

SEISMOLOGY

Master Degree Programme in Physics - UNITS
Physics of the Earth and of the Environment

ANELASTICITY

FABIO ROMANELLI

Department of Mathematics & Geosciences

University of Trieste

romanel@units.it



Intrinsic Attenuation: outline



- **Recap:**
 - solids, fluids, stress, strain
 - materials classification
- **Rheology:**
 - creep and stress relaxation experiments
- **Physical models for attenuation:**
 - Maxwell, Kelvin-Voigt, SLS
 - Dynamic tests
 - Complex modulus
 - Relaxed and unrelaxed modules
- **Q in the Earth**
 - dispersion
 - complex velocities



Anelasticity



Hooke's law implies that stress and strain are instantaneous, i.e., time independent.

Some deformation are time dependent.

The applied stress leads the resulting strain.

Time-dependent behavior is known as **anelasticity**.

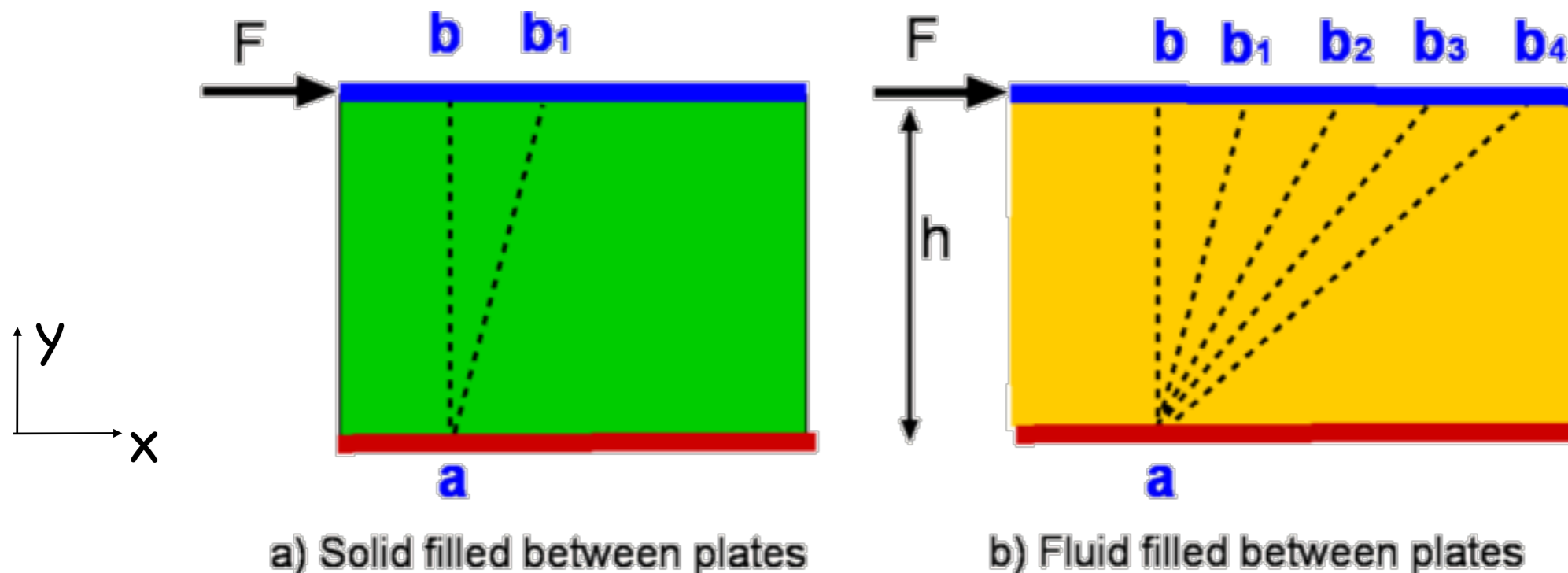
In polymer and glass, it is called **viscoelastic** behavior.



Strain as a measure of Deformation



To understand deformation due to shear, picture two flat plates with a fixed spacing, h , between them:



Fluids are qualitatively different from solids in their response to a shear stress. Ordinary fluids such as air and water have no intrinsic configuration, and hence fluids **do not develop a restoring force** that can provide a static balance to a shear stress. When the shear stress is held steady, and assuming that the geometry does not interfere, the **shear deformation rate**, may also be steady or have a meaningful time-average.



Strain as a measure of Deformation



- A strain measure for simple shear can be obtained by dividing the displacement of the moving plate, ΔX , by the distance between the plates:

$$\gamma = \frac{\Delta x}{h} \approx \frac{dx}{dy}$$

Shear strain

- The **shear rate**, or rate of shearing strain, is the rate of change of shear strain with time:

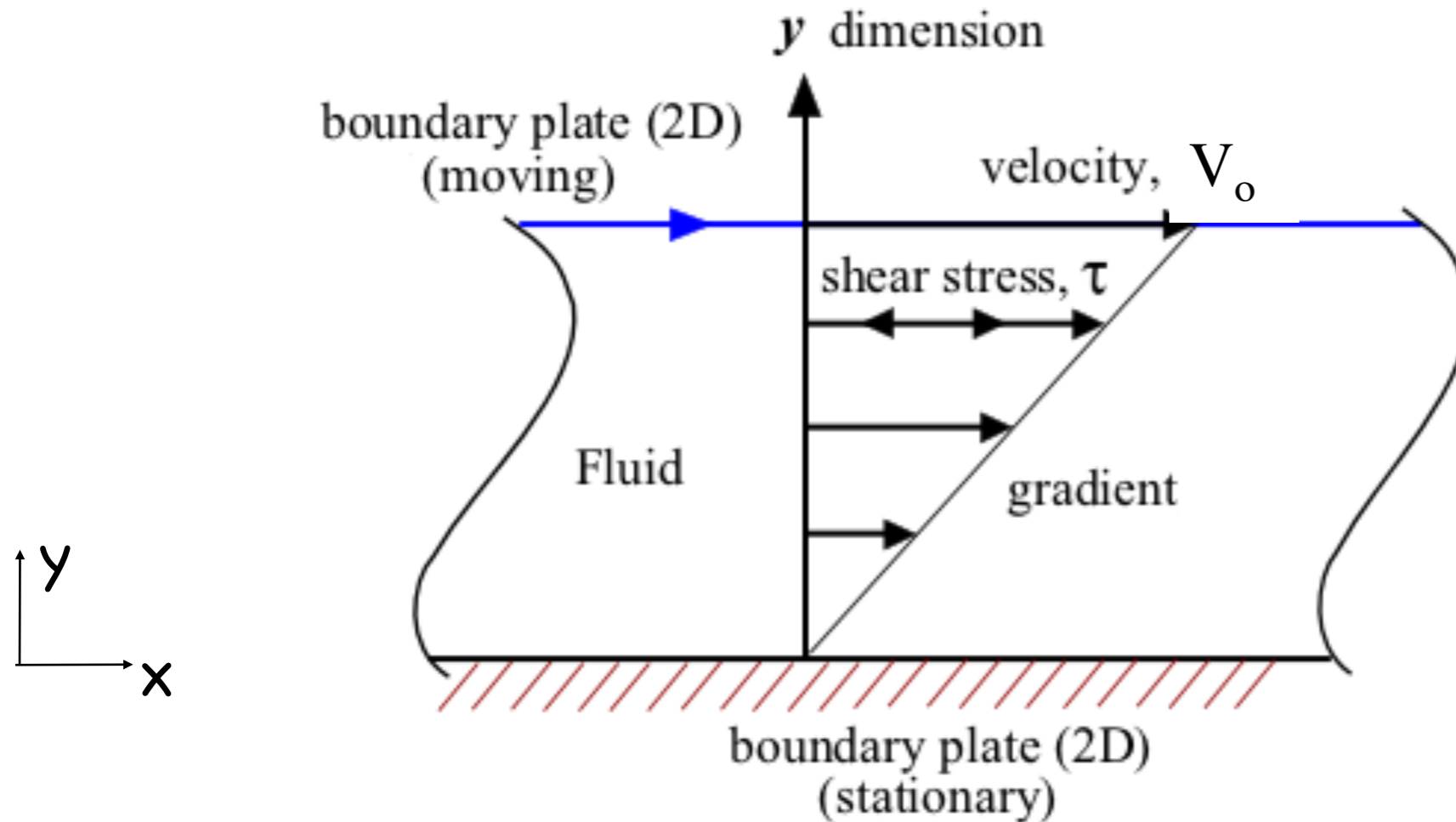
$$\dot{\gamma} = \frac{d\gamma}{dt} = \frac{d}{dt} \left(\frac{dx}{dy} \right) = \frac{d}{dy} \left(\frac{dx}{dt} \right)$$

$$\dot{\gamma} = \frac{dv}{dy}$$

Shear strain rate



Simple Shear Flow



The velocity profile is a straight line:
the velocity varies uniformly from 0 to V_0

$$\dot{\gamma} = \frac{dv}{dy} = \frac{V_0}{h}$$

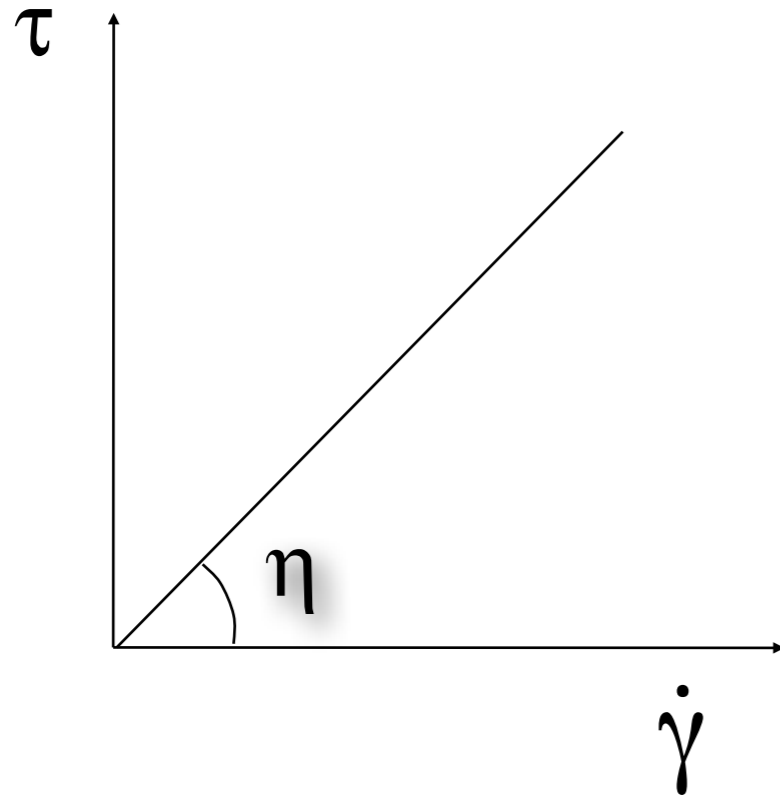


Newton's Law of Viscosity



Newtonian fluids:

Shearing stress is linearly related to the rate of shearing strain.



This is called a "flow curve"

The proportionality constant

is the viscosity

Newton's law of viscosity

$$\tau = \eta \frac{dv}{dy} = \eta \frac{d\gamma}{dt}$$

The **viscosity** (units Pa·s=Pl) of a fluid measures its resistance to flow under an applied shear stress.



Newtonian Fluids



Viscosity of Newtonian fluids depends **only** on **temperature** and **pressure**, e.g.:

$$\eta(T, P) = \eta_0 e^{\left[\frac{\Delta E}{R} \left(\frac{T_0 - T}{T_0 T} \right) \right]} e^{\beta(P - P_0)}$$

Where: η_0 : viscosity at T_0 and P_0 (reference temperature and pressure)

ΔE : activation energy for flow

R : gas constant

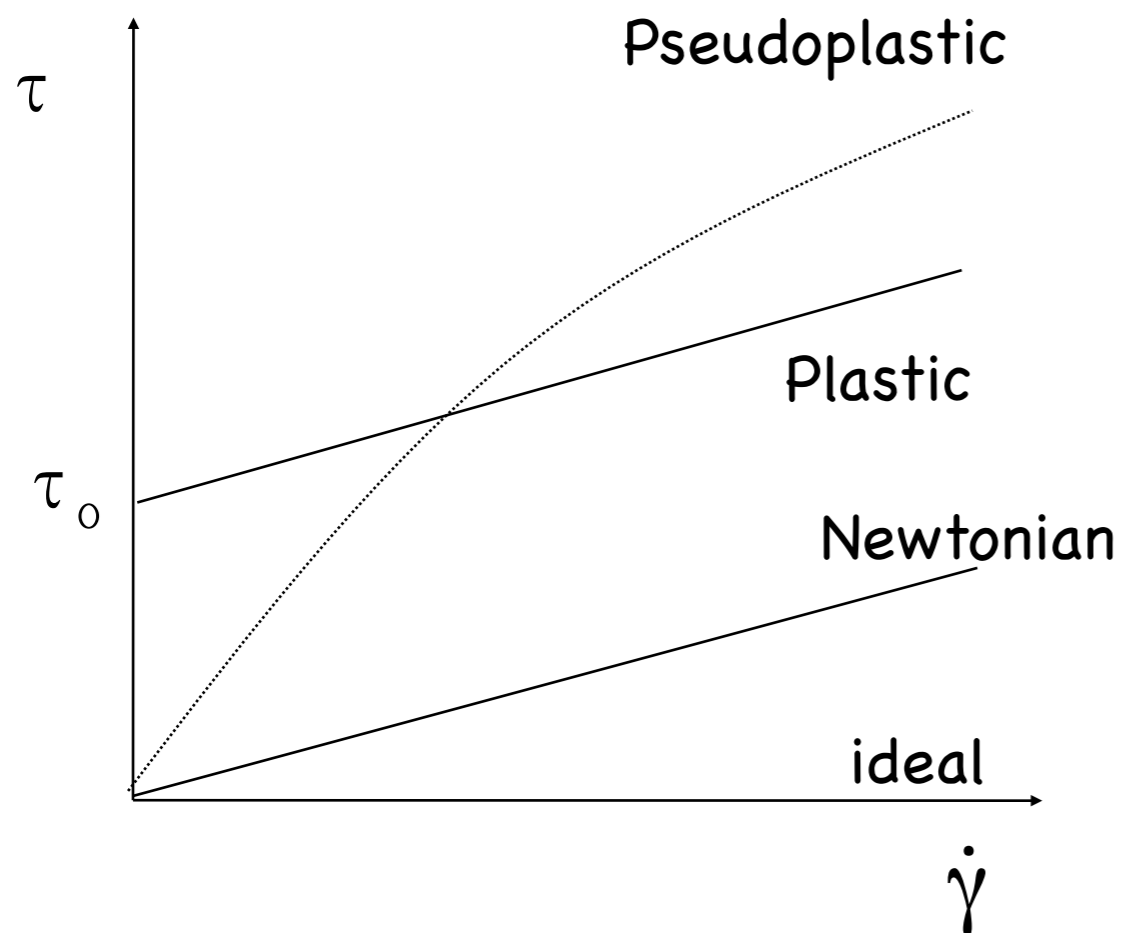
β : material property [m^2/N]



Plasticity and Yield Stress



The structure of some polymers, especially filled polymers or concentrated suspensions can be sufficiently rigid that it permits the material to withstand a certain level of deforming stress without flowing. The maximum stress that can be sustained without flow is called the “**yield stress**” and this type of behavior is called “**plasticity**”



$$\dot{\gamma} = 0 \quad \text{for } \tau < \tau_0$$
$$\tau = \tau_0 + \eta \dot{\gamma} \quad \text{for } \tau \geq \tau_0$$



Model parameters for different fluids

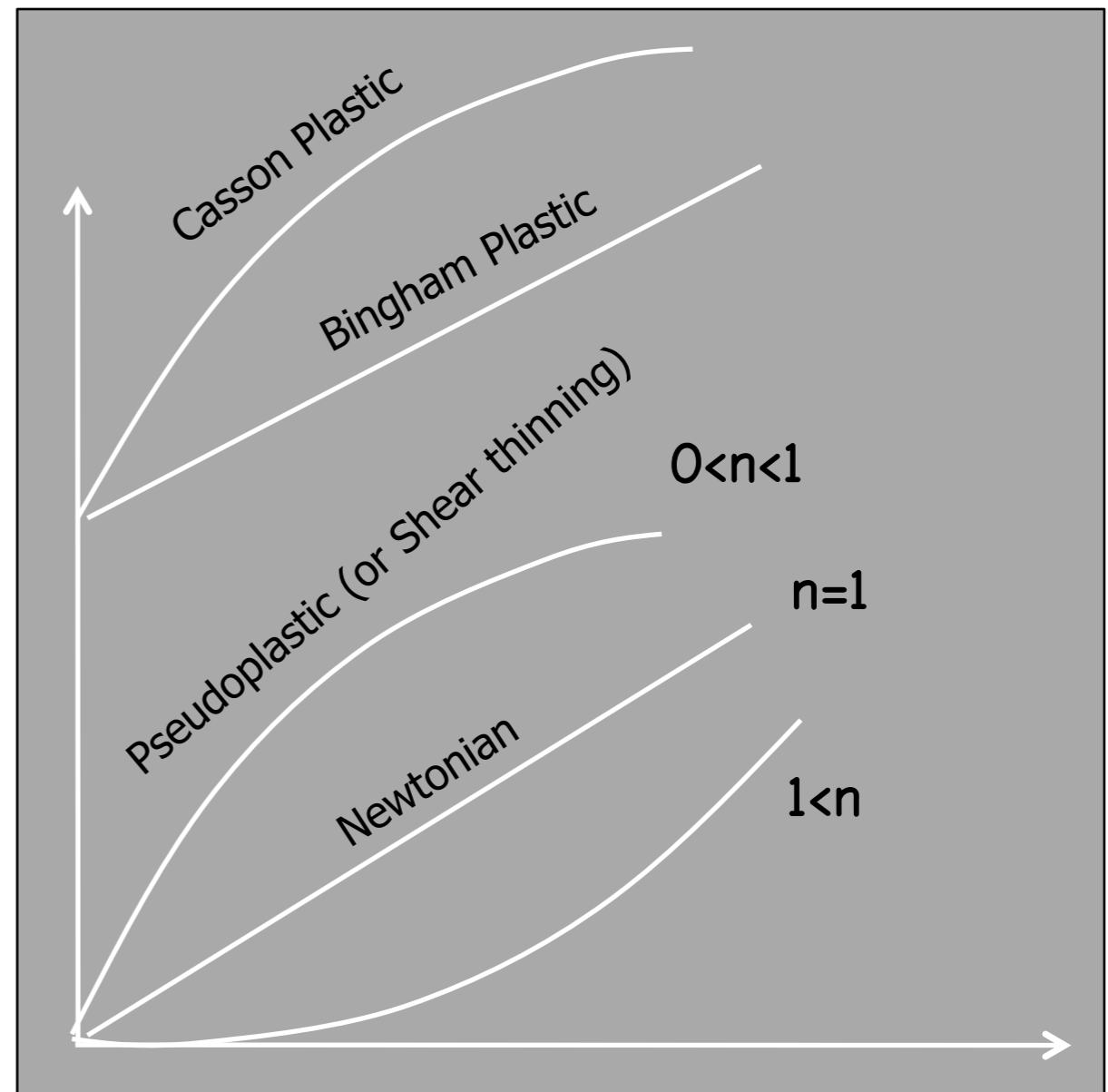


$$\tau = K\dot{\gamma}^n + \tau_0$$

When stress is less than yield stress, material does not flow.

It behaves like a solid

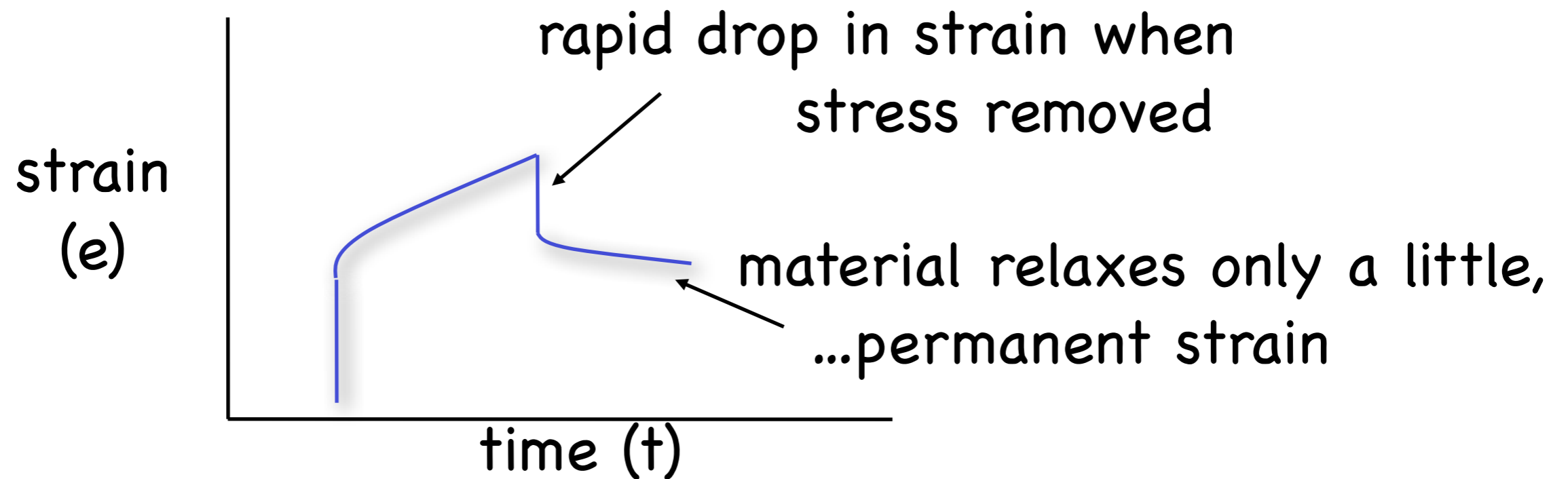
Shear stress



Shear rate



if stress removed during steady-state creep
...before material fractures...



to examine this behavior of natural rocks...
...look at rheological models

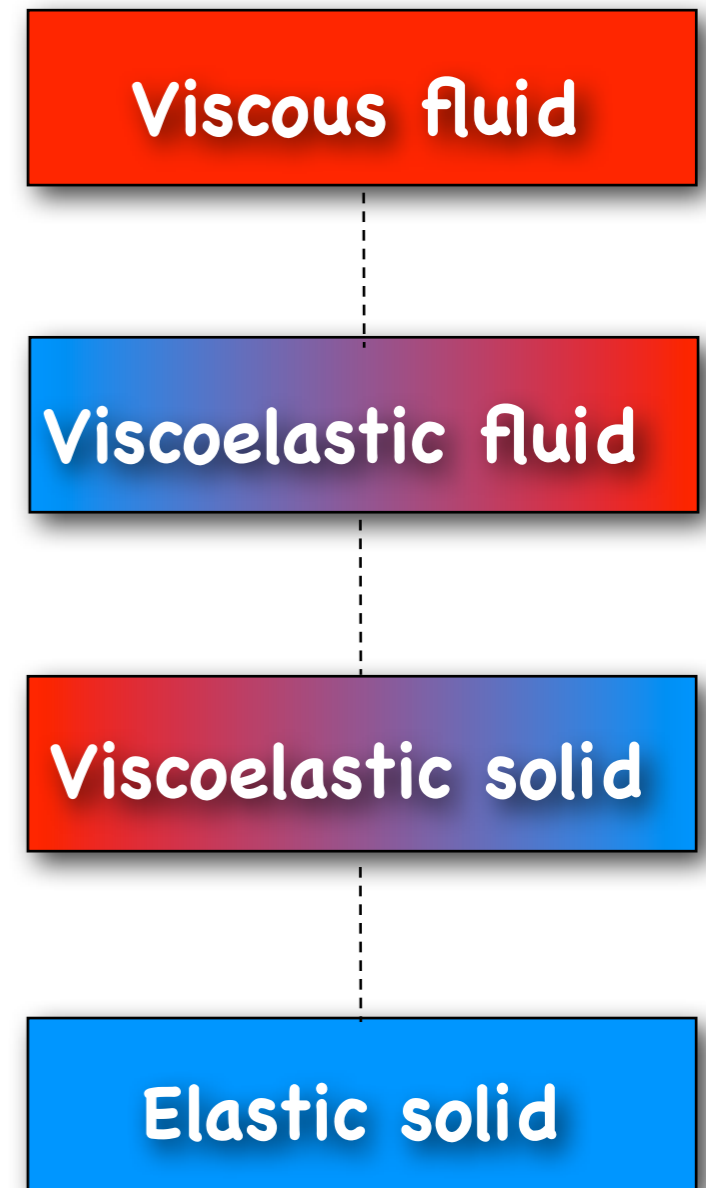
divide into two types: **elastic** and **viscous** behavior



Introduction to Viscoelasticity



- All **viscous fluids** deform continuously (flow) under the influence of an applied stress – They exhibit viscous behavior.
- **Viscoelastic** materials can exhibit both viscosity and elasticity, depending on the conditions.
- **Solids** deform under an applied stress, but soon reach a position of equilibrium, in which further deformation ceases. If the stress is removed they recover their original shape – They exhibit elastic behavior.





Materials classification



we can classify materials respect to stress-strain relationship:

If one applies a force to a **solid** it deforms to a certain extent:

- **Rigid** (Euclidean): $\varepsilon=0$
- **Linear elastic** (Hookean): $\sigma = G \varepsilon$
- **Non Linear elastic**: $\sigma = G(\varepsilon) \varepsilon$

If one applies a force to a **fluid** it deforms continuously (flowing):

- **Inviscid** (Pascalian): $\tau = 0$
- **Linear viscous** (Newtonian): $\tau = \eta \dot{\gamma}$
- **Non Linear viscous** (Non Newtonian): $\tau = \eta(\dot{\gamma}) \dot{\gamma}$

Viscoelasticity: time-dependent material behavior where the stress response of that material depends on both the strain applied and the strain rate at which it was applied!
A viscoelastic material has infinite material responses depending on the strain-rate.



Rheology



The response of polymeric liquids, such as melts and solutions, to an imposed stress may under certain conditions resemble the behavior of a solid or a liquid, depending on the situation.

Reiner used the biblical expression that "mountains flowed in front of God" to define the DEBORAH number:

$$De = \frac{\text{time of relaxation}}{\text{time of observation}}$$

- Solid-like response: $De \rightarrow \infty$
- Liquid-like response: $De \rightarrow 0$

Rheology is the science of the deformation and flow of materials.

M. Reiner is credited with naming the Deborah Number after the song of Deborah, Judges 5:5- "The mountains flowed before the Lord"(Fig. 3.10). It was first mentioned in his article "The Deborah Number" in the January 1964 issue of Physics Today.

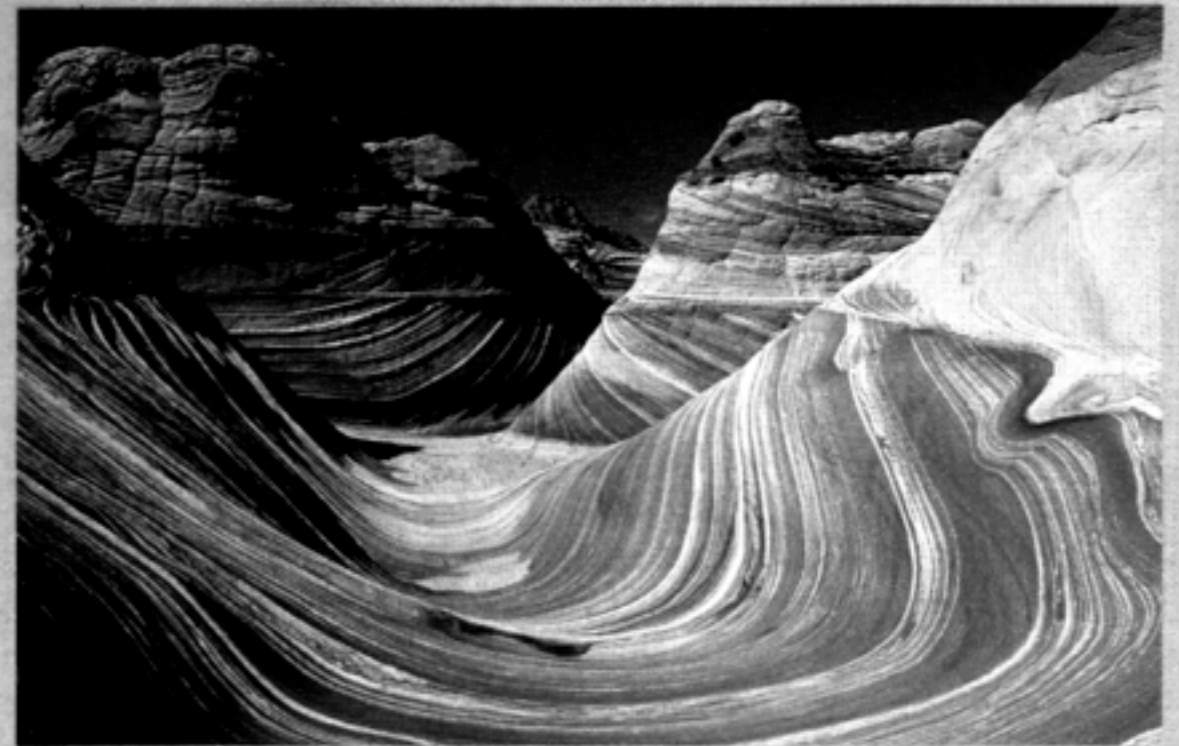


Figure. 3.10 Nestles Canyon, Arizona. Courtesy of Wolfgang Cohnen (©1997)



Elastic (Solid-like) Response



A material is perfectly elastic, if the equilibrium shape is attained instantaneously when a stress is applied. Upon imposing a step input in strain, the stresses do not relax.

The simplest elastic solid model is the Hookean model, which we can represent by the “spring” mechanical analog.



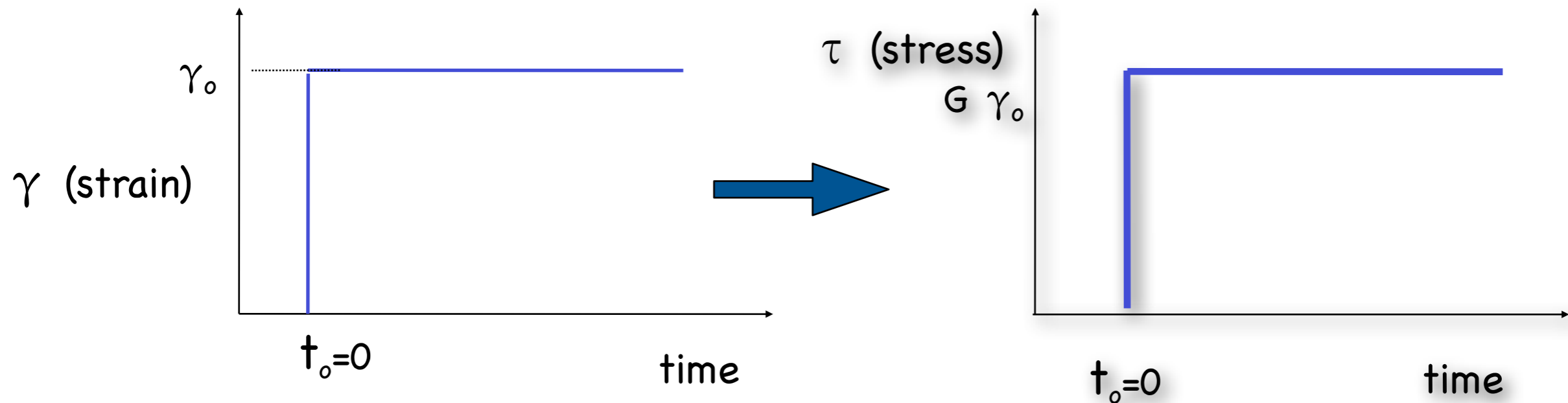
$$\tau = G \gamma$$



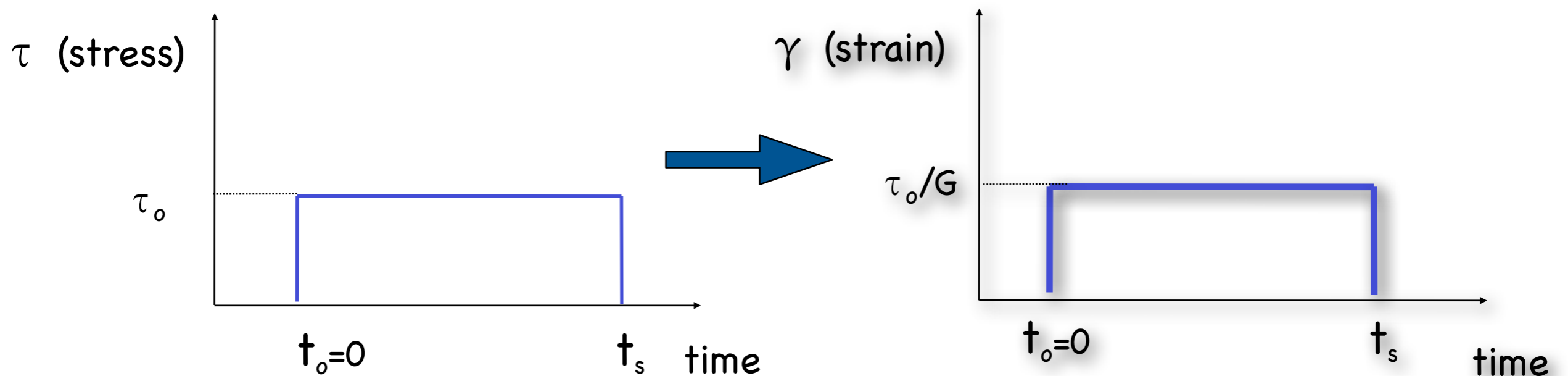
Elastic (Solid-like) Response



- **Stress Relaxation experiment** (suddenly applying a strain to the sample and following the stress as a function of time as the strain is held constant).



- **Creep Experiment** (a constant stress is instantaneously applied to the material and the resulting strain is followed as a function of time)



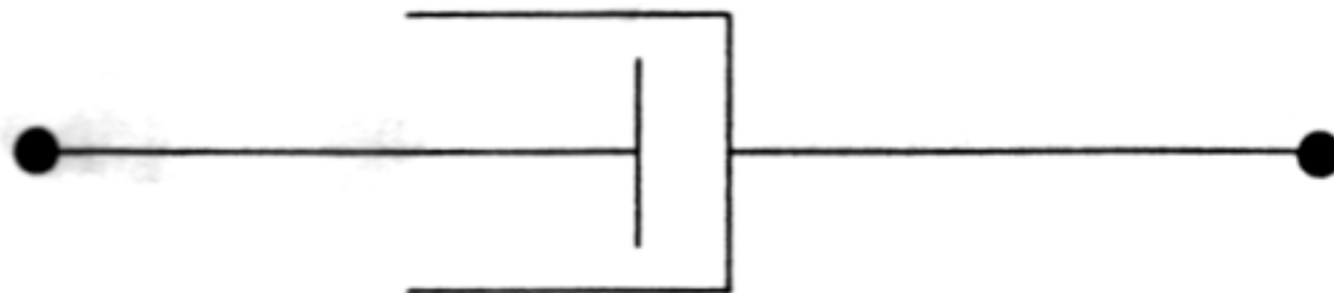


Viscous (Liquid-like) Response



A material is purely viscous (or inelastic) if following any flow or deformation history, the stresses in the material become instantaneously zero, as soon as the flow is stopped; or the deformation rate becomes instantaneously zero when the stresses are set equal to zero. Upon imposing a step input in strain, the stresses relax as soon as the strain is constant.

The liquid behavior can be simply represented by the Newtonian model. We can represent the Newtonian behavior by using a “dashpot” mechanical analog:



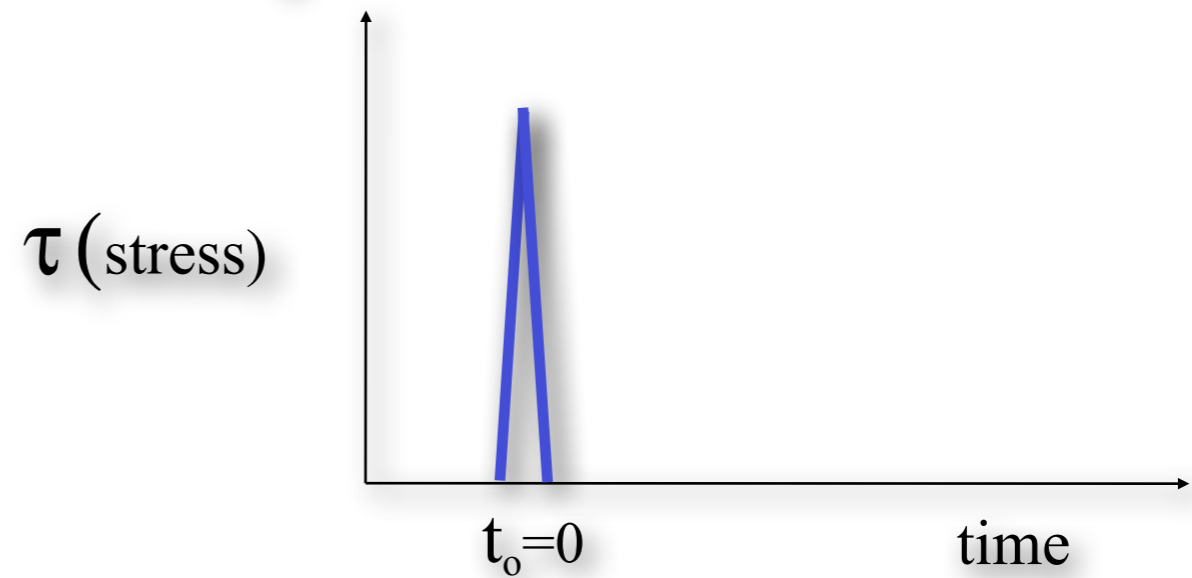
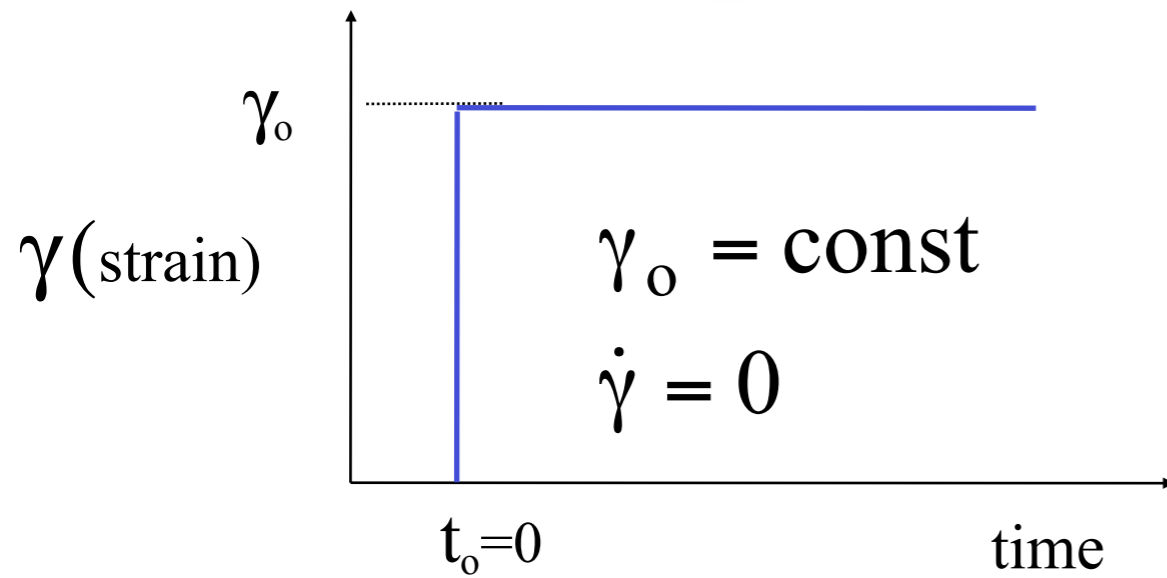
$$\tau = \eta \dot{\gamma}$$



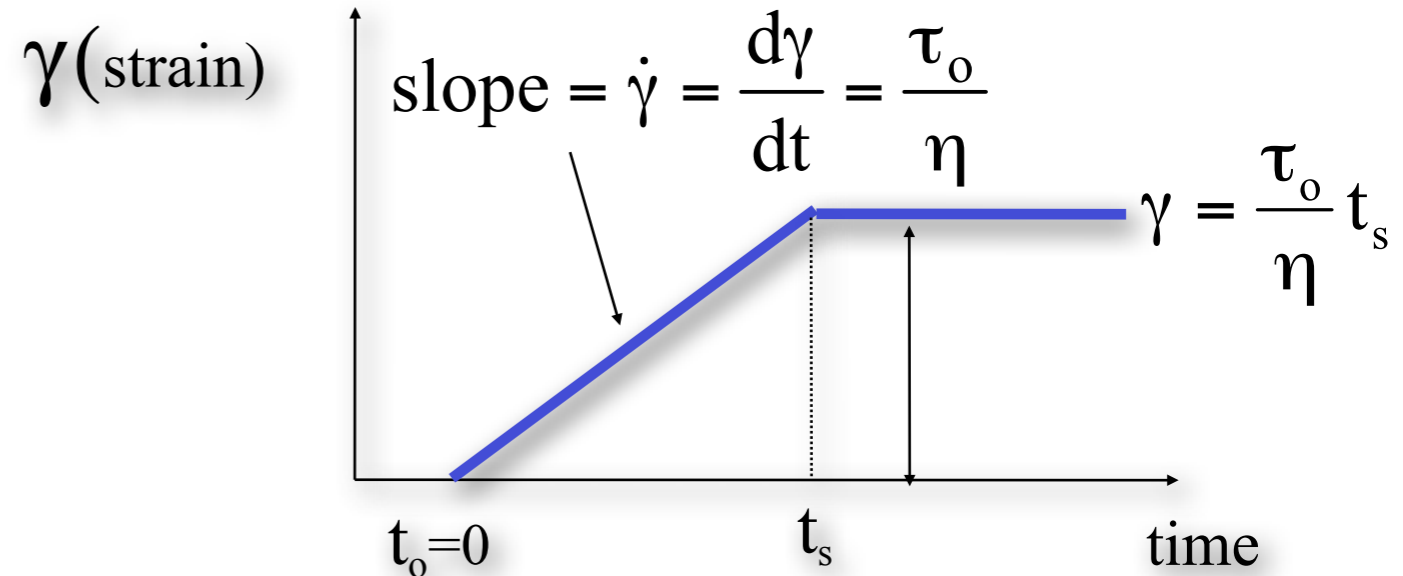
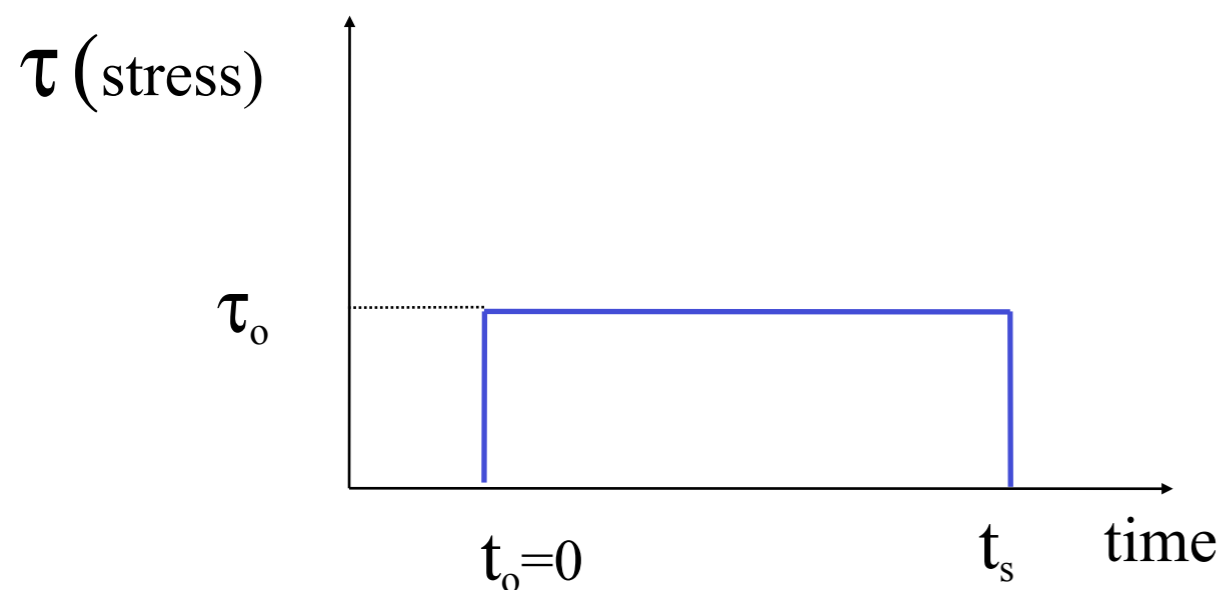
Viscous (Liquid-like) Response



● Stress Relaxation experiment



● Creep Experiment



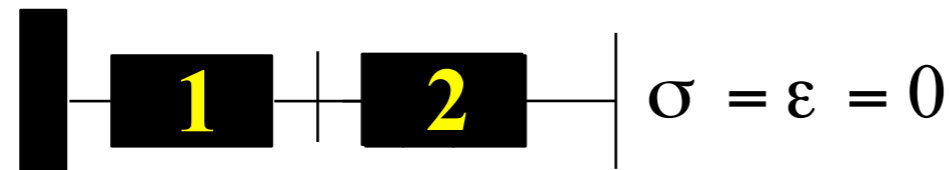


Network Formulation of Viscoelasticity

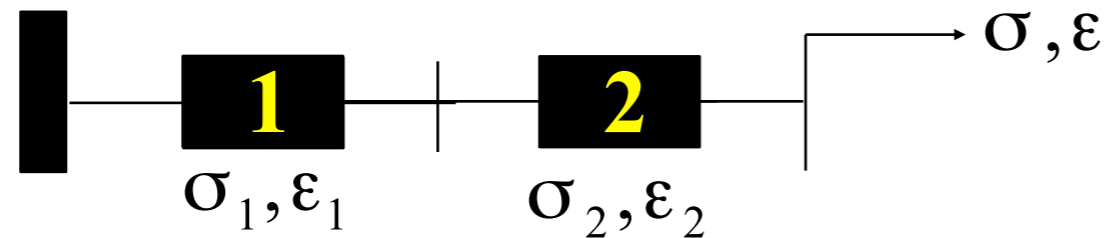


The "art" of **viscoelastic modeling** is choosing the proper forms of the elastic and viscous components (e.g. linear), as well as combining the elements into the best possible network so that the proper time dependent behavior is predicted

Series element:

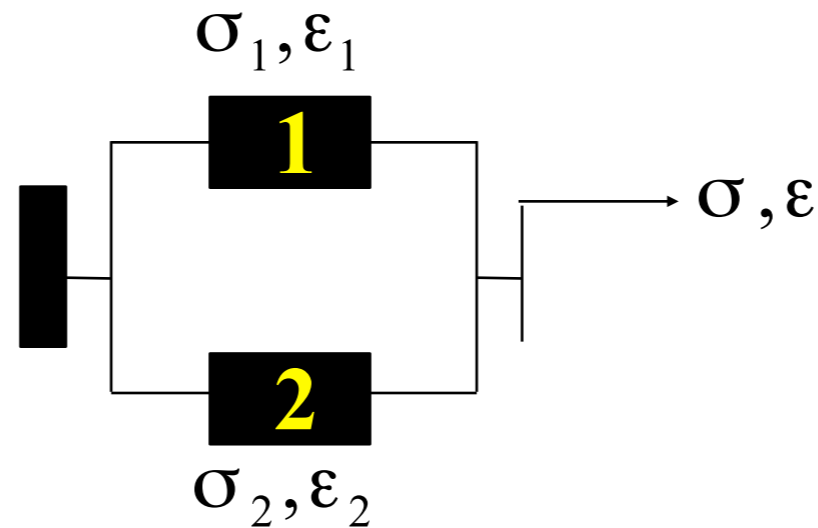
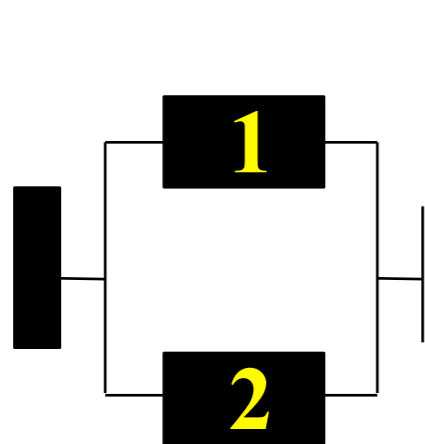


$$\sigma_1 = \sigma_2 = \sigma$$



$$\epsilon_1 + \epsilon_2 = \epsilon$$

Parallel element:



$$\sigma_1 + \sigma_2 = \sigma$$

$$\epsilon_1 = \epsilon_2 = \epsilon$$



Viscoelastic - Maxwell Element



A viscoelastic material (liquid or solid) will not respond instantaneously when stresses are applied, or the stresses will not respond instantaneously to any imposed deformation. Upon imposing a step input in strain the viscoelastic liquid or solid will show stress relaxation over a significant time.

At least two components are needed, one to characterize elastic and the other viscous behavior. One such model is the Maxwell model:



$G(t, \gamma)$ = relaxation modulus.

If $G = G(t)$ only, then we have linear viscoelastic behavior



Maxwell Model Response



Let's try to deform the Maxwell element

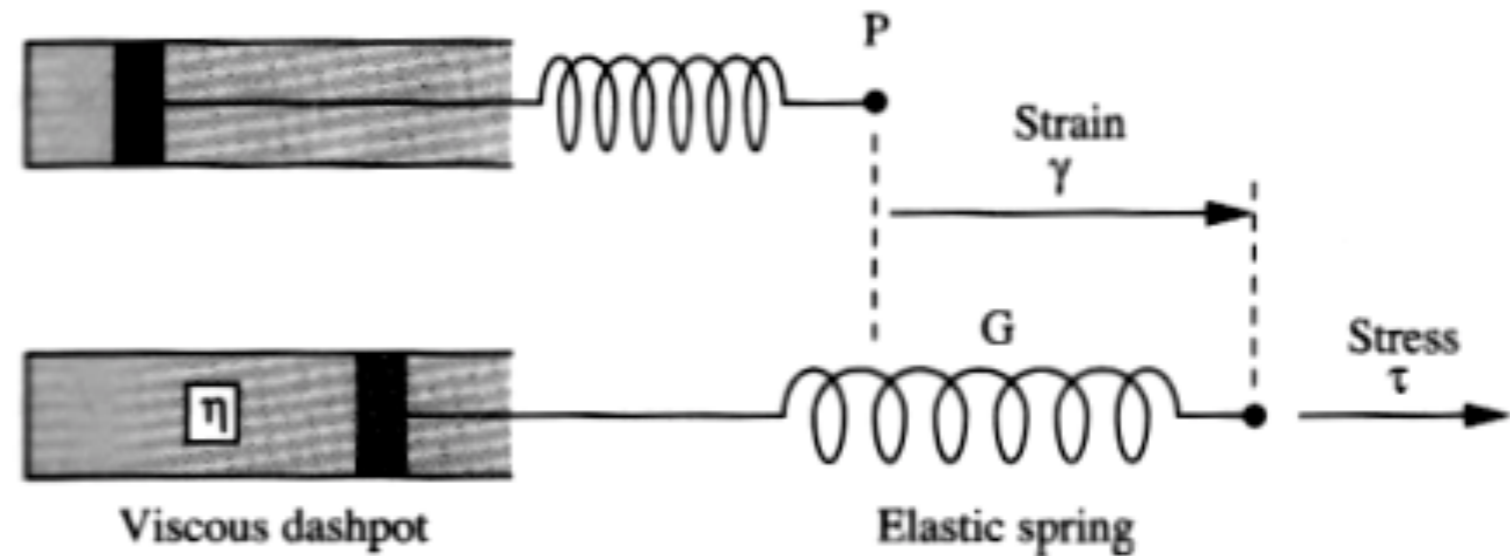
The deformation rate of the Maxwell model is equal to the sum of the individual deformation rates:

$$\dot{\gamma} = \dot{\gamma}_{\text{fluid}} + \dot{\gamma}_{\text{solid}}$$

$$\dot{\gamma} = \frac{\tau}{\eta} + \frac{\dot{\tau}}{G}$$

$$\tau + \frac{\eta}{G} \dot{\tau} = \eta \dot{\gamma}$$

$$\tau + \lambda \dot{\tau} = \eta \dot{\gamma} \quad (1)$$



$\lambda = \eta/G$ is called the **relaxation time**



Maxwell Model Response



1) **Stress Relaxation Experiment:** If the mechanical model is suddenly extended to a position and held there ($\gamma_0 = \text{const.}$, $\dot{\gamma} = 0$):

$$\tau(t) = \tau_0 e^{-t/\lambda} \quad \text{Exponential decay}$$

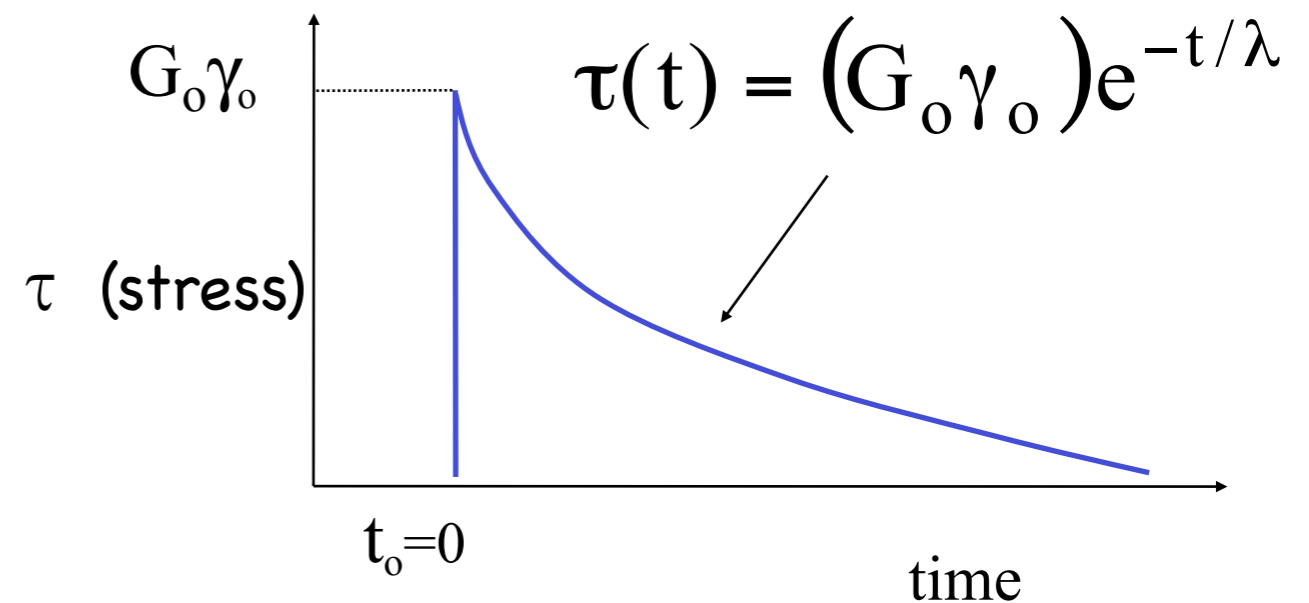
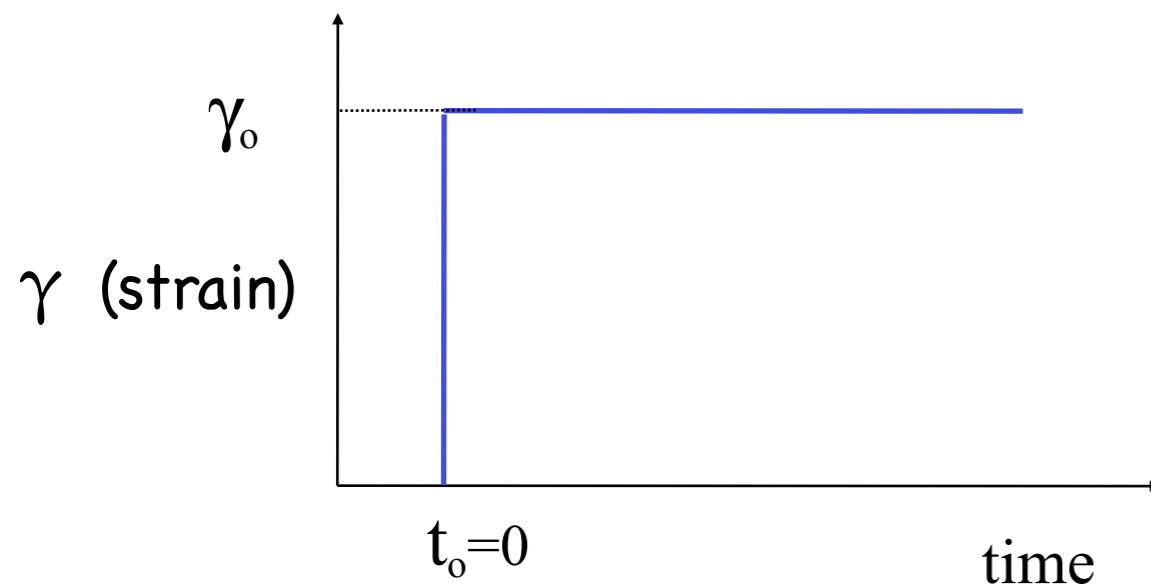
Also recall the definition of the "relaxation" modulus:

$$G(t) = \frac{\tau(t)}{\gamma_0}$$

$$\tau(t) = (G_0 \gamma_0) e^{-t/\lambda}$$

and

$$G(t) = G_0 e^{-t/\lambda}$$





Maxwell Model Response



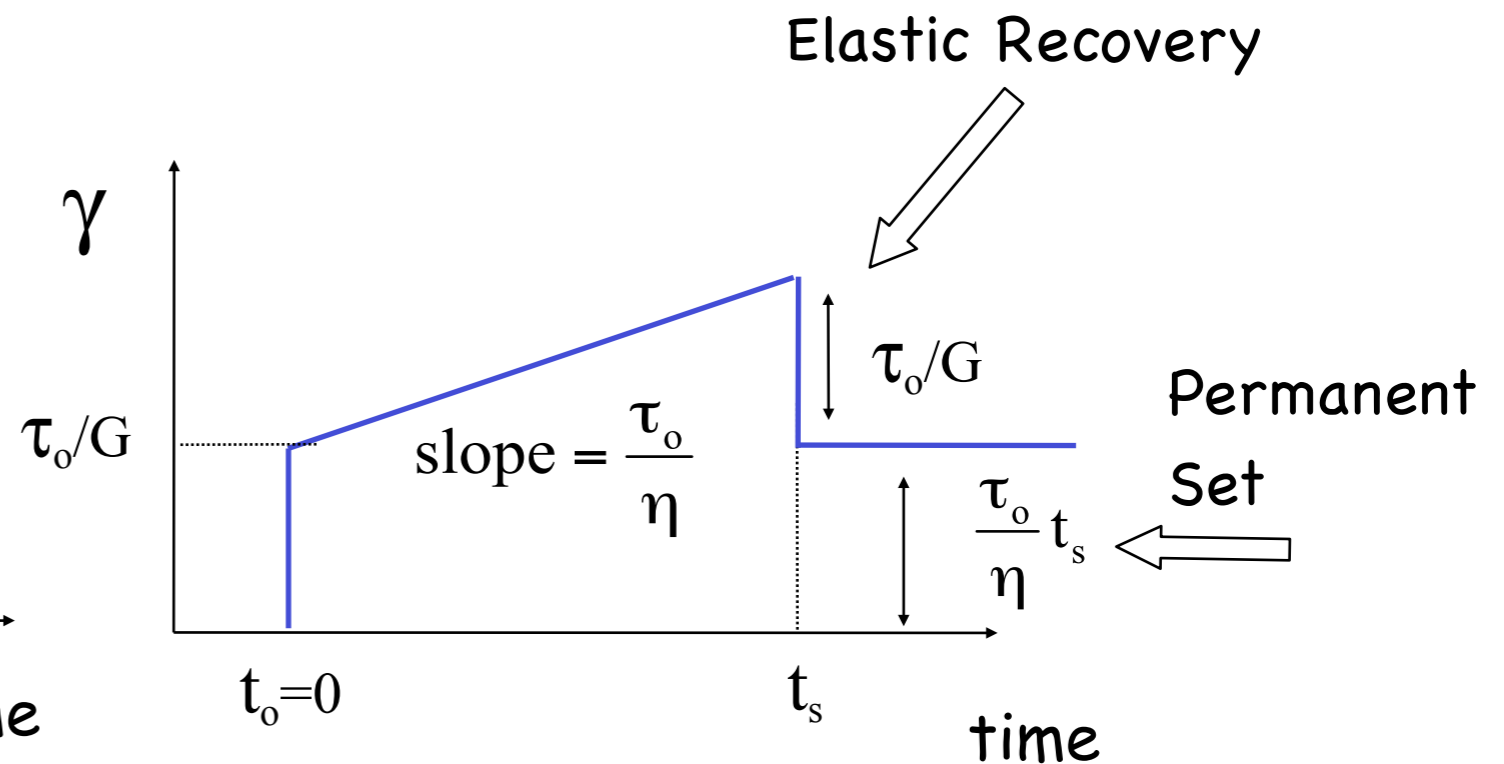
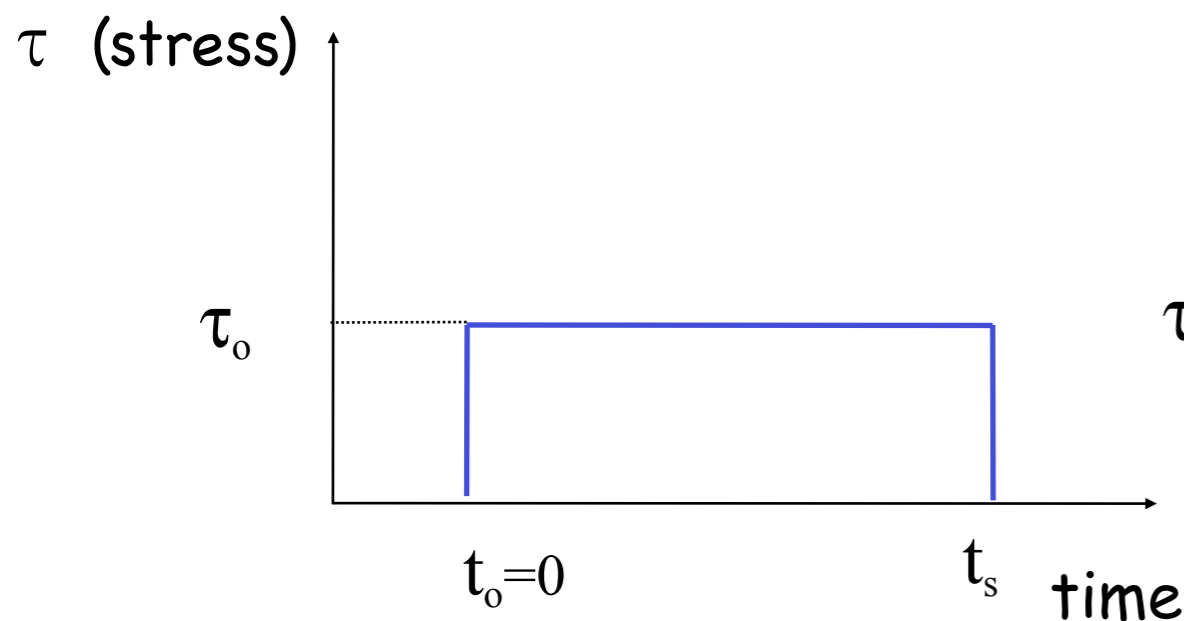
2) **Creep Experiment:** If a sudden stress is imposed, an instantaneous stretching of the spring will occur, followed by an extension of the dashpot.

Deformation after removal of the stress is known as **creep recovery**.

$$\gamma(t) = \frac{\tau_0}{G} + \frac{\tau_0}{\eta} t$$

Or by defining the "creep compliance": $J(t) = \frac{\gamma(t)}{\tau_0}$

$$J(t) = \frac{1}{G} + \frac{t}{\eta}$$

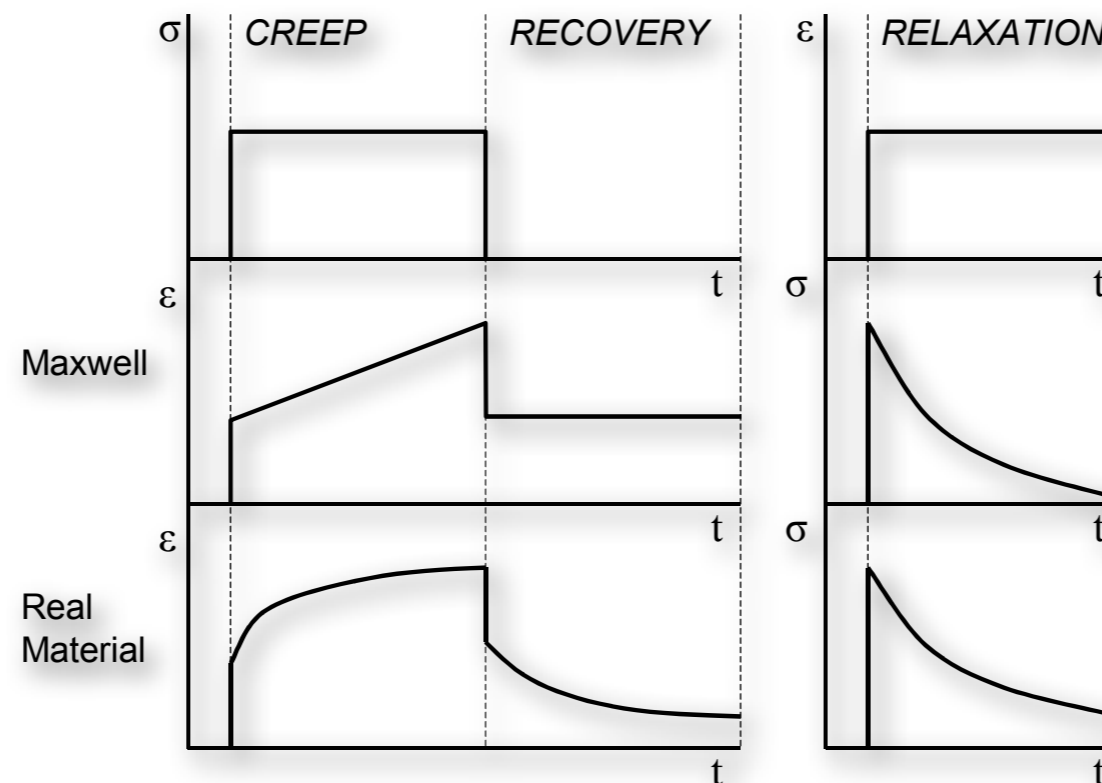




Maxwell Model Response



- ✓ The Maxwell model can describe successfully the phenomena of elastic strain, creep recovery, permanent set and stress relaxation observed with real materials
- ✓ Moreover the model exhibits relaxation of stresses after a step strain deformation and continuous deformation as long as the stress is maintained. These are characteristics of liquid-like behaviour
- ✓ Therefore the Maxwell element represents a **VISCOELASTIC FLUID**.

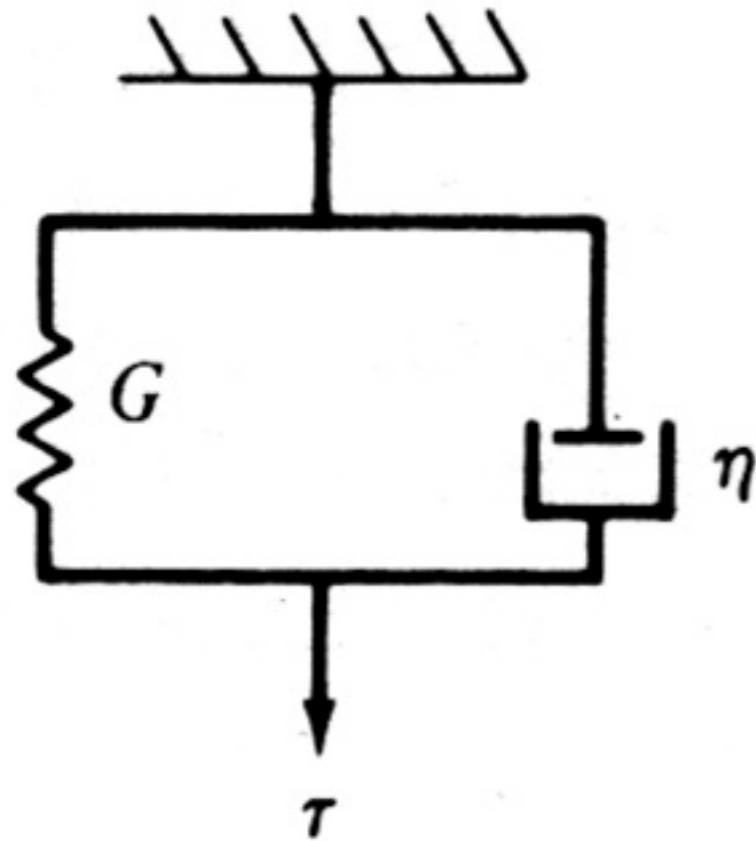




Viscoelastic - Voigt-Kelvin Element



The Voigt-Kelvin element consists of a spring and a dashpot connected in parallel.



$$\gamma = \gamma_{\text{spring}} = \gamma_{\text{dashpot}}$$

$$\tau = \tau_{\text{spring}} + \tau_{\text{dashpot}}$$

$$\tau = G\gamma + \eta\dot{\gamma}$$



Voigt-Kelvin Model Response



Creep Experiment ($\tau_0 = \text{const.}$):

$$\gamma(t) = \frac{\tau_0}{G} \left(1 - e^{-\frac{t}{\lambda}} \right)$$

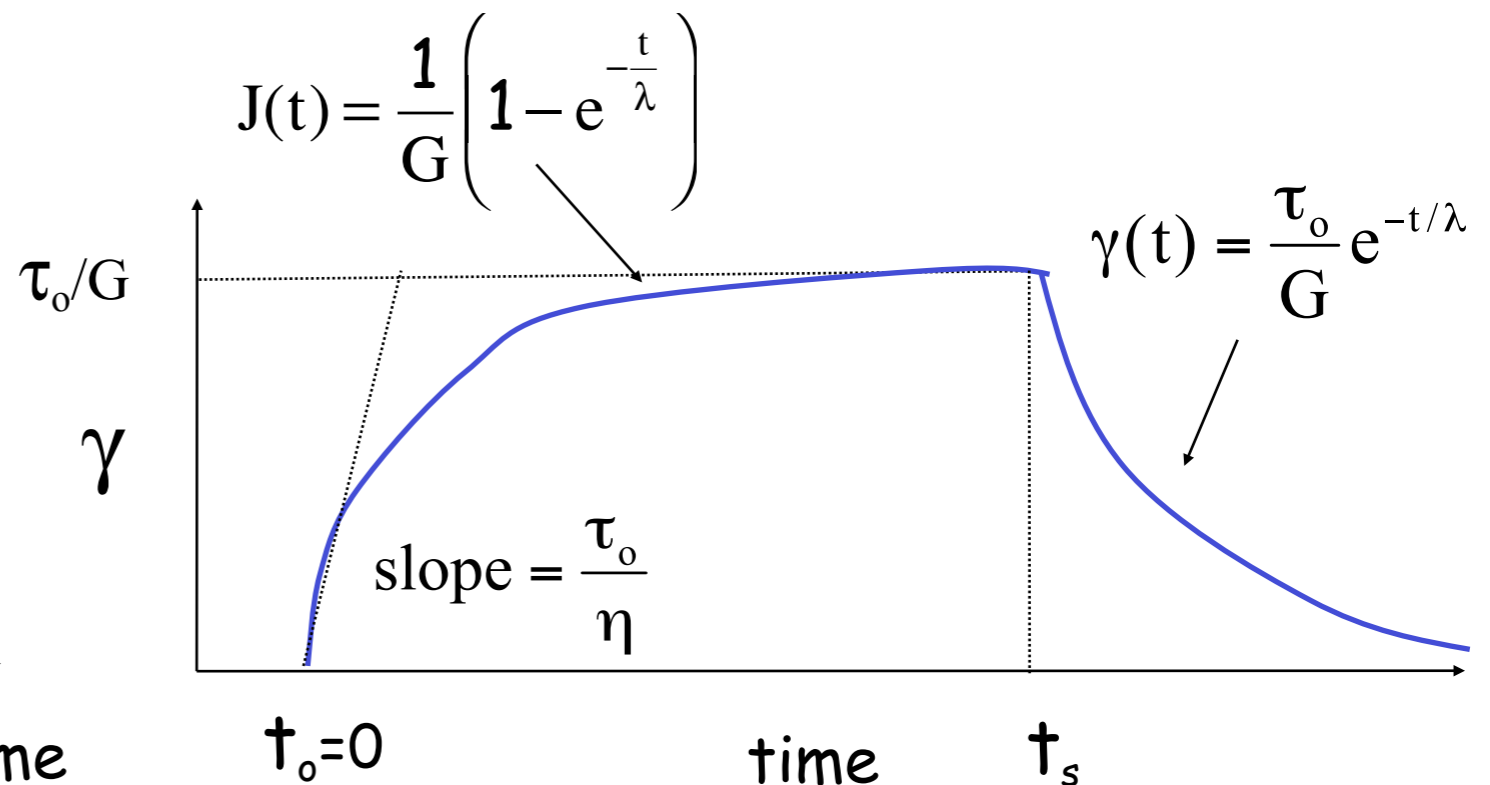
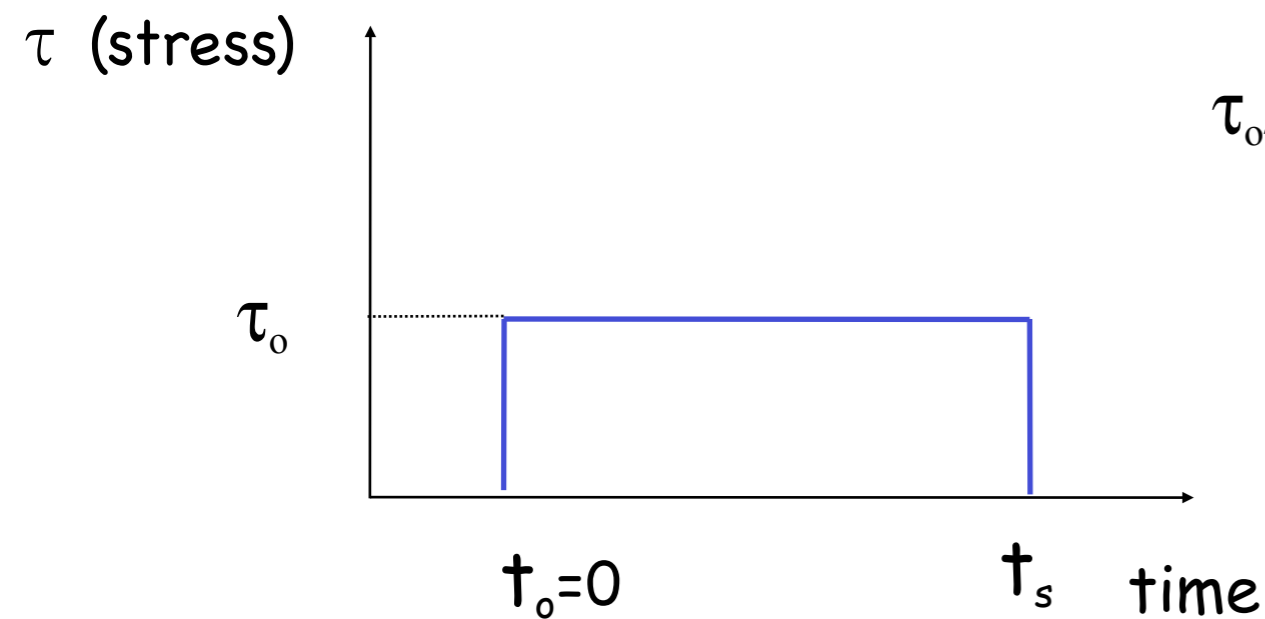
or

$$J(t) = \frac{1}{G} \left(1 - e^{-\frac{t}{\lambda}} \right)$$

If the stress is removed after equilibrium has been reached (**creep recovery**):

$$\gamma(t) = \frac{\tau_0}{G} e^{-\frac{t}{\lambda}}$$

Exponential decay

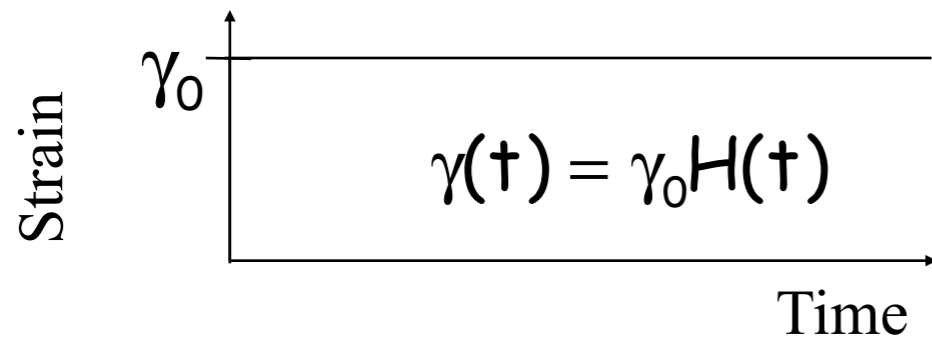




Voigt-Kelvin Model Response

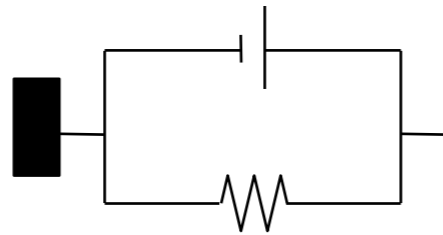


Stress relaxation ($\gamma_0 = \text{const.}$):

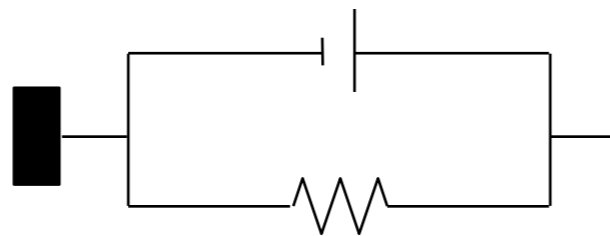


$$\eta \gamma_0 \delta(t) + G \gamma_0 H(t) = \tau$$

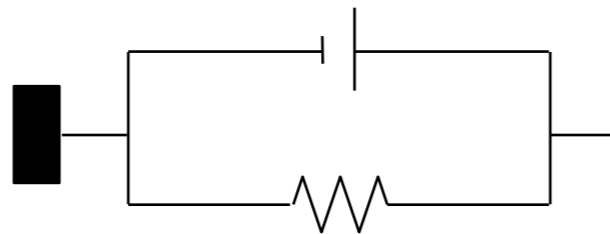
Initial state:



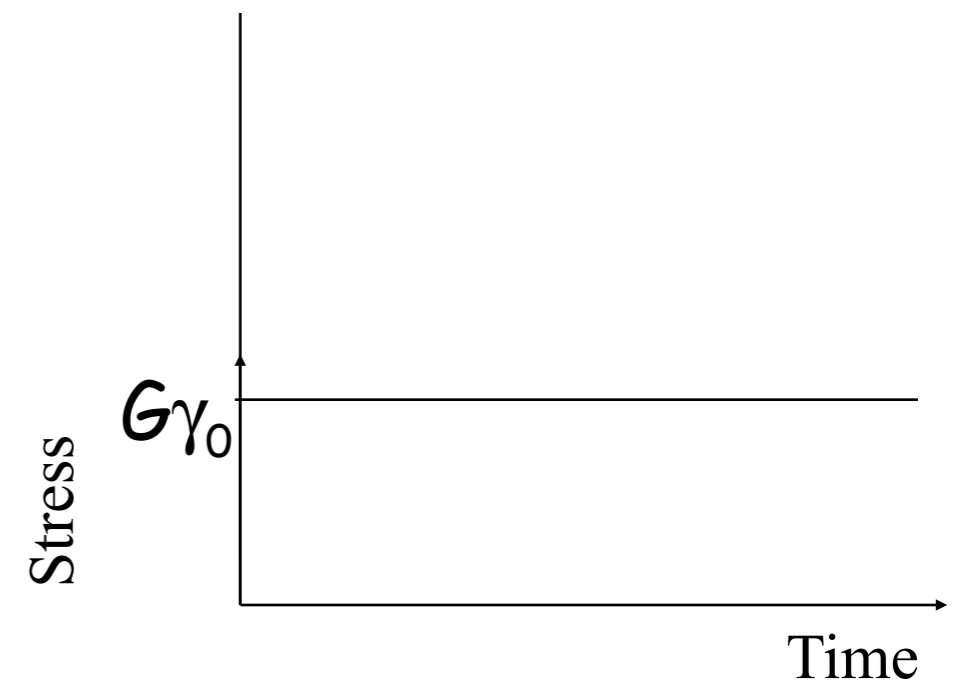
Instantaneous response:



Final state:



The response is given immediately: the stress is initially infinitely large because of the viscous element, but immediately returns to a constant finite level



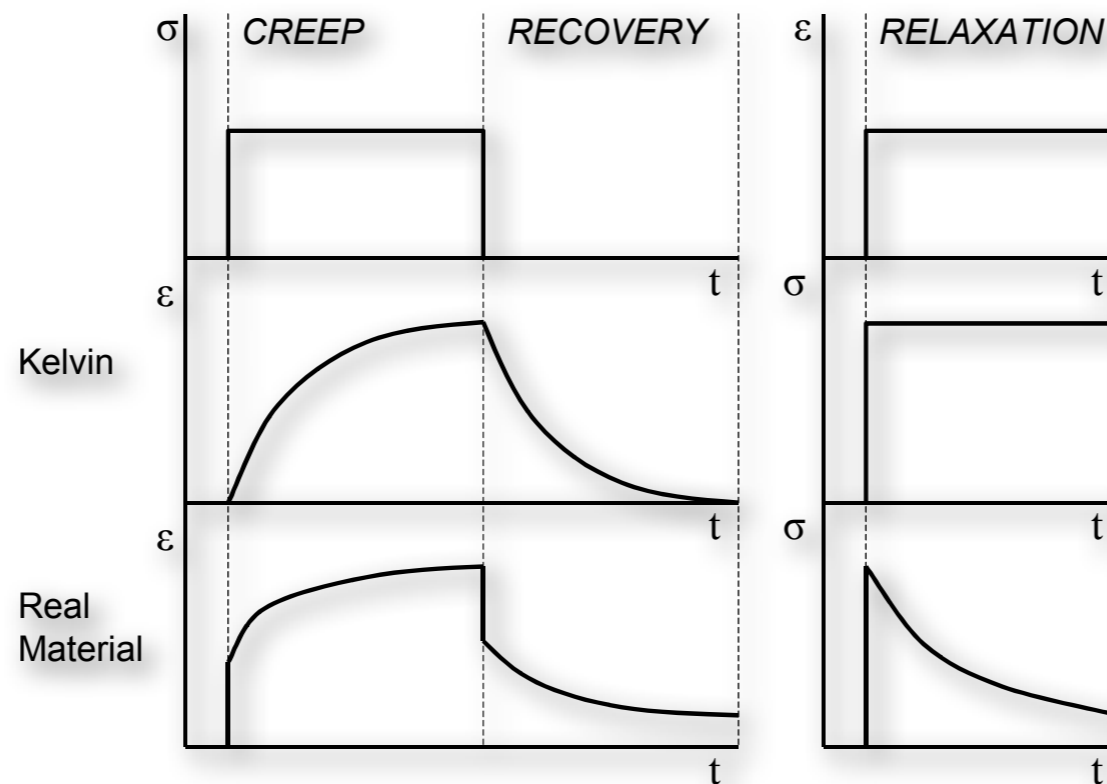


Voigt-Kelvin Model Response



✓ The Voigt-Kelvin element does not continue to deform as long as stress is applied, rather it reaches an equilibrium deformation. It does not exhibit any permanent set. These resemble the response of cross-linked rubbers and are characteristics of solid-like behaviour. The Voigt-Kelvin element cannot describe stress relaxation.

✓ Therefore the Voigt-Kelvin element represents a **VISCOELASTIC SOLID**.



✓ Both Maxwell and Voigt-Kelvin elements can provide only a qualitative description of the response. Various other spring/dashpot combinations have been proposed.

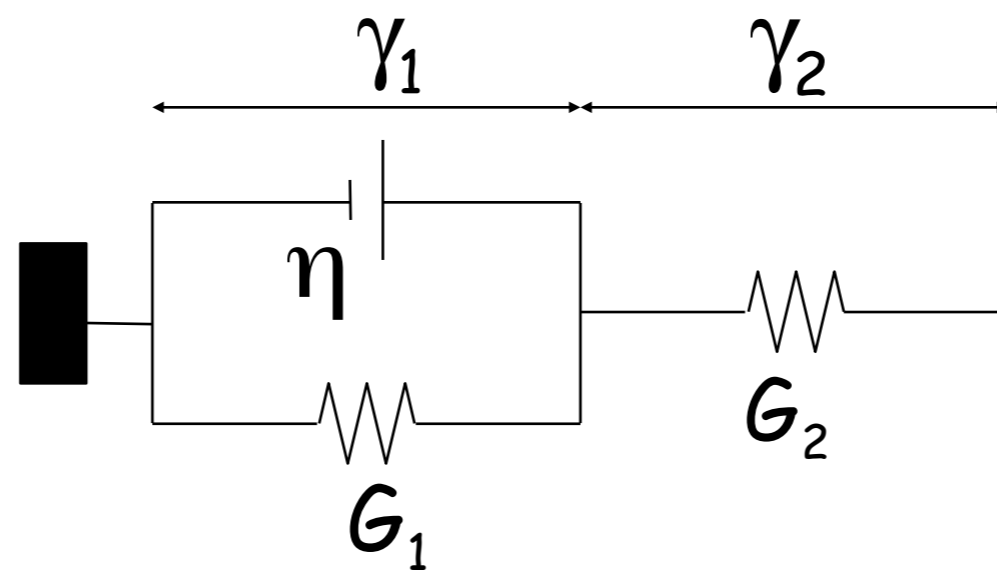


More Complex Network Models



Neither the Maxwell fluid nor the Kelvin (Voigt) solid gives a viscoelastic response that can qualitatively capture even the most basic features; therefore, more complex network models must be used, e.g. three element models (aka **Standard Linear Solids**):

A Kelvin solid in series with a spring (**Zener's model**):



$$\left. \begin{aligned} \tau &= G_1 \gamma_1 + \eta \dot{\gamma}_1 = G_2 \gamma_2 \\ \gamma &= \gamma_1 + \gamma_2 \end{aligned} \right\} \Rightarrow (G_1 + G_2) \tau + \eta \dot{\tau} = G_1 G_2 \gamma + \eta G_2 \dot{\gamma}$$

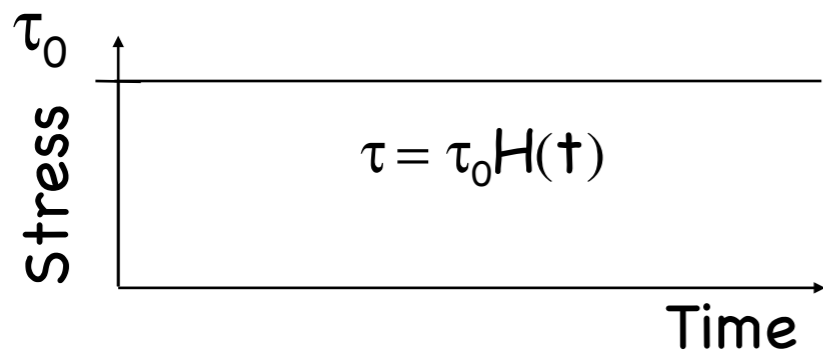


SLS: creep



Consider the response of the three element model to creep and stress relaxation:

Perfect creep:



$$\tau_0 H(t) = G_1 \gamma_1 + \eta \dot{\gamma}_1 = G_2 \gamma_2$$

Kelvin element:

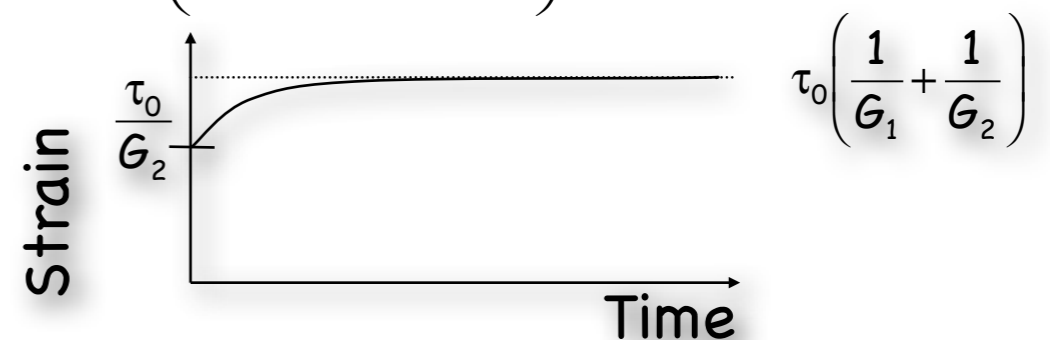
$$\tau_0 H(t) = G_1 \gamma_1 + \eta \dot{\gamma}_1 \Rightarrow \gamma_1(t) = \frac{\tau_0}{G_1} \left(1 - e^{-\frac{G_1 t}{\eta}} \right)$$

Elastic element:

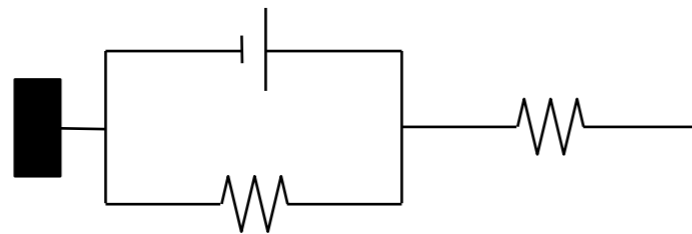
$$\tau_0 H(t) = G_2 \gamma_2 \Rightarrow \gamma_2(t) = \frac{\tau_0 H(t)}{G_2}$$

Total strain:

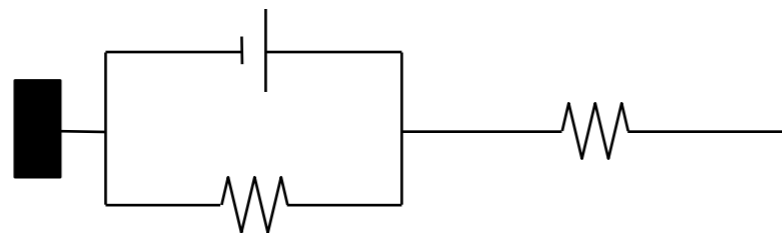
$$\gamma(t) = \tau_0 \left(\frac{1 - e^{-\frac{G_1 t}{\eta}}}{G_1} + \frac{1}{G_2} \right)$$



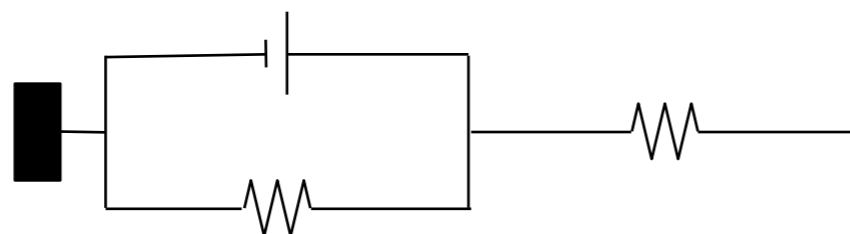
Initial state:



Instantaneous response:



Final state:





SLS - Creep and Relaxation Functions



The creep function, $J(t)$, and relaxation function, $G(t)$, for a material model is determined by setting the input (stress and strain, respectively) to be unity

For the three component model considered previously:

Creep function:

$$\gamma(t) = \tau_0 \left(\frac{1 - e^{-\frac{G_1 t}{\eta}}}{G_1} + \frac{1}{G_2} \right) \Rightarrow J(t) = \frac{1 - e^{-\frac{t}{\tau}}}{G_1} + \frac{1}{G_2}, \tau = \frac{\eta}{G_1}$$

Relaxation function:

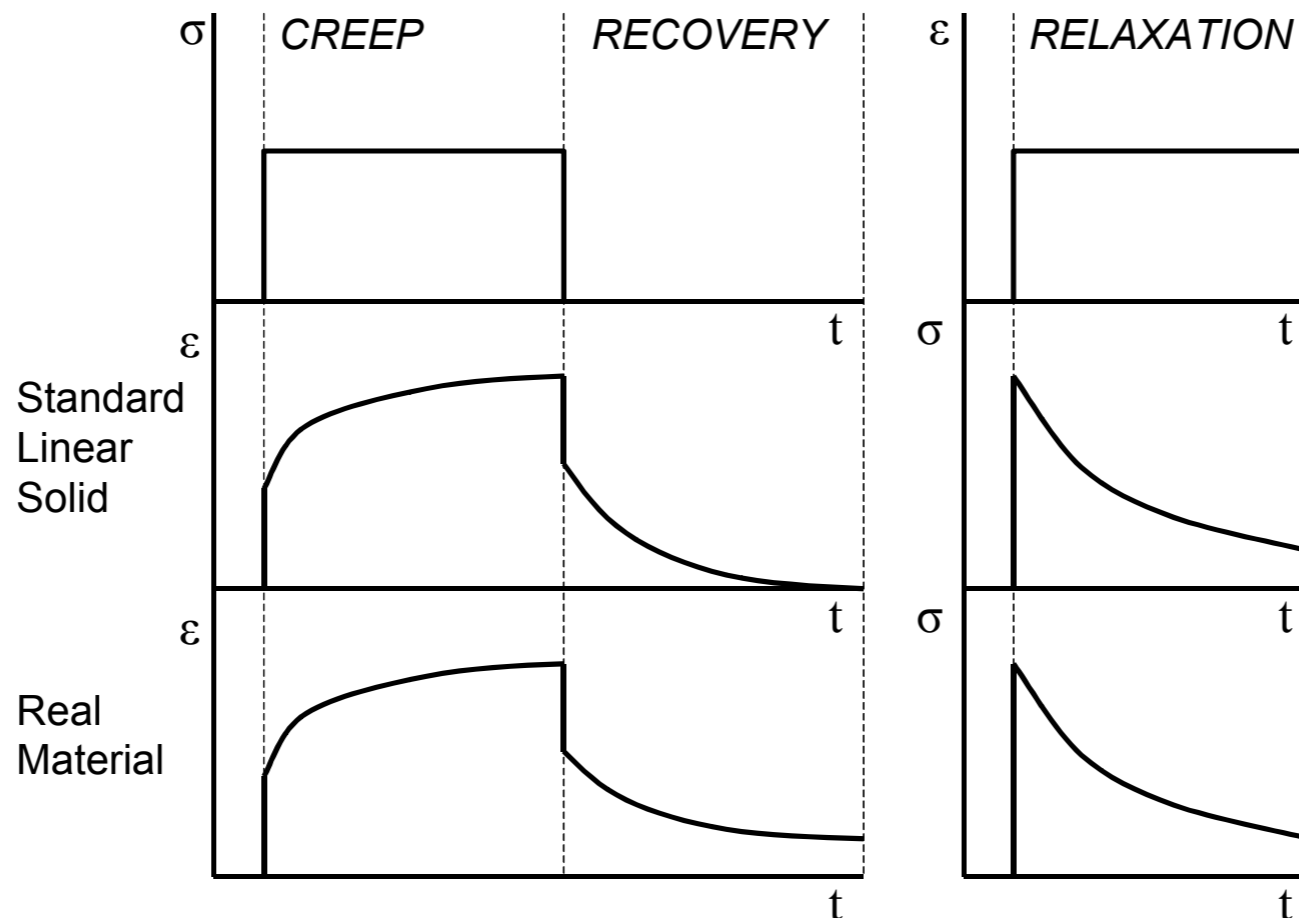
$$\tau(t) = G_2 \gamma_0 - \frac{G_2^2 \gamma_0}{G_1 + G_2} \left[1 - e^{-\frac{(G_1 + G_2)t}{\eta}} \right] \Rightarrow G(t) = \frac{G_1 G_2}{G_1 + G_2} \left(\frac{G_1 - G_2 e^{-\frac{t}{\tau}}}{G_1} \right), \tau = \frac{\eta}{G_1 + G_2}$$



SLS Response



The strain is seen to be made up of two components – an instantaneous deformation corresponding to the spring, and a delayed response corresponding to the Kelvin element. The creep compliance changes from an **unrelaxed** value, $J_U = 1/G_1$, at $t = 0$, to a **relaxed** value, $J_R = 1/G_1 + 1/G_2$, at infinite time.



The stress relaxes exponentially with time from a high initial value to a lower equilibrium value. The relaxation time depends on both the spring stiffness, G_1 , and the Kelvin element parameters, η and G_2 . This is in contrast with the retardation time in creep, which depends only on the Kelvin element parameters.

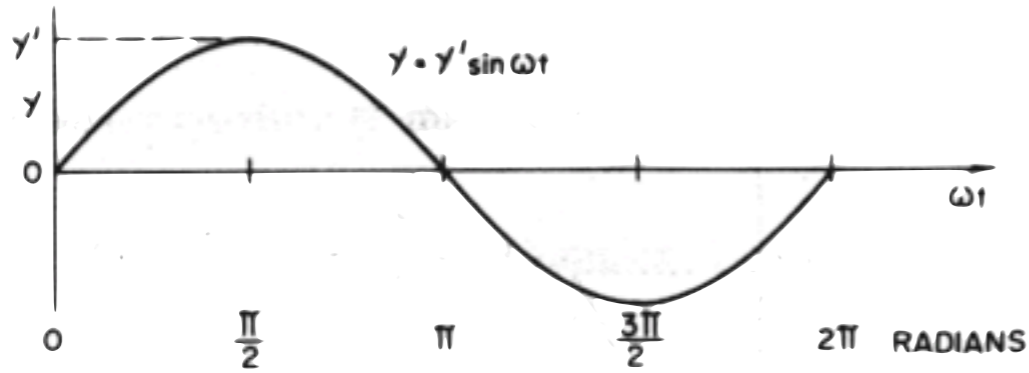
The relaxation modulus changes from an **unrelaxed** value, $G_U = G_2$, at $t = 0$, to a **relaxed** value, $G_R = G_1 G_2 / (G_1 + G_2)$, at infinite time.



Dynamic (Oscillatory) Testing



In Dynamic Oscillatory Testing the sample is deformed sinusoidally.

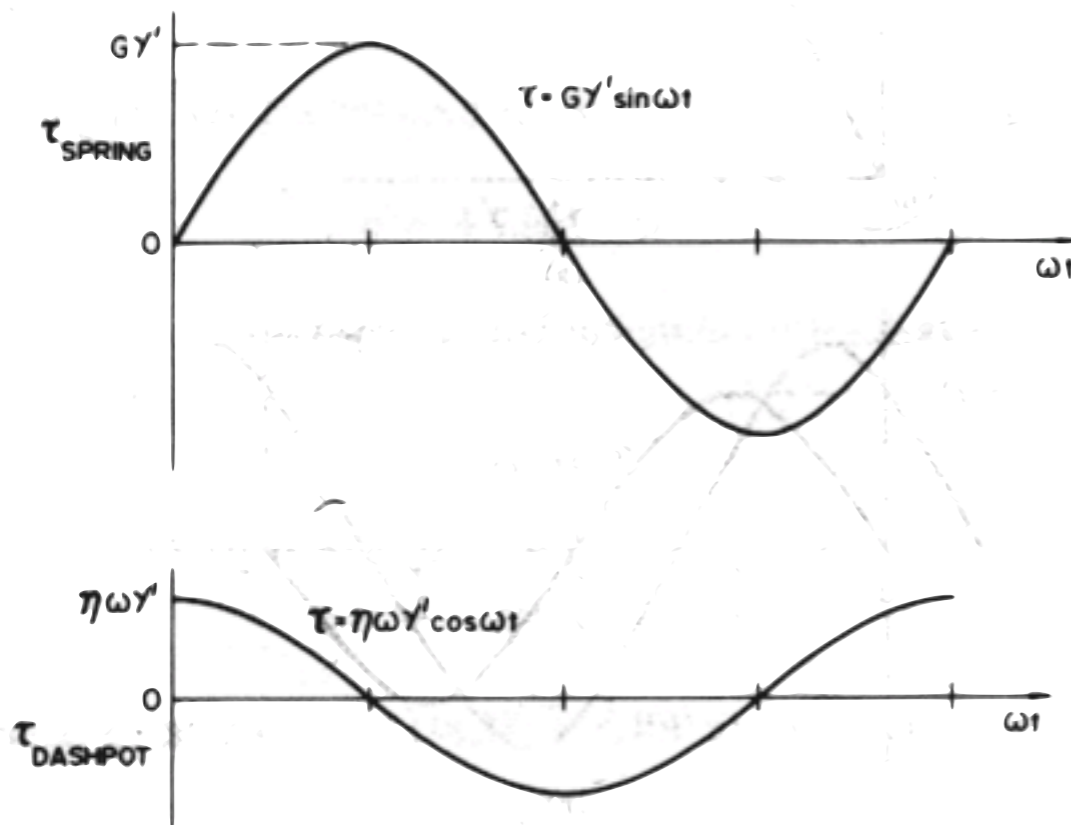


$$\gamma = \gamma_0 \sin(\omega t)$$

$$\dot{\gamma} = \gamma_0 \omega \cos(\omega t)$$

$$\tau_{\text{spring}} = G\gamma = G\gamma_0 \sin(\omega t)$$

In-phase response (0°)
(solid-like behavior)



$$\tau_{\text{dashpot}} = \eta\dot{\gamma} = \eta\gamma_0 \omega \cos(\omega t)$$

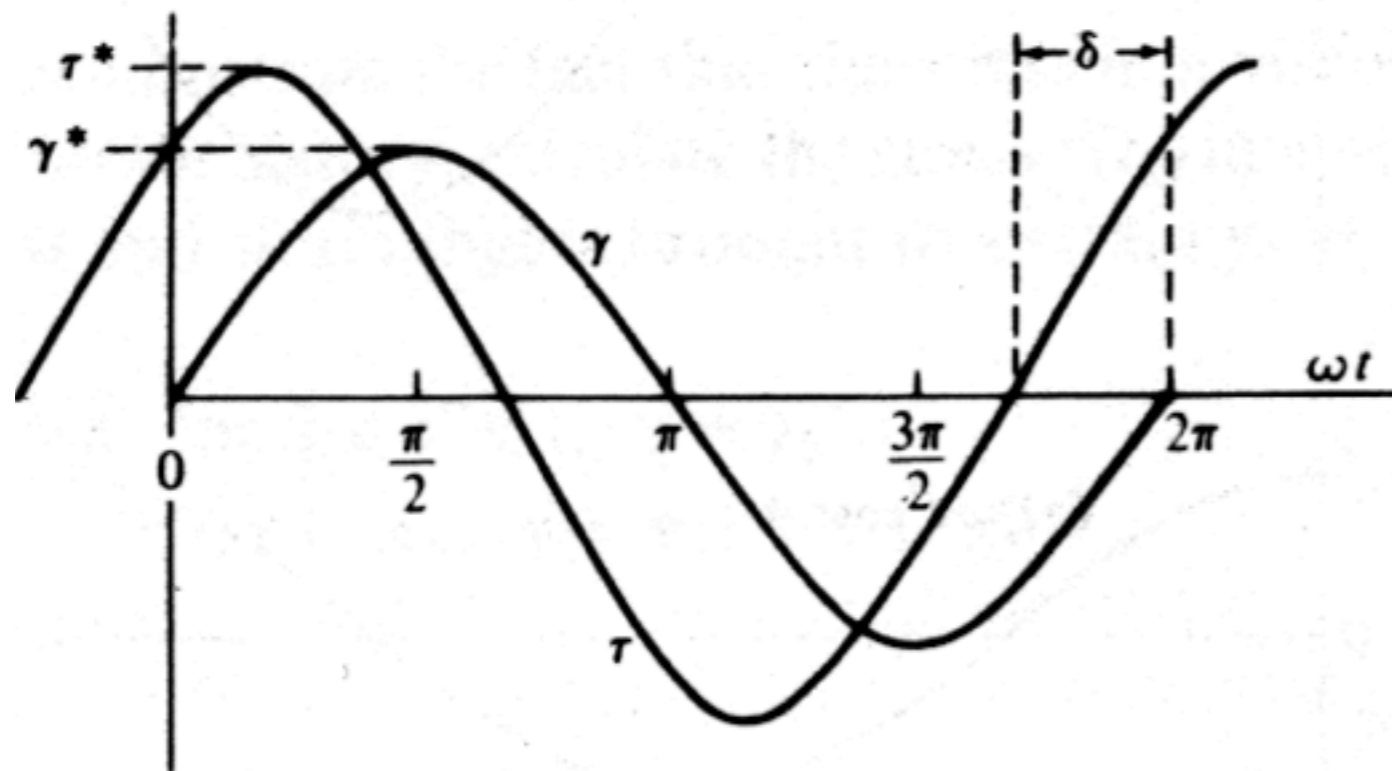
90° out-of-phase response
(liquid-like behavior)



Dynamic (Oscillatory) Testing



In the general case when the sample is deformed sinusoidally, as a response the stress will also oscillate sinusoidally at the same frequency, but in general will be shifted by a phase angle δ with respect to the strain wave. **The phase angle will depend on the nature of the material (viscous, elastic or viscoelastic).**



Input

$$\gamma = \gamma_0 \sin(\omega t)$$

Response

$$\tau = \tau_0 \sin(\omega t + \delta)$$

where $0^\circ < \delta < 90^\circ$



Dynamic (Oscillatory) Testing



By using trigonometry:

$$\tau = \tau_0 \sin(\omega t + \delta) = \underbrace{\tau'_0 \sin(\omega t)}_{\text{In-phase component}} + \underbrace{\tau''_0 \cos(\omega t)}_{\text{Out-of-phase component}}$$

In-phase component of the stress, representing solid-like behavior

Out-of-phase component of the stress, representing liquid-like behavior

Let's define: $\tau'_0 = G' \gamma_0$ and $\tau''_0 = G'' \gamma_0$

where:

$$G'(\omega) = \frac{\text{in - phase stress}}{\text{maximum strain}} = \frac{\tau'_0}{\gamma_0}, \text{ Elastic or Storage Modulus}$$
$$G''(\omega) = \frac{\text{out - of - phase stress}}{\text{maximum strain}} = \frac{\tau''_0}{\gamma_0}, \text{ Viscous or Loss Modulus}$$



Physical Meaning of G' , G''



Equation becomes:

$$\tau = \gamma_0 [G'(\omega) \sin(\omega t) + G''(\omega) \cos(\omega t)]$$

We can also define the loss tangent:

$$\tan \delta = \frac{G''}{G'}$$

For solid-like response:

$$\tau_{\text{spring}} = G\gamma = G\gamma_0 \sin(\omega t)$$

$$\therefore G' = G, G'' = 0, \tan \delta = 0, \delta = 0^\circ$$

For liquid-like response:

$$\tau_{\text{dashpot}} = \eta \dot{\gamma} = \eta \gamma_0 \omega \cos(\omega t)$$

$$\therefore G' = 0, G'' = \eta \omega, \tan \delta = \infty, \delta = 90^\circ$$



DMA Viscoelastic Parameters



The Complex Modulus: Measure of materials overall resistance to deformation.

$$G^* = \text{Stress}^* / \text{Strain}$$

$$G^* = G' + iG''$$

The Elastic (Storage) Modulus:
Measure of elasticity of material. The ability of the material to store energy.

$$G' = (\text{stress}^* / \text{strain}) \cos \delta$$

The Viscous (loss) Modulus:
The ability of the material to dissipate energy. Energy lost as heat.

$$G'' = (\text{stress}^* / \text{strain}) \sin \delta$$

Tan Delta:
Measure of material damping - such as vibration or sound damping.

$$\text{Tan } \delta = G'' / G'$$

Courtesy: TA Instruments



Standard linear solid - again



Zener's SLS model: a solid in which the stress, the strain and their first derivatives are related to each other in a linear relation:

$$\sigma + \tau_{\sigma} \dot{\sigma} = M_R \left(\varepsilon + \tau_{\varepsilon} \dot{\varepsilon} \right)$$

where τ_{ε} is the characteristic relaxation time for strain under an applied step in stress (**creep experiment**), and τ_{σ} is the characteristic relaxation time for stress under an applied step in strain (**relaxation experiment**).

M_R represents the **relaxed** modulus, i.e. the stress/strain ratio when all the relaxation is occurred and the time derivatives are 0.

If the changes in stress and strain in the material occur so rapidly (e.g., at sufficiently high frequencies) that relaxation cannot proceed to completion, it can be shown that the stress/strain ratio is given by the **unrelaxed** elastic modulus.



Creep function



The response to a step function load $\sigma = \sigma_0 H(t)$ of the SLS can be written as:

$$\varepsilon(t) = \frac{\sigma_0}{M_R} \left[1 - \left(1 - \frac{\tau_\sigma}{\tau_\varepsilon} \right) e^{-t/\tau_\varepsilon} \right]$$

and M_R gives the ratio of stress to strain when t goes to infinity (i.e. $f \rightarrow 0$). The response can be written also as:

$$\varepsilon(t) = \frac{\sigma_0}{M_U} [1 + \phi(t)]$$

where ϕ is called the **creep** function for that modulus.

For elastic materials $\phi = 0$ and $M_U = \mu$ (for S waves) or $M_U = \lambda + 2\mu$ (for P-waves), while for anelastic materials there is an instantaneous strain (i.e. high frequencies), σ_0/M_U , explaining that the subscript u stands for **unrelaxed** modulus. By comparison with previous expression one has:

$$M_R = M_U \frac{\tau_\sigma}{\tau_\varepsilon} \quad \text{and} \quad \phi(t) = \left(\frac{\tau_\sigma}{\tau_\varepsilon} - 1 \right) \left(1 - e^{-t/\tau_\varepsilon} \right)$$



Complex modulus



In general, the ratio of stress to strain for a SLS is:

$$\frac{\sigma(t)}{\varepsilon(t)} = M^* = M_R + \frac{(M_U - M_R)\omega^2\tau_\sigma^2}{1 + \omega^2\tau_\sigma^2} + i \frac{(M_U - M_R)\omega\tau_\sigma}{1 + \omega^2\tau_\sigma^2}$$

that represents a complex modulus that is frequency dependent, implying **dispersed** seismic velocities.

It can be shown that:

$$c^2(\omega) = \frac{M_R}{\rho} \left[1 + \frac{1}{2} \frac{(M_U - M_R)}{M_R} \frac{\omega^2\tau_\sigma^2}{1 + \omega^2\tau_\sigma^2} \right]^2$$

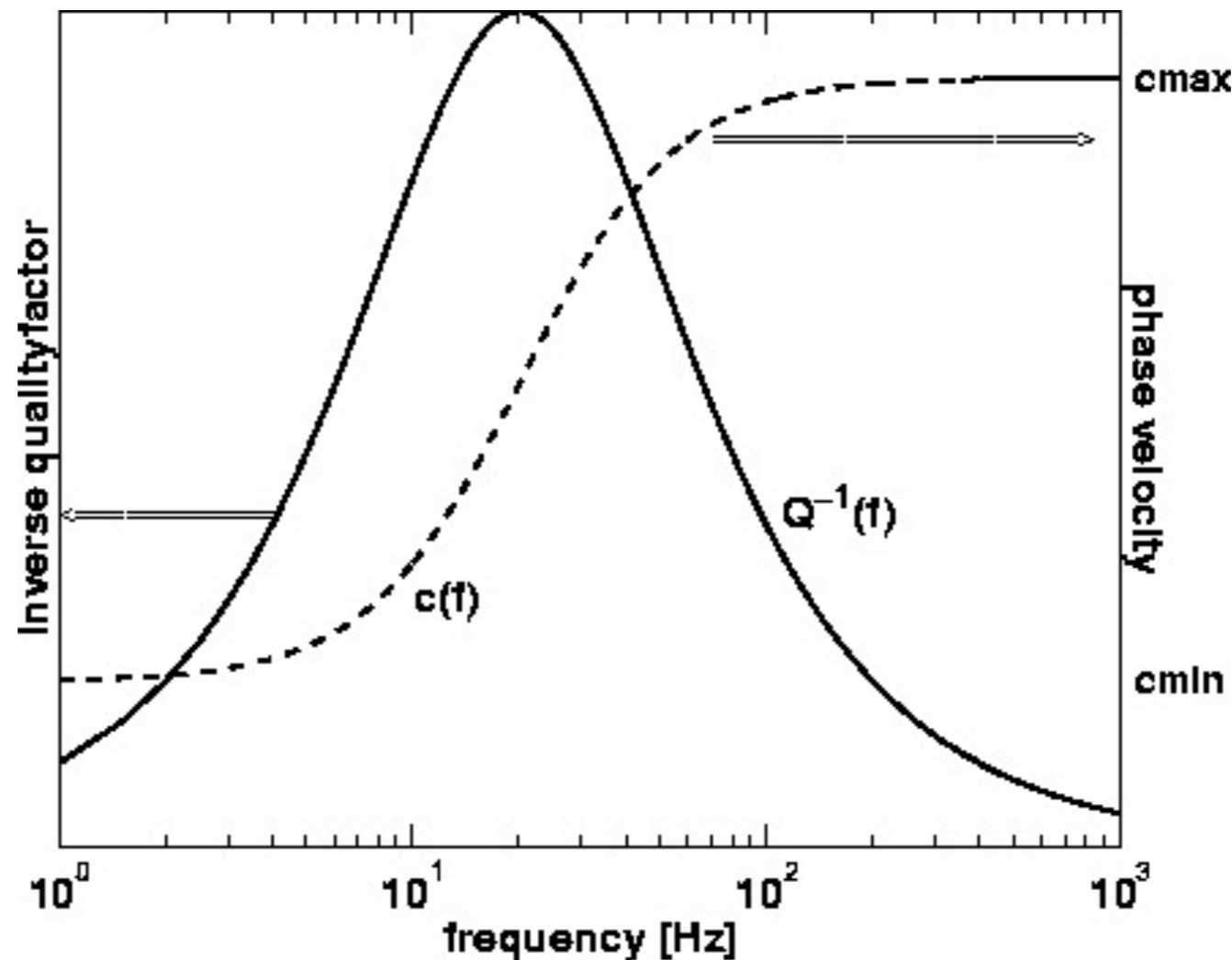
$$\frac{1}{Q(\omega)} = \frac{(M_U - M_R)}{M_R} \frac{\omega\tau_\sigma}{1 + \omega^2\tau_\sigma^2}$$



Debye peak



That can be plotted versus frequency, showing that maximum of attenuation occurs at a frequency of $(\tau_\epsilon \tau_\sigma)^{-1/2}$ (**Debye peak**). Velocity is $(M_R/\rho)^{1/2}$ at $\omega=0$ (full relaxation) and $(M_U/\rho)^{1/2}$ at infinite frequency (unrelaxed), while the internal friction is 0 for both these extreme cases.





Different definitions of Q



If a volume of material is cycled in stress at a frequency ω , then a dimensionless measure of the internal friction is given by

$$\frac{1}{Q(\omega)} = \frac{\Delta E}{2\pi E}$$

where E is the peak strain energy stored in the volume and ΔE is the energy lost in each cycle because of imperfections in the elasticity of the material.

The definition is rarely of direct use and more commonly one observes either

- 1) the temporal decay of amplitude in a standing wave at fixed wavenumber
- 2) the spatial decay of amplitude in a propagating wave at fixed frequency.

The assumption that is usually made is that attenuation is a linear phenomenon and a wave may be resolved into its Fourier components, each of which can be studied by 1 or 2.



Intrinsic attenuation



For a propagating wave, **intrinsic attenuation** can be described by Q factor:

A) after n periods of oscillation (i.e. at $t=nT=n \cdot 2\pi/\omega$)

$$A(nT) = A_0 \left(1 - \frac{\pi}{Q}\right)^n = A_0 \left(1 - \frac{\omega t}{2Qn}\right)^n \Rightarrow A(t) = A_0 \exp\left(-\frac{\omega t}{2Q}\right)$$

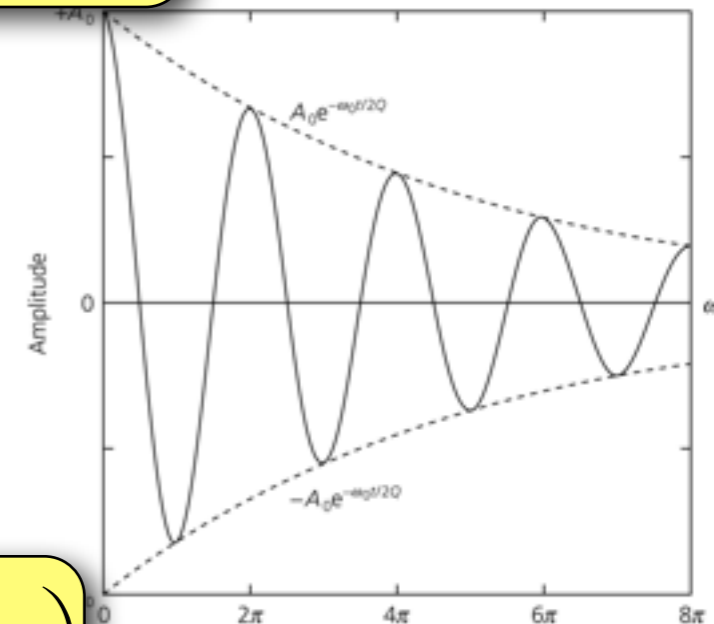
for large times

resulting in a definition of **temporal Q**

B) after a path of a wavelength the amplitude decay is

$$\Delta A = \frac{dA}{dx} \lambda \Rightarrow -\frac{A\pi}{Q} = \frac{dA}{dx} \frac{2\pi c}{\omega} \Rightarrow A(x) = A_0 \exp\left(-\frac{\omega x}{2cQ}\right)$$

resulting in a definition of **spatial Q** and the effect is to replace real frequencies and wavenumbers with complex valued quantities in the expression: $\exp[i(\omega t - kx)]$





Frequency dependence of Q

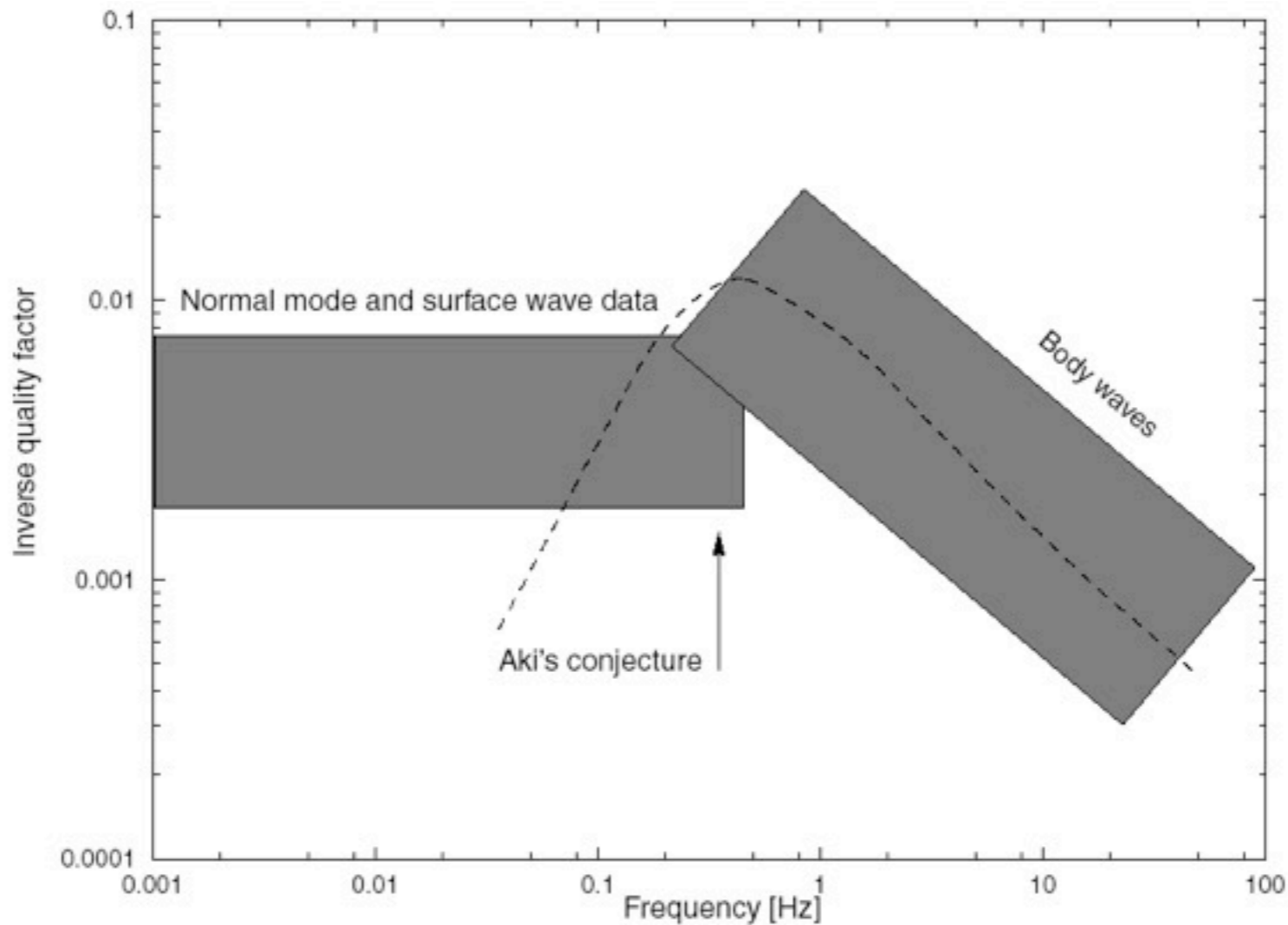


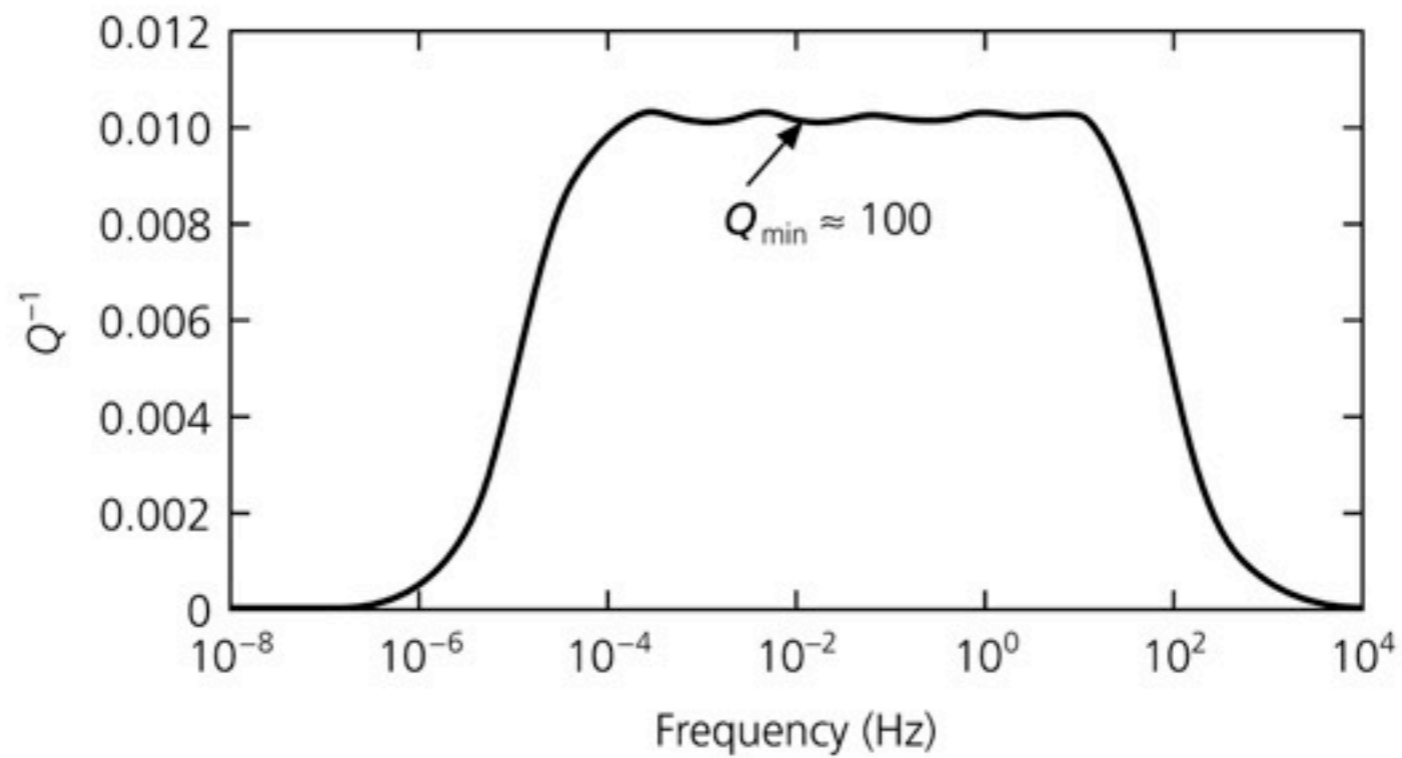
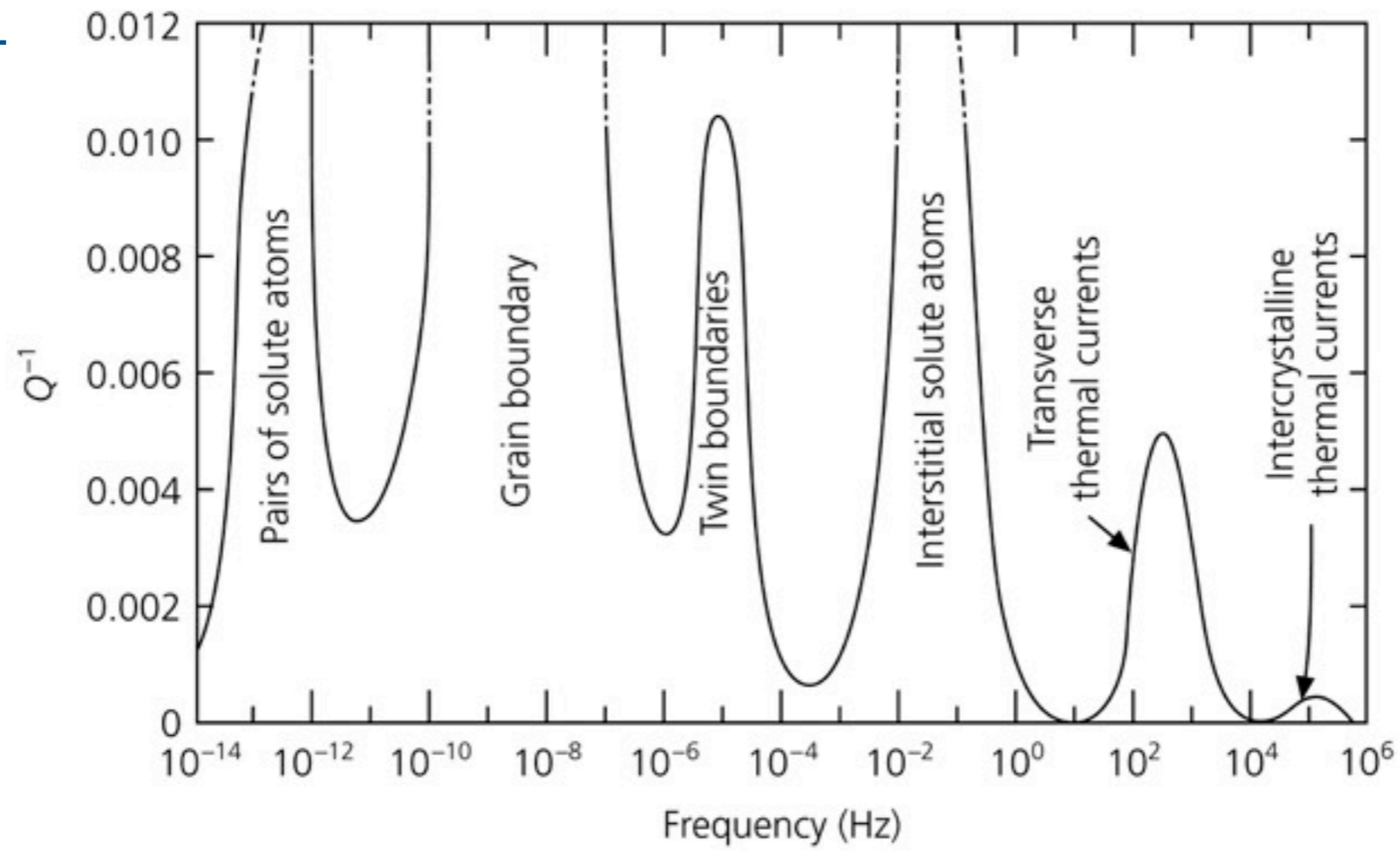
Figure 1

Schematic sketch of frequency dependent Q measurements. The height of the boxes indicates roughly the uncertainty in measurements. The position of the resonance peak conjectured by AKI (1980) is also shown. After SIPKIN and JORDAN (1979), AKI (1980) and SATO and FEHLER (1998).

Q for seismic waves is observed to be largely independent of frequency between 0.001 and 1.0 Hz; at higher frequencies it increases. To explain this, one has to superpose numerous Debye peaks, obtaining an **absorption** band.



Figure 3.7-16: Relaxation spectrum for a polycrystalline material.





Physical dispersion due to anelasticity:

Assume that a delta function wave propagates through a homogeneous elastic medium with intrinsic velocity c : $u(x, t) = \delta(t - x/c)$

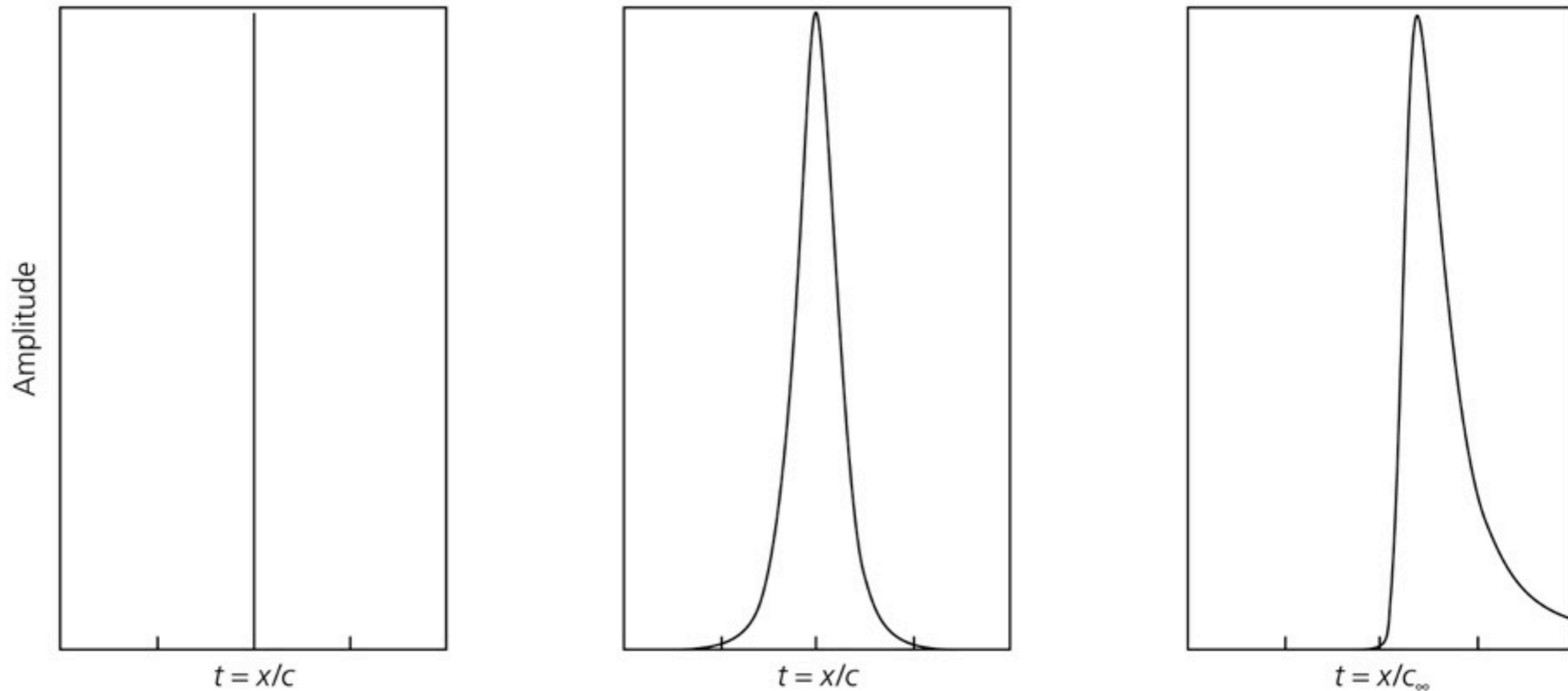
The Fourier transform of the delta function is $F(\omega) = \int_{-\infty}^{\infty} u(x, t)e^{-i\omega t} dt = \int_{-\infty}^{\infty} \delta(t - x/c)e^{-i\omega t} dt = e^{(-i\omega x/c)}$

If there is no dispersion, all the frequencies travel at the same speed and arrive at the same time.

The effect of attenuation varies as a function of frequency, $A(\omega) = \exp\left(\frac{-\omega x}{2cQ}\right)$



Figure 3.7-14: Demonstration of physical dispersion for an attenuated pulse.



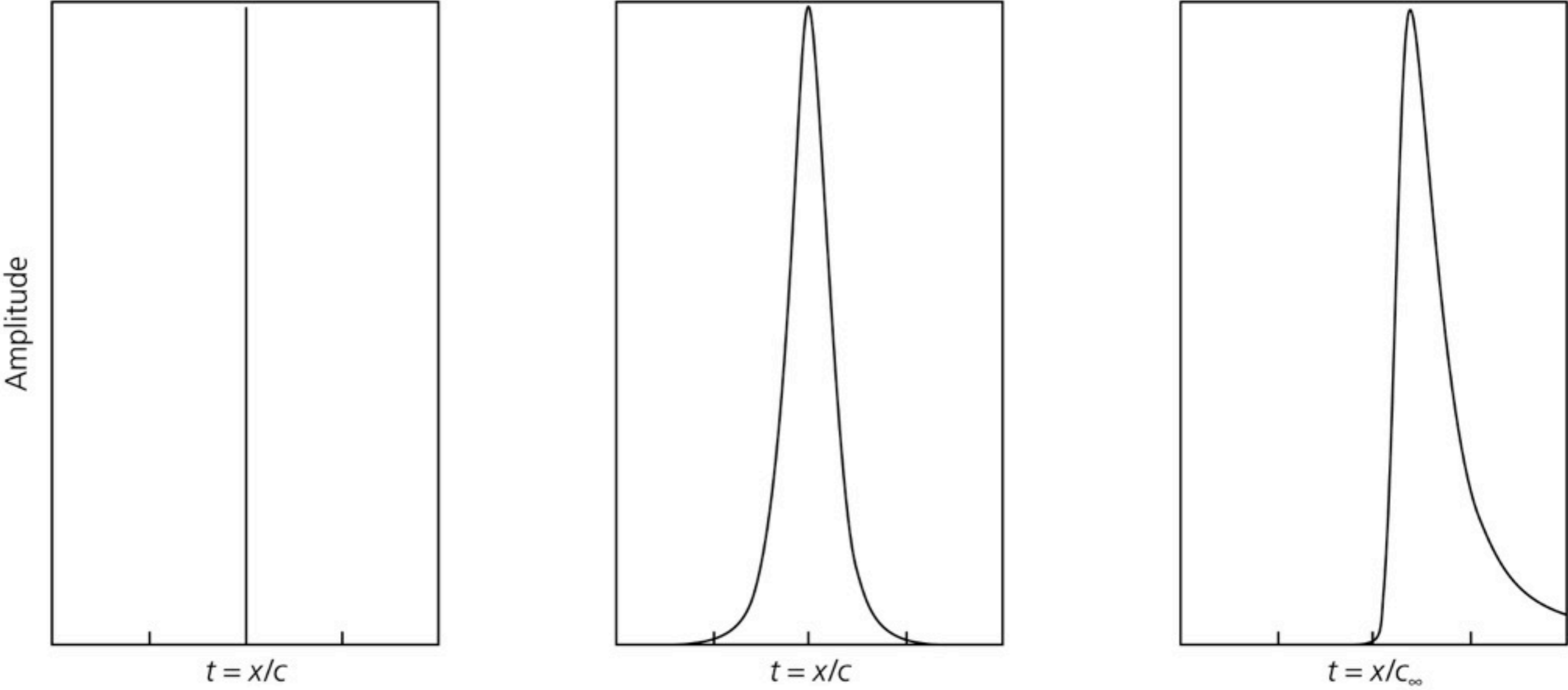
Multiply $F(\omega)$ by $A(\omega)$ and take inverse Fourier transform:

$$u(x, t) = \frac{1}{2\pi} \int_{-\infty}^{\infty} A(\omega)F(\omega)e^{i\omega t} d\omega = \frac{1}{2\pi} \int_{-\infty}^{\infty} \exp\left(\frac{-\omega x}{2cQ}\right) \exp\left(\frac{-i\omega x}{c}\right) e^{i\omega t} d\omega$$

Evaluating the integral yields
$$u(x, t) = \frac{(x/2cQ)}{\pi[(x/2cQ)^2 + (x/c - t)^2]}$$

so the delta function is broadened by attenuation into a wavelet that is symmetric in time about its maximum at $t = x/c$. Problem! Non-causal!

Figure 3.7-14: Demonstration of physical dispersion for an attenuated pulse.



The physical mechanisms that cause attenuation must prevent waves of all frequencies from traveling at the same speed. Dispersion!

A dispersion relation for phase velocity as a function of frequency, called Azimi's attenuation law, is

$$c(\omega) = c_0 \left[1 + \frac{1}{\pi Q} \ln \left(\frac{\omega}{\omega_0} \right) \right] \quad (c_0 \text{ is the velocity corresponding to a reference frequency } \omega_0)$$



Attenuation and dispersion



Wave propagation in anelastic media can be treated once the elastic problem is solved: elastic velocity and propagation factor have to be replaced by:

$$\frac{1}{c_e} \rightarrow \frac{1}{c(\omega)} \left(1 - \frac{i}{2Q(\omega)} \right)$$

$$\exp \left[i(\omega t - Kx) \right] = \exp \left[\frac{-\omega x}{2c(\omega)Q(\omega)} \right] \exp \left[i\omega \left(t - \frac{x}{c(\omega)} \right) \right]$$

Since Q has to be constant in the absorption range, dispersion still have to be present (**body wave dispersion**). Using a reference frequency, ω_0 , the wave velocity in an anelastic medium is:

$$c(\omega_0) \left[1 + \frac{1}{\pi Q} \ln \left(\frac{\omega}{\omega_0} \right) - \frac{i}{2Q} \right]$$



Complex velocities



An expression for the wave slowness can be given for S (and P) waves:

$$\frac{1}{\beta} = \frac{1}{B_1} - iB_2$$

where B_1 is the frequency dependent velocity and B_2 is the phase attenuation:

$$B_1(\omega) = \frac{B_1(\omega_0)}{\left[1 + \frac{2}{\pi} B_1(\omega_0) B_2(\omega_0) \log\left(\frac{\omega}{\omega_0}\right) \right]} \quad B_2(\omega) = \frac{1}{2B_1(\omega) Q_\beta}$$

The surface wave phase velocity will be expressed as:

$$\frac{1}{c} = \frac{1}{C_1} - iC_2$$

where C_1 is the attenuated phase velocity and C_2 is the phase attenuation, necessary to compute synthetic seismograms in anelastic media.



Q in the Earth



Rock Type	Q_p	Q_s
Shale	30	10
Sandstone	58	31
Granite	250	70-250
Peridotite	650	280
Midmantle	360	200
Lowermantle	1200	520
Outer Core	8000	



Q in the Earth



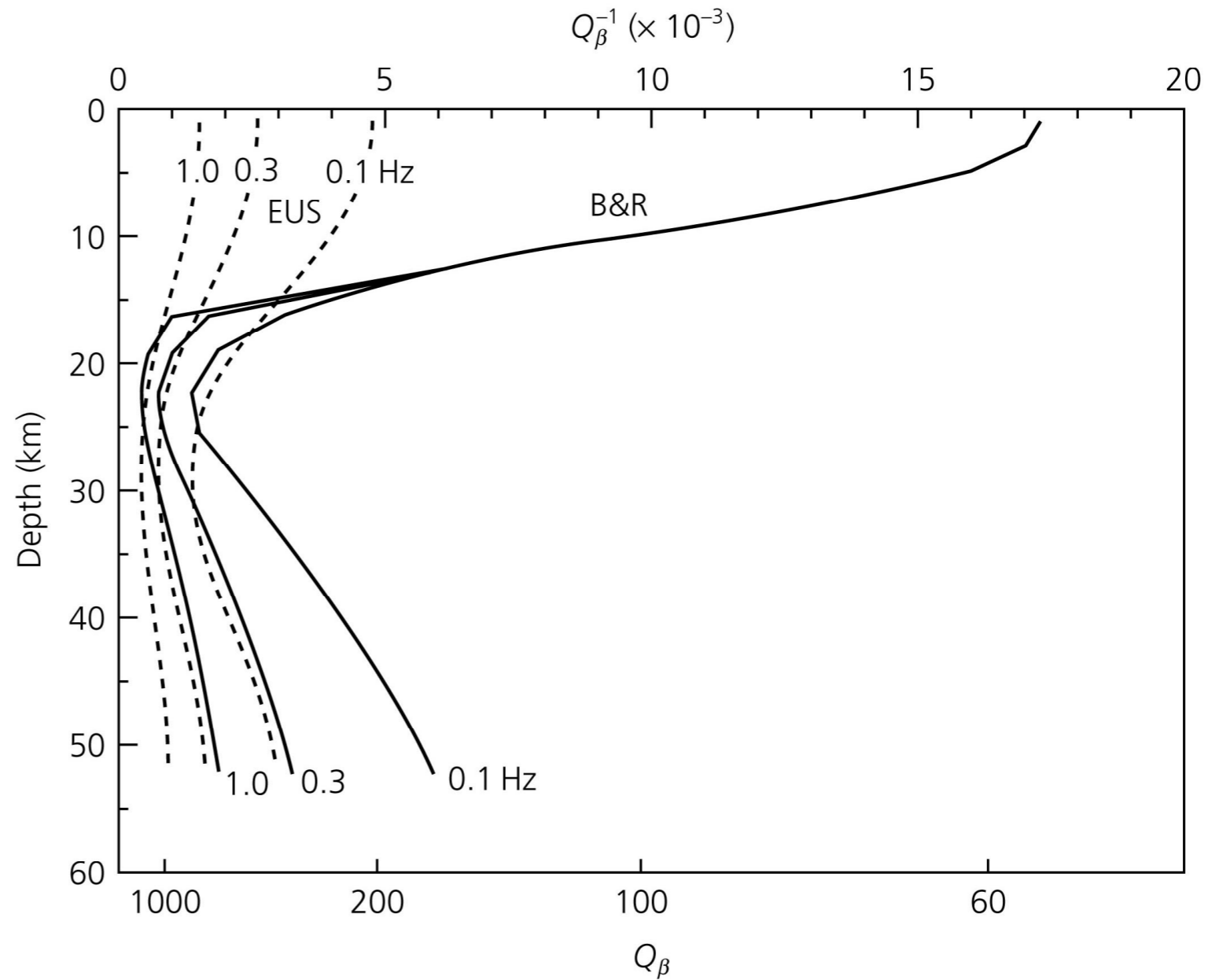
ATTENUATION VARIES BOTH WITH DEPTH AND Laterally

In the crust, the greatest attenuation (lowest Q or highest Q^{-1}) is near the surface, presumably due to fluids.

Attenuation is lowest at ~20-25 km, and increases again, presumably due to increasing temperature.

Attenuation decreases as a function of frequency.

Figure 3.7-17: Regional variations in lithospheric attenuation.

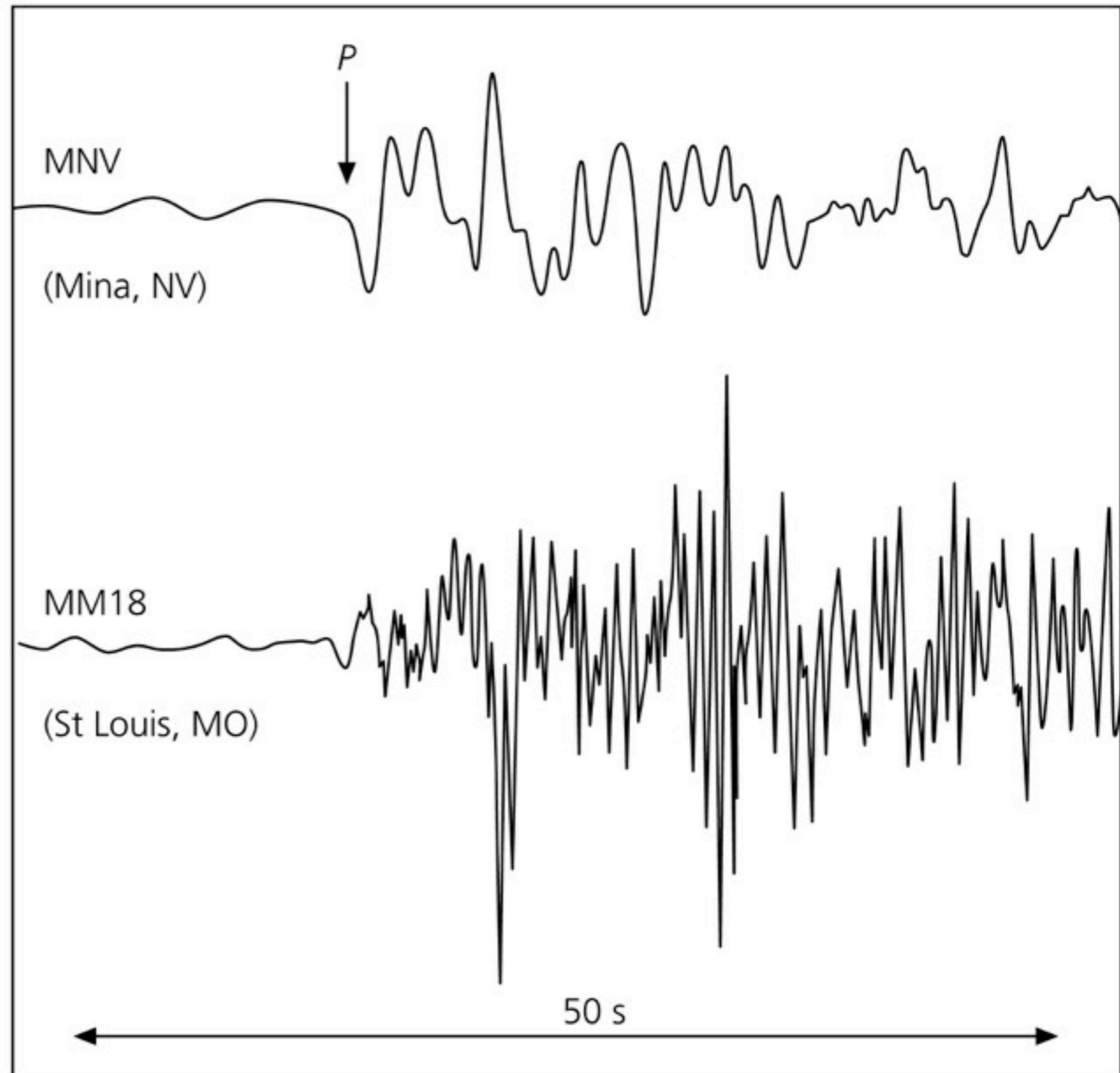




Seismograms from an earthquake in Texas recorded in Nevada and Missouri.

The MNV record has less high frequencies because the tectonically-active western U.S. is more attenuating than the stable mid-continent.

Figure 3.7-1: Regional effects of attenuation.

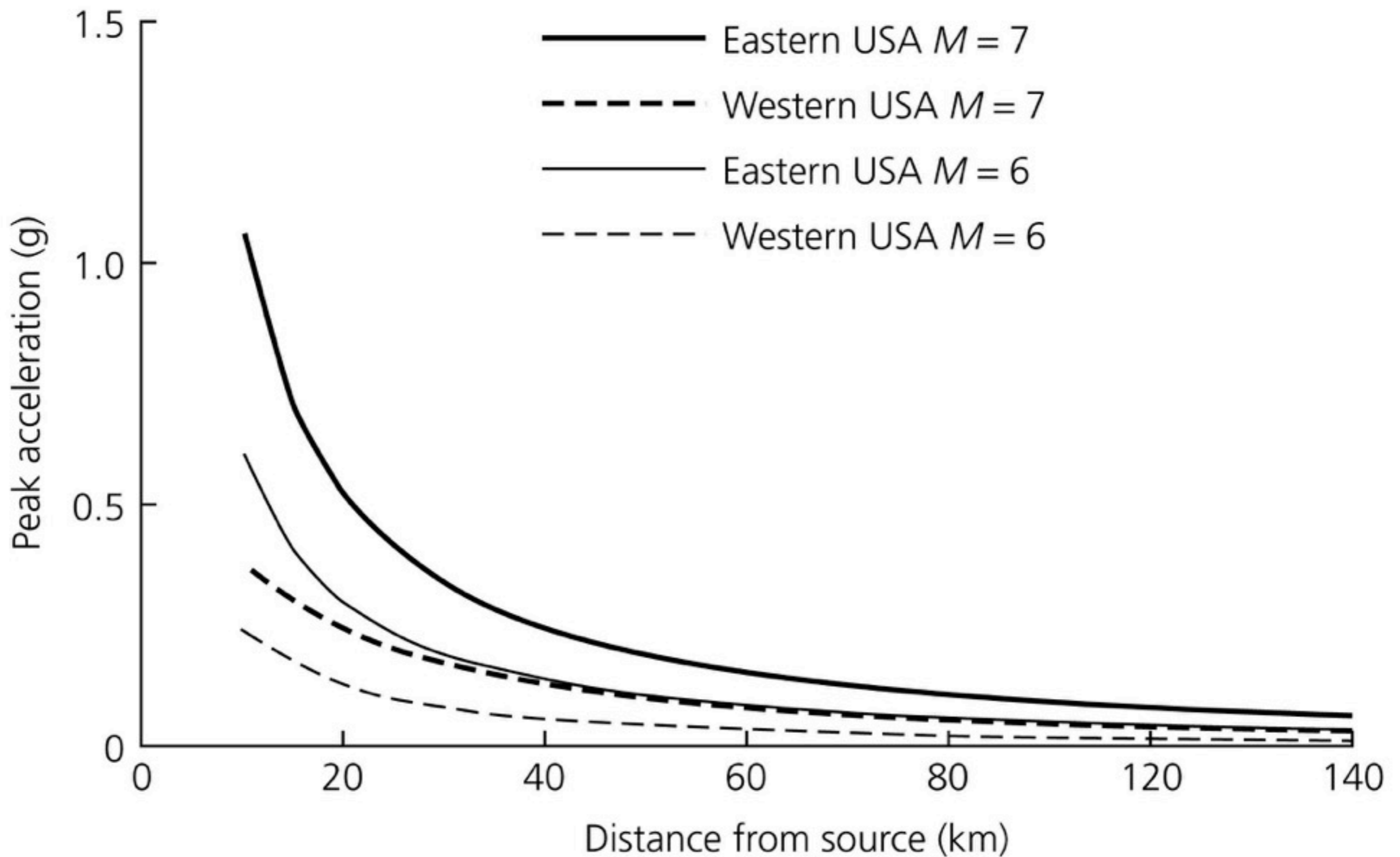




Attenuation laws

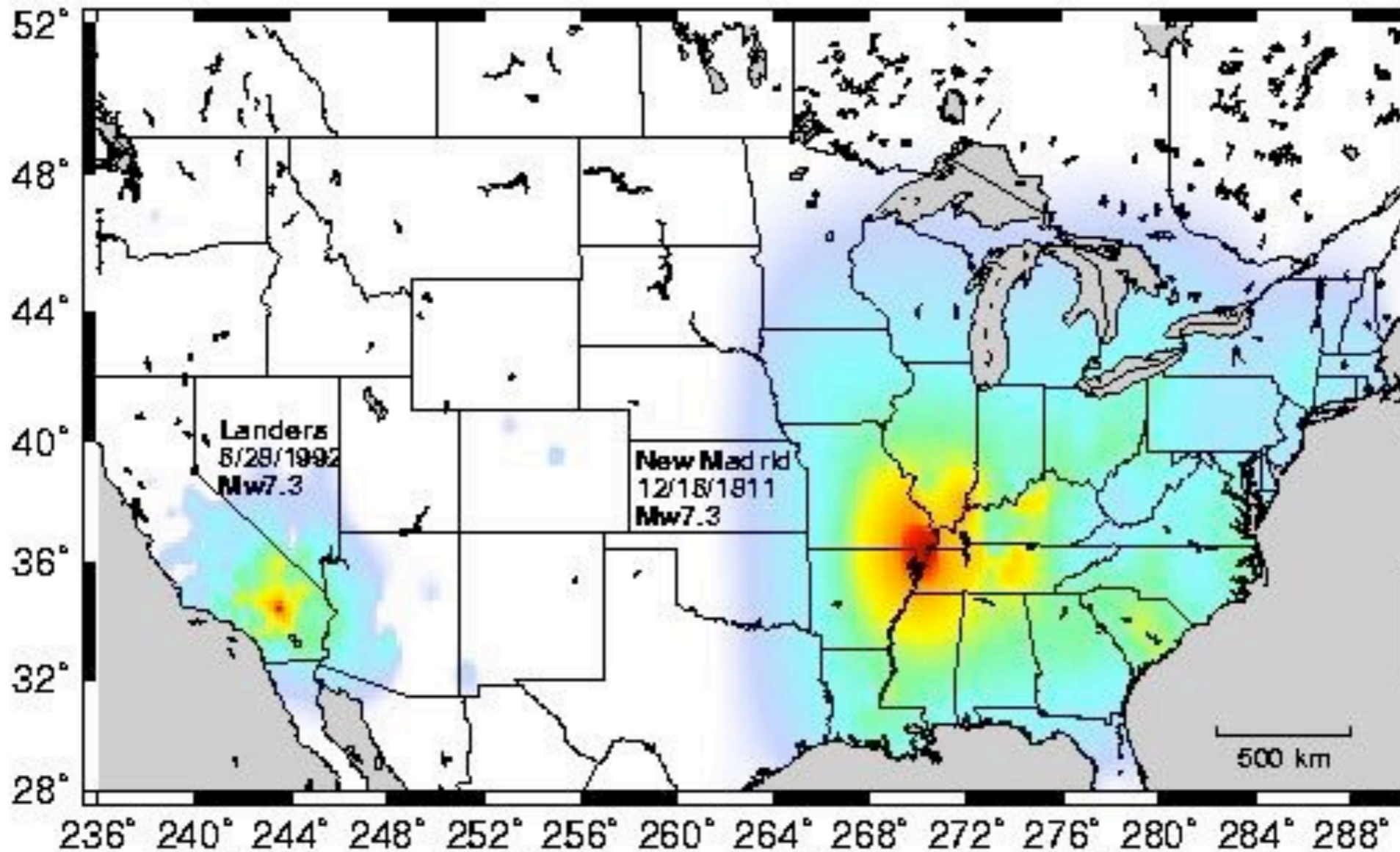


Figure 1.2-5: Predicted strong ground motion in eastern and western U.S.





Seismic hazard



PERCEIVED SHAKING	Not felt	Weak	Light	Moderate	Strong	Very strong	Severe	Violent	Extreme
POTENTIAL DAMAGE	none	none	none	Very light	Light	Moderate	Moderate/Heavy	Heavy	Very Heavy
PEAK ACC. (%g)	< 0.17	0.17-1.4	1.4-3.9	3.9-9.2	9.2-18	18-34	34-65	65-124	> 124
PEAK VEL. (cm/s)	< 0.1	0.1-1.1	1.1-3.4	3.4-8.1	8.1-16	16-31	31-60	60-116	> 116
INSTRUMENTAL INTENSITY	I	II-III	IV	V	VI	VII	VIII	IX	X+