

ESPERIENZA 1

Sintesi di acetilacetato complessi di metalli di transizione della prima serie

Il comportamento acido/base del 2,4-pentandione

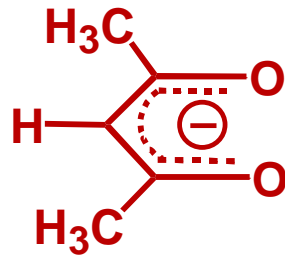
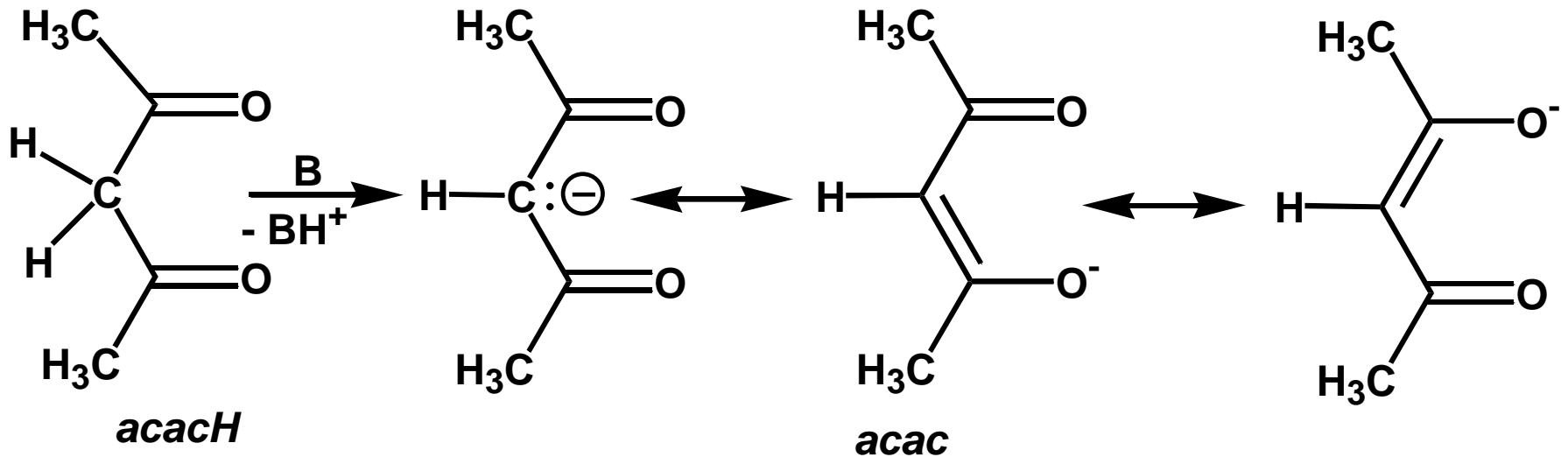

La **coordinazione** dello ione acetilacetonato ai metalli di transizione

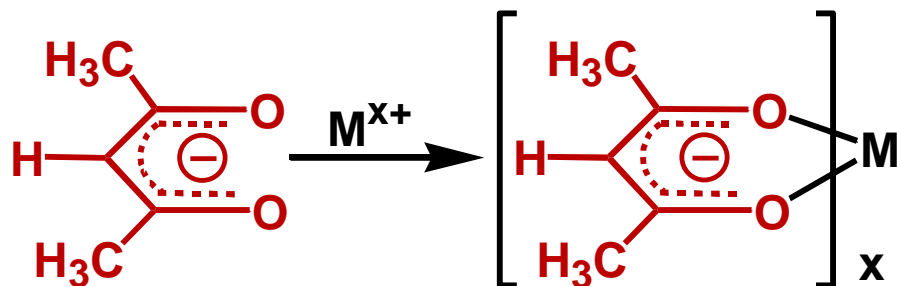

Altre **forme di risonanza** dovute alla coordinazione

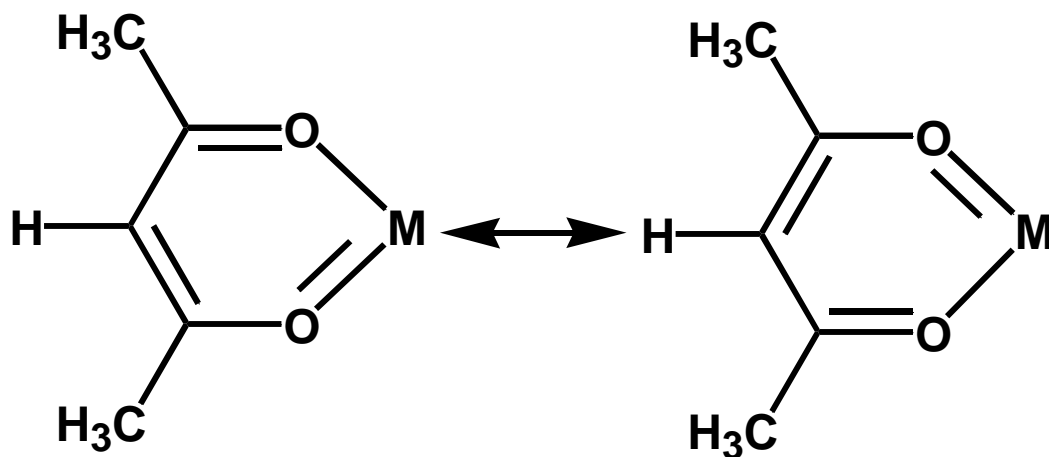

Distanze di legame a due a due **uguali**: M-O, C-O, C-C

Sintesi di $[\text{Cr}(\text{acac})_3]$

Idrolisi dell'urea



Sintesi del complesso

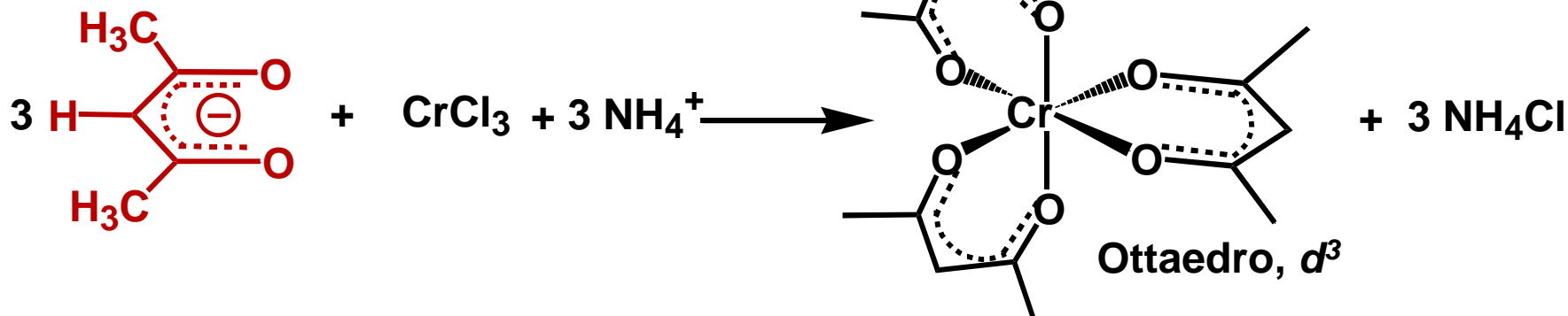

paramagnetico

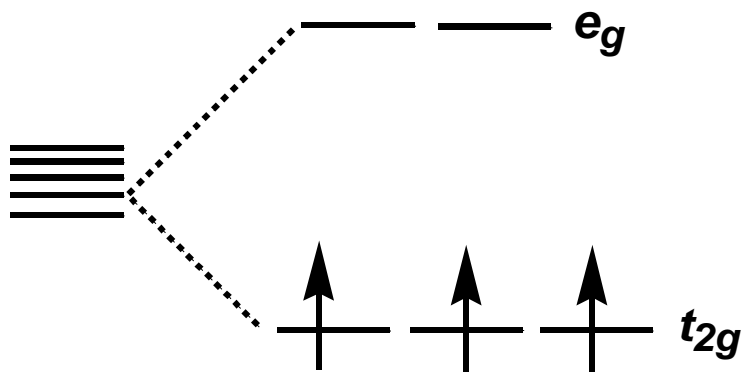

Sintesi di $[\text{Mn}(\text{acac})_3]$

Sintesi del complesso

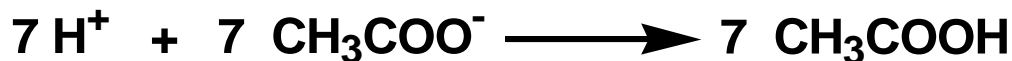
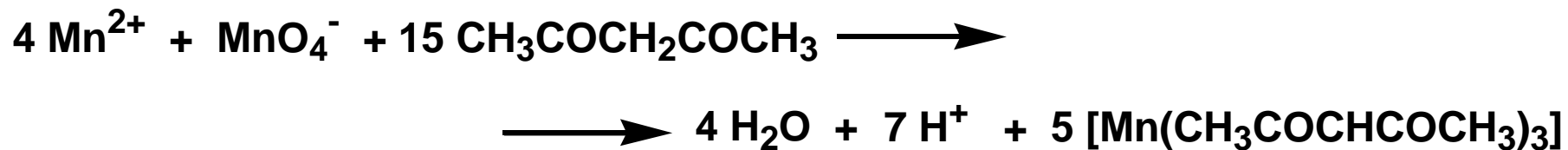
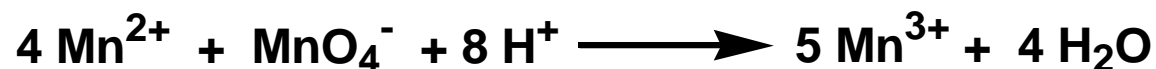

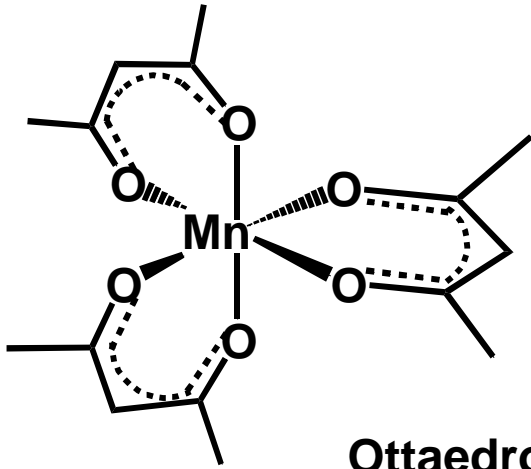

Ottaedro, d^4

Distorsioni per effetto Jahn-Teller:

Allungamento: 2 Mn-O 2.12 Å;
4 Mn-O 1.93 Å;

Compressione: 2 Mn-O 1.95 Å;
4 Mn-O 2.00 Å.

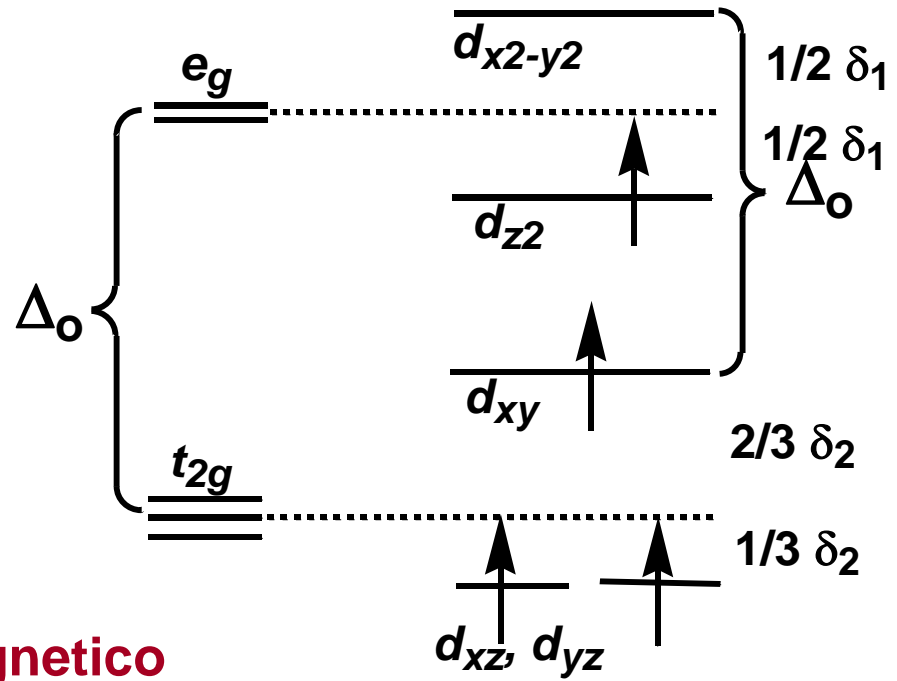
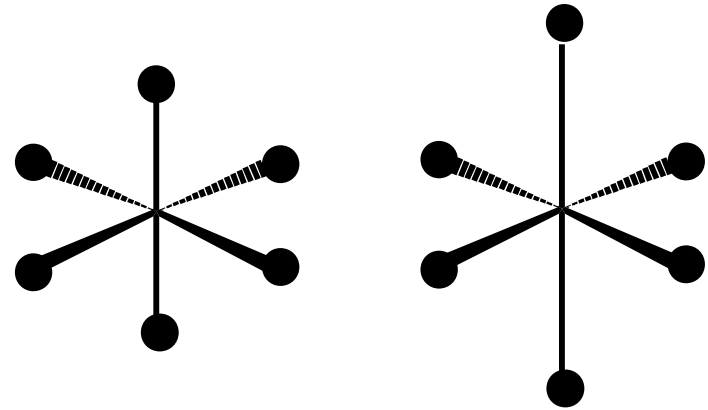

paramagnetico

Sintesi di $[\text{Fe}(\text{acac})_3]$

Sintesi del complesso

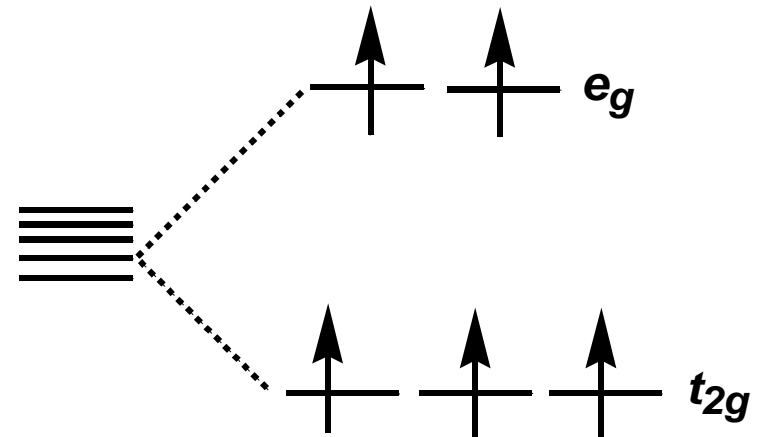
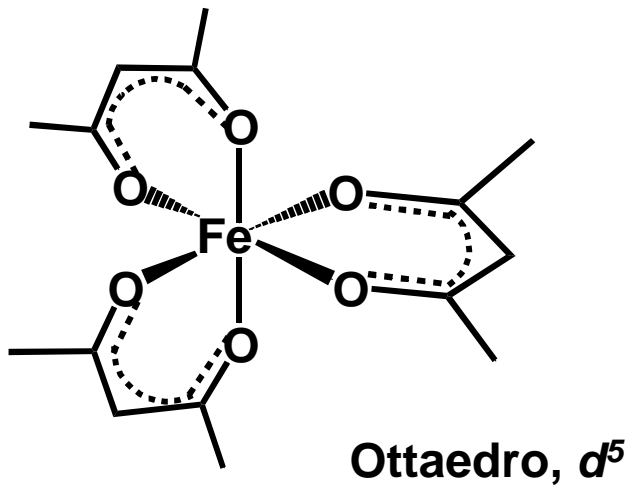
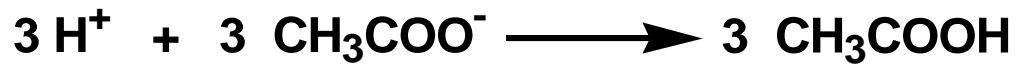

paramagnetico

Sintesi di [Co(acac)₃]

Sintesi del complesso

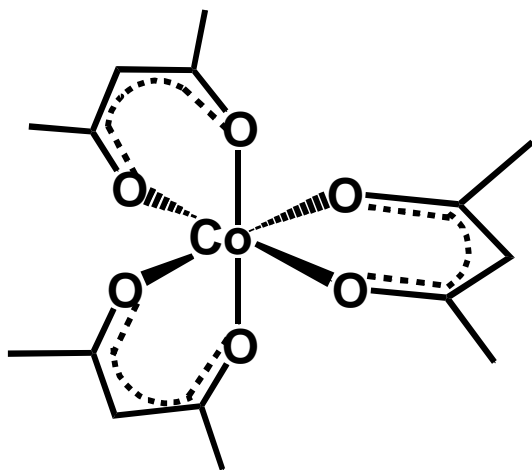
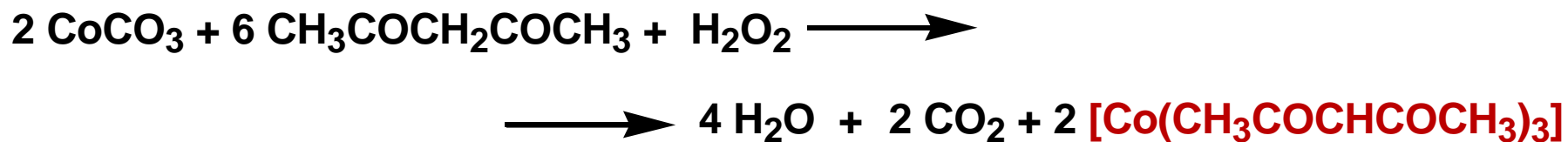

Ottaedro, d^6

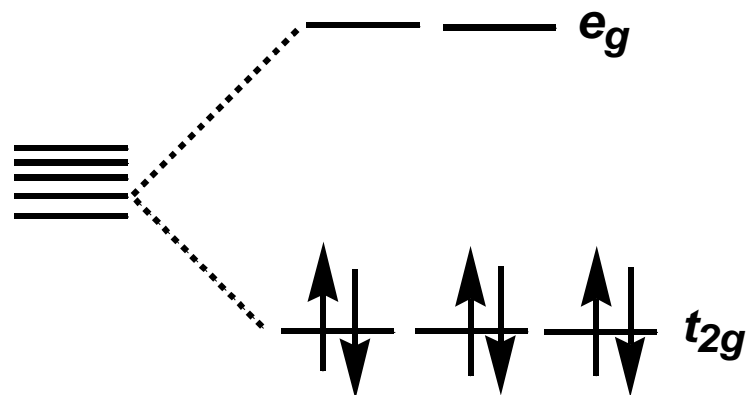

diamagnetico

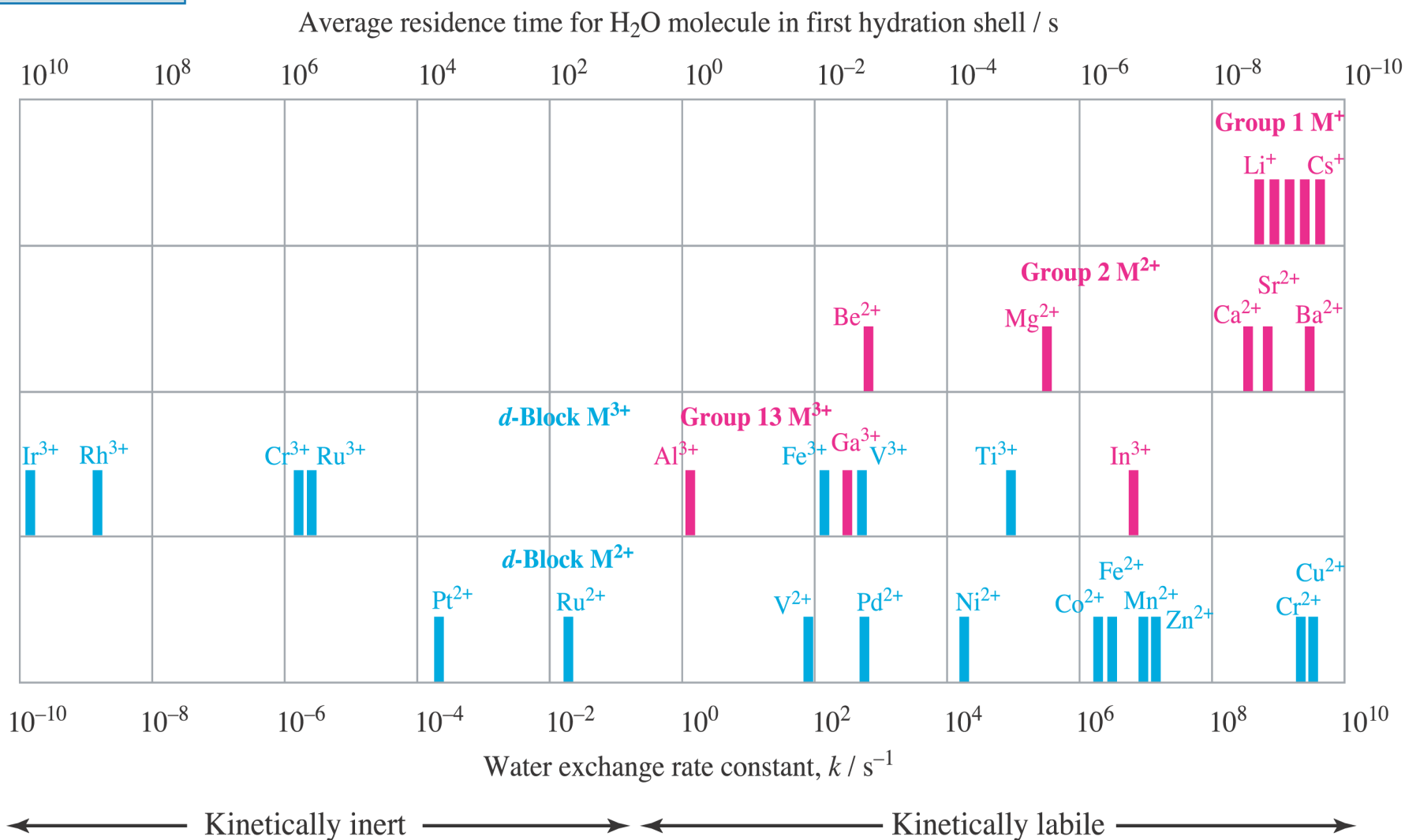
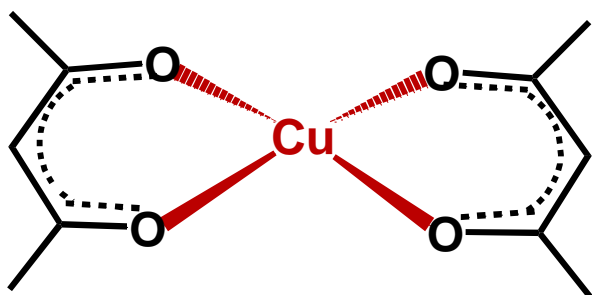
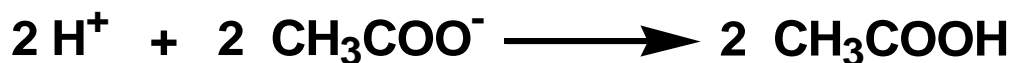
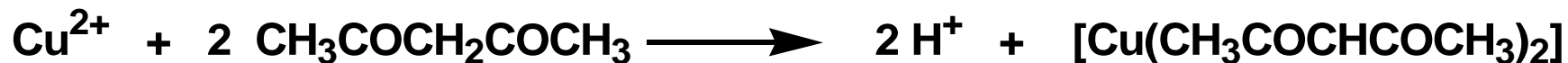

Fig. 26.1 Water exchange rate constants and average residence times for water molecules in the first coordination sphere of aquated metal ions at 298 K. Group 1, 2 and 13 metal ions are shown in pink, and d -block metal ions in blue. [Based on S.F. Lincoln (2005) *Helv. Chim. Acta*, vol. 88, p. 523 (Figure 1).]

Sintesi di $[\text{Cu}(\text{acac})_2]$

Sintesi del complesso



planare quadrato, d^9

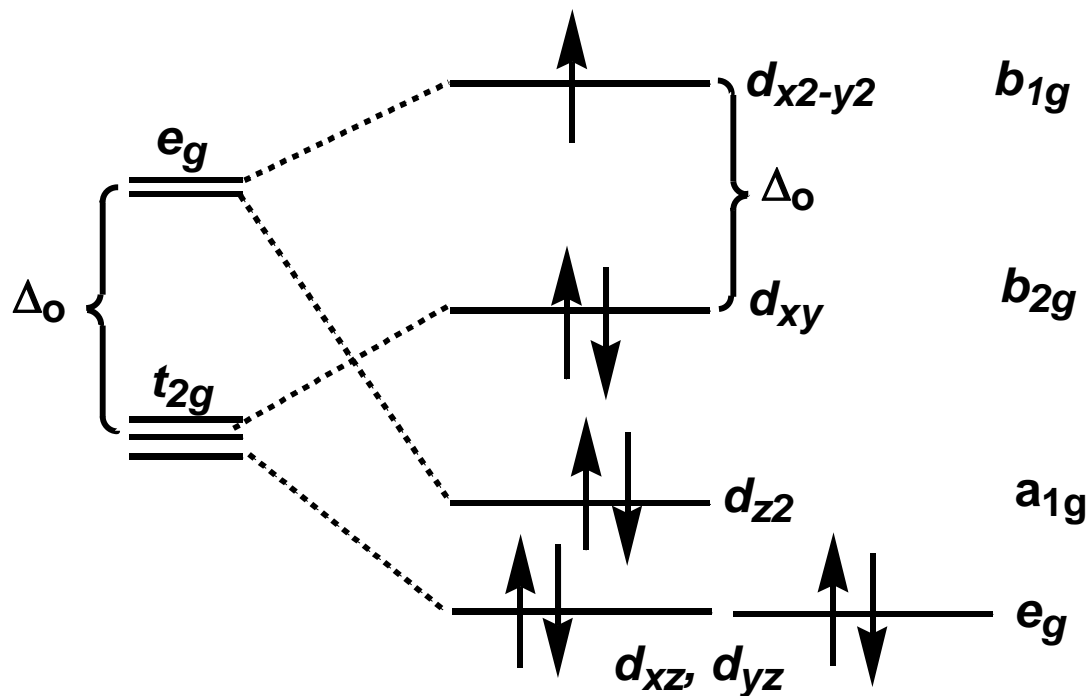

paramagnetico

Sintesi di $[Al(acac)_3]$

Sintesi del complesso

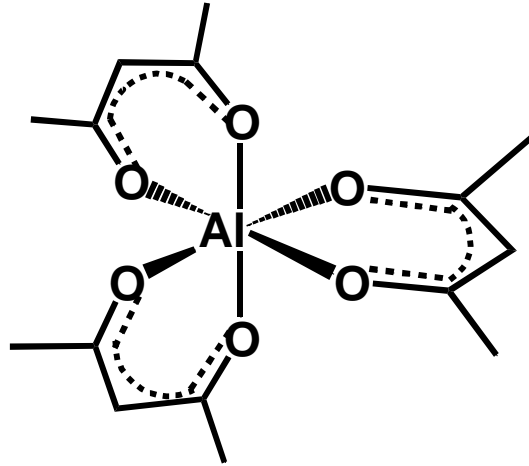

ottaedro, **no elettroni *d***

diamagnetico