



UNIVERSITÀ
DEGLI STUDI DI TRIESTE

Law of torts





UNIVERSITÀ
DEGLI STUDI DI TRIESTE

Che cosa si intende per
responsabilità civile,
o meglio per *law of torts*?



Went in to buy some
tarts, came out with
torts



À

DI DI TRIESTE

Responsabilità Civile



Si tratta di allocare i danni patiti da un
soggetto (danneggiato) a seguito di un
comportamento o di un'attività
riferibile ad un altro soggetto
(danneggiante)

indipendentemente da qualsiasi
rapporto contrattuale eventualmente
intercorso tra i due.





UNIVERSITÀ
DEGLI STUDI DI TRIESTE

Oliver Wendell Holmes - 1871

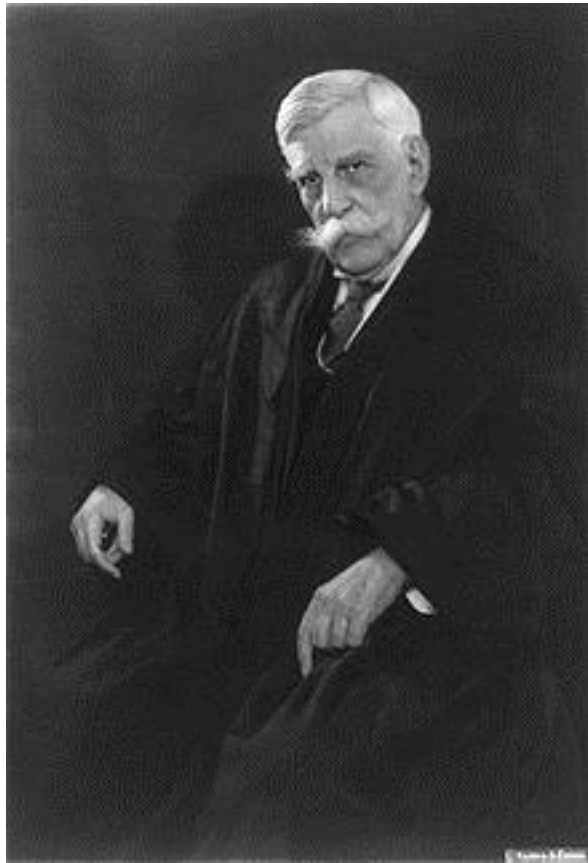

*'torts is not a
proper subject for
a law book'*





Sistemi di *civil law*

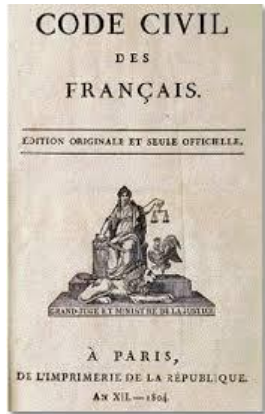

Ci sono clausole (più o meno) generali:

- 1382 Code Napoleon
- § 823, I e II co., e 826 BGB
- 2043 c.c.





Sistemi di *civil law*



Section 823 - Liability in damages

(1) A person who, intentionally or negligently, unlawfully injures the life, body, health, freedom, property or another right of another person is liable to make compensation to the other party for the damage arising from this.

Section 826 - Intentional damage contrary to public policy

A person who, in a manner contrary to public policy, intentionally inflicts damage on another person is liable to the other person to make compensation for the damage



Sistemi di *common law*

È governato da un sistema di rimedi tipici,
che dipendono da:

- tipo di condotta posta in essere dal danneggiante;
- natura dei danni patiti dal danneggiato.





UNIVERSITÀ
DEGLI STUDI DI TRIESTE

Per ogni tipo di
CONDOTTA e di danno esiste uno specifico
tort:

tort of defamation

tort of conversion

trespass to land

action of nuisance





Da dove derivano i *torts*?

Sono frutto della vicende
storiche del sistema di
common law **INGLESE**



writs e forms of action di
epoca medievale





UNIVERSITÀ
DEGLI STUDI DI TRIESTE

Cosa succede con l'eliminazione dei *writs*?

Anche con l'eliminazione dei *writs*, è rimasta assai forte nella *law of torts* la **tipicità** che connotava le *forms of action*.

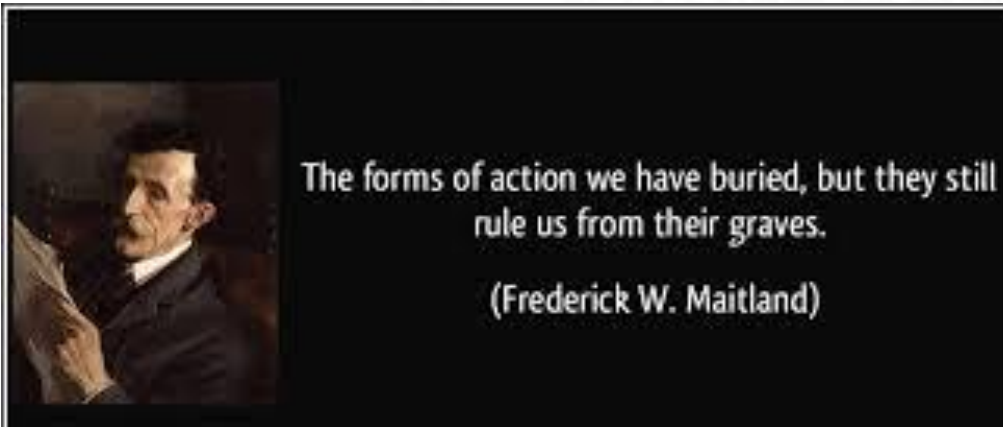



Evoluzione storica

Action of
trespass:

to land

to good

to person





UNIVERSITÀ
DEGLI STUDI DI TRIESTE

writs 'in consimili casu'

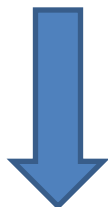

action of trespass on the case

Giudice BLACKSTONE nel caso Scott v. Shepherd (1773), 2 Black. W. 892, 96
Eng. Rep, 525:

"If I throw a log of timber to the highway (which is an unlawful act), and another man tumbles over it, and is hurt, an action on the case only lies, it being a consequential damage; but if in throwing it I hit another man, he may bring trespass because it is immediate wrong".





UNIVERSITÀ
DEGLI STUDI DI TRIESTE

- **intentional interference with persons** (assault; battery; false imprisonment);
- **intentional interference with property** (trespass to land; nuisance; conversion [Moorgate Mercantile Co., Ltd, v. Finch & Read, [1962] 2 Q.B. 701]);
- **intentional interference with economic relationships** (fraud, tort of inducing a breach of contract, passing off, tort of malicious falsehood; tort of conspiracy, intimidation [Rookes v. Barnard, (1964) A.C. 1129])
- **Tort of negligence.**





UNIVERSITÀ
DEGLI STUDI DI TRIESTE

Tort of negligence

1. *duty of care*
2. *Breach of the duty of care*
3. *Damages*
4. *Causation*
5. *inesistenza di cause di giustificazione*





Successo del *tort of negligence*

- si rivelò lo strumento adatto alle esigenze della società neo-industriale;
- possedeva dei connotati processuali che lo rendevano assai più appetibile che le altre azioni.





UNIVERSITÀ
DEGLI STUDI DI TRIESTE

USA v. UK

Responsabilità del produttore
(privity of contract)

• *MacPherson v. Buick Motor Co.*,
217 N.Y. 382, 111
N.E. 1050 (1916)

USA



• *Donoghue v Stevenson* [1932] AC
562

UK





UNIVERSITÀ DEGLI STUDI DI TRIESTE



*MacPherson v. Buick
Motor Co., 217 N.Y. 382,
111 N.E. 1050 (1916)*



«Se la natura di una cosa è tale che è ragionevole ipotizzare che la sua negligente costruzione metterà a repentaglio la vita e l'integrità fisica di terzi, allora la cosa è pericolosa. La natura della cosa avverte il suo produttore delle conseguenze che possono derivarne. Se all'elemento del pericolo si aggiunge la consapevolezza che la cosa verrà usata da persone diverse dall'acquirente e sarà da costoro utilizzata senza nuove prove, allora, ci sia o no un contratto, il produttore di questa cosa pericolosa ha un duty of care di fabbricarla diligentemente»





UNIVERSITÀ
DEGLI STUDI DI TRIESTE

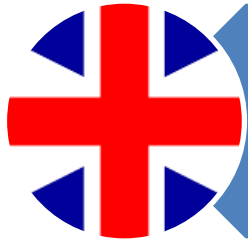

Donoghue v Stevenson
[1932] AC 562

duty of care

quando né il commerciante né i
consumatori hanno avuto – in
concreto – la possibilità di
verificare se le merci sono o no
esenti da vizi





UNIVERSITÀ
DEGLI STUDI DI TRIESTE

tort of negligence

*common
law*



civil law





UNIVERSITÀ
DEGLI STUDI DI TRIESTE

Strict liability



*Rylands v
Fletcher*
[1868] UKHL 1

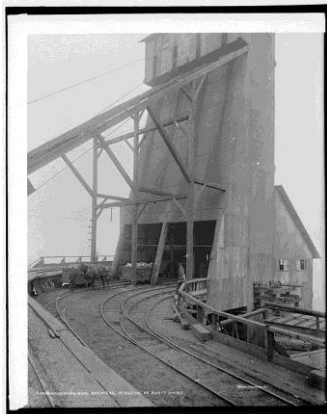

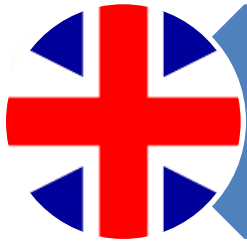

Rylands v Fletcher [1868]

UKHL 1

- Da noi la fattispecie ricadrebbe nelle categorie dei rapporti di vicinato o delle immissioni nocive
- I giudici inglesi non ne hanno fatto largo uso (*Cambridge Water v Eastern Counties Leather* [1994] 2 AC 264 HL: “*It was not reasonably foreseeable that the spillages would result in the closing of the borehole*”)





UNIVERSITÀ
DEGLI STUDI DI TRIESTE

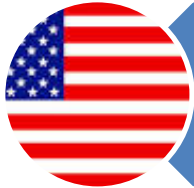

Attività pericolose

Restatement on Torts, 3rd, alla Section §
20:

§ 20. Abnormally Dangerous Activities

An actor who carries on an abnormally dangerous activity is subject to **strict liability** for physical harm resulting from the activity.





UNIVERSITÀ
DEGLI STUDI DI TRIESTE



Product liability

Restatement Third, Products Liability

§ 1 Liability of Commercial Seller or Distributor for Harm Caused by Defective Products

One engaged in the business of selling or otherwise distributing products who sells or distributes a defective product is subject to liability for harm to persons or property caused by the defect.





UNIVERSITÀ
DEGLI STUDI DI TRIESTE

Western Legal Tradition

UNIFORMITA'

diritto operativo

DIVERGENZA

formule, *modus operandi*
e apparato dei concetti
per giungere, o per
giustificare, conclusioni in
larga parte analoghe





Due precisazioni

1. Ruolo dell'*Equity*



2. USA v. UK





EQUITY



- *trespass on the case*
- Rimedi (*specific restitution; injunction*)





UNIVERSITÀ
DEGLI STUDI DI TRIESTE



USA v. UK

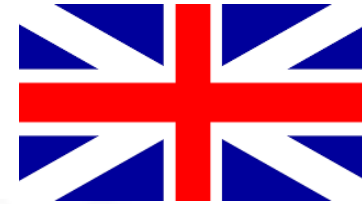

- *standard of care*
- *Duty of care* vs. nesso di causalità
- Responsabilità oggettiva
- *Policy (it is fair, just, and reasonable)*
- Analisi economica del diritto (*United States v. Carroll Towing Co.*, 159 F.2d 169 (2d. Cir. 1947))

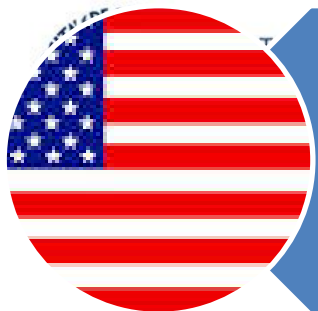

Formula di Hand

standard di diligenza x ,
Investimento in prevenzione x^*
se $x^* > x$ non c'è colpa
se $x^* < x$ c'è colpa

In altre parole, il convenuto è in colpa
se

$$B < L \times p$$

(dove B è the actor's burden, L è il degree of loss per è
la probability of harm)





USA v. UK

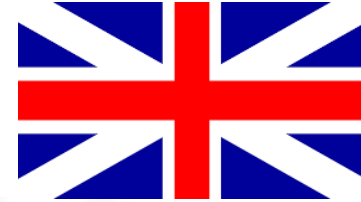

- *standard of care*
- *Duty of care* vs. nesso di causalità
- Responsabilità oggettiva
- *Policy (it is fair, just, and reasonable)*
- Analisi economica del diritto (*United States v. Carroll Towing Co.*, 159 F.2d 169 (2d. Cir. 1947))
- Presenza della giuria
- *Punitive Damages*



UNIVERSITÀ
DEGLI STUDI DI TRIESTE

Tort of negligence

1. *duty of care*
2. *Breach of the duty of care*
3. *Damages*
4. *Causation*
5. *inesistenza di cause di giustificazione*





1. *Duty of care*

- *Donoghue v Stevenson*
- *three stage test*

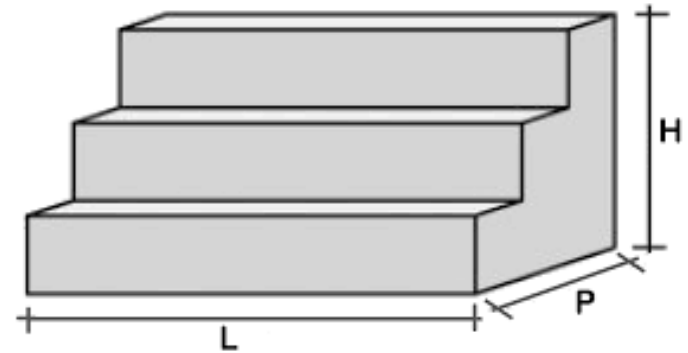



Donoghue v Stevenson
(il c.d. neighbour
principle)

“La regola secondo la quale devi amare chi ti è vicino entra nel diritto come ‘non danneggiare il tuo vicino, e alla domanda del giurista ‘ma chi è il mio vicino’ si può così rispondere: occorre sempre agire con la prudenza necessaria ad evitare azioni od omissioni che potrebbero ragionevolmente essere fonte di danno per chi ci sta vicino. Ma chi è allora il mio vicino? La risposta sembra a questa: tutte le persone che sono così strettamente e direttamente colpite dalle azioni od omissioni cui facevo riferimento prima, tanto che io avrei dovuto prevedere di colpirle, quando ho deciso di realizzare quelle azioni od omissioni”.





three stage test

1. chiedersi se il convenuto avrebbe potuto (e dovuto) **prevedere** il verificarsi di un danno a carico dell'attore;
2. chiedersi se fra attore e convenuto, potesse dirsi sussistente – prima dell'illecito – una **relazione di prossimità sufficientemente stretta** da giustificare l'accollo al secondo del danno subito dal terzo
3. chiedersi se sia **'fair, just and reasonable'** imporre al convenuto un *duty of care* nei confronti dell'attore.

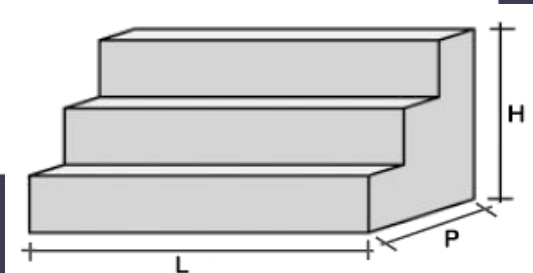



UNIVERSITÀ
DEGLI STUDI DI TRIESTE

1. Foreseeability

Palsgraf v. Long Island R.R. Co., 248 N.Y. 339
(N.Y. 1928)



Download from
Dynamilis.com



Download from
Dynamilis.com



2. *Proximity*

limitazione

```
graph TD; A[limitazione] --- B[danni psichici]; A --- C[pure economic losses]
```

danni psichici

pure economic losses





UNIVERSITÀ
DEGLI STUDI DI TRIESTE

3. Fair, just and reasonable

respingere una domanda, che a rigore di
stretto diritto, andrebbe accolta





UNIVERSITÀ
DEGLI STUDI DI TRIESTE



Palsgraf v. Long Island R.R. Co., 248 N.Y. 339 (N.Y. 1928)

Alcock v Chief Constable of South Yorkshire Police (1992)

Spartan Steel v. Martin (1973)

Hedley Byrne & Co. v. Heller & Partners Ltd (1964)

Caparo Industries Plc v. Dickman (1990)

White v. Jones (1995) (Ross v. Counters (1980))





UNIVERSITÀ
DEGLI STUDI DI TRIESTE



Alcock v Chief Constable of South Yorkshire Police [1992] 1 AC
310





UNIVERSITÀ
DEGLI STUDI DI TRIESTE



*Spartan Steel & Alloys Ltd v Martin &
Co (Contractors) Ltd [1973] 1 QB 27*



TERGES
TVM



UNIVERSITÀ
DEGLI STUDI DI TRIESTE



*Hedley Byrne & Co Ltd v Heller
& Partners Ltd* [1964] AC 465

National Provincial
(bank)



Heller & Partners
(bank)



Hedley Byrne



Easipower





UNIVERSITÀ
DEGLI STUDI DI TRIESTE



Caparo Industries plc v Dickman
[1990] UKHL 2

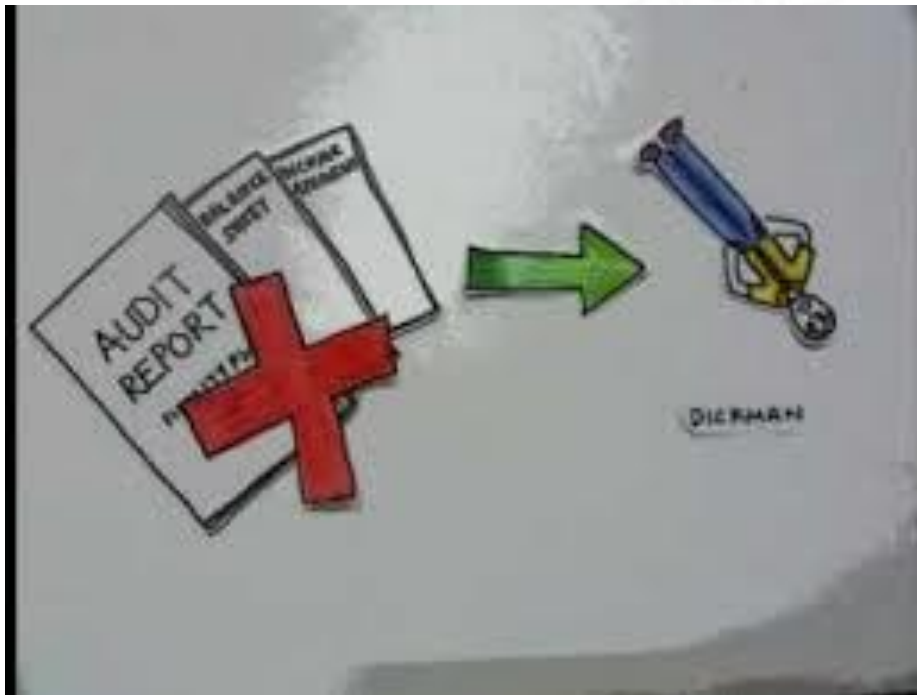



UNIVERSITÀ
DEGLI STUDI DI TRIESTE



White v Jones [1995] UKHL 5





UNIVERSITÀ
DEGLI STUDI DI TRIESTE

2. Violazione del *duty of care*

reasonable man
(*bonus pater familias*)

Paterfamilias





Come si valuta?

- Le Corti si dimostrano spesso assai sensibili nel tarare i caratteri di quel modello
- *Nettleship v. Weston* (1971)





3. Damages

non sono molto distanti
da quelli propri ai
sistemi *civilian*

*physical
damages*

*psychiatric
injury*

*pure economic
losses*





4. *Causation*

test bifasico

- 1) stabilire se la condotta del convenuto ha contribuito alla produzione del danno a carico dell'attore (*legal cause*);
- 2) valutare se quella condotta, pacificamente incidente sull'evento finale, possa però dirsi la causa sostanziale dell'evento dannoso (*proximate cause*).



UNIVERSITÀ
DEGLI STUDI DI TRIESTE

but for test

In assenza della condotta inappropriata del convenuto, il danno si sarebbe verificato comunque?

(conditio sine qua non)



non è sufficiente





Proximate cause

too remote

*indirect
consequences*

Mancanza della
foreseeability





Risultati divergenti

- *Re Polemis & Furness Withy & Company Ltd.*

[1921] 3 KB 560

- «*The Wagon Mound*» (Overseas Tankship (UK) Ltd v Morts Dock & Engineering Co Ltd [1961] AC 388).





5. 'Fattore negativo' del *tort of negligence*

elemento che in genere viene portato in giudizio dal danneggiante, a propria difesa, e che tende ad ottenere l'esclusione della responsabilità





CABLE CASES

ITALIA

Pasta Puddu

(primo grado e appello: Giur. it, 1970, I, 2, p. 644; Cassazione: Cass. 24 giugno 1972, n. 2135, in *Giur. it.*, 1972, I, 1, p. 1124 e in *Foro it.*, 1973, I, p. 99)

La Corte di Appello di Cagliari condanna l'impresa che aveva cagionato l'interruzione dell'energia.

(Sentenza confermata in Cassazione)

De Chirico

GERMANIA

La domanda viene accolta in primo e secondo grado ma annullata dal BGH (Bundesgerichtshof).

Il par. 823 BGB prevede la protezione di specifiche situazioni giuridiche protette: vita, integrità fisica, libertà, proprietà.

La domanda risarcitoria viene respinta dal BGH





UNIVERSITÀ
DEGLI STUDI DI TRIESTE

CABLE CASES

INGHILTERRA

Spartan Steel and Alloys v. Martin & Co. (C.A. [1972] 3All. E.R. 557)

Corte d'Appello: riconosce parzialmente il diritto al risarcimento della fonderia, limitandolo al solo danno derivante alla colata in corso di lavorazione e non ultimata, e negandolo invece per il lucro cessante da mancata attività.

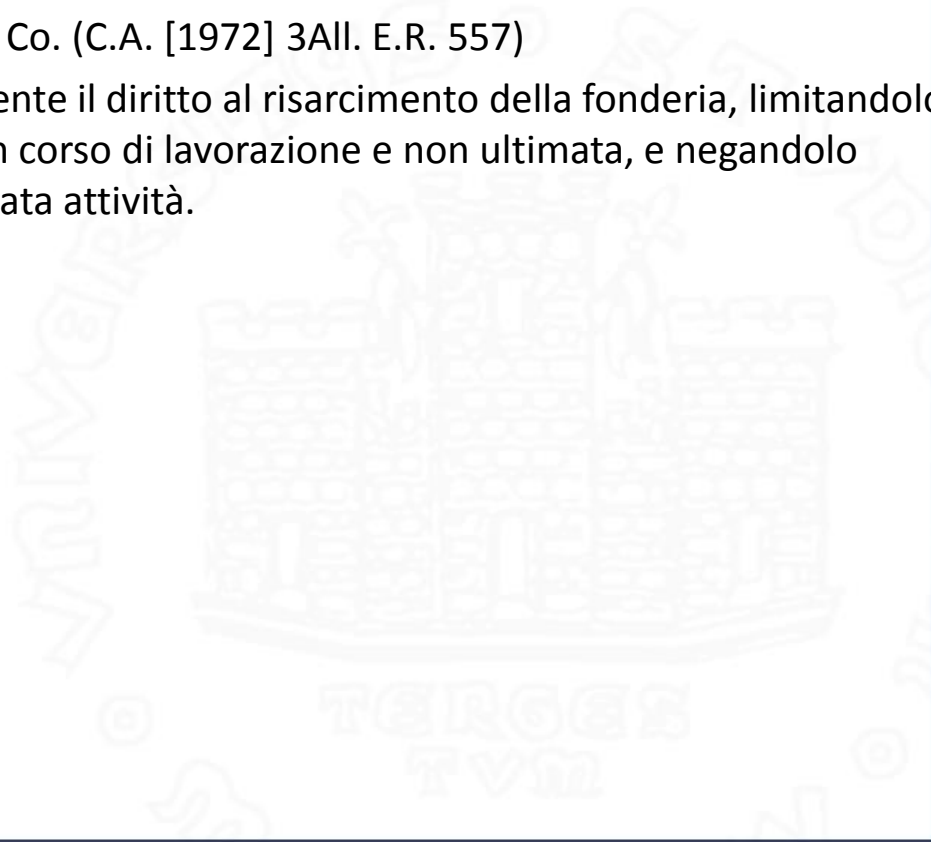



Il danno da informazioni inesatte

ITALIA

Tribunale di Bologna (17 ottobre 1952, Soc. Esi c. Canè e Berzioli, in Foro it, 1953, I, 422)

Corte d'Appello (16 gennaio 1954, in Foro pad., 1954,1,273)

GERMANIA

Bundesgerichtshof , 2 novembre 1983 (in NJW, 1984, 355)

INGHILTERRA

Hedley Byrne v. Heller & Partners [1964] (AC 465)

Lord Devlin: *There is no duty to be careful in speech as there is a duty to be honest in speech. Nor indeed is there any general duty to be careful in action. The duty is limited to those who can establish some relationship of proximity such as was found to exist in Donoghue v. Stevenson. A plaintiff cannot therefore recover for financial loss caused by a careless statement unless he can show that the maker of the statement was under a special duty to him to be careful.*



Debitore ferito o ucciso

- Cass. 4 luglio 1953, n. 2085 (in Foro it., 1953, 1,1086) - Associazione Calcio Torino
- Cass. 26 gennaio 1971, n. 174, in Foro it., 1971, I, 342) - «caso Meroni»
- Cour d'Appel di Colmar (20 aprile 1955, Football Club Metz c. Wiroth, in D., 1955,723)
- Mankin v. Scala Theodrome Co. [1954] (1 K.B. 257) / Inland Revenue Commissioners V. Hambrood (C.A. [1956] 2 Q.B. 641)



La perdita di una «chance»

- Corte di Cassazione nel «caso Melis» (Cass. Pen. 7 gennaio 1983)
- Gardner V. National Bulk Carrier (310 F.2d 284) (4th Cir., 1962)
- App. Grenoble 24 ottobre 1962
- **Gregg v. Scott [2005]** non potendo il paziente che ha iniziato la terapia in ritardo per via di un errore medico dimostrare che egli sarebbe guarito, o che comunque il danno lamentato sarebbe stato evitato da una tempestiva diagnosi, la sua domanda dovesse essere respinta

