

SFERONIZZAZIONE

miscelazione

$t_{90/95}$

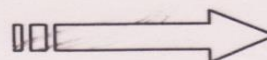
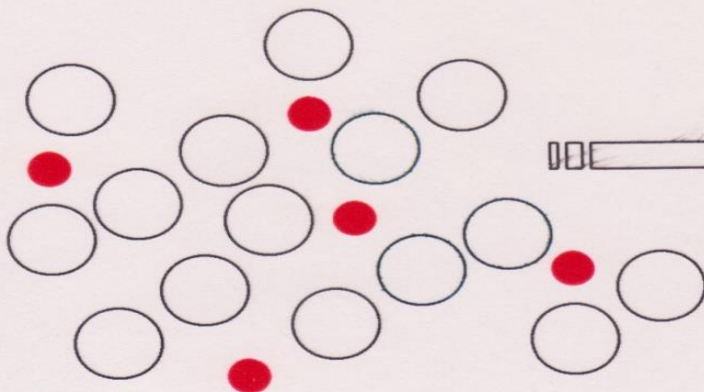
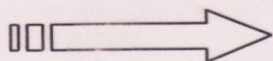

- incapsulamento e/o compressione diretta
- polveri come forma farmaceutica

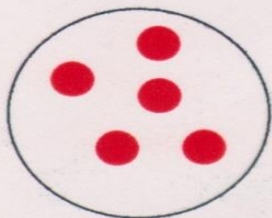

sferonizzato
pellets

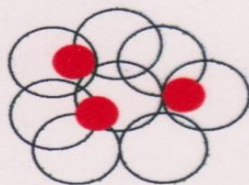

granulo



estruso



MISCELAZIONE

Pellets (Beads, Spheroids)

- ❑ Piccole unità solide scorrevoli
- ❑ Forma sferica o pseudosferica
- ❑ Dimensioni tra 500-2000 μm
- ❑ Impiego: forme farmaceutiche orali a rilascio modificato

Capsule di gelatina dura



Compresse disgreganti



PERCHÈ I PELLETS?

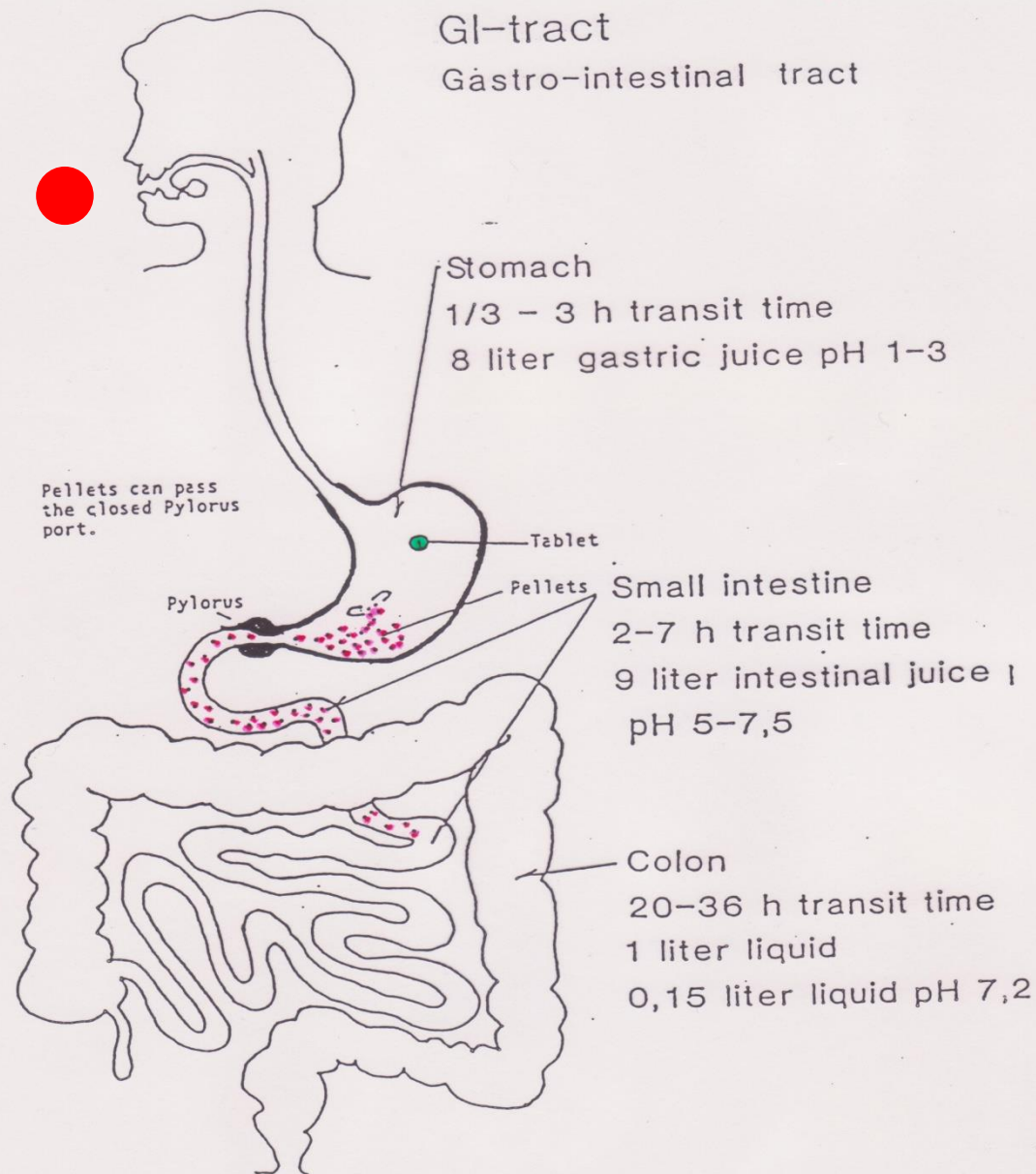

Performance biofarmaceutica

- ❑ **Maggior riproducibilità del profilo di assorbimento**



Stomaco vuoto ogni due ore

Possono passare attraverso il piloro indipendentemente dalla fase di digestione in atto

Riduce i rischi di:

- **Dose dumping (liberazione istantanea della dose)**
- **Danni locali a carico della mucosa gastrica**

TIPI DI PELLETS?

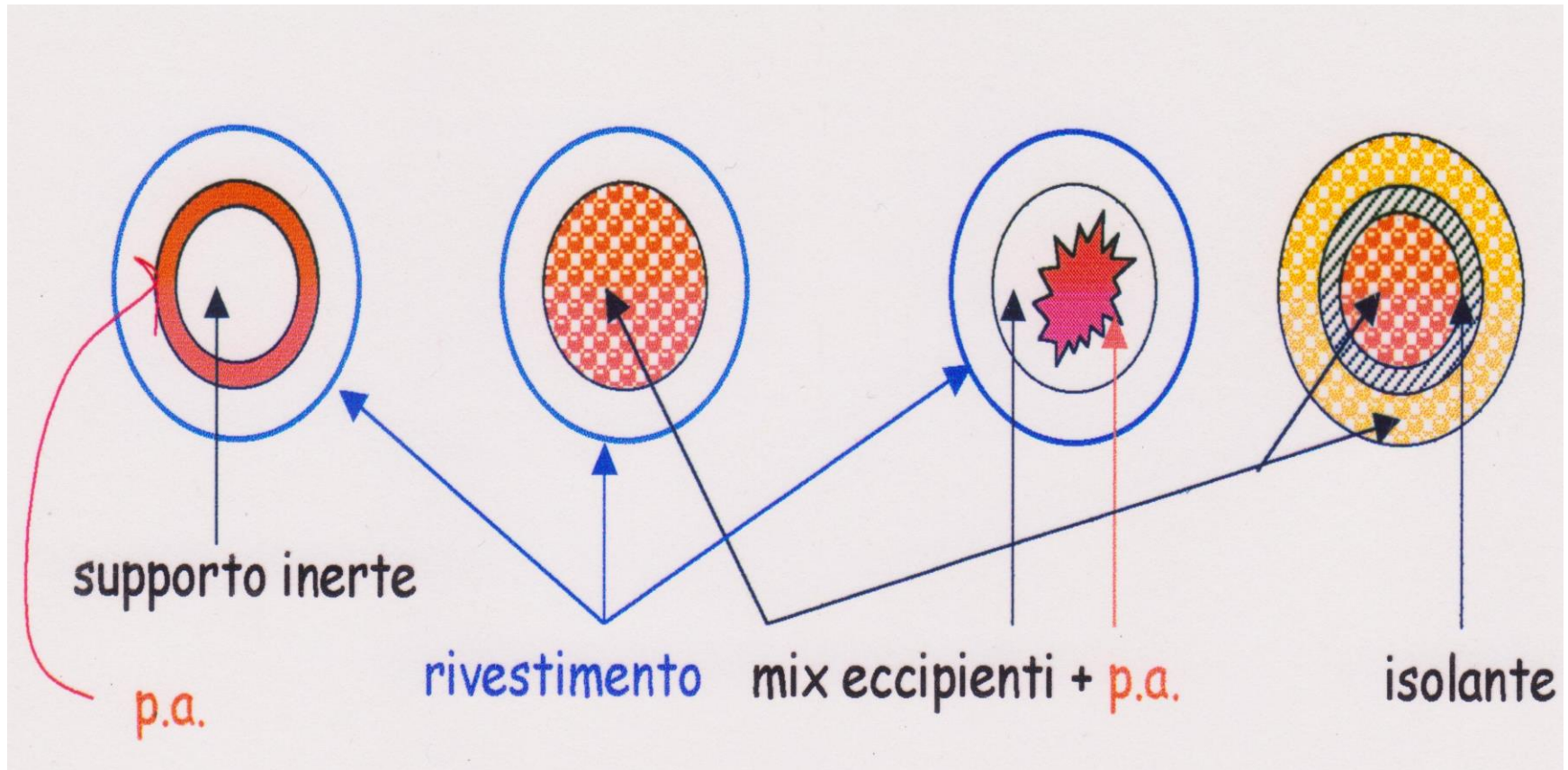

500µm-2/3 mm

TECNICHE DI PELLETTIZZAZIONE (MECCANISMO DI INGROSSAMENTO)

1. GLOBULAZIONE

```
graph LR; A[1. GLOBULAZIONE] --- B[ ]; B --- C[SPRAY-DRYING]; B --- D[SPRAY-CONGEALING];
```

**SPRAY-
DRYING**

**SPRAY-
CONGEALING**

2. AGGLOMERAZIONE

COMPATTAZIONE

COMPRESSIONE

ESTRUSIONE/
SFERONIZZAZIONE

AGITAZIONE

PALLOTTIZZAZIONE

GRANULAZIONE

ROTOGRANULATORE A
LETTO FLUIDO

GRANULATORI
RAPIDI

3. STRATIFICAZIONE SU NUCLEI PREFORMATI

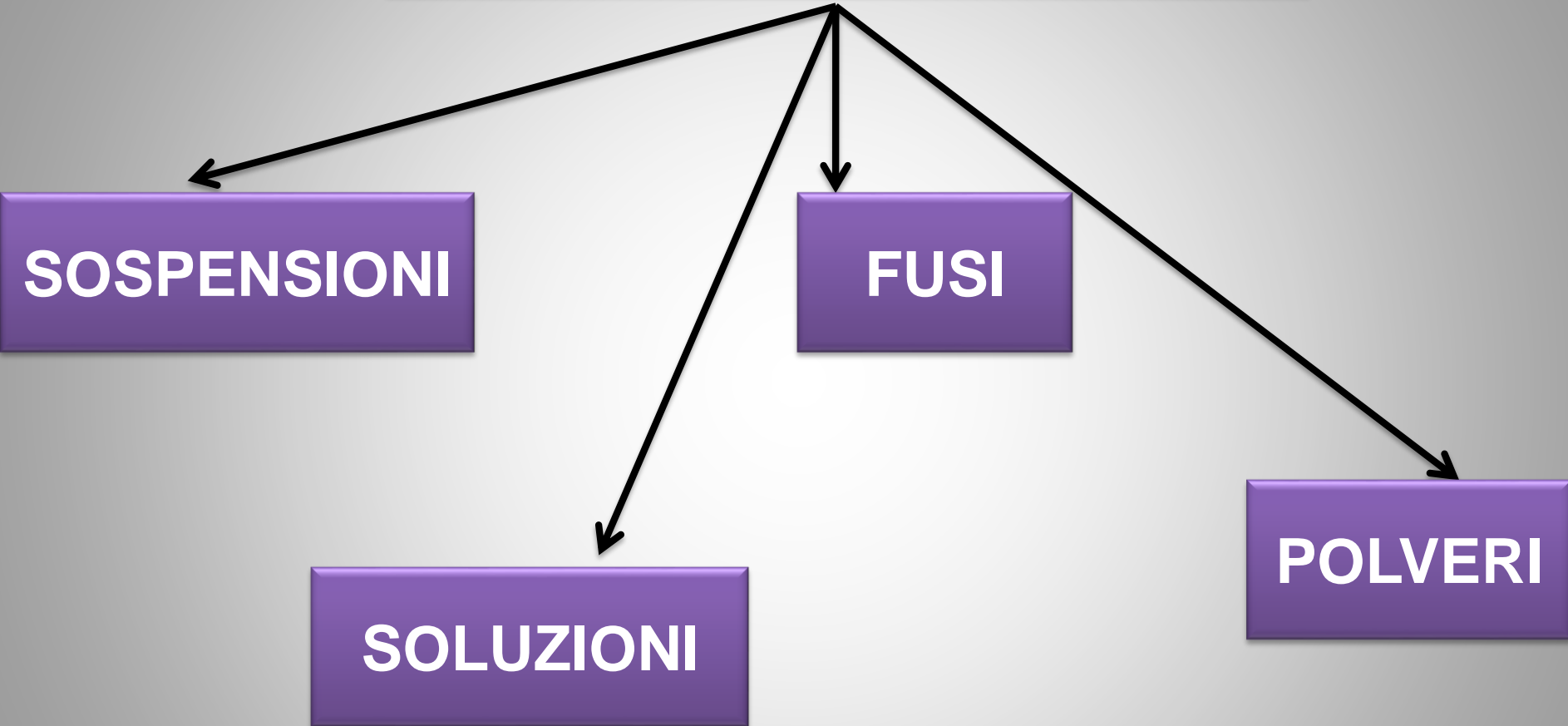

2. AGGLOMERAZIONE/COMPATTAZIONE (COMPRESSIONE)

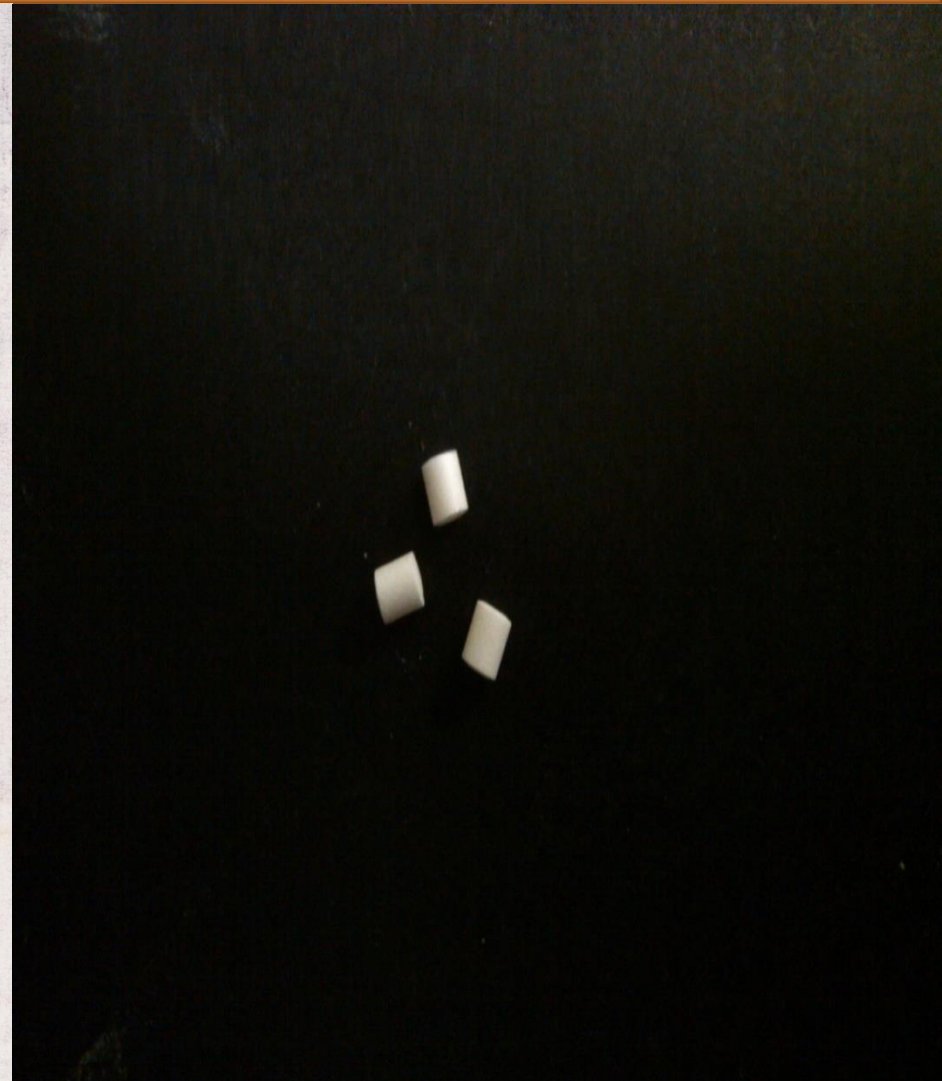
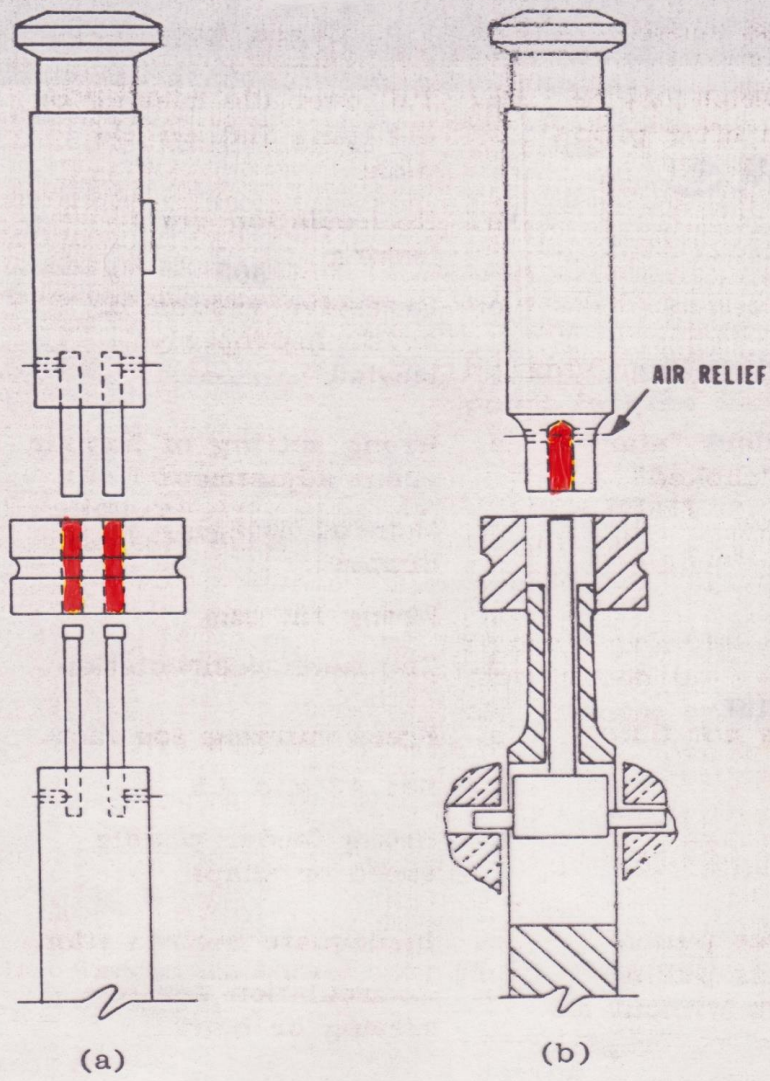

Compressione

- ❑ **Materiali:** - p. attivo
 - eccipienti per compressione
- ❑ **Apparecchiature:** - comprimetrici con più punzoni concavi (2-2,5 mm)
- ❑ **Aspetti favorevoli:** - tecnica consolidata
 - senza impiego di liquidi
 - riproducibilità
- ❑ **Aspetti critici:** - carico di p. attivo
 - polveri con caratteristiche di scorrevolezza e compattazione ottimale
 - velocità di produzione
 - usura punzoni

2.AGGLOMERAZIONE/COMPATTAZIONE/ ESTRUSIONE-SFERONIZZAZIONE

**CONSISTE IN 4 E/O 5 FASI (GRANULAZIONE,
ESTRUSIONE, SFERONIZZAZIONE, ESSICCAMENTO
E RIVESTIMENTO)**

SI POSSONO OTTENERE PELLETS AD ALTA DENSITÀ

CAMPANA STRETTA

SUPERFICIE LISCIA

CONTENUTO P.A. ANCHE SUPERIORE AL 90%

PROCESSO VELOCE (DIVERSI MACCHINARI)

GRANULAZIONE

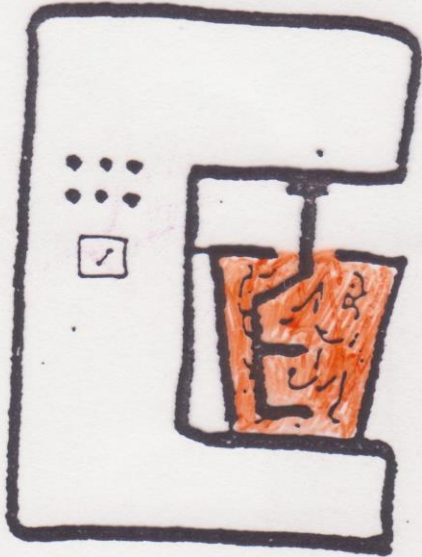

ESTRUSIONE

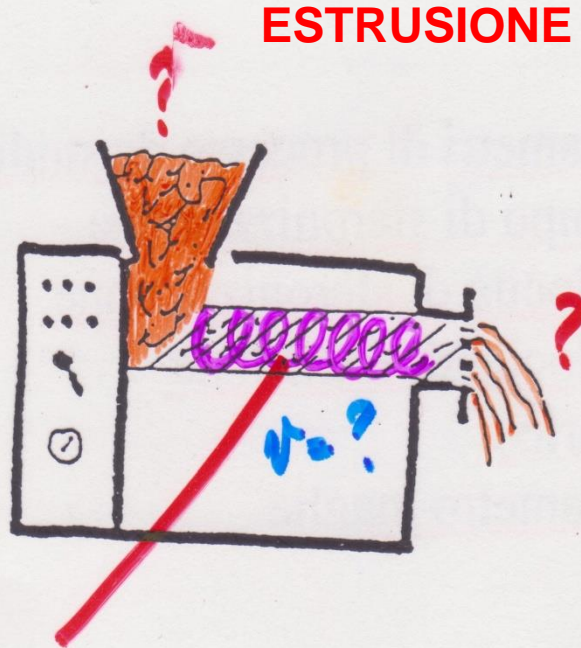

SFERONIZZAZIONE

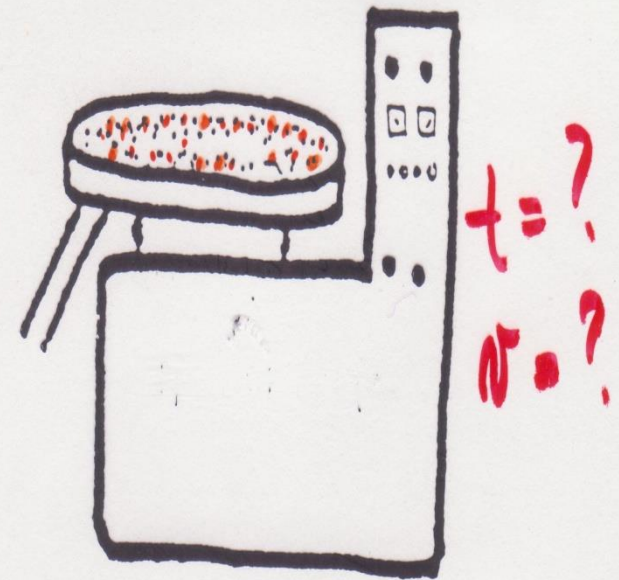

ESSICCAMENTO

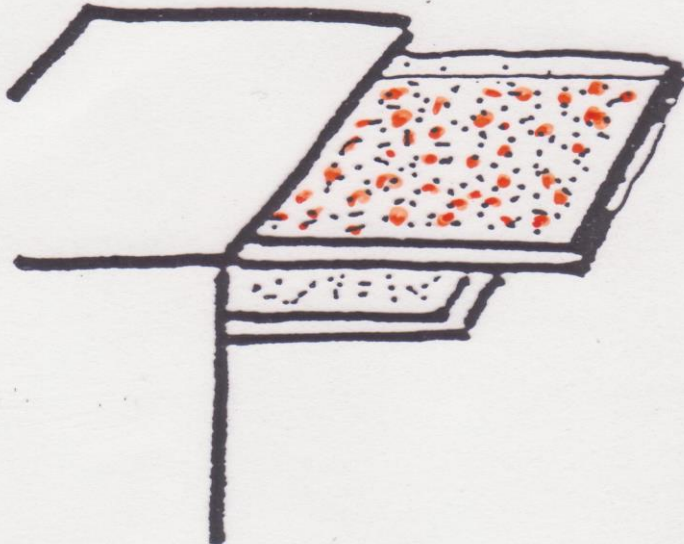

RIVESTIMENTO



CLASSIFICAZIONE DEGLI ESTRUSORI A SECONDA DELLA MODALITÀ DEL TRASPORTO DEL MATERIALE:

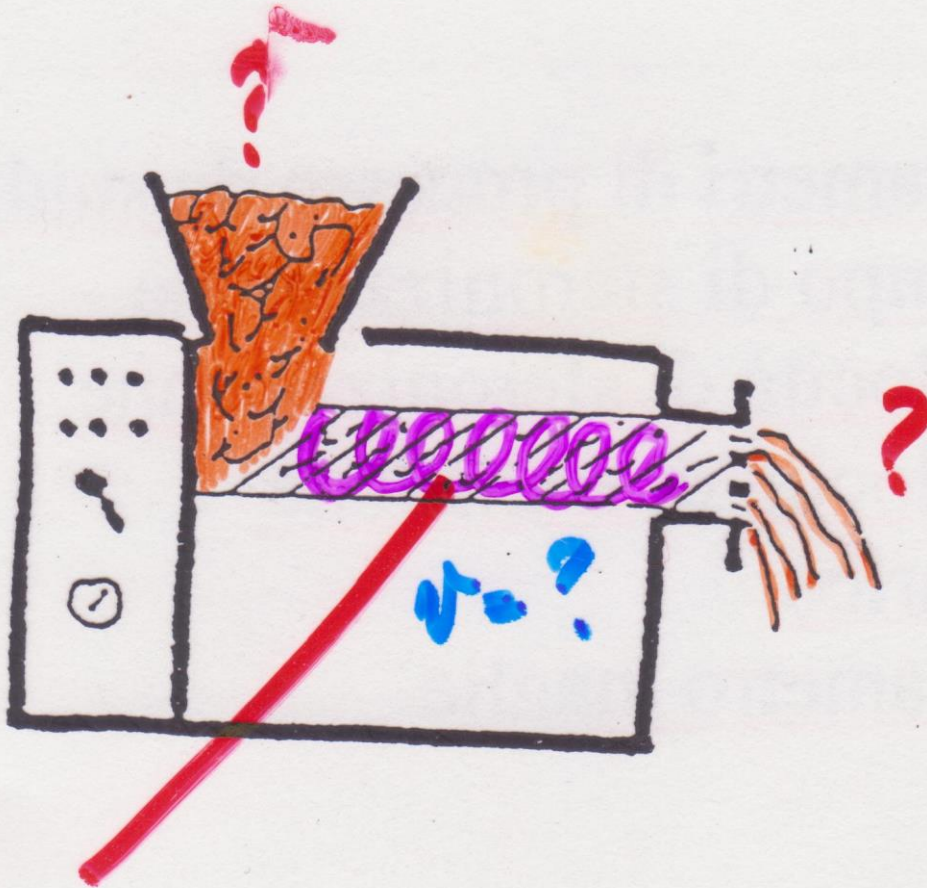

**1. ESTRUSORE A
PISTONE**

**2. ESTRUSORE A
VITE**

**3. ESTRUSORE
GRAVIMETRICO**

1. ESTRUSORE A PISTONE

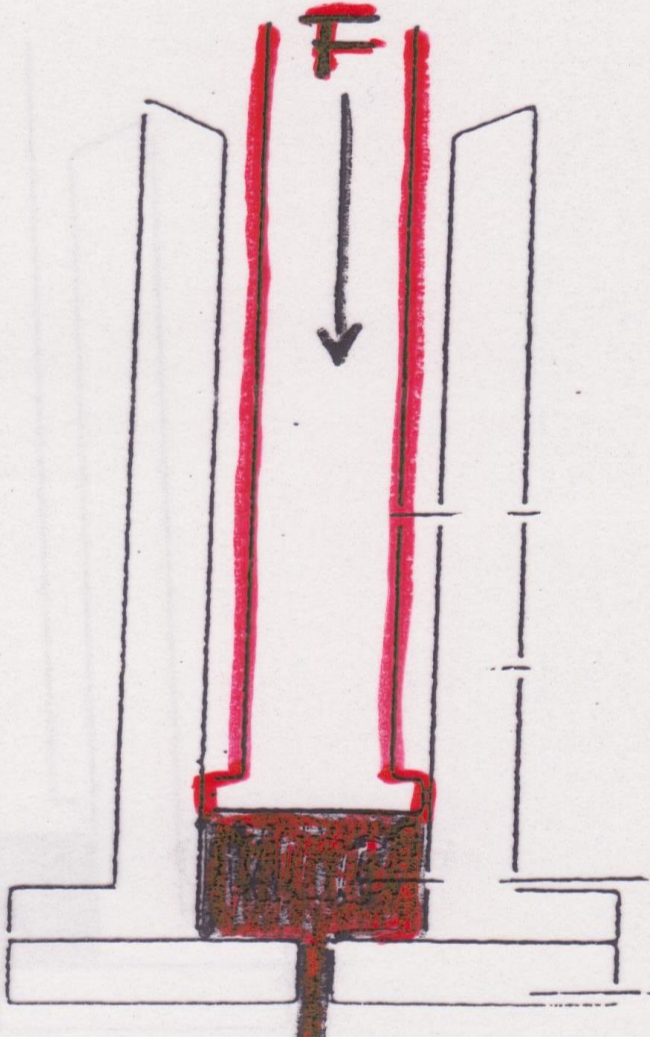

UTILIZZA UN
PISTONE PER
FORZARE IL
MATERIALE
ATTRAVERSO IL
FORO
D'ESTRUSIONE

LLOYD
INSTRUMENTS

LR 50K



RELAZIONE FORZA-SPOSTAMENTO

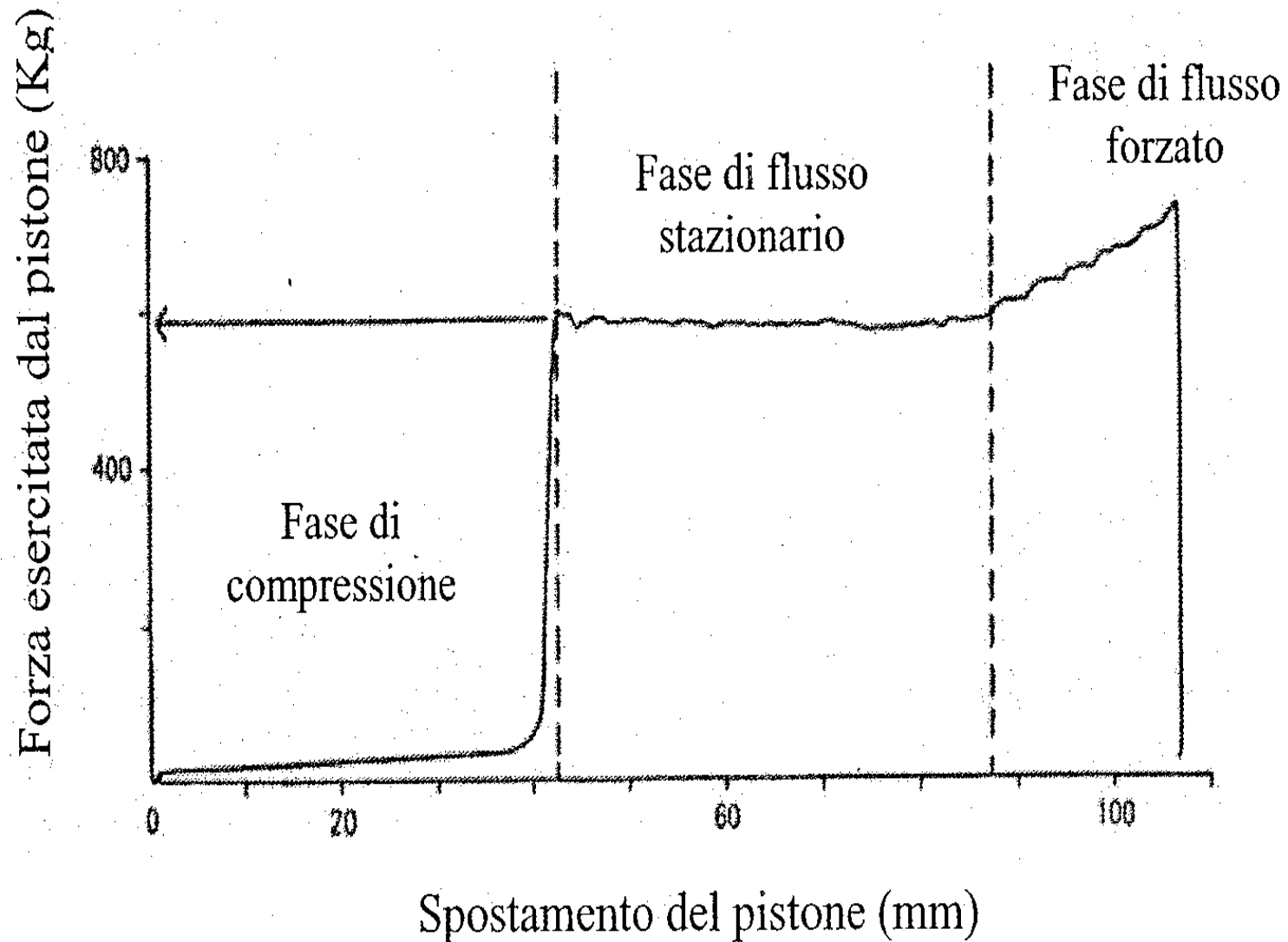

Profili d'estrusione

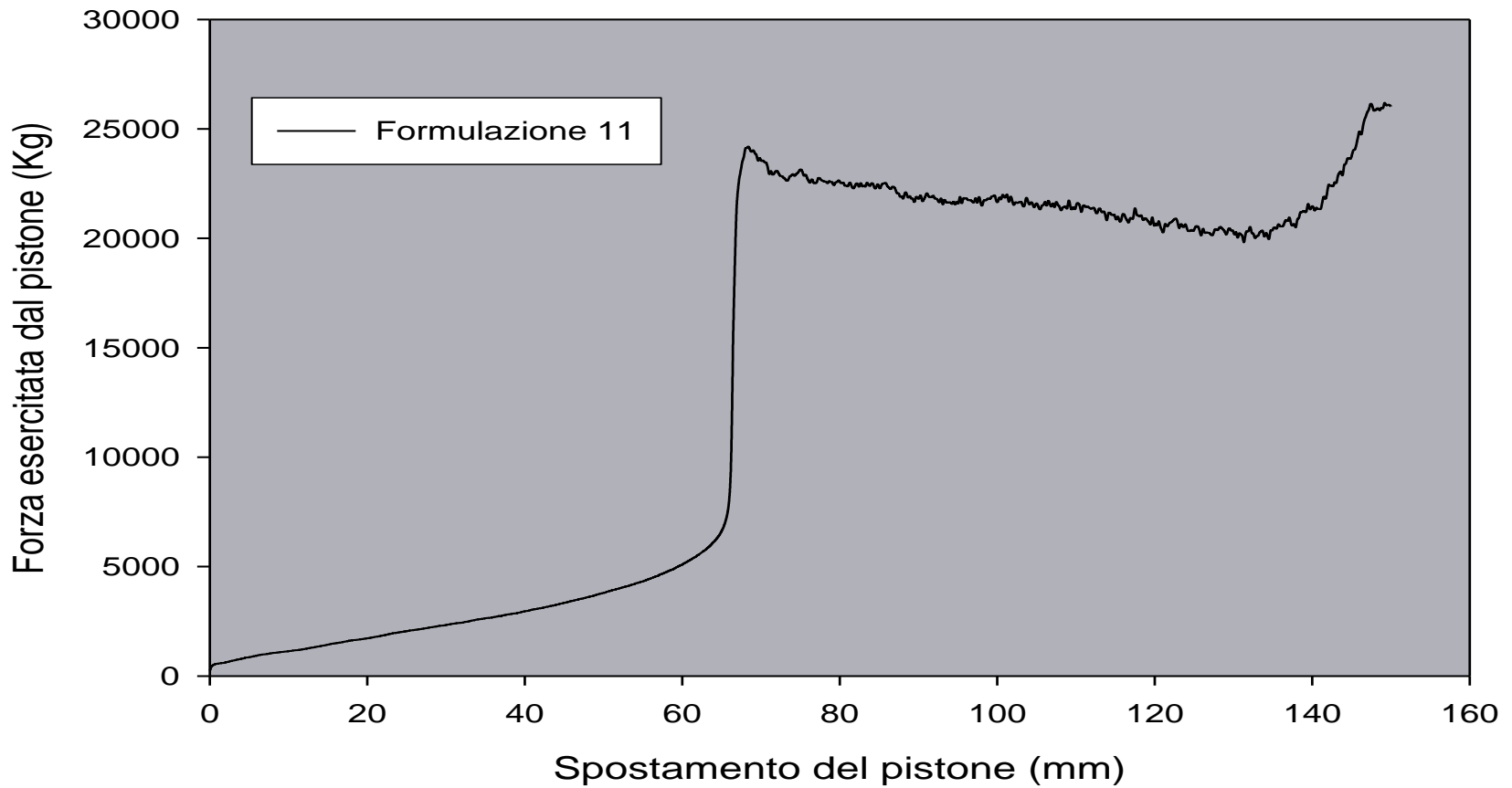

Profili d'estrusione

(Bagnatura insufficiente/massa non estrude)

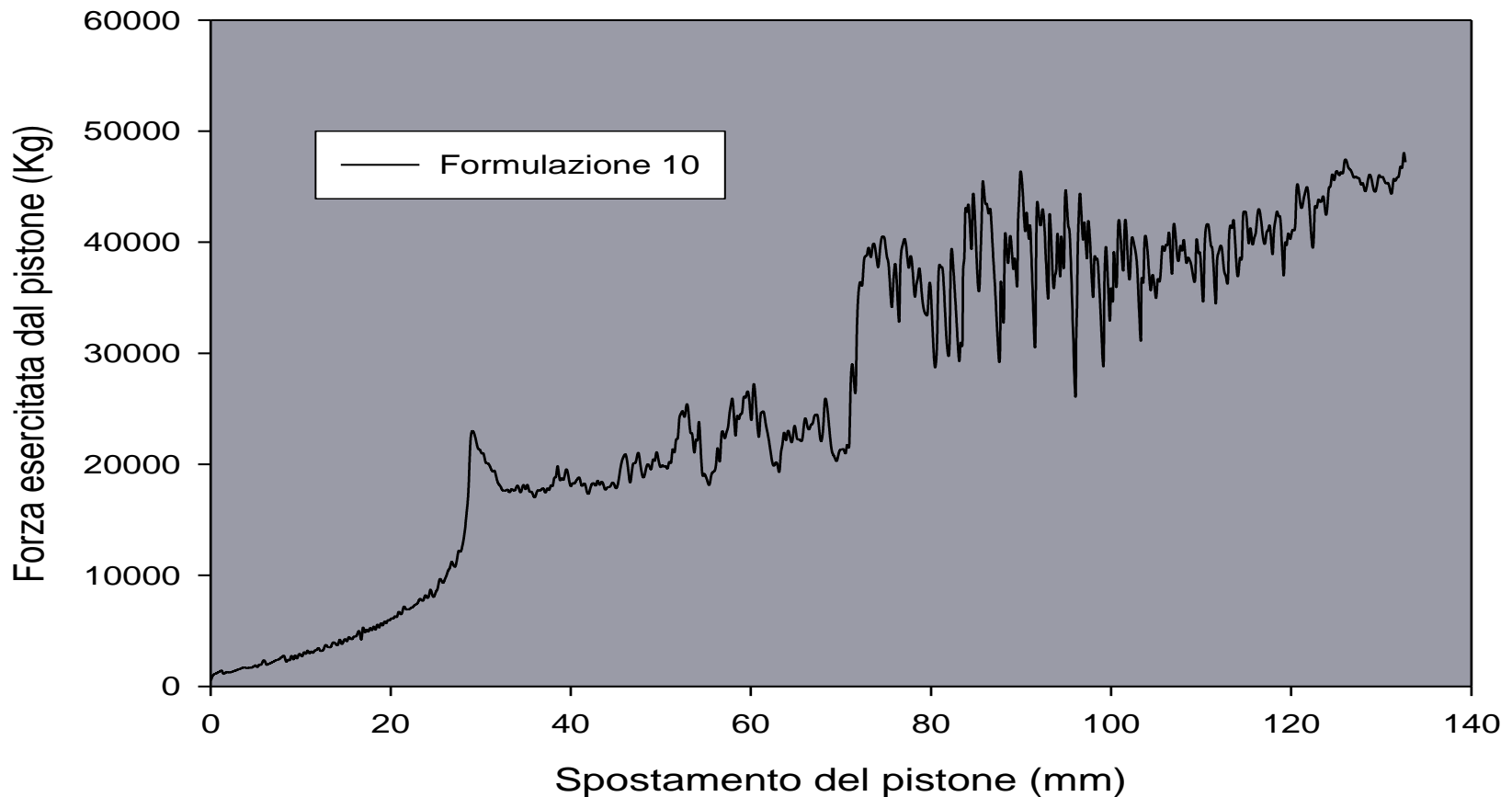

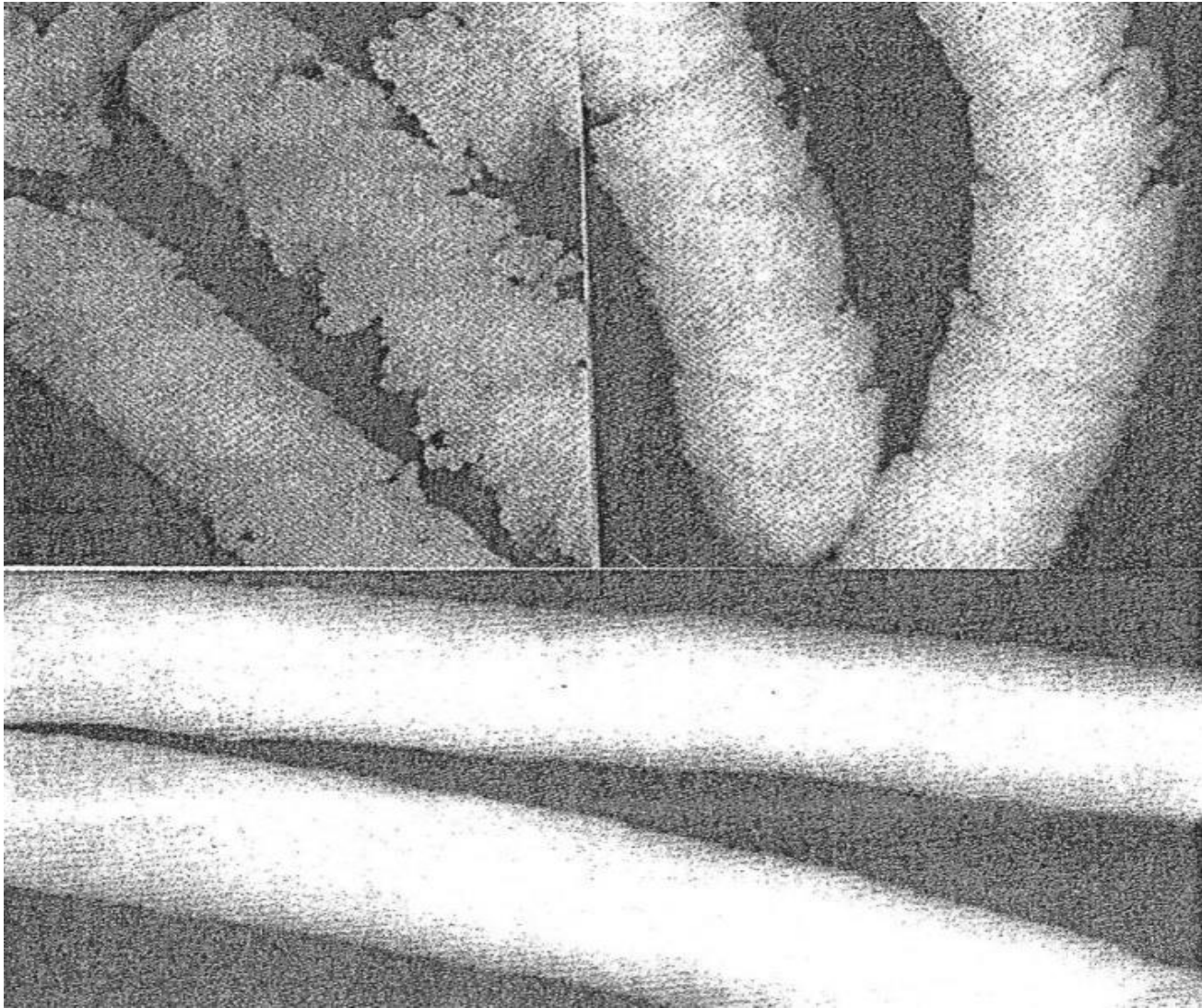

2. ESTRUSORE A VITE

UTILIZZA UNA O PIU VITI PER IL TRASPORTO E PER SVILUPPARE LA PRESSIONE PER SFORZARLO

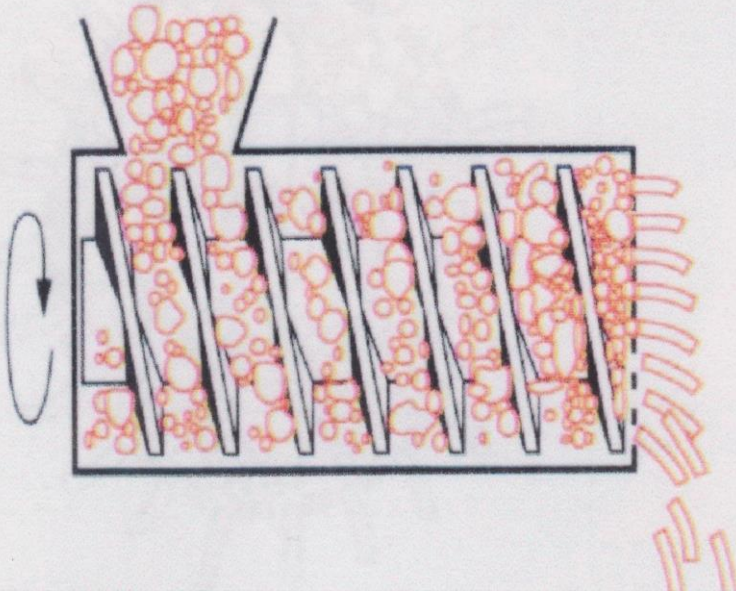

ESTRUSIONE ASSIALE SEGUE LA
STESSA DIREZIONE DEL TRASPORTO

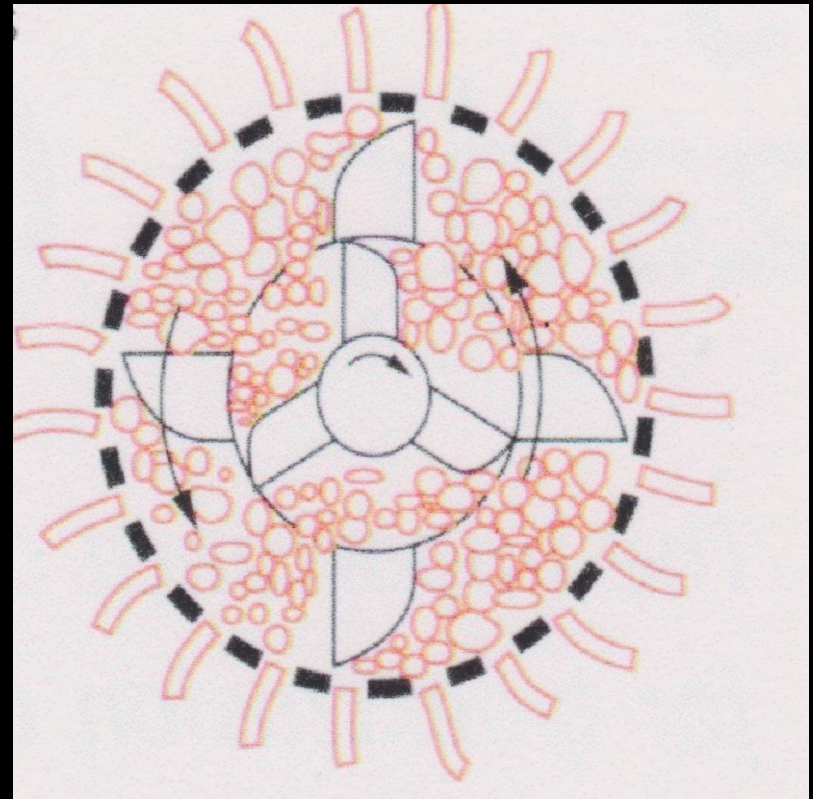

ESTRUSIONE RADIALE- ESTRUSO LUNGO
LE PARETI DELLA CAMERA



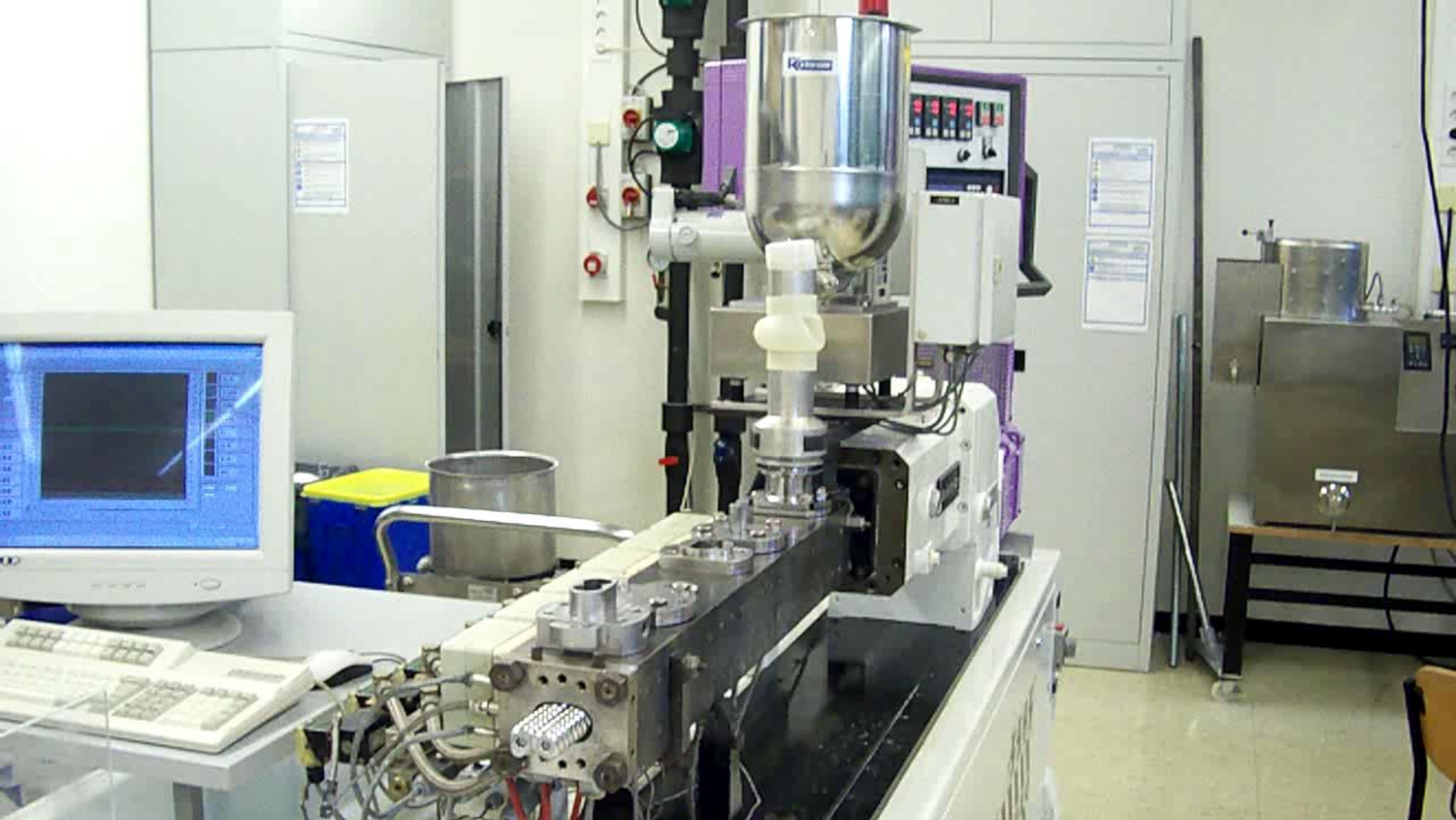





3. ESTRUSORE GRAVIMETRICO

IL MATERIALE VIENE TRASPORTATO DALLA FORZA DI GRAVITA VERSO DUE CILINDRI O INGRANAGGI CONTROROTANTI

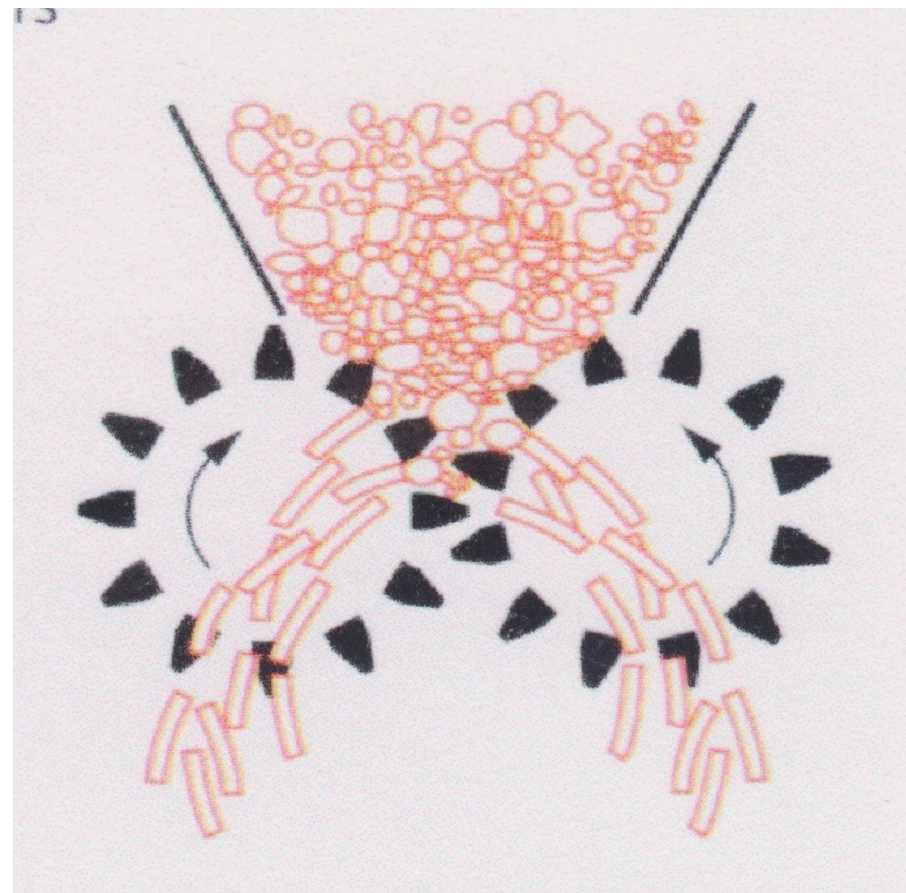
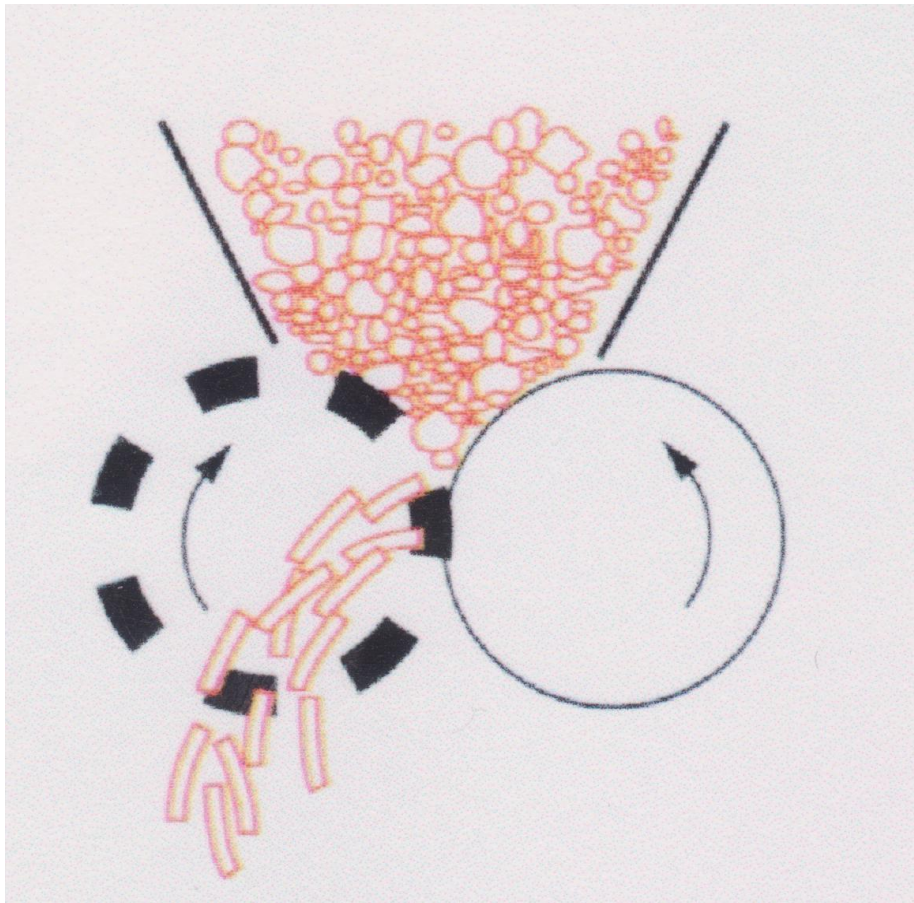

SFERONIZZATORE (DISCO ROTANTE)

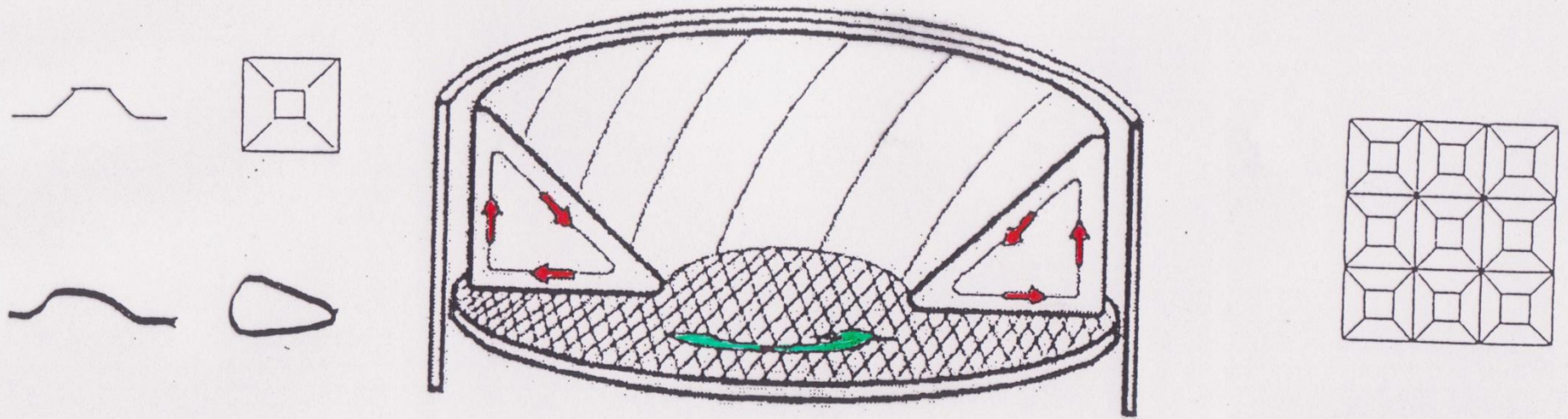

er

1491.0

FERN- BETRIEB OK

DISPLAY STATUS DUCK MENU MENU

CHARGE DATA CANCEL OK

← + →

↓ -

ALARM WARNING ON

STOP/RESET JOG FWD/REV START

8585

⏪ ⏩

Runder Überspannung EIN

START Überspannung

STOP

PARAMETRI SFERONIZZAZIONE

VELOCITA'

velocità
finale

velocità
iniziale

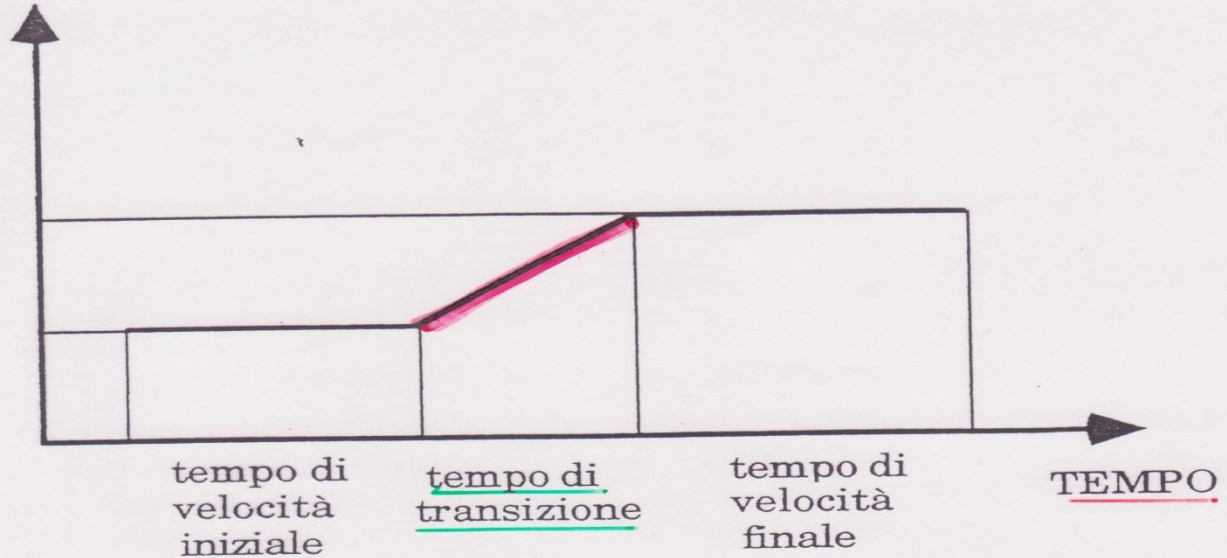

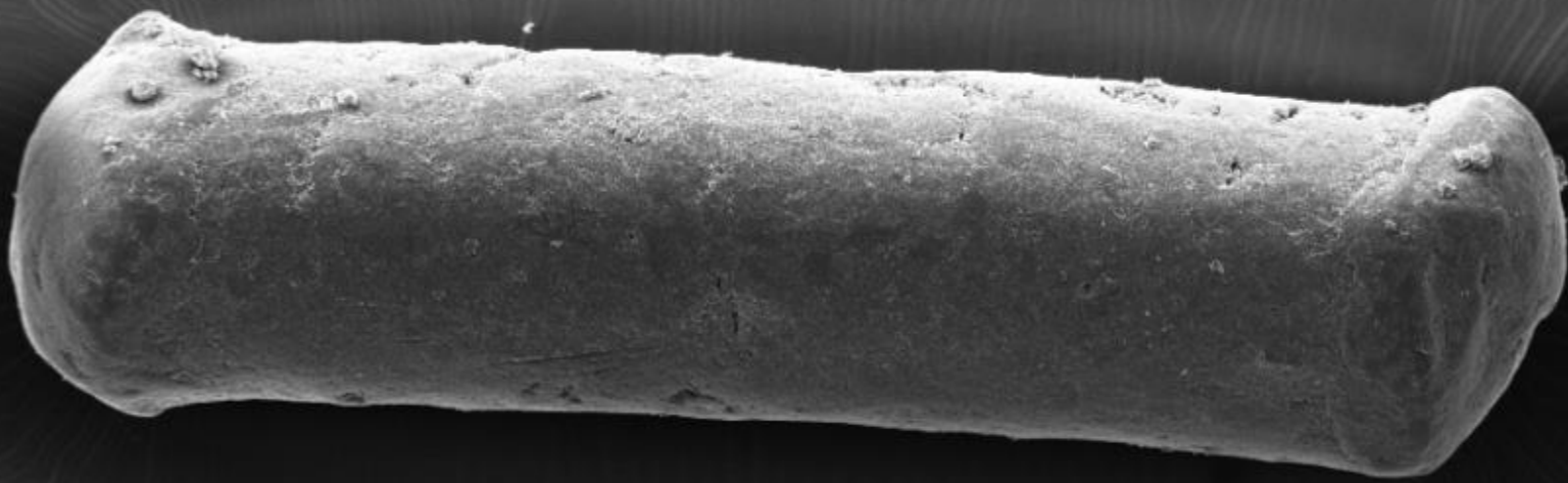

EHT=15.00 kV
200µm 

WD= 33 mm

Photo No.=8095

Mag= 75 X

Detector= SE1

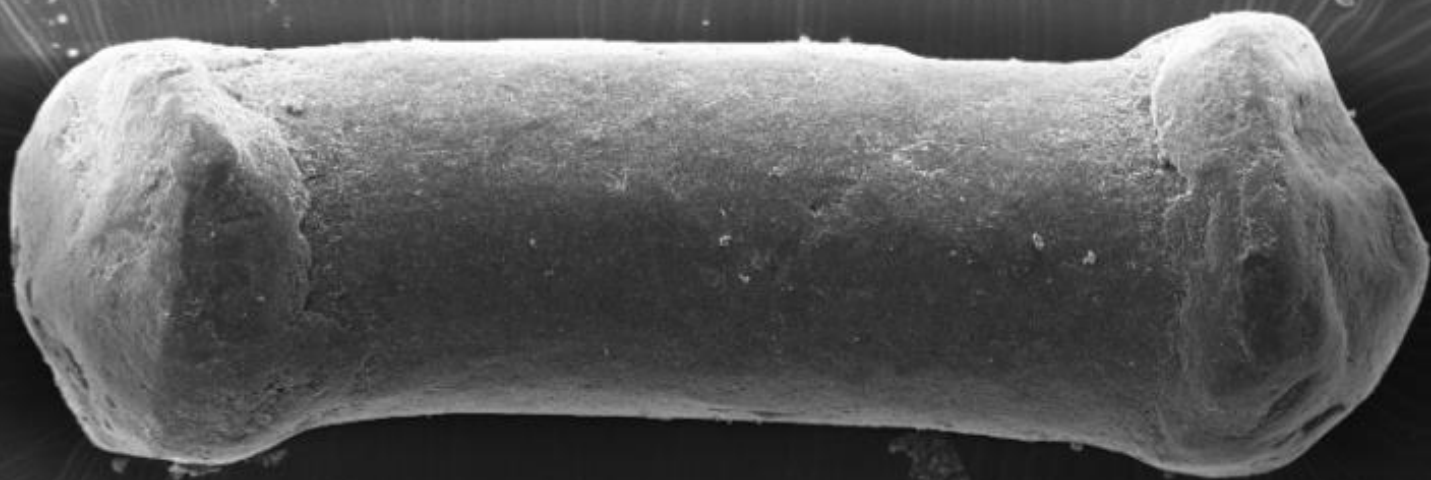

EHT=15.00 kV
200µm 

WD= 33 mm

Photo No.=8096

Mag= 75 X

Detector= SE1

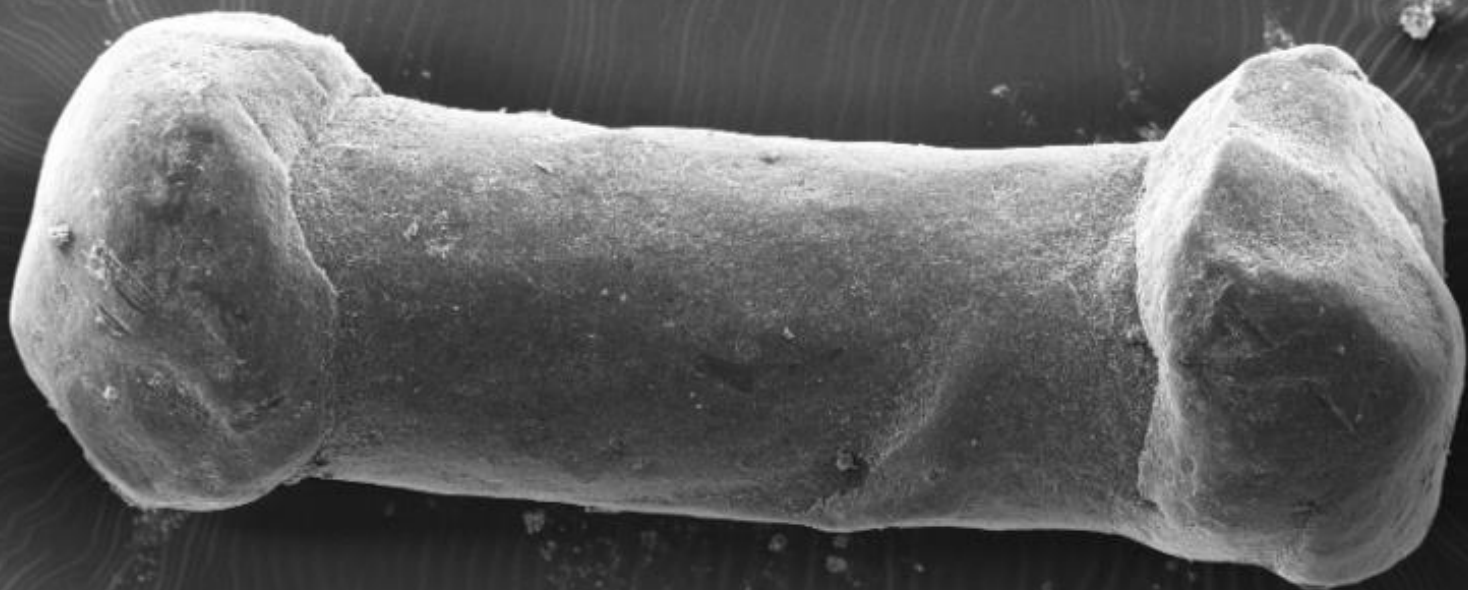

EHT=15.00 kV
200µm 

WD= 33 mm

Photo No.=8097

Mag= 75 X

Detector= SE1



EHT=15.00 kV
200µm 

WD= 33 mm

Photo No.=8098

Mag= 75 X

Detector= SE1



EHT=15.00 kV
200µm 

WD= 33 mm

Photo No.=8099

Mag= 75 X

Detector= SE1

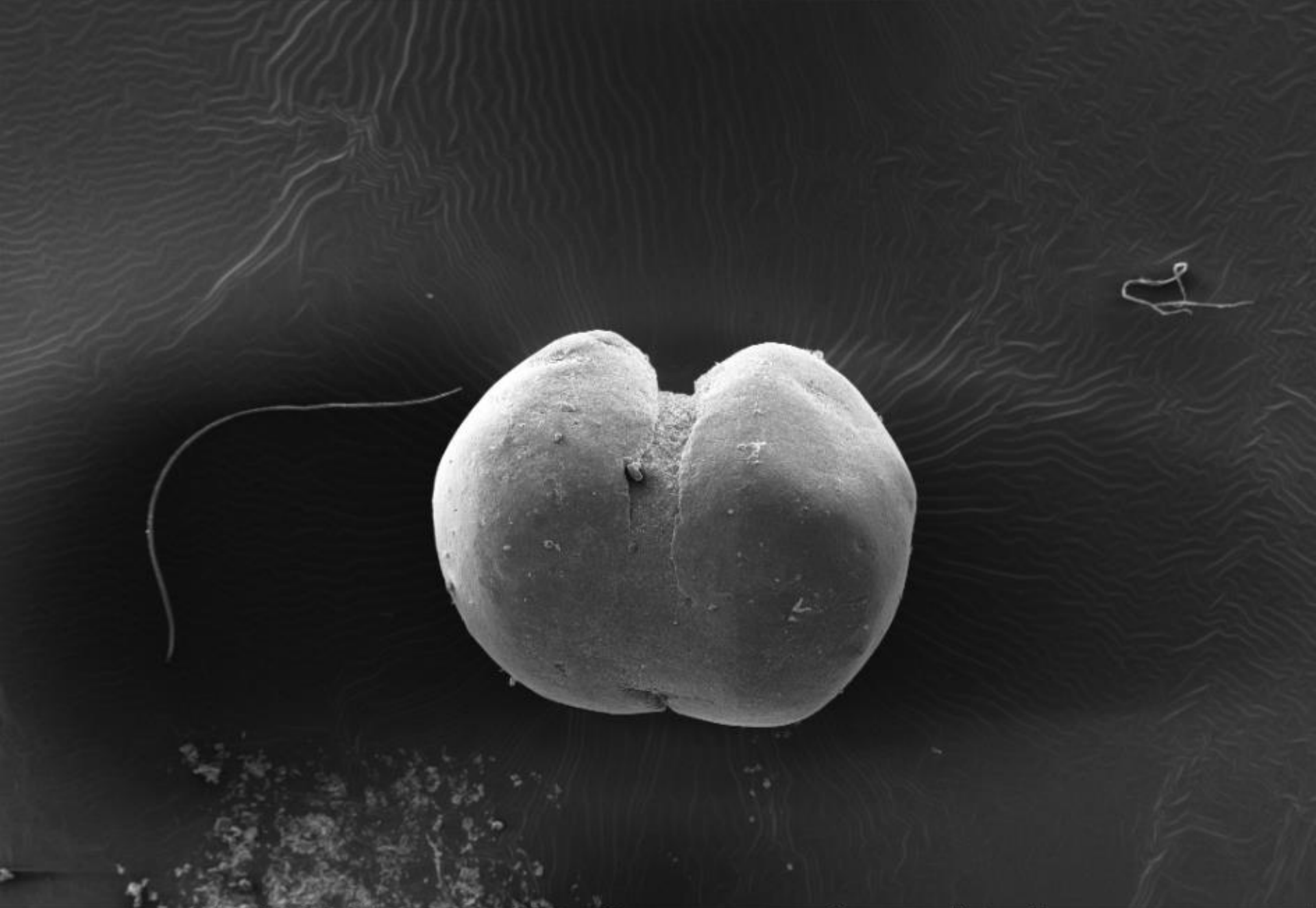

EHT=15.00 kV
200µm 

WD= 33 mm

Photo No.=8100

Mag= 75 X

Detector= SE1



EHT=15.00 kV
200µm 

WD= 33 mm

Photo No.=8101

Mag= 75 X

Detector= SE1

FORMULAZIONE SBAGLIATA!!!!

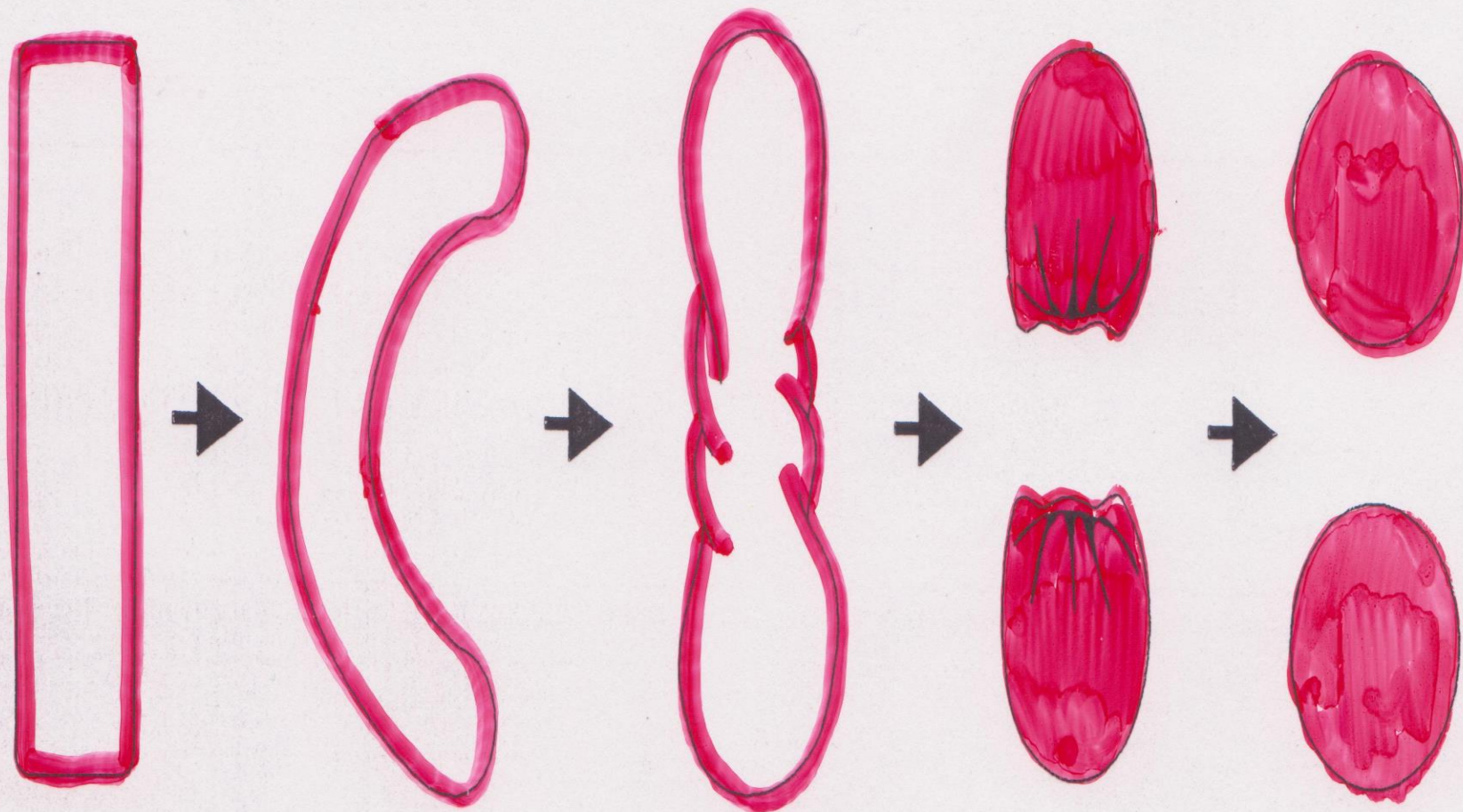

(a)

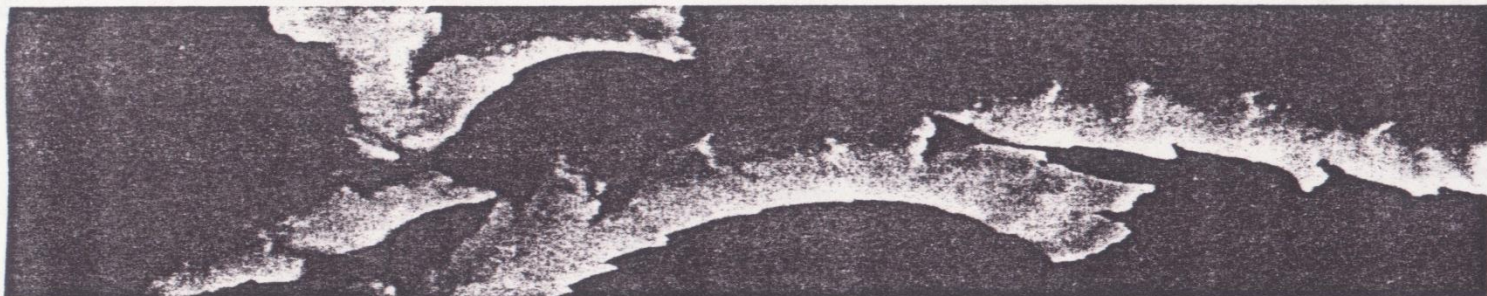

(b)



(c)



(d)

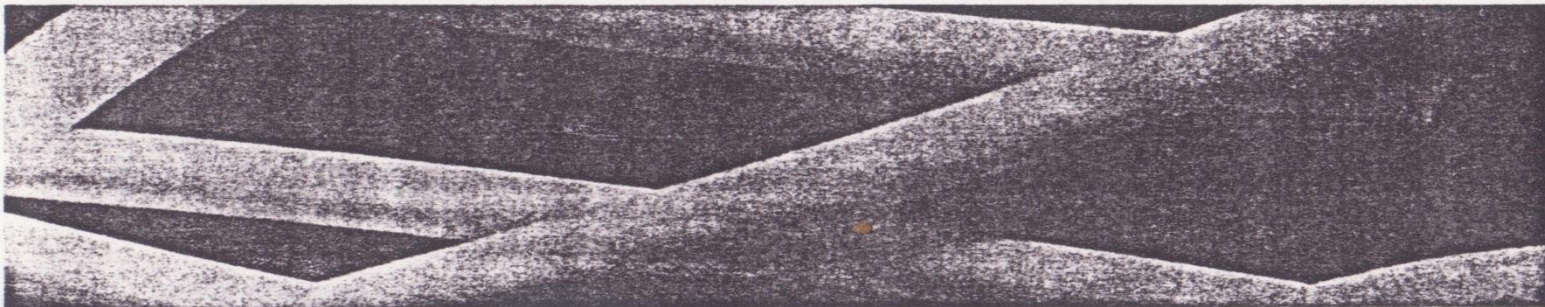

50:50

1.6 – 2 mm (95%)

1735 ± 114 μm



Ar = 1.03 ± 0.03

60:40 1.6 – 2mm (80%)

1.25 – 1.6 mm (14%)

$1686 \pm 111 \mu\text{m}$

$1619 \pm 150 \mu\text{m}$

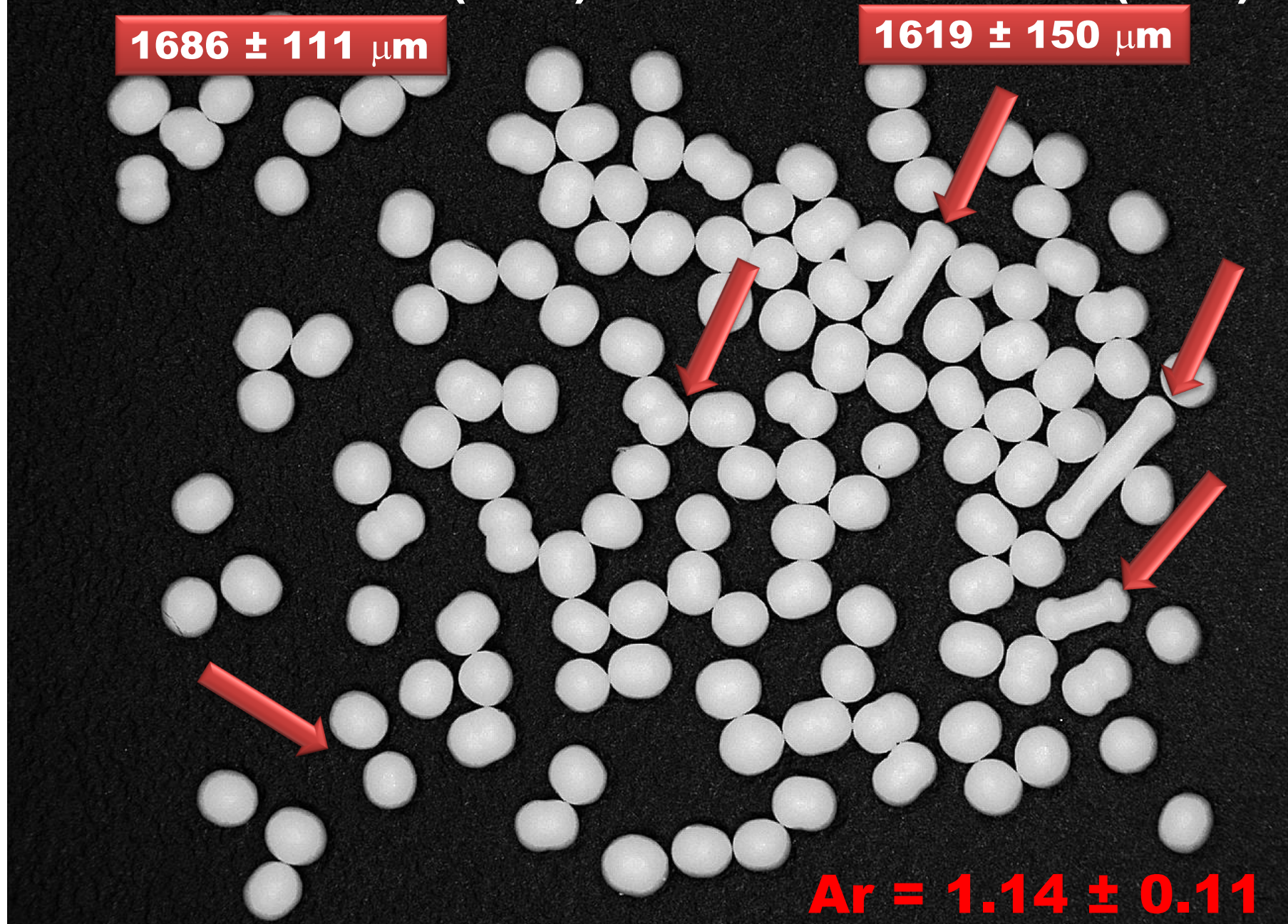

$Ar = 1.14 \pm 0.11$

70:30 1.25 – 1.6 mm (94%)

1640 ± 202 μm

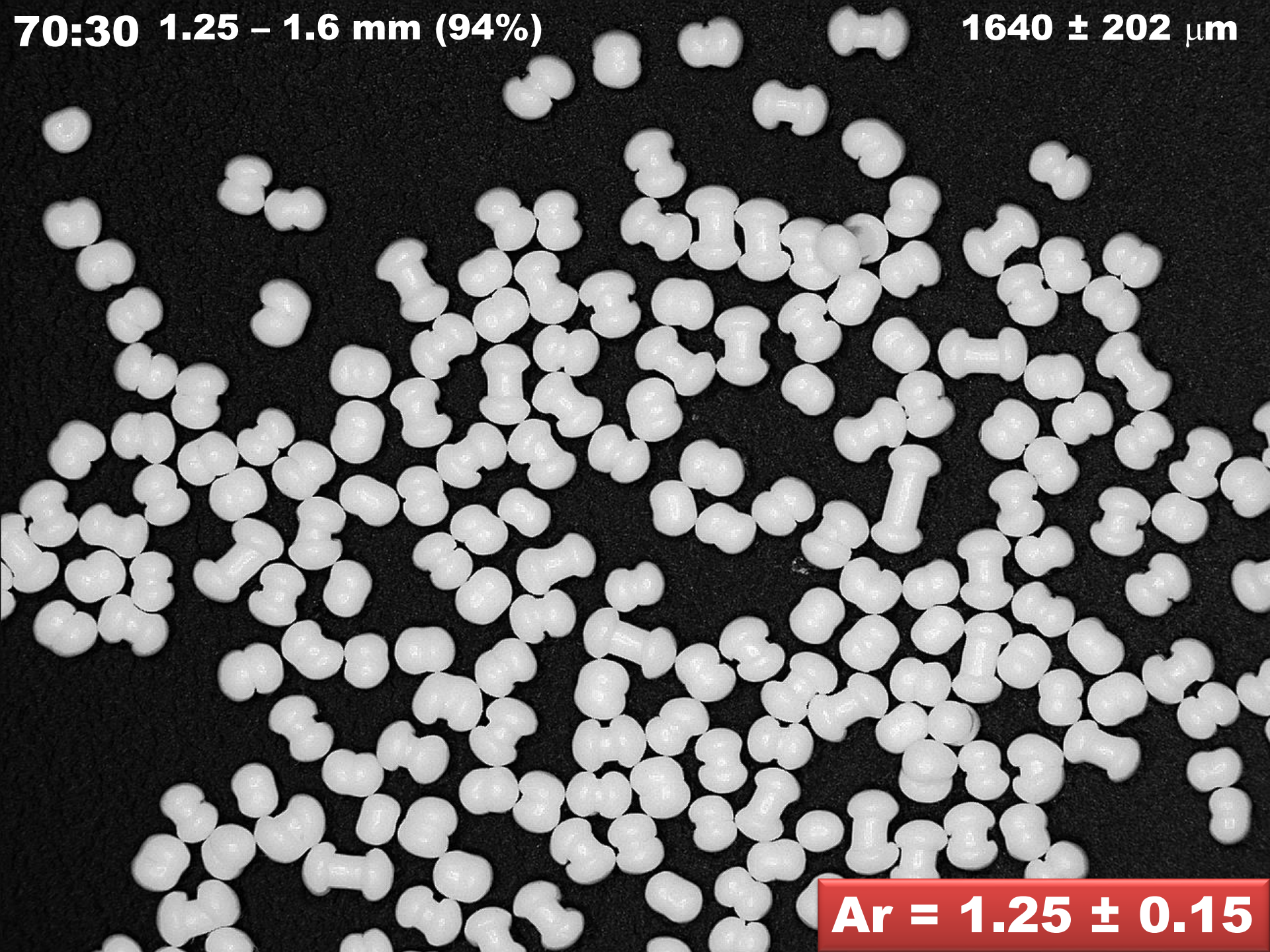

Ar = 1.25 ± 0.15

CARATTERISTICHE RICHIESTE PER DEFINIRE UNA SFERONIZZAZIONE IDEALE:

- **PRODUZIONE DI PELLETS CON FORMA SFERICA DI DIMENSIONI UNIFORMI, SUPERFICIE LISCIA, SUFFICIENTE RESISTENZA MECCANICA, BASSA FRIABILITÀ E CON CARATTERISTICHE DI RILASCIO DEL FARMACO APPROPRIATE.**
- **RESE ELEVATE CON CARICAMENTO DI UNA ELEVATA QUANTITÀ DI FARMACO (MINIMO 80%)**
- **ACQUA COME BAGNANTE**
- **NON NECESSARI ULTERIORI ECCIPIENTI NELLA FORMULAZIONE**
- **AMPIO INTEVALLO DI CONCENTRAZIONE DEL LIQUIDO BAGNANTE**

FATTORI CHE INFLUENZANO LA QUANTITÀ DEI PELLETS NELL'ESTRUSIONE/SFERONIZZAZIONE

1. ECCIPIENTI

2. PRINCIPI ATTIVI

3. TIPI DI ESTRUSORI

1. ECCIPIENTI

- ❑ **CARATTERISTICHE CHIMICO-FISICHE: FORMA e D**
- ❑ **INSOLUBILITÀ IN AMBIENTE ACQUOSO**
- ❑ **CAPACITÀ DI ASSORBIRE ACQUA E DI TRATTENERLA**
- ❑ **PROPRIETÀ LEGANTI**
- ❑ **SUFFICIENTE AREA SUPERFICIALE PER INTERAZIONI CON L'ACQUA E ALTRI INGREDIENTI IN UNA MISCELA DI POLVERI**
- ❑ **CAPACITÀ DI MIGLIORARE IL RILASCIO DEL FARMACO**

ESEMPI ECCIPIENTI:

- **CELLULOSA
MICROCRISTALLINA
(Avicel)**
- **AMIDO E DERIVATI**
- **HPMC-HEC**
- **OSSIDO DI PROPILENE**
- **CHITOSANO**
- **PECTINA**
- **CROSPOLIDONE**
- **GLICERIL
MONOSTEARATO**
- **K-CARRAGENANO**

SVANTAGGI TECNOLOGICI DELLA CELLULOSA MICROCRISTALLINA (MCC):

- NEI PELLETS CONTENENTI UN'ALTA PERCENTUALE DI MCC LA DISGREGAZIONE È CONCENTRAZIONE DIPENDENTE
- I PROFILI DISSOLUTIVI SEGUONO UNA DISSOLUZIONE DI TIPO MATRICIALE

PROBLEMATICA:

- PER FARMACI POCO SOLUBILI
 - PER RIVESTIMENTO
- PER UN RILASCIO PULSATILE



SI CERCANO SOSTANZE ALTERNATIVE

ECCIPIENTI UTILIZZATI IN COMBINAZIONE CON MCC PER MIGLIORARE LA DISGREGAZIONE DEI PELLETS E/O IL RILASCIO DEL FARMACO:

a) DILUENTI

- LATTOSIO
- CALCIO DIFOSFATO
- MANNITOLO

- AMIDO E DERIVATI
- GLUCOSIO
- *β -CICLODESTRINE*

b) DISGREGANTI

• SODIO CROSCARAMELLOSO

• SODIO AMIDO GLICOLATO

c) AGENTI DI SUPERFICIE

• SODIO LAURILSOLFATO

• PEG

• POLISOBATO 80

• GLICERIL E SORBITANO
MONOLEATO

• SORBITAN
MONOPALMITATO

• GLICERIL
MONOSTEARATO

• SISTEMI
AUTOEMULSIONANTI

2. PRINCIPI ATTIVI

- **CONCENTRAZIONE (10-90%)**
- **CARATTERISTICHE CHIMICO-FISICHE (SOLUBILITÀ, FORMA)**

3. TIPI DI ESTRUSORI

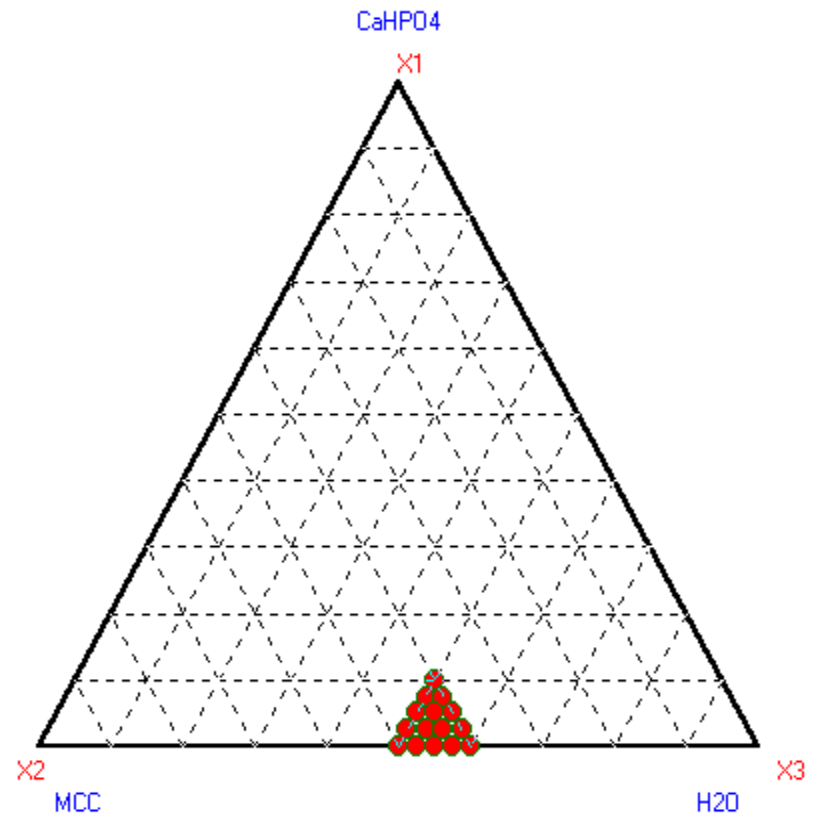
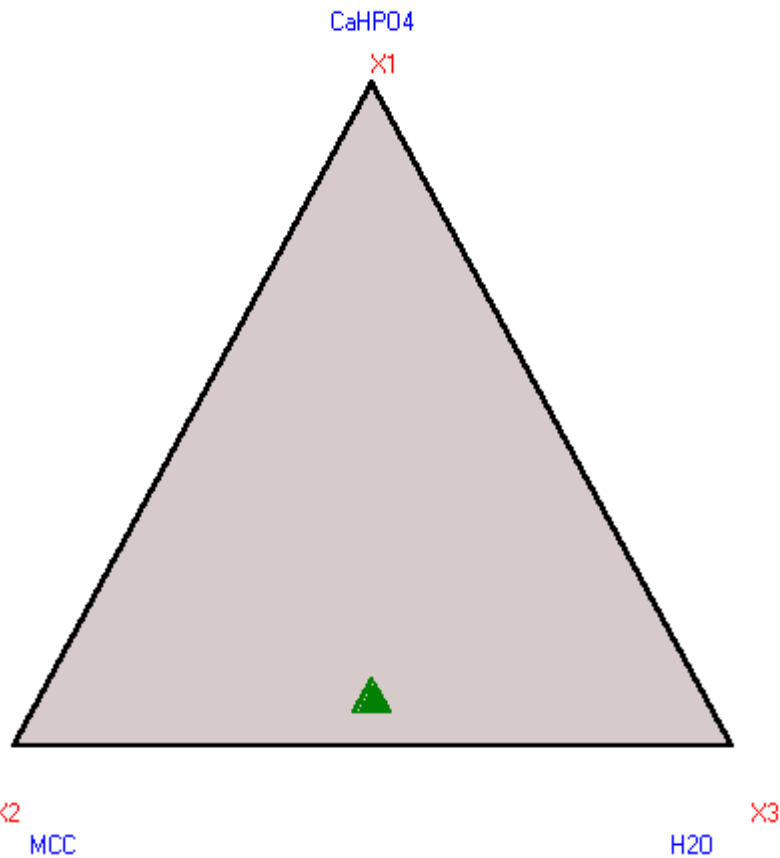

**ESTRUSORE
GRAVIMETRICO**

**ESTRUSORE
A PISTONE**

FORMULAZIONE?

Composant1

x1

x2

Composant2

x3

Composant3

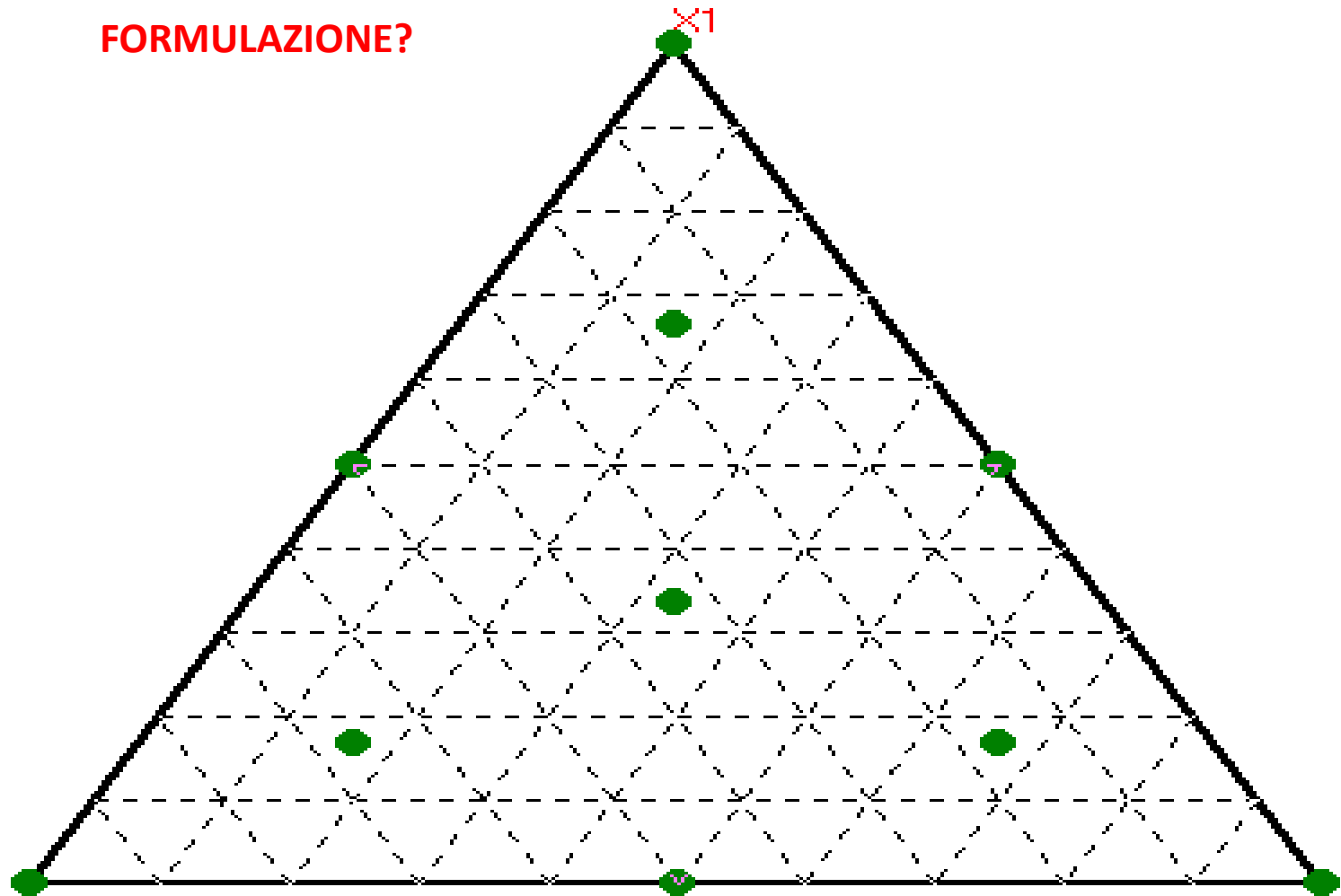

FORMULAZIONE?

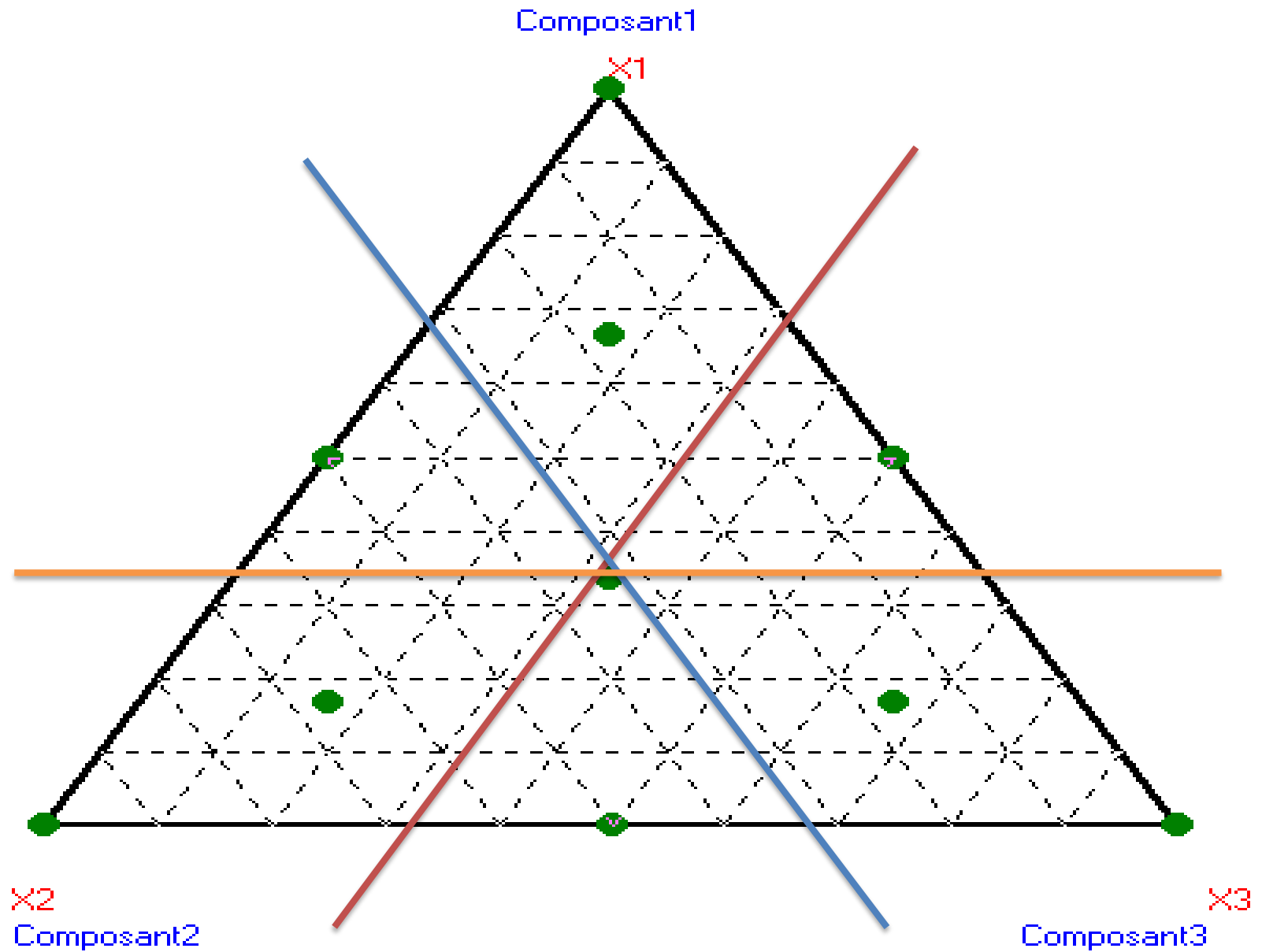

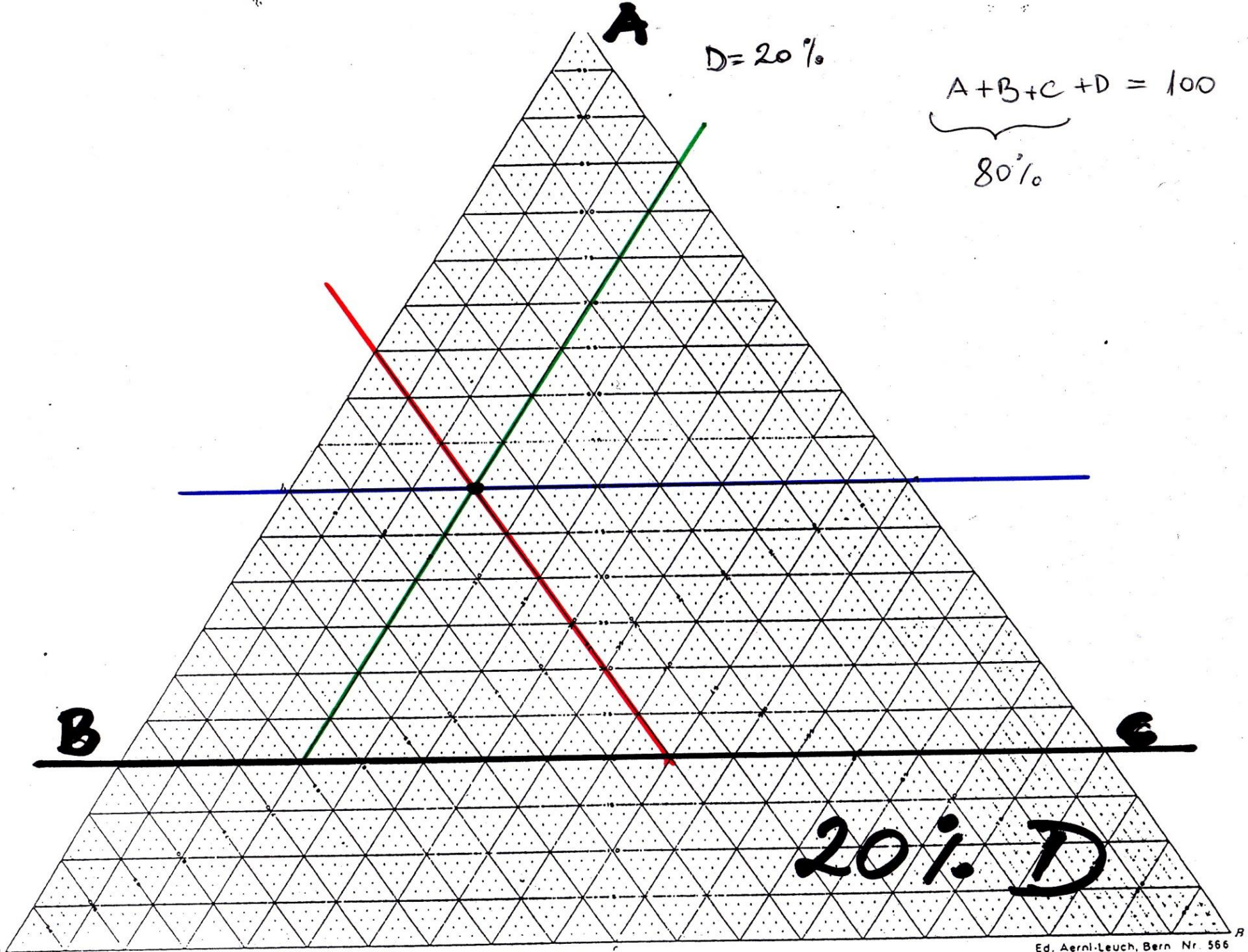

Estrusione/Sferonizzazione

- ❑ **Materiali:** -p. attivo
 - agente sferonizzante (CMC)
 - leganti
 - diluenti
- ❑ **Apparecchiature:** -impastatrice convenzionale
 - estrusore
 - sferonizzatore
- ❑ **Aspetti favorevoli:** -controllo della distribuzione dimensionale
 - ottima possibilità di carico del p. attivo con resistenza meccanica
 - discreta riproducibilità
- ❑ **Aspetti critici:** -p. attivo a contatto con liquidi
 - caratteristiche di solubilità del p. attivo
 - necessita di più apparecchiature (essiccamento in letto fluido)

estrusione/sferonizzazione: chetoprofene + CMC

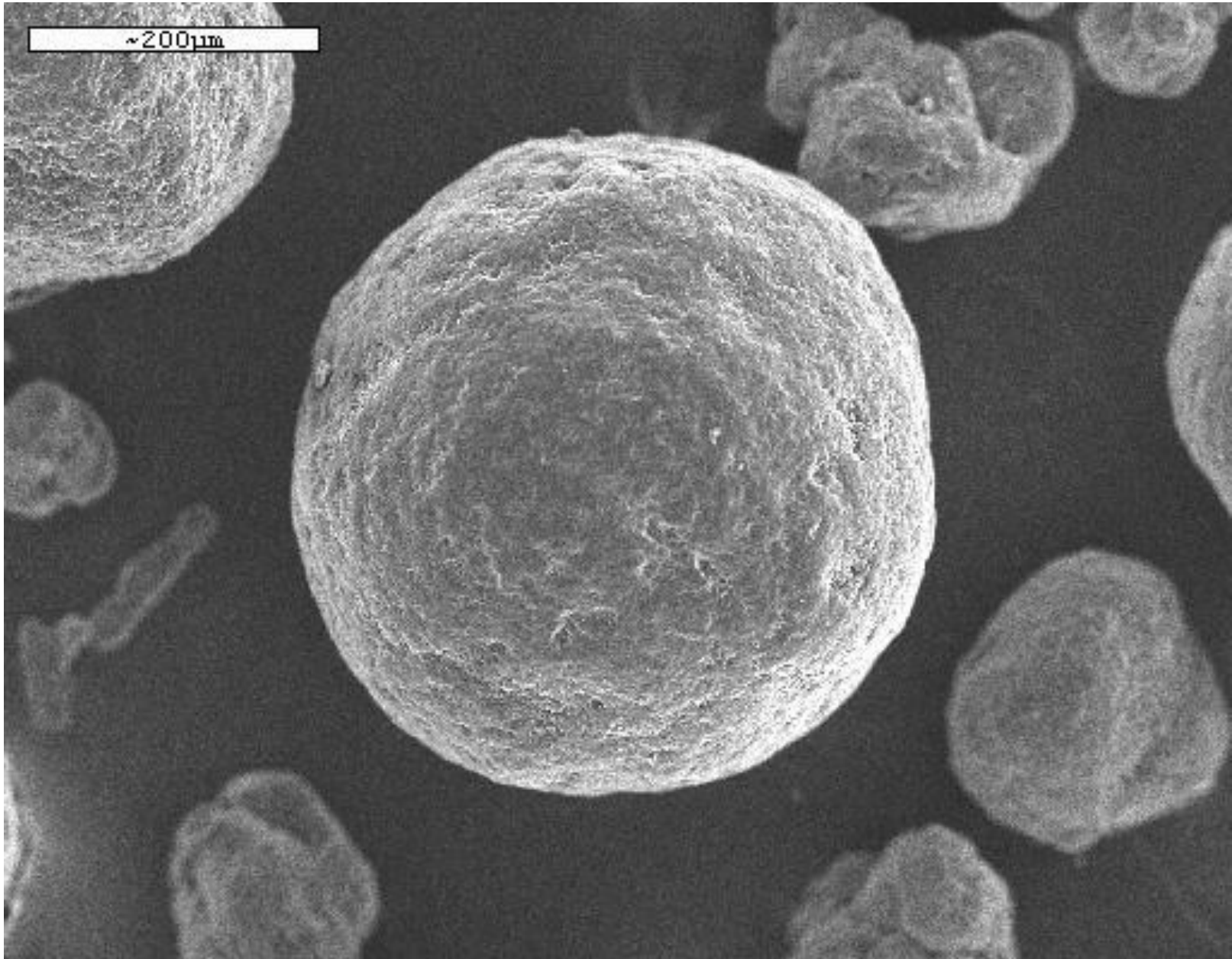

AGGLOMERIZZAZIONE AGITAZIONE/PALLOTIZZAZIONE

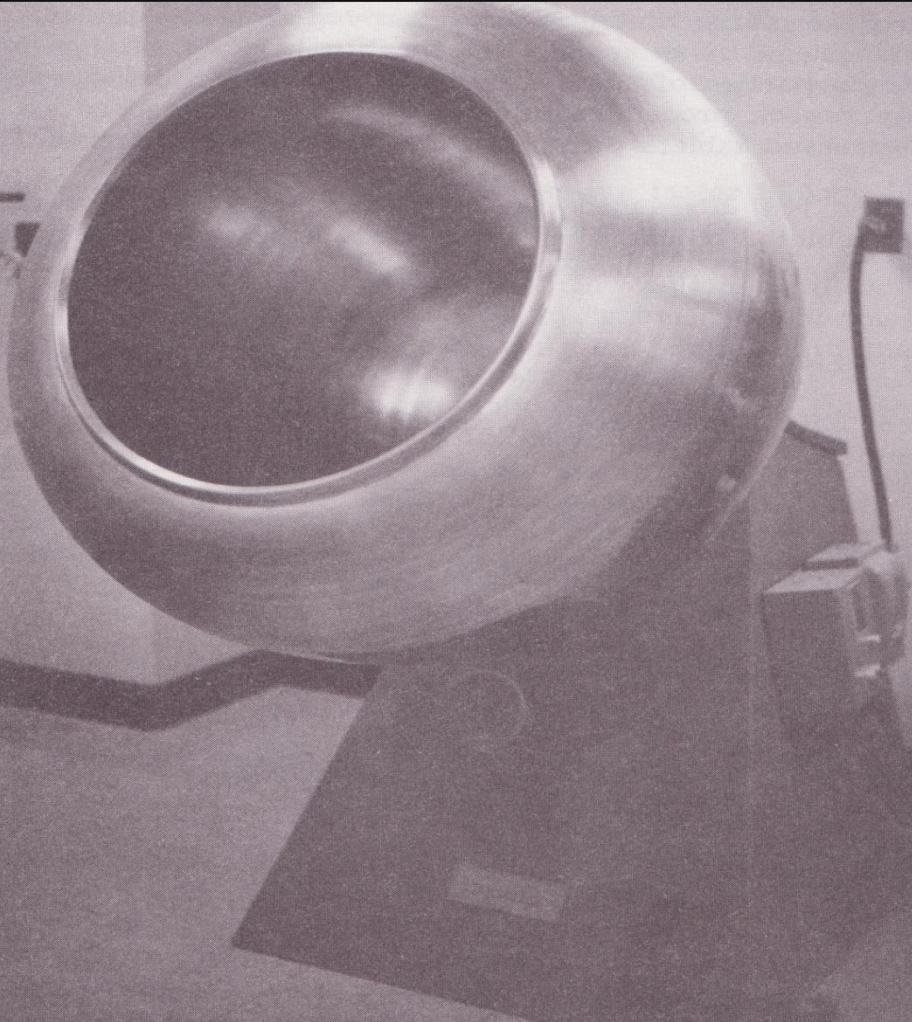

BASSINA

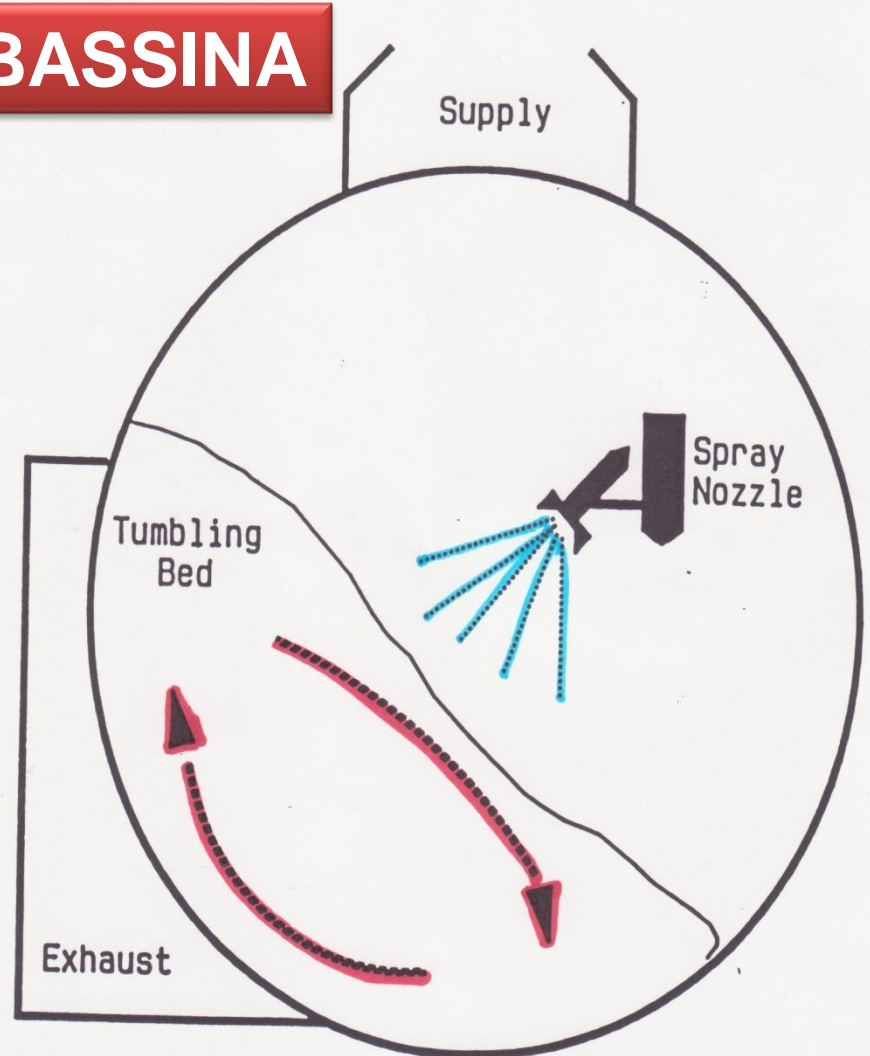

Fig. 5 Perforated pan.

NUCLEI PREFORMATTI INERTI : SACCAROSIO



AGITAZIONE/GRANULAZIONE AD UMIDO/G.RAPIDI

POLVERE + LIQUIDO + ENERGIA



TEMPO DI PROCESSO: 30-60 min

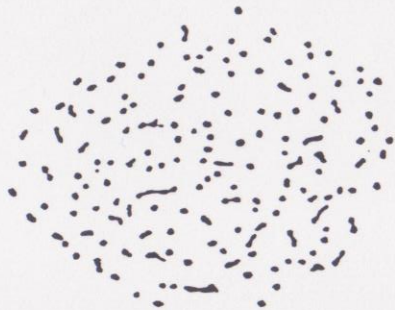

IL P.A. + MCC + ACQUA O SOLVENTE ORGANICO. I GRANULI VENGONO COMPATTATI E SFERONIZZATI

MECCANISMO

BAGNATURA



FASE DI COMPATTAZIONE 1

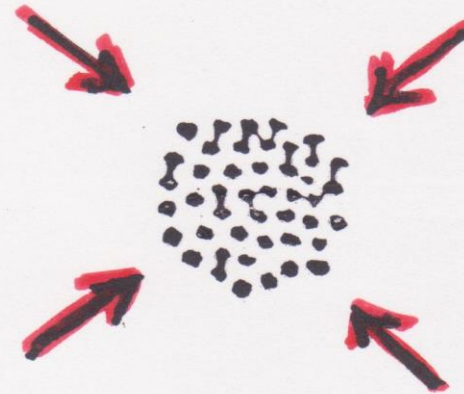

**FASE DI COMPATTAZIONE 2
EFFETTO SPUGNA/ESSICCAMENTO**

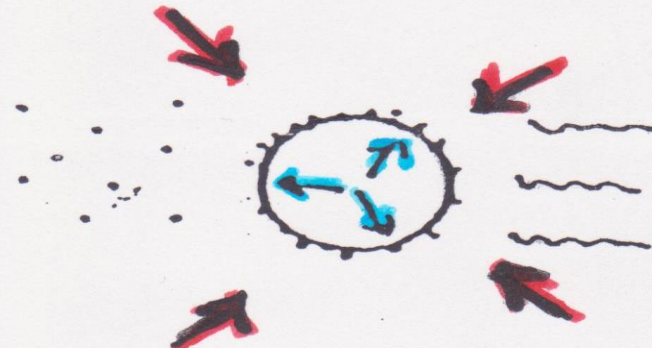

**FASE DI COMPATTAZIONE 2
EFFETTO SPUGNA/ESSICCAMENTO**

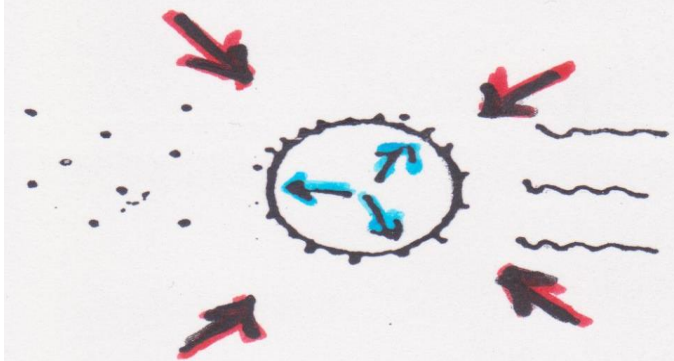

GA.ST. FOR ROTO P MEANS:

- faster drying
- no revalidation

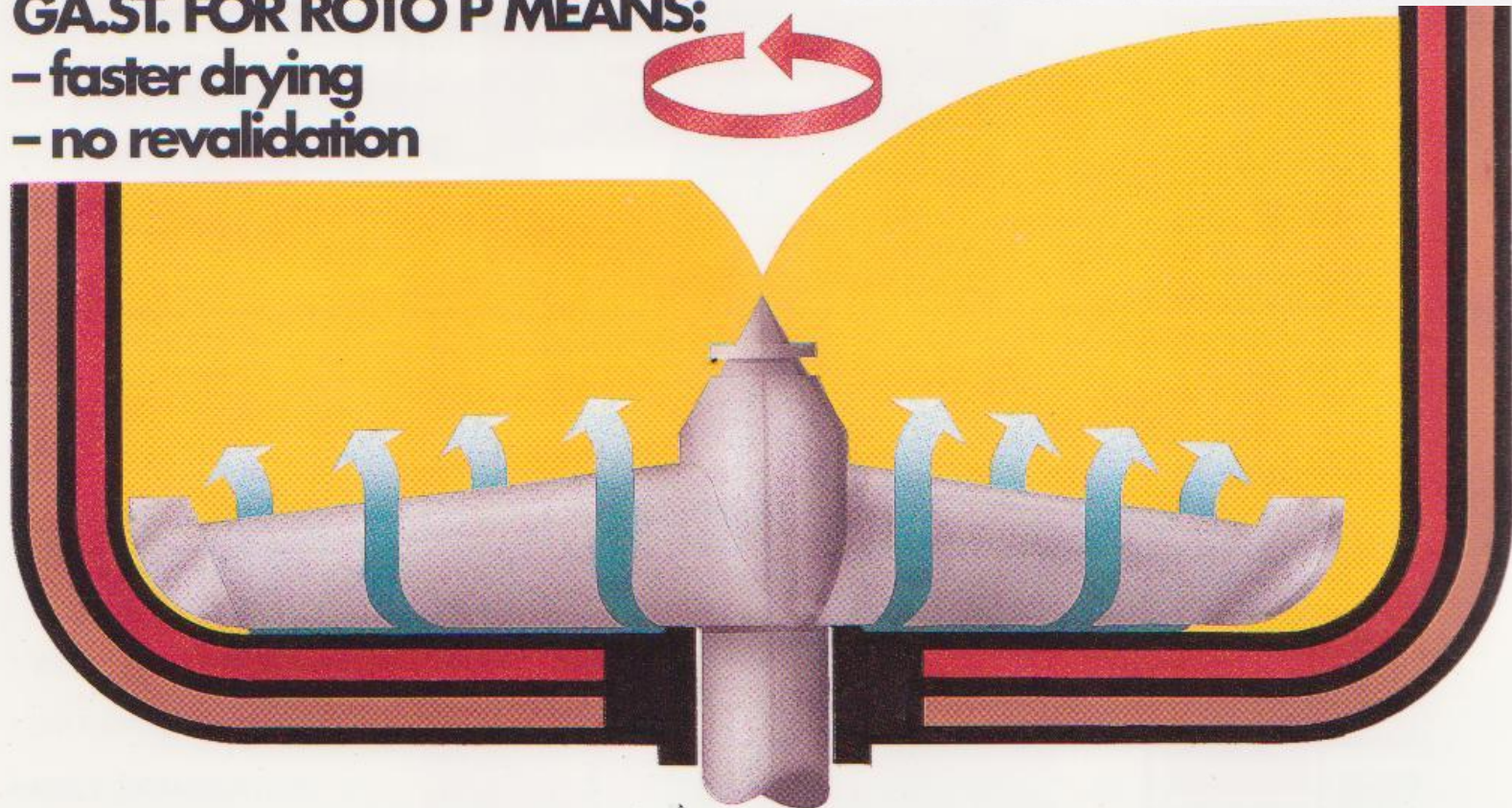

VARIABILI CRITICHE DI PROCESSO:

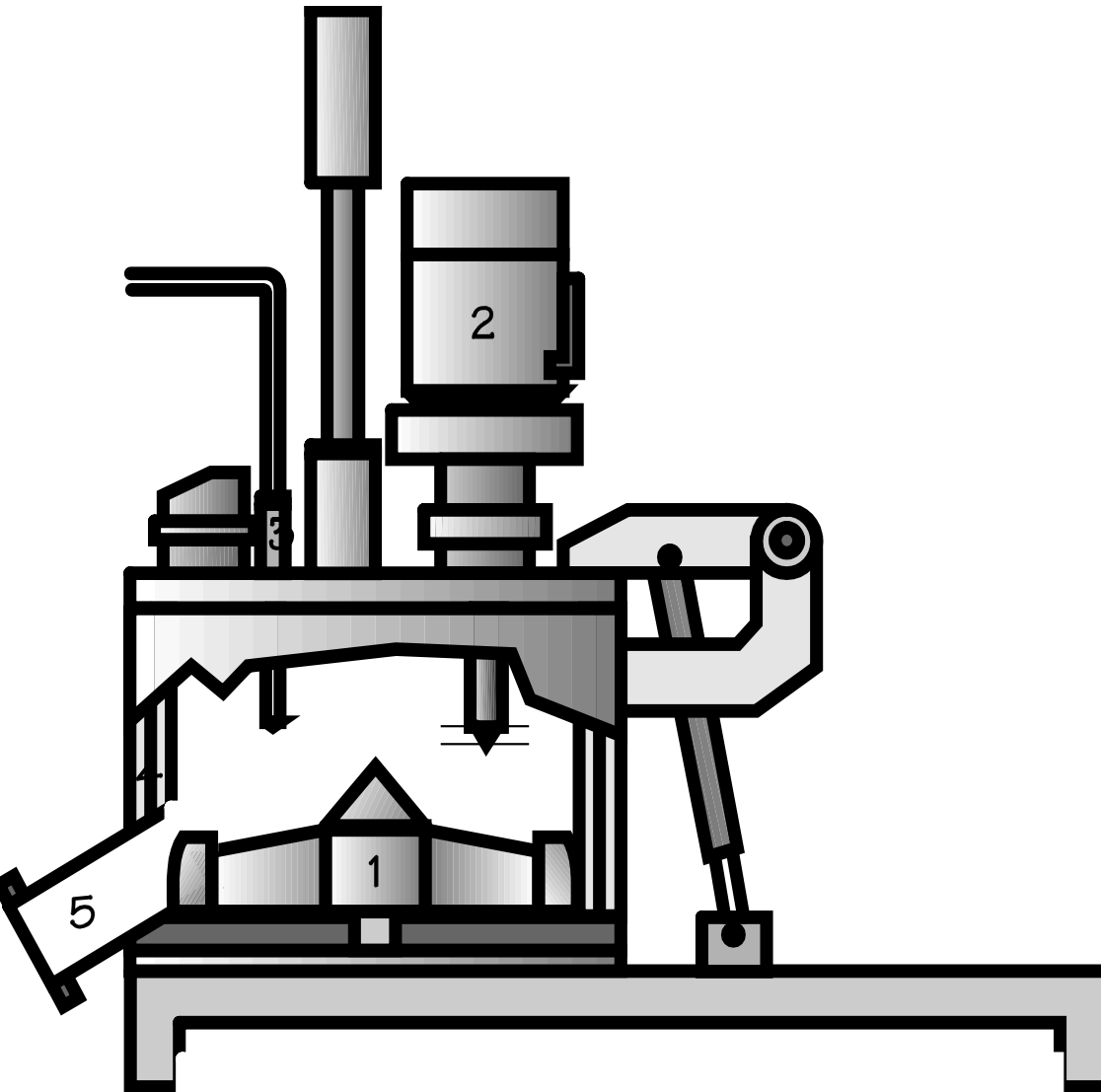

- **BAGNATURA**
- **VELOCITÀ DELL'IMPELLER**
- **TEMPO D'IMPASTO**
- **CARICO**
- **DEPOSITO SULLE PARETI**
- **FLUSSO D'ARIA**
- **CONFIGURAZIONE DELL'IMPELLER**
- **DIMENSIONI DELLE PARTICELLE**
- **CARATTERISTICHE DELLA SOLUZIONE LEGANTE**
- **INTERAZIONE TRA LEGANTE E POLVERI**

INGROSSAMENTO DEI PELLETS

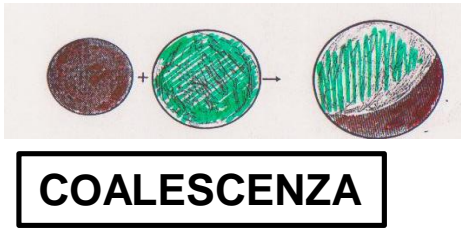
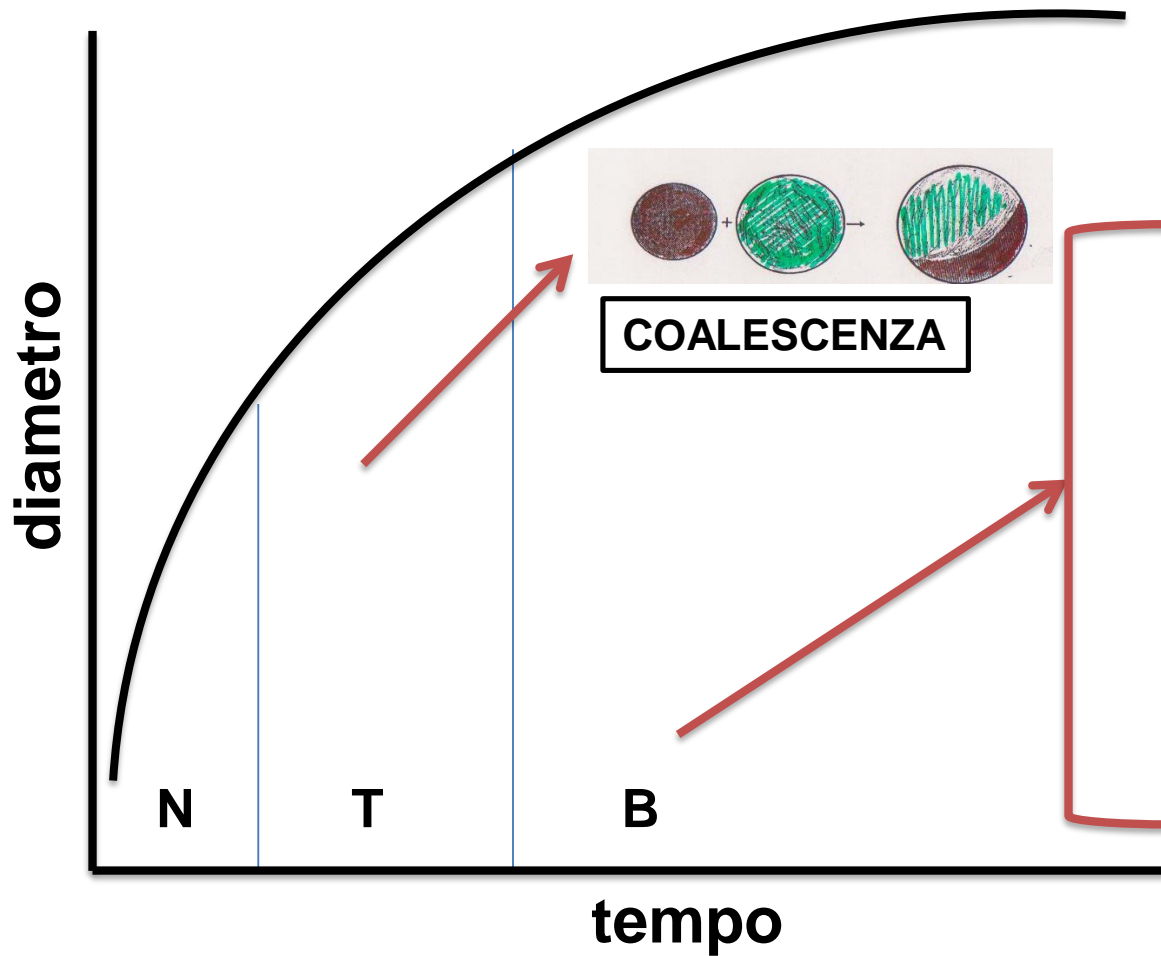

STRATIFICAZIONE

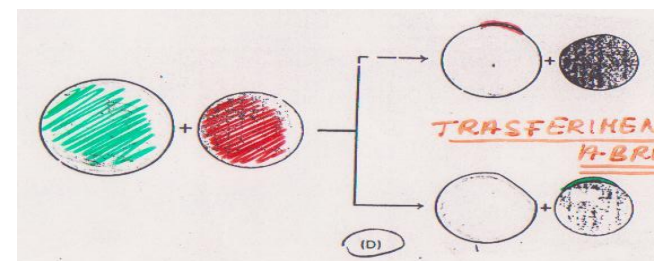
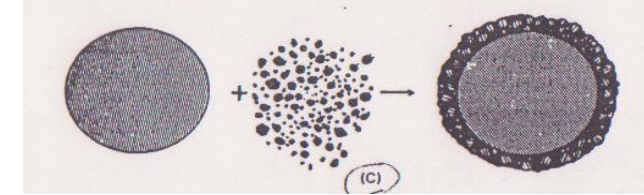

ABRASIONE

N - REGIONE DI NUCLEAZIONE
T - REG. DI TRANSIZIONE
B - REG. DI INGROSSAMENTO

Pellets prodotti con rotogranulatore (one step) ad alta velocità



AGITAZIONE/GRANULAZIONE PER FUSIONE/G.RAPIDI

P.A. IN POLVERE + ECCIPIENTI + LEGANTE (IN POLVERE) + ENERGIA

TEMPO DI PROCESSO: 15-30 min



VARIABILI CRITICHE DI PROCESSO:

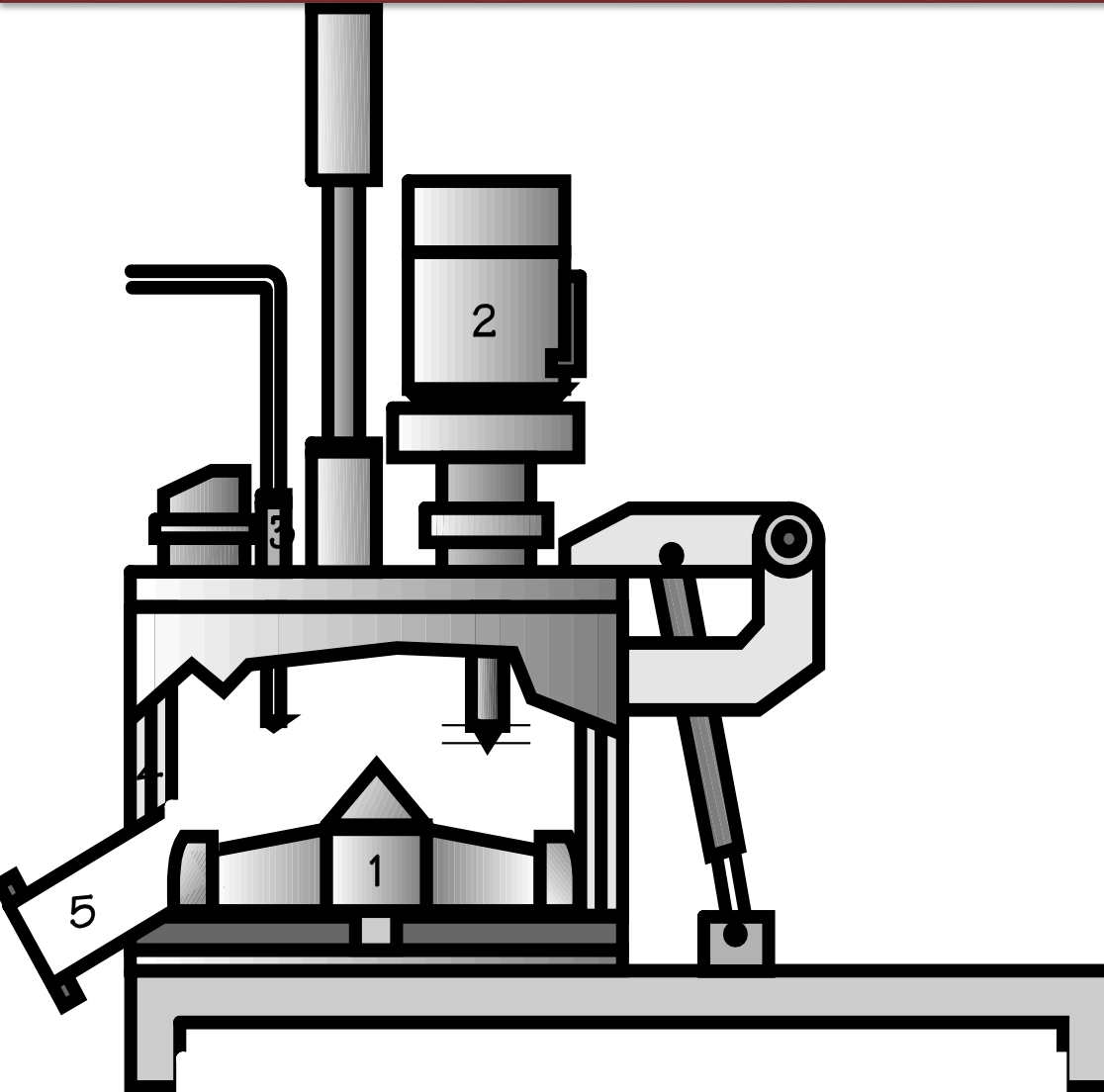

- QUANTITÀ DI LEGANTE
- VELOCITÀ DELL'IMPELLER
- TEMPO D'IMPASTO
- CARICO
- DEPOSITO SULLE PARETI
- **ENERGIA FORNITA (CALORE)**
- **CONFIGURAZIONE DELL'IMPELLER**
- DIMENSIONI DELLE PARTICELLE
- CARATTERISTICHE DELLA SOLUZIONE LEGANTE
- **I NTERAZIONE TRA LEGANTE E POLVERI**

CONFIGURAZIONE DELL'IMPELLER?

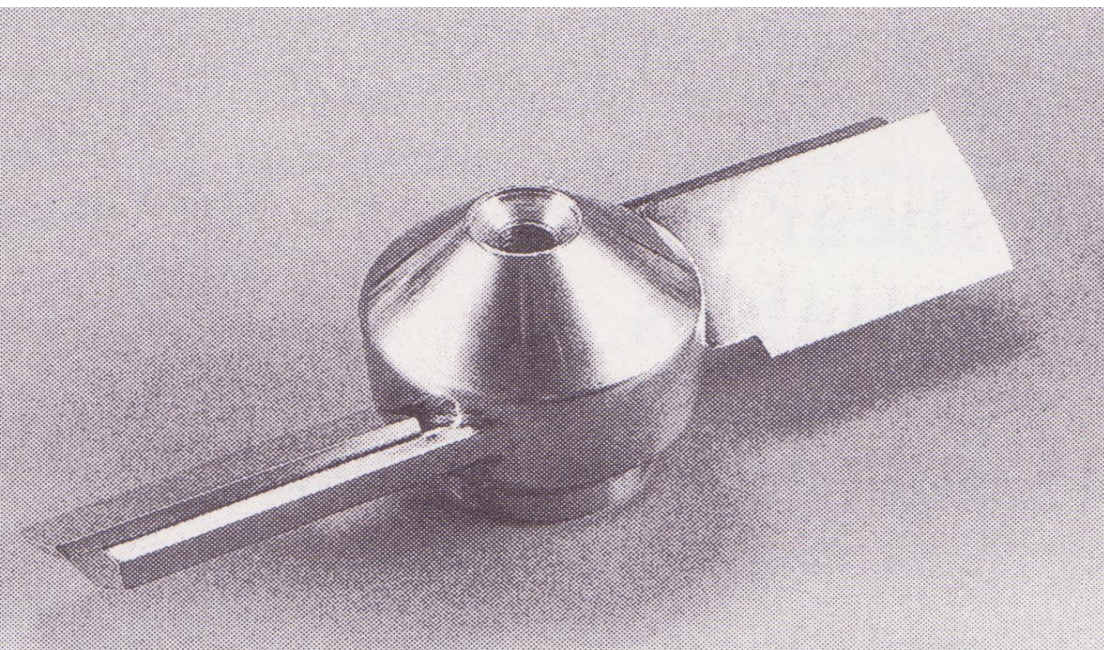

PIANA

CURVA

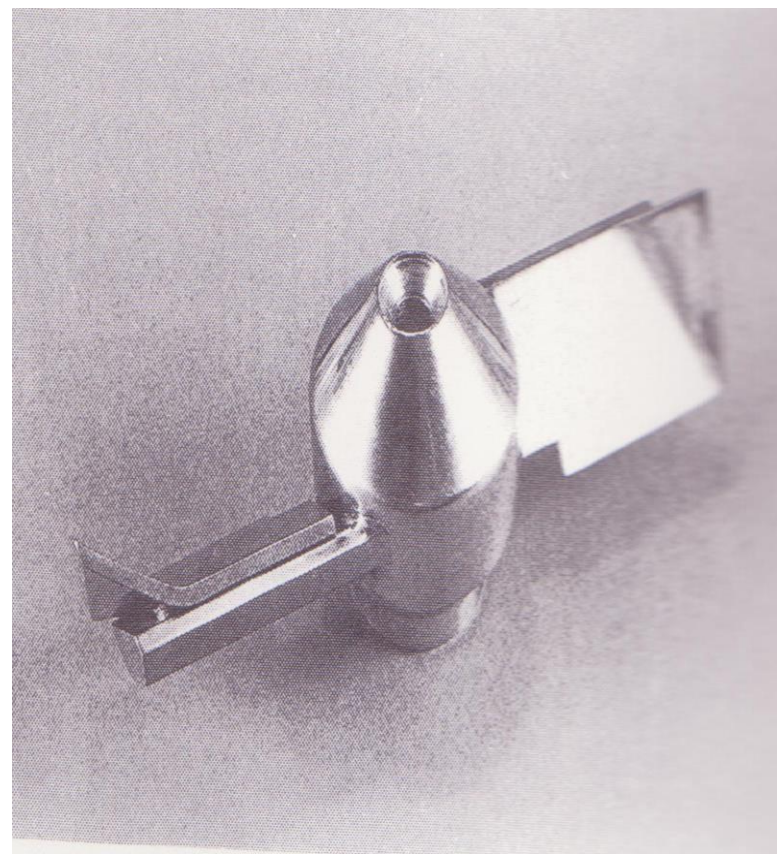

17 MIN

6 MIN

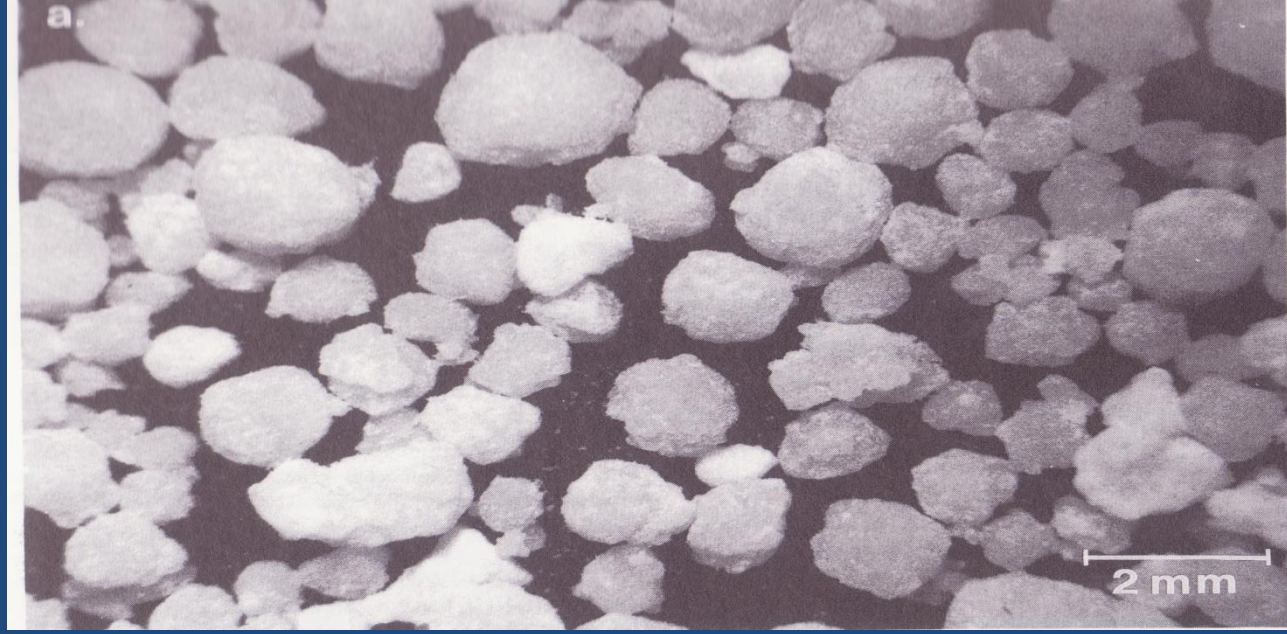
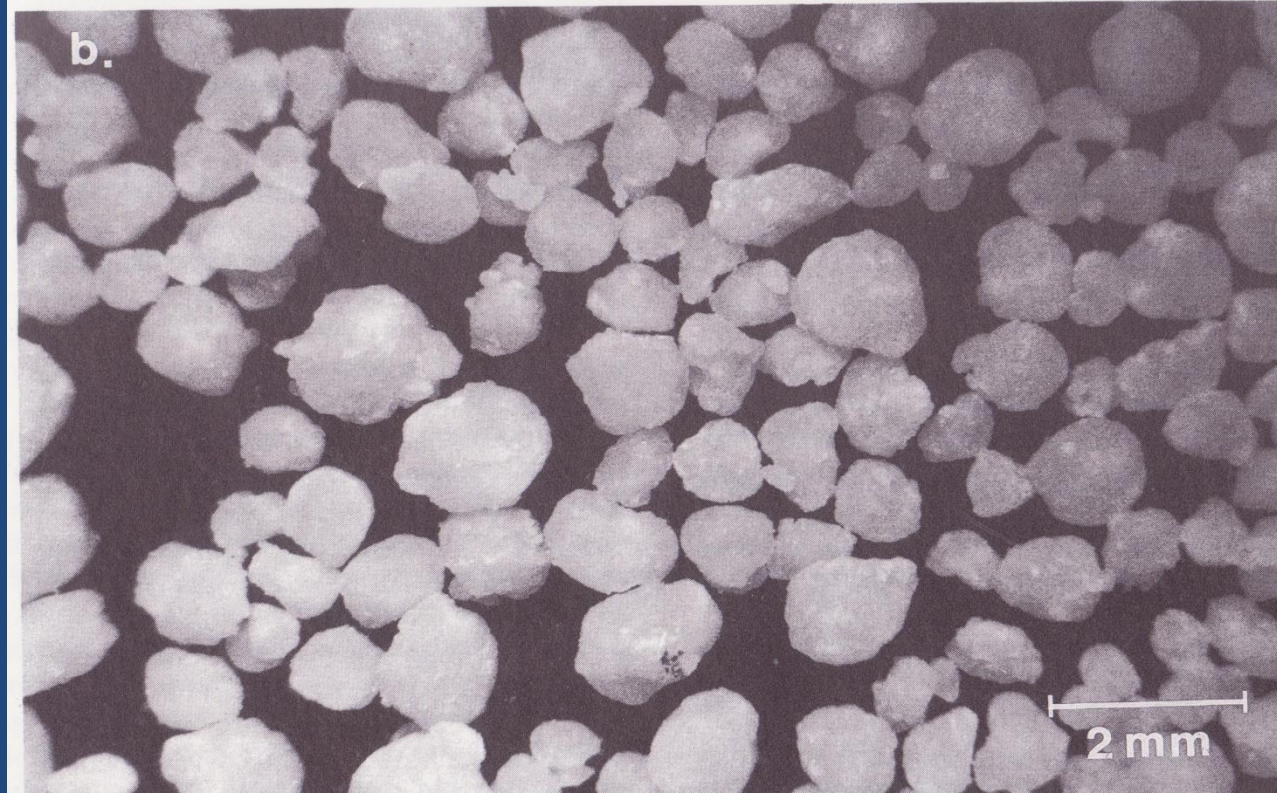

1200 rpm

17 MIN

6 MIN

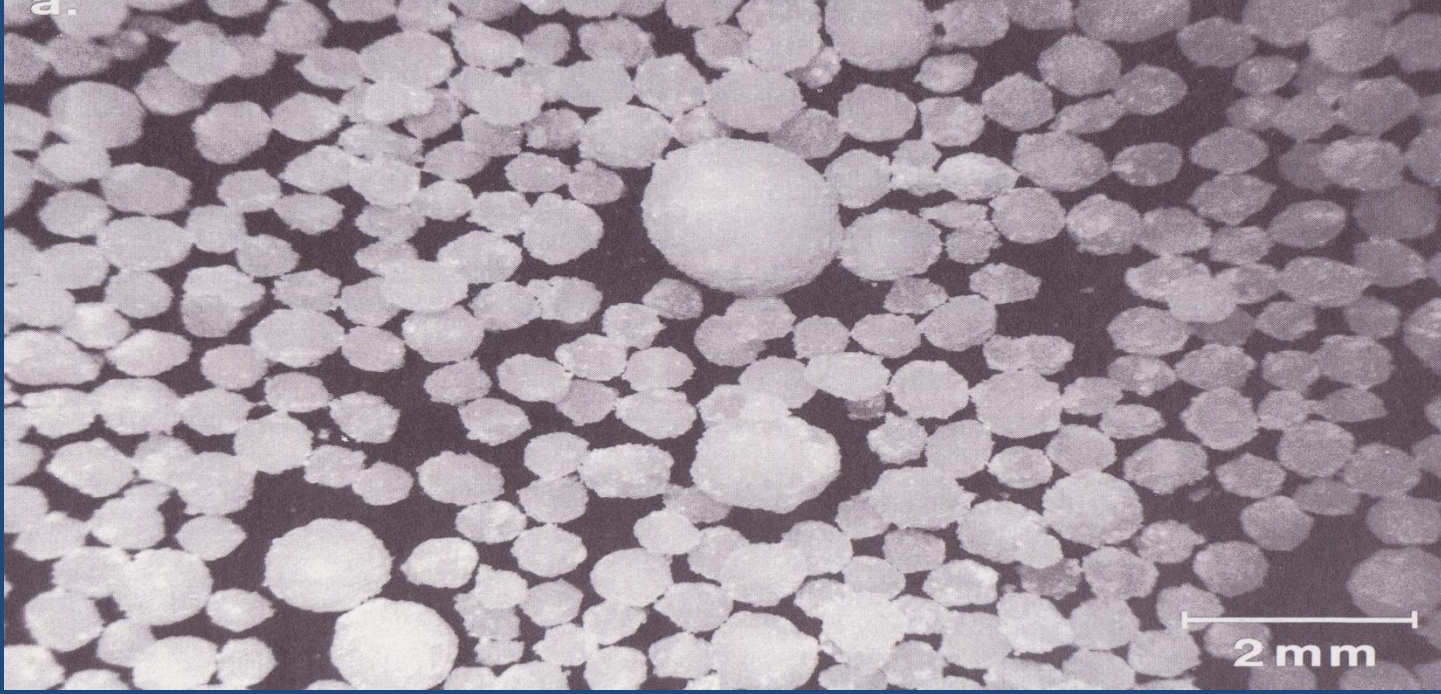

1200 rpm

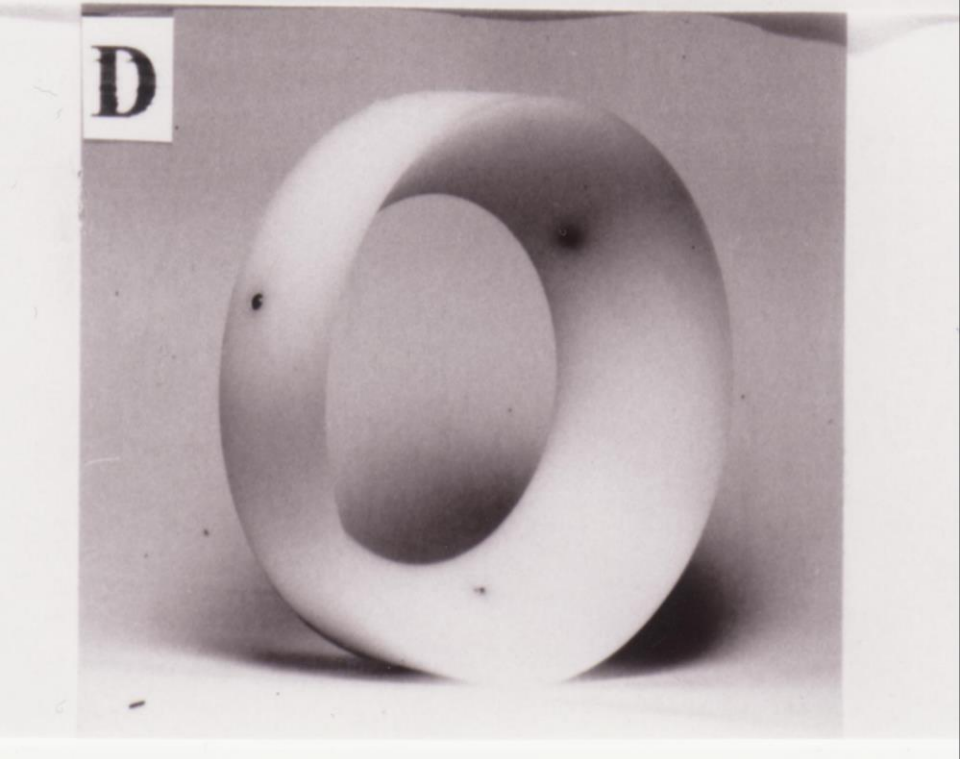
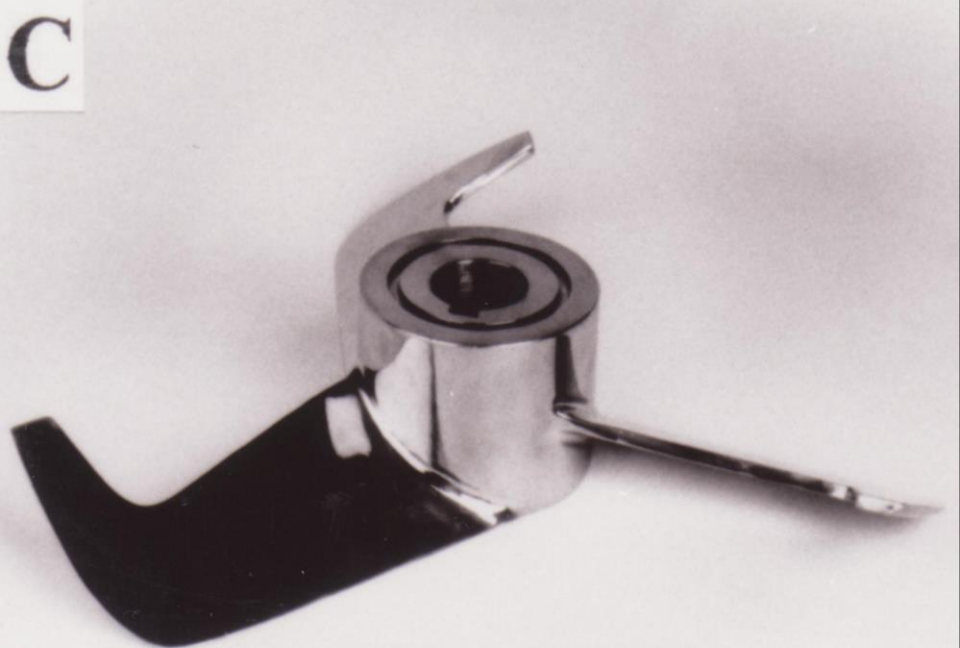

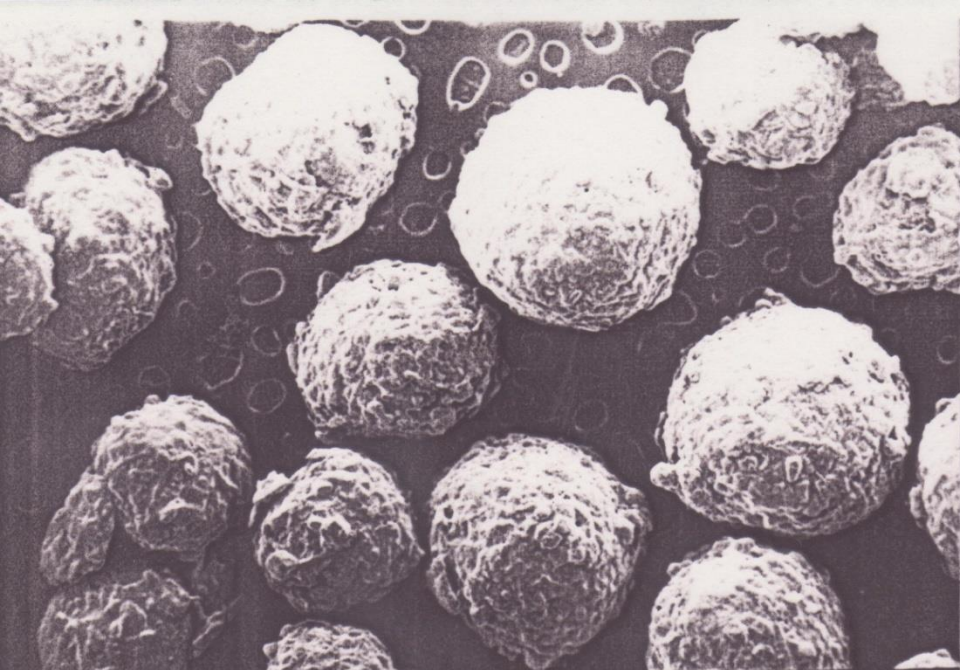

EHT= 8.54 kV WD= 16 mm Mag= 20 X Detector= SE1
200µm | Photo No.=1274

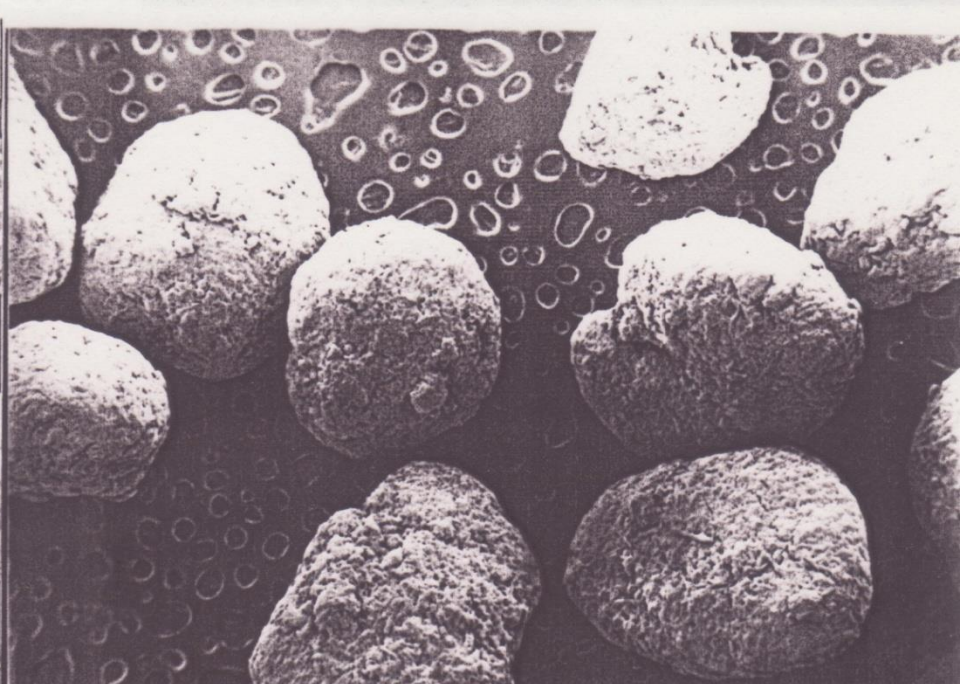

EHT= 8.54 kV WD= 17 mm Mag= 15 X Detector= SE1
1 mm | Photo No.=1275

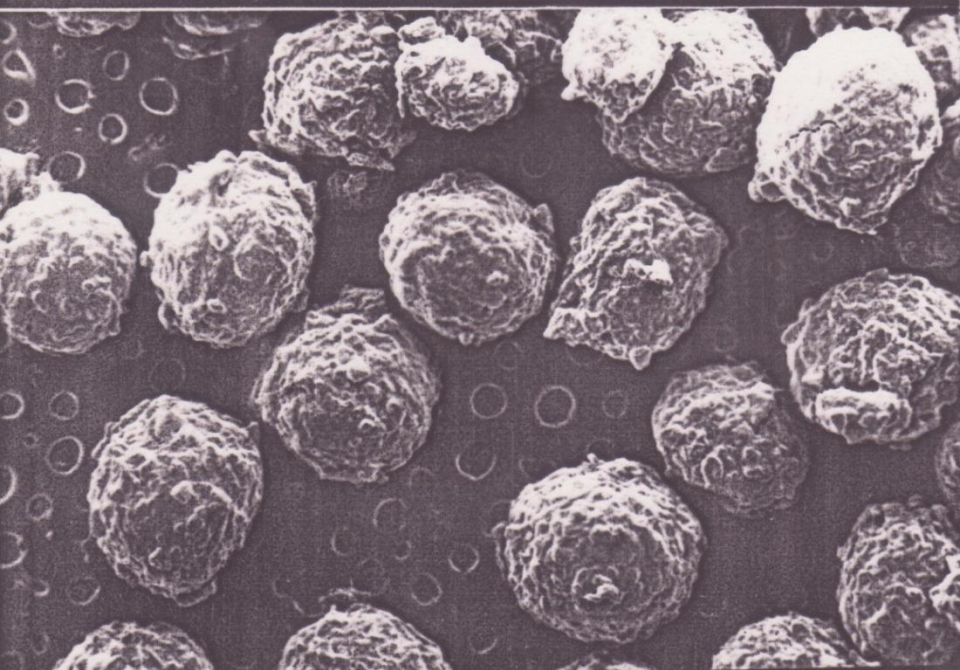

EHT= 8.54 kV WD= 17 mm Mag= 20 X Detector= SE1
200µm | Photo No.=1277

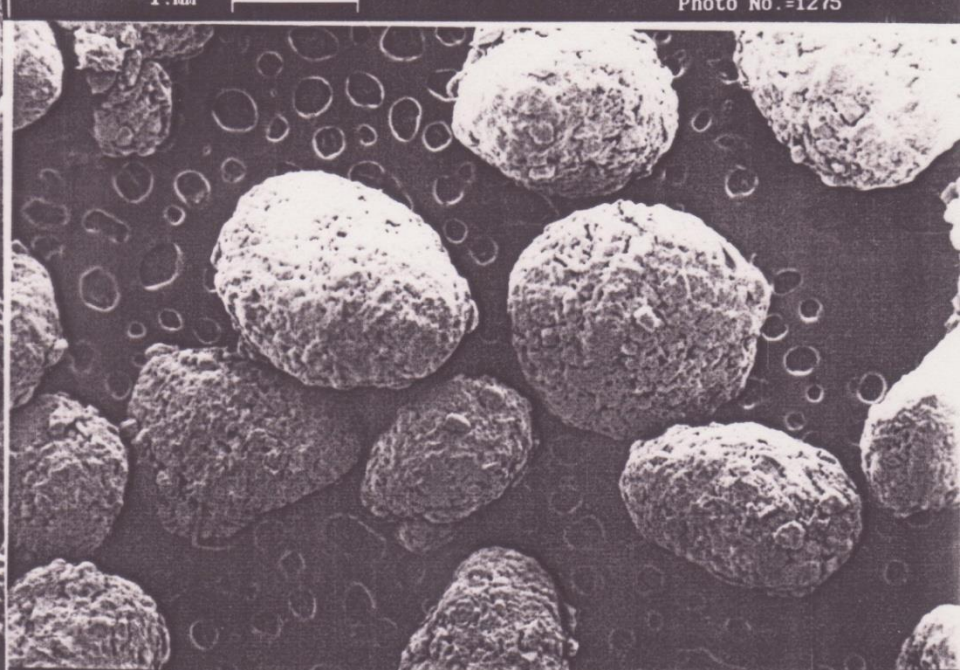

EHT= 8.54 kV WD= 17 mm Mag= 20 X Detector= SE1
200µm | Photo No.=1278

Rotogranulazione

- ❑ **Materiali:** - p. attivo
 - agente sferonizzante (CMC)
 - leganti, glidanti, antiaderenti, diluenti

- ❑ **Apparecchiature:** - rotogranulatore ad alta velocità (tipologie diverse – forma dimensioni)
 - rotogranulatore a letto fluido (stessa tipologia)

- ❑ **Aspetti favorevoli:** - tempi di processo contenuti
 - (rivestimento) impiego di una sola apparecchiatura
 - buona possibilità di carico del p. attivo

- ❑ **Aspetti critici:** - caratteristiche di solubilità del p. attivo
 - p. attivo a contatto con liquidi
 - caratteristiche del materiale di partenza
 - (dimensionali) problemi di resa (dimensioni) o ottimizzazione del processo
 - tecnologia non consolidata

ESTRUSORE A PISTONE/FUSIONE

- P_{max} pistone = 150 bar
- Capacità camera = 66 cm³
- ϕ int. = 25 mm
- T_{max} = 120°C
- Ugello intercambiabile (1.5, 2, 2.5 e 3 mm)

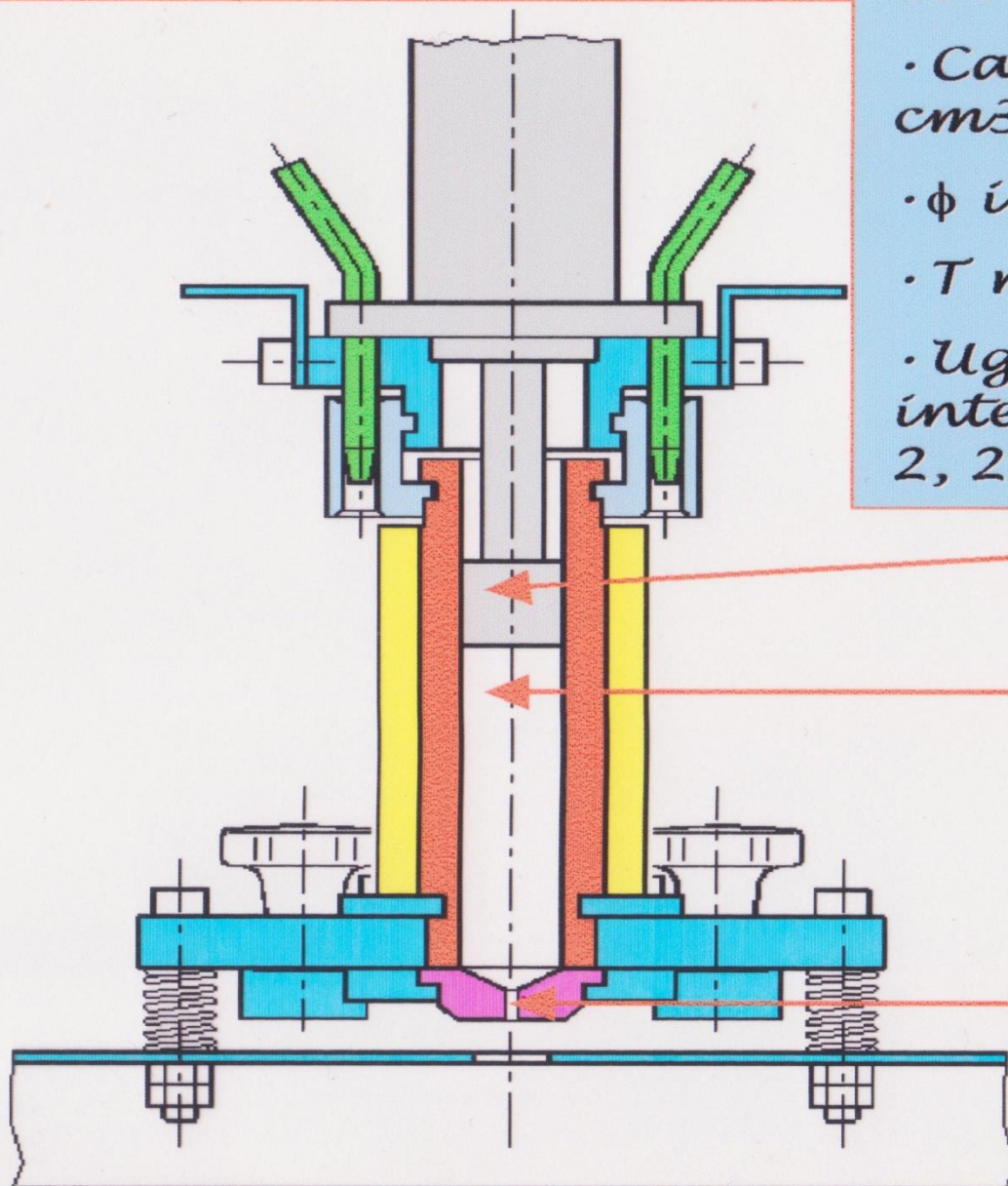

PISTONE

CAMERA

UGELLO



2. AGGLOMERAZIONE/COMPATTAZIONE (COMPRESSIONE)

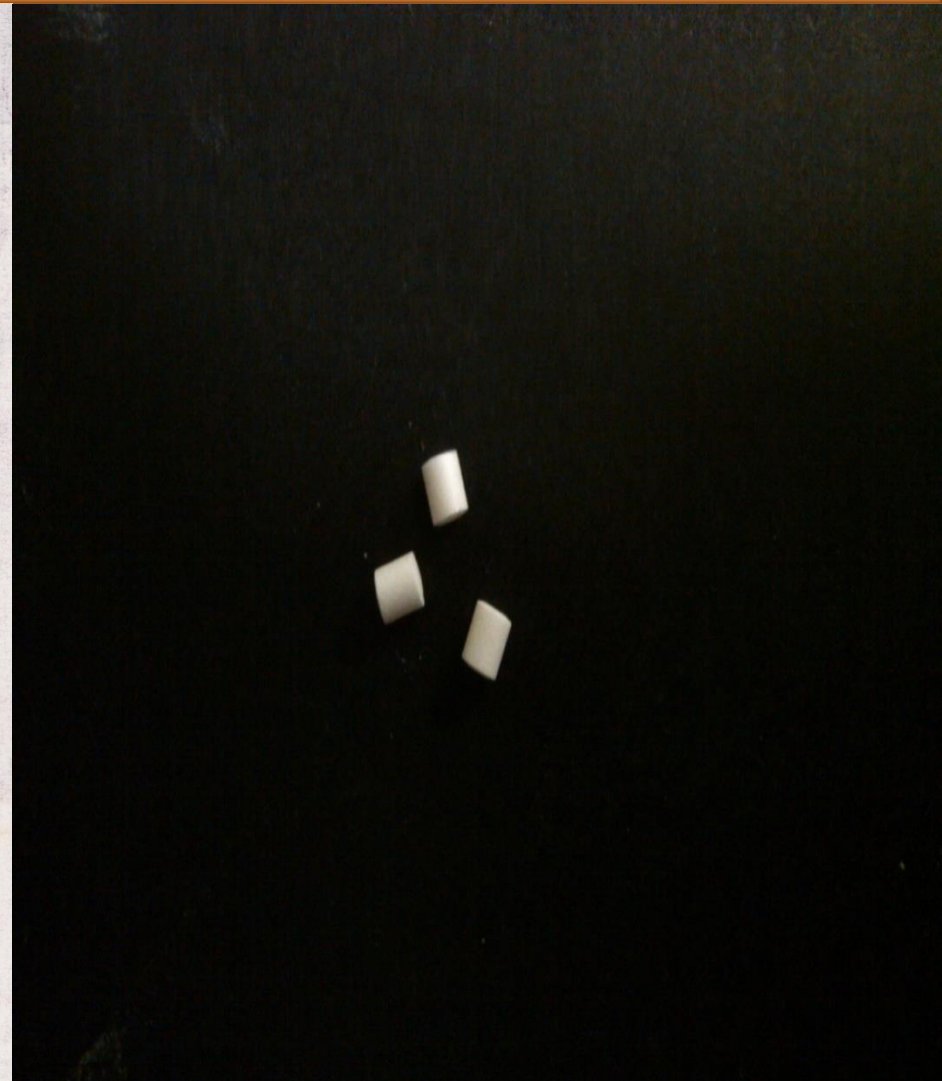
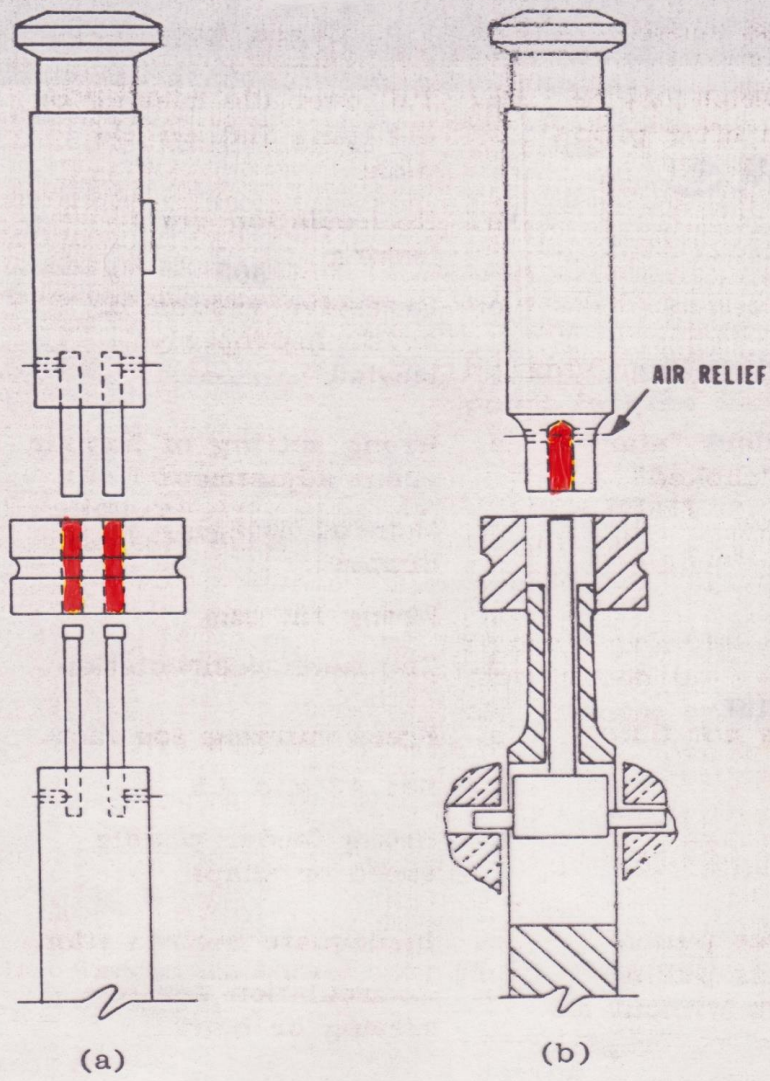

MATRICE

TEOFILLINA

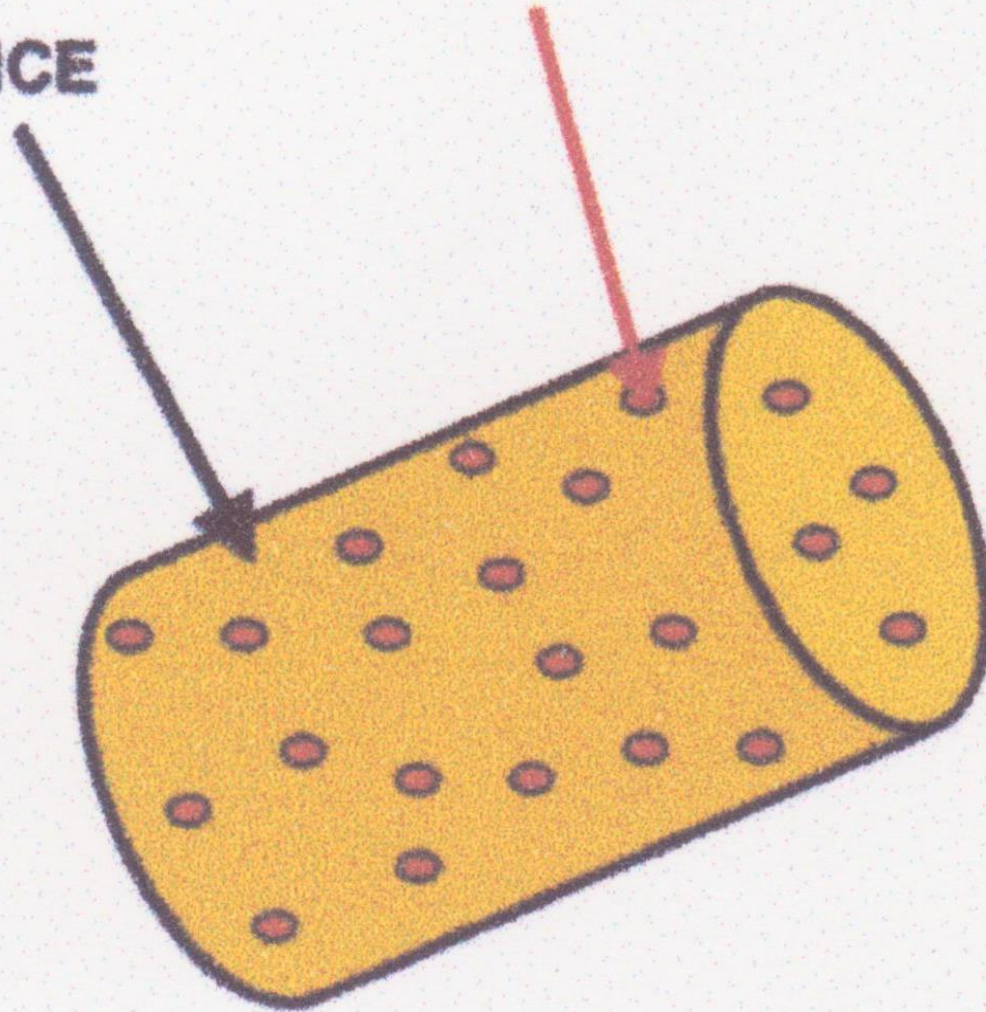

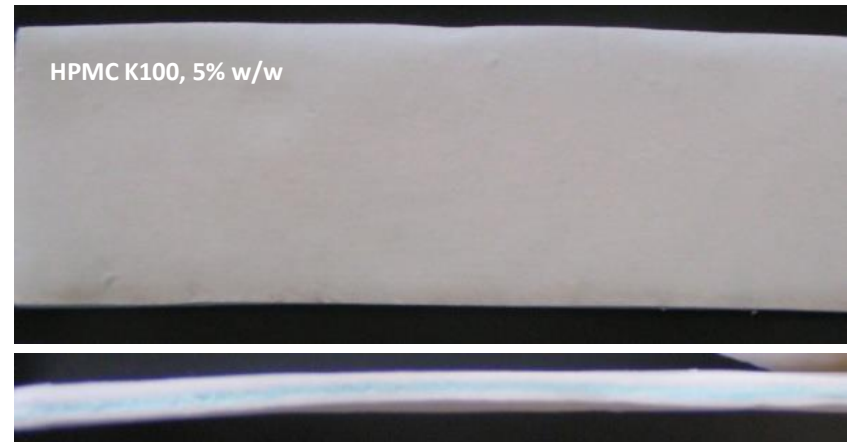
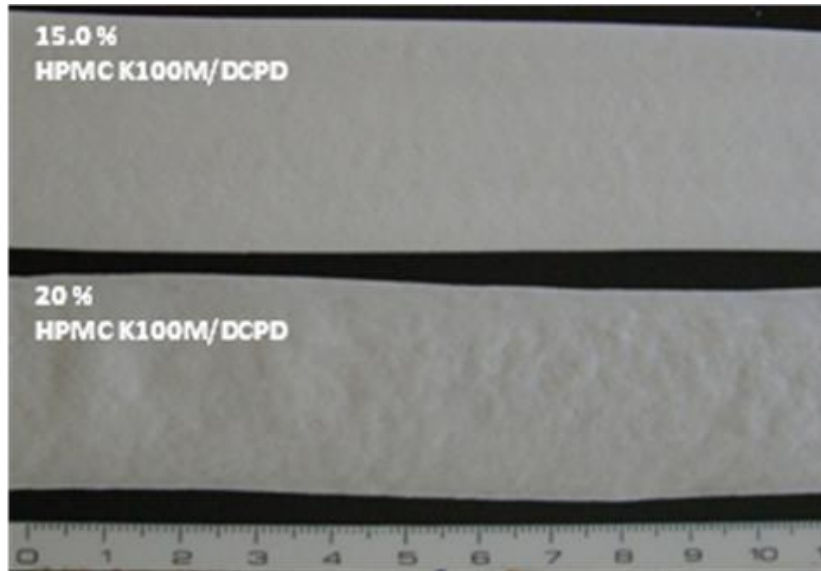

MELTREX

Seven steps in one

Melt extrusion – a single, continuous production process

Ideal for on-line monitoring and process control

Essentially, the melt extrusion process consists of an extruder and a shaping device – e.g. a calender. The extruder processes the drug together with a thermoplastic polymer and additional ingredients continuously, to produce a molten mass containing the drug. Subsequently the shaping device forms tablets, granules or pellets.

The resulting extrudates need only minimum further processing. If removal of edges or polishing is desired, it may be combined with film coating.

Continuous processes have a built-in operational advantage: they eliminate interfaces and reduce complexity; they are also well suited for on-line monitoring, which provides an ideal basis for process documentation and simplified quality control to meet all GMP requirements.

The extruder melts, mixes and conveys material within about one minute of passage time. By combining different types of screws and housing components the extruder can be adapted to meet various requirements.

The second key component of the system is the shaping device; it may be a calender for tablet production or rotating blades for manufacturing pellets.



A standard film coater is used to remove edges from the extrudate tablets.



Pellets suitable for filling capsules.

Continuous on-line weighing of the ingredients is carried out by a loss-in-weight feeder system. Mixing beforehand is unnecessary, as perfect homogeneity is achieved during melt extrusion.

Process data are supplied continuously by multiple sensors. The control unit provides process monitoring, feedback and documentation.

Conventionally, tablets are produced in batches. The process involves seven different steps and requires six different machines.

- Conventional
- Weighing
- Blending
- Granulation
- Drying
- Sifting
- Blending
- Tabletting

- Extrusion
- On-line weighing
- Extrusion
- Calendering
- Cooling

Melt extrusion combines the separate steps necessary in conventional tablet manufacture in a single, continuous process.



3. STRATIFICAZIONE SU NUCLEI PREFORMATI

a) RIVESTIMENTO CON LIQUIDO (SOLUZIONE DI PRINCIPIO ATTIVO)

**PROCESSO FACILE MA TEMPI LUNGHI
(3-10 ORE)**

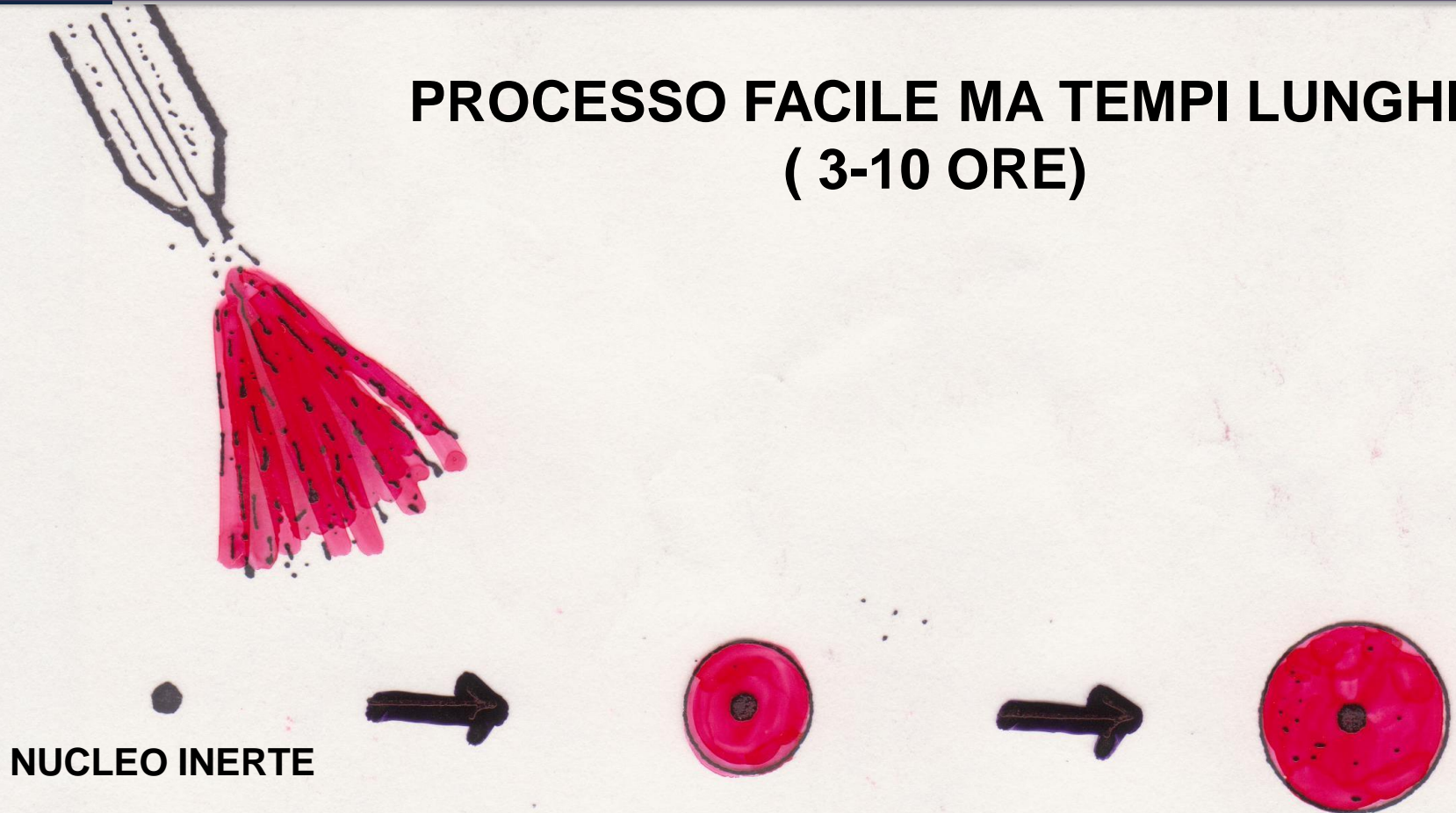

b) RIVESTIMENTO CON POLVERI

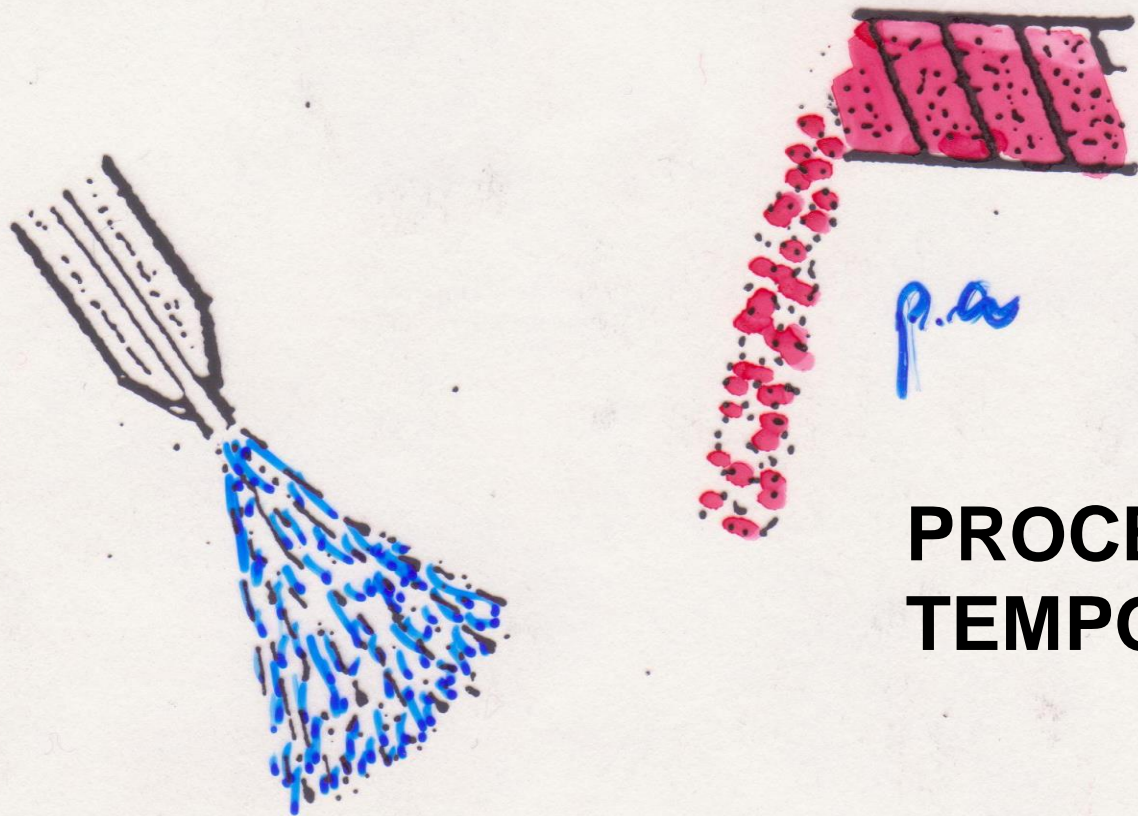

**PROCESSO NON FACILE
TEMPO BREVE (1 ORA)**

NUCLEO INERTE



Stratificazione

- ❑ **Materiali: nuclei preformati (saccarosio, CMC)**
- ❑ **P. attivo: in soluzione, sospensione o polvere**
- ❑ **Leganti: sostanze polimeriche e non**
- ❑ **Apparecchiature: bassine e letti fluidi**

P. Attivo in soluzione - sospensione

- letto fluido convenzionale (top spray)
- letto fluido con inserto Wurster (bottom spray)
- Rotogranulatore a letto fluido (tangential spray)
- Bassina convenzionale con unita' di spruzzo

P. Attivo in polvere

- Bassina convenzionale e rotogranulatore a letto fluido con dispositivi dedicati per distribuire dirette della polvere

NUCLEI PREFORMATI INERTI : SACCAROSIO



Sciropo caldo

**Amido
(antiaderente)**



**Saccaroso
(cristalli)**

...S, PELETS AND MICROGRANULES IN THE SAME PRA- IT
ED BY THE FORBUI ANON-IT

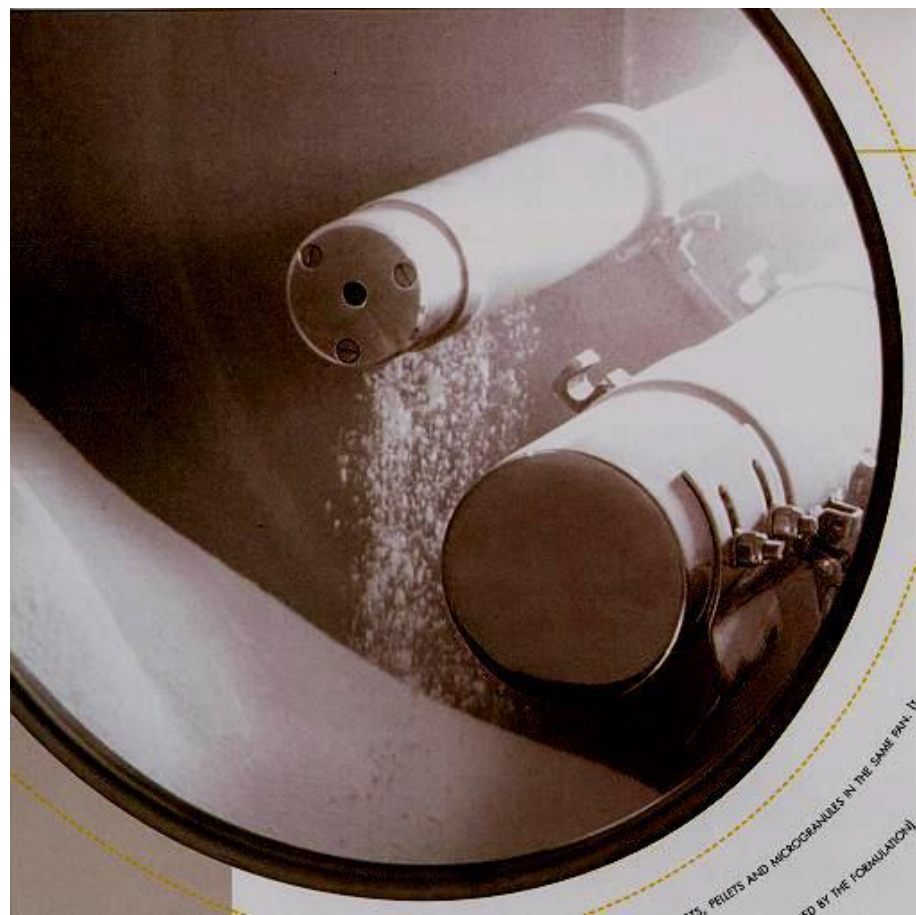
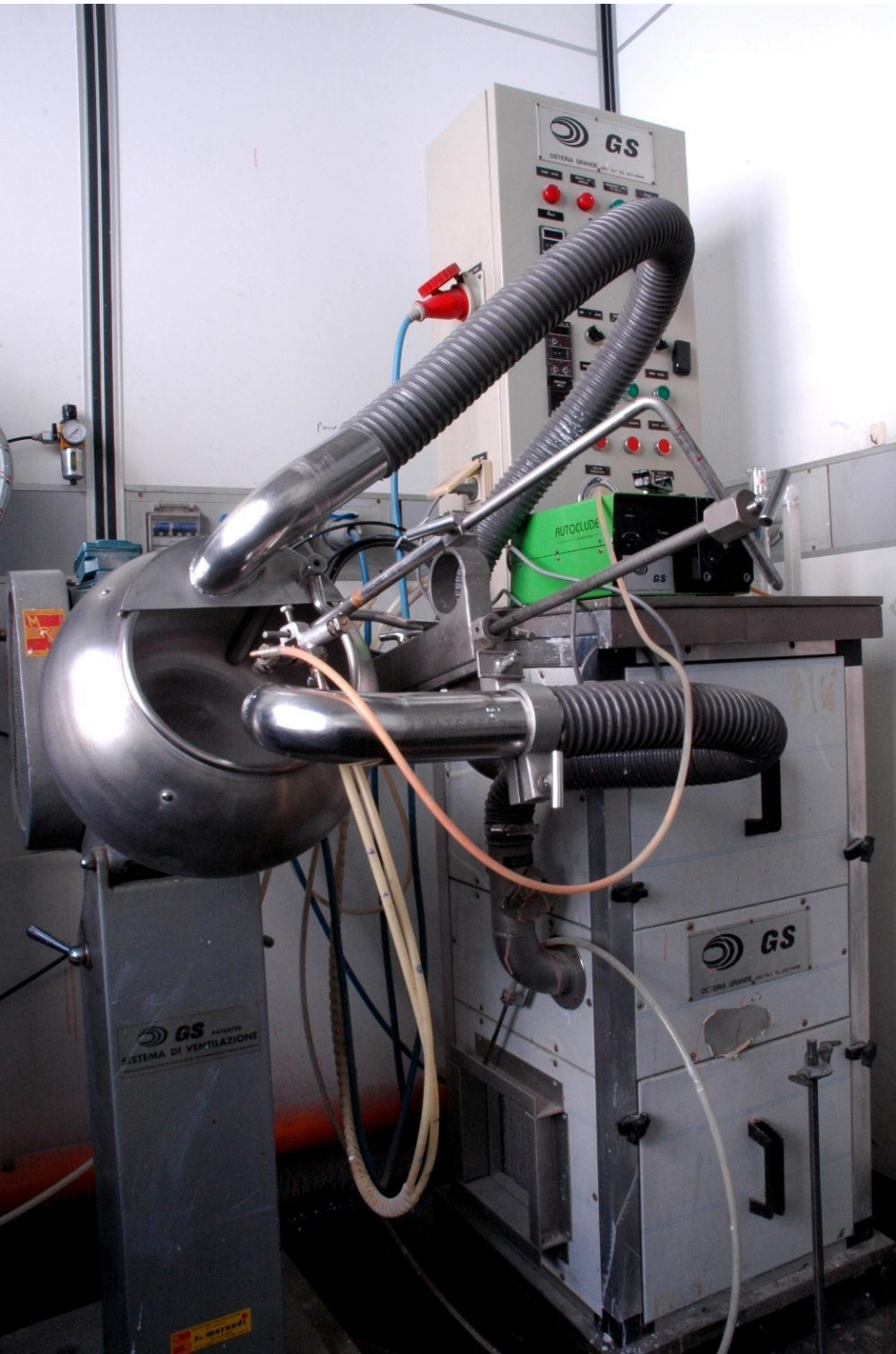

ROTOGRANULATORI

a) A CAMERA SINGOLA (SFERONIZZAZIONE, ESSICCAMENTO E RIVESTIMENTO NELLA STESSA CAMERA)

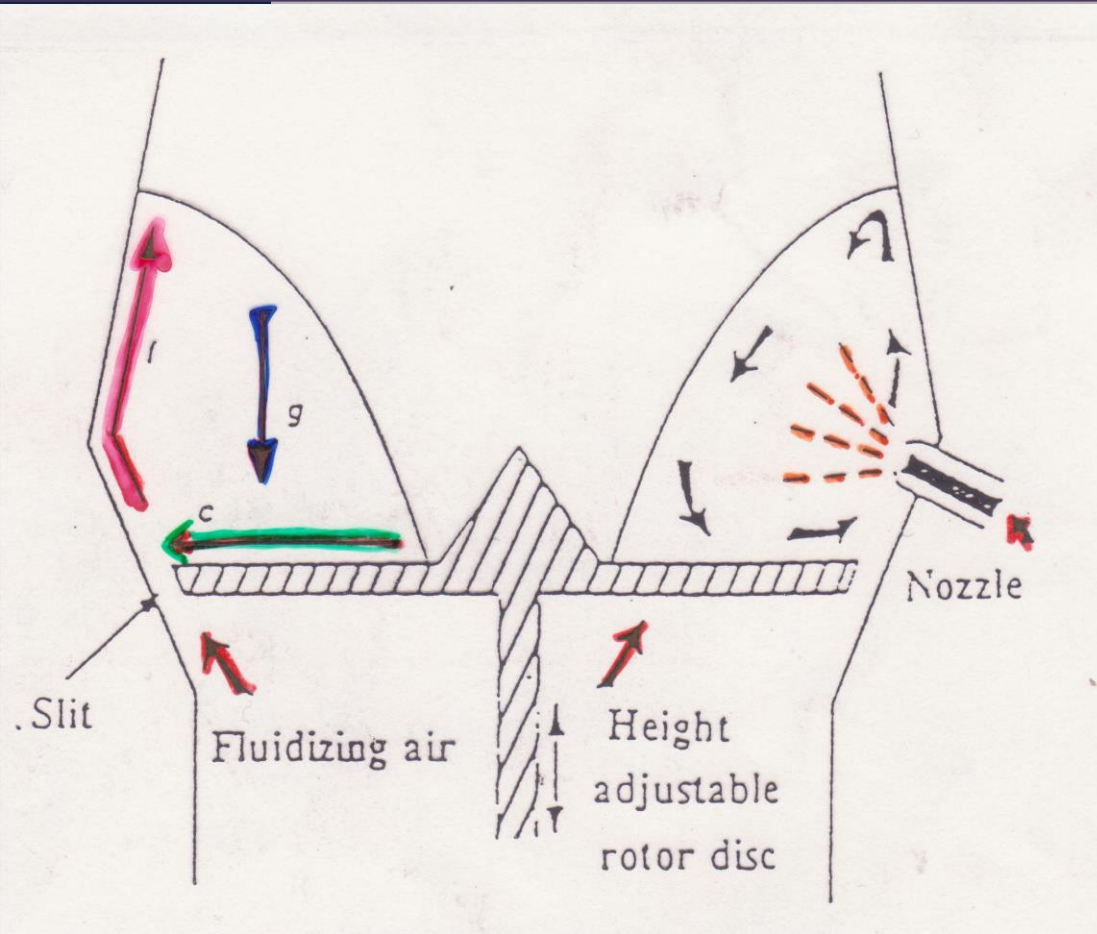

- **G – FORZA PESO**
- **C – FORZA CENTRIFUGA**
- **F – FORZA ARIA**

b) A CAMERA DOPPIA (CAMERA DI ESSICCAMENTO SEPARATA DALLA ZONA SFERONIZZAZIONE)

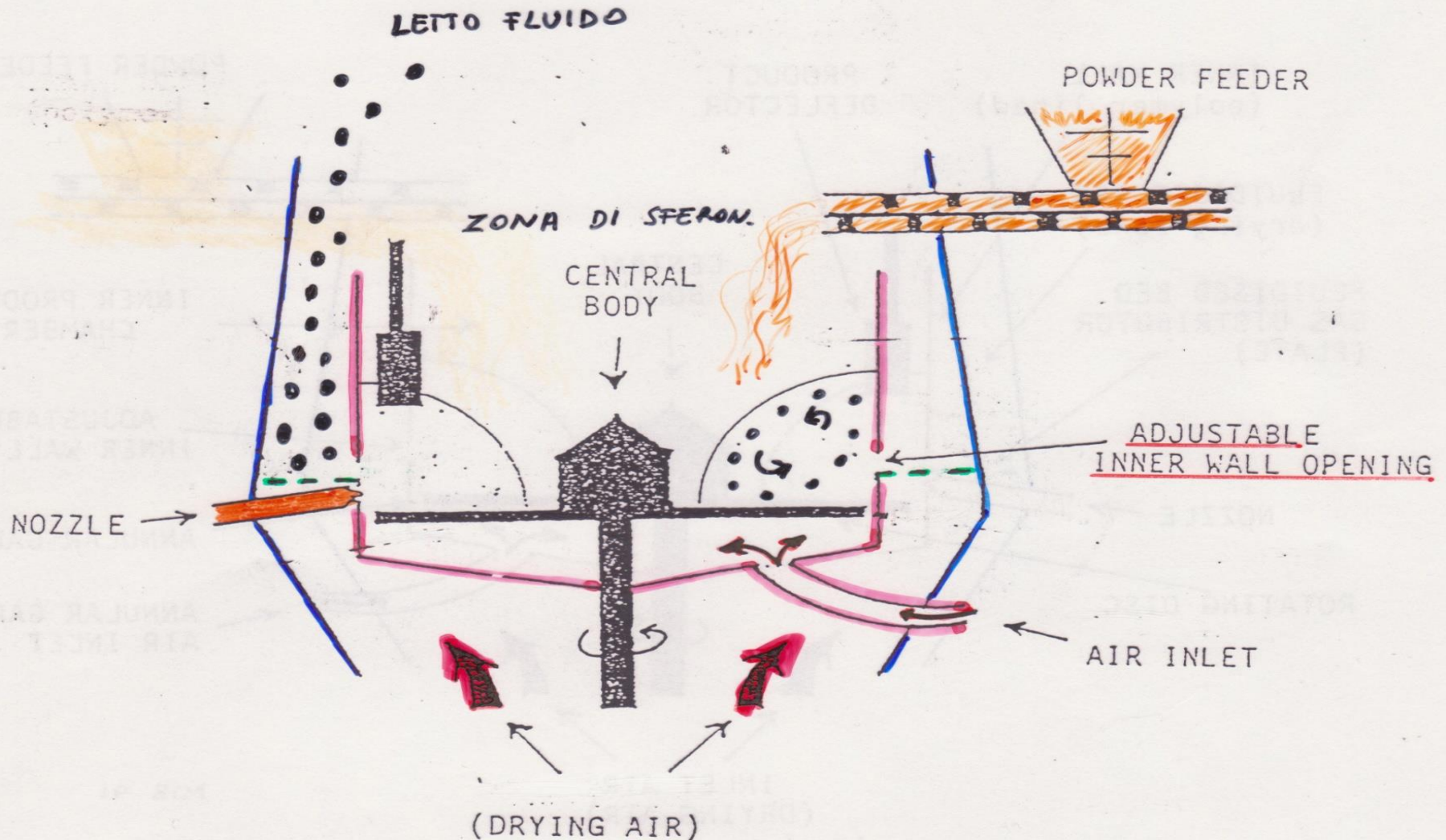





Inserto intercambiabile



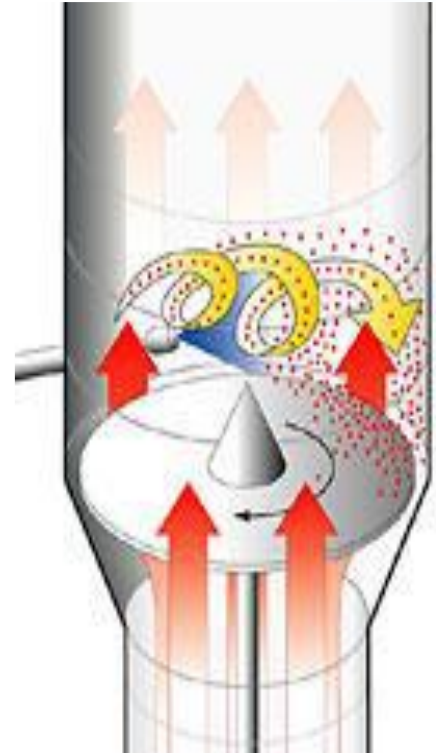
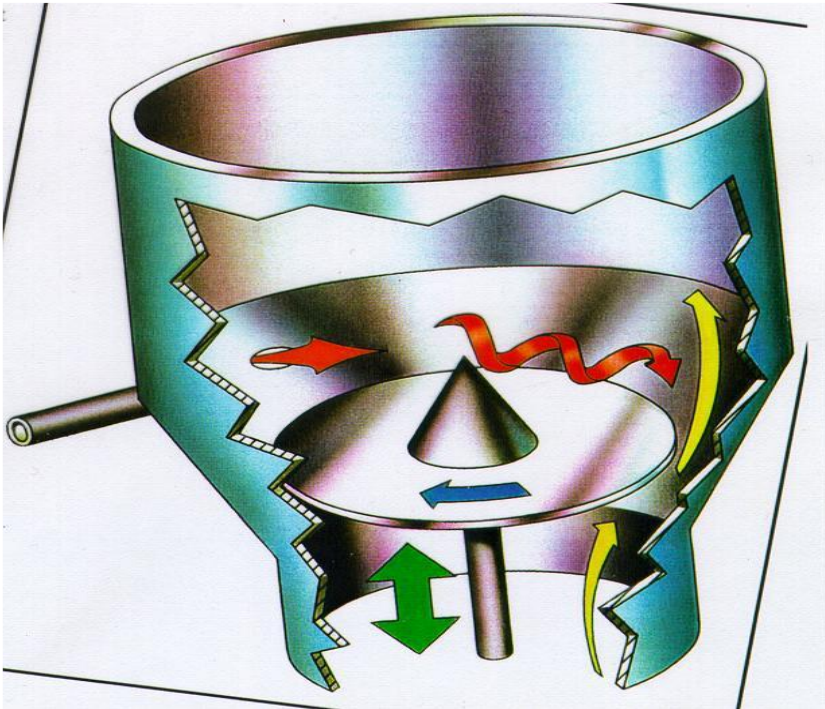



Stratificazione: sferette di saccarosio + mannitolo

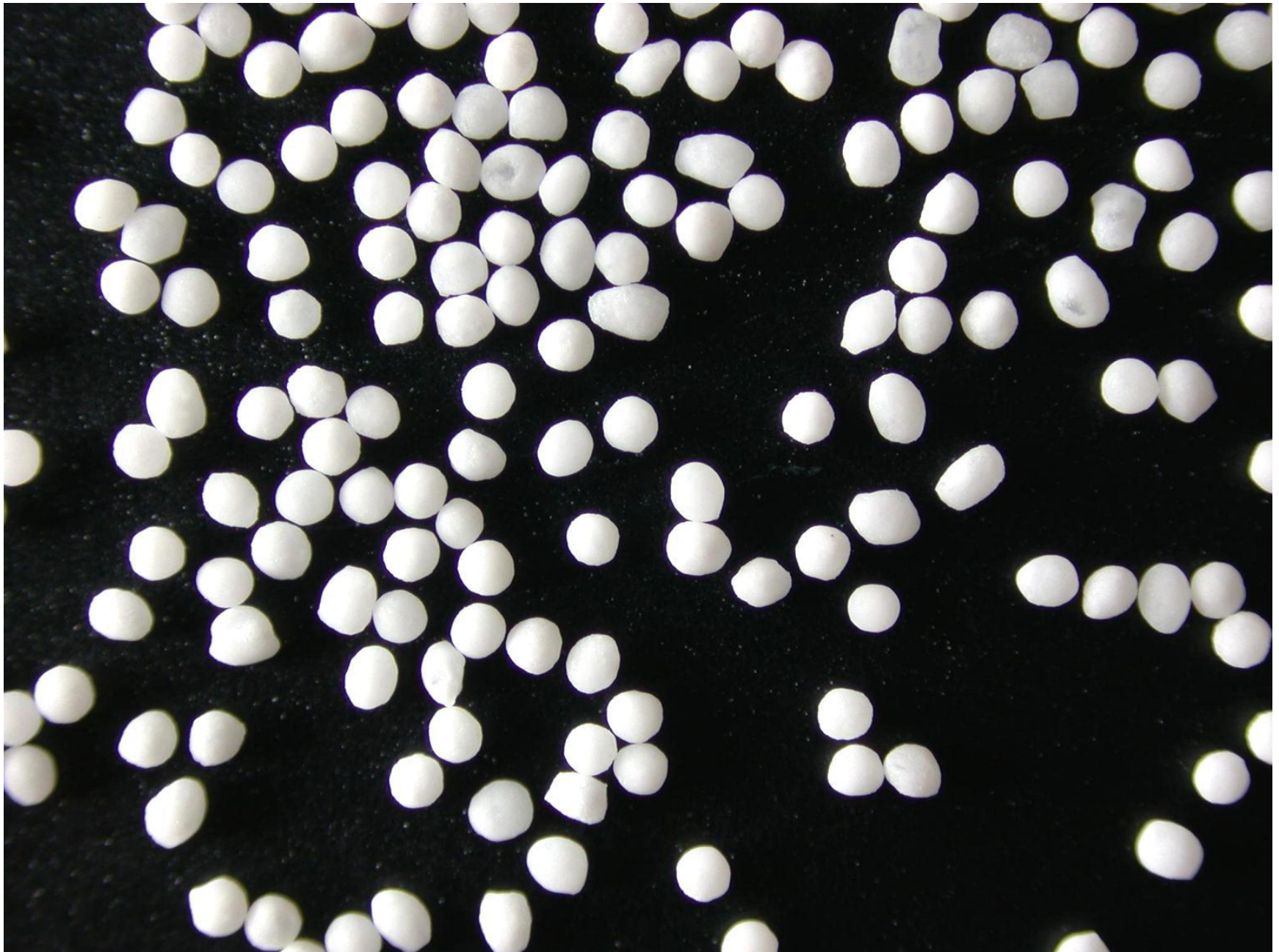

Stratificazione: sferette di saccarosio + ibuprofene



Stratificazione: chetopropene rivestito con sucralfato

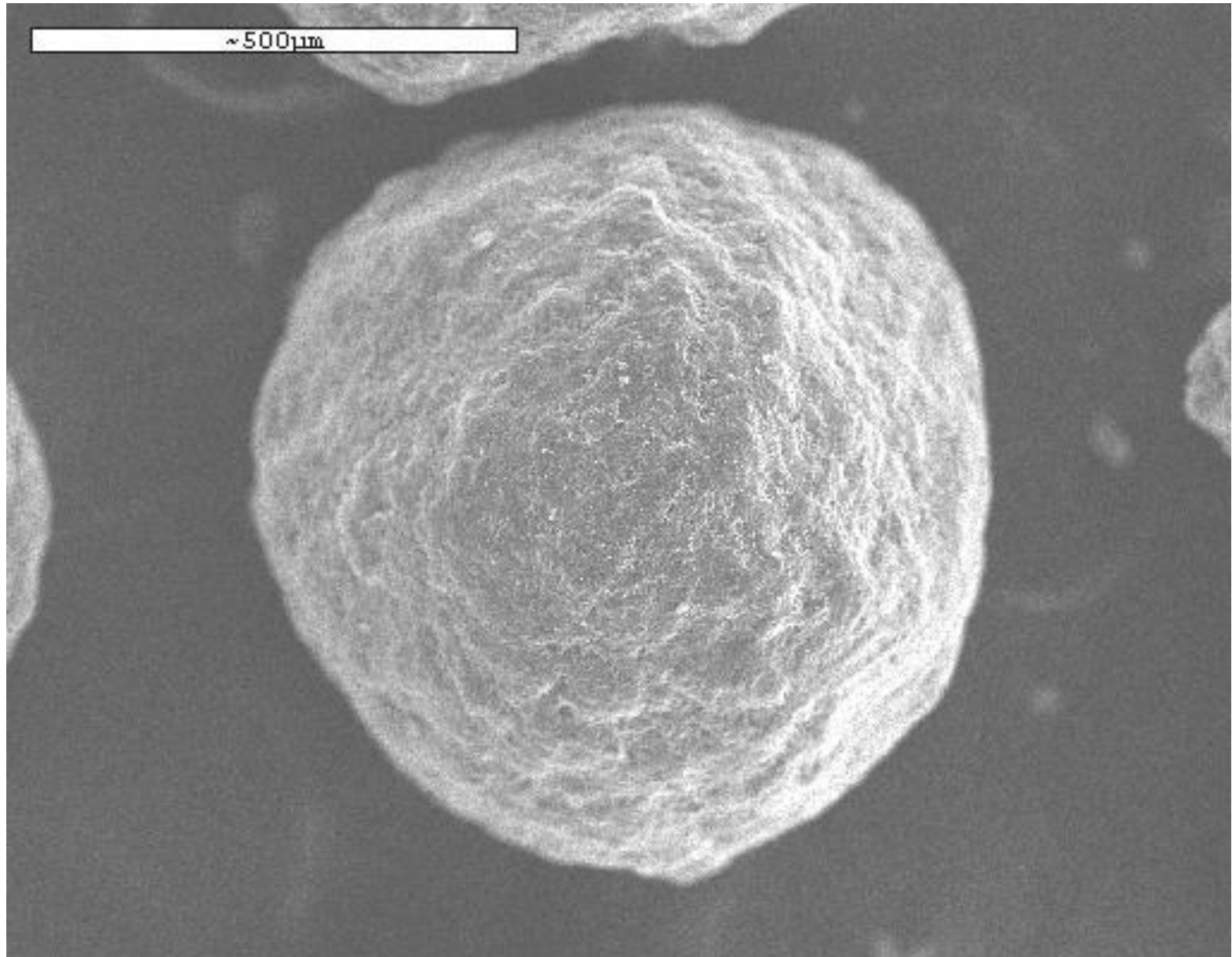

Schema delle procedure operative del rivestimento per

Stratificazione di polveri con un polimero gastroresistente (HPMCAS)

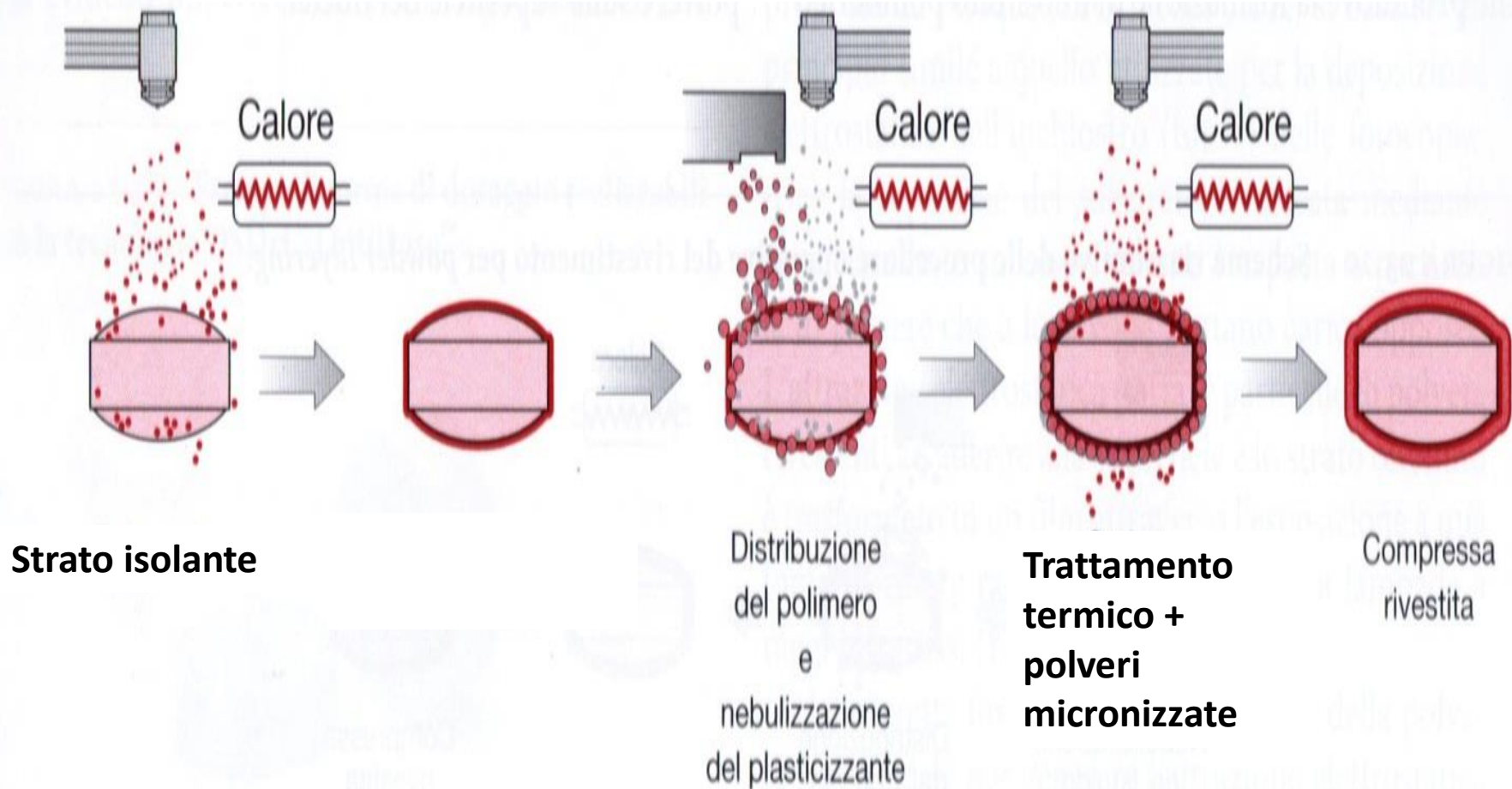

Schema riassuntivo del meccanismo di formazione del film per stratificazione di polveri

Deposizione
del polimero in polvere

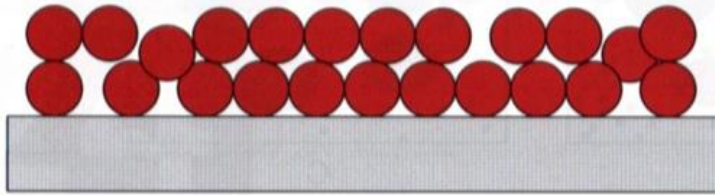

Coalescenza e
sintetizzazione



Livellamento



Raffreddamento



Rivestimento per fusione:

- Esteri di Glicerolo;
- Oli vegetali idrogenati
- Alcoli a lunga catena
- PEG
- Cere naturali sintetiche

Stratificazione

❑ Aspetti favorevoli:

- **tecniche semplici e consolidate**
- **uniformità dimensionale**
- **soddisfacenti caratteristiche meccaniche**
- **processo riproducibile**
- **rivestimento nella stessa apparecchiatura**

❑ Aspetti critici:

- **p. attivo a contatto con liquidi (solubilità)**
- **tempi di processo lunghi**
- **necessità di mix di polveri scorrevoli e bagnabilità**

Respicur 400 mg

capsule rigide a rilascio prolungato

teofillina

30 capsule

Uso orale



**ECCIPIENTI: PELLETS DI ZUCCHERO (SACCAROSIO,
AMIDO DI MAIS, SCIROPPO DI GLUCOSIO**

GRANULATI EFFERVESCENTI

3 : 5



Bicarbonati
o
Carbonati

+

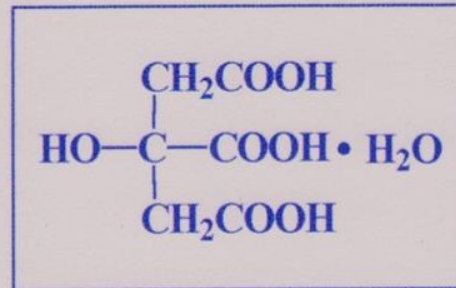

20-25% monoidrato

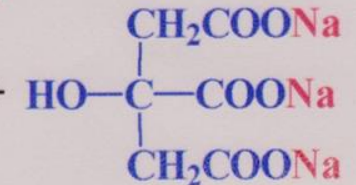
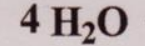

CARBONATI

Sodio Bicarbonato
Sodio Carbonato
Potassio Bicarbonato
Potassio Carbonato
Lisina Carbonato

COMPONENTI ACIDI

Acido Citrico
Acido Tartarico
Acido Malico
Acido Fumarico
Acido Adipico
Acido Succinico

SALI ACIDI

Sodio Fosfato Monobasico

PREPARAZIONE:

- 1. GRANULAZIONE CON CALORE SENZA AGGIUNTA DI SOLVENTI, SFRUTTANDO L'ACQUA DI IDRATAZIONE PRESENTE NEI MATERIALI UTILIZZATI (GRANULATORI RAPIDI- LETTO FLUIDO)**
- 2. GRANULAZIONE AD UMIDO IN PRESENZA DI SOLVENTI NON ACQUOSI QUALI EtOH ANIDRO O ALCOOL ISOPROPILICO**
- 3. GRANULAZIONE CON MINIME QUANTITÀ DI ACQUA (0,5 %)**
- 4. GRANULAZIONE SEPARATA DEI COMPONENTI ACIDI DA QUELLI BASICI (ROTOGRANULATORE)**

Figure 1 Manufacture of alkaline spheres by rotogranulation.

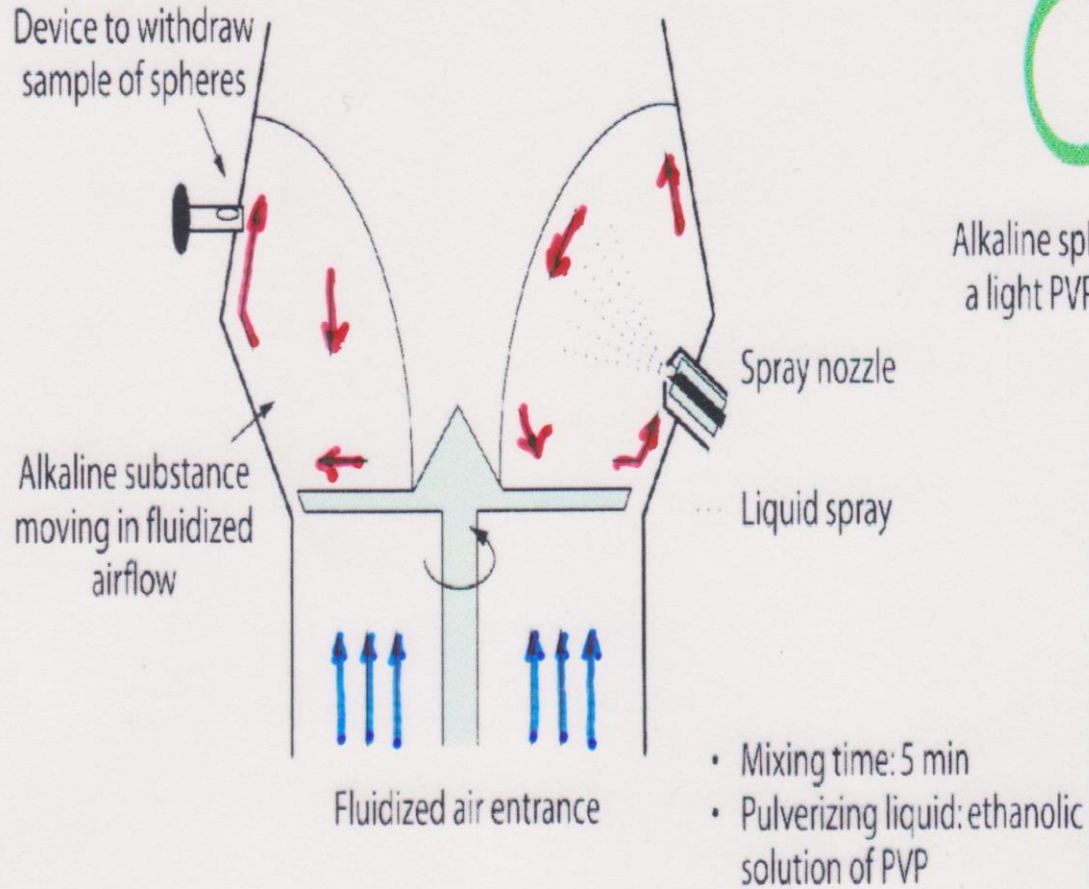

Alkaline sphere with a light PVP coating

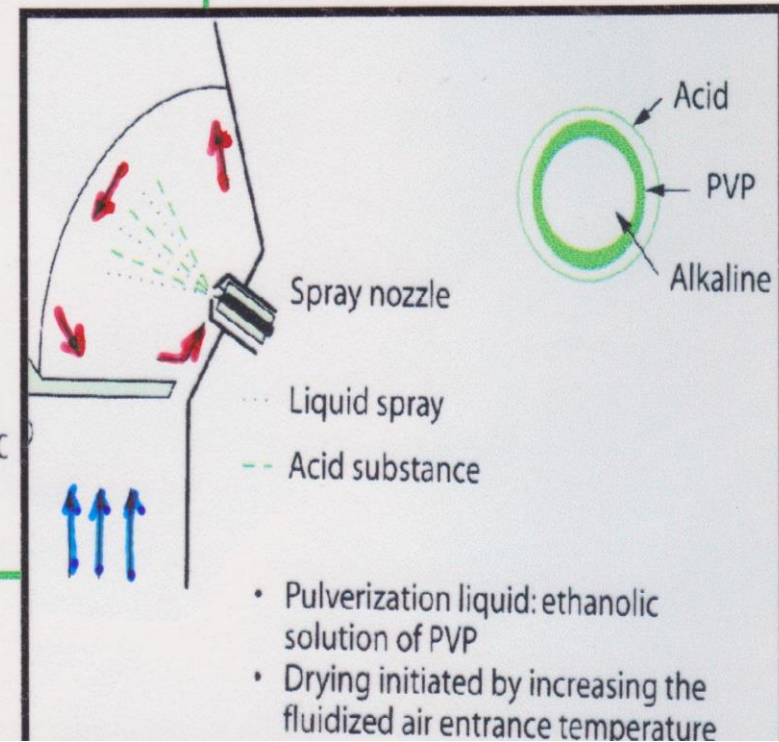

CONFEZIONAMENTO:

LOCALI AD UMIDITÀ
CONTROLLATA

CONTENITORE A PROVA DI
UMIDITÀ (GEL DI SILICE,
SOLFATO DI CALCIO ANIDRO,
FOGLI DI ALLUMINIO)

TACCHIPIRINA® 500 mg GRANULATO EFFERVESCENTE

PRINCIPIO ATTIVO:

PARACETAMOLO 500 mg

ECCIPIENTI:

**E965 – MALTILOLO
E421 – MANNITOLO
SODIO BICARBONATO
ACIDO CITRICO
AROMA AGRUMI
E 951 – ASPARTAME
SODIO DOCUSATO**

Drug Discovery and Development

Molecules to Materials to Medicines

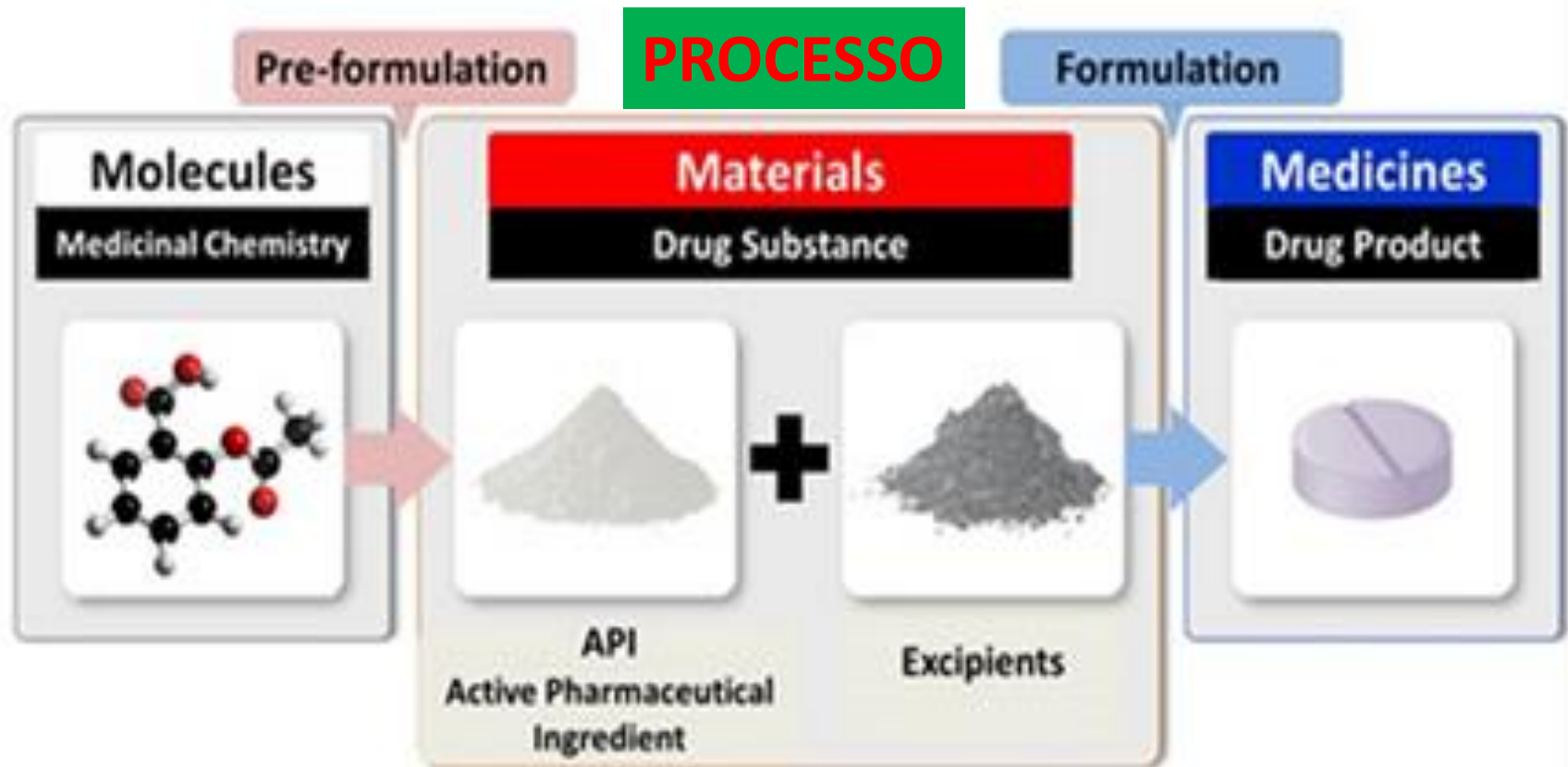

3. ESSICCAMENTO

ESSICCAMENTO

- RIMOZIONE DELL'ACQUA (O ALTRO LIQUIDO) DA UNA MASSA SOLIDA O SEMISOLIDA MEDIANTE EVAPORAZIONE (ESSICCATORI)
- ACQUA (O SOLVENTE) LEGATA
- ACQUA NON LEGATA
- CONTENUTO DI ACQUA (UMIDITÀ) LIBERA (PRIMA ESSICCAMENTO) - H_i
- CONTENUTO IN ACQUA (O UMIDITÀ) ALL'EQUILIBRIO (DOPO ESSICCAMENTO) - H_f

CLASSIFICAZIONE DEGLI ESSICCATORI

**ARMADIO
(STUFA)**

LETTO FLUIDO

**GRANULATORI
RAPIDI**



ESSICCAMENTO: TRASFERIMENTO DI CALORE E MATERIA

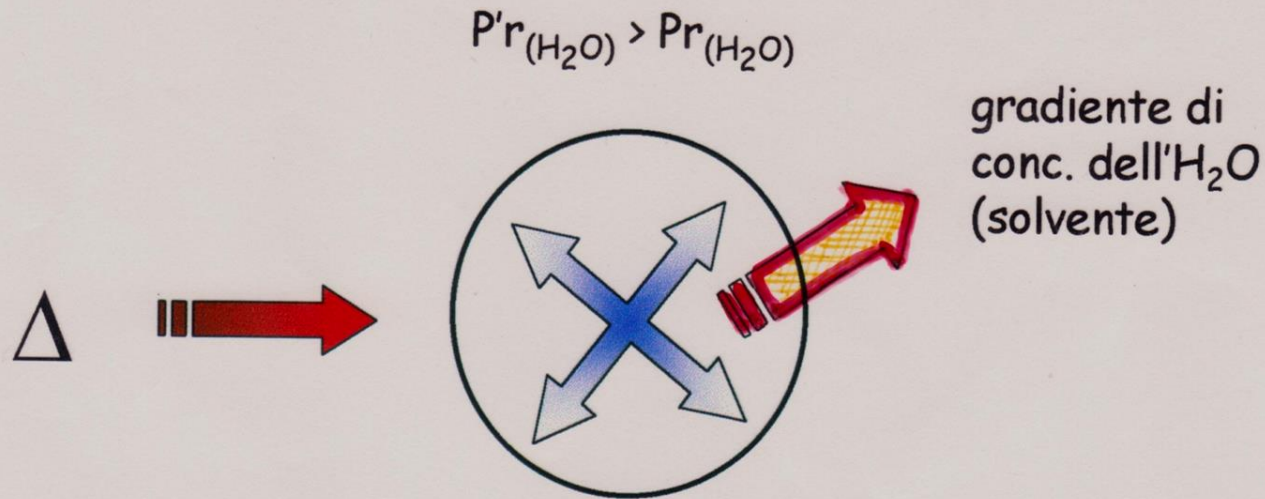

Fattori che influenzano la velocità d'essiccamento:

- temperatura
- flusso aria
- umidità relativa
- dimensioni delle particelle
- grado d'agitazione del letto di particelle
- tipo di supporto del granulato
- contatto fra i granuli ed il mezzo preposto all'essiccamento

TEMPO DI ESSICCAMENTO

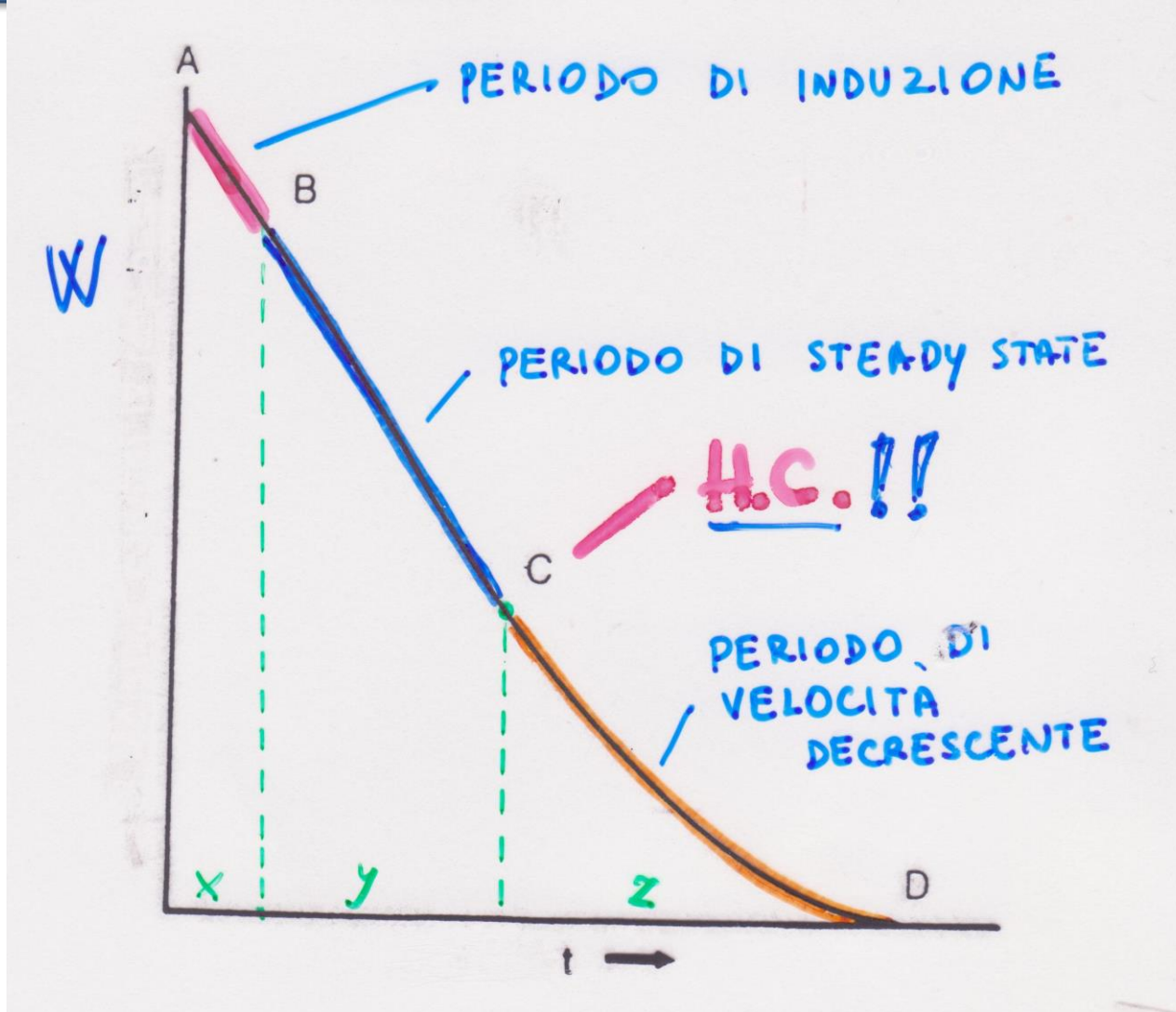

PROFILO DI ESSICCAMENTO

CONTENUTO DI UMIDITÀ CRITICA (NATURA DEL MATERIALE, VELOCITÀ DI ESSICCAMENTO E DIMENSIONI).

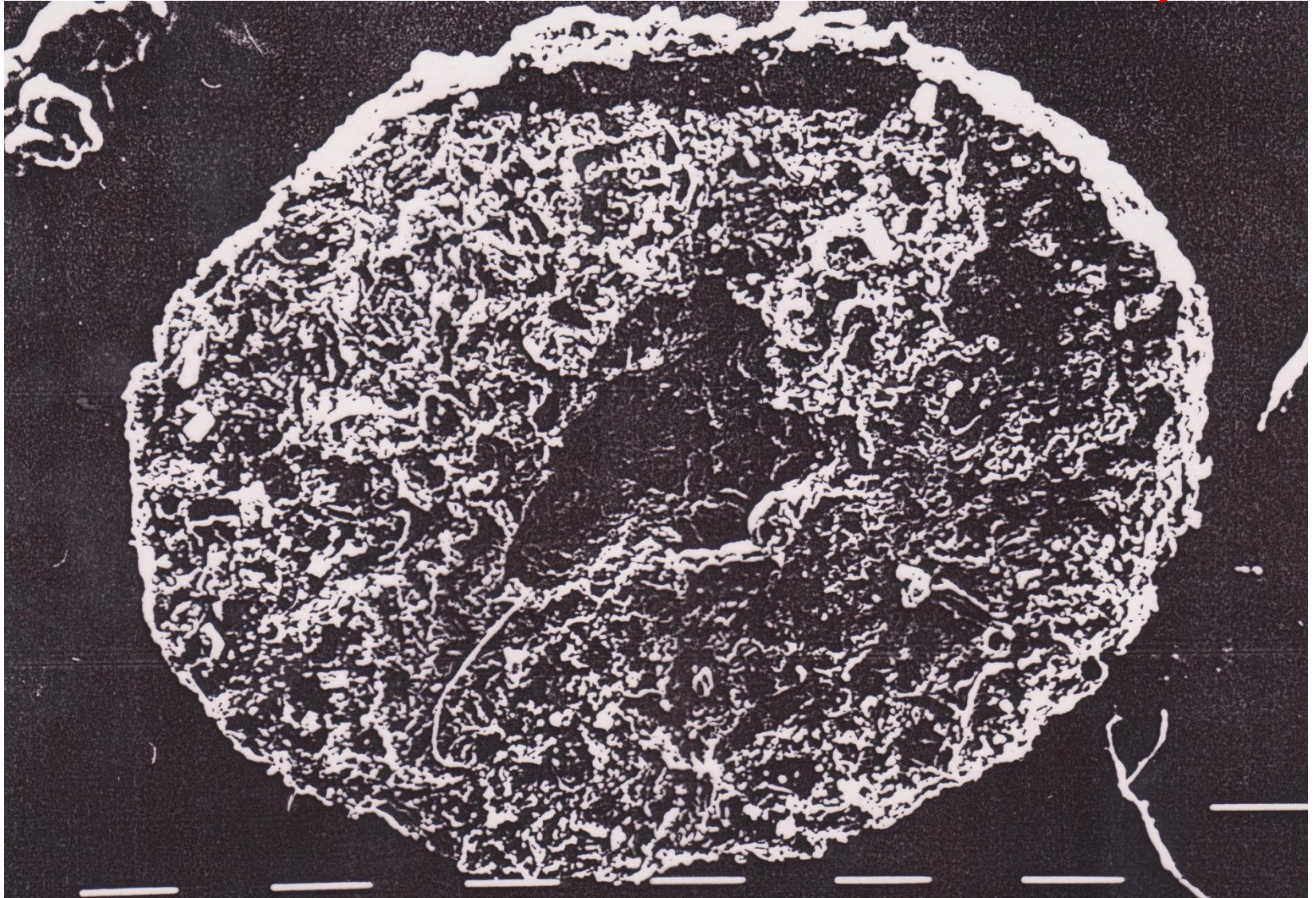

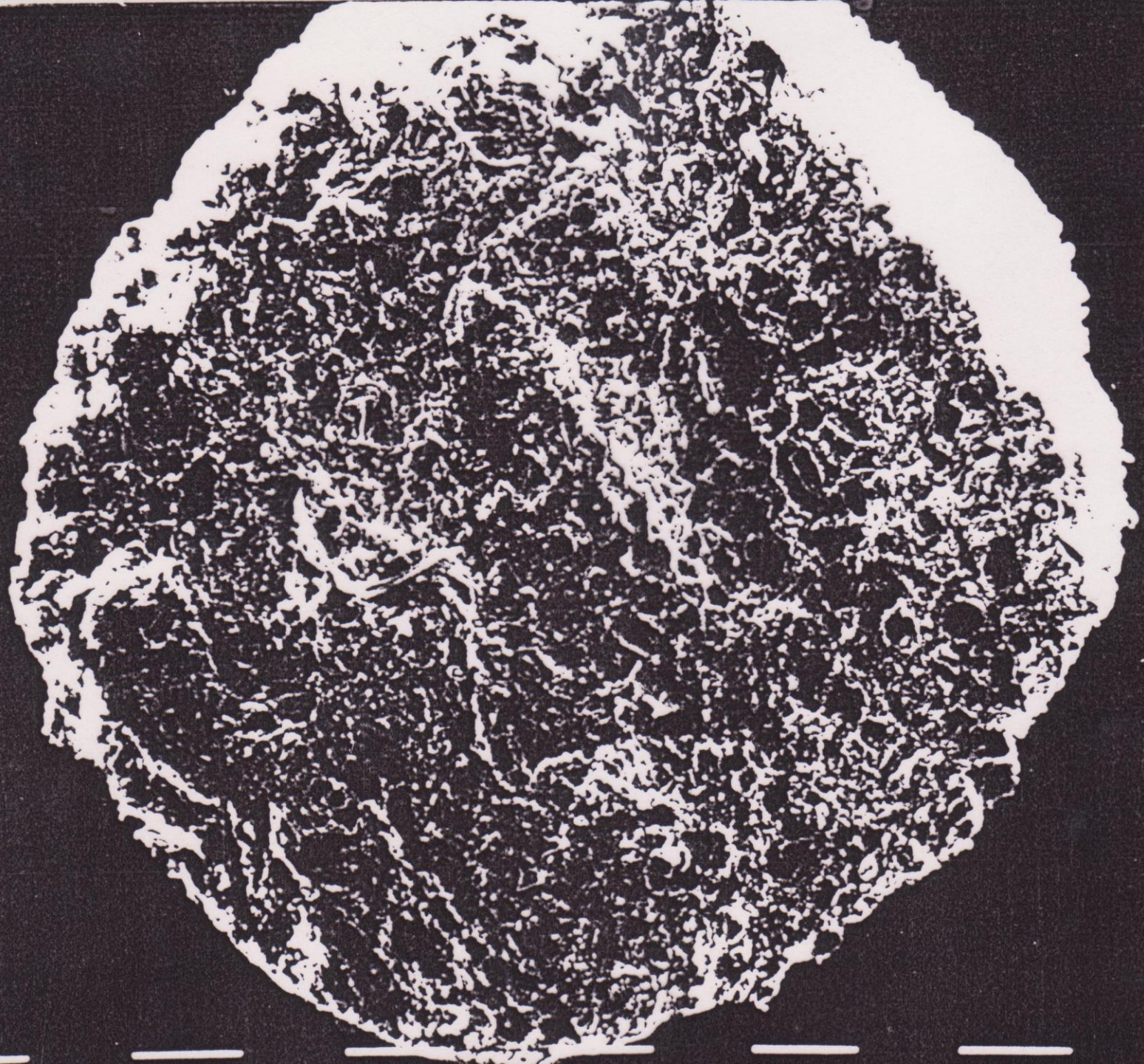

RAPPRESENTAZIONE GRAFICA

100 g

W_0

W_t

80 g

W_∞

$T(h)$

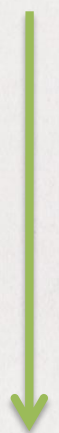

TEMPO DI ESSICCAMENTO

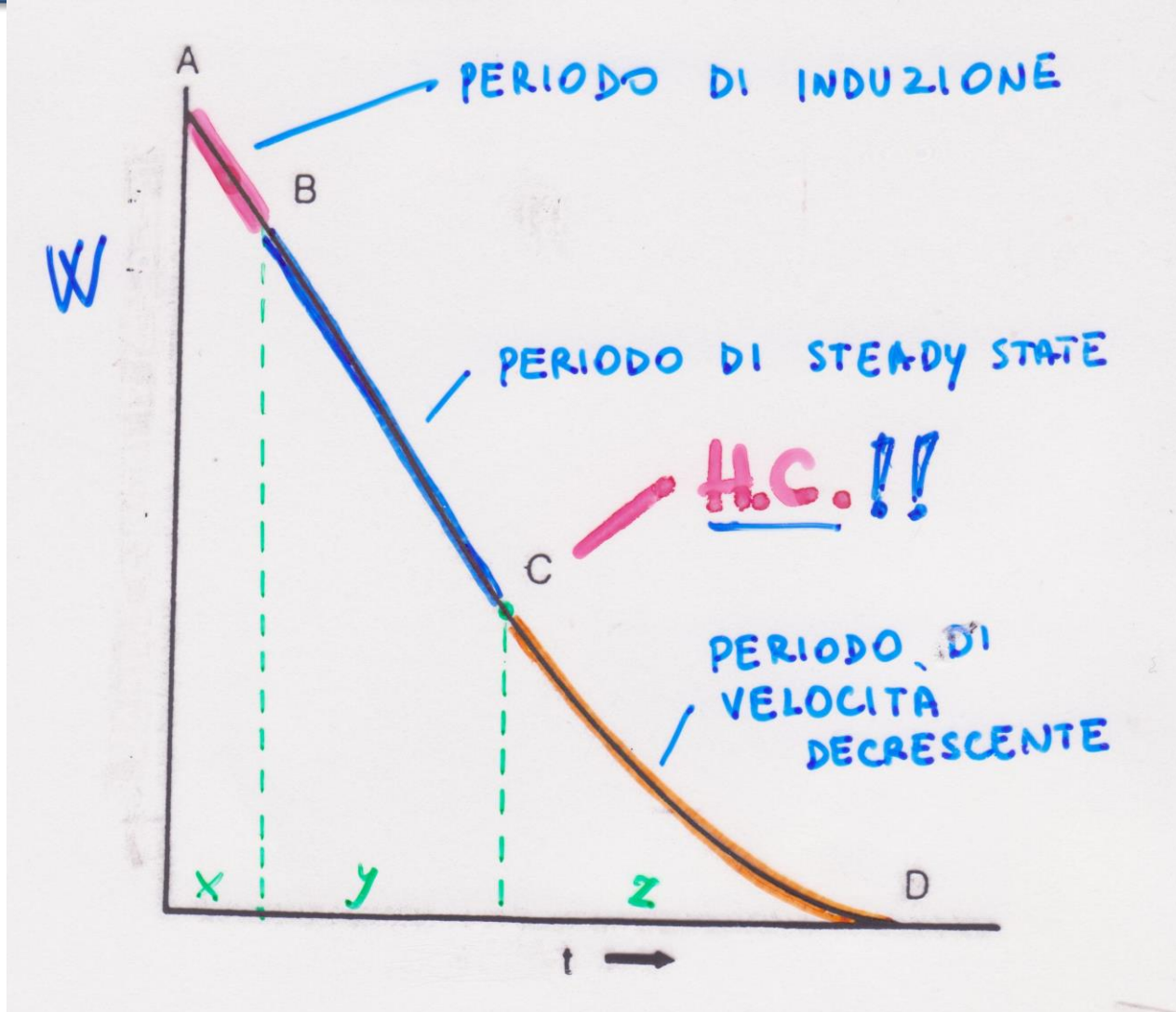

PROFILO DI ESSICCAMENTO

$$\ln \left[\frac{(W_t - W_\infty)}{(W_0 - W_\infty)} \right] = -kt$$

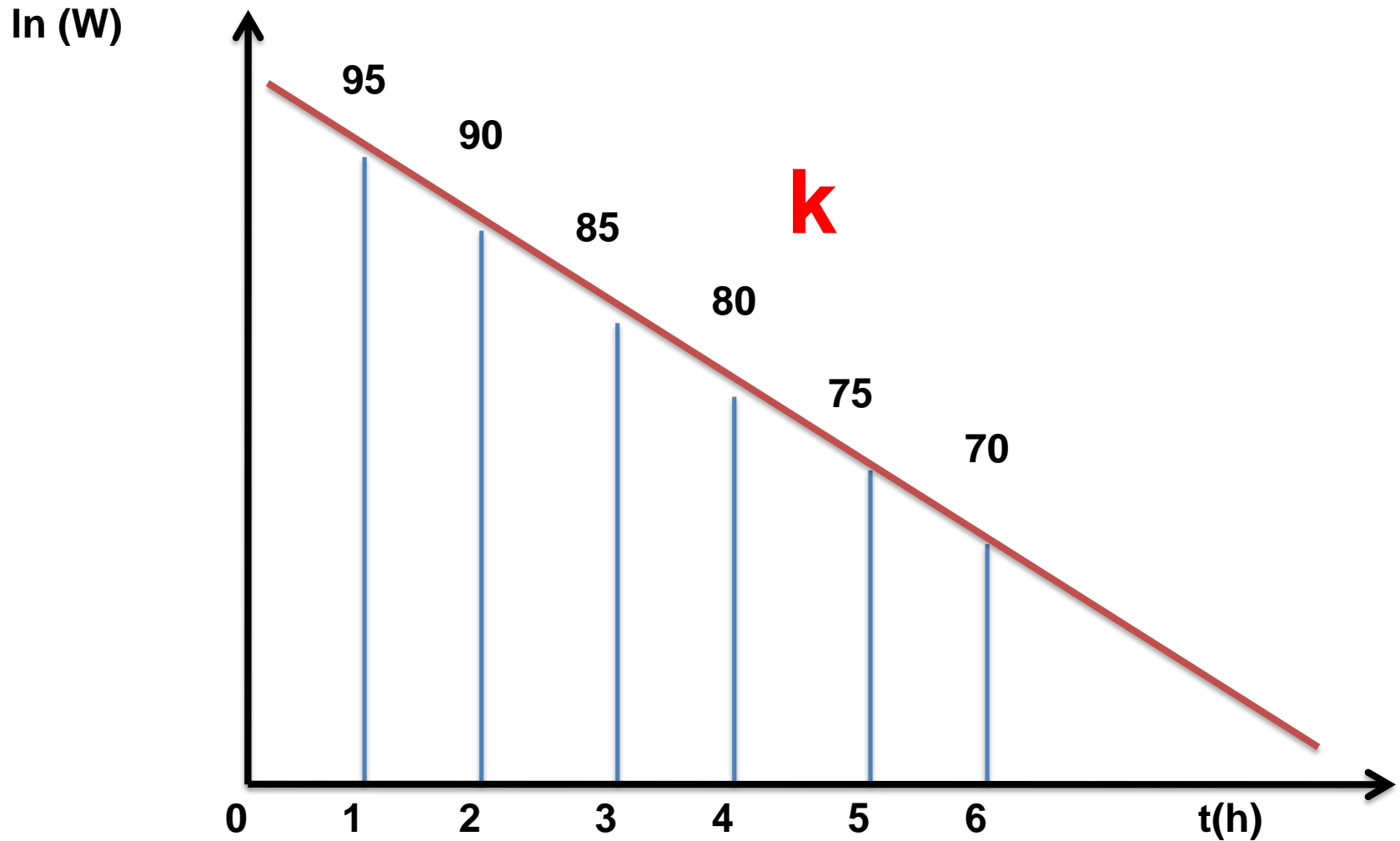

ESEMPIO:

$$100 \text{ g } (W_0) \xrightarrow{\triangle} 80 \text{ g } (W_\infty)$$
$$90 \text{ g } (W_t) \text{ t}=3\text{h}$$

$$W_0 - W_\infty = 100 - 80 = 20 \text{ g}$$

$$W_t - W_\infty = 90 - 80 = 10 \text{ g}$$

$$\ln [10/20] = \ln [0.5] = -0.69$$

$$0.69 = kt_{50}$$

$$k = 0.69/3 = 0.23 \text{ h}^{-1}$$

$$T_{50} = 0.69/0.23 = 3 \text{ h}$$

k DIPENDE DALL'IMPIANTO

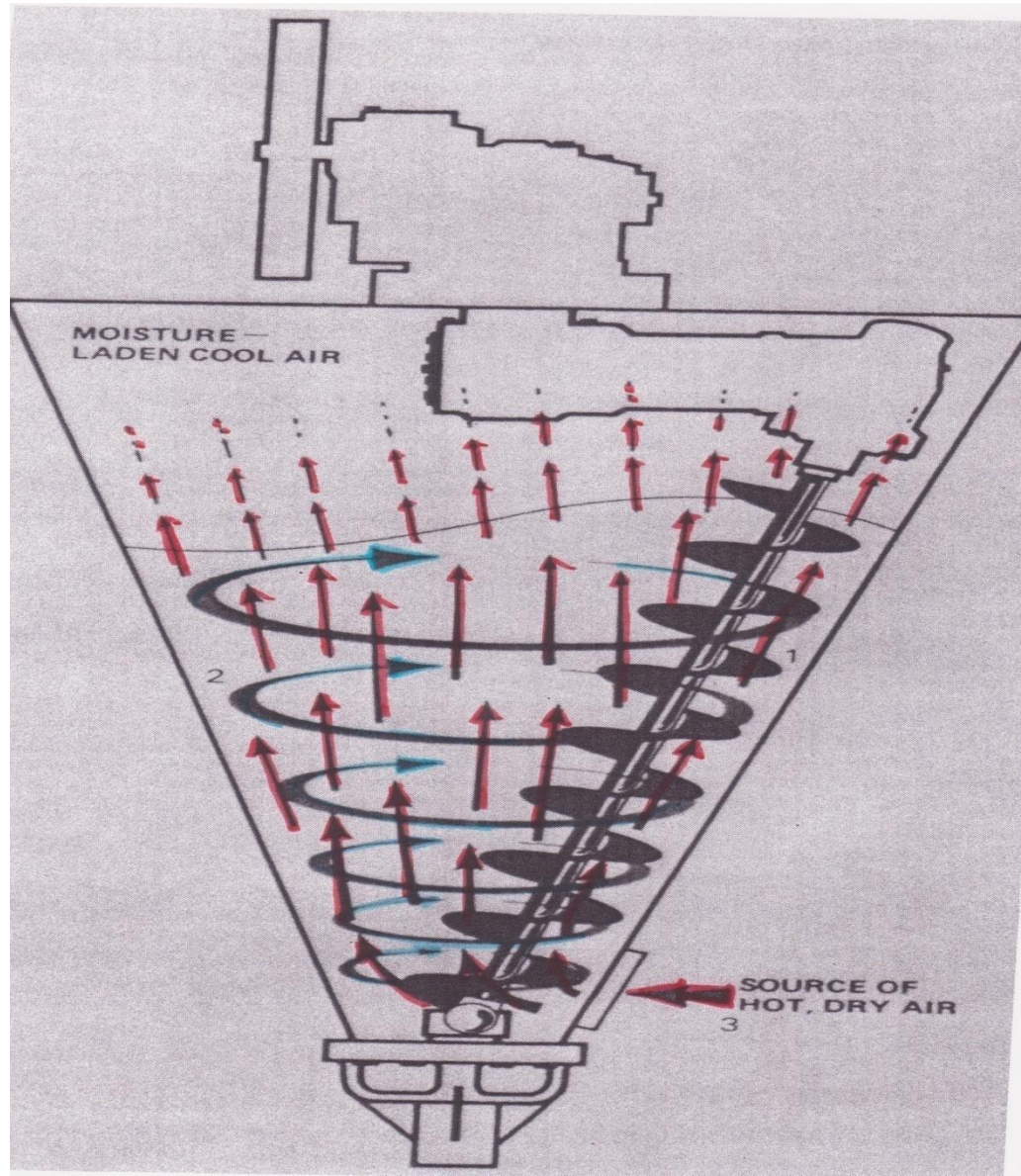

CONTROLLO DEL PRODOTTO:

- ESAME GRANULOMETRICO (DA 90 μm A 2 mm; FINO NON SUPERIORE AL 10%)
- FRIABILITÀ
- VOLUME AL VERSAMENTO/SCUOTIMENTO E DENSITÀ
- POROSITÀ (DISGREGAZIONE)
- AREA SUPERFICIALE (INFLUISCE SULLA VELOCITÀ DI DISSOLUZIONE)
- CARATTERISTICHE DI SCORRIMENTO
- **UMIDITÀ (3-5%)**
- OMOGENEITÀ (DOSAGGIO P.A. SAGGI F.U.)

UNIFORMITÀ DI CONTENUTO
DELLE FORME
FARMACEUTICHE A DOSE
UNICA



DOSE \pm 15%
SCARTO MASSIMO

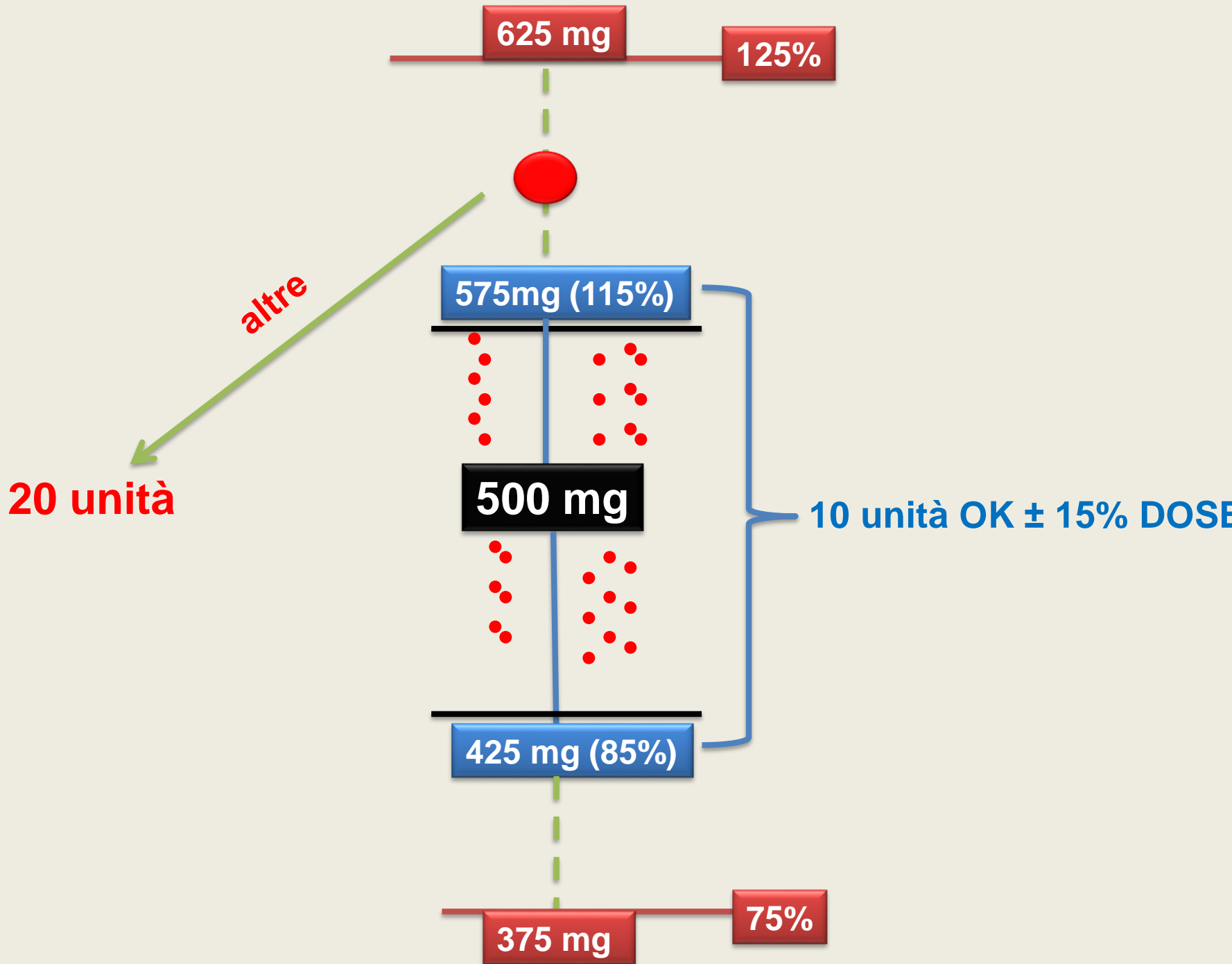

LIOFILIZZAZIONE (ESSICCAMENTO DI PRODOTTI TERMOLABILI)

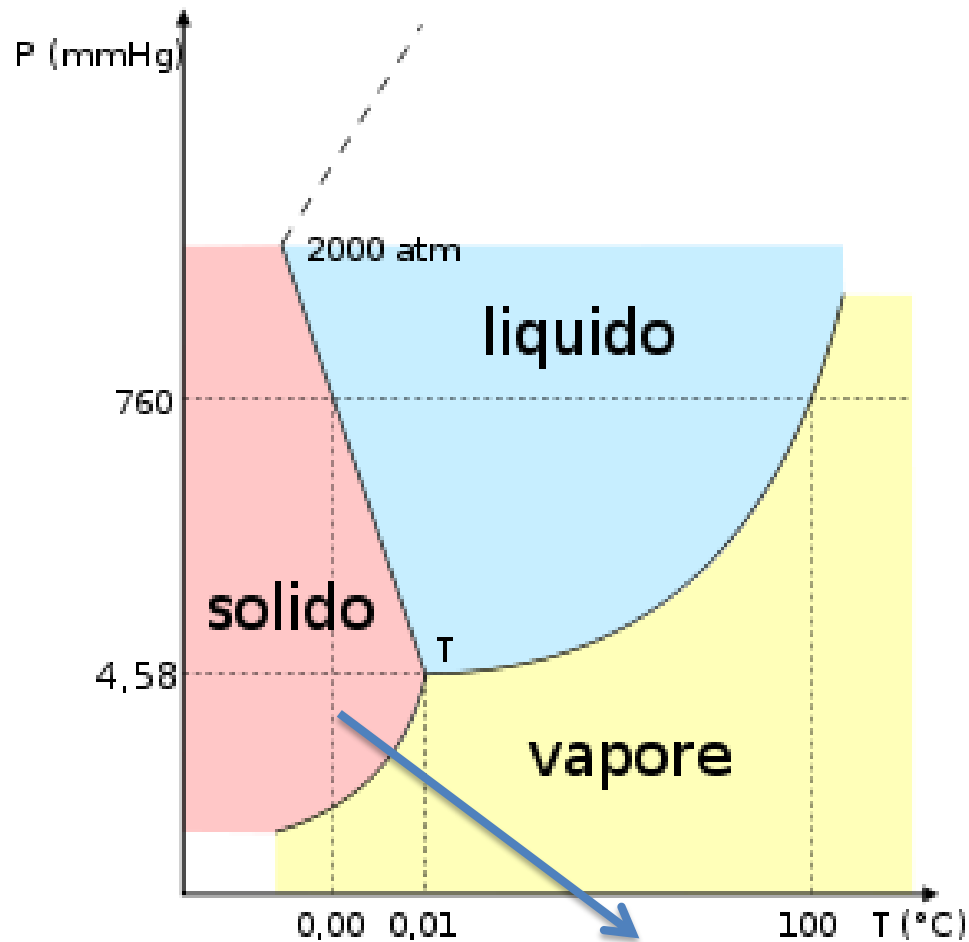

SUBLIMAZIONE

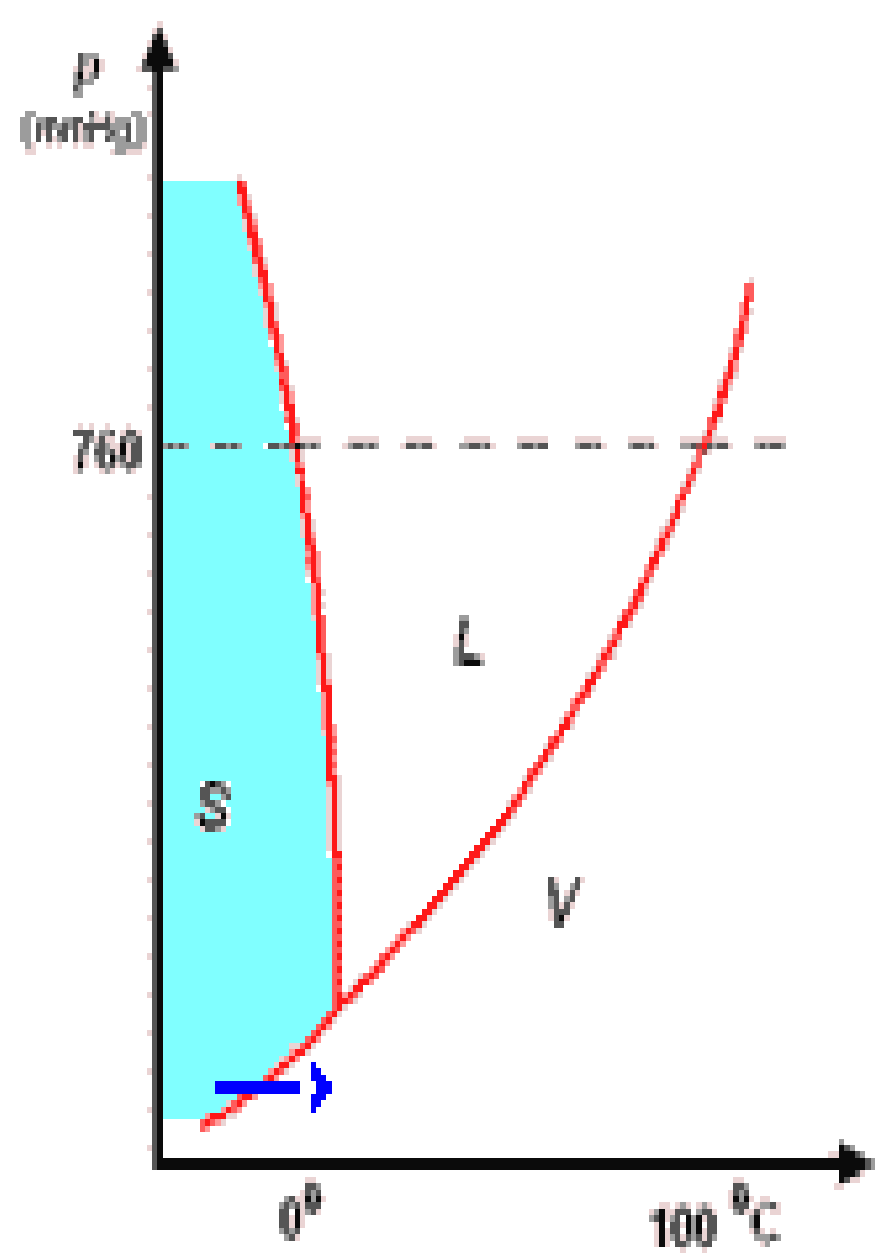
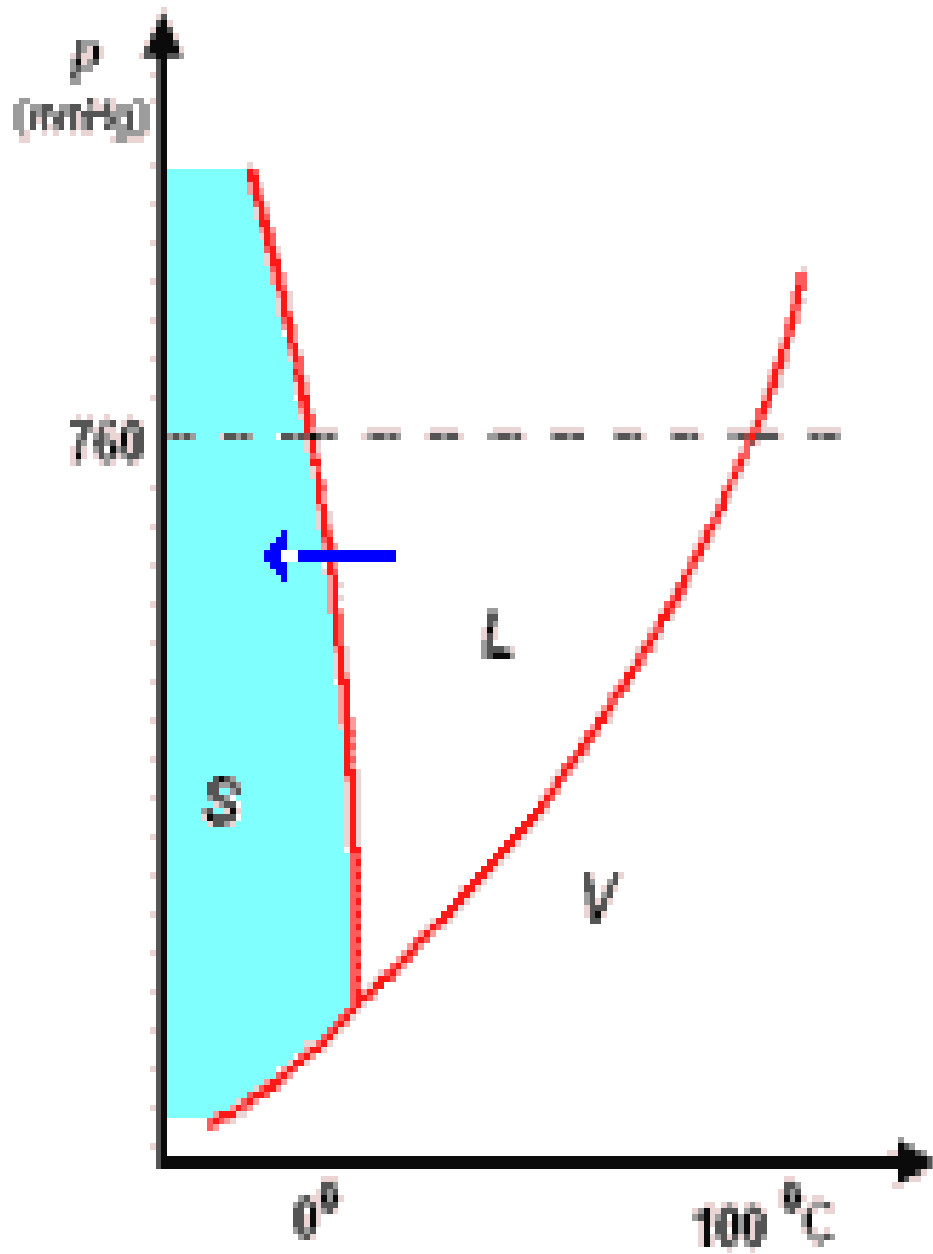

PRODOTTO:

➤ **POROSO, FRIABILE, IGROSCOPICO.**



➤ **VOLUME APPARENTE UGUALE ALLA
SOLUZIONE DI PARTENZA**

LIOFILIZZATORE INDUSTRIALE

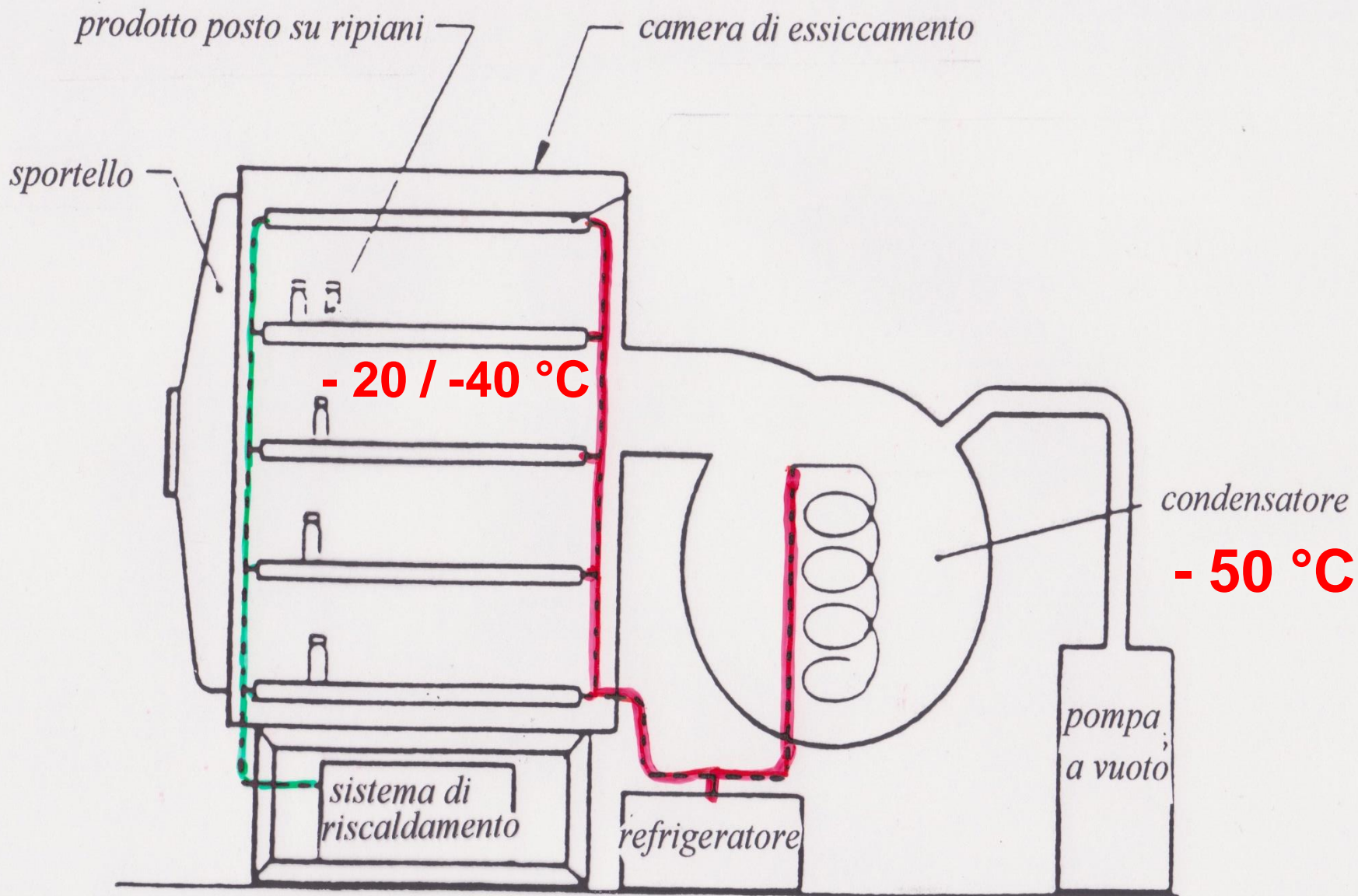

- **Non uniformità delle condizioni operative (temperatura piastre, pressione)**
- **Capacità apparecchiatura (chokingflow)**

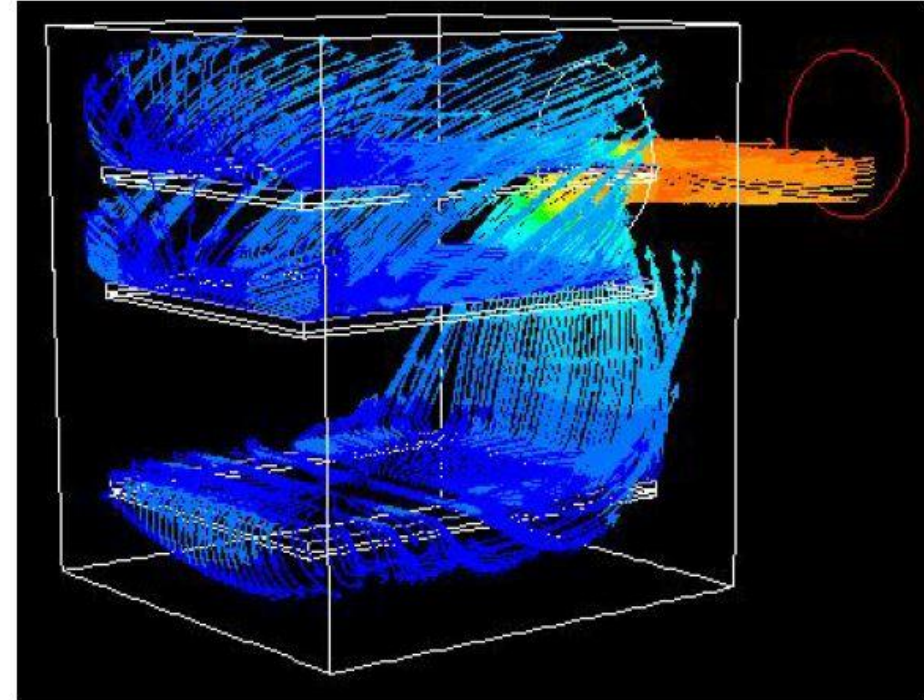
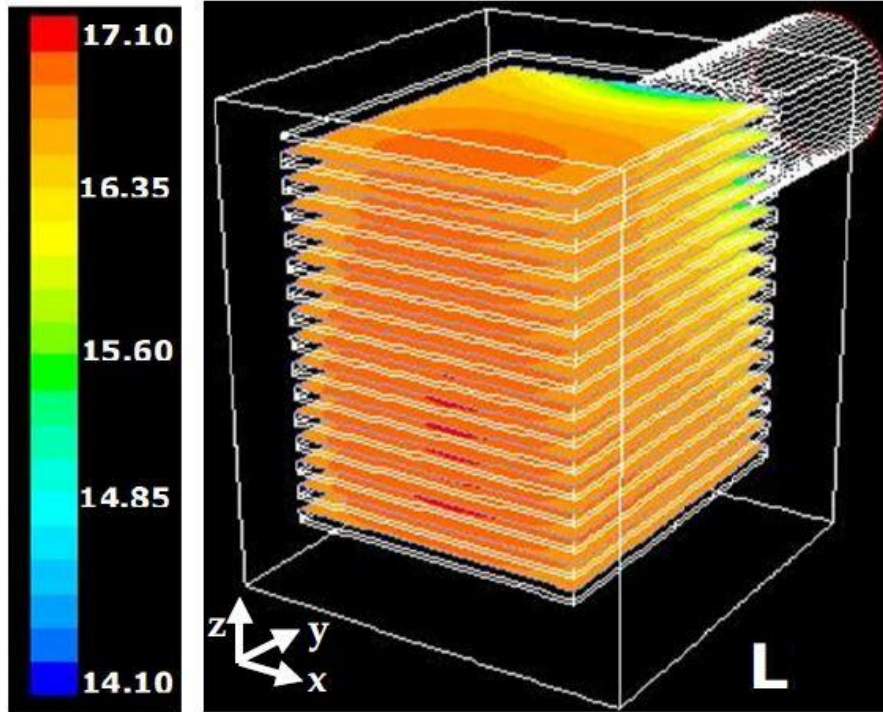

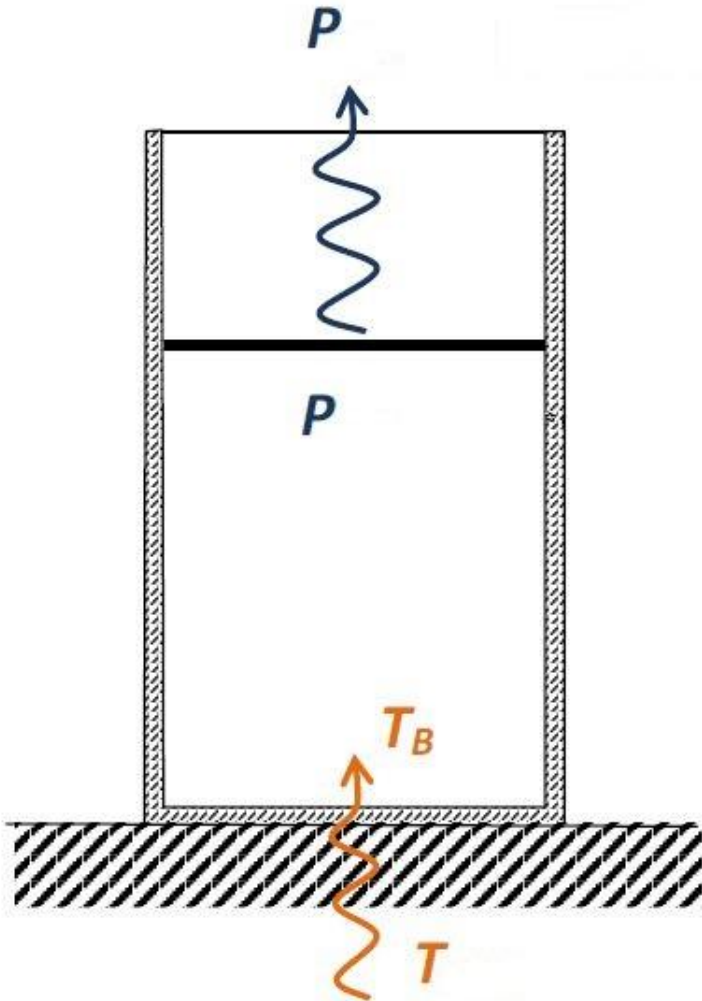

FASI DI LIOFILIZZAZIONE

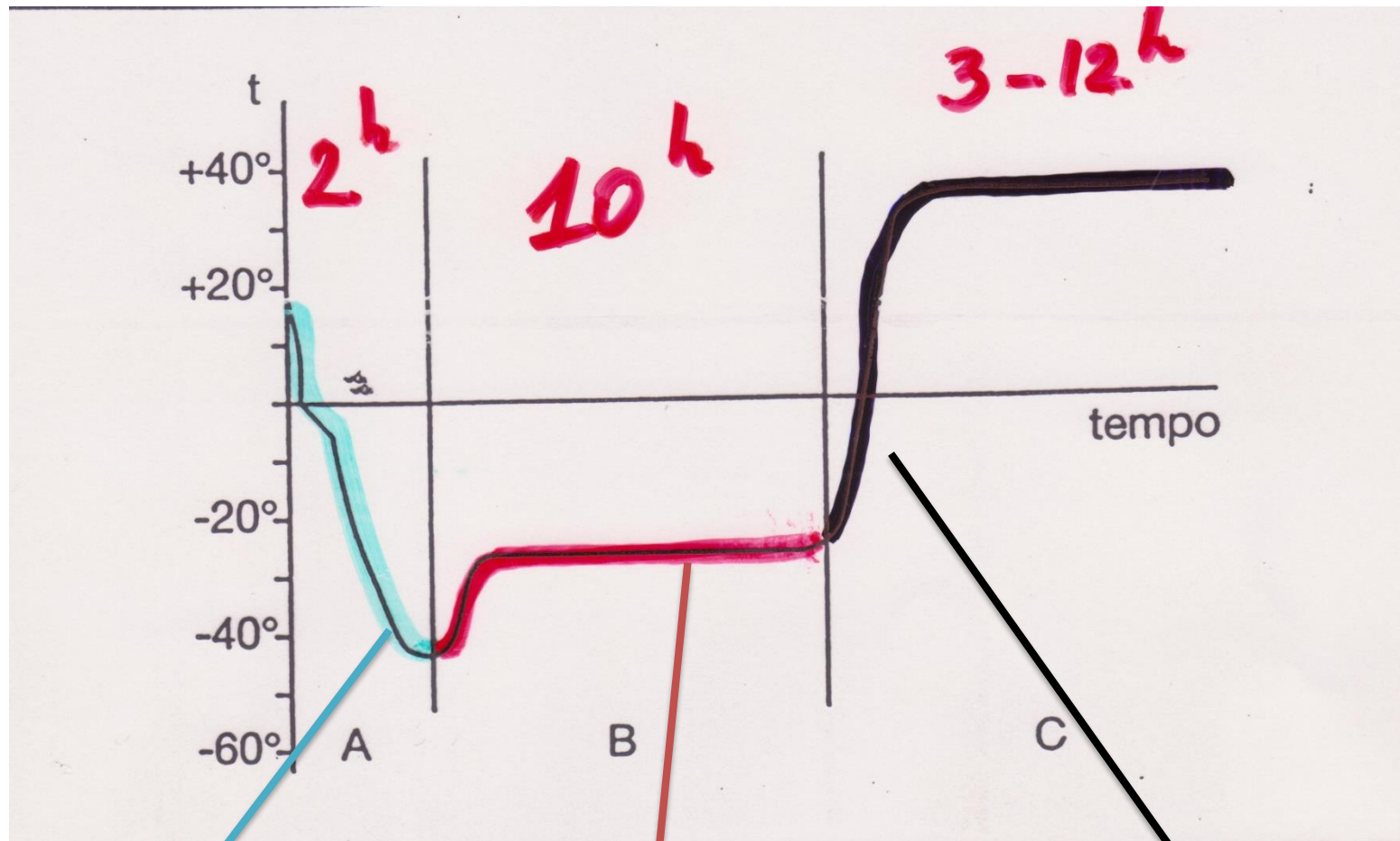

CONGELAMENTO

LIOFILIZZAZIONE VERA E PROPRIA

ESSICCAMENTO

CONGELAMENTO PARAMETRI:

VELOCITÀ (ELEVATA – FORMAZIONE DEI CRISTALLI PICCOLI; BASSA – GROSSI CRISTALLI)
TEMPERATURA MINIMA RAGGIUNTA -20/-40 °C

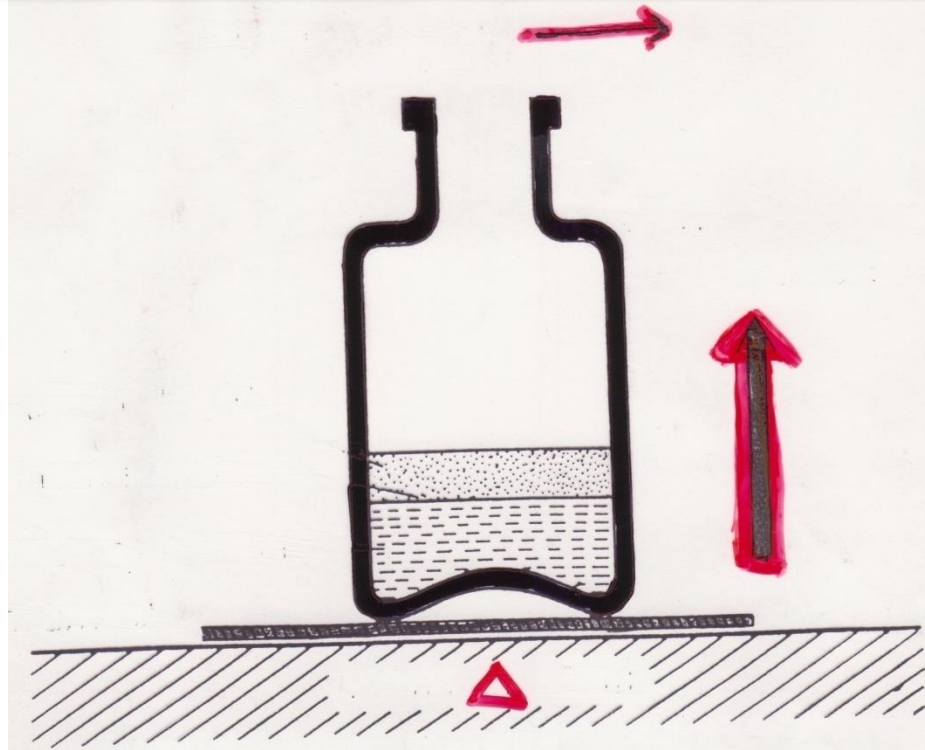

RIPARTIZIONE IN FIALE O FLACCONI: AMPIA SUPERFICIE E SPESSORE RIDOTTO



METODI DI CONGELAMENTO

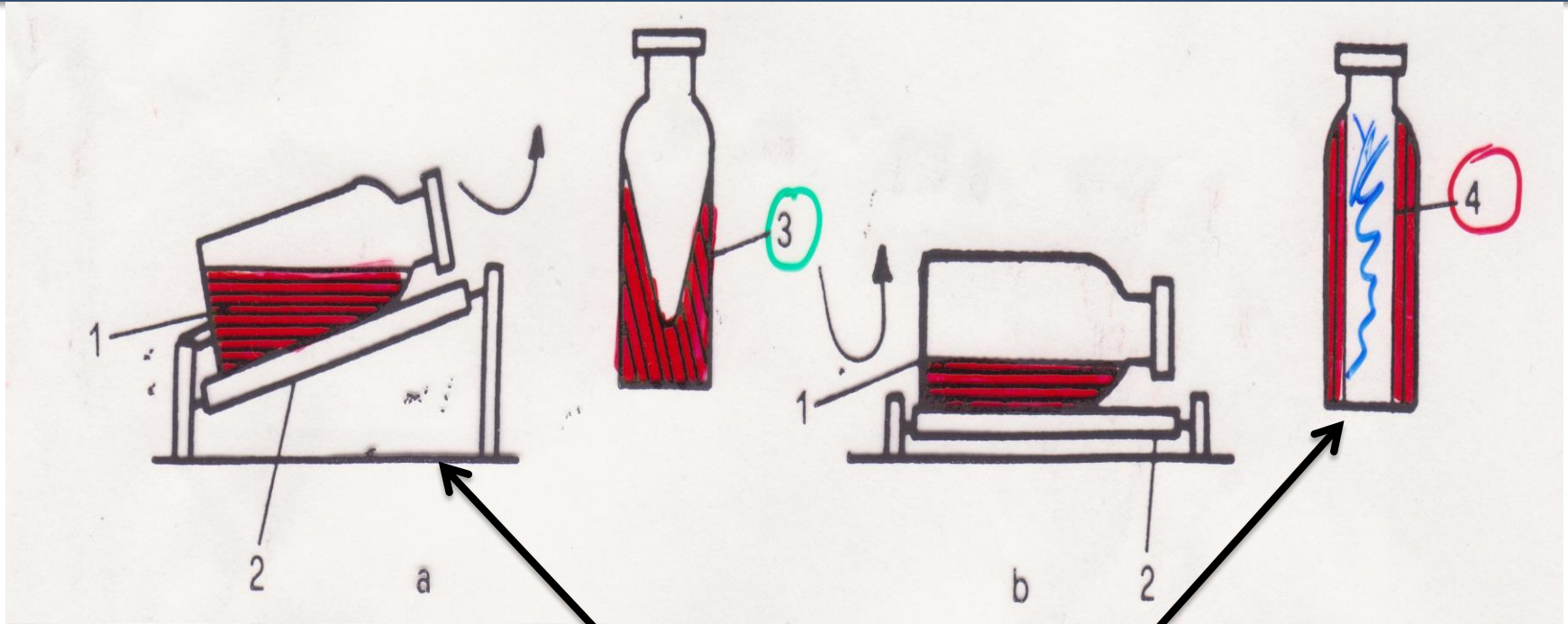

a) CONCHIGLIA

b) CILINDRO

c) FONDELLO (SPESSORE 10 – 12 mm, PLASMA UMANO 20 mm)

