

Chapter 7: Genetic aspects of bacterial virulence

Mechanisms of genetic change and diversification

The ability of bacteria to respond to new selective pressures, to survive adverse environmental conditions, and to exploit new environments depends on modification of gene functions or acquisition of new genes.

- **Slow processes of changing:**

Point mutation, gene deletion and insertion, gene duplication, and chromosomal rearrangement.

Under stressed-conditions: hypermutable subpopulation.

Slow acquisition of new phenotypes

- **Rapid processes of changing:**

Phase and antigenic variation: Mechanisms by which microorganisms results in a heterogenic phenotype in which individual cells either express the phase-variable protein(s) or not (**phase variation**), or express one of alternative and multiple forms of the protein (**antigenic variation**).

Horizontal gene transfer (HGT): mechanisms which lead the microorganisms to acquire new sequences, new elements that contributes to the evolution of pathogens through exchange of mobile genetic elements.

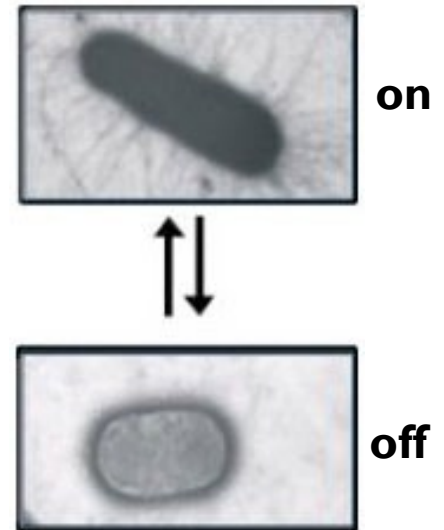

Phase variation

A reversible switch between an "all-or-none" (on/off) expressing phase, resulting **in variation in expression** of one or more proteins between individual cells of a clonal population.

The switch is a stochastic event and the frequency and that of its reversion **exceed that of a random mutation**. (1/100-1/1000 per generation), but the switching frequency can be modulated by external factors.

Daughter cells will inherit the expression phase of the parent, and the phase of expression is reversible between generations.

Structures that were found to phase vary were **on the cell surface**, where they would be exposed to the immune system.

Different molecular mechanisms involved: DNA inversion (recombination), DNA mispairing,

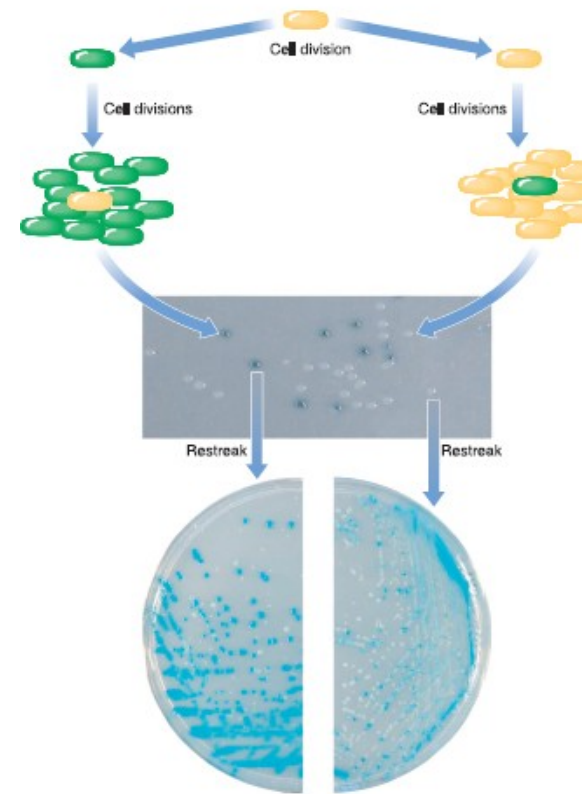

Microbe, 2008 vol 3 pp 21-26

Representative examples of phase and/or antigenic variations

The strategy is particularly important for organisms that target long-lived hosts, or repeatedly infect a single host.

<i>Bacterial species</i>	<i>Affected moiety or phenotype</i>	<i>Gene(s) or operon regulated</i>	<i>Variation of regulated gene(s)^c</i>	<i>Class(es) of regulated gene or operon</i>	<i>Molecular mechanism</i>
<i>B. Pertussis</i>	Fimbriae bvg+	<i>fim3, fim3</i>	Phase	Structural	SSM
		<i>bvgS</i>	Phase	Regulatory	SSM
<i>E. coli</i>	type I fimbriae Pilus P	<i>fim</i> operon	Phase	Structural	CSSR
		<i>pap</i> operon	Phase	Structural	epigenetic
<i>S. Typhimurium</i>	Flagella	<i>fljBA, fliC</i>	Phase	Structural	CSSR
<i>N. Gonorrhoeae</i> and <i>N. meningitidis</i>	Type IV pilin	<i>pilE, pilS</i>	Antigenic	Structural	Rec
<i>S. pneumoniae</i>	Capsule	<i>cap3A</i>	antigenic	Structural	Rec

SSM= slipped strand mispairing, appaiamento sfalsato di corte sequenze ripetute in tandem

CSSR= conservative site-specific recombination

Rec= recombination



Flagellar phase variation in Salmonella

Salmonella is able to switch between two distinct **flagellin** proteins once about every 1,000 cell generations which is accomplished by periodic inversion of a segment of DNA containing the promoter for a flagellin gene

DNA recombinase (*hin*) which promotes inversion of sequences at specific site of 14 base pairs (*hix* sequences)

Regulation of flagellin genes in Salmonella. H1 (*fljA*) and H2 (*fljB*) are different flagellins. In one orientation H2 is expressed **(a)**; in the opposite orientation H1 is expressed **(b)**.

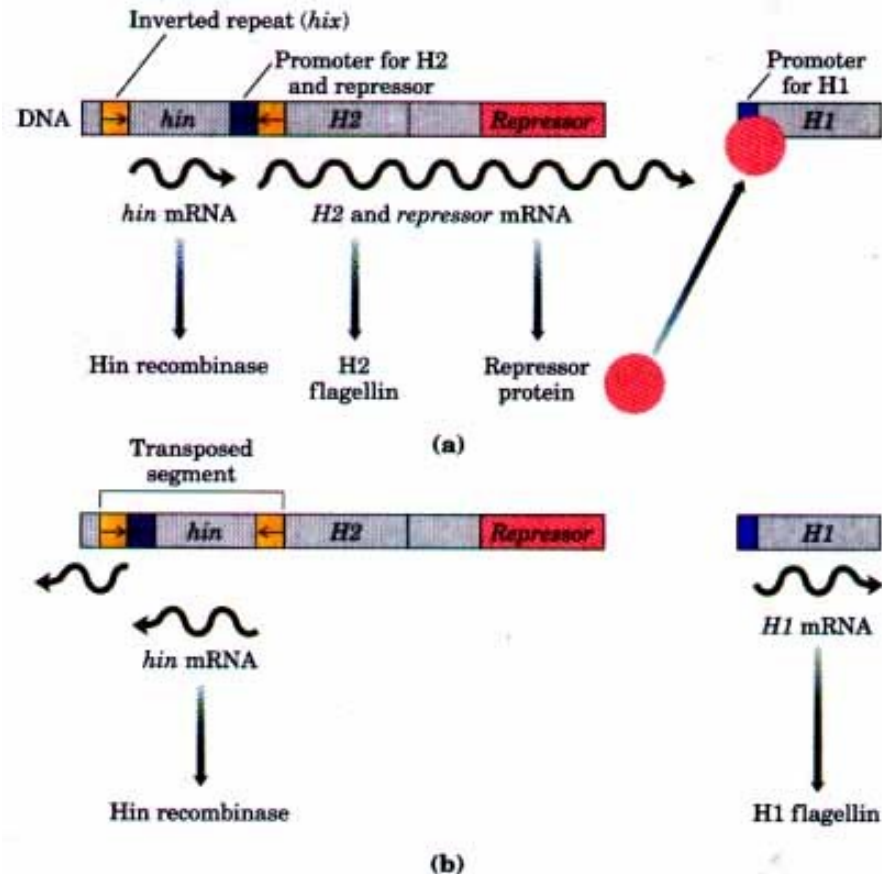

Hin recombinase-mediated inversion

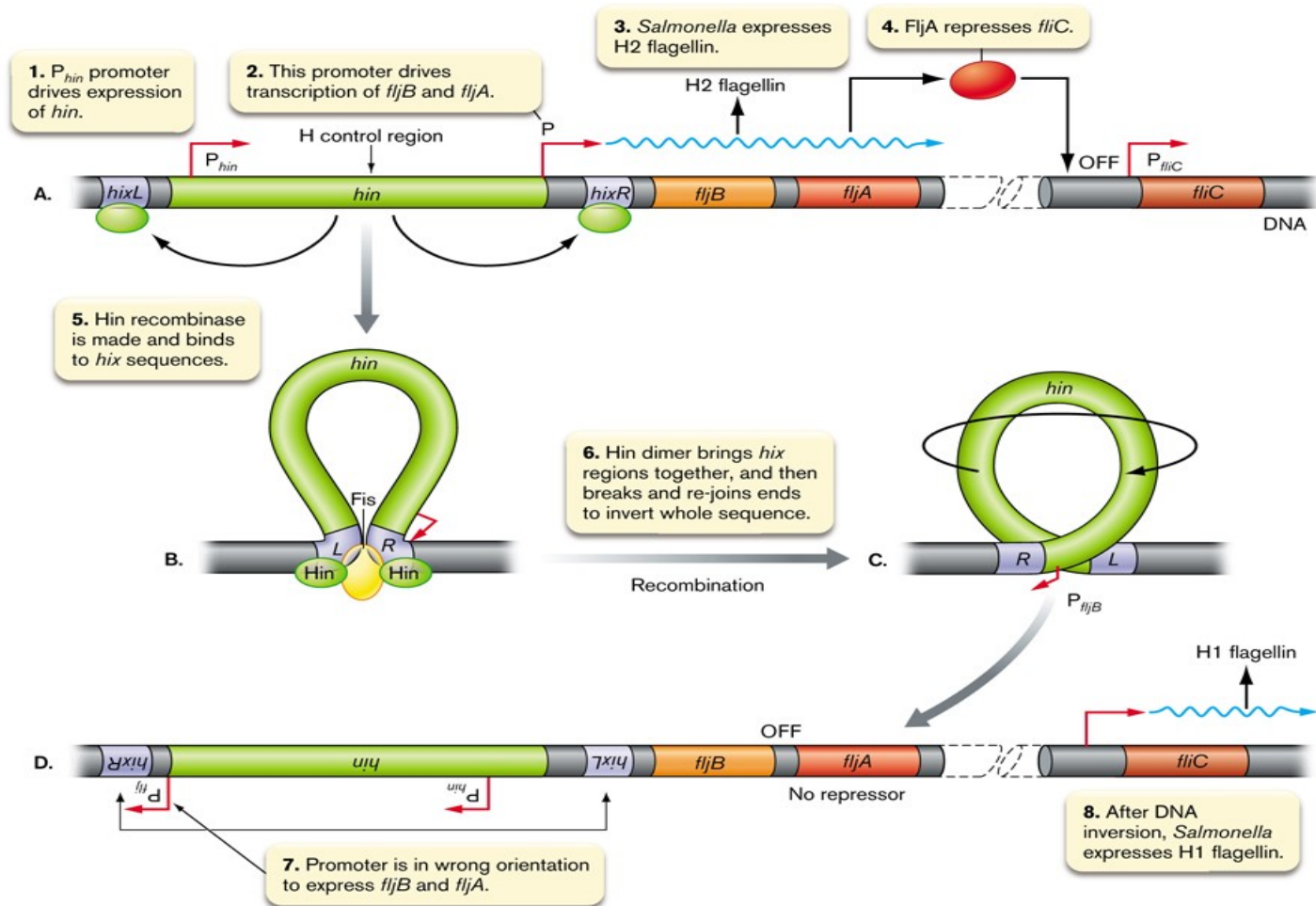

The mechanism of inversion is a **site-specific recombination**: the invertible element contains the promoter for the structural operon encoding *H2 flagellin* and H1 repressor.

Phase variation by means of DNA inversion

Phase variation of **type I fimbrial expression**, encoded by the *fim* operon, in *E. coli* as a result of DNA inversion. The main subunit of the fimbriae is coded by *fimA* in ON orientation.

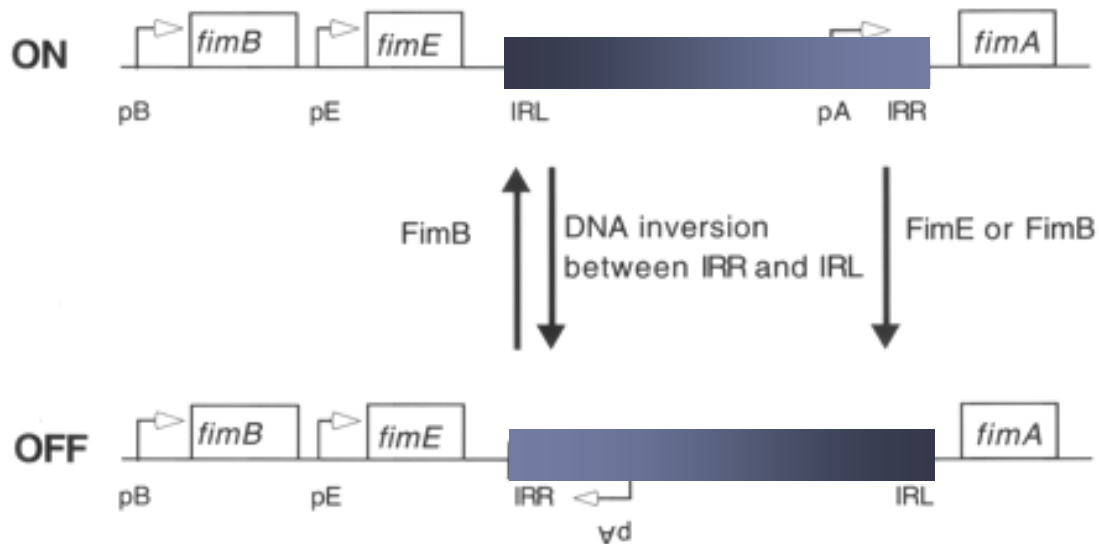

The mechanism of inversion is a **site-specific recombination**: the invertible element contains the promoter for *fimA* that is essential to transcribe the structural operon. The invertible element consists of 300 bp flanked by two 9-bp inverted repeats which are within the binding sites for the **recombinases** FimB and FimE.

Mechanism of slipped-strand mispairing (SSM)

SSM is a common strategy for antigenic variation by bacterial, fungal and protozoan pathogens. It is a process that produces mispairing of **short repeat sequences** between the mother and daughter strand during DNA synthesis.

Illegitimate base pairing in regions of repetitive DNA during replication, can produce **deletions or insertions of repeat units**. Backwards slippage and forwards slippage gives rise to larger and smaller numbers of repeat units in the synthesized strand.

Normal replication

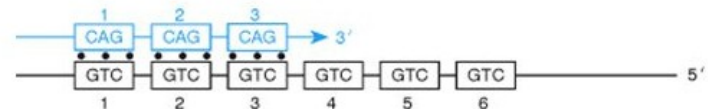

Backwards slippage causes insertion

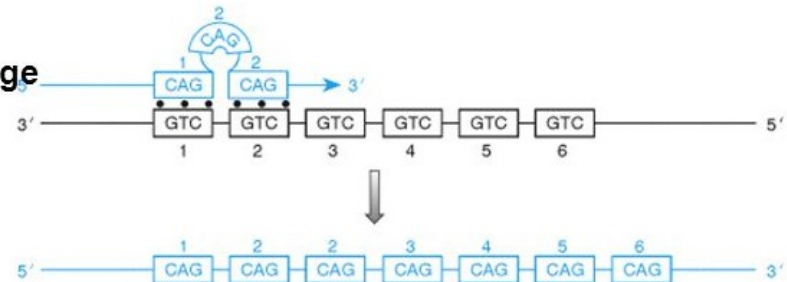

Forwards slippage causes deletion

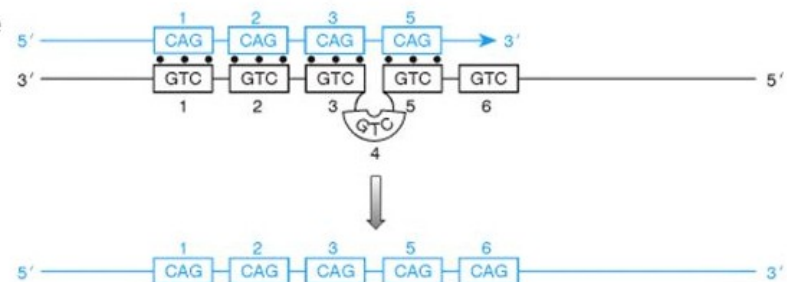

Model for phase variation via slipped-strand mispairing.

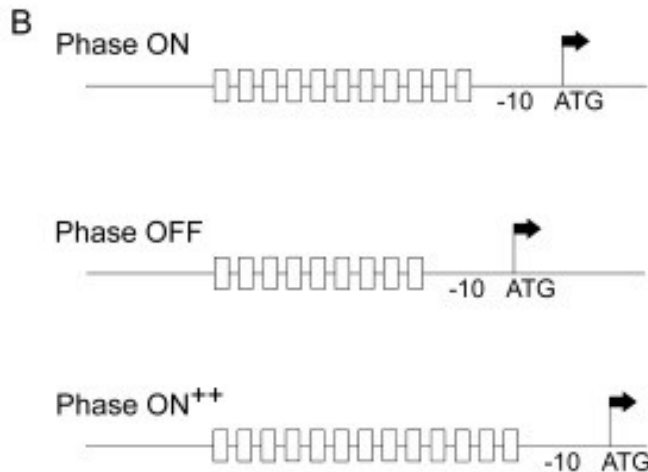
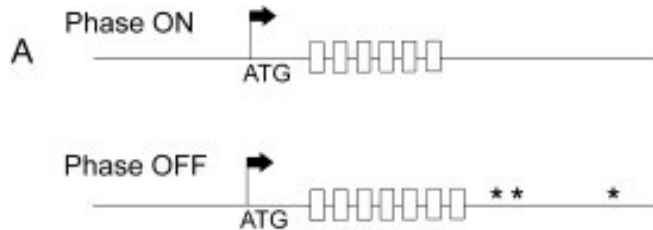

Variations in the number of repeats **within the coding region** of the gene results in a shift of reading frame in or out of frame. A shift out of frame will introduce premature stop codons (*).

Variations in the number of repeats **within the promoter region** of the gene will vary promoter -10 and -35 spacing, thereby increasing (ON⁺⁺) or decreasing (ON or OFF) promoter efficiency



Phase variation in gene encoding a major fimbriae in *H. influenzae*

A tetranucleotide repeat sequence (AGTC) is present in the promoter and in the coding sequences of a gene (*mod*) for fimbriae protein

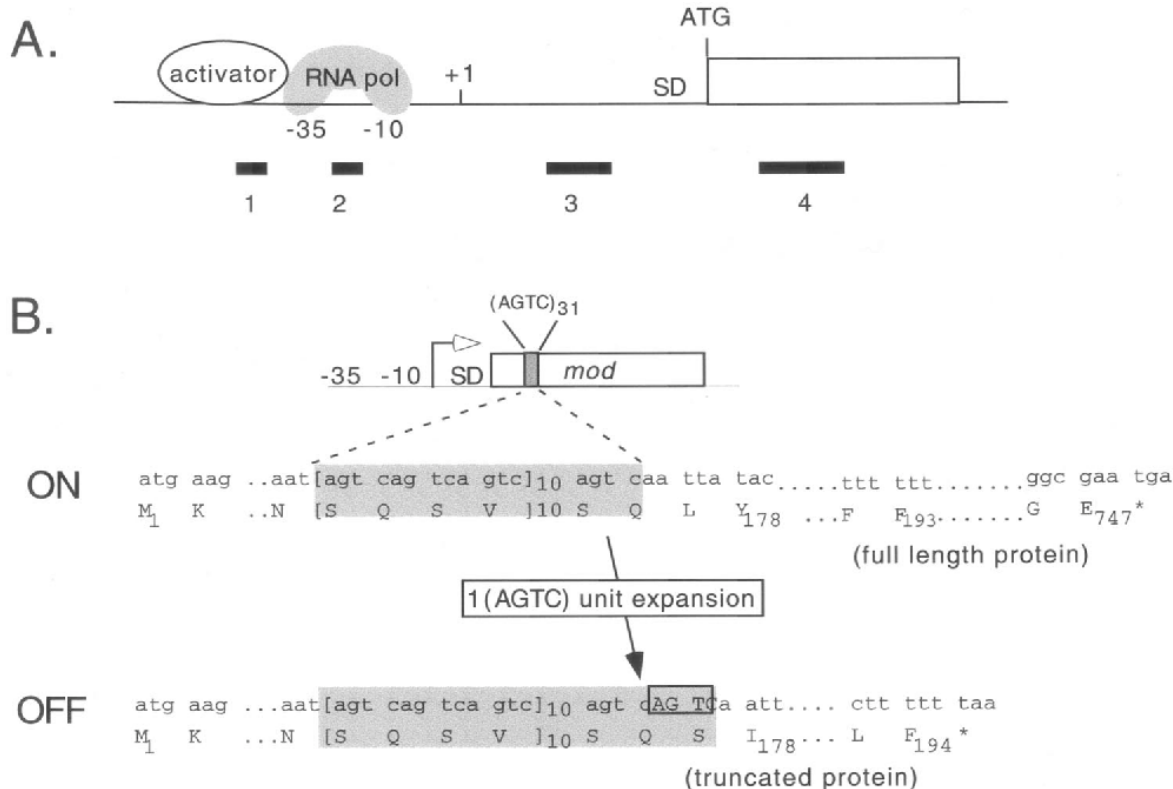

A. Scheme of four positions, relative to a gene, at which tetranucleotide **AGTC** repeats are presents.

B. One-unit insertion of the repeat AGTC in the **coding sequence**. The reading frame changes leading to the formation of a premature stop codon (*).

variation as a result of SSM at short sequence repeats. (A) Schematic of the four positions, relative to a gen

A similar mechanism is present in *bvgS* regulatory gene of *B. pertussis* and Opa and Opc protein of *Neisseria* species. (CTCTT)_n



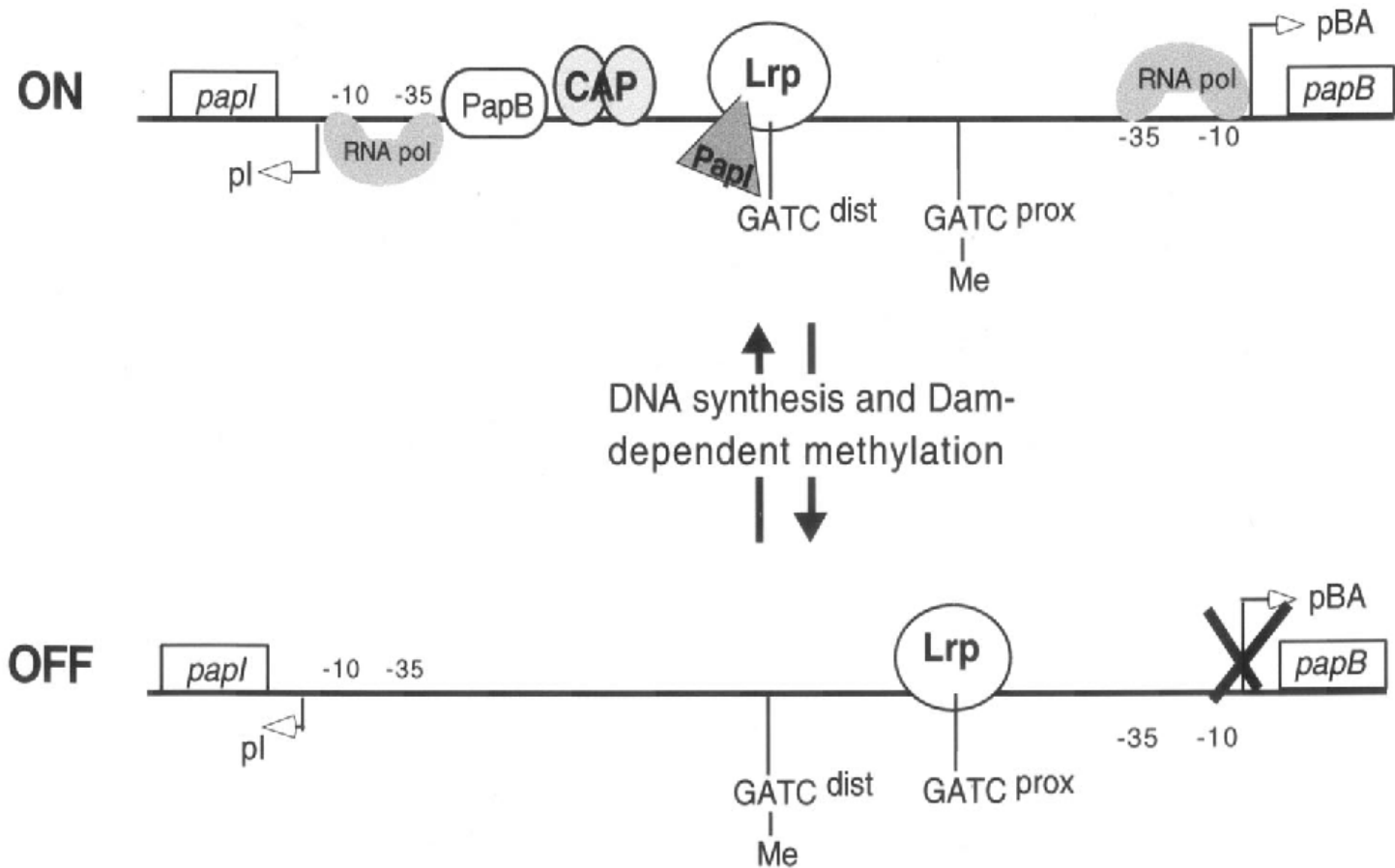

methylation-dependent phase variation of the *pap* operon in *E. coli*. Proteins that are essential for the “on” and

Antigenic variation

Antigenic variation refers to the expression of functionally conserved moieties within a clonal population **that are antigenically distinct**. The genetic information for producing a family of antigenic variants is available in the cell, but only one variant is expressed at a given time.

Antigenic variation is present also in eukaryotic pathogens, including *Plasmodium falciparum* and trypanosomes.

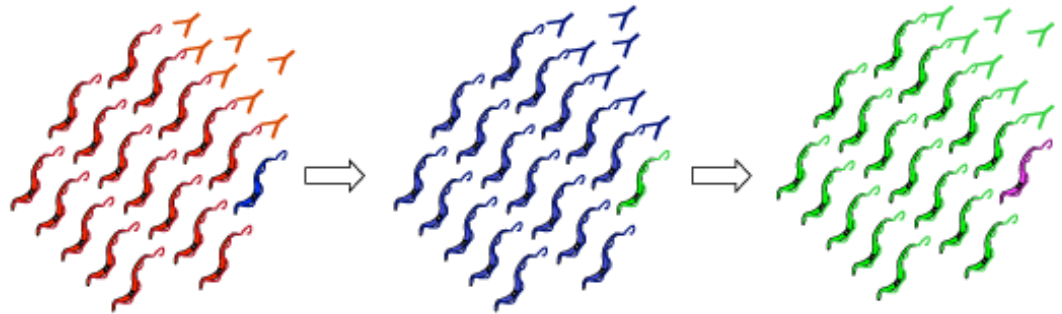

Trypanosomes multiply in the blood of the host until an antibody response results in lysis of recognized variants. Switched variants have a selective growth advantage until a host antibody response is mounted against these too.



Type IV pilin antigenic variation in *Neisseria gonorrhoea*

The most remarkable feature of *N. gonorrhoea* is its ability to evade the host's immune system through variation of its surface antigens (**type IV pili**). Recombination ($>10^{-3}$), between different variants (up to 1×10^6) of the same gene can occur.

It is a result of unidirectional transfer to the expression locus ***pilE*** of a sequence from one of the numerous **silent *pilS* loci** without altering the donor ***pilS*** sequence (**gene conversion**).

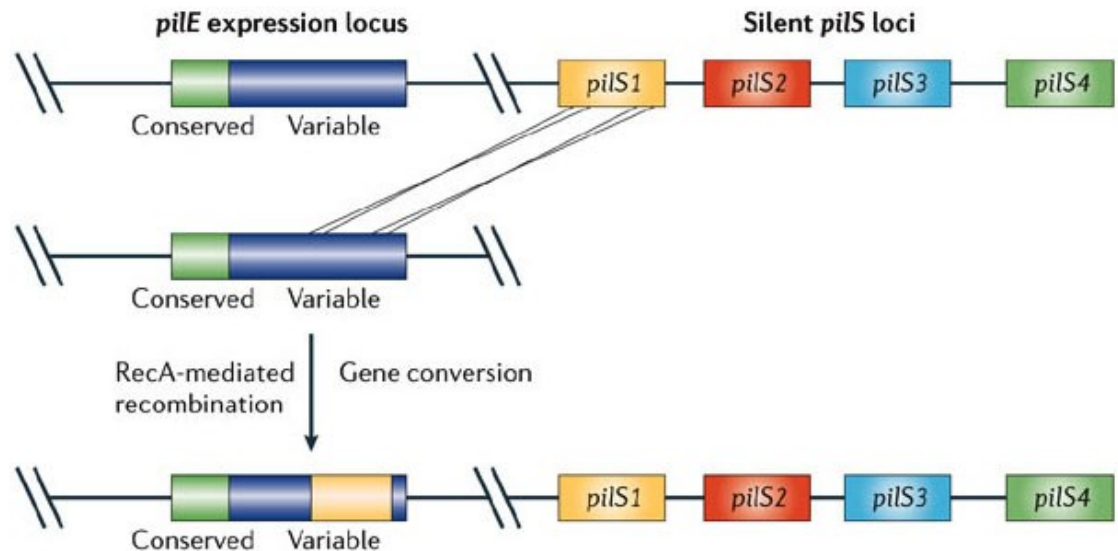

Copyright © 2006 Nature Publishing Group
Nature Reviews | Microbiology

There can be 1-10 copies of the silent loci on the genome, and an even higher variability may occur by intergenic recombination after natural transformation with *pilS* genes of different bacteria.



Horizontal gene transfer (HGT)

The ability of bacteria to adapt to new environments most often results from the **acquisition of new genes** through **horizontal transfer**

Horizontal gene transfer: movement of genetic material between bacteria other than by descent in which information travels through the generations as the cell divides.

There are at least three mechanisms of HGT, equivalent to the three processes of genetic exchange in bacteria. These are **transformation**, **conjugation** and **transduction**.

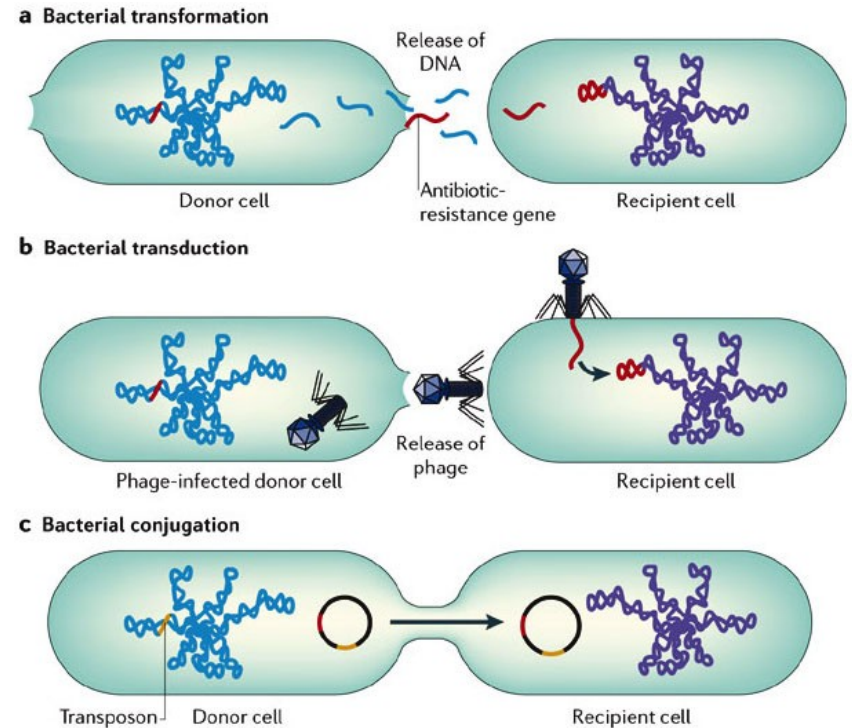

DNA uptake and transformation by competent Gram-negative bacteria

Transformation is a highly regulated process. DNA uptake sequences serve as recognition sites for binding and uptake

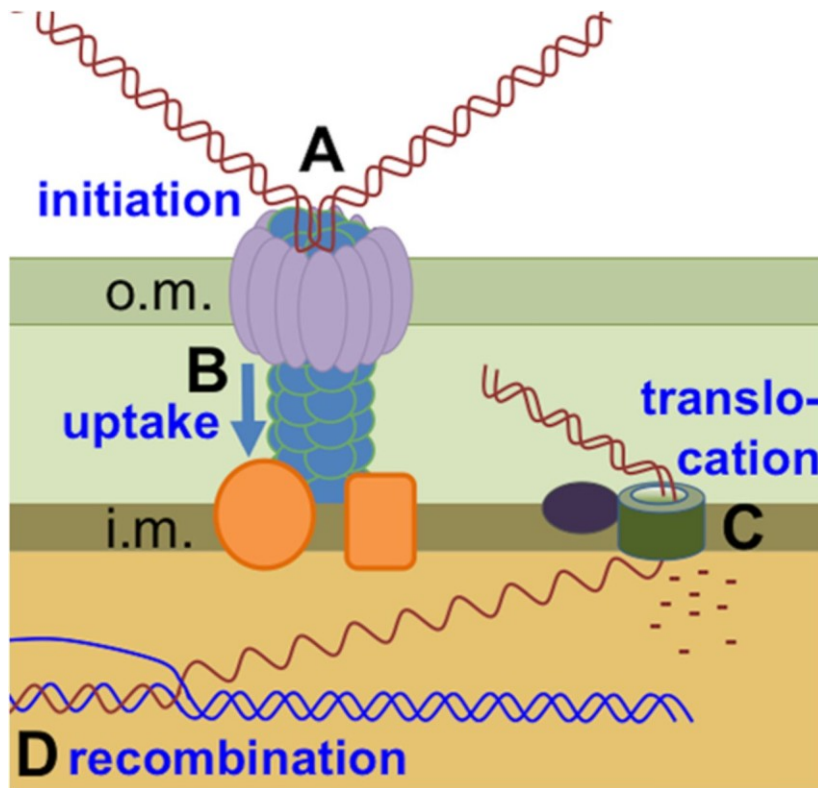

- (A) dsDNA is bound at the cell surface.
- (B) DNA is pulled through the a secretin pore by retraction of a pilus (T4P).
- (C) One strand is translocated intact into the cytoplasm by a complex protein; the other is degraded.
- (D) The new strand recombines with a homologous sequence in the chromosome, displacing the resident strand

Joshua Chang Mell, and Rosemary J. Redfield J. Bacteriol. 2014;196:1471-1483

Mobile genetic elements employed in conjugation: plasmids and transposones

DNA from plasmids and transposones are transferred by conjugation (and transformation). Interspecies transfer is likely possible. (emerging of antibiotic resistance).

Plasmids: replicate independently. They may carry only one or few genes coding for virulence or may also be very large (70-100 kb) and encode a complex set of genes giving a virulence phenotype.

Natural occurring plasmids are **self-transmissible** or **mobilizable** by conjugation.

Self-transmissible plasmid: it possesses conjugation genes known as **tra** genes and **oriT** (sequences for initiation of DNA transfer) enable the bacterium to form a mating pair with another organism.

Mobilizable plasmid: have **oriT** but lack the **tra** genes, it needs help to move its DNA.

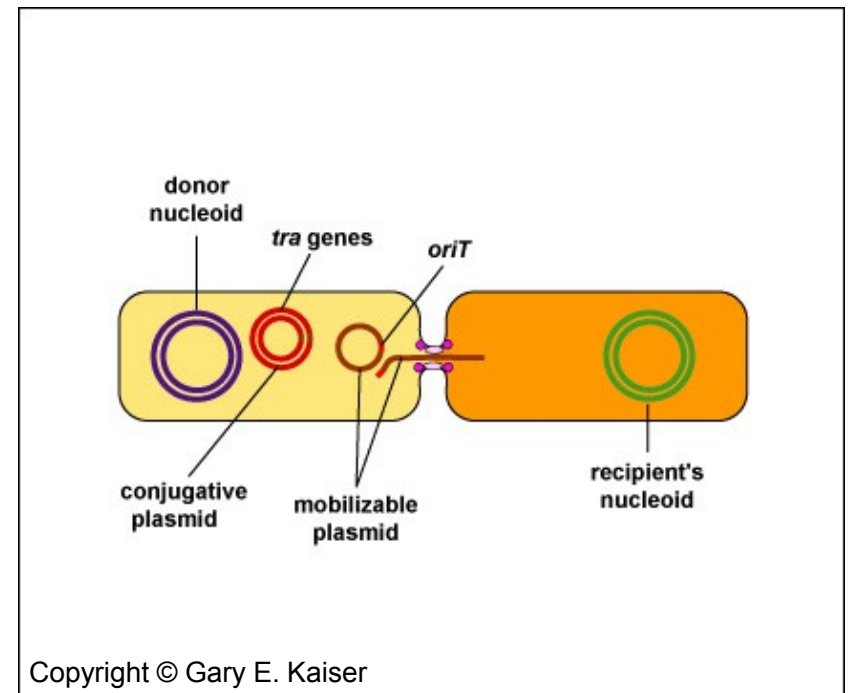

General structure of a IS element and of a transposon

DNA transposons: DNA element that can move (transpose) from one place in DNA to another.

Smallest one: Insertion sequence (IS) contains a **transposase gene** and inverted-repeat sequences at their ends used to target IS sites in the target DNA. More complex transposons (Tn3, Tn5 Tn10 etc) consist of two IS and other selectable genes in the middle. Some of them are **conjugative transposons**, have **tra** genes and promote transfer of their DNA and can promote transfer of their own DNA.

Copyright © The McGraw-Hill Companies, Inc. Permission required for reproduction or display.

(a) IS element structure

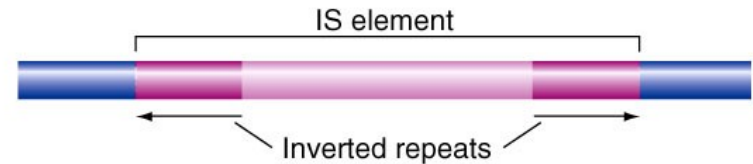

(b) IS insertion into *lacZ* gene

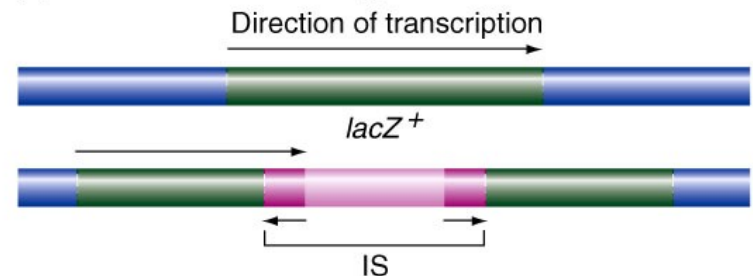

In *lacZ*⁻ IS interrupts *lacZ* gene and prevents transcription of the entire gene.

(c) Tn10 structure

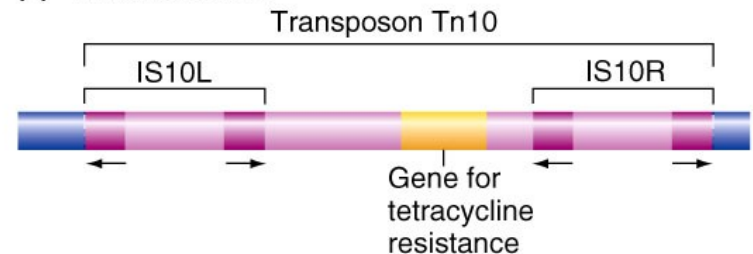

Mechanism of DNA transposition by the Tn5 transposon

Model of cut-and-paste transposition.

Transposase catalyzes the excision of the element and its insertion at a new target site. Individual molecules of transposase (blue spheres) bind to specific sites at the ends of the transposon.

Looping of the transposon DNA results in formation of a synaptic complex that brings the two ends of the transposable element close together.

The Tn5 transposase cuts the transposon DNA away from the flanking "donor" DNA (green).

The Tn5 transposase/DNA complex can move about freely until it encounters and binds to the "target" DNA (red), the transposase catalyzes insertion of the transposon DNA into the target DNA

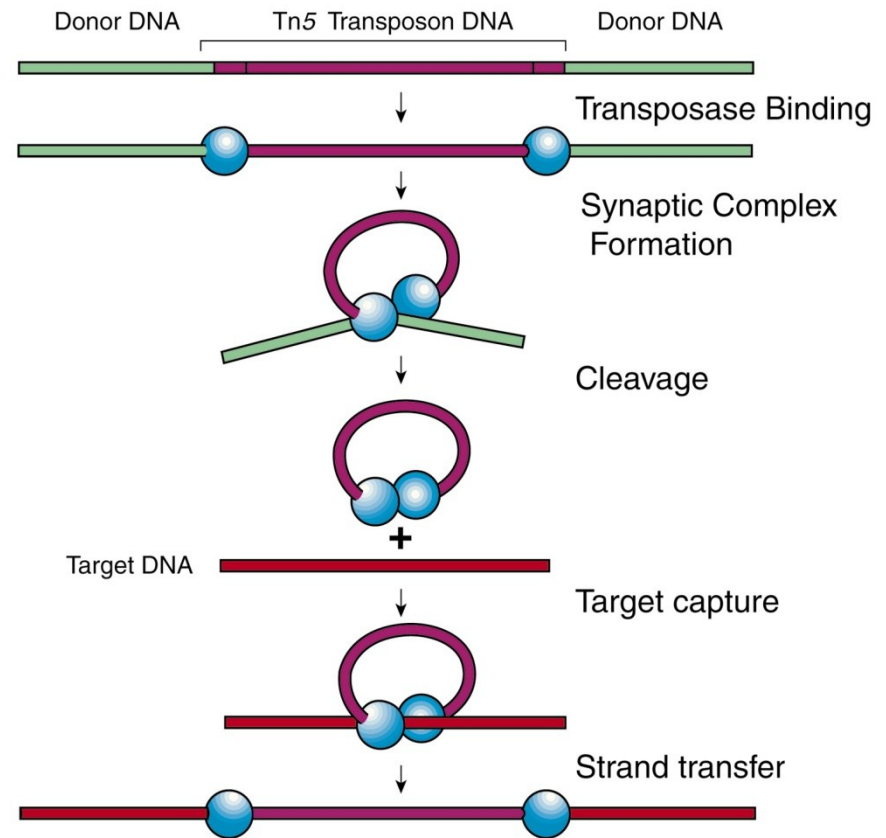

Schematic illustration of the mechanism of transposition catalyzed by the Tn5 transposase

Phage Transduction

DNA exchange between cells from bacteriophages are mediated by **DNA transduction**. Some lysogenic bacteriophages carry genes for toxins or other virulence genes. **Generalized transduction:** phage can accidentally transfer pieces of bacterial DNA during the lytic phase. New sequences are incorporated by recombination.

Specialized transduction: it occurs in phage that undergo both lytic and lysogenic phases in their life cycles. Phage moves their own phage genes but sometimes can also package segments of DNA that flank the phage attachment site.

Sometimes integrated lysogenic phages (prophages) may mutate and lose the ability to undergo a lytic phase

(a) Generalized transduction

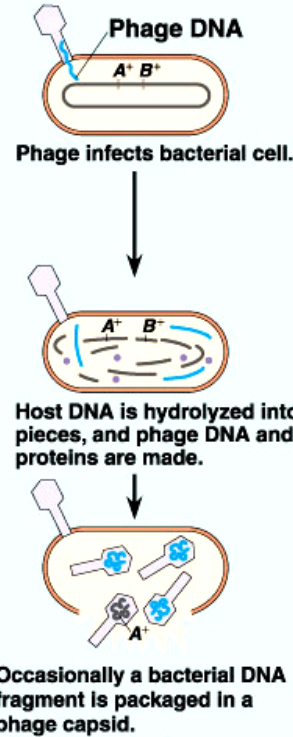

(b) Specialized transduction

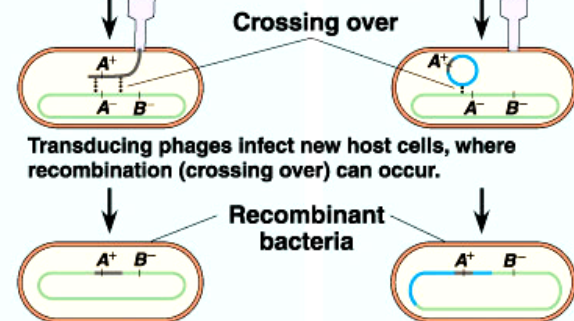
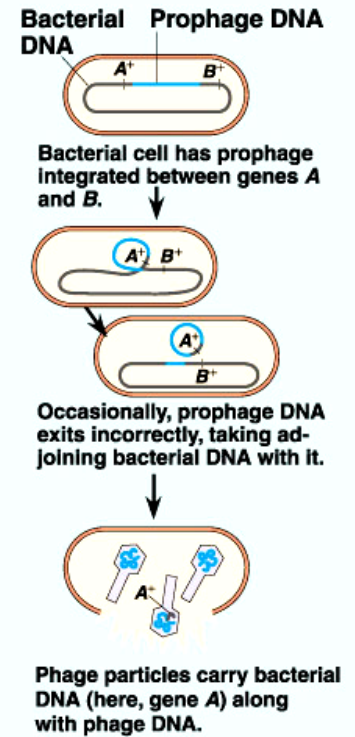

The recombinants have genotypes ($A^+ B^-$) different from either the donor ($A^+ B^+$) or recipient ($A^- B^-$).

Genomic islands and pathogenicity island

Genomic islands (GEI): discrete DNA segments differing between closely related bacterial strains which are horizontally acquired DNA regions and that are chromosomally inserted. GEIs show a large variety of sizes and abundance in bacterial genomes. Different GEI families have been recognized on the basis of predicted sequence and functional homologies.

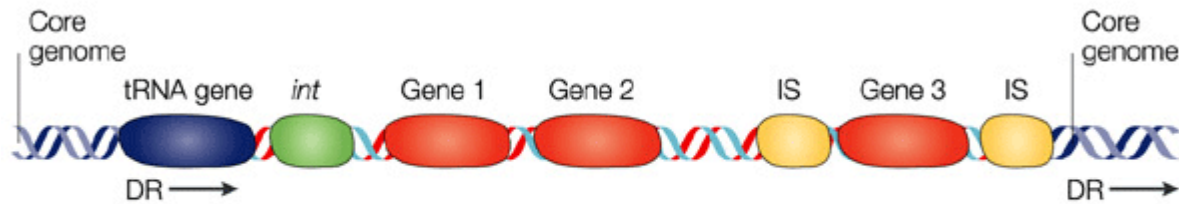

Nature Reviews Microbiology 2, 414-424 (May 2004)

Nature Reviews | Microbiology

A typical GEI is flanked by direct repeat (DR) structures and carries genes encoding traits that may increase bacterial adaptability or fitness under certain growth conditions including such traits as symbiosis, metabolic capability, antibiotic resistance, and virulence (**pathogenicity islands**).

GEIs carry multiple functional and fragmented insertion sequence (IS) elements and other mobility-related genes, (integrase, *int* gene), involved in insertion and deletion of the DNA.



Pathogenicity islands (PAIs) present in different pathogens

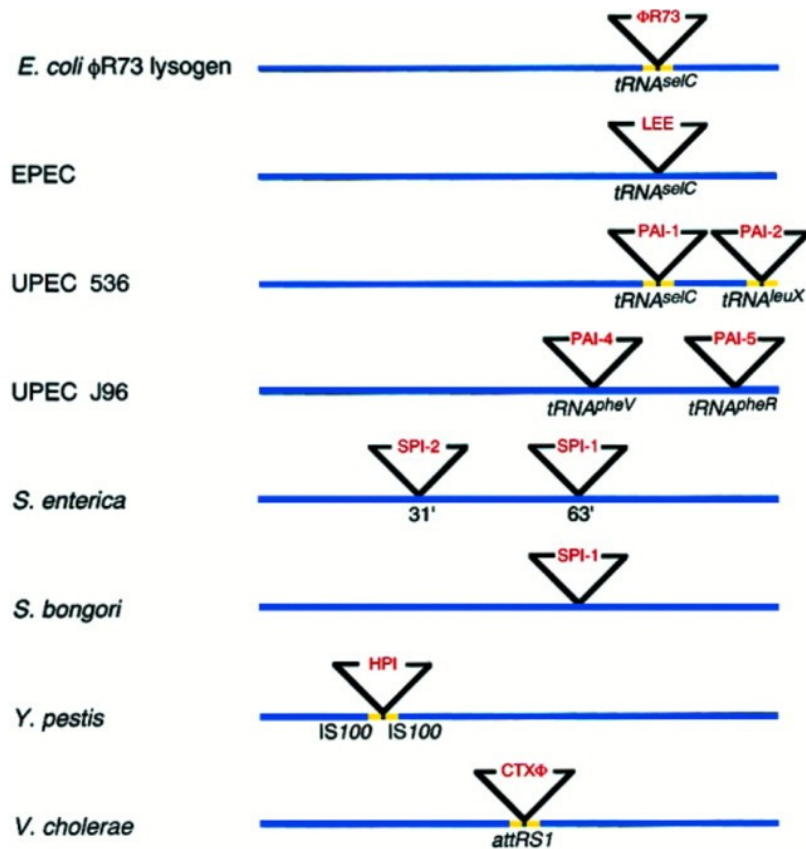

PAIs are distinct regions of DNA that are present in the genome of pathogenic bacteria but absent in non-pathogenic strains of the same or related species. PAI have a length of 10-200 kb, and these insertions may constitute 10-15 % of the genome.

PAIs are mostly inserted in the backbone genome of the host strain in specific sites: tRNA genes as phage attachment site or IS.

Comparison of a large number of genome sequences has revealed the importance of PAIs in the diversification of strains within a single species.

Characteristics of pathogenicity islands (PAI)

The PAI region has biased sequence composition (G+C % content) and often a different codon usage (used to identify new PAI).

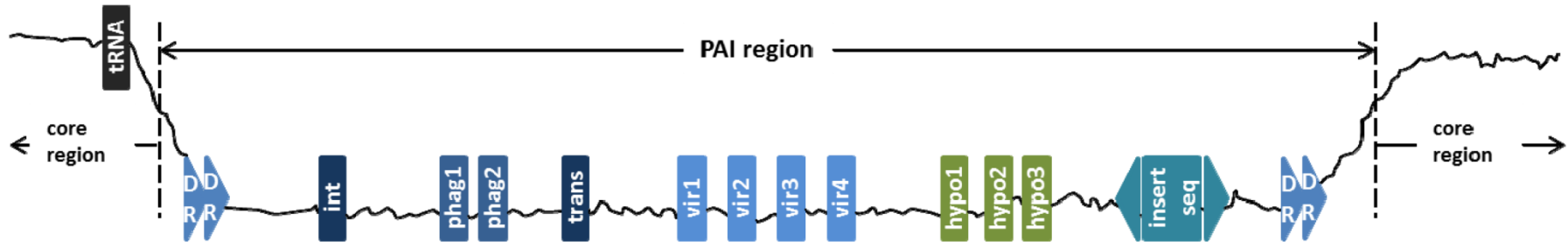

They have boundaries determined by direct repeats DRs, they contain **mobility genes**, complete or defective IS elements (some mobile genetic elements seem to be potentially mobilizable), genes linked to virulence (**vir**) phage-related genes (**phag**) and other protein-coding genes.

They could have originated by lysogenic phages integrated into the bacterial chromosome (prophages) that have lost by mutation the ability to undergo a lytic phase. Defective prophages (dormant) can still express many of their virulence genes. They have high potential for generating new pathogens in relatively short period of time.



The genomic organization of a PAI

PAIs may include genes that confer a variety of new functions: new iron uptake systems, different adhesins, different toxins, second-messenger pathway toxins, secreted lipases and proteases, type I, III, IV, and V protein secretion systems, antibiotic resistance. Example:

The Locus of Enterocyte Effacement (**LEE**) has been described in the *E. coli* EPEC strain, causative agent of infant diarrhoea and in *E. coli* EHEC.

LEE contains **≈40 ORFs** and is organized into polycistronic operons.

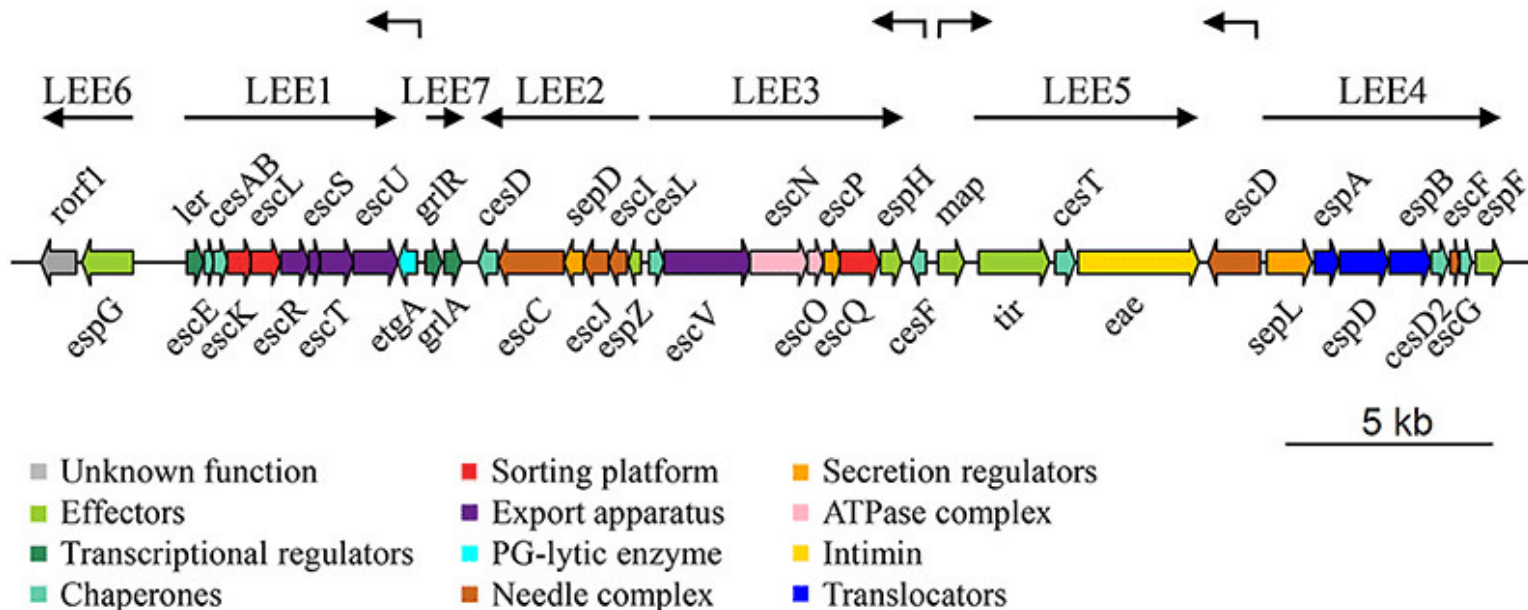

Evolution of a pathogen: acquisition of virulence genes

Acquisition of genes and gene clusters can drive the rapid evolution of pathogens and turn non pathogens into pathogens. *Vibrio cholerae*: a Gram-negative bacterium that causes the epidemic diarrheal disease cholera.

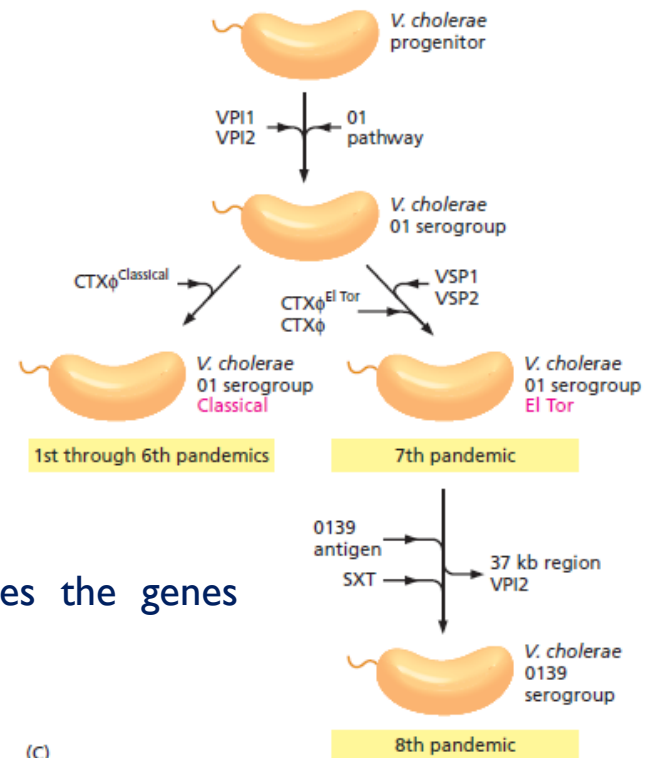
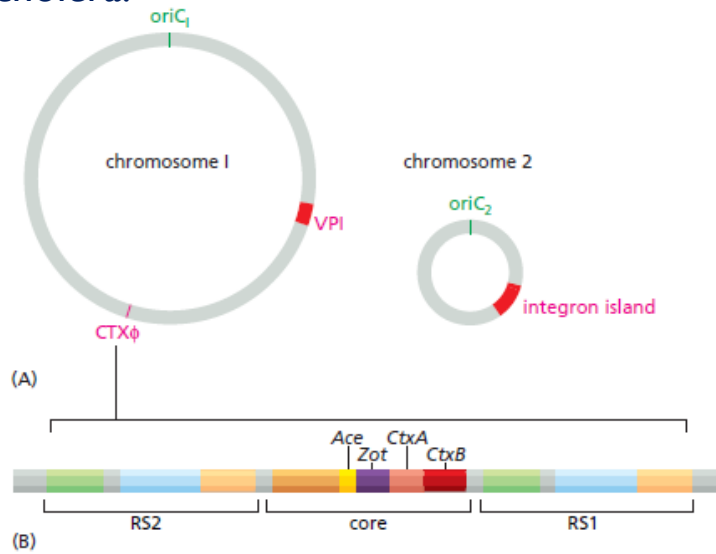

CTXφ: an integrated bacteriophage genome that carries the genes encoding cholera toxin (*CtxA* and *CtxB*).

O1 and O139 = primary carbohydrate surface antigen

VPI, VSP (pathogenicity islands)



Comparative-genomics-based model for the evolution of pathogenic *V. cholerae* strains

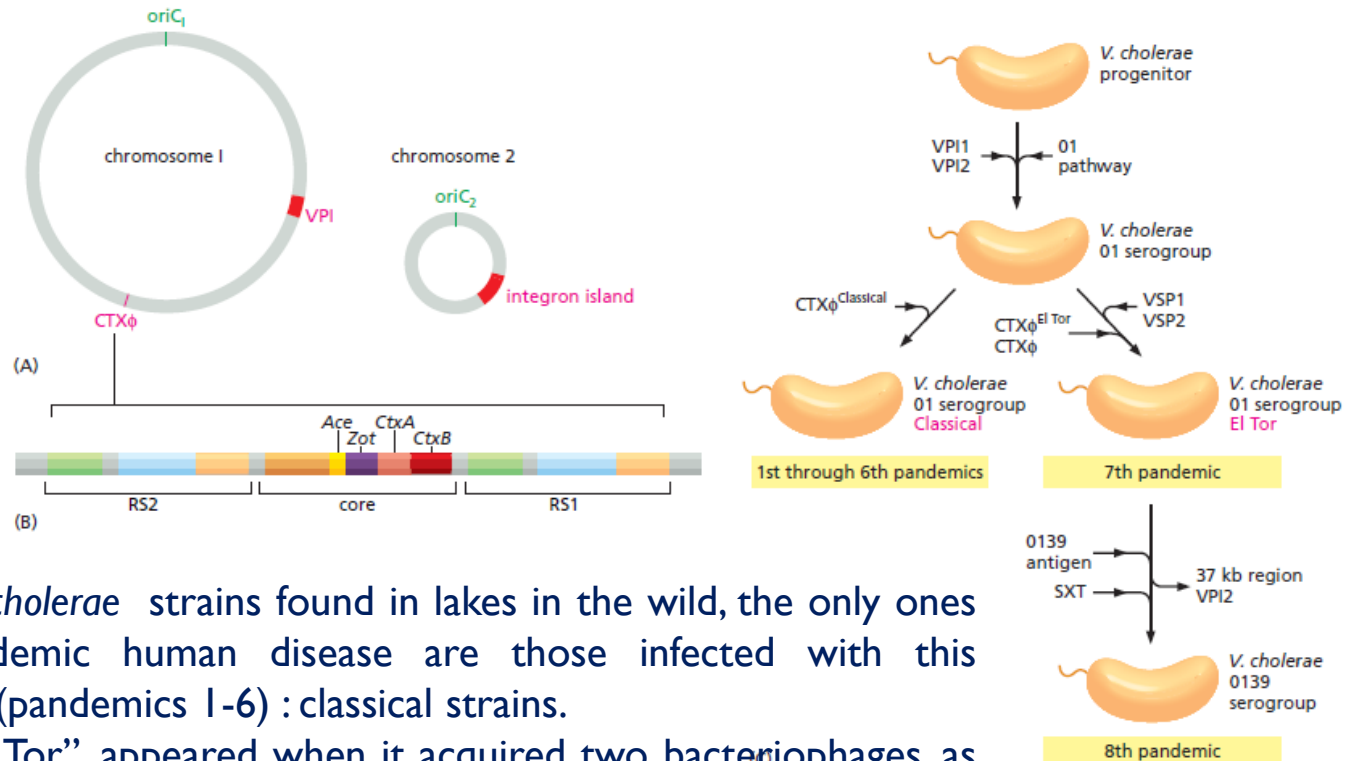

Of all the *Vibrio cholerae* strains found in lakes in the wild, the only ones that cause pandemic human disease are those infected with this **bacterial virus** (pandemics 1-6) : classical strains.

A new strain “El Tor”, appeared when it acquired two bacteriophages, as well as at least two new pathogenicity islands not found in Classical strains.

In 1991, an **eighth pandemic began**, even people who had suffered cholera previously were not immune, as the new strain had a different type of O antigen, rendering the anti-O1 antibodies present in the blood of survivors of previous cholera epidemics ineffective against the new strain.