



Università degli Studi di Udine  
Dipartimento Politecnico di Ingegneria e Architettura  
Corso di Sistemi per la produzione di energia



## L'EVOLUZIONE NELL'IDROELETTRICO DI BASSO SALTO: Innovazione e Sostenibilità Ambientale

Nicola Bragato

# STE ENERGY IN NUMBERS

95

PEOPLE

22

YEARS OF HISTORY



250

INSTALLED PLANTS

260

MW IN O&M

43

MLN € AVERAGE  
YEARLY REVENUES OF  
LAST 5 YEARS

# BUSINESS DEVELOPMENT

# 29

COUNTRIES IN THE WORLD  
HAVE CHOSEN  
STE ENERGY

ALBANIA  
ARMENIA  
BELGIUM  
BOLIVIA  
CANADA  
CHILE  
CHINA  
COLOMBIA  
COSTA RICA  
CROATIA  
DOMINICAN REP.  
E.A.U.  
ECUADOR  
FINLAND  
FRANCE

GERMANY  
GUATEMALA  
HONDURAS  
INDIA  
ITALY  
NICARAGUA  
NIGERIA  
PANAMA  
PERU  
POLAND  
QATAR  
ROMANIA  
TURKEY  
VIETNAM



# PRESENCE AROUND THE WORLD



# INNOVATION & DEVELOPMENT



17

PUBLICATIONS IN  
SCIENTIFIC JOURNALS  
AND INTERNATIONAL  
CONFERENCES



20

GRADUATION THESIS



1%

INVESTMENT IN I&D  
ON TOTAL TURNOVER



8

ONGOING PROJECTS



7

AWARDS RECEIVED



15

PEOPLE INVOLVED IN  
I&D PROJECTS

# MISICUNI

CLIENT	ENDE
SITE	Bolivia 
YEARS	2014-2017
CONTRACT	Turnkey design, supply and assembly of civil, electrical, mechanical and automation works
POWER	3 x 40.000 kW Pelton
NOMINAL HEAD	1024 m
NOMINAL FLOW	4,9 m <sup>3</sup> /s each turbine



LARGE HYDRO



# QUITARACSA

CLIENT	Enersur S.A. - GDF Suez
SITE	Peru 
YEARS	2011-2015
CONTRACT	Turnkey design, supply and assembly of electrical, mechanical and automation works
POWER	2 x 56.000 kW Pelton
NOMINAL HEAD	895 m
NOMINAL FLOW	7,5 m <sup>3</sup> /s each turbine



LARGE HYDRO



# LOS NEGROS 2

CLIENT	Constructora Los Negros S.A.
SITE	Costa Rica 
YEARS	2015-2017
CONTRACT	Turnkey design, supply and assembly of electrical, mechanical and automation works
POWER	2 x 14.300 kW Francis
NOMINAL HEAD	126 m
NOMINAL FLOW	12,25 m <sup>3</sup> /s each turbine



MEDIUM HYDRO





# VIGONOVO

CLIENT	IS Renewable
SITE	Italy 
YEARS	2014-2015
CONTRACT	Water to wire Engineering, procurement, construction, commissioning
POWER	1 x 1319 kW Kaplan bulb config.
NOMINAL HEAD	2,43 m
NOMINAL FLOW	24 m <sup>3</sup> /s



SMALL HYDRO



# OSPEDALETTO

CLIENT	Domus Flow
SITE	Italy 
YEARS	2017. Under construction
CONTRACT	Turnkey design, supply and assembly of electrical, mechanical and automation works
POWER	1 x 387 kW VLH 3550
NOMINAL HEAD	3,15 m
NOMINAL FLOW	15,1 m <sup>3</sup> /s



MINI HYDRO



# PONTE MAS

CLIENT	Hydro Power srl
SITE	Italy 
YEARS	2014-2015
CONTRACT	Water to wire Engineering, procurement, construction, commissioning
POWER	1 x 172 kW Archimedean Screw
NOMINAL HEAD	4,2 m
NOMINAL FLOW	5,6 m <sup>3</sup> /s



MINI HYDRO



# SAN GIOVANNI BIANCO

CLIENT	Laut Engineering
SITE	Italy 
YEARS	2017. Under construction
CONTRACT	Turnkey design, supply and assembly of electrical, mechanical and automation works
POWER	1 x 80 kW Kaplan
NOMINAL HEAD	4,25 m
NOMINAL FLOW	1,95 m <sup>3</sup> /s



MICRO HYDRO



■ Potenza Eff. Lorda (MW)    ■ Numero Impianti

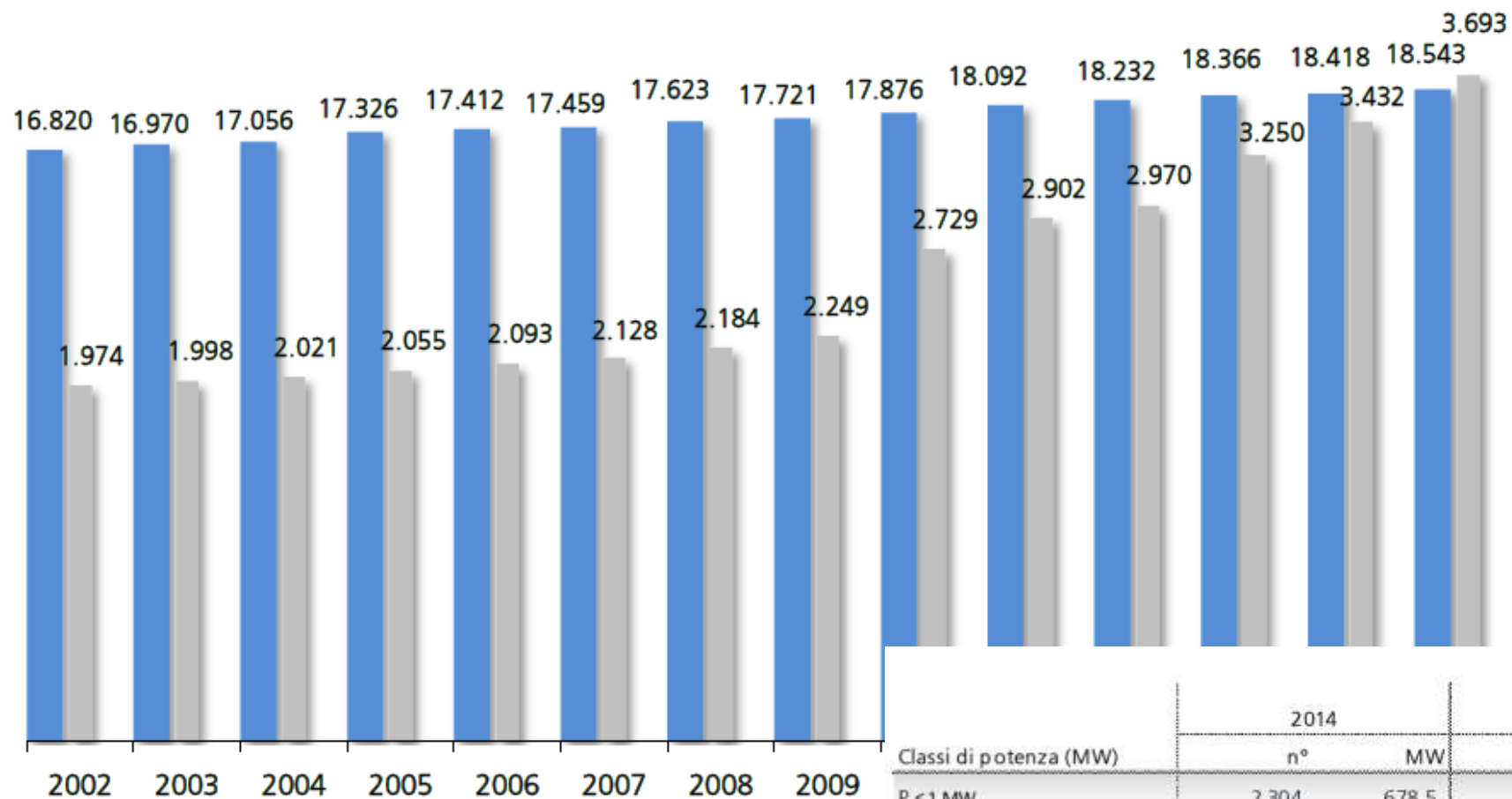

Classi di potenza (MW)	2014		2015		2015 / 2014 Variazione %	
	n°	MW	n°	MW	n°	MW
P ≤ 1 MW	2.304	678,5	2.536	722,8	10,1	6,5
1 MW < P ≤ 10 MW	825	2.493,9	854	2.575,3	3,5	3,3
P > 10 MW	303	15.245,1	303	15.245,1	0,0	0,0
<b>Totale</b>	<b>3.432</b>	<b>18.417,5</b>	<b>3.693</b>	<b>18.543,3</b>	<b>7,6</b>	<b>0,7</b>



DAGLI ALTI SALTI IDRAULICI



AI BASSI E BASSISSIMI SALTI

# TRADIZIONE ED INNOVAZIONE



PELTON



FRANCIS



KAPLAN



DIVE



COCLEA



VLH

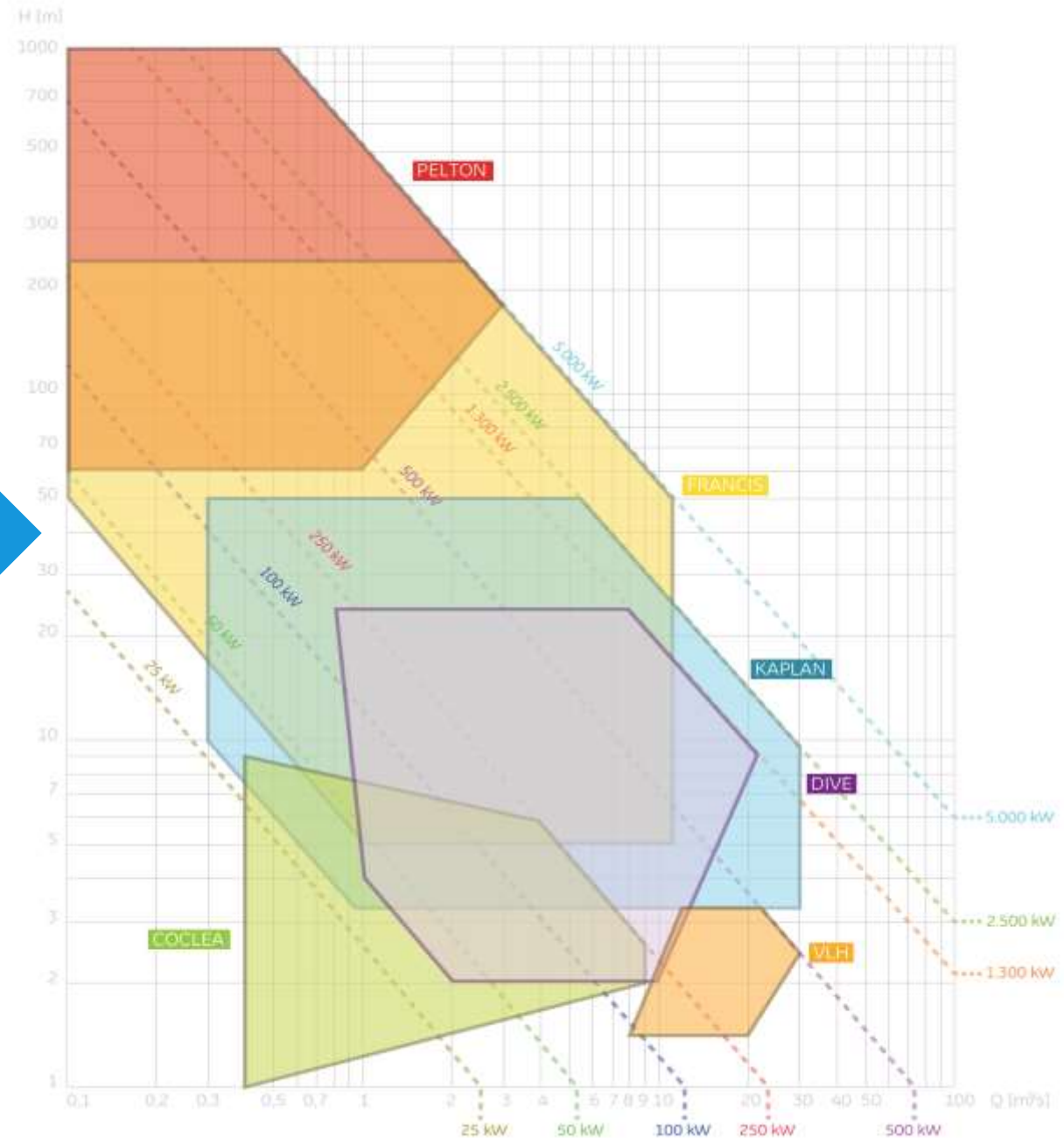

# CENTRALI SU CANALI DI BONIFICA E DI IRRIGAZIONE

## PUNTI DI FORZA

Portata "conosciuta"  
(canale regimato)  
Trasporto solido ridotto



## PUNTI DI DEBOLEZZA

Opere civili in acqua  
Rendimenti dipendenti OO. CC.  
Gestione delle piene





# TECNOLOGIE INNOVATIVE PER LO SFRUTTAMENTO DEI SITI A BASSO SALTO

- Coclea
- Turbina DIVE
- Turbina VLH

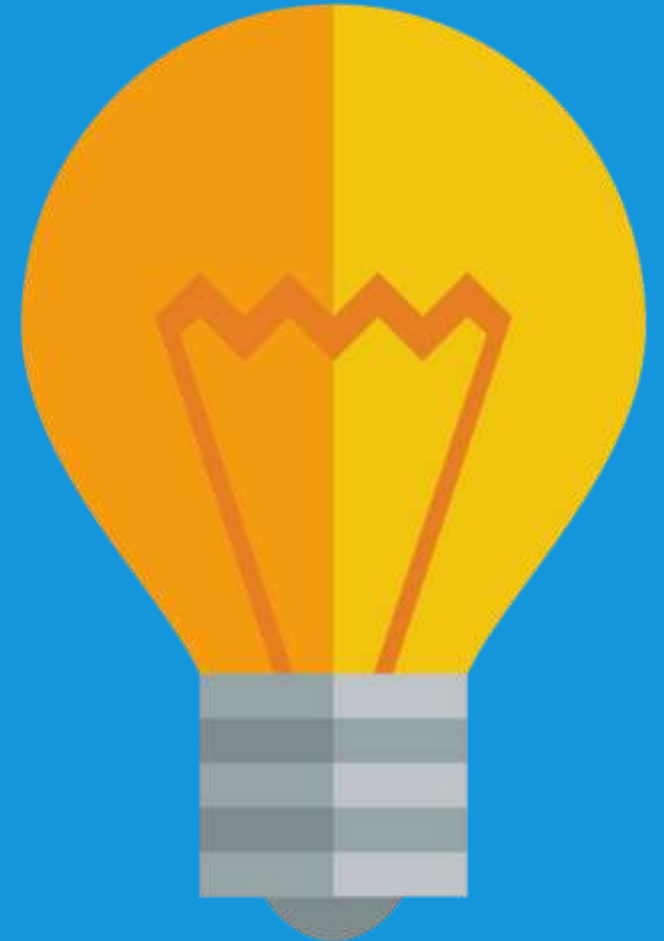

# LA TURBINA DI TIPO COCLEA

Ampio range di funzionamento con siti a basso salto e bassa portata



Attualizzazione, perfezionamento, industrializzazione della Vite di Archimede

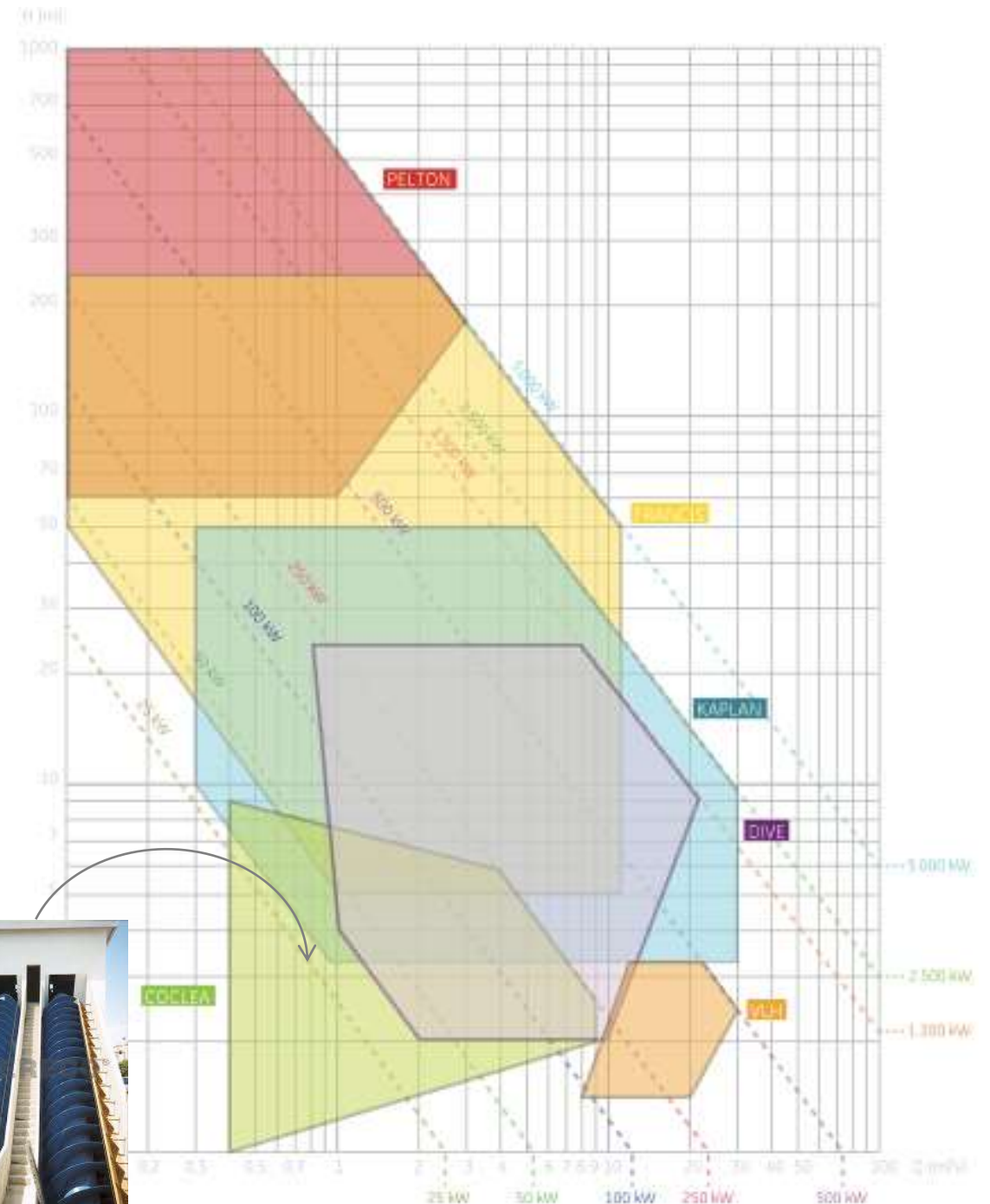

# COCLEA: DESCRIZIONE DELLA MACCHINA

## COCLEA IDROELETTRICA

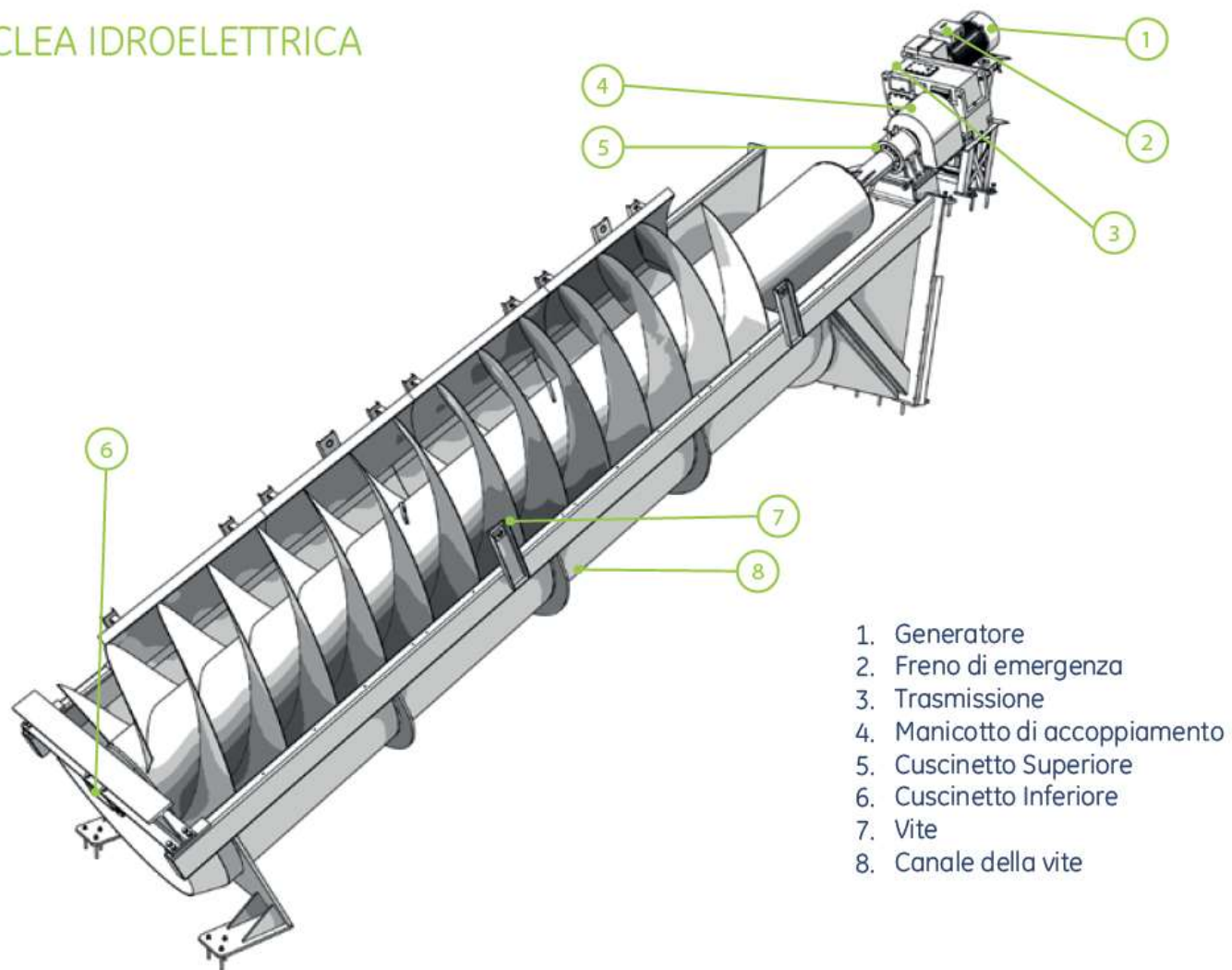

# COCLEA: DESCRIZIONE DELLA MACCHINA

## COME FUNZIONA?

L'acqua fluisce lungo la vite ed inizia la sua rotazione. La rotazione è trasmessa alla trasmissione e inviata al generatore che produce elettricità.

Il canale di entrata ha uno schermatura grossolana. Questa trattiene materiale estraneo (rifiuti galleggianti) dal sistema.

Sedimenti più piccoli possono passare dalla schermatura e dalla vite, così che la struttura del sedimento naturale venga mantenuta.

## Campi di applicazione della vite idroelettrica

Flusso	da 300 l/s a 10.000 l/s
Salto	da 1 m a 10 m



# COCLEA: LAYOUT DI CENTRALE

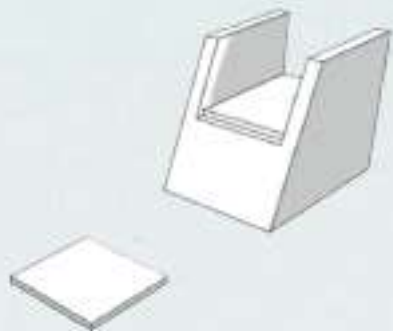

## Step 1

Struttura: Fondazione in basso, canale di ingresso in alto.

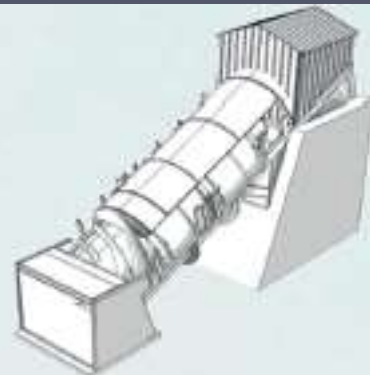

## Step 2

Tutto viene assemblato in fabbrica. Quindi il sistema viene sollevato in posizione e fissato in sito.

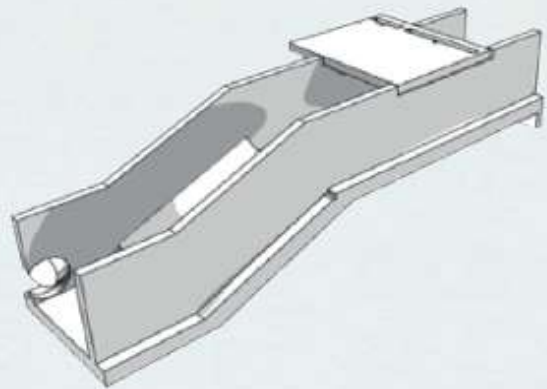

## Step 1

In accordo con le specifiche di progettazione, questa struttura deve essere costruita prima della consegna del sistema.

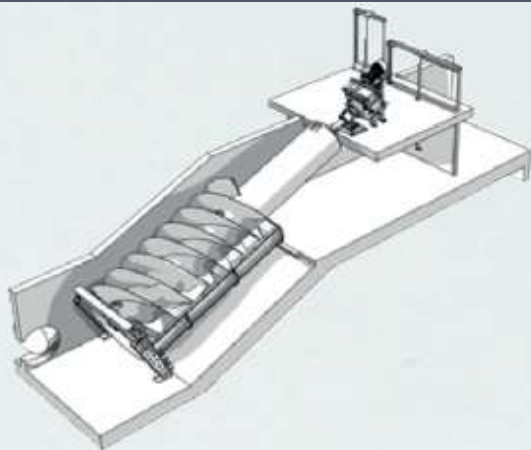

## Step 2

Inghisaggio del canale. Bullonatura del cuscinetto superiore e console del meccanismo di trazione.

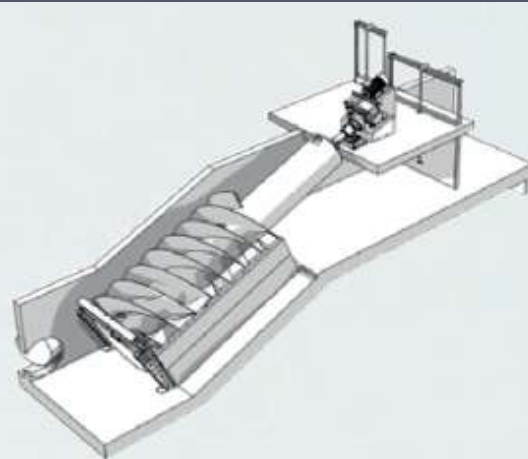

## Step 3

La colata del canale della vite e del meccanismo di trazione con il cemento è un passaggio obbligatorio.

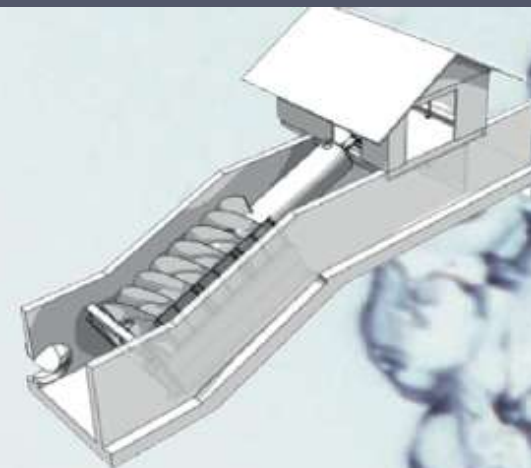

## Step 4

Assemblaggio finale, fissaggio degli scudi deflettori, lavorazioni elettriche finali, completamento dell'edificio centrale.

# COCLEA: IMPATTO AMBIENTALE

## CO2 NEUTRO

L'elettricità prodotta tramite l'idroelettrico è CO2 neutra.

## FISH-FRIENDLY

La vite di Archimede è un sistema operativo non pressurizzato. I pesci possono passare la vite nel loro corso a valle. Il pesce torna per deporre le uova attraverso un passaggio laterale.

## SILENZIOSA

Le viti di Archimede può anche essere installata in aree residenziali.

# LA TURBINA DI TIPO DIVE

Sovrapposizione con Kaplan tradizionale ma con una spinta maggiore verso i bassi salti.  
In che modo?



Realizzazione di una turbina con una **girante fissa** e ottimizzazione dell'efficienza attraverso il controllo della **variazione di velocità**

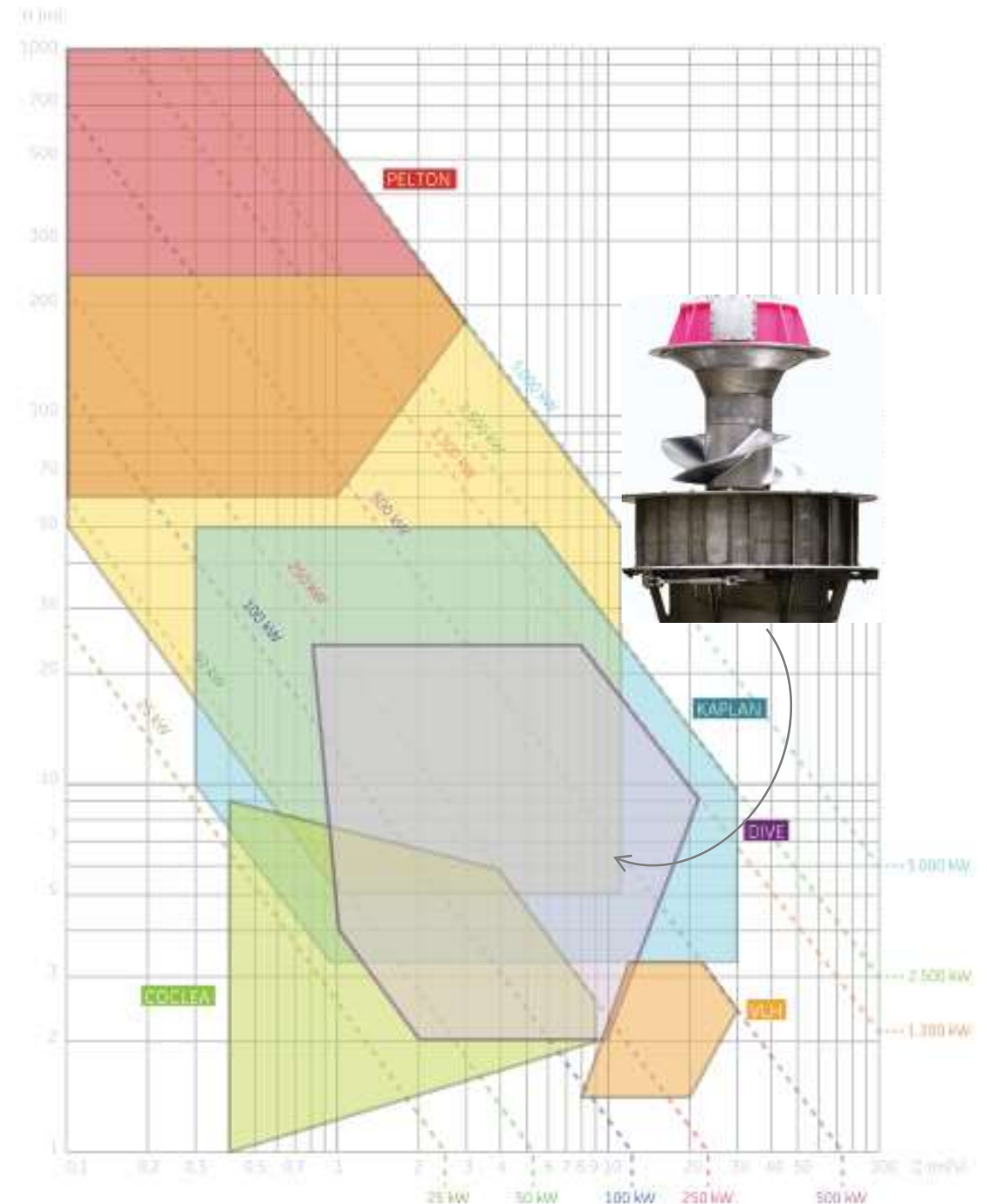

# DIVE: DESCRIZIONE DELLA MACCHINA

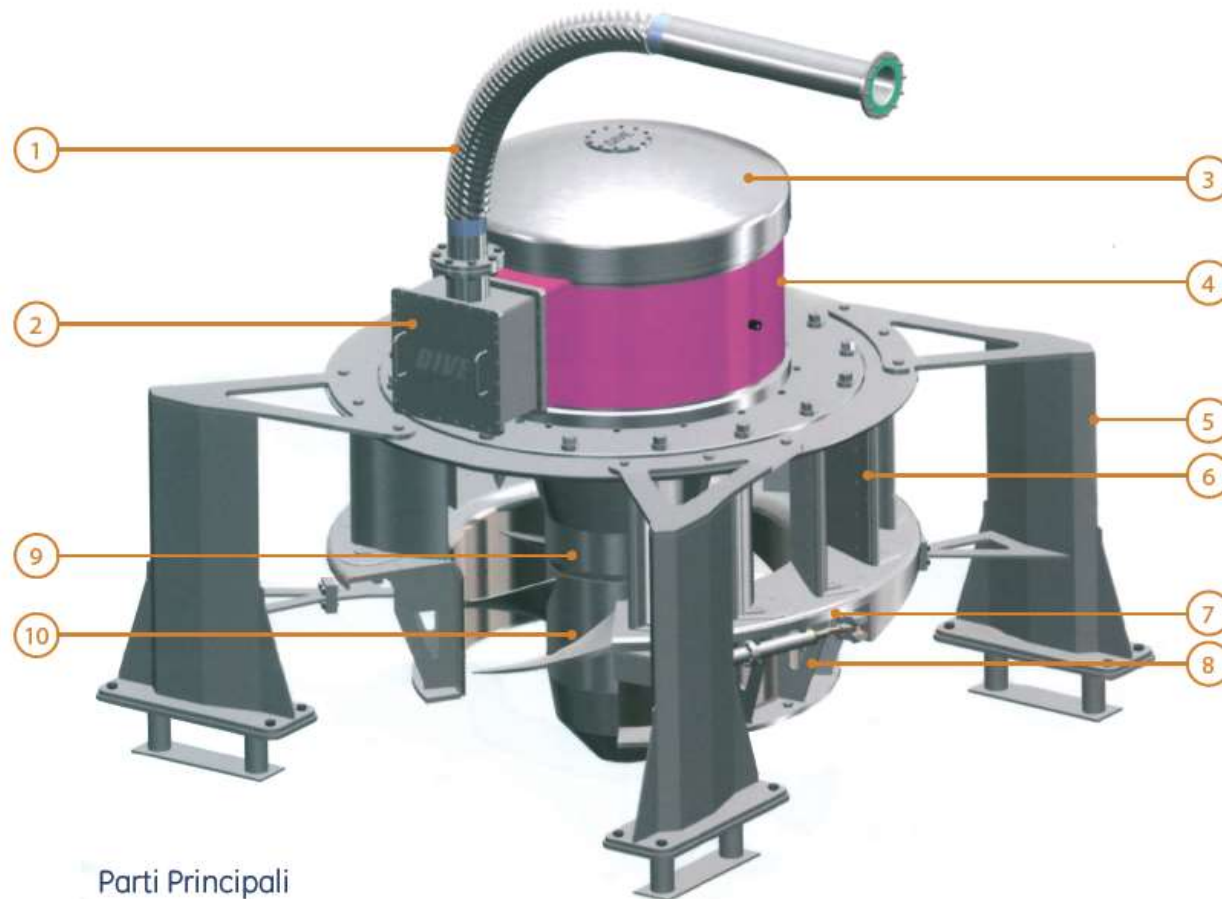

## Parti Principali

1. Tubazione di protezione per i cavi
2. Morsettiera
3. Cofano del generatore
4. Generatore a magneti permanenti OSWALD
5. Ancoraggi anti-torsione

6. Pale del distributore
7. Comando del distributore
8. Scocca
9. Tenuta ruota-statore
10. Pale della ruota DIVE



# DIVE: DESCRIZIONE DELLA MACCHINA

## CAMPI DI APPLICAZIONE

- Salto tra 2 – 25 m
- Portata 1.5 – 20 m<sup>3</sup>/s per turbina
- Potenza nominale da 50 kW fino a 1.300 kW per turbina
- Nuove centrali idroelettriche
- Ristrutturazione e riattivazione di centrali esistenti
- Potenziamento di centrali esistenti
- Integrazione in dighe esistenti (DMV)
- Integrazione in edifici e canali esistenti
- Funzionamento garantito in siti a rischio di allagamento
- Funzionamento garantito in impianti ad acqua marina e di scarico

## DIMENSIONI

Altezza incl. generatore	0.80 - 3.00 m
Diametro della turbina	0.50 - 2.12 m
Diametro incl. distributore	1.00 - 3.50 m



# DIVE: LAYOUT DI CENTRALE

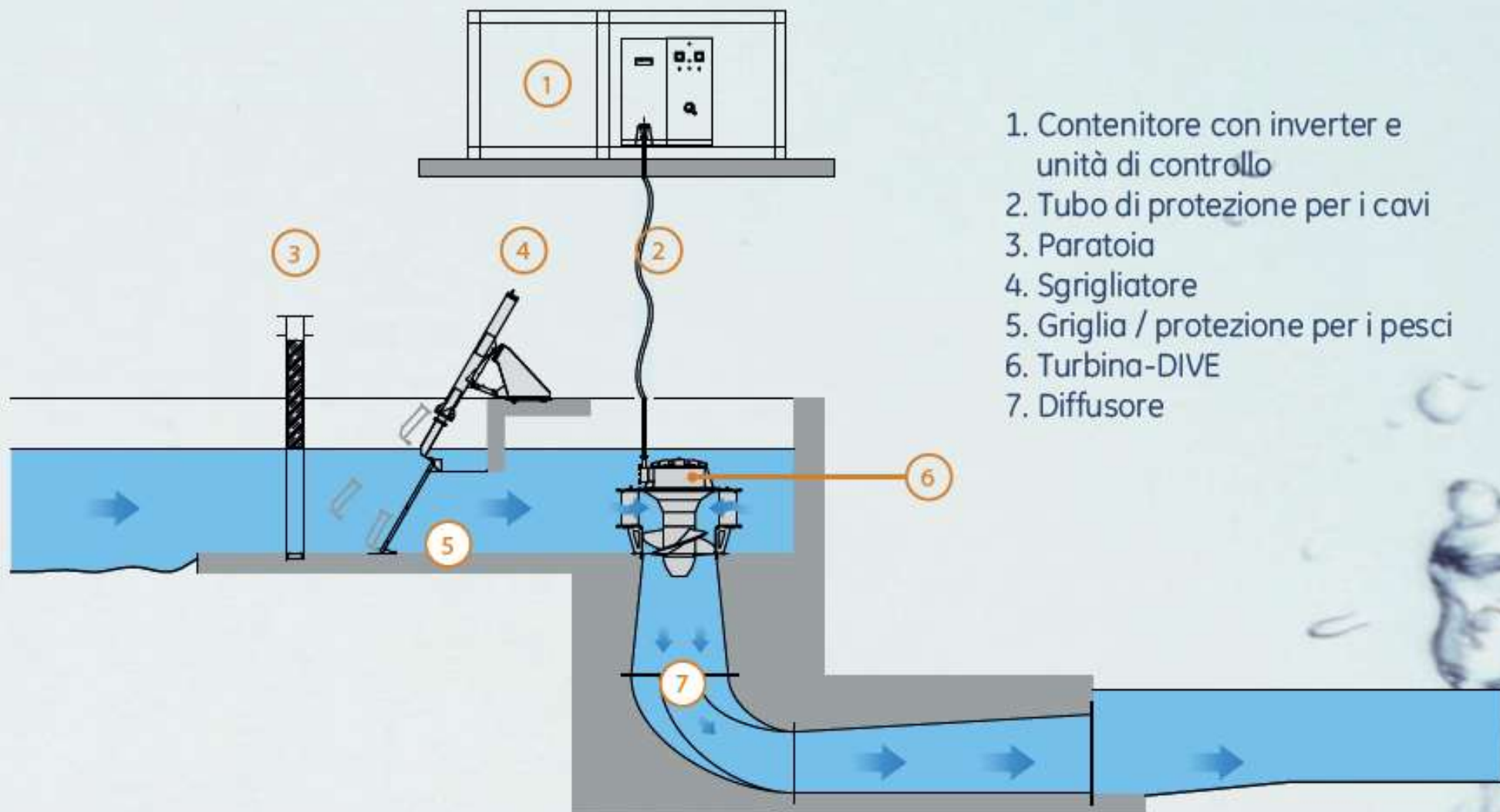

# DIVE: FUNZIONAMENTO A VELOCITÀ VARIABILE

- ❖ Generatore a magneti permanenti
- ❖ Convertitore statico di frequenza

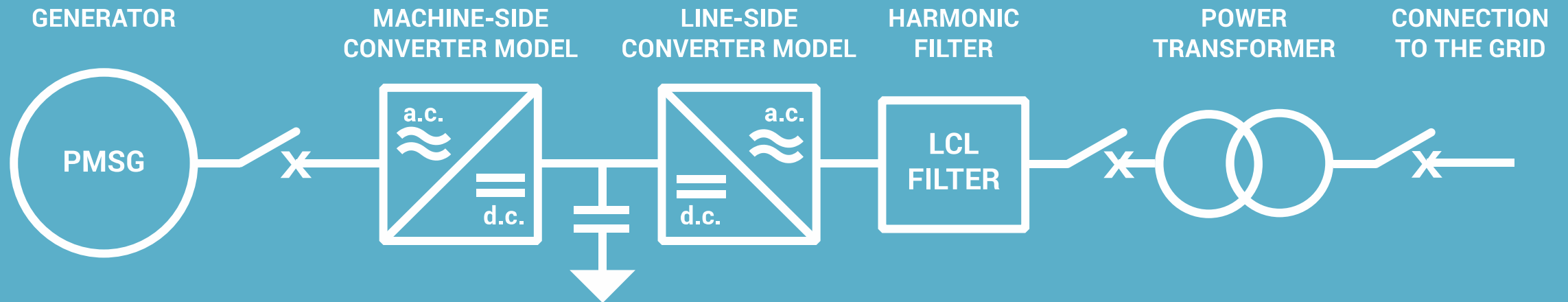

- ✓ Il PMSG può generare coppie molto alte a basse velocità.
- ✓ Connessione diretta della girante della turbina al generatore.
- ✓ Efficienza molto elevata, tra il 95% ed il 98%.
- ✓ La turbina a velocità variabile opera dal 20% fino al 120% della velocità nominale.

# DIVE: IMPATTO AMBIENTALE

Il gruppo turbina-generatore funziona completamente sommerso. L'unica parte sopra l'acqua rimane un tubo flessibile di connessione al Centro di Controllo.

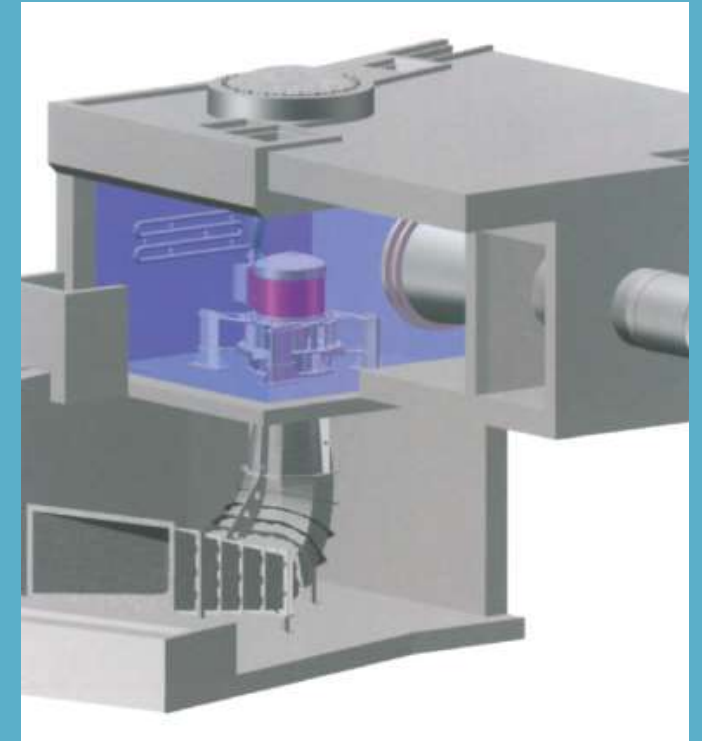
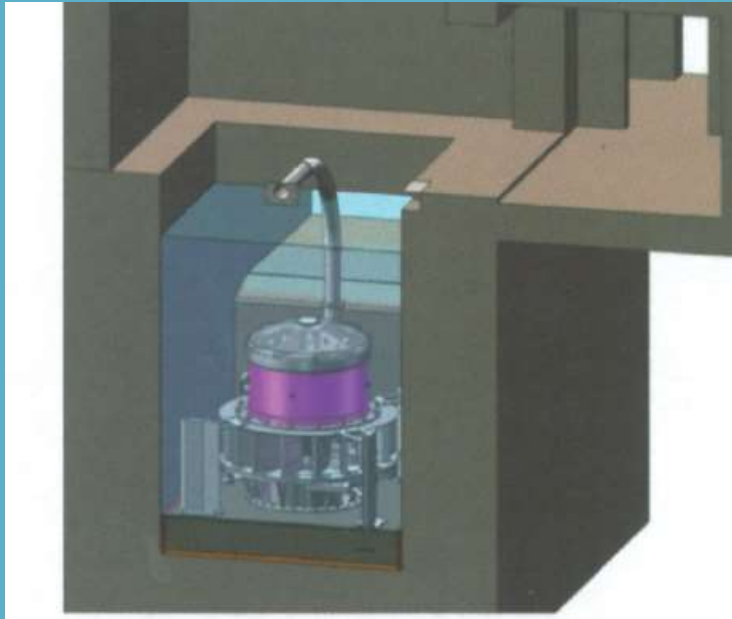

# LA TURBINA DI TIPO VLH

Ampio range di funzionamento con siti a basso salto ed elevata portata.  
Nessuna concorrenza tecnologica.



Concetto totalmente innovativo:  
standardizzazione e raggruppamento,  
importante riduzione opere civili e  
funzionamento a velocità variabile.

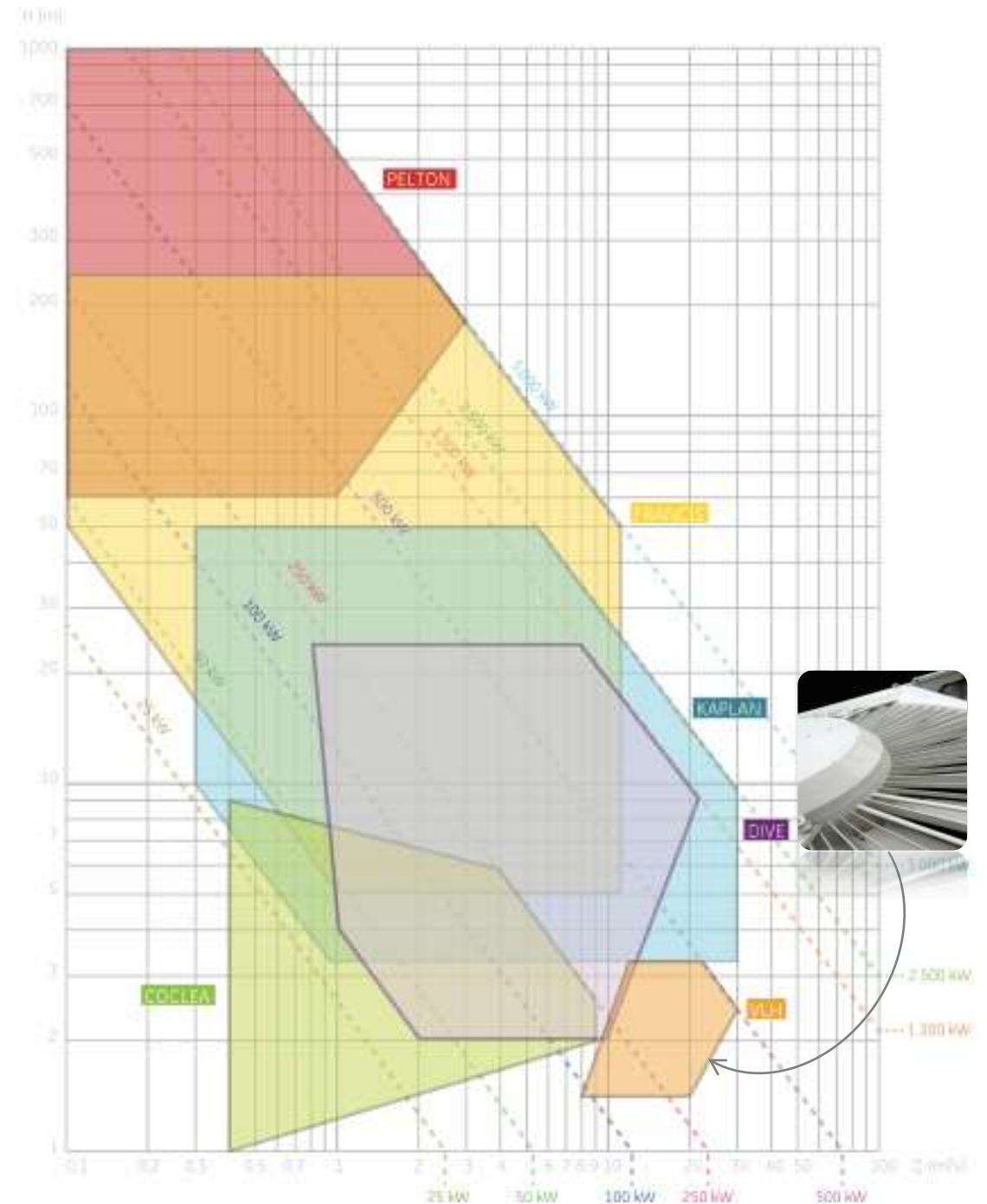

# VLH: VANTAGGI



RIDUZIONE OPERE CIVILI



IMPATTO AMBIENTALE



BASSO SALTO



FUNZIONAMENTO IN ISOLA



FISH FRIENDLY



STANDARDIZZAZIONE DEL PRODOTTO



ELEVATA EFFICIENZA



ELEVATA GAMMA DI SALTI



# VLH: DESCRIZIONE DELLA MACCHINA

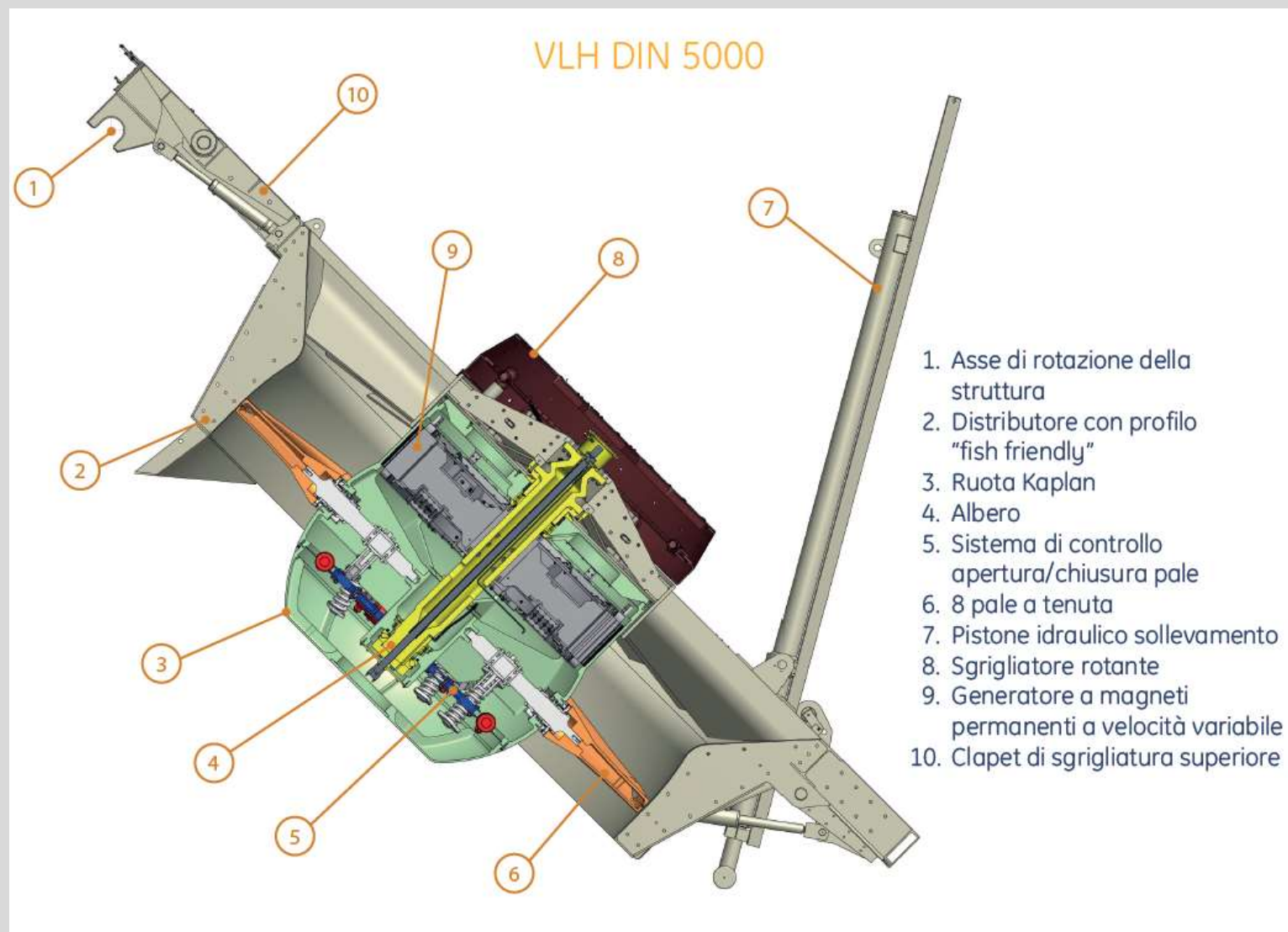

## VLH: SOLUZIONE INTEGRATA

- Turbina **Kaplan standardizzata** con 8 pale regolabili a seconda del livello e della portata.
- Una **struttura autoportante** che permetta il completo montaggio in fabbrica e montaggio / smontaggio molto veloce.
- Un **generatore a magneti permanenti a velocità variabile** e a trasmissione diretta lenta.
- Dispositivo per fermare il flusso chiudendo le pale su loro stesse senza energia dal sistema. Le installazioni VLH non richiedono paratoie.
- Il distributore è utilizzato come griglia di protezione.



## VLH: SOLUZIONE INTEGRATA

- Sgrigliatore rotativo incorporato.
- Apparecchiature di controllo elettronico integrate che gestiscono l'unità turbogeneratore e le apparecchiature elettroniche.
- Dispositivo di sollevamento che permette di togliere l'unità dall'acqua per manutenzione oppure in caso di inondazione.

# VLH: RIDUZIONE OPERE CIVILI

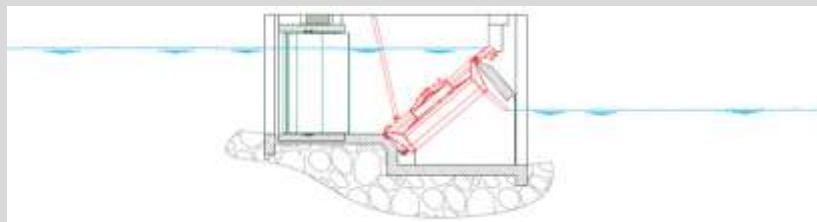
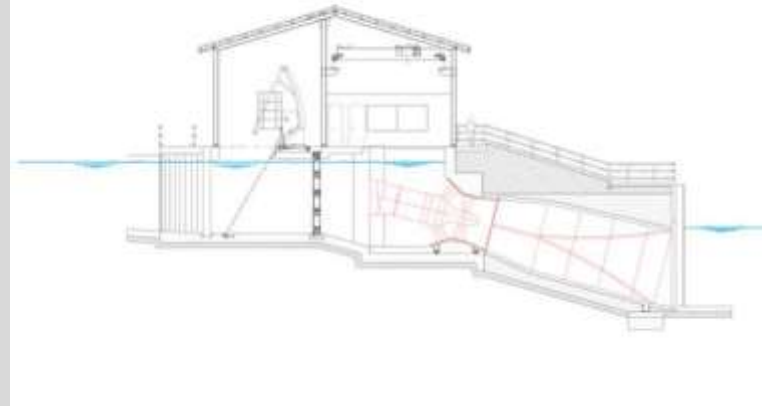
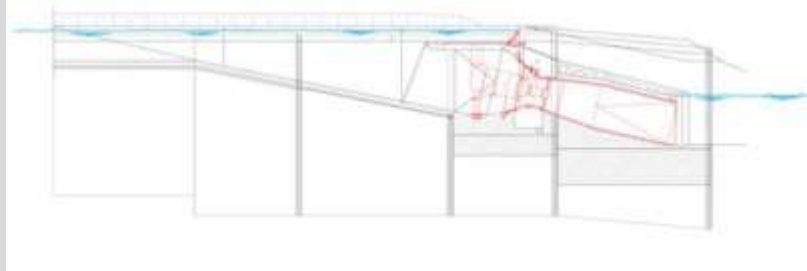
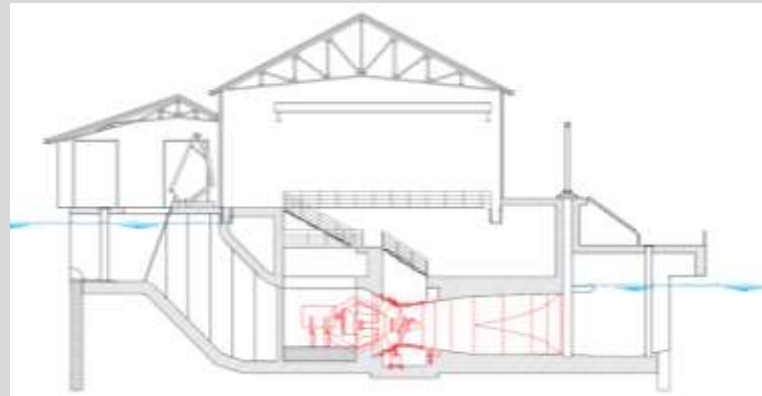
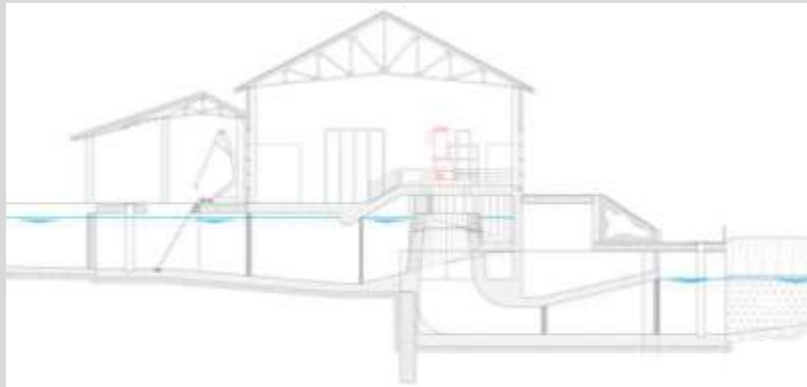

# VLH: BASSO SALTO

## GAMMA SALTO NETTO

Il salto netto trattato dalla VLH si estende da 1.4 a 3.2 m. Il rinforzo delle strutture di supporto ha permesso di rendere accettabili i salti netti superiori ai 4 m per alcuni modelli più piccoli.

## GAMMA DI PORTATE

La gamma delle portate si estende da 10 a 26 m<sup>3</sup>/s.

## GAMMA DI POTENZE

La gamma di potenze per unità va da 100 a 500 kW. Si stima che al di sotto dei 100 kW, è difficile raggiungere la redditività desiderata.

# VLH: ALTA EFFICIENZA

- ❖ Generatore a magneti permanenti
- ❖ Convertitore statico di frequenza

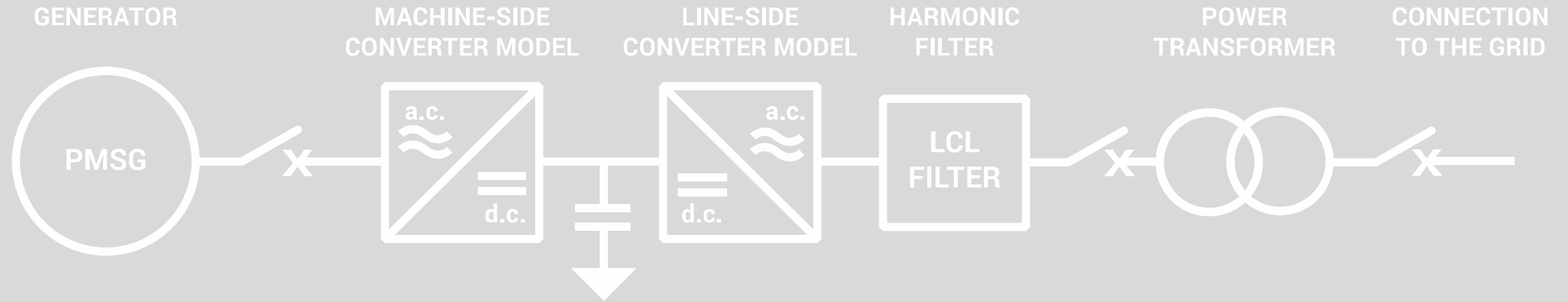

- ✓ Il PMSG può generare coppie molto alte a basse velocità.
- ✓ Connessione diretta della girante della turbina al generatore.
- ✓ Efficienza molto elevata, tra il 95% ed il 98%.
- ✓ La turbina a velocità variabile opera dal 20% fino al 120% della velocità nominale.

# VLH: FISH FRIENDLY

- Ottimizzazione profilo palare



- Test reali di compatibilità



# VLH: IMPATTO AMBIENTALE

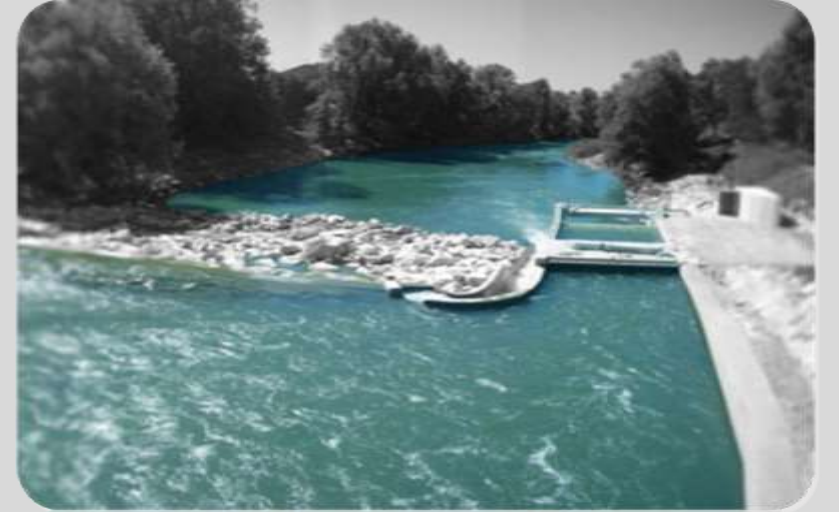

# GRAZIE,



NICOLA BRAGATO  
[n.bragato@ste-energy.com](mailto:n.bragato@ste-energy.com)

S.T.E. Energy S.p.A.  
[www.ste-energy.com](http://www.ste-energy.com)