

Course of Geothermics

Dr. Magdala Tesauro

Course Outline:

1. Thermal conditions of the early Earth and present-day Earth's structure
2. Thermal parameters of the rocks
3. Thermal structure of the lithospheric continental areas (steady state)
4. Thermal structure of the lithospheric oceanic areas
5. Thermal structure of the lithosphere for transient conditions in various tectonic settings
6. Heat balance of the Earth
7. Thermal structure of the sedimentary basins
8. Thermal maturity of sediments
9. Mantle convection and hot spots
10. Magmatic processes and volcanoes
- 11. Heat transfer in hydrogeological settings**
12. Geothermal Systems

Porous Media

Porous Media is a portion of space occupied by heterogeneous matter (Solid Matrix, Gas and/or Liquid and Void Space)

NB: a minimum number of voids must be interconnected, in order to allow for the fluid phases to move !

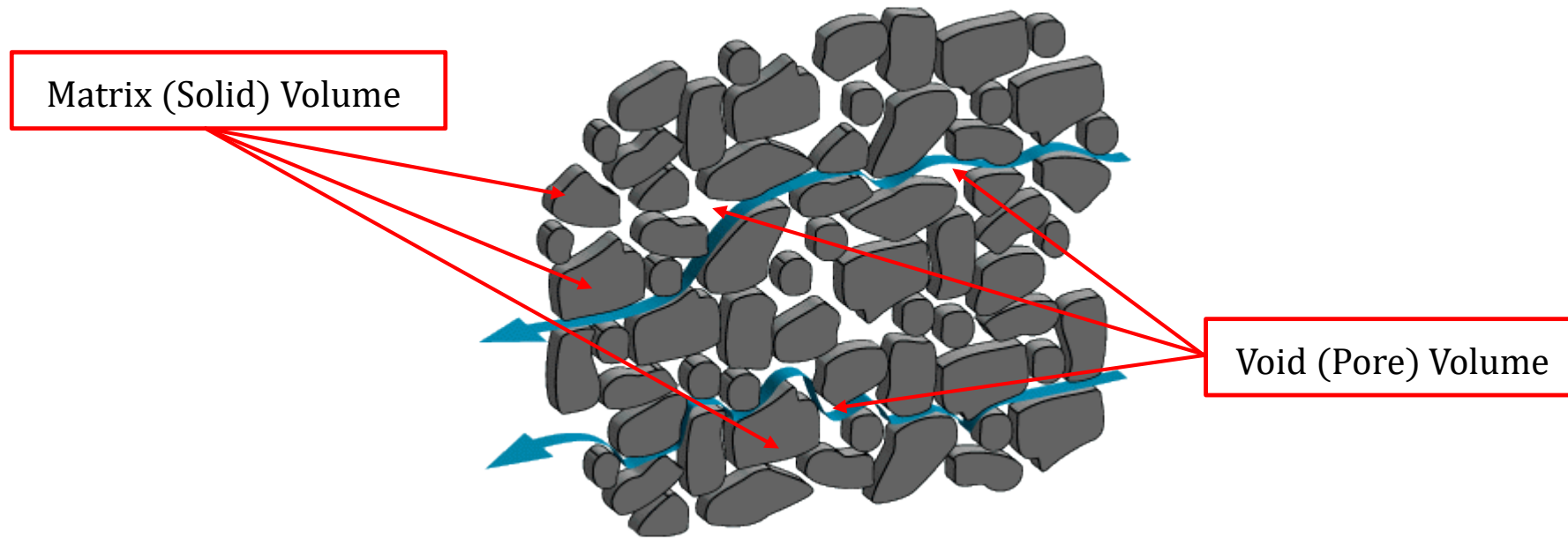

Hornberger et al. (1998)

Fluid Flow in sedimentary basins

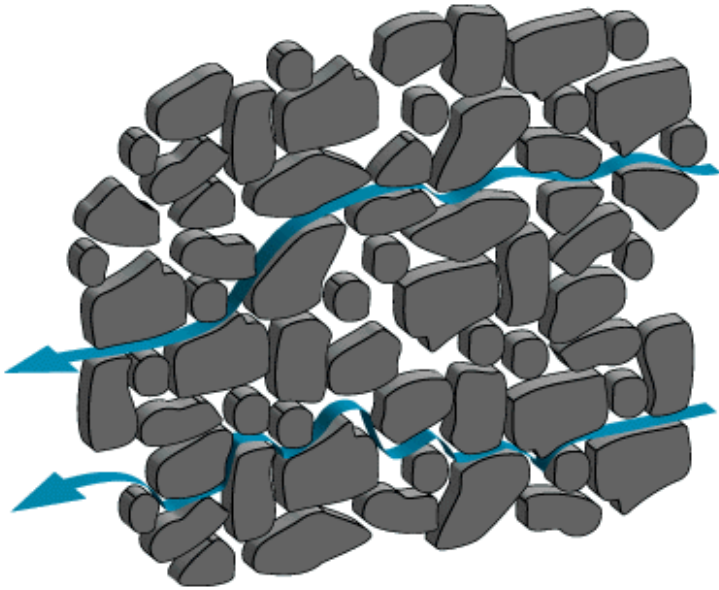

Hornberger et al. (1998)

Pore space (ϕ) is mostly filled with water

- **Meteoric water:** groundwater originated from rainwater
- **Connate water:** Seawater buried with sediments
- **Juvenile water:** hydrothermal water by igneous activity
- **Formation water:** produced during oil or geothermal production

Porosity

- Consists of rock and pore space (void space)

Total porosity $\frac{V_{void}}{V_{total}}$ ← $\varphi + c = 1$ → **Matrix Volume fraction** $\frac{V_{pore}}{V_{total}}$

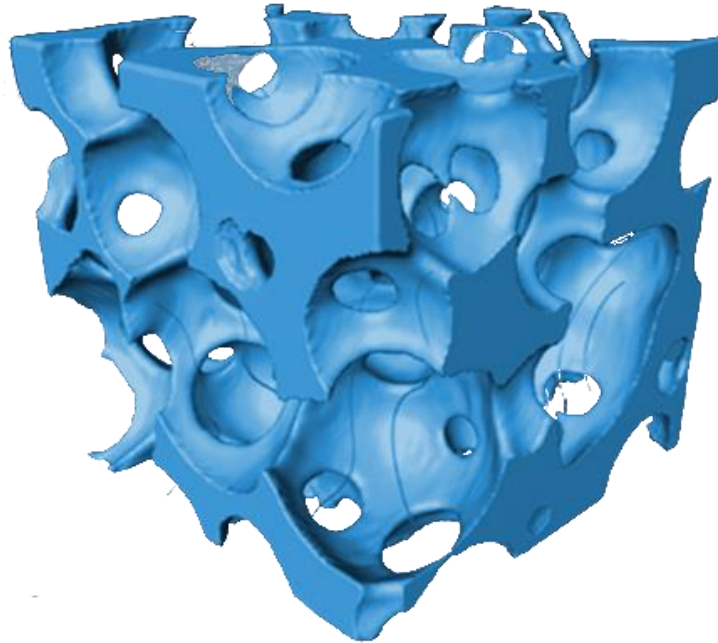

Effective Porosity

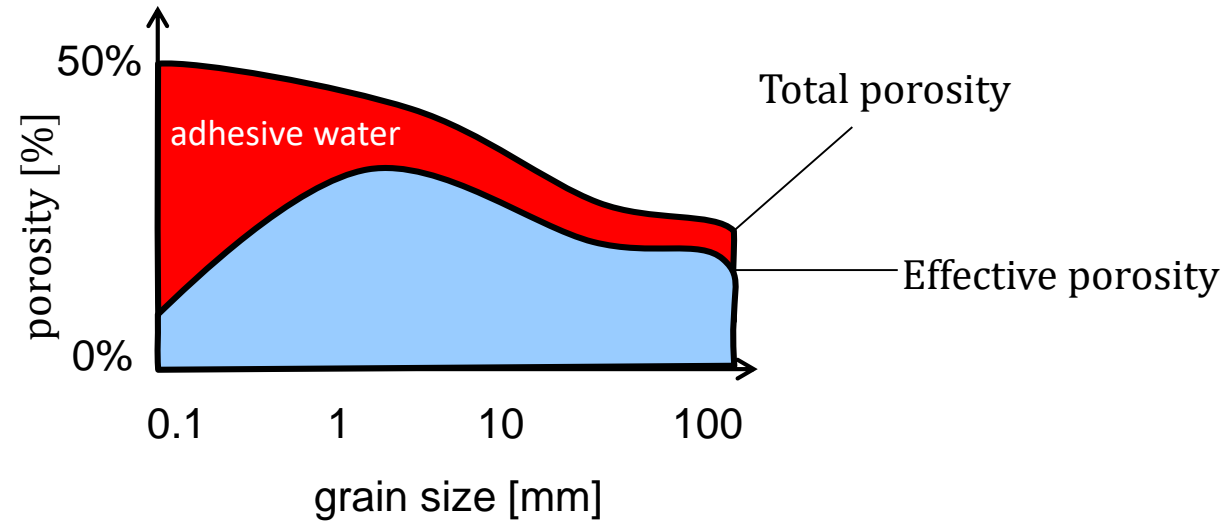
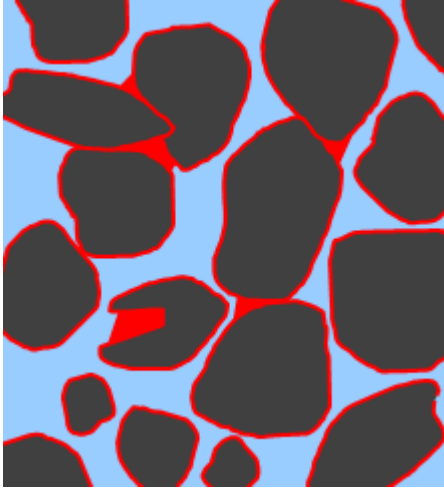

Effective porosity

$$\varphi_{\text{eff}} = \varphi_{\text{tot}} - \varphi_{\text{adh}}$$

Permeability

Friction Loss along the walls of the grains

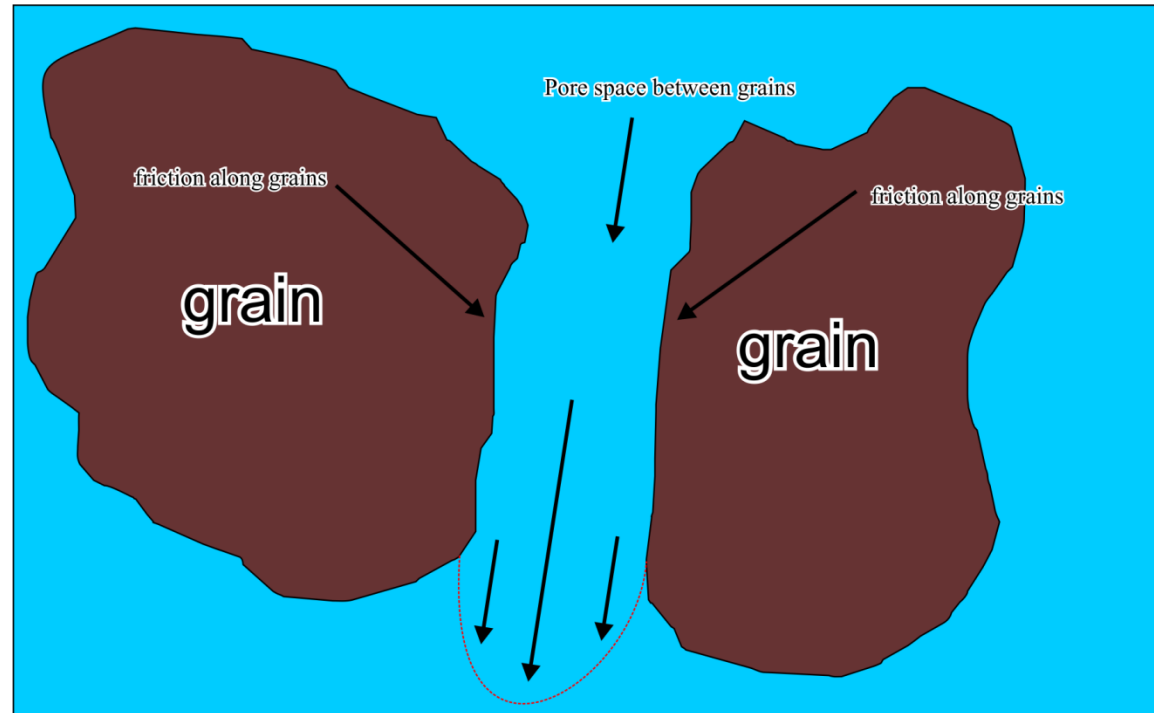

Smaller pores → more frictional resistance → lower permeability

Permeability and Rheology

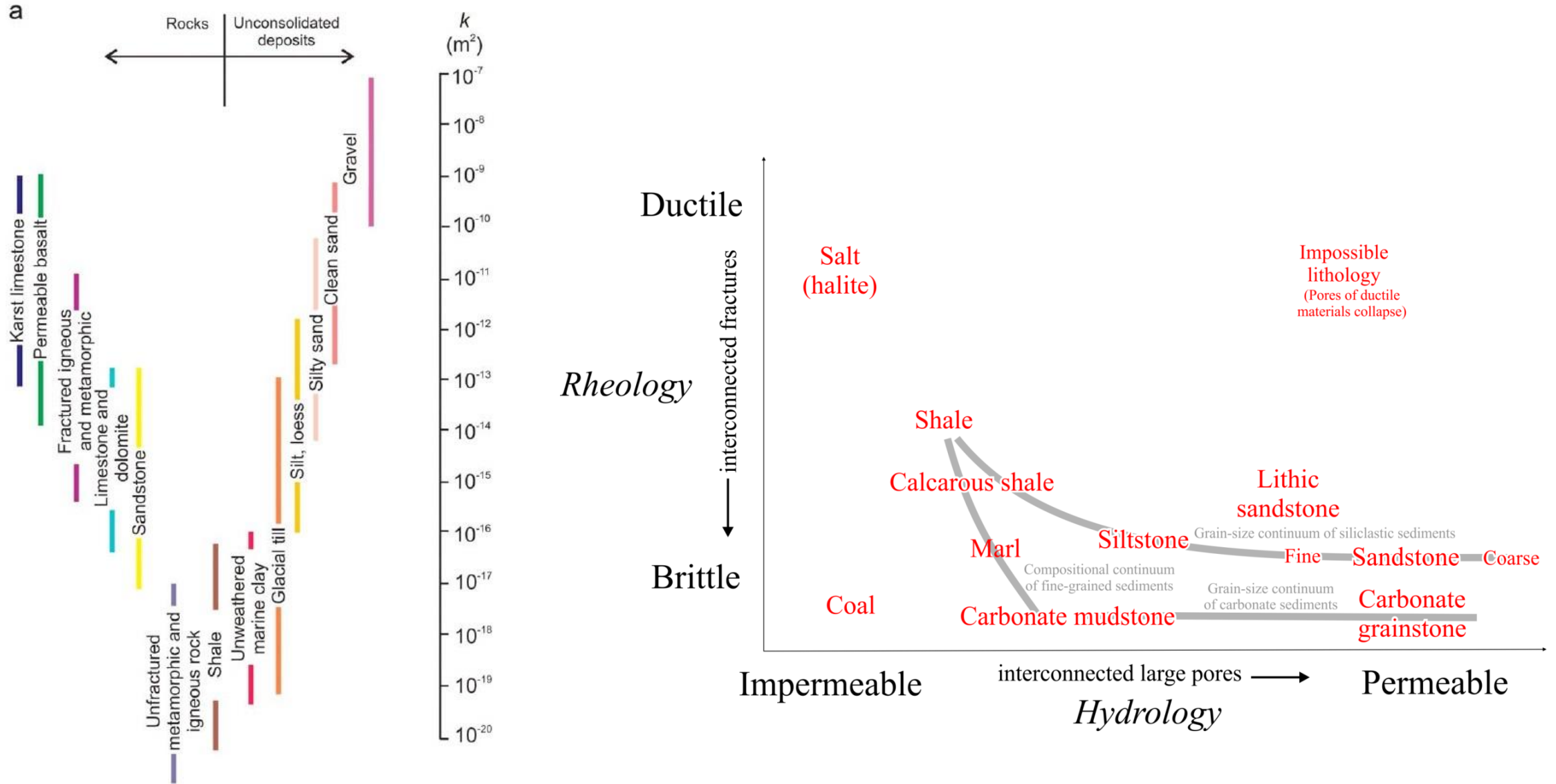

Permeability

K=hydraulic conductivity

$$K = \frac{k}{\mu}(\rho g), \text{ SI } [ms^{-1}]$$

k = intrinsic permeability, SI [m^2] Porous medium property

μ = dynamic viscosity, SI [Pas]

Fluid properties

ρ = fluid density, SI [kgm^{-3}]

g = gravitational constant, SI [ms^{-2}]

- A combined property of the medium and the fluid
- Ease with which fluid moves though the medium

Fluid Flow in sedimentary basins



Because ...

Groundwater flow in sedimentary basins follows Darcy's law

$$v_f = -K \nabla h$$

- Flux of water through a permeable formation (v_f) is proportional to the head loss (∇h = distance between top and bottom of the soil column)
- The constant of proportionality is called **hydraulic conductivity** (K , SI [ms^{-1}])

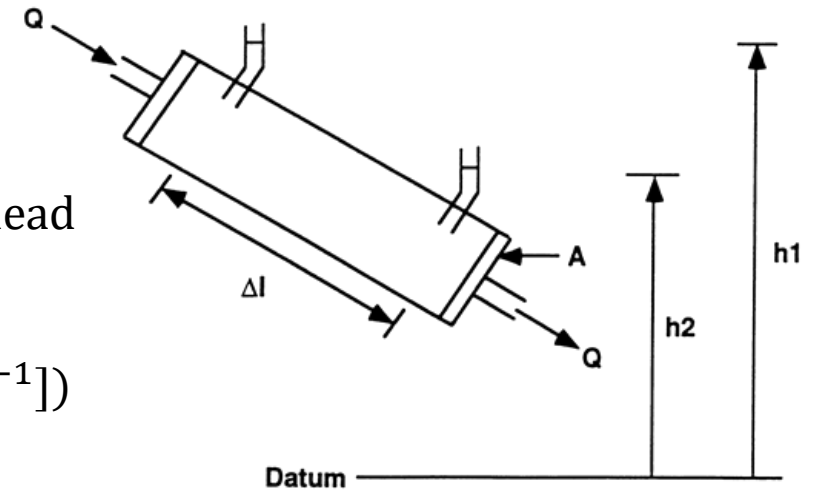

Fluid Flow in sedimentary basins

Darcy velocity

$$v_f = -K \nabla h$$

- Macroscopic concept (easily measured)
- Flow rate per unit of cross sectional Area
($v_f = \frac{Q}{A}$)
- Different from the real microscopic velocities
- Microscopic velocities are real, they are impossible to measure

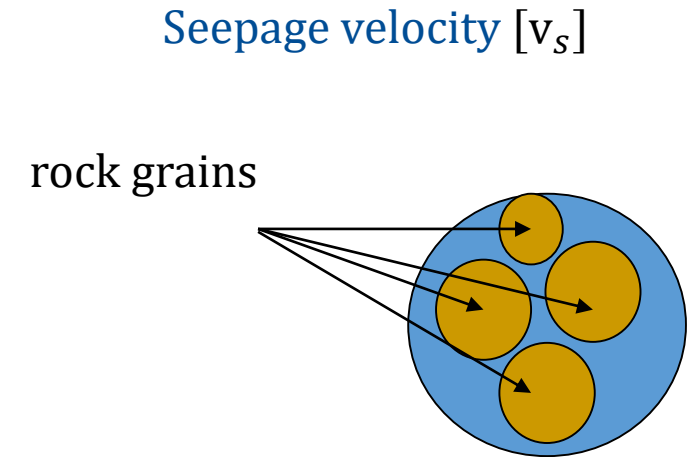

Fluid Flow in sedimentary basins

Seepage velocity [v_s]

$$Q = A \cdot v_f = A_v \cdot v_s$$

Q = flow rate

A = total cross sectional area of the material

A_v = cross sectional area of the voids

v_f = Darcy velocity

v_s = seepage velocity

$$v_s = v_f \left(\frac{A}{A_v} \right)$$

$$v_s = v_f \left(\frac{A \cdot \Delta l}{A_v \cdot \Delta l} \right) = v_f \left(\frac{V}{V_v} \right)$$

$$v_s = v_f \cdot \phi$$

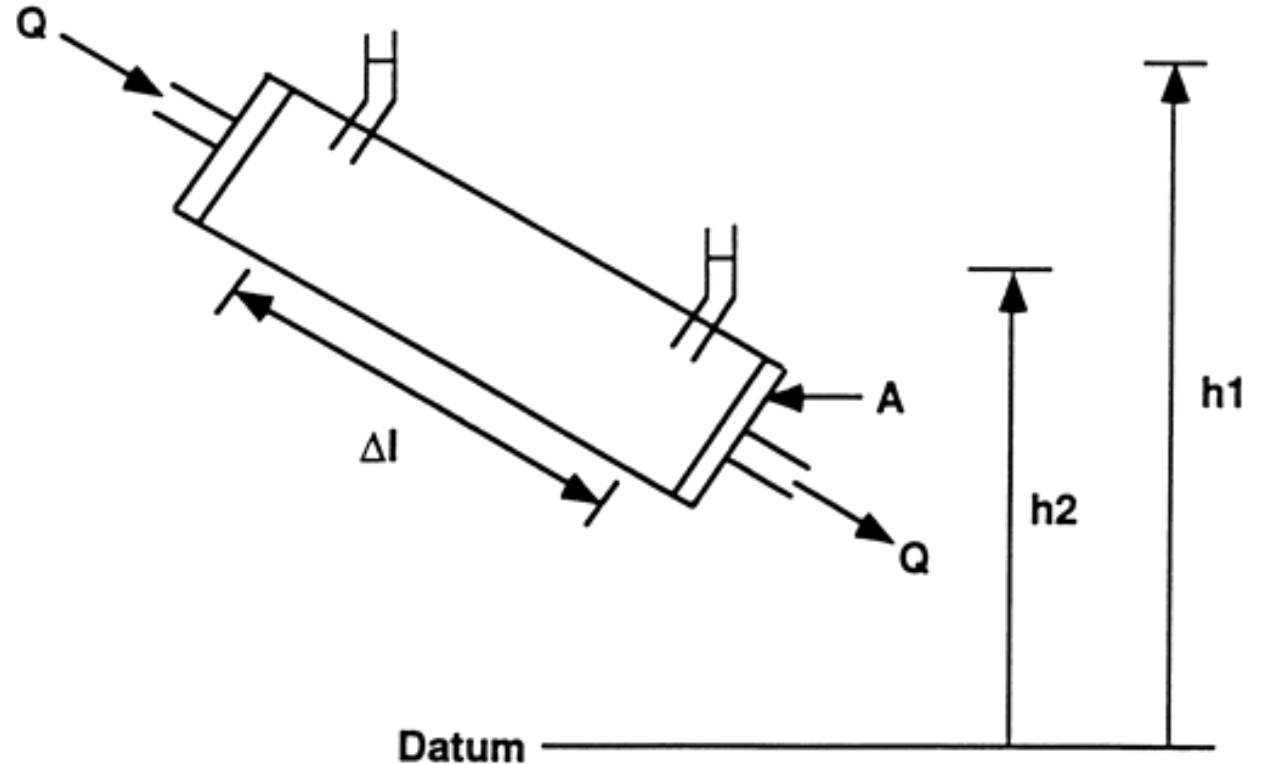

Darcy's Law

$$\frac{Q_{out}}{A} = K \frac{\Delta h}{\Delta L}, \quad K = \frac{k}{\mu} (\rho g)$$

$$I = \frac{dh}{dl} = \frac{\Delta h}{\Delta l}$$

I=Hydraulic Gradient

$\Delta h = h_2 - h_1$ = difference between hydraulic heads measured at two different points Δl = distance between the points at which hydraulic heads were measured.

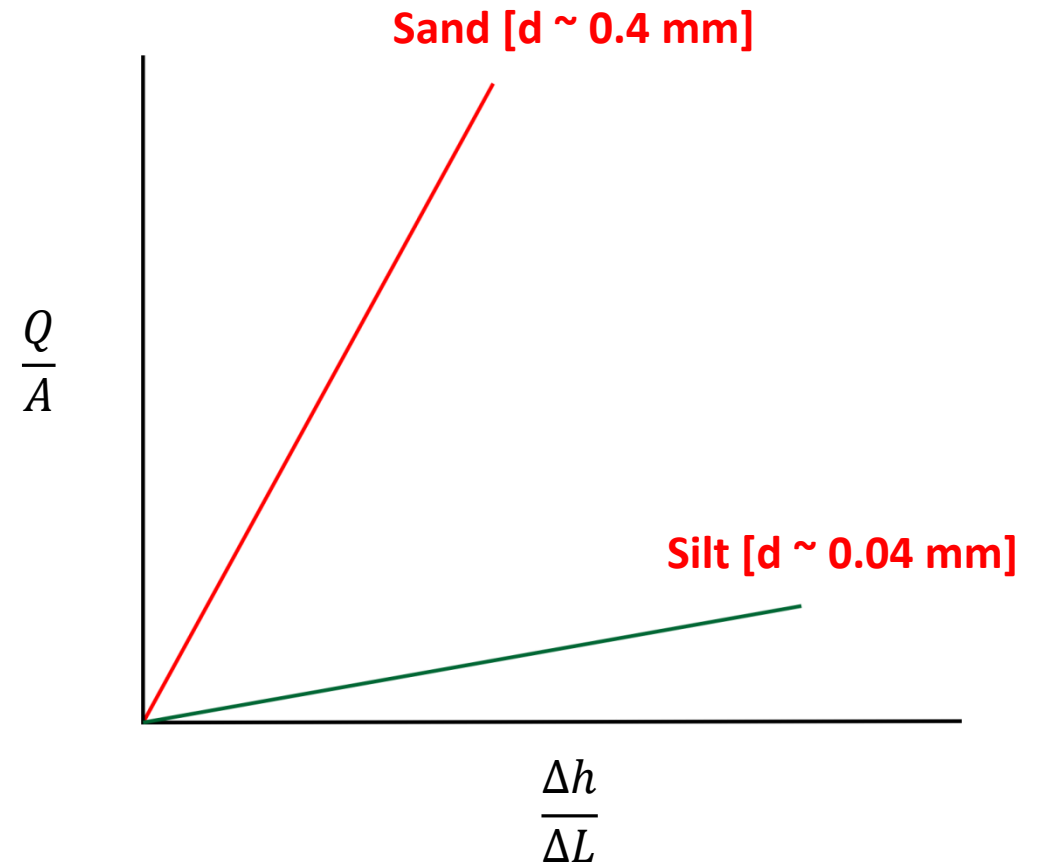
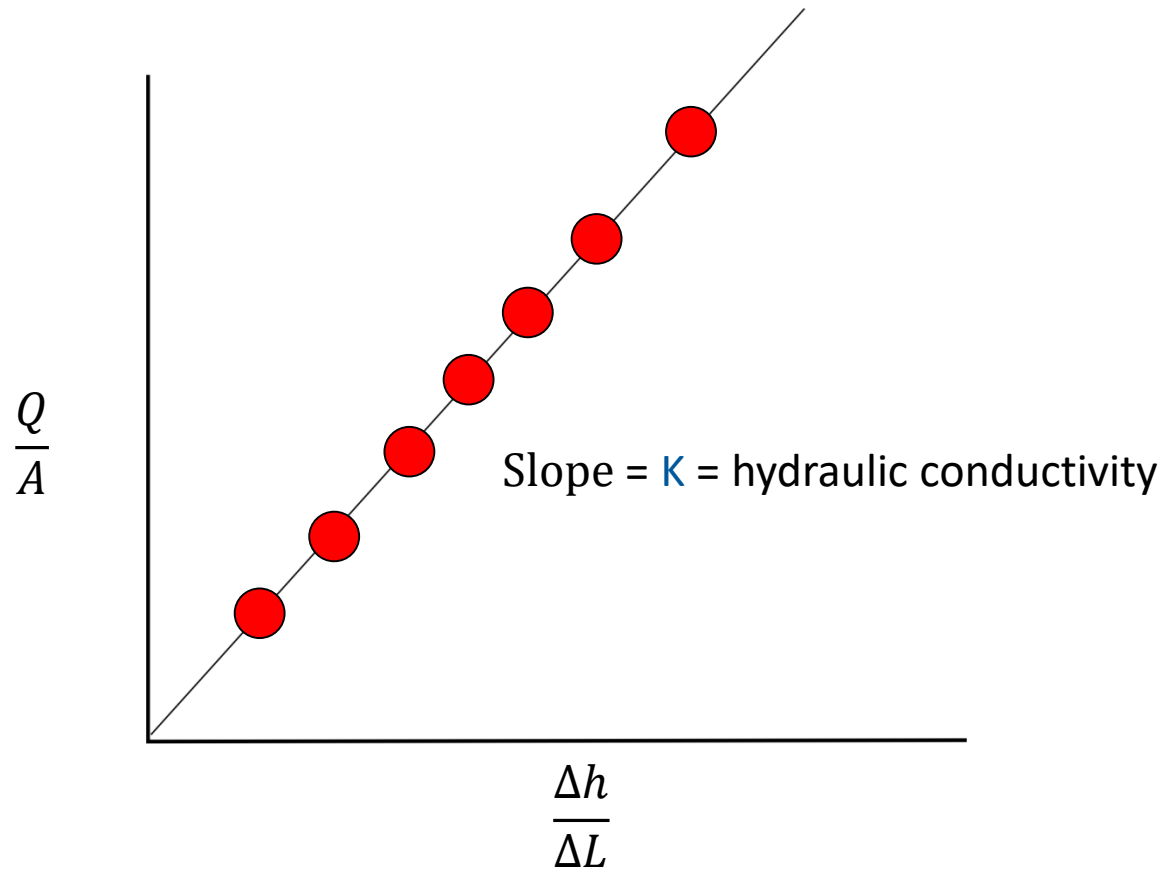

Principle of Bernoulli

Bernoulli's principle: for an ideal fluid flow, an increase in the speed of a fluid occurs simultaneously with a decrease in pressure or a decrease in the fluid's potential energy

$$\frac{\sigma v^2}{2} + \sigma g z + P = \text{const.} \qquad \frac{\sigma v^2}{2} = P_D$$

v =fluid flow velocity at a point, g =gravity acceleration z =elevation of the point above a reference plane, P =static pressure at the point, σ =density of the fluid, P_D = dynamic pressure, and $\sigma g z$ = pressure formed by the elevation of the point above a reference plane.

$$h = z + \frac{P}{\sigma g} \qquad h = \text{piezometric (or hydraulic) head}$$

$$h_T = h + v^2/2g \qquad h_T = \text{dynamic head}$$

$$\frac{P}{\sigma g} = \text{pressure head} \qquad v^2/2g = \text{velocity head (negligible if the water moves slowly)}$$

Principle of Bernoulli

$$p_1 + \frac{1}{2}\rho v_1^2 + \rho g h_1 = p_2 + \frac{1}{2}\rho v_2^2 + \rho g h_2$$

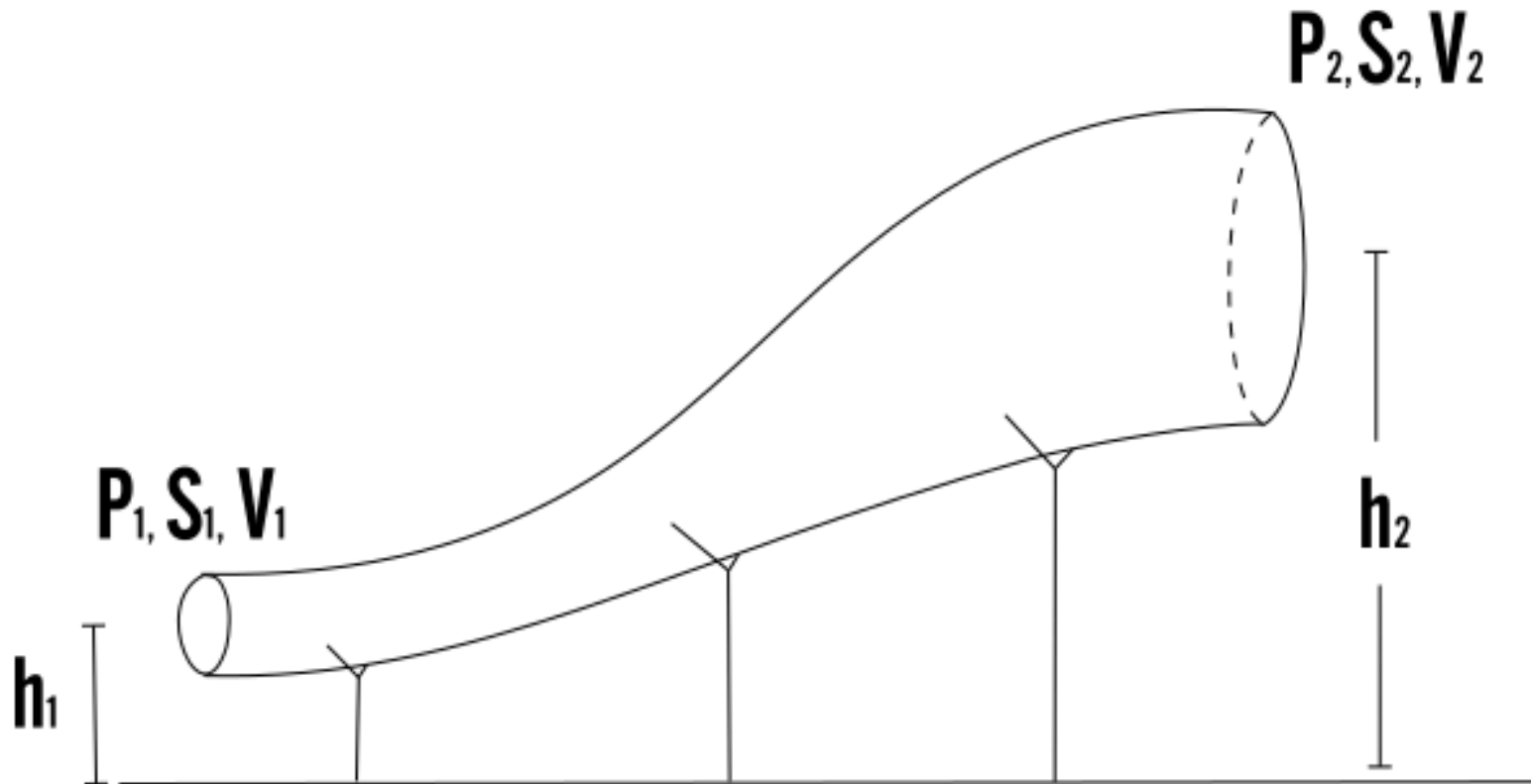

Water in the underground

- An aquifer (saturated zone) is an underground layer of water-bearing permeable rock.
- A typical hydrological system on land is composed of an unsaturated zone, an unconfined aquifer (between the water table and the first confining bed or aquitard), and confining aquifers separated by aquitards.
- Water has an extremely high heat capacity ($C_{pw} = 4186 \text{ Jkg}^{-1}\text{K}^{-1}$) compared to rocks ($C_{pRocks} \sim 1000 \text{ Jkg}^{-1}\text{K}^{-1}$) and the constant movement of groundwater favours a fast heat transfer.
- Groundwater flow involves three major processes: groundwater recharge, groundwater flow through permeable aquifers, and groundwater discharge.

- Water in underground storage is usually divided in the part that drains under the influence of gravity (**specific yield**), and the part that is retained as a film on rock surfaces and in very small pores (**specific retention**).
- Specific yield shows how much water is actually available, and specific retention shows how much water remains in the rock after it is drained by gravity.

Fluid Flow in sedimentary basins

Porewater flow is oriented perpendicular to isopotential lines (steepest hydraulic gradients)

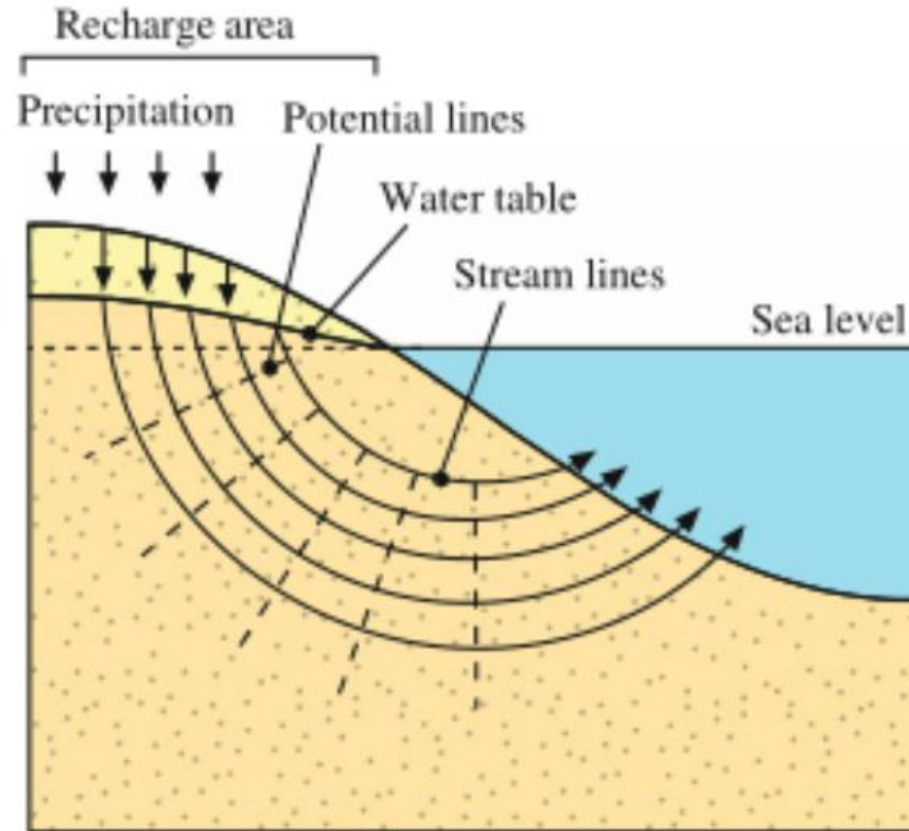

Only for homogeneous sediments

Fluid Flow in sedimentary basins

But sediments are heterogeneous, groundwater flow is highly compartmentalized ...

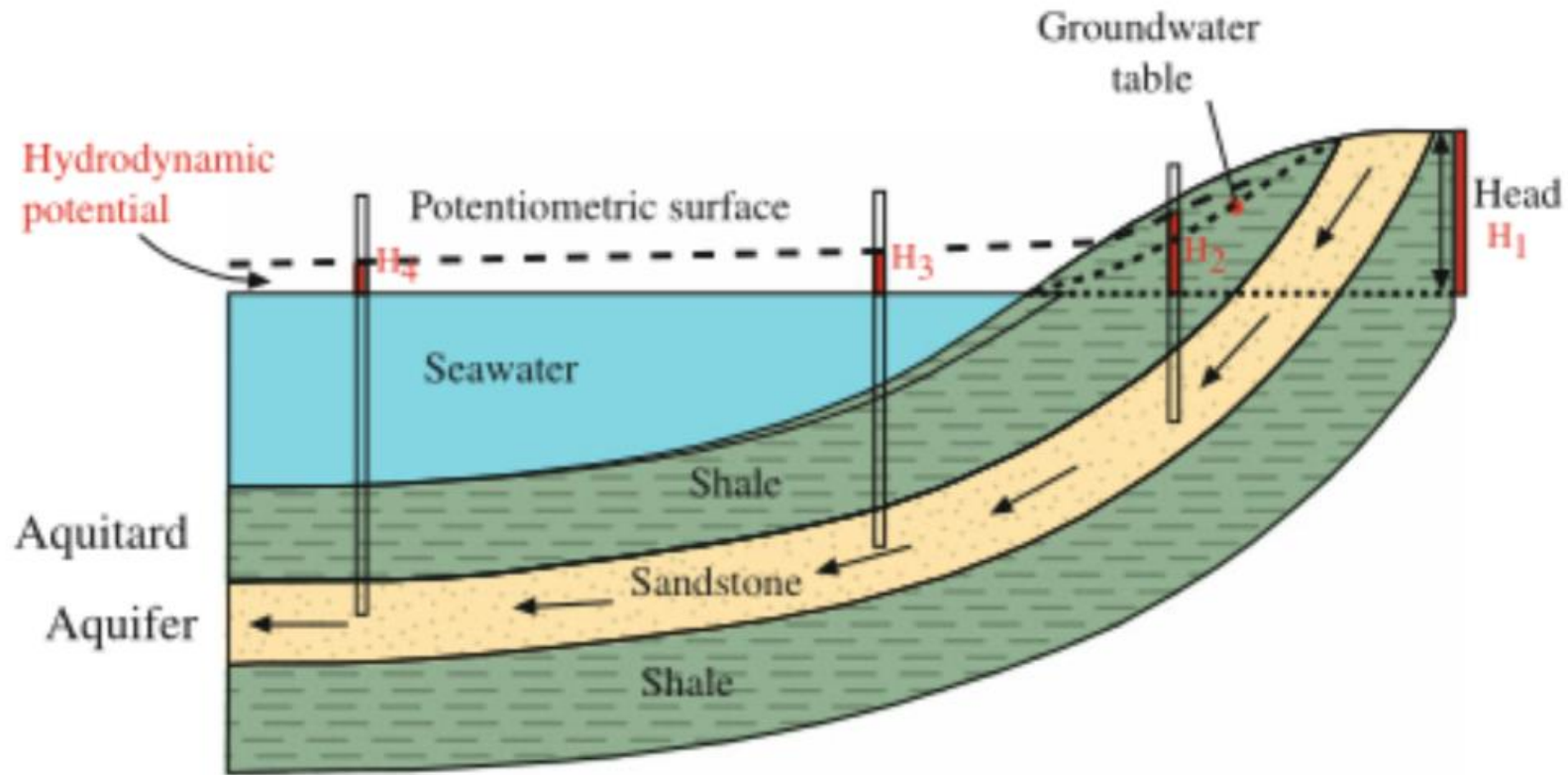

Bjørlykke (1994)

Fluid Flow in sedimentary basins

Darcy's law: $v_f = -K \nabla h$

- provides an accurate description of the flow of groundwater in almost all hydrogeologic environments
- allows an estimate of:
 - velocity (flow rate) moving within the aquifer
 - average time of travel from the head of the aquifer to a point located downstream

Equations of groundwater flow

Darcy's law ($v_f = -K \nabla h$) + Conservation of fluid mass (Inflow = Outflow)

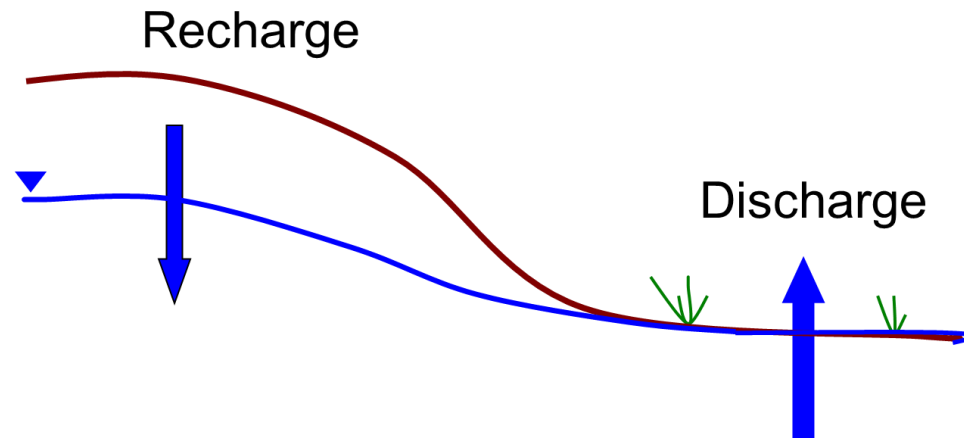

Fluid Flow in sedimentary basins

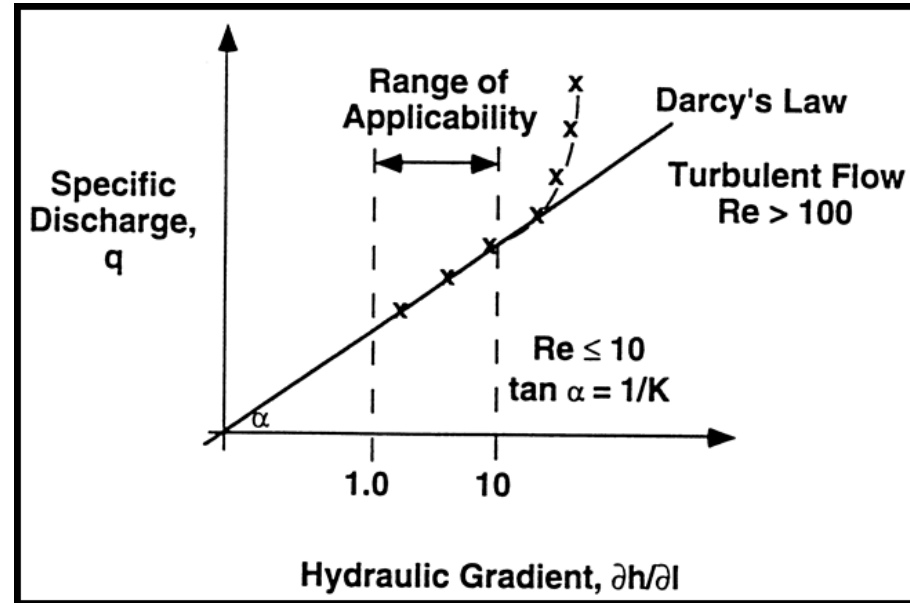

Darcy's law is not applicable where:

- For $Re > 10$ or where the flow is turbulent (pumped wells)
- Water flows through extremely fine-grained materials (colloidal clay)

Groundwater recharge/discharge

- Groundwater recharge is a hydrologic process where water infiltrates from the surface into underground horizons to replenish aquifers with water.
- Recharge of the saturated zone occurs by percolation of water from the land surface through the unsaturated zone and occurs both naturally (by natural precipitation, rivers and lakes) and artificially (by human activities, such as borehole injection, artificial ponds).
- Groundwater recharge areas are at local heights and discharge areas are at local depressions, since these processes are driven by gravity.
- The rate of groundwater recharge that occurs in any particular area depends on different factors, such as the climate, topography, superficial geology, the kind of aquifer of the area.

Total groundwater recharge

$$R_T = \sum_i R_i$$

The recharge depends mainly on precipitation and thus is intermittent, while the discharge is a continual process.

Goundwater recharge/discharge

- Different methods are used to estimate the recharge rate: lysimeter method, soil water budget models, the water table fluctuation method, numerical modeling of the unsaturated zone, the zero flux plane method, the Darcy method, the tritium profiling method, the chloride profiling method, etc.
- An empirical relationship for recharge as a function of annual precipitation is:

$$R = 2.0(\text{Pr} - 15)^{0.4} \quad (\text{Kumar and Seethapathi, 2002})$$

R = net recharge due to precipitation during the year (inch), Pr = annual precipitation (inch)

- If chloride is present in an unsaturated zone as a result of atmospheric deposition, and in the absence of other sources or sinks of chloride ions in the unsaturated zone, the recharge rate (R):

$$R = \frac{C_{ic}}{C_z} Pr$$

C_z = mean chloride ion concentration in soil water (in mg/l), Pr = precipitation (in mm/year), C_{ic} = chloride ion concentration in rainfall (in mg/l).

Transmissivity

Transmissivity is the rate at which water is transmitted through a unit width of an aquifer under a unit hydraulic gradient. The transmissivity (Tr) of an aquifer is equal to the hydraulic conductivity of the aquifer multiplied by the saturated thickness (b) of the aquifer:

$$Tr = \kappa b \quad Tr = \frac{Q}{W} \left(\frac{dl}{dh} \right)$$

Q = amount of water moving through the width (W) of the aquifer

b =saturated thickness of the acquirer

κ =hydraulic conductivity

$$\kappa = K \sigma \frac{g}{\mu}$$

K = permeability (in m^2), κ = hydraulic conductivity (m/s), μ = dynamic viscosity (Pa s), σ = density of the fluid (kg/m^3) and g = gravity acceleration (in m/s^2).

Discharge

$$q_T = \sum_i q_i$$

Groundwater discharge (q) is the flow rate of groundwater through an aquifer: $q = \kappa A \frac{dh}{dl}$

κ = hydraulic conductivity of the aquifer A = area the groundwater is flowing through

Water reservoir

Amount of water stored:

$$\Delta S = \sum_i R_i - \sum_i q_i$$

Only the part of aquifer porous water that will drain under the influence of gravity (usable volume capacity V_U):

$$V_U = K_{OP} V_0$$

V_0 = total volume of aquifer and K_{OP} = effective porosity of rock comprising the aquifer (e.g., 23 % for an unconfined aquifer)

- **Underground water can also be contained in reservoirs confined in fields at much greater depths. This water usually does not move, but can absorb significant amounts of heat due to the very high heat capacity of water.**

To estimate the extra-heat energy absorbed by water, if the initial volume of water is V_0 and the initial P and T within the reservoir are P_1 and T_1 :

$$P_1 = P_0 + \frac{\alpha_W}{\beta_W} (T_1 - T_0) - \frac{1}{\beta_W} \frac{\Delta V}{V_0}$$

α_w = coefficient of the thermal expansion β_w = volume and compressibility of water, P_0 and T_0 = normal pressure and temperature of water in the reservoir, ΔV = change in the initial volume V_0 .

Water and oil reservoir

If some water V_1 is pumped out of the reservoir at the pressure and temperature within the reservoir, the rest of water and the pressure within the reservoir will drop to P_2 , since the water will take the initial volume of water within the reservoir V_0 :

$$P_2 - P_1 = -\frac{1}{\beta_W} \frac{V_1}{V_0} \qquad V_0 = -\frac{1}{\beta_W} \frac{V_1}{(P_2 - P_1)}$$

(change of volume = V_1 , change of temperature is negligible)

If the reservoir is filled with water and oil (P_1 and T_1 = initial pressure and temperature):

$$V_0 = V_{W0} + V_{N0}$$

V_{W0} = initial volumes of water V_{N0} = initial volumes of oil

If some water/oil V_1 is pumped out of the reservoir:

Change of volume

$$V_1 = \Delta V_{W1} + \Delta V_{N1} \qquad \Delta V_{N1} = V_1 - \Delta V_{W1}$$

Change of pressure

$$P_2 = P_1 + \frac{\alpha_W}{\beta_W} (T_2 - T_1) - \frac{1}{\beta_W} \frac{\Delta V_{W1}}{V_{W0}} \qquad P_2 = P_1 + \frac{\alpha_N}{\beta_N} (T_2 - T_1) - \frac{1}{\beta_N} \frac{V_1 - \Delta V_{W1}}{V_{N0}}$$

Heat in groundwater flow

Groundwater flow can be described by Darcy's law, in which the velocity of water u is connected with its pressure in the form:

$$u = -\frac{\kappa_p}{\eta_w} \nabla (p + \rho_w g z) = -\frac{\kappa_p \rho_w g}{\eta_w} \nabla H_h = -\lambda_c \nabla H_h \quad H_h = z + p/(\rho_w g)$$

u = average velocity per unit area, κ_p = permeability, η_w = water dynamic viscosity and ρ_w = water density, p = pressure, H_h is the hydraulic head, z is the elevation above a standard datum, g = gravity acceleration, gH_h = hydraulic potential, and $\lambda_c = \kappa_p \rho_w g / \eta_w$ = hydraulic conductivity

The heat transferred from rock to water depends on u , the volumetric heat capacity of water ($\rho_w c_w$) and the thermal gradient in the direction of u :

$$\rho c \frac{\partial T}{\partial t} = k \nabla^2 T - \rho_w c_w (\mathbf{u} \cdot \nabla T)$$

ρ_w = water density, c_w = specific heat of water, c = specific heat, ρ = density, k = thermal conductivity of the water-rock matrix, t = time

Heat in groundwater flow vertical flow

When the flow in an aquifer occurs due to an externally applied pressure gradient, the heat is transferred through a mechanism known as **advection**. When the flow occurs due to buoyancy effect, the mechanism of heat transfer is the **convection**.

$$\frac{d^2 T}{dz^2} = \frac{\rho_w c_w \kappa_p}{k \eta_w} \left[\frac{d}{dz} (p + \rho_w g z) + g z \frac{d\rho_w}{dz} \right] \frac{dT}{dz}$$

$$\alpha_w = (d\rho_w/dT)/\rho_w$$

α_w =water thermal expansion coefficient

For thermal steady state conditions the conductive heat transfer, heat advection, and thermal convection in a homogenous permeable layer is expressed by:

$$\frac{d^2 T}{dz^2} = \frac{\rho_w^2 c_w g \kappa_p}{k \eta_w} \left(\frac{dH_h}{dz} + \alpha_w z \frac{dT}{dz} \right) \frac{dT}{dz}$$

Vertical flow for conductive and advective heat transfer for steady-state thermal conditions and for a uniform, isotropic, homogeneous and saturated aquifer:

$$\frac{d^2 T}{dz^2} - \frac{c_w \rho_w u_z}{k} \frac{dT}{dz} = 0$$

$$T = T_1 + (T_2 - T_1) \frac{\exp(\beta_z z/h) - 1}{\exp(\beta_z) - 1}$$

u_z =Darcy velocity in the vertical direction

h =vertical distance within the aquifer

$$\beta_z = c_w \rho_w u_z h/k \quad (\text{dimensionless parameter})$$

Fluid Flow in sedimentary basins

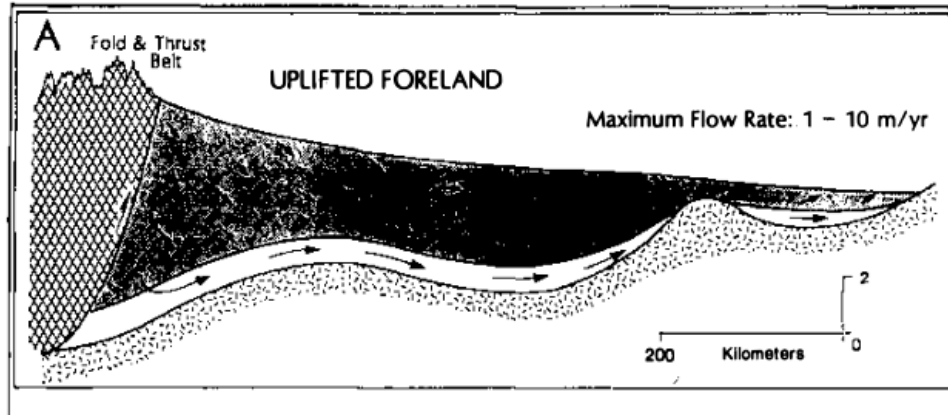

Topographic-driven

Groundwater table drives meteoric water inside a basin

Density-driven (convection)

Subsurface water flow by density gradients in fluid density due to differences in temperature and salinity.

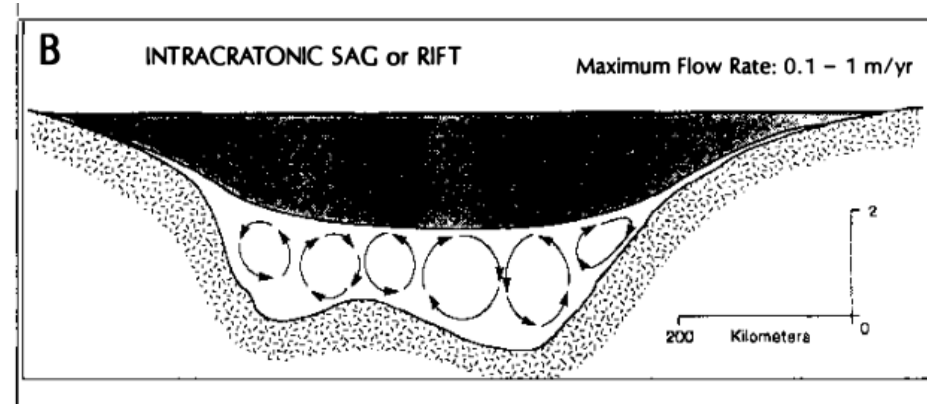

Compaction-driven

Upward pushing of connate water driven by the effective stress and chemical compaction

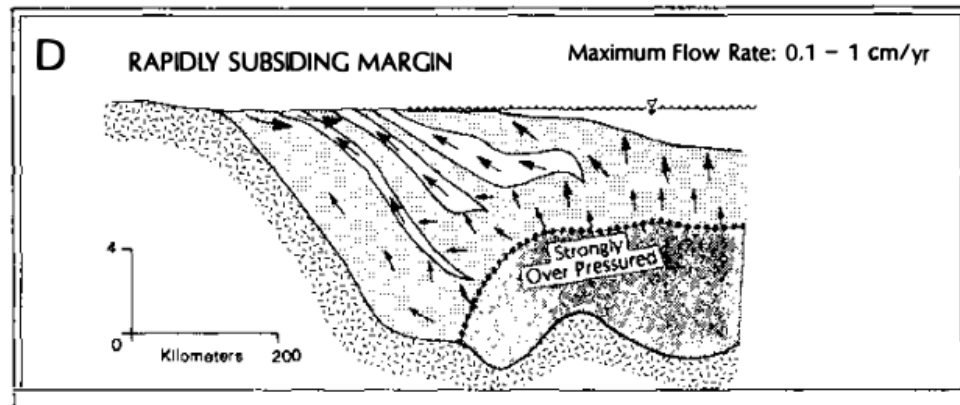

Compaction-driven groundwater flow

Flow induced by **ANOMALOUS PORE PRESSURE**

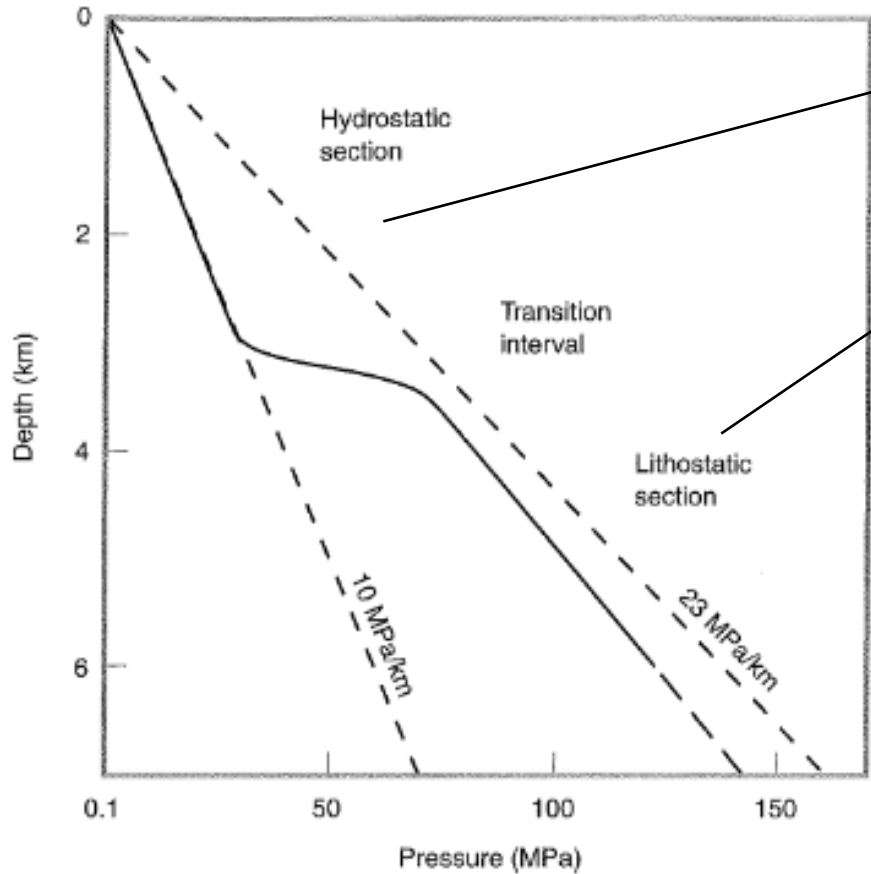

HYDROSTATIC pore pressure
weight of the overlying fluid

LITHOSTATIC pore pressure
weight of the entire burden (fluid + matrix)

OVERPRESSURE (geopressure) higher than hydrostatic

UNDERPRESSURE lower than hydrostatic

How anomalous pressure are created and maintained ?

Abnormal Pore Pressure

STATIC SCHOOL

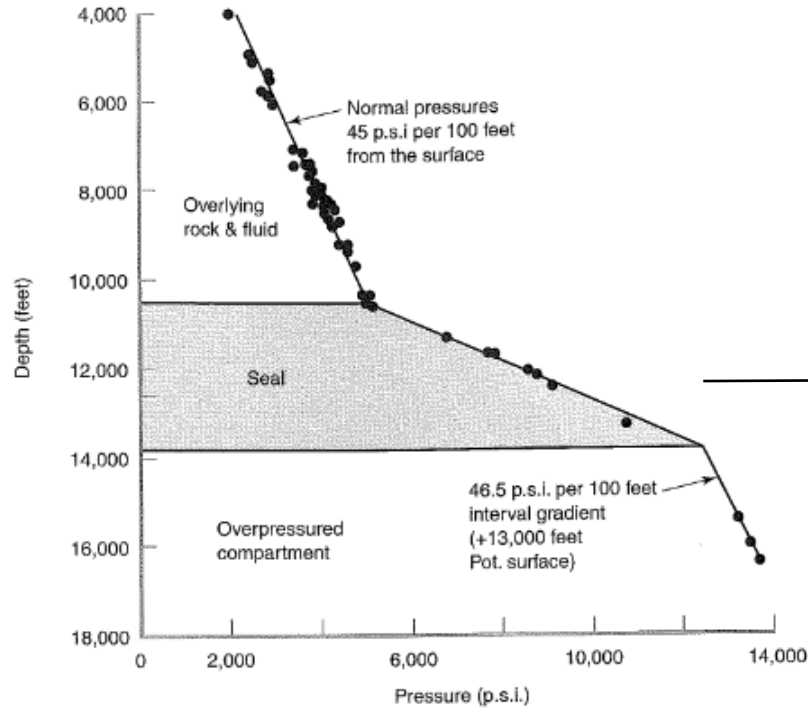

PRESSURE COMPARTMENTS

“A three dimensional hydraulically isolated volume of the Earth’s crust that has a fluid pressure different from the ambient surrounding.”

Anomalous pore pressures are maintained by **SEALS**

“... a zone of rocks capable of hydraulic sealing, that is, preventing the flow of oil, gas and water. The term does not refer to capillary seals ... the term refer to seals that prevent essentially all pore fluid movement over substantial intervals of geologic time.”

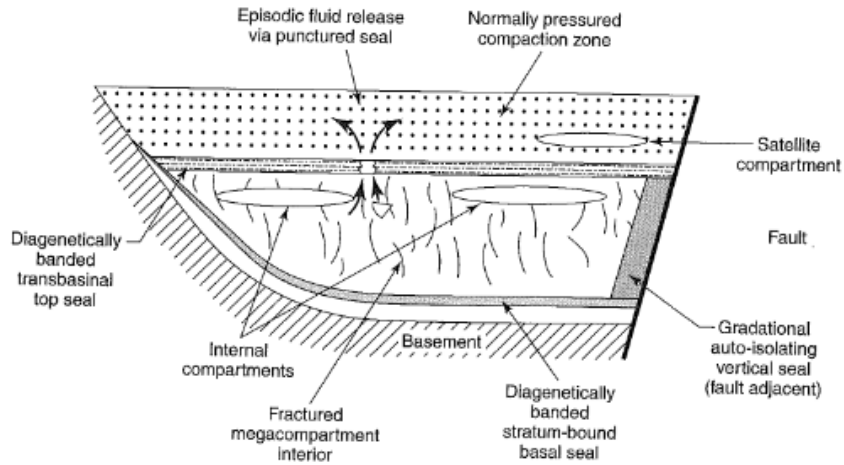

References

Main Readings:

Books:

- Eppelbaum, Kutasov, and Pilchin, 2014: Applied Geothermics, Chapter 9: Temperature Analyses in Hydrology, 593-615.
- Pasquale Pasquale, Geothermics, Heat flow in the Lithosphere, Chapter 5: Heat in the Groundwater Flow, 101-115.