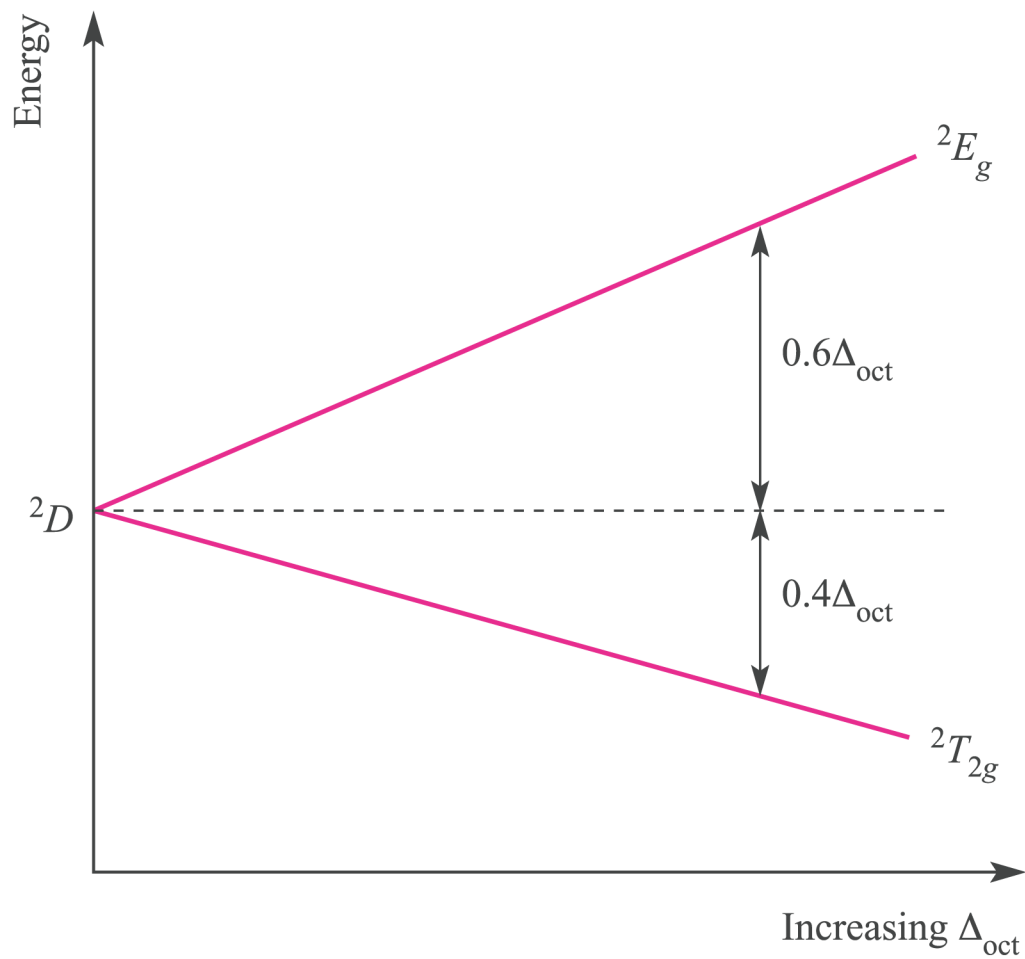

**Table 19.7** The correlation of spectroscopic terms for  $d$  electrons in  $O_h$  complexes

Atomic term	Number of states	Terms in $O_h$ symmetry
S	1	$A_{1g}$
P	3	$T_{1g}$
D	5	$T_{2g} + E_g$
F	7	$T_{1g} + T_{2g} + A_{2g}$
G	9	$A_{1g} + E_g + T_{1g} + T_{2g}$

# Diagramma dei livelli di energia per uno ione $d^1$ in campo ottaedrico



# Spettro di assorbimento elettronico del complesso $d^1$ $[\text{Ti}(\text{OH}_2)_6]^{3+}$

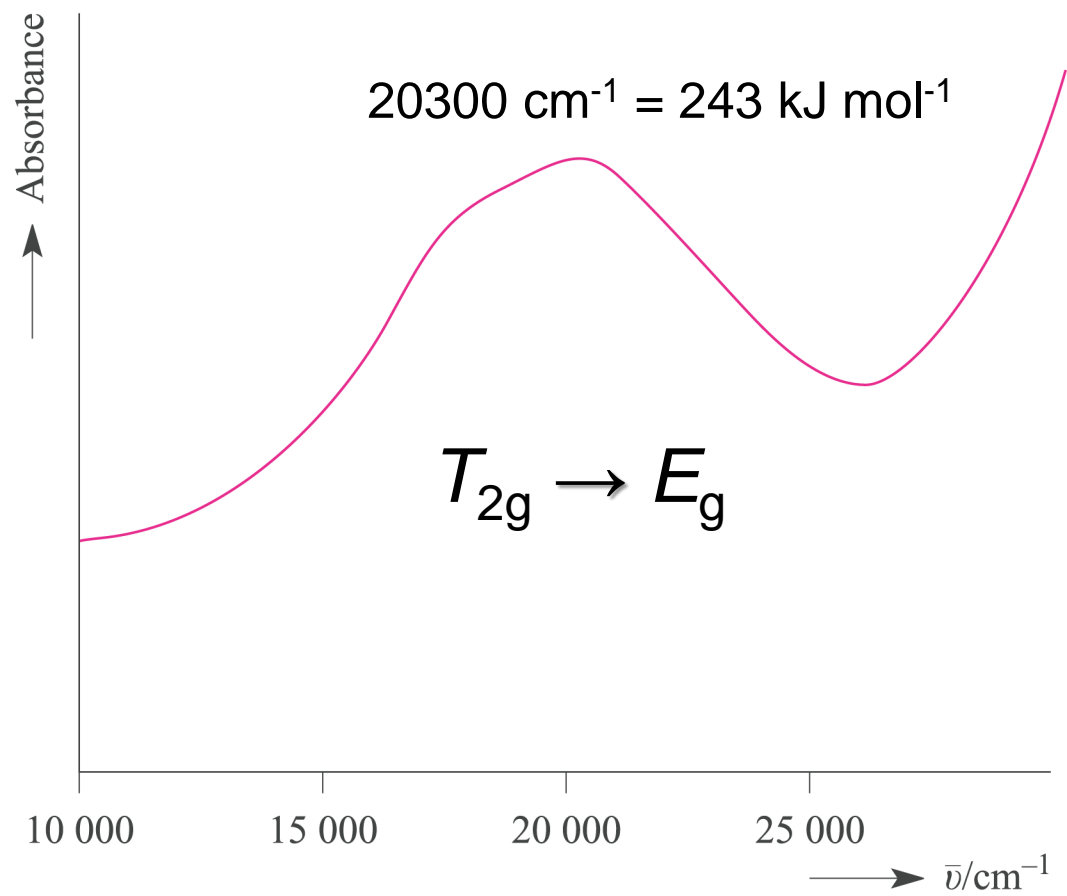

# Diagramma di correlazione di Orgel per ioni $d^1$ , $d^4$ (h.s.), $d^6$ (h.s.) e $d^9$ in campo ottaedrico (debole) e tetraedrico

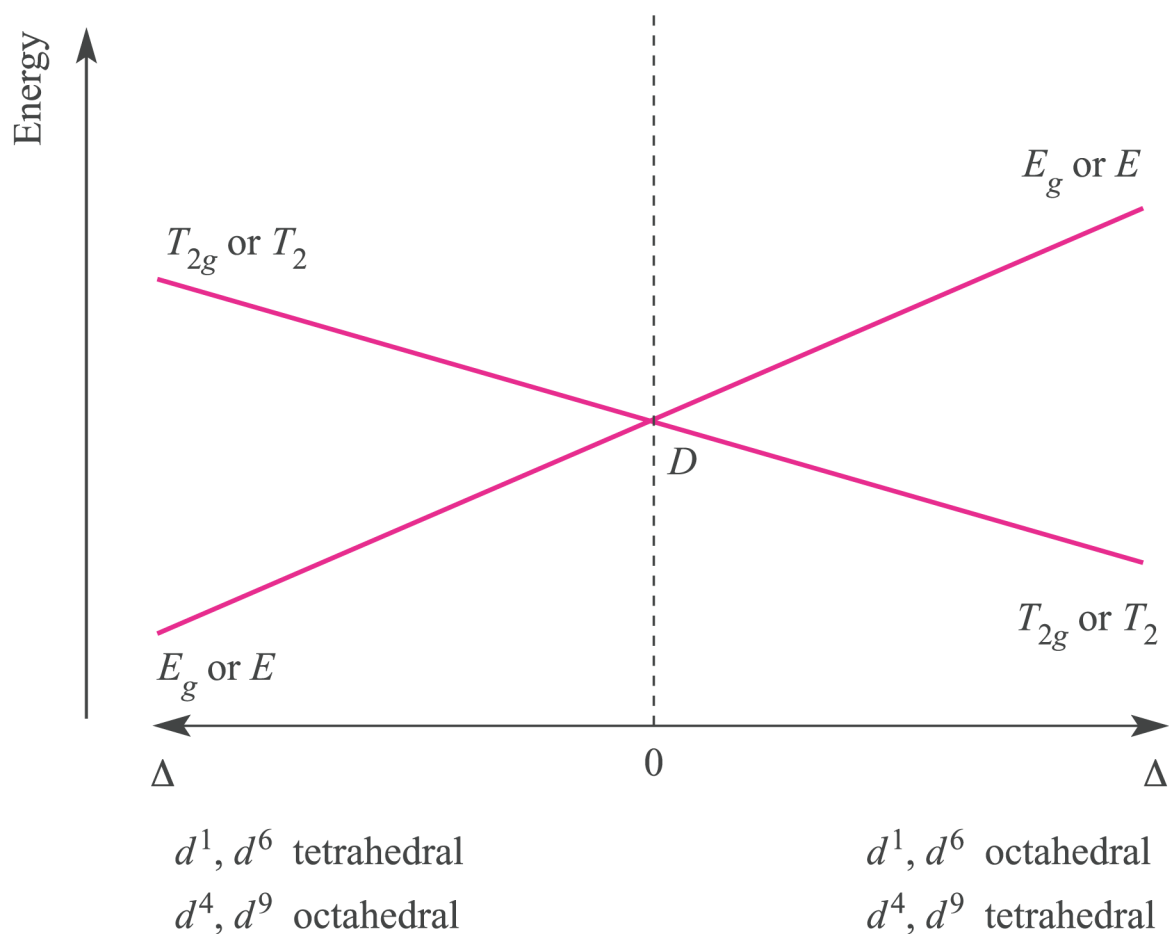

La molteplicità di spin dipende dalla configurazione elettronica

# Parametri di Racah

$$E(^1S) = A + 14B + 7C$$

$$E(^1G) = A + 4B + 2C$$

$$E(^1D) = A - 3B + 2C$$

$$E(^3P) = A + 7B$$

$$E(^3F) = A - 8B$$

$$C > 5B$$

$$^3F < ^3P < ^1D < ^1G < ^1S$$

$$C < 5B$$

$$^3F < ^1D < ^3P < ^1G < ^1S$$

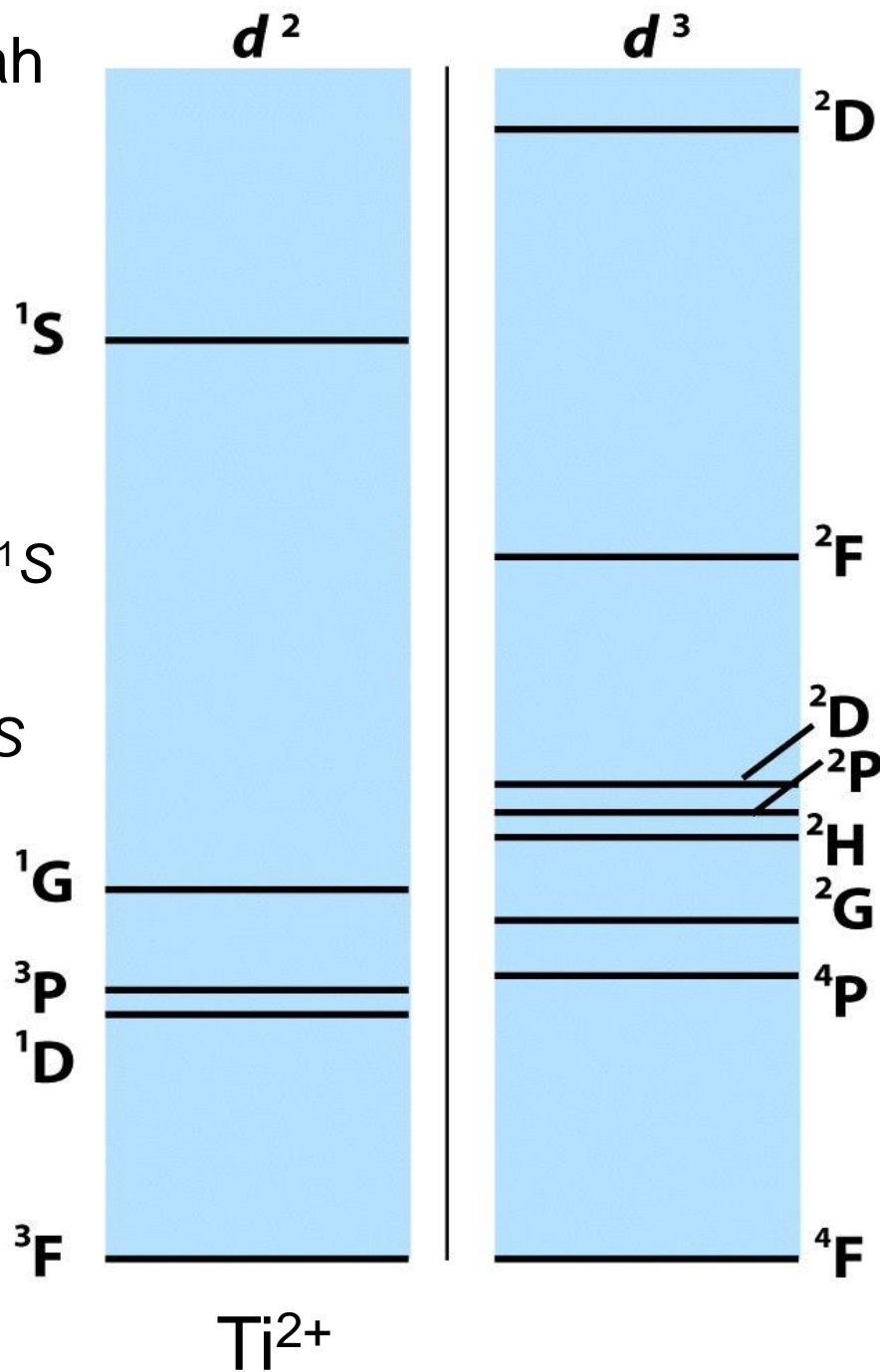

**Table 19.7** The correlation of spectroscopic terms for  $d$  electrons in  $O_h$  complexes

Atomic term	Number of states	Terms in $O_h$ symmetry
S	1	$A_{1g}$
P	3	$T_{1g}$
D	5	$T_{2g} + E_g$
F	7	$T_{1g} + T_{2g} + A_{2g}$
G	9	$A_{1g} + E_g + T_{1g} + T_{2g}$

# Diagramma di correlazione di Orgel per ioni $d^2$ , $d^3$ , $d^7$ e $d^8$ (tutti h.s.) in campo ottaedrico e tetraedrico

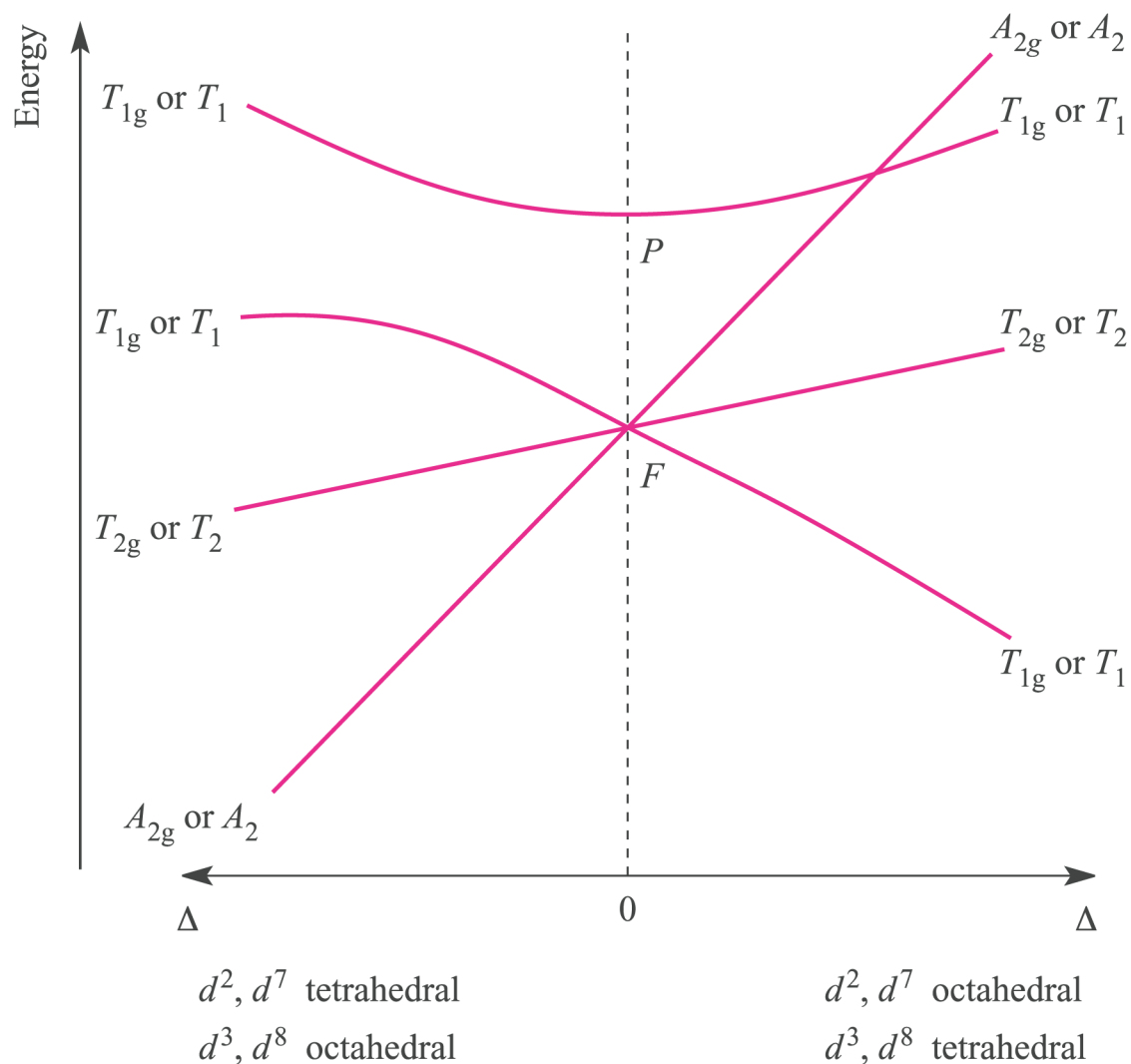

La molteplicità di spin dipende dalla configurazione elettronica



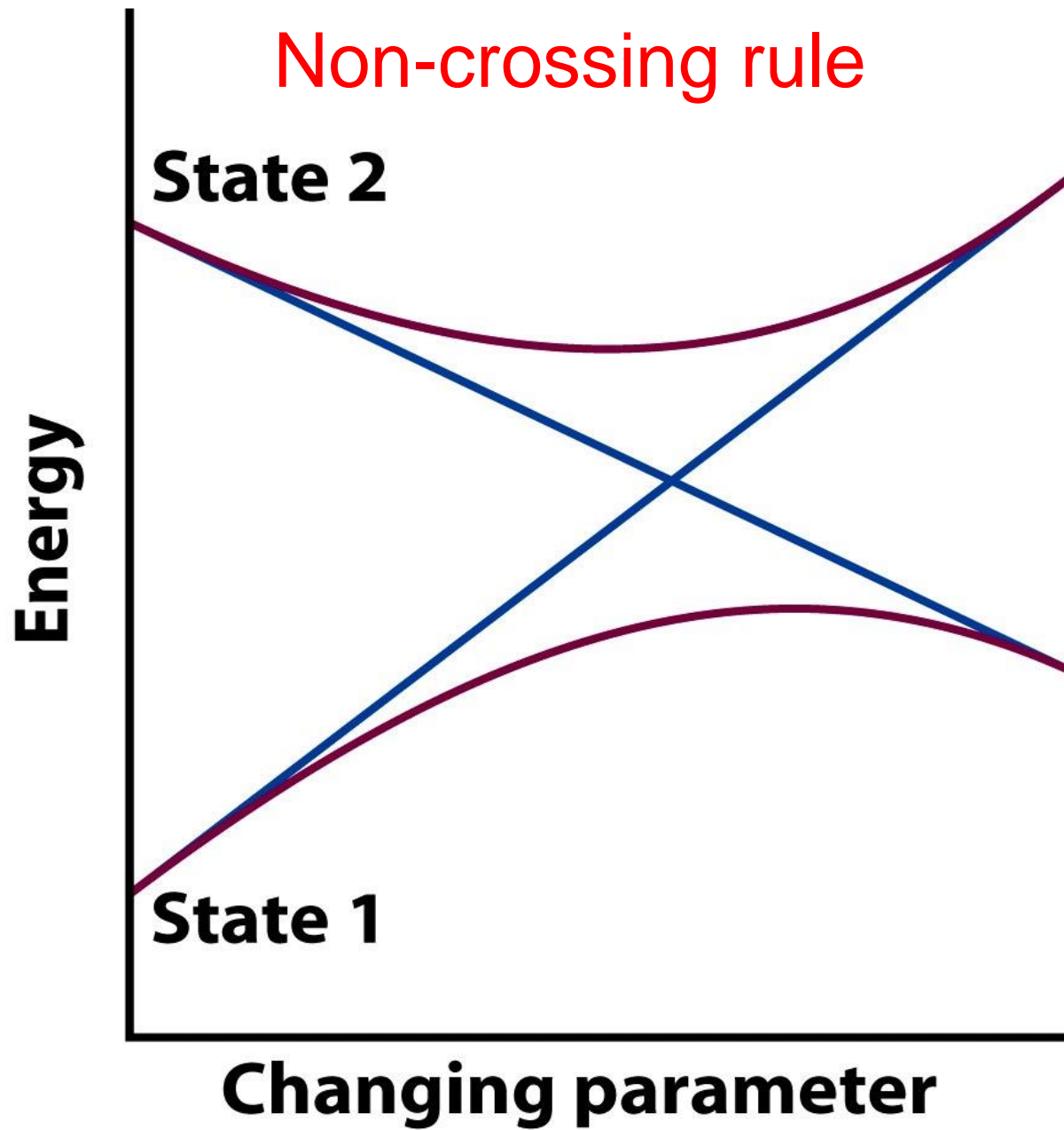



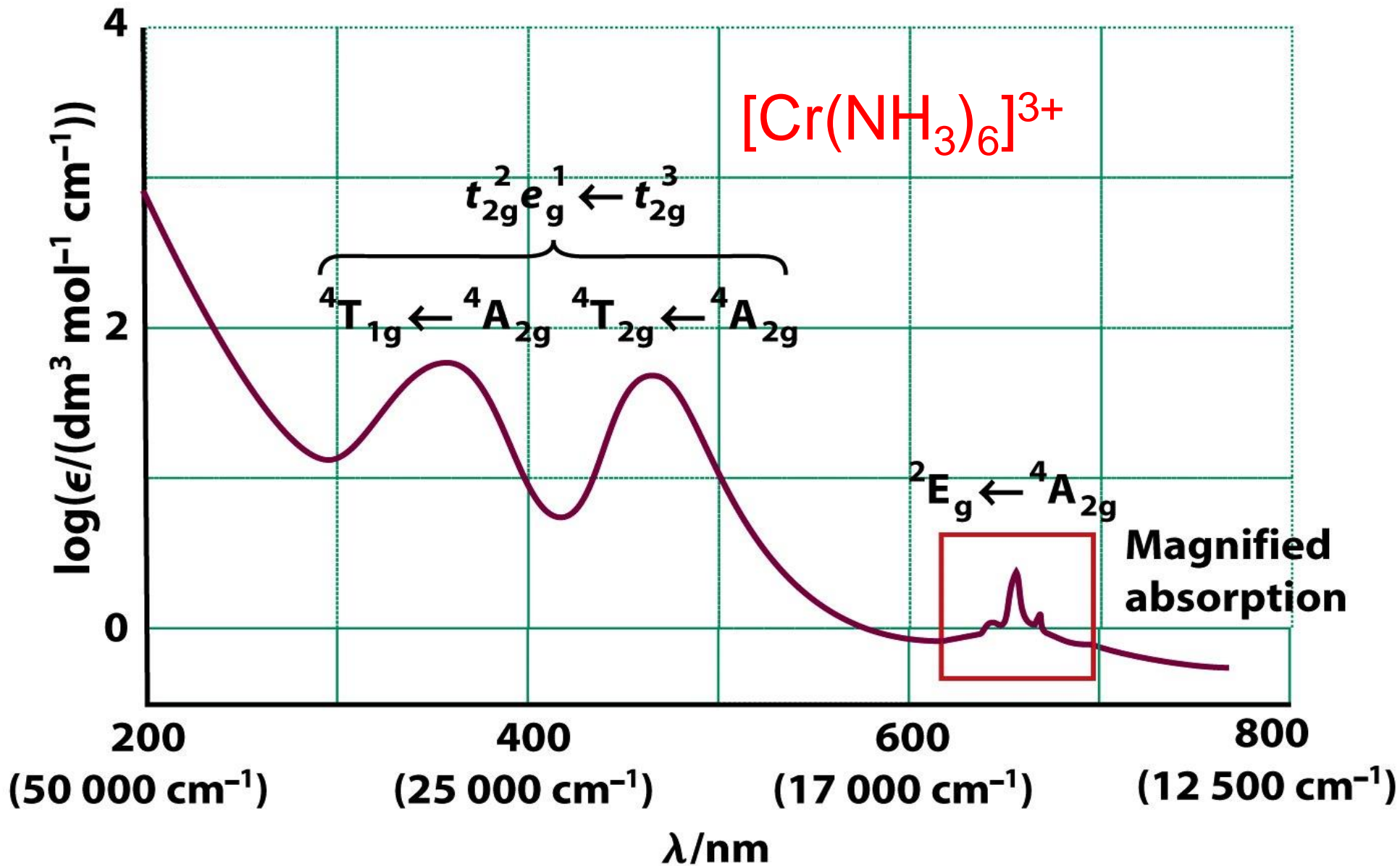

# Le 3 bande di assorbimento per complessi d<sup>8</sup> h.s.

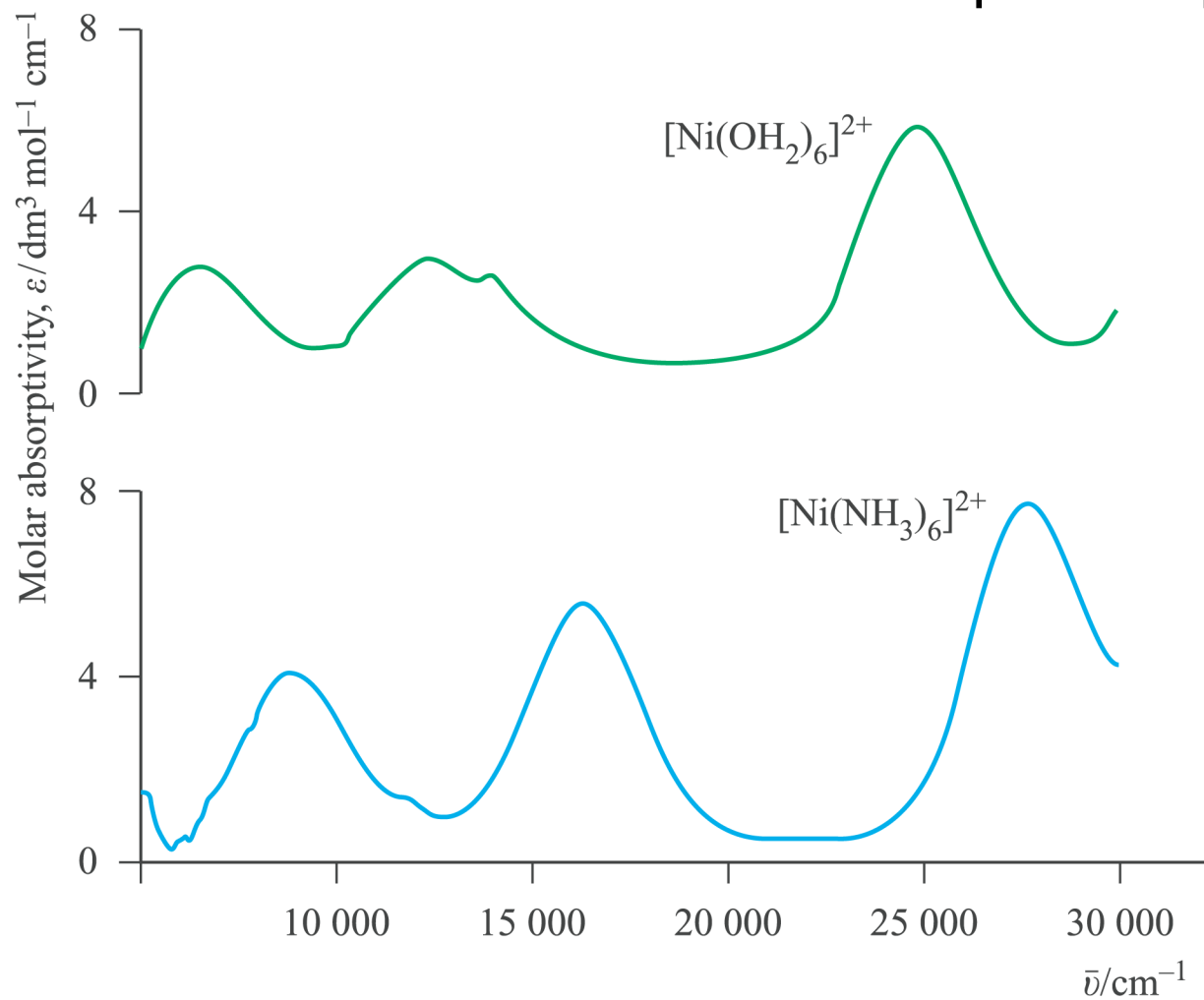

# Diagramma di correlazione di Orgel per ioni $d^2$ , $d^3$ , $d^7$ e $d^8$ (tutti h.s.) in campo ottaedrico e tetraedrico

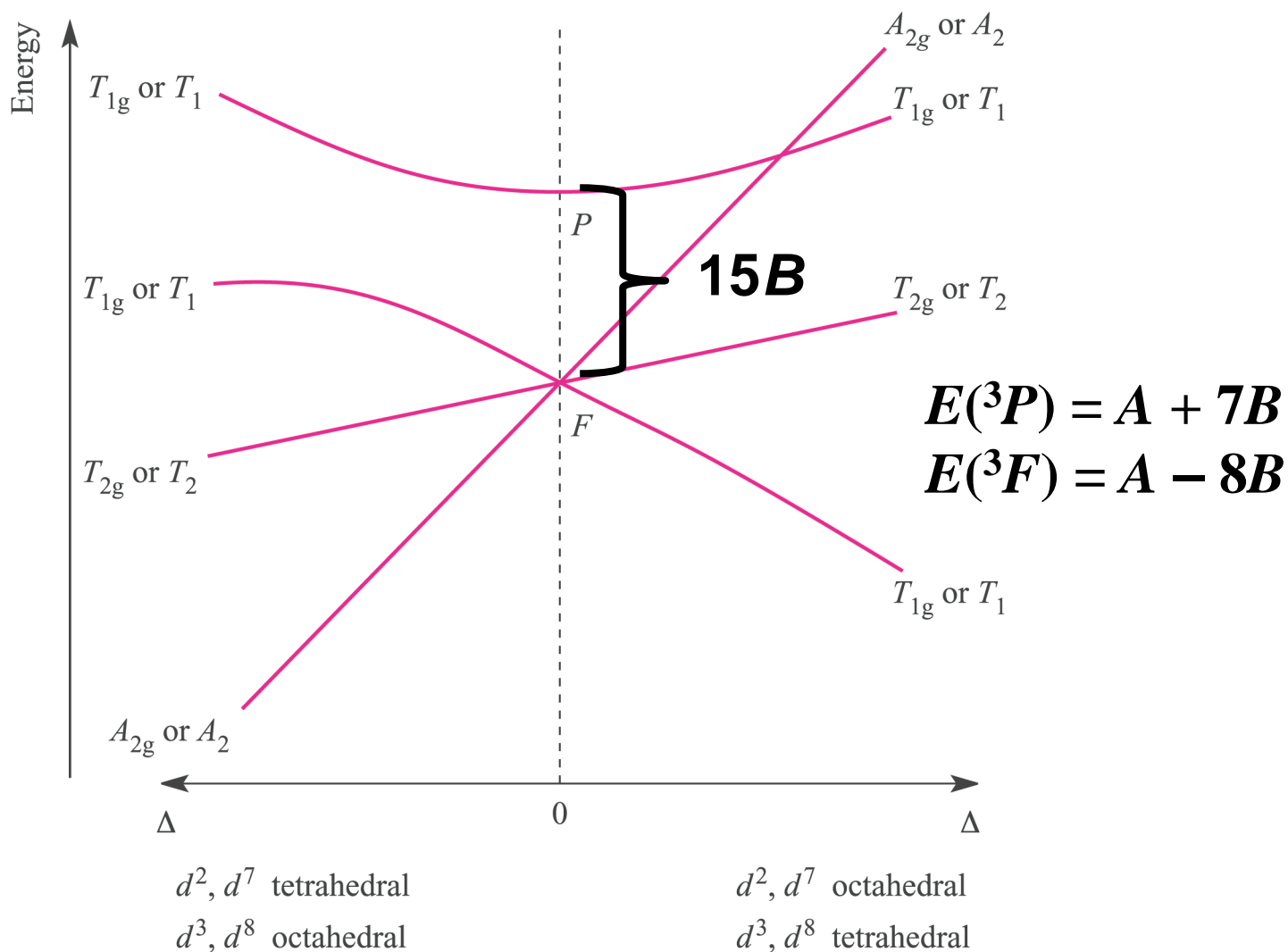

La molteplicità di spin dipende dalla configurazione elettronica

# Dipendenza della separazione di energia fra i termini in funzione di $\Delta_O$

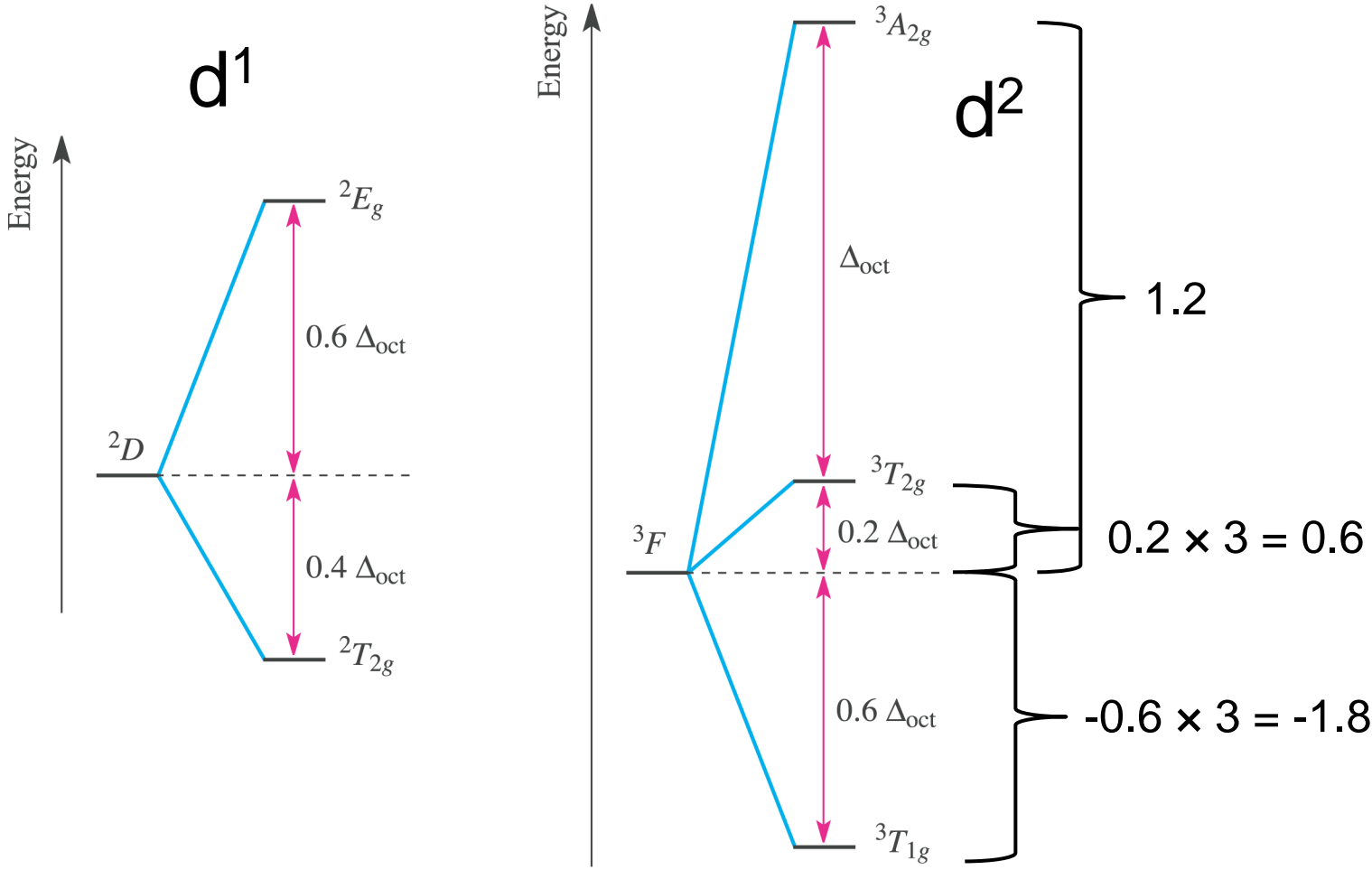

$d^2, d^7$

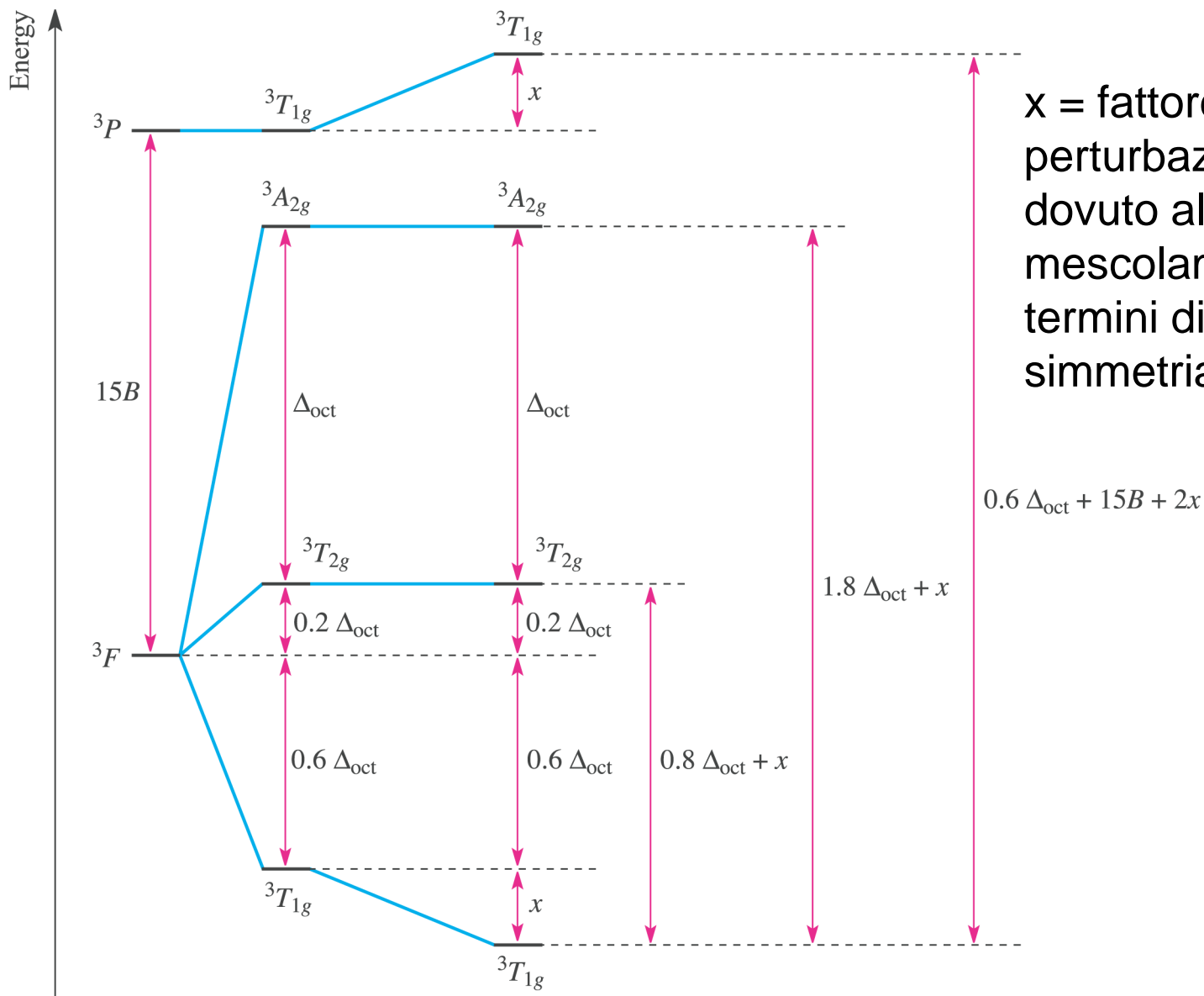

$x$  = fattore di perturbazione dovuto al parziale mescolamento fra i termini di uguale simmetria

(a)  $\Delta_o = 1.8\Delta_o + x - (0.8\Delta_o + x)$

**Il valore di  $\Delta_o$  è dato dalla differenza di energia fra le due bande a energia minore**

$d^3, d^8$

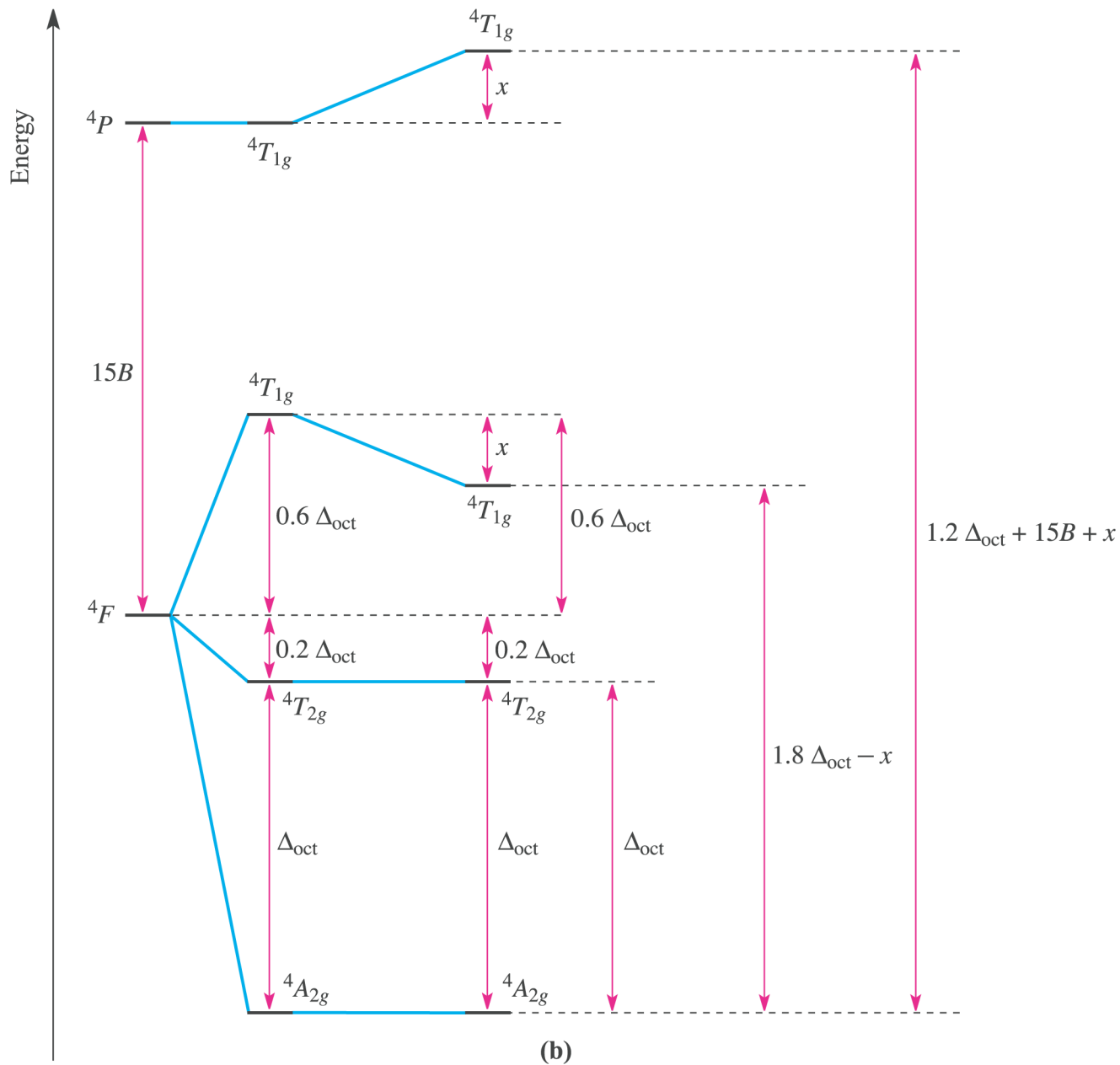

**Il valore di  $\Delta_o$  coincide con l'energia della banda a energia minore**

# Diagramma di Tanabe-Sugano per la configurazione $d^2$ in campo ottaedrico

$$C \approx 4B$$

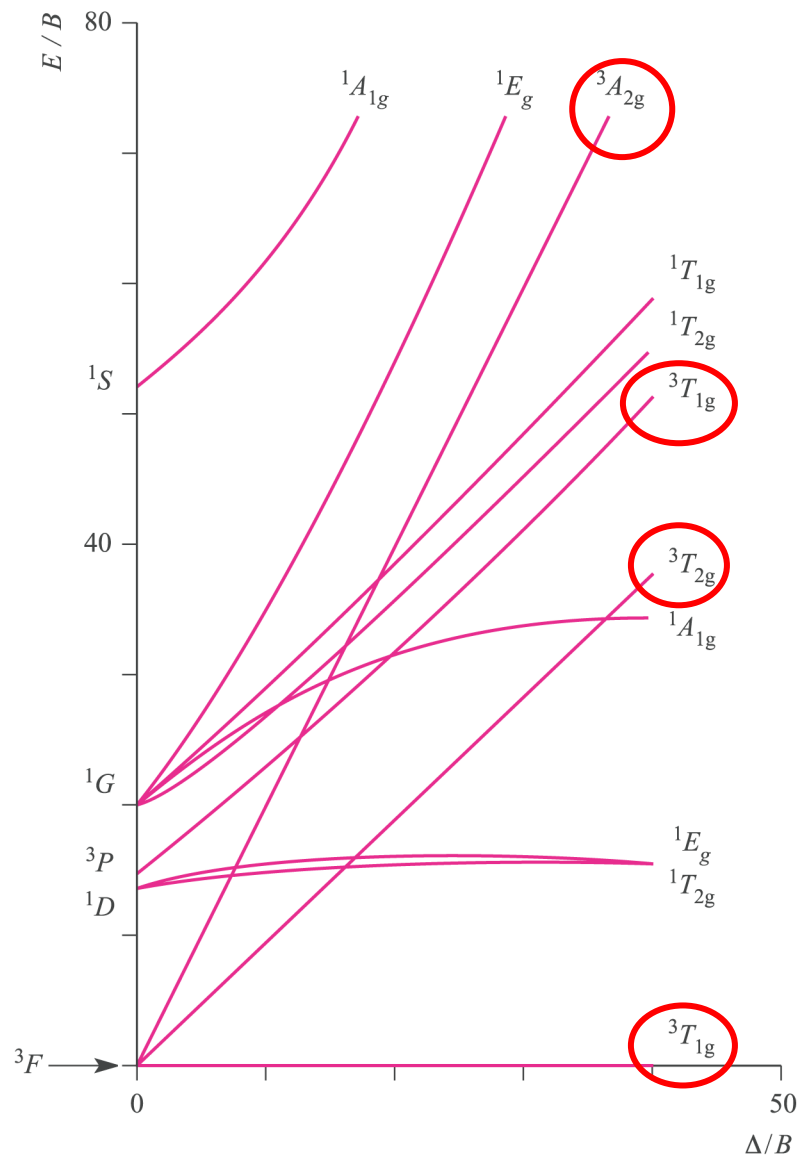



# Diagramma di Tanabe-Sugano per la configurazione $d^6$ in campo ottaedrico

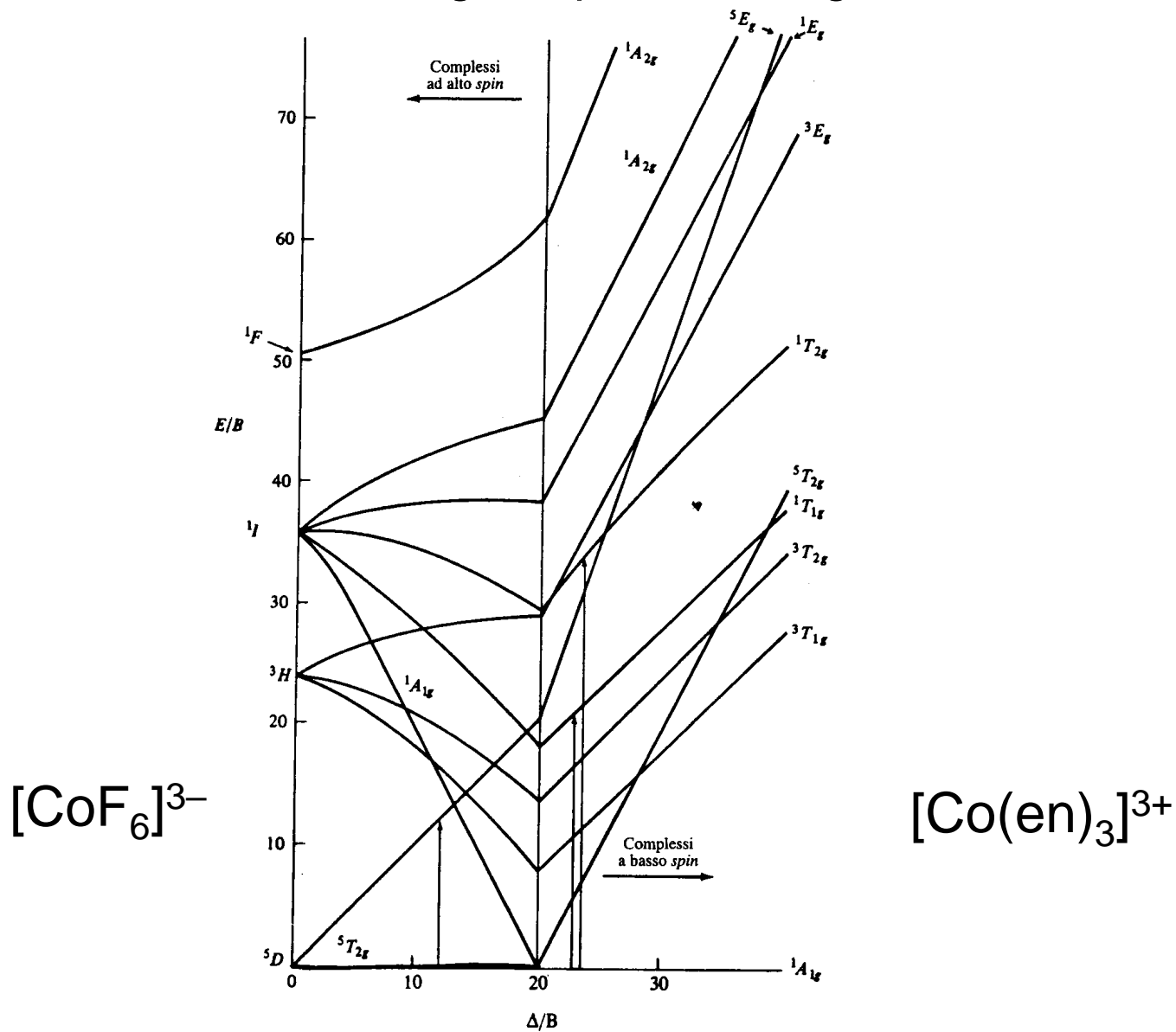

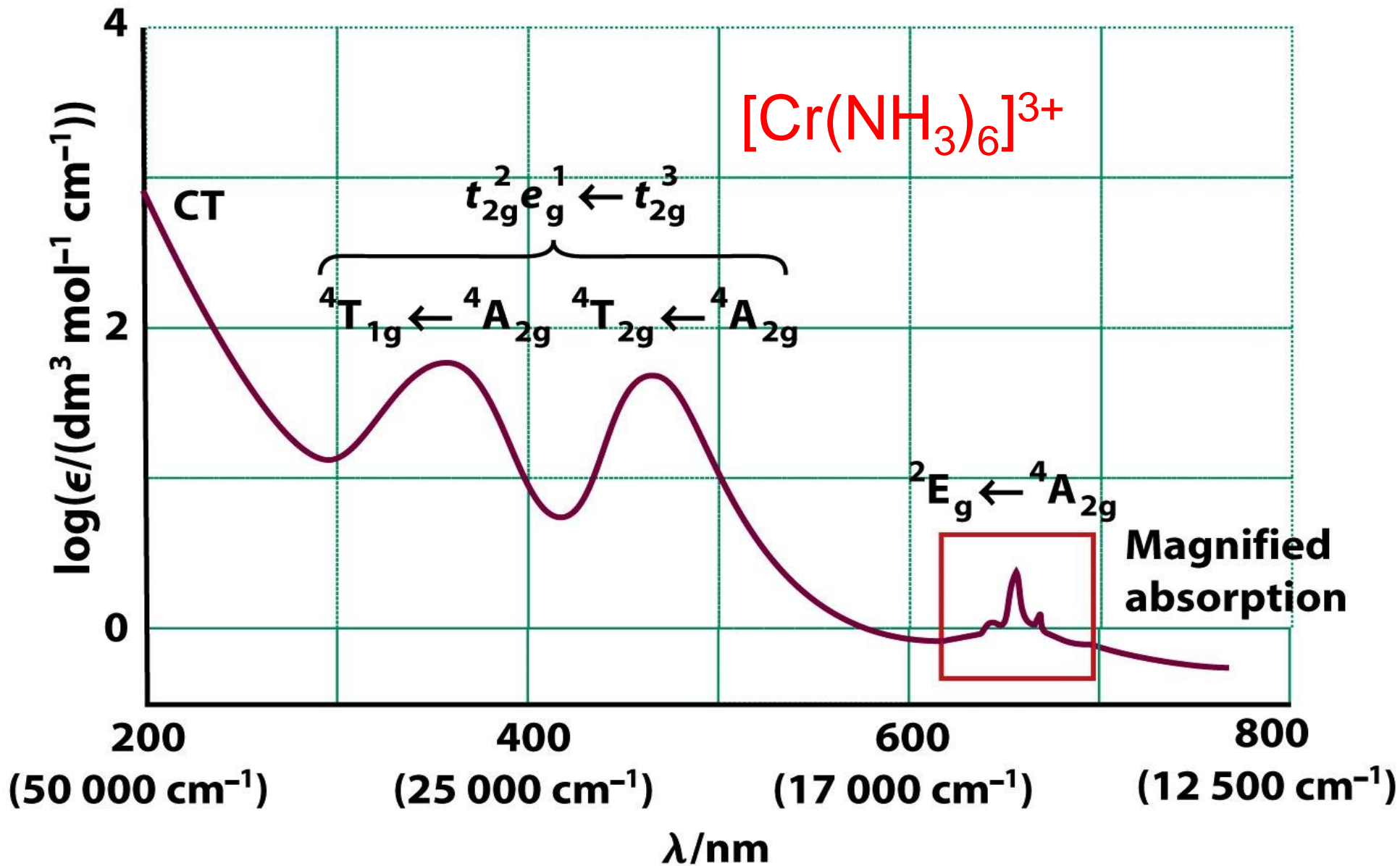

21550 e 28500  $\text{cm}^{-1}$

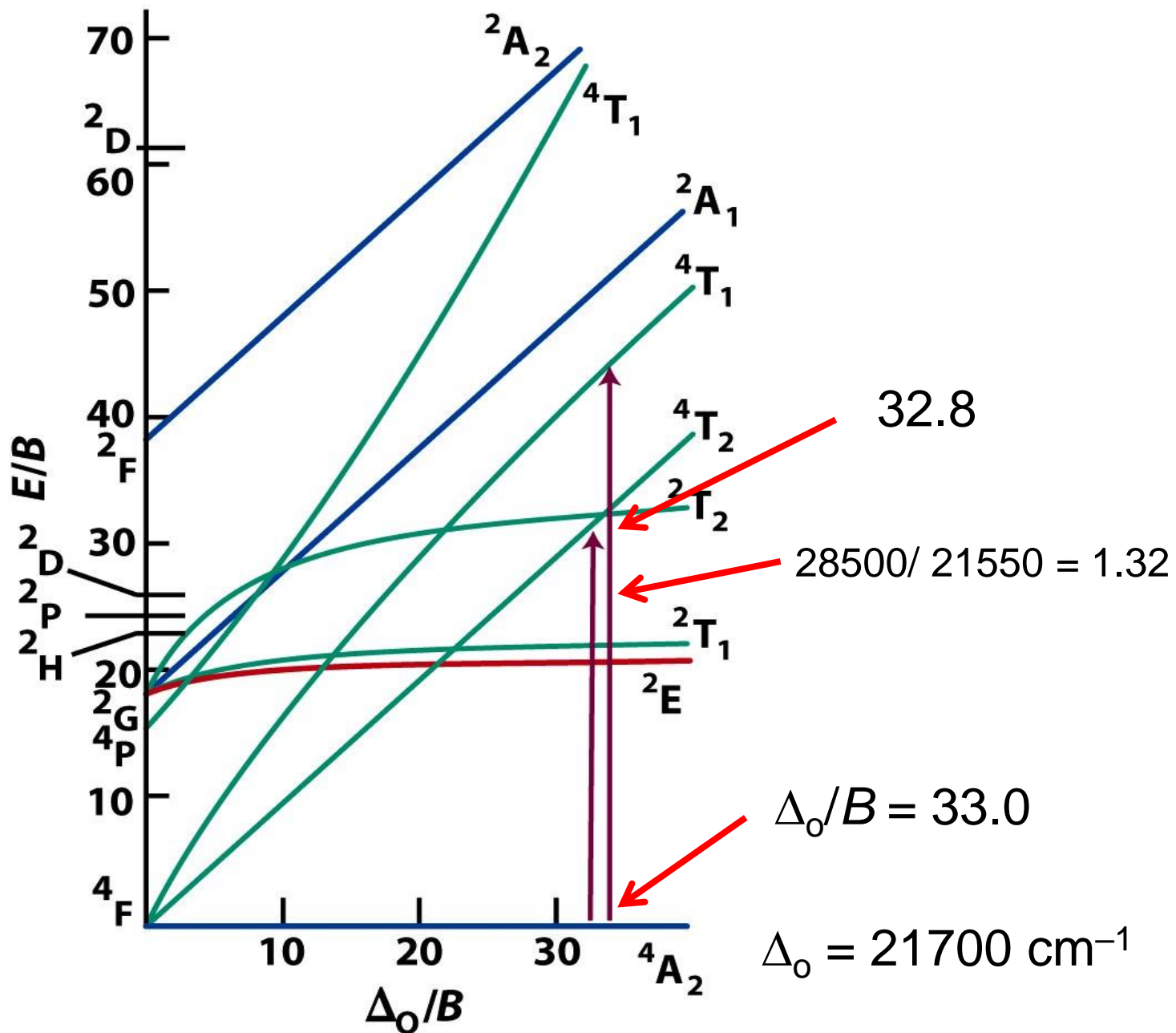

Diagramma di Tanabe-Sugano per la configurazione  $d^3$  in campo ottaedrico

# Effetto nefelauxetico

Metal ion	$k$	Ligands	$h$
Co(III)	0.35	6 Br <sup>-</sup>	2.3
Rh(III)	0.28	6 Cl <sup>-</sup>	2.0
Co(II)	0.24	6 [CN] <sup>-</sup>	2.0
Fe(III)	0.24	3 en	1.5
Cr(III)	0.21	6 NH <sub>3</sub>	1.4
Ni(II)	0.12	6 H <sub>2</sub> O	1.0
Mn(II)	0.07	6 F <sup>-</sup>	0.8

$$\beta = \frac{B}{B^\circ} \text{ rapporto nefelauxetico } (< 1)$$