



HIGHWAY CAPACITY MANUAL

**TRANSPORTATION
RESEARCH
BOARD**

National Research Council

TRB

HCM2000

**TRANSPORTATION RESEARCH BOARD
2000 EXECUTIVE COMMITTEE***

Chairman: **Martin Wachs**, Director, Institute of Transportation Studies, University of California, Berkeley
Vice Chairman: **John M. Samuels**, Senior Vice President—Operations Planning and Support (Operations Division), Norfolk Southern Corporation, Norfolk, Virginia
Executive Director: **Robert E. Skinner, Jr.**, Transportation Research Board

Thomas F. Barry, Jr., Secretary of Transportation, Florida Department of Transportation, Tallahassee
Jack E. Buffington, Associate Director and Research Professor, Mack-Blackwell National Rural Transportation Study Center, University of Arkansas, Fayetteville
Sarah C. Campbell, President, TransManagement, Inc., Washington, D.C.
Anne P. Canby, Secretary of Transportation, Delaware Department of Transportation, Dover
E. Dean Carlson, Secretary of Transportation, Kansas Department of Transportation, Topeka
Joanne F. Casey, President, Intermodal Association of North America, Greenbelt, Maryland
John L. Craig, Director, Nebraska Department of Roads, Lincoln
Robert A. Frosch, Senior Research Fellow, Belfer Center for Science & International Affairs, John F. Kennedy School of Government, Harvard University, Cambridge, Massachusetts
Gorman Gilbert, Director, Oklahoma Transportation Center, Oklahoma State University, Stillwater
Genevieve Giuliano, Professor, School of Policy, Planning, and Development, University of Southern California, Los Angeles
Lester A. Hoel, L.A. Lacy Distinguished Professor, Department of Civil Engineering, University of Virginia, Charlottesville
H. Thomas Kornegay, Executive Director, Port of Houston Authority, Houston, Texas
Thomas F. Larwin, General Manager, San Diego Metropolitan Transit Development Board, San Diego, California
Bradley L. Mallory, Secretary of Transportation, Pennsylvania Department of Transportation, Harrisburg
Jeffrey R. Moreland, Senior Vice President—Law and Chief of Staff, Burlington Northern Santa Fe Corporation, Fort Worth, Texas
Sid Morrison, Secretary of Transportation, Washington State Department of Transportation, Olympia
John P. Poorman, Staff Director, Capital District Transportation Committee, Albany, New York
Wayne Shackelford, Senior Vice President, Gresham Smith & Partners, Alpharetta, Georgia (Past Chairman, 1999)
Michael S. Townes, Executive Director, Transportation District Commission of Hampton Roads, Hampton, Virginia
Thomas R. Warne, Executive Director, Utah Department of Transportation, Salt Lake City
Arnold F. Wellman, Jr., Vice President, Corporate Public Affairs, United Parcel Service, Washington, D.C.
James A. Wilding, President and CEO, Metropolitan Washington Airports Authority, Alexandria, Virginia
M. Gordon Wolman, Professor of Geography and Environmental Engineering, The Johns Hopkins University, Baltimore, Maryland
David N. Wormley, Dean of Engineering, Pennsylvania State University, University Park (Past Chairman, 1997)

Mike Acott, President, National Asphalt Pavement Association, Lanham, Maryland (ex officio)
Sue Bailey, Administrator, National Highway Traffic Safety Administration, U.S. Department of Transportation (ex officio)
Kelley S. Coyner, Administrator, Research and Special Programs Administration, U.S. Department of Transportation (ex officio)
Mortimer L. Downey, Deputy Secretary of Transportation, U.S. Department of Transportation (ex officio)
Nuria I. Fernandez, Acting Administrator, Federal Transit Administration, U.S. Department of Transportation (ex officio)
Russell L. Fuhrman, (Maj. Gen., U.S. Army), Acting Commander, U.S. Army Corps of Engineers, Washington, D.C. (ex officio)
Jane F. Garvey, Administrator, Federal Aviation Administration, U.S. Department of Transportation (ex officio)
John Graykowski, Acting Administrator, Maritime Administration, U.S. Department of Transportation (ex officio)
Edward R. Hamberger, President and CEO, Association of American Railroads, Washington, D.C. (ex officio)
Clyde J. Hart, Jr., Acting Deputy Administrator, Federal Motor Carrier Safety Administration, U.S. Department of Transportation (ex officio)
John C. Horsley, Executive Director, American Association of State Highway and Transportation Officials, Washington, D.C. (ex officio)
James M. Loy (Adm., U.S. Coast Guard), Commandant, U.S. Coast Guard, Washington, D.C. (ex officio)
William W. Millar, President, American Public Transportation Association, Washington, D.C. (ex officio)
Jolene M. Molitoris, Administrator, Federal Railroad Administration, U.S. Department of Transportation (ex officio)
Margo Oge, Director, Office of Transportation and Air Quality, U.S. Environmental Protection Agency, Washington, D.C. (ex officio)
Valentin J. Riva, President and CEO, American Concrete Pavement Association, Skokie, Illinois (ex officio)
Ashish K. Sen, Director, Bureau of Transportation Statistics, U.S. Department of Transportation (ex officio)
Kenneth R. Wykle, Administrator, Federal Highway Administration, U.S. Department of Transportation (ex officio)

Transportation Research Board publications may be ordered directly from the TRB Business Office, through the Internet at nationalacademies.org/trb, or by annual subscription through organization or individual affiliation with TRB. Affiliates and library subscribers are eligible for substantial discounts. For further information, contact the Transportation Research Board Business Office, National Research Council, 2101 Constitution Avenue, NW, Washington, DC 20418 (telephone 202-334-3214; fax 202-334-2519; or e-mail TRBsales@nas.edu).

© 2000 by the National Academy of Sciences.
All rights reserved.
Printed in the United States of America.

Library of Congress Cataloging in Publication Data
Highway capacity manual.
p. cm.
"HCM 2000."
Includes bibliographic references.
ISBN 0-309-06681-6
1. Highway capacity—Handbooks, manuals, etc.
HE336.H48 H54 2000
388.3'14—dc21

00-061507

* Membership as of October 2000.

THE NATIONAL ACADEMIES

Advisers to the Nation on Science, Engineering, and Medicine

National Academy of Sciences
National Academy of Engineering
Institute of Medicine
National Research Council

The **National Academy of Sciences** is a private, nonprofit, self-perpetuating society of distinguished scholars engaged in scientific and engineering research, dedicated to the furtherance of science and technology and to their use for the general welfare. Upon the authority of the charter granted to it by the Congress in 1863, the Academy has a mandate that requires it to advise the federal government on scientific and technical matters. Dr. Bruce M. Alberts is president of the National Academy of Sciences.

The **National Academy of Engineering** was established in 1964, under the charter of the National Academy of Sciences, as a parallel organization of outstanding engineers. It is autonomous in its administration and in the selection of its members, sharing with the National Academy of Sciences the responsibility for advising the federal government. The National Academy of Engineering also sponsors engineering programs aimed at meeting national needs, encourages education and research, and recognizes the superior achievements of engineers. Dr. William A. Wulf is president of the National Academy of Engineering.

The **Institute of Medicine** was established in 1970 by the National Academy of Sciences to secure the services of eminent members of appropriate professions in the examination of policy matters pertaining to the health of the public. The Institute acts under the responsibility given to the National Academy of Sciences by its congressional charter to be an adviser to the federal government and, upon its own initiative, to identify issues of medical care, research, and education. Dr. Kenneth I. Shine is president of the Institute of Medicine.

The **National Research Council** was organized by the National Academy of Sciences in 1916 to associate the broad community of science and technology with the Academy's purposes of furthering knowledge and advising the federal government. Functioning in accordance with general policies determined by the Academy, the Council had become the principal operating agency of both the National Academy of Sciences and the National Academy of Engineering in providing services to the government, the public, and the scientific and engineering communities. The Council is administered jointly by both the Academies and the Institute of Medicine. Dr. Bruce M. Alberts and Dr. William A. Wulf are chairman and vice chairman, respectively, of the National Research Council.

The **Transportation Research Board** is a unit of the National Research Council, which serves the National Academy of Sciences and the National Academy of Engineering. The Board's mission is to promote innovation and progress in transportation by stimulating and conducting research, facilitating the dissemination of information, and encouraging the implementation of research results. The Board's varied activities annually engage more than 2,000 engineers, scientists, and other transportation researchers and practitioners from the public and private sectors and academies, all of whom contribute their expertise in the public interest. The program is supported by the state transportation departments, federal agencies including the component administrations of the U.S. Department of Transportation, and other organizations and individuals interested in the development of transportation.

CONTENTS

PREFACE.....	vii
CONTRIBUTORS AND ACKNOWLEDGMENTS.....	ix
PART I: OVERVIEW	
1. INTRODUCTION	1-1
2. CAPACITY AND LEVEL-OF-SERVICE CONCEPTS.....	2-1
3. APPLICATIONS.....	3-1
4. DECISION MAKING	4-1
5. GLOSSARY	5-1
6. SYMBOLS.....	6-1
PART II: CONCEPTS	
7. TRAFFIC FLOW PARAMETERS	7-1
8. TRAFFIC CHARACTERISTICS.....	8-1
9. ANALYTICAL PROCEDURES OVERVIEW	9-1
10. URBAN STREET CONCEPTS	10-1
11. PEDESTRIAN AND BICYCLE CONCEPTS.....	11-1
12. HIGHWAY CONCEPTS.....	12-1
13. FREEWAY CONCEPTS	13-1
14. TRANSIT CONCEPTS	14-1
PART III: METHODOLOGIES	
15. URBAN STREETS.....	15-1
16. SIGNALIZED INTERSECTIONS	16-1
17. UNSIGNALIZED INTERSECTIONS	17-1
18. PEDESTRIANS.....	18-1
19. BICYCLES	19-1
20. TWO-LANE HIGHWAYS	20-1
21. MULTILANE HIGHWAYS	21-1
22. FREEWAY FACILITIES.....	22-1
23. BASIC FREEWAY SEGMENTS	23-1
24. FREEWAY WEAVING	24-1
25. RAMPS AND RAMP JUNCTIONS	25-1
26. INTERCHANGE RAMP TERMINALS.....	26-1
27. TRANSIT.....	27-1
PART IV: CORRIDOR AND AREAWIDE ANALYSES	
28. ASSESSMENT OF MULTIPLE FACILITIES.....	28-1
29. CORRIDOR ANALYSIS.....	29-1
30. AREAWIDE ANALYSIS	30-1
PART V: SIMULATION AND OTHER MODELS	
31. SIMULATION AND OTHER MODELS	31-1

PREFACE

The Transportation Research Board's (TRB's) *Highway Capacity Manual* (HCM) provides a collection of state-of-the-art techniques for estimating the capacity and determining the level of service for transportation facilities, including intersections and roadways as well as facilities for transit, bicycles, and pedestrians. For more than 50 years, the HCM has fulfilled this goal, earning a unique place in the esteem of the transportation community.

Developed and revised under the direction of the TRB Committee on Highway Capacity and Quality of Service, this newest edition, HCM 2000, presents the best available techniques for determining capacity and level of service for transportation facilities at the start of the new millennium. However, this comprehensive manual does not establish a legal standard for highway design or construction.

HISTORICAL PERSPECTIVE

Originally published in 1950, the HCM was the first document to quantify the concept of capacity for transportation facilities. The 1965 edition in turn was the first to define the concept of level of service, which has become the foundation for determining the adequacy of transportation facilities from the perspectives of planning, design, and operations. The 1985 edition, along with its 1994 and 1997 updates, is TRB's most widely used document. Translated into several languages, it has become the standard reference on capacity and level-of-service procedures, relied on by transportation analysts around the world.

DEVELOPMENT OF HCM 2000

To produce HCM 2000, TRB's Committee on Highway Capacity and Quality of Service developed a comprehensive program of research. The research was implemented through the funding efforts of the National Cooperative Highway Research Program (NCHRP) and the Transit Cooperative Research Program. In addition, the Federal Highway Administration supported TRB with a variety of research endeavors. These combined efforts produced the basic research reviewed by the committee and incorporated into HCM 2000.

All of the research results contributing to HCM 2000 underwent an iterative and interactive review. When a funded research project was completed, the group that guided its development—for example, an NCHRP panel—reviewed the findings first. If accepted by the group, the research was then presented for consideration by one of the 12 working subcommittees of the Highway Capacity and Quality of Service Committee. The subcommittee, including several committee members as well as other active professionals, then provided its recommendations to the full committee. The final approval for each chapter of HCM 2000 rested with the Highway Capacity and Quality of Service Committee, composed of 30 members representing the research community, government agencies, and private industry.

CONTENTS OF HCM 2000

The *Highway Capacity Manual* 2000 represents a significant revision and expansion of the material provided in previous editions. The manual has grown from 14 to 31 chapters. These chapters are divided into five parts:

- I. Overview,
- II. Concepts,
- III. Methodologies,
- IV. Corridor and Areawide Analyses, and
- V. Simulation and Other Models.

Parts I and III contain information that corresponds to the contents of previous editions. Part II provides concepts and estimated default values for use in planning-level

analytical work. Part IV presents computational techniques and general analysis guidelines for corridor and areawide analyses. Part V offers background and information on alternative models that may be appropriate for systemwide or more complex analyses.

A companion version of the manual is available in CD-ROM, including tutorials and video clips to enhance the communication of the concepts. In addition, there are links between the text and the glossary to facilitate understanding of the manual by less-experienced users.

SPECIAL ACKNOWLEDGMENTS

HCM 2000 incorporates significant advances in the state of knowledge in determining capacity and quality-of-service values for all modes of surface transportation.

Hundreds of professionals have volunteered their time and energy to the work of the Committee on Highway Capacity and Quality of Service. Twice every year, the committee meets to perform a major review of relevant research and to identify new research needs in response to changes in roadway design standards, driver behavior, and vehicle operating characteristics.

Members of the committee and its subcommittees are listed on pages ii–vii. Special recognition is extended to those who have chaired the committee: O.K. Normann, Carl C. Saal, Robert C. Blumenthal, James H. Kell, Carlton C. Robinson, and Adolf D. May. In acknowledgment of their sustained contributions to the committee and to the development of HCM 2000, Robinson and May have been designated members emeritus of the committee.

Complementing the volunteer efforts vital to the work of the committee, TRB staff has provided outstanding support. Special thanks are given to Richard Cunard, Engineer of Traffic and Operations, and to B. Ray Derr, NCHRP Senior Program Officer, for their contributions.

The Committee on Highway Capacity and Quality of Service invites comments and suggestions on HCM 2000 while continuing its mission of enhancing and improving the design, operation, and planning of transportation facilities.

John D. Zegeer

Chairman, TRB Committee on Highway Capacity and Quality of Service

CONTRIBUTORS AND ACKNOWLEDGMENTS

HCM 2000 is the result of the coordinated efforts of many individuals, groups, research organizations, and government agencies. The TRB Committee on Highway Capacity and Quality of Service is responsible for the content of the *Highway Capacity Manual*; preparation of the volume was accomplished through the efforts of the following groups and individuals:

TRB COMMITTEE ON HIGHWAY CAPACITY AND QUALITY OF SERVICE

(Members as of January 31, 2000)

John Zegeer, *Kittelson & Associates, Inc.*—Chairman
Richard Dowling, *Dowling Associates, Inc.*—Secretary
James Bonneson, *Texas A & M University*
Werner Brilon, *Ruhr University, Bochum, Germany*
Robert Bryson, *City of Milwaukee*
Kenneth Courage, *University of Florida*
Alan Danaher, *Kittelson & Associates, Inc.*
Rafael DeArazoza, *Florida Department of Transportation*
Lily Elefteriadou, *Pennsylvania State University*
Dan Fambro, *Texas A & M University (deceased)*
Ronald Giguere, *Federal Highway Administration*
Albert Grover, *Albert Grover & Associates*
Mariano Gullón Löw, *Centro de Estudios de Carreteras (deceased)*
Fred L. Hall, *McMaster University, Canada*
Douglas Harwood, *Midwest Research Institute*
Chris Hoban, *The World Bank*
Wayne Kittelson, *Kittelson & Associates, Inc.*
Michael Kyte, *University of Idaho*
Adolf D. May, *University of California at Berkeley*
Douglas McLeod, *Florida Department of Transportation*
Barbara Ostrom, *LAW PCS*
James Powell, *Parsons Transportation Group*
Nagui Roupail, *North Carolina State University*
Erik Ruehr, *Valley Research and Planning Associates*
Rikke Rysgaard, *Danish Road Directorate*
James Schoen, *Catalina Engineering, Inc.*
Alex Sorton, *Northwestern University*
Dennis Strong, *Strong Concepts*
Stan Teply, *University of Alberta, Canada*
Rod Troutbeck, *Queensland University of Technology, Australia*
Richard Cunard, *Transportation Research Board Staff Representative*

Emeritus Members

(As of February 1, 2000)

Adolf D. May, *University of California at Berkeley*
Carlton C. Robinson, *Consultant*

Subcommittee on Arterials

James Bonneson, *Texas A & M University*—Chair
Janice Daniel, *New Jersey Institute of Technology*
Ronald Giguere, *Federal Highway Administration*
Joel Marcuson, *Sverdrup Civil, Inc.*
Doug McLeod, *Florida Department of Transportation*

(continued)

Subcommittee on Arterials (continued)

Dennis Strong, *Strong Concepts*
Andrzej Tarko, *Purdue University*
Mark Vandehey, *Kittelson & Associates, Inc.*

Subcommittee on Concepts and Definitions

Barbara Ostrom, *LAW PCS—Chair*
Fred L. Hall, *McMaster University, Canada*
Doug McLeod, *Florida Department of Transportation*
Stan Teply, *University of Alberta, Canada*

Subcommittee on Freeways and Multilane Highways

Adolf D. May, *University of California at Berkeley—Group Leader, Uninterrupted Flow*
Nagui Rouphail, *North Carolina State University—Group Leader, Uninterrupted Flow*
Lily Elefteriadou, *Pennsylvania State University—Leader, Ramp and Weaving Junctions*
James Schoen, *Catalina Engineering, Inc.—Leader, Basic Freeway Segments and Multilane Highways*
Michael Cassidy, *University of California at Berkeley*
Michael Church, *California Department of Transportation*
Brian Eads, *Crawford, Murphy & Tilly, Inc.*
Lily Elefteriadou, *Pennsylvania State University*
Joseph Fazio, *Illinois Institute of Technology*
Fred L. Hall, *McMaster University, Canada*
Abdul-Rahman Hamad, *H.W. Lochner, Inc.*
Lee Han, *University of Tennessee*
Joel Leisch, *Consultant*
John Leonard, *Georgia Institute of Technology*
Barbara Ostrom, *LAW PCS*
Thomas Parlante, *Arizona Department of Transportation*
Ronald Pfefer, *Northwestern University*
William Prosser, *Federal Highway Administration*
William Reilly, *Catalina Engineering, Inc.*
Bruce Robinson, *Kittelson & Associates, Inc.*
Roger Roess, *Polytechnic University*
Fred Rooney, *California Department of Transportation*
Rikke Rysgaard, *Danish Road Directorate*
James Schoen, *Catalina Engineering, Inc.*
Ronald Sonntag, *Marquette University*
Andrzej Tarko, *Purdue University*
Michelle Thomas, *Federal Highway Administration*
Jose Ulerio, *Polytechnic University*
Tom Urbanik, *Texas A & M University*

Subcommittee on Interchange Ramp Terminals

James Powell, *Parsons Transportation Group—Chair*
James Bonneson, *Texas A & M University*
Robert Bryson, *City of Milwaukee*
Michael Church, *California Department of Transportation*
Thomas Creasey, *Jordan, Jones & Goulding, Inc.*
Janice Daniel, *New Jersey Institute of Technology*

(continued)

Subcommittee on Interchange Ramp Terminals *(continued)*

Michael Holling, *Transcore*
 B. Kent Lall, *Portland State University*
 Joel Leisch, *Consultant*
 Joel Marcuson, *Sverdrup Civil, Inc.*
 Scott Parker, *Edwards & Kelcey, Inc.*
 Fred Rooney, *California Department of Transportation*

Subcommittee on Pedestrians and Bicycles

Alex Sorton, *Northwestern University—Chair*
 Patrick Allen, *California Department of Transportation*
 Hein Botma, *Delft University, The Netherlands*
 Jeff Davis, *The Citadel*
 Joseph Fazio, *Illinois Institute of Technology*
 Chris Hoban, *The World Bank*
 Bruce Landis, *Sprinkler Associates*
 John LaPlante, *TYLin-Bascor*
 Joe Milazzo, *North Carolina State University*
 John Morrall, *University of Calgary, Canada*
 Virginia Sisiopiku, *Michigan State University*
 Mark Virkler, *University of Missouri at Columbia*
 Thomas Walsh, *Madison Department of Transportation*

Subcommittee on Planning Applications

Douglas McLeod, *Florida Department of Transportation—Chair*
 Jim Altenstadter, *Arizona Department of Transportation*
 Robert Bryson, *City of Milwaukee*
 Thomas Creasey, *Jordan, Jones & Goulding, Inc.*
 Richard Dowling, *Dowling Associates, Inc.*
 Kurt Eichin, *Florida Department of Transportation*
 Abdul-Rahman Hamad, *H.W. Lochner, Inc.*
 John Karachepone, *Kittelson & Associates, Inc.*
 Wayne Kittelson, *Kittelson & Associates, Inc.*
 William McShane, *Polytechnic University*
 Barbara Ostrom, *LAW PCS*
 Elena Prassas, *Polytechnic University*
 Erik Ruehr, *VRPA Technologies*
 Paul Ryus, *Kittelson & Associates, Inc.*
 Terrel Shaw, *Reynolds, Smith & Hills, Inc.*
 Stan Teply, *University of Alberta, Canada*

Subcommittee on Research

Fred L. Hall, *McMaster University, Canada—Chair*
 Alan Danaher, *Kittelson & Associates, Inc.*
 Richard Dowling, *Dowling Associates, Inc.*
 Lily Elefteriadou, *Pennsylvania State University*
 John Leonard, *Georgia Institute of Technology*
 George List, *Rensselaer Polytechnic University*
 Pawan Maini, *University of Colorado at Denver*
 James Powell, *DeLeuw Cather & Company*
 Larry Sutherland, *Ohio Department of Transportation*
 Rod Troutbeck, *Queensland University of Technology*
 Davey Warren, *Federal Highway Administration*

Subcommittee on Signalized Intersections

Dennis Strong, *Strong Concepts—Chair*
Rahmi Akcelik, *Akcelik & Associates*
Rahim Benekohal, *University of Illinois*
Robert Bryson, *City of Milwaukee*
Kenneth Courage, *University of Florida*
Glenn Grigg
Albert Grover, *Albert Grover & Associates*
David Hook, *Hook Engineering*
John Leonard, *Georgia Institute of Technology*
Feng-Bor Lin, *Clarkson University*
Pawan Maini, *University of Colorado at Denver*
Carroll Messer, *Texas A & M University*
Elena Prassas, *Polytechnic University*
Bruce Robinson, *Kittelson & Associates, Inc.*
Roger Roess, *Polytechnic University*
Nagui Rouphail, *North Carolina State University*
Stan Teply, *University of Alberta, Canada*
Robert Wortman, *University of Arizona*

Subcommittee on Transit Systems

Alan Danaher, *Kittelson & Associates, Inc.—Chair*
Tara Barte, *Florida Department of Transportation*
Howard Benn, *Montgomery County, MD Transit*
Joseph Goodman, *Federal Transit Administration*
William Hoey, *Consultant*
Michael Kyte, *University of Idaho*
Herbert Levinson, *Consultant*
David Miller, *Parsons Brinckerhoff*
Rikke Rysgaard, *Danish Road Directorate*
Paul Ryus, *Kittelson & Associates, Inc.*
Kevin St. Jacques, *Wilbur Smith and Associates*
Joel Volinski, *Center for Urban Transportation Research—University of South Florida*

Subcommittee on Two-Lane Roads

Douglas Harwood, *Midwest Research Institute—Chair*
Jan Botha, *San Jose State University*
Hein Botma, *Delft University, The Netherlands*
Albert Grover, *Albert Grover & Associates*
Mariano Gullón Löw, *Centro de Estudios de Carreteras (deceased)*
Christopher Hoban, *The World Bank*
Greg Laragan, *Idaho Department of Transportation*
David Lovell, *University of Maryland*
Adolf D. May, *University of California at Berkeley*
Carroll Messer, *Texas A & M University*
John Morrall, *University of Calgary, Canada*
William Prosser, *Federal Highway Administration*
Guido Radelat
Alex Sorton, *Northwestern University Traffic Institute*
Davey Warren, *Federal Highway Administration*
Alexander Werner, *Reid Crowther Consultants, Ltd.*

Subcommittee on Unsignalized Intersections

Rod Troutbeck, *Queensland University of Technology, Australia—Chair*
 Werner Brilon, *Ruhr University, Bochum, Germany*
 Robert Bryson, *City of Milwaukee*
 Joon Byun, *Federal Highway Administration*
 Mitzi M. Dobersek, *Wisconsin Department of Transportation*
 Aimee Flannery, *Mitretek Systems*
 Glenn Grigg
 Mariano Gullón Löw, *Centro de Estudios de Carreteras (deceased)*
 Wayne Haussler, *Goodkind & O’Dea, Inc.*
 Dane Ismart, *Federal Highway Administration*
 R. Ian Kingham, *GMK Transportation, Ltd., Canada*
 Wayne Kittelson, *Kittelson & Associates, Inc.*
 Michael Kyte, *University of Idaho*
 B. Kent Lall, *Portland State University*
 George List, *Rensselaer Polytechnic Institute*
 Charles Manning, *Creighton Manning, Inc.*
 Joseph Marek, *Clackamas County*
 Michael O’Rourke, *Eng-Wong-Taub & Associates*
 Bruce Robinson, *Kittelson & Associates, Inc.*
 Lee Rodegerdts, *Kittelson & Associates, Inc.*
 Erik Ruehr, *VRPA Technologies*
 John Sampson, *Jeffares & Green, Inc.*
 Zong Tian, *Kittelson & Associates, Inc.*
 Marian Tracz, *Cracow Technical University, Poland*
 Kenneth Voigt, *HNTB Corporation*
 Andrew Wolfe, *Union College*

Subcommittee on User Liaison

Wayne Kittelson, *Kittelson & Associates, Inc.—Chair*
 Robert Foyle, *ITRE*
 Ronald Giguere, *Federal Highway Administration*
 Joel Leisch, *Consultant*
 John Leonard, *Georgia Institute of Technology*
 William Prosser, *Federal Highway Administration*
 Dennis Strong, *Strong Concepts*
 Charles Wallace, *University of Florida*

NCHRP 3-55 PANEL

Carlton C. Robinson, *Consultant—Chair*
 Rafael DeArazoza, *Florida Department of Transportation*
 Richard Dowling, *Dowling Associates, Inc.*
 Ronald Giguere, *Federal Highway Administration*
 Wayne Kittelson, *Kittelson & Associates, Inc.*
 Barbara Ostrom, *LAW PCS*
 William Prosser, *Federal Highway Administration*
 Nagui Rouphail, *North Carolina State University*
 Ronald Sonntag, *Marquette University*
 Stan Teply, *University of Alberta, Canada*
 Edward Thomas, *Federal Transit Administration*
 John Zegeer, *Kittelson & Associates, Inc.*
 B. Ray Derr, *Transportation Research Board Staff Representative*

RESEARCH TEAM

William Reilly, Principal Investigator, *Catalina Engineering, Inc.*
Susan Donahue, *Catalina Engineering, Inc.*
Michael Ereti, *Catalina Engineering, Inc.*
Wei Lien Liang, *Catalina Engineering, Inc.*
Khang Nguyen, *Catalina Engineering, Inc.*
Andrea Reilly, *Catalina Engineering, Inc.*
James Schoen, *Catalina Engineering, Inc.*

Roger Roess, *Polytechnic University*
Elena Prassas, *Polytechnic University*
Jose Ulerio, *Polytechnic University*
Rahmi Akcelik, *Akcelik & Associates*
Ronald Pfefer, *Maron Engineering, Ltd.*

HCM 2000 was edited and produced under the supervision of Nancy A. Ackerman, director of the TRB Office of Reports and Editorial Services; Javy Awan and Norman Solomon edited the manual.

CHAPTER 1

INTRODUCTION

CONTENTS

I.	INTRODUCTION	1-1
	Purpose of the Manual	1-1
	Scope of the Manual	1-1
	Use of the Manual	1-1
	Results from the Metric and U.S. Customary Versions	1-1
	North American and International Applications	1-2
	Online Manual	1-2
	Calculation Software	1-2
II.	HISTORY OF THE MANUAL	1-2
III.	WHAT'S NEW IN HCM 2000	1-3
	Part I: Overview	1-3
	Part II: Concepts	1-4
	Part III: Methodologies	1-4
	Urban Streets	1-5
	Signalized Intersections	1-5
	Unsignalized Intersections	1-5
	Pedestrians	1-5
	Bicycles	1-5
	Two-Lane Highways	1-5
	Multilane Highways	1-5
	Freeway Facilities	1-5
	Basic Freeway Segments	1-5
	Freeway Weaving	1-5
	Ramps and Ramp Junctions	1-5
	Interchange Ramp Terminals	1-5
	Transit	1-5
	Part IV: Corridor and Areawide Analyses	1-5
	Part V: Simulation and Other Models	1-6
IV.	RESEARCH BASIS FOR HCM 2000	1-6
V.	REFERENCE	1-6

EXHIBITS

Exhibit 1-1.	HCM 1985 Edition: Organization and Updates	1-3
Exhibit 1-2.	HCM 2000 Organization	1-4
Exhibit 1-3.	Related Research Projects	1-7

I. INTRODUCTION

PURPOSE OF THE MANUAL

The *Highway Capacity Manual* (HCM) provides transportation practitioners and researchers with a consistent system of techniques for the evaluation of the quality of service on highway and street facilities. The HCM does not set policies regarding a desirable or appropriate quality of service for various facilities, systems, regions, or circumstances. Its objectives include providing a logical set of methods for assessing transportation facilities, assuring that practitioners have access to the latest research results, and presenting sample problems. This fourth edition of the HCM is intended to provide a systematic and consistent basis for assessing the capacity and level of service for elements of the surface transportation system and also for systems that involve a series or a combination of individual facilities. The manual is the primary source document embodying research findings on capacity and quality of service and presenting methods for analyzing the operations of streets and highways and pedestrian and bicycle facilities. A complementary volume, *Transit Capacity and Quality of Service Manual*—now in development by the Transportation Research Board (TRB)—presents methods for analyzing transit services from the perspectives of both the user and the operator.

SCOPE OF THE MANUAL

This manual is divided into five parts. Part I provides an overview of the traffic flow concepts inherent in capacity and level-of-service analyses, a discussion of their applications, and a description of policy decision making based on this fourth edition. It also includes a glossary of terms and a list of symbols. Part II describes the concepts and provides the estimated default values for use in the analytical work presented in Part III. Part III offers specific methods for assessing roadway, bicycle, pedestrian, and transit facilities in relation to their performance, capacity, and level of service.

For the analyst who must assess more than an individual facility, Part IV of this manual provides a framework for the analysis of corridors, areas, and multimodal operations. In some cases, it provides specific computational techniques, while in others it provides a more general analysis of the facility or facilities. Part V offers background and information on the type of models appropriate for systemwide or more complex capacity and level-of-service analyses.

Additional information beyond this manual is available on the World Wide Web at <http://nationalacademies.org/trb/hcm>.

USE OF THE MANUAL

In addition to the service measures necessary to determine quality of service, this manual identifies analytical procedures for other performance measures. These allow the analyst to assess different aspects of an existing or planned facility. Moreover, this document makes it possible to evaluate broader systems of facilities and to establish a link between operational and planning models.

This manual is intended for use by a range of practitioners, including traffic engineers, traffic operations personnel, design engineers, planners, management personnel, teachers, and university students. To use the manual effectively and to apply its methodologies, some technical background is desirable—typically university-level training or technical work in a public agency or consulting firm.

RESULTS FROM THE METRIC AND U.S. CUSTOMARY VERSIONS

This fourth edition of the manual is published in two versions, one in metric units and one in U.S. customary units. Although the methodologies in the metric and U.S. customary versions of the manual are identical, parameters, level-of-service thresholds, and other values will be hard-converted. This means that analysis results calculated using

Part I: Overview

1. Introduction
2. Capacity and Level-of-Service Concepts
3. Applications
4. Decision Making
5. Glossary
6. Symbols

Part II: Concepts

7. Traffic Flow Parameters
8. Traffic Characteristics
9. Analytical Procedures Overview
10. Urban Street Concepts
11. Pedestrian and Bicycle Concepts
12. Highway Concepts
13. Freeway Concepts
14. Transit Concepts

Part III: Methodologies

15. Urban Streets
16. Signalized Intersections
17. Unsignalized Intersections
18. Pedestrians
19. Bicycles
20. Two-Lane Highways
21. Multilane Highways
22. Freeway Facilities
23. Basic Freeway Segments
24. Freeway Weaving
25. Ramps and Ramp Junctions
26. Interchange Ramp Terminals
27. Transit

Part IV: Corridor and Areawide Analyses

28. Assessment of Multiple Facilities
29. Corridor Analysis
30. Areawide Analysis

Part V: Simulation and Other Models

31. Simulation and Other Models

the metric version may differ slightly from those calculated using the U.S. customary version. Transportation agencies may want to specify which system of units they and their consultants will use and discourage conversions between systems of units.

NORTH AMERICAN AND INTERNATIONAL APPLICATIONS

During the 1990s, capacity and level of service analysis generated interest on an international scale. Therefore, increased attention and effort has focused on incorporating into the HCM research results and proposed procedures from countries outside of North America. Also, by producing its first HCM with metric units, TRB has taken a step toward making these methods and procedures more applicable to international work. However, the user of the manual is cautioned that the majority of the research base, the default values, and the typical applications are from North America, particularly from the United States. Although there is considerable value in the general methods presented, their use outside of North America requires additional emphasis on calibrating the equations and the procedures to local conditions as well as recognizing major differences in the composition of traffic; in driver, pedestrian, and bicycle characteristics; and in typical geometrics and control measures.

ONLINE MANUAL

HCM 2000 is available in electronic format on CD-ROM. The online edition offers several multimedia, user-interactive components that allow for viewing of simulated and real-world traffic conditions, explanations of capacity and level of service concepts, and a step-by-step graphic presentation of the solutions to sample problems. The online manual faithfully presents the material and procedures described in this book.

CALCULATION SOFTWARE

As a companion tool to this manual, commercial software is available to perform the numerical calculations for the chapters in Part III. The CD-ROM online manual has a feature to incorporate the user's preferred software as required. Although there are several calculation software packages available, TRB does not produce, review, or endorse any.

CD-ROM version

Software for
implementing HCM
methodologies

II. HISTORY OF THE MANUAL

The first edition of the HCM was published in 1950 by the U.S. Bureau of Public Roads as a guide to the design and operational analysis of highway facilities. In 1965, TRB—then known as the Highway Research Board—published the second edition under the guidance of its Highway Capacity Committee. The third edition, published by TRB in 1985, reflected more than two decades of comprehensive research conducted by a variety of agencies under the sponsorship of several organizations, primarily the National Cooperative Highway Research Program and the Federal Highway Administration. Its development was guided by the TRB Committee on Highway Capacity and Quality of Service. As a result of continuing research in capacity, the third edition of the HCM was updated in 1994 and 1997. Exhibit 1-1 lists the 1985 HCM chapters along with their most recent updates.

The 1997 update included extensive revisions to Chapters 3, 9, 10, and 11. In addition, Chapters 1, 4, 5, 6, and 7 were modified to make them consistent with other revised chapters.

The basic freeway sections chapter (Chapter 3) revised the procedure for determining capacity based on density. It also proposed that capacity values under ideal flow conditions varied by free-flow speed.

EXHIBIT 1-1. HCM 1985 EDITION: ORGANIZATION AND UPDATES

Chapter	Description/Facility Type	Final Update
1	Introduction, Concepts, and Applications	1997
2	Traffic Characteristics	1994
Uninterrupted-Flow Facilities		
3	Basic Freeway Sections	1997
4	Weaving Areas	1997
5	Ramps and Ramp Junctions	1997
6	Freeway Systems	1997
7	Multilane Rural and Suburban Highways	1997
8	Two-Lane Highways	1985
Interrupted-Flow Facilities		
9	Signalized Intersections	1997
10	Unsignalized Intersections	1997
11	Arterial Streets	1997
12	Transit Capacity	1985
13	Pedestrians	1985
14	Bicycles	1985

The signalized intersections chapter included findings from research on actuated traffic signals. The delay equation was modified to account for signal coordination, oversaturation, variable length analysis periods, and the presence of initial queues at the beginning of an analysis period. The level-of-service measure was changed from stopped delay to control delay. Adjustments were made to the permitted left-turn movement model and to the left-turn equivalency table.

The chapter on unsignalized intersections was completely revised to incorporate the results of a nationwide research project in the United States examining two-way and four-way stop-controlled intersections. In addition, it addressed the impact of an upstream traffic signal on capacity at a two-way stop-controlled intersection. Procedures were provided to account for flared approaches, upstream signals, pedestrian crossings, and two-stage gap acceptance (when vehicles seek refuge in a median before crossing a second stream of traffic).

The arterial streets chapter in the 1997 HCM incorporated the relevant changes from the signalized intersections chapter. It also established a new arterial classification for high-speed facilities. The delay equation was modified to account for the effect of platoons from upstream signalized intersections.

III. WHAT'S NEW IN HCM 2000

This fourth edition of the HCM is published in two versions: metric and U.S. customary units. The chapter organization also has changed—HCM 2000 consists of five parts with a total of 31 chapters. Exhibit 1-2 lists the parts and chapters. The changes to these are summarized in the next sections.

PART I: OVERVIEW

Part I presents the basic concept of level of service and capacity as applied throughout the manual. In addition, specific discussions cover different types of applications, decision making, and guidelines for using results from the methodologies in this manual. A glossary of terms and a list of symbols—previously at the end of the manual—now appear in the first part and are significantly expanded.

Part I: Chapters 1–6

EXHIBIT 1-2. HCM 2000 ORGANIZATION

Chapter	Description/Facility Type
Part I: Overview	
1	Introduction
2	Capacity and Level-of-Service Concepts
3	Applications
4	Decision Making
5	Glossary
6	Symbols
Part II: Concepts	
7	Traffic Flow Parameters
8	Traffic Characteristics
9	Analytical Procedures Overview
10	Urban Street Concepts
11	Pedestrian and Bicycle Concepts
12	Highway Concepts
13	Freeway Concepts
14	Transit Concepts
Part III: Methodologies	
15	Urban Streets
16	Signalized Intersections
17	Unsignalized Intersections
18	Pedestrians
19	Bicycles
20	Two-Lane Highways
21	Multilane Highways
22	Freeway Facilities
23	Basic Freeway Segments
24	Freeway Weaving
25	Ramps and Ramp Junctions
26	Interchange Ramp Terminals
27	Transit
Part IV: Corridor and Areawide Analyses	
28	Assessment of Multiple Facilities
29	Corridor Analysis
30	Areawide Analysis
Part V: Simulation and Other Models	
31	Simulation and Other Models

PART II: CONCEPTS

Part II presents the concepts of the facility types with methodologies described in the manual and includes discussions of typical capacity parameters. In the past, these materials were presented together with the methodology for each facility. New discussion reviews the precision and accuracy of variables in the HCM. Default values are offered to aid the analyst in obtaining input values for the methodologies that are presented in Part III. In addition, the second part includes several sample service volume tables and, in Chapter 10, a modified quick-estimation method for evaluating signalized intersections.

Part II: Chapters 7–14

PART III: METHODOLOGIES

Part III: Chapters 15–27

Part III contains the analytical methodologies, which generally correspond to the 12 facility chapters in the 1997 version of the HCM.

Urban Streets

Titled “Arterial Streets” in the 1997 HCM, this chapter does not change the methodology significantly, but includes new worksheets.

Signalized Intersections

A methodology for the estimation of back of queue is added, along with new saturation flow rate adjustment factors for pedestrian and bicycle effects. New consolidated worksheets are provided.

Unsignalized Intersections

Additions to this chapter include a new 95th percentile queue estimation equation and newly designed worksheets.

Pedestrians

This chapter expands the 1985 HCM methodology, enabling the evaluation of several pedestrian facility types previously not addressed.

Bicycles

A new methodology for evaluating bicycle facilities, based on the concept of events and hindrance, has replaced the previous version in its entirety.

Two-Lane Highways

A new methodology for evaluating two-lane highways by direction of travel or by both directions combined has replaced the previous version in its entirety.

Multilane Highways

New truck equivalency values are introduced.

Freeway Facilities

A new methodology is presented.

Basic Freeway Segments

Again, new truck equivalency values are introduced.

Freeway Weaving

The 1997 HCM methodology has been slightly revised.

Ramps and Ramp Junctions

A new speed prediction model is presented.

Interchange Ramp Terminals

Although this new chapter does not describe a methodology, it presents concepts for analyzing interchange areas.

Transit

A new methodology is presented, based on research conducted for TRB’s *Transit Capacity and Quality of Service Manual (I)*.

PART IV: CORRIDOR AND AREAWIDE ANALYSES

The methodologies for corridor and areawide analyses are new additions to the HCM. The chapters show how to aggregate results from the Part III chapters to analyze the combined effects of different facility types.

PART V: SIMULATION AND OTHER MODELS

Part V is a new addition, presenting concepts and numerical exercises using traffic simulation models. In addition, it demonstrates typical applications of simulation models to complement HCM methodologies. An extensive reference list points to more information on simulation and other models.

Part V: Chapter 31

IV. RESEARCH BASIS FOR HCM 2000

Exhibit 1-3 lists the major research projects performed since 1990 that have contributed significantly to the contents of HCM 2000.

V. REFERENCE

1. *Transit Capacity and Quality of Service Manual*. Transit Cooperative Research Program Web Document No. 6. TRB, National Research Council, Washington, D.C., 1999. Online. Available: <http://www4.nationalacademies.org/trb/crp.nsf/all+projects/tcrp+a15>.

EXHIBIT 1-3. RELATED RESEARCH PROJECTS

Research	Research Title	Objective
NCHRP 3-33	Capacity and Level-of-Service Procedures for Multilane Rural and Suburban Highways	Develop procedures to determine capacity and level of service of multilane highways
NCHRP 3-37	Capacity and Level of Service at Ramp-Freeway Junctions	Develop methodology to determine capacity and level of service at ramp-freeway junctions
NCHRP 3-37(2)	Capacity and Level of Service at Ramp-Freeway Junctions (Phase II)	Validate methodology produced by NCHRP 3-37
NCHRP 3-45	Speed-Flow Relationships for Basic Freeway Segments	Revise material on speed-flow relationships to update HCM 1994 analysis of Basic Freeway Sections
NCHRP 3-46	Capacity and Level of Service at Unsignalized Intersections	Develop capacity analysis procedure for stop-controlled intersections and correlate with the warrants for installation of traffic signals in the <i>Manual on Uniform Traffic Control Devices</i>
NCHRP 3-47	Capacity Analysis of Interchange Ramp Terminals	Develop methodology to determine capacity and level of service at signalized ramp terminals
NCHRP 3-48	Capacity Analysis for Actuated Intersections	Develop capacity and level of service analysis at intersections with actuated control
NCHRP 3-49	Capacity and Operational Effects of Midblock Left-Turn Lanes	Develop qualitative methodology for evaluating alternative midblock left-turn treatments on urban streets
NCHRP 3-55	<i>Highway Capacity Manual</i> for the Year 2000	Recommend user-preferred format and delivery system for HCM 2000
NCHRP 3-55(2)	Techniques to Estimate Speeds and Service Volumes for Planning Applications	Develop extended planning techniques for estimating measures of effectiveness (MOEs)
NCHRP 3-55(2)A	Planning Applications for the Year 2000 <i>Highway Capacity Manual</i>	Develop draft chapters related to planning for HCM 2000
NCHRP 3-55(3)	Capacity and Quality of Service for Two-Lane Highways	Improve methods to determine capacity and quality of service of two-lane highways
NCHRP 3-55(4)	Performance Measures and Levels of Service in the Year 2000 <i>Highway Capacity Manual</i>	Recommend MOEs and additional performance measures
NCHRP 3-55(5)	Capacity and Quality of Service of Weaving Areas	Improved methods for capacity and quality of service analyses of weaving areas
NCHRP 3-55(6)	Production of the Year 2000 <i>Highway Capacity Manual</i>	Complete HCM 2000 document
TCRP A-07	Operational Analysis of Bus Lanes on Arterials	Develop procedures to determine capacity and level of service of bus flow on arterials
TCRP A-07A	Operational Analysis of Bus Lanes on Arterials: Extended Field Investigations	Expand field testing and validation of procedures developed in TCRP A-07
TCRP A-15	Development of Transit Capacity and Quality of Service Principles, Practices and Procedures	Provide transit input to HCM 2000
FHWA	Capacity Analysis of Pedestrian and Bicycle Facilities Project (DTFH61-92-R-00138)	Update method for analyzing effects of pedestrians and bicycles at signalized intersections; recommend improvements
FHWA	Capacity and Level of Service Analysis for Freeway Systems Project (DTFH61-95-Y-00086)	Develop procedure to determine capacity and level of service of a freeway facility

CHAPTER 2

CAPACITY AND LEVEL-OF-SERVICE CONCEPTS

CONTENTS

I. INTRODUCTION	2-1
II. CAPACITY	2-2
III. DEMAND	2-2
IV. QUALITY AND LEVELS OF SERVICE	2-2
Service Flow Rates	2-3
Performance Measures	2-3
Service Measures	2-3
V. FACTORS AFFECTING CAPACITY AND LOS	2-3
Base Conditions	2-3
Roadway Conditions	2-4
Traffic Conditions	2-4
Vehicle Type	2-4
Directional and Lane Distribution	2-5
Control Conditions	2-5
Technology	2-6

I. INTRODUCTION

This manual presents methods for analyzing capacity and level of service for a broad range of transportation facilities. It provides procedures for analyzing streets and highways, bus and on-street light rail transit, and pedestrian and bicycle paths.

Facilities are classified into two categories of flow: uninterrupted and interrupted. Uninterrupted-flow facilities have no fixed elements, such as traffic signals, that are external to the traffic stream and might interrupt the traffic flow. Traffic flow conditions result from the interactions among vehicles in the traffic stream and between vehicles and the geometric and environmental characteristics of the roadway.

Interrupted-flow facilities have controlled and uncontrolled access points that can interrupt the traffic flow. These access points include traffic signals, stop signs, yield signs, and other types of control that stop traffic periodically (or slow it significantly), irrespective of the amount of traffic.

Uninterrupted and interrupted flows describe the type of facility, not the quality of the traffic flow at any given time. A freeway experiencing extreme congestion, for example, is still an uninterrupted-flow facility because the causes of congestion are internal.

Freeways and their components operate under the purest form of uninterrupted flow. Not only are there no fixed interruptions to traffic flow, but access is controlled and limited to ramp locations. Multilane highways and two-lane highways also can operate under uninterrupted flow in long segments between points of fixed interruption. On multilane and two-lane highways, it is often necessary to examine points of fixed interruption as well as uninterrupted-flow segments.

The analysis of interrupted-flow facilities must account for the impact of fixed interruptions. A traffic signal, for example, limits the time available to various movements in an intersection. Capacity is limited not only by the physical space but by the time available for movements.

Transit, pedestrian, and bicycle flows generally are considered to be interrupted. Uninterrupted flow might be possible under certain circumstances, such as in a long busway without stops or along a pedestrian corridor. However, in most situations, capacity is limited by stops along the facility.

Capacity analysis, therefore, is a set of procedures for estimating the traffic-carrying ability of facilities over a range of defined operational conditions. It provides tools to assess facilities and to plan and design improved facilities.

A principal objective of capacity analysis is to estimate the maximum number of persons or vehicles that a facility can accommodate with reasonable safety during a specified time period. However, facilities generally operate poorly at or near capacity; they are rarely planned to operate in this range. Accordingly, capacity analysis also estimates the maximum amount of traffic that a facility can accommodate while maintaining its prescribed level of operation.

Operational criteria are defined by introducing the concept of level of service. Ranges of operating conditions are defined for each type of facility and are related to the amount of traffic that can be accommodated at each service level.

The two principal concepts of this manual—capacity and level of service—are defined in the following sections.

Uninterrupted-flow facility defined

Interrupted-flow facility defined

Capacity analysis defined

Capacity defined

II. CAPACITY

The capacity of a facility is the maximum hourly rate at which persons or vehicles reasonably can be expected to traverse a point or a uniform section of a lane or roadway during a given time period under prevailing roadway, traffic, and control conditions.

Vehicle capacity is the maximum number of vehicles that can pass a given point during a specified period under prevailing roadway, traffic, and control conditions. This assumes that there is no influence from downstream traffic operation, such as the backing up of traffic into the analysis point.

Person capacity is the maximum number of persons that can pass a given point during a specified period under prevailing conditions. Person capacity is commonly used to evaluate public transit services, high-occupancy vehicle lanes, and pedestrian facilities.

Prevailing roadway, traffic, and control conditions define capacity; these conditions should be reasonably uniform for any section of facility analyzed. Any change in the prevailing conditions changes the capacity of the facility.

Capacity analysis examines segments or points (such as signalized intersections) of a facility under uniform traffic, roadway, and control conditions. These conditions determine capacity; therefore, segments with different prevailing conditions will have different capacities.

Capacity is defined on the basis of reasonable expectancy

Reasonable expectancy is the basis for defining capacity. That is, the stated capacity for a given facility is a flow rate that can be achieved repeatedly for peak periods of sufficient demand. Stated capacity values can be achieved on facilities with similar characteristics throughout North America. Capacity is not the absolute maximum flow rate observed on such a facility. Driver characteristics vary from region to region, and the absolute maximum flow rate can vary from day to day and from location to location.

Persons per hour, passenger cars per hour, and vehicles per hour are measures that can define capacity, depending on the type of facility and type of analysis. The concept of person flow is important in making strategic decisions about transportation modes in heavily traveled corridors and in defining the role of transit and high-occupancy vehicle priority treatments. Person capacity and person flow weigh each type of vehicle in the traffic stream by the number of occupants it carries.

Concepts of demand and volume

III. DEMAND

In this manual, demand is the principal measure of the amount of traffic using a given facility. Demand relates to vehicles arriving; volume relates to vehicles discharging. If there is no queue, demand is equivalent to the traffic volume at a given point on the roadway. Throughout this manual, the term volume generally is used for operating conditions below the threshold of capacity.

Quality and level of service defined

IV. QUALITY AND LEVELS OF SERVICE

Quality of service requires quantitative measures to characterize operational conditions within a traffic stream. Level of service (LOS) is a quality measure describing operational conditions within a traffic stream, generally in terms of such service measures as speed and travel time, freedom to maneuver, traffic interruptions, and comfort and convenience.

Six LOS are defined for each type of facility that has analysis procedures available. Letters designate each level, from A to F, with LOS A representing the best operating conditions and LOS F the worst. Each level of service represents a range of operating conditions and the driver's perception of those conditions. Safety is not included in the measures that establish service levels.

SERVICE FLOW RATES

The analytical methods in this manual attempt to establish or predict the maximum flow rate for various facilities at each level of service—except for LOS F, for which the flows are unstable or the vehicle delay is high. Thus, each facility has five service flow rates, one for each level of service (A through E). For LOS F, it is difficult to predict flow due to stop-and-start conditions.

The service flow rate is the maximum hourly rate at which persons or vehicles reasonably can be expected to traverse a point or uniform segment of a lane or roadway during a given period under prevailing roadway, traffic, and control conditions while maintaining a designated level of service. The service flow rates generally are based on a 15-min period. Typically, the hourly service flow rate is defined as four times the peak 15-min volume.

Note that service flow rates are discrete values, whereas levels of service represent a range of conditions. Because the service flow rates are the maximums for each level of service, they effectively define the flow boundaries between levels of service.

Most design or planning efforts typically use service flow rates at LOS C or D, to ensure an acceptable operating service for facility users.

Service flow rate defined

PERFORMANCE MEASURES

Each facility type that has a defined method for assessing capacity and level of service (see Part III of this manual) also has performance measures that can be calculated. These measures reflect the operating conditions of a facility, given a set of roadway, traffic, and control conditions. Travel speed and density on freeways, delay at signalized intersections, and walking speed for pedestrians are examples of performance measures that characterize flow conditions on a facility.

SERVICE MEASURES

For each facility type, one or more of the stated performance measures serves as the primary determinant of level of service. This LOS-determining parameter is called the service measure or sometimes the measure of effectiveness (MOE) for each facility type.

Service measure defined

V. FACTORS AFFECTING CAPACITY AND LOS

BASE CONDITIONS

Many of the procedures in this manual provide a formula or simple tabular or graphic presentations for a set of specified standard conditions, which must be adjusted to account for prevailing conditions that do not match. The standard conditions so defined are termed base conditions.

Base conditions assume good weather, good pavement conditions, users familiar with the facility, and no impediments to traffic flow. Other, more specific base conditions are identified in each chapter of Part III. Examples of base conditions for uninterrupted-flow facilities and for intersection approaches are given below.

Base conditions for uninterrupted-flow facilities include the following:

Base conditions defined

Impact of roadway conditions

- Lane widths of 3.6 m,
- Clearance of 1.8 m between the edge of the travel lanes and the nearest obstructions or objects at the roadside and in the median,
- Free-flow speed of 100 km/h for multilane highways,
- Only passenger cars in the traffic stream (no heavy vehicles),
- Level terrain,
- No no-passing zones on two-lane highways, and
- No impediments to through traffic due to traffic control or turning vehicles.

Base conditions for intersection approaches include the following:

- Lane widths of 3.6 m,
- Level grade,
- No curb parking on the approaches,
- Only passenger cars in the traffic stream,
- No local transit buses stopping in the travel lanes,
- Intersection located in a noncentral business district area, and
- No pedestrians.

In most capacity analyses, prevailing conditions differ from the base conditions, and computations of capacity, service flow rate, and level of service must include adjustments. Prevailing conditions are generally categorized as roadway, traffic, or control.

ROADWAY CONDITIONS

Roadway conditions include geometric and other elements. In some cases, these influence the capacity of a road; in others, they can affect a performance measure such as speed, but not the capacity or maximum flow rate of the facility.

Roadway factors include the following:

- Number of lanes,
- The type of facility and its development environment,
- Lane widths,
- Shoulder widths and lateral clearances,
- Design speed,
- Horizontal and vertical alignments, and
- Availability of exclusive turn lanes at intersections.

The horizontal and vertical alignment of a highway depend on the design speed and the topography of the land on which it is constructed.

In general, the severity of the terrain reduces capacity and service flow rates. This is significant for two-lane rural highways, where the severity of terrain not only can affect the operating capabilities of individual vehicles in the traffic stream, but also can restrict opportunities for passing slow-moving vehicles.

TRAFFIC CONDITIONS

Traffic conditions that influence capacities and service levels include vehicle type and lane or directional distribution.

Vehicle Type

The entry of heavy vehicles—that is, vehicles other than passenger cars (a category that includes small trucks and vans)—into the traffic stream affects the number of vehicles that can be served. Heavy vehicles are vehicles that have more than four tires touching the pavement.

Trucks, buses, and recreational vehicles (RVs) are the three groups of heavy vehicles addressed by the methods in this manual. Heavy vehicles adversely affect traffic in two ways:

- They are larger than passenger cars and occupy more roadway space; and

Impact of traffic conditions

- They have poorer operating capabilities than passenger cars, particularly with respect to acceleration, deceleration, and the ability to maintain speed on upgrades.

The second impact is more critical. The inability of heavy vehicles to keep pace with passenger cars in many situations creates large gaps in the traffic stream, which are difficult to fill by passing maneuvers. The resulting inefficiencies in the use of roadway space cannot be completely overcome. This effect is particularly harmful on sustained, steep upgrades, where the difference in operating capabilities is most pronounced, and on two-lane highways, where passing requires use of the opposing travel lane.

Heavy vehicles also can affect downgrade operations, particularly when downgrades are steep enough to require operation in a low gear. In these cases, heavy vehicles must operate at speeds slower than passenger cars, forming gaps in the traffic stream.

Trucks cover a wide range of vehicles, from lightly loaded vans and panel trucks to the most heavily loaded coal, timber, and gravel haulers. An individual truck's operational characteristics vary based on the weight of its load and its engine performance.

RVs also include a broad range: campers, both self-propelled and towed; motor homes; and passenger cars or small trucks towing a variety of recreational equipment, such as boats, snowmobiles, and motorcycle trailers. Although these vehicles might operate considerably better than trucks, the drivers are not professionals, accentuating the negative impact of RVs on the traffic stream.

Intercity buses are relatively uniform in performance. Urban transit buses generally are not as powerful as intercity buses; their most severe impact on traffic results from the discharge and pickup of passengers on the roadway. For the methods in this manual, the performance characteristics of buses are considered to be similar to those of trucks.

Directional and Lane Distribution

In addition to the distribution of vehicle types, two other traffic characteristics affect capacity, service flow rates, and level of service: directional distribution and lane distribution. Directional distribution has a dramatic impact on two-lane rural highway operation, which achieves optimal conditions when the amount of traffic is about the same in each direction. Capacity analysis for multilane highways focuses on a single direction of flow. Nevertheless, each direction of the facility usually is designed to accommodate the peak flow rate in the peak direction. Typically, morning peak traffic occurs in one direction and evening peak traffic occurs in the opposite direction. Lane distribution also is a factor on multilane facilities. Typically, the shoulder lane carries less traffic than other lanes.

CONTROL CONDITIONS

For interrupted-flow facilities, the control of the time for movement of specific traffic flows is critical to capacity, service flow rates, and level of service. The most critical type of control is the traffic signal. The type of control in use, signal phasing, allocation of green time, cycle length, and the relationship with adjacent control measures affect operations. All of these are discussed in detail in Chapters 10 and 16.

Stop signs and yield signs also affect capacity, but in a less deterministic way. A traffic signal designates times when each movement is permitted; however, a stop sign at a two-way stop-controlled intersection only designates the right-of-way to the major street. Motorists traveling on the minor street must stop and then find gaps in the major traffic flow to maneuver. The capacity of minor approaches, therefore, depends on traffic conditions on the major street. An all-way stop control forces drivers to stop and enter the intersection in rotation. Capacity and operational characteristics can vary widely, depending on the traffic demands on the various approaches.

Other types of controls and regulations can affect capacity, service flow rates, and LOS significantly. Restriction of curb parking can increase the number of lanes available on a street or highway. Turn restrictions can eliminate conflicts at intersections,

Impact of control conditions

increasing capacity. Lane use controls can allocate roadway space to component movements and can create reversible lanes. One-way street routings can eliminate conflicts between left turns and opposing traffic.

TECHNOLOGY

Emerging transportation technologies, also known as intelligent transportation systems (ITS), will enhance the safety and efficiency of vehicles and roadway systems. ITS strategies aim to increase the safety and performance of roadway facilities. For this discussion, ITS includes any technology that allows drivers and traffic control system operators to gather and use real-time information to improve vehicle navigation, roadway system control, or both.

To date, there has been little research to determine the impact of ITS on capacity and level of service. The procedures in this manual relate to roadway facilities without ITS enhancements.

Current ITS programs might have the following impacts on specific capacity analyses:

- For freeway and other uninterrupted-flow highways, ITS might achieve some decrease in headways, which would increase the capacity of these facilities. In addition, even with no decrease in headways, level of service might improve if vehicle guidance systems offered drivers a greater level of comfort than they currently experience in conditions with close spacing between vehicles.
- For signal and arterial operations, the major benefits of ITS would be a more efficient allocation of green time and an increase in capacity. ITS features likely will have a less pronounced impact on interrupted flow than on uninterrupted-flow facilities.
- At unsignalized intersections, capacity improvements might result if ITS assisted drivers in judging gaps in opposing traffic streams or if it somehow controlled gaps in flow on the major street.

Many of these ITS improvements—such as incident response and driver information systems—are occurring at the system level. Although ITS features will benefit the overall roadway system, they will not have an impact on the methods to calculate capacity and level of service for individual roadways and intersections.

CHAPTER 3

APPLICATIONS

CONTENTS

I. INTRODUCTION3-1

II. FRAMEWORK FOR APPLICATION OF THE HCM3-1

 Analysis of Individual Elements3-1

 System Analysis3-1

 Range of Operational Conditions Covered3-4

III. ANALYSIS OBJECTIVES3-5

 Levels of Analysis3-5

 HCM Analyses as Part of a Broader Process3-6

IV. REFERENCES3-7

EXHIBITS

Exhibit 3-1. Facilities and Road User Types Included in HCM Analyses3-2

Exhibit 3-2. Example of HCM Application to Analysis of Urban Systems3-3

Exhibit 3-3. Components of HCM Analysis of Urban Systems3-4

Exhibit 3-4. Levels and Objectives of Typical HCM Analyses3-6

Exhibit 3-5. HCM Performance Measures for Environmental and
Economic Analyses3-8

I. INTRODUCTION

This chapter provides an overview of the *Highway Capacity Manual* (HCM) analyses and describes how to apply them to a range of facilities. The scope of the manual and the framework for its application is followed by a description of the levels at which an analyst can apply the methods. The chapter concludes with an outline of how to use HCM analyses as input to other models.

II. FRAMEWORK FOR APPLICATION OF THE HCM

ANALYSIS OF INDIVIDUAL ELEMENTS

The purpose of the HCM is to produce estimates of performance measures for individual elements or facilities of a transport system, as well as to combine those elements to expand the view of the system. Exhibit 3-1 tabulates the various system elements for which the HCM provides analysis methodologies. The chapters shown appear in Part III of the HCM, which deals with methodologies. Other chapters provide background on related concepts.

SYSTEM ANALYSIS

Measures of effectiveness (MOEs)—performance measures that can be estimated quantitatively—are produced for individual system elements (and in some cases, subelements) by the methods in each chapter of Part III. These measures allow combination of the elements to produce an expanded view of a facility. For example, an analysis of a signalized intersection might consider individual movements, or groups of movements, on each approach. The results then can be successively combined to determine MOEs for each approach, each street, and the intersection as a whole. Similarly, the outputs from models for analyzing each element of a freeway facility can be combined to provide a result for a section of the freeway, including ramp junctions, weaving segments, and basic segments.

It is also possible to extend this procedure by combining the results of analyses of individual facilities to represent successively larger portions of a whole system, as addressed in Part IV of this manual. A system includes the corridors, with one or more types of facility or mode, as well as the areas representing all or part of the transportation network under study.

Exhibit 3-2 depicts a system analysis—combining the analyses of individual elements to produce an aggregate view of a facility, a corridor, or an area. The diagram provides an example that applies only to urban systems. Each box represents a method of analysis covered in this manual, indicating the element, or combination of elements, included. The box also indicates the chapter in which the applicable methodology is presented (Parts III and IV); however, there are also materials in other parts of the manual that might apply, especially in Part II. Finally, each box indicates the appropriate performance measures that can be derived from the chapter and that are applicable to a system analysis.

In general, speed and delay are the variables that derive from an analysis of individual elements and that can be used to calculate measures for system analysis. Usually this is done by converting the estimates of speed and delay into travel times and then aggregating the travel times across individual elements. In some cases, however, speed and delay can be averaged and used as performance measures even at aggregate levels.

Concept of system analysis

EXHIBIT 3-1. FACILITIES AND ROAD USER TYPES INCLUDED IN HCM ANALYSES

Element	Chapter ^a	Service Measure ^b	Reference Points on Exhibit 3-3	Performance Measure Used to Calculate Travel Time Systems Analysis
Vehicular				
Interrupted Flow				
Urban street	15	speed	L, P	speed
Signalized intersection	16	delay	H, O	delay
Two-way stop intersection	17	delay	I, J, M, N	delay
All-way stop intersection	17	delay	I, J, M, N	delay
Roundabout	17	^c	K	delay
Interchange ramp terminal	26	delay	Q, R, S	delay
Uninterrupted Flow				
Two-lane highway	20	speed, percent time-spent-following		speed
Multilane highway	21	density		speed
Freeway				
Basic segment	23	density	B, X, Z	speed
Ramp merge	25	density	A, E, V, Y	speed
Ramp diverge	25	density	C, D, G, U, W	speed
Weaving	24	speed	F	speed
Other Road Users				
Transit	27	^d	^e	speed
Pedestrian	18	space, delay	^f	speed, delay
Bicycle	19	event, delay	^g	speed, delay

Notes:

- a. Only Part III chapters are listed. When performing planning level analyses, the analyst should refer to Part II, for further guidelines and for selection of default values.
- b. The service measure for a given facility type is the primary performance measure and determines the level of service.
- c. HCM does not include a method for estimating performance measures for roundabouts. Non-HCM models that produce a delay estimate must be employed.
- d. Several measures capture the multidimensional nature of transit performance when defining LOS; see Chapter 27.
- e. Transit facilities, such as buses in mixed traffic, buses on exclusive lanes, buses in high-occupancy vehicle (HOV) lanes, and rail vehicles, can be analyzed separately as a transit system, or combined for a multimodal analysis.
- f. Pedestrian facilities, such as sidewalks and walkways, form a system and can be analyzed separately. Pedestrian delay at signalized intersections can be predicted or measured, and a multimodal analysis can include estimates of person delay, person travel time, and speed.
- g. Bicycle facilities—such as bicycles in traffic, bicycle lanes, and separate bicycle paths—form a system and can be analyzed separately. Speed of bicycles in traffic and on bicycle lanes can be predicted or measured, and a multimodal analysis can include estimates of person delay, person travel time, and speed.

The boxes referring to the basic analysis of individual elements are placed on the periphery of the diagram. The results of these analyses are aggregated at successively higher levels, until the objective is achieved. For example, Chapter 15 shows the analyst how to combine the results of delay estimates for unsignalized and signalized intersections with speed and travel time on the links between these points, to determine an average speed for an urban street segment. The analysis of a street segment can include pedestrian, bicycle, and transit modes. These can be combined with parallel segments to arrive at a result for a corridor analysis. A corridor analysis (Chapter 29) can involve combining results from analyses of uninterrupted-flow facilities, as well as transit, pedestrian, and bicycle facilities. Areawide analysis is the highest level of study possible (Chapter 30). The systems analyses that can be performed using this manual are shown in the central box of Exhibit 3-2.

EXHIBIT 3-2. EXAMPLE OF HCM APPLICATION TO ANALYSIS OF URBAN SYSTEMS

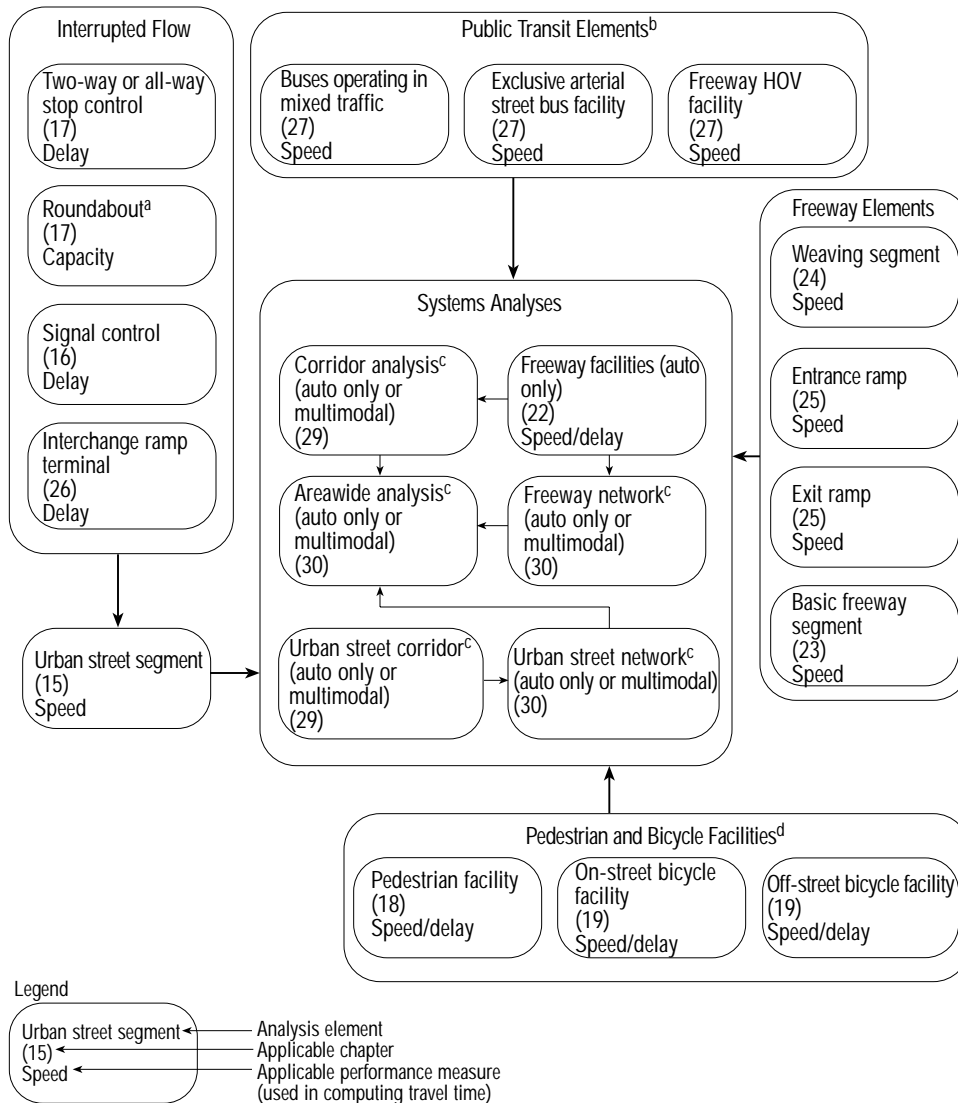

An example of how to aggregate individual elements of urban systems to perform a system analysis

Notes:

- a. Current HCM methods do not provide models for estimating delay at roundabouts. The user may employ other models to complete the analysis.
- b. Public transit elements can be analyzed as a separate system, using a variety of performance measures provided in Chapter 27, or as part of a larger system using travel speed as the common performance measure.
- c. The chapters on corridor and areawide analysis do not specify a specific MOE for defining LOS. Instead, performance measures are defined for five dimensions: quantity of service produced by the system; intensity of congestion; extent of congestion; variability of the measures; and accessibility.
- d. Pedestrian and bicycle elements can be analyzed as a separate system, using the performance measures provided in Chapters 18 and 19, or as part of a larger system using travel speed as the common performance measure.

Exhibit 3-3 is a schematic of a typical urban network. The interrupted-flow elements along an arterial are included when determining LOS for urban street segments; for example, analysis of urban street Segment L will include the results from analysis of Intersections H, I, J, and K. These may be further combined for an arterial corridor analysis (designated as 2 in the exhibit). Similarly, the freeway facility (designated by 1) is a combination of the individual elements within it. A freeway corridor analysis combines the freeway with one or more parallel arterials. An area analysis (designated by 3) further accumulates the values for the appropriate performance measures from preceding stages. System analyses can consider only one mode or user type or combine several modes or user types.

EXHIBIT 3-3. COMPONENTS OF HCM ANALYSIS OF URBAN SYSTEMS

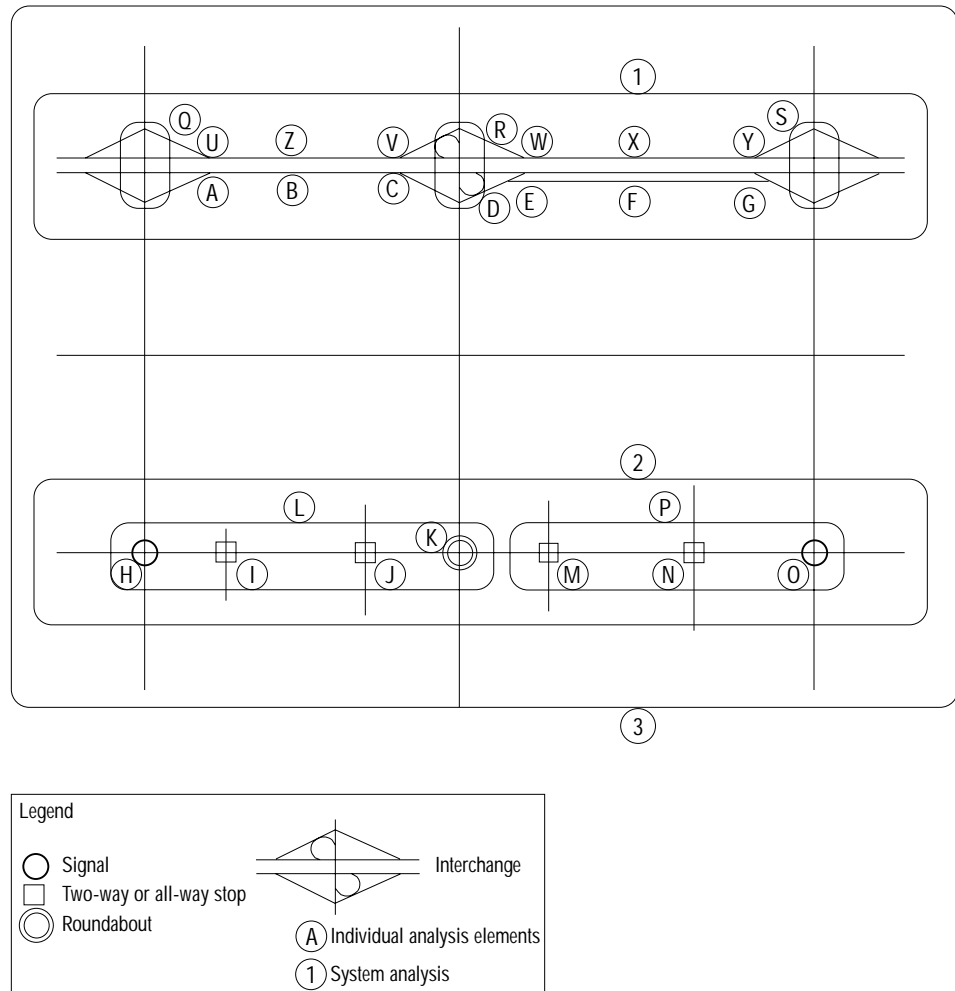

Looking at Exhibit 3-1, the right portion identifies the performance measures used to compute travel time and to analyze the constituent elements of the system in Exhibit 3-3. Exhibit 3-2 lists the chapters in HCM Parts III and IV that include guidelines and methods for combining performance measures.

RANGE OF OPERATIONAL CONDITIONS COVERED

The HCM can be used to analyze a wide range of operational conditions. The methodologies can determine the performance and LOS for undersaturated conditions and, in some cases, for oversaturated conditions. There are two primary ways of dealing with oversaturation: one is to conduct analyses over successive 15-min periods of congestion; the other is to account for queue interference when downstream conditions cause queue buildup to affect upstream elements.

The analyst can work with individual 15-min periods, or hourly periods for which peak-hour factors are established. This flexibility expedites analyses over several hours of the day, allowing the analyst to consider both peak and off-peak conditions, as well as 24-h totals.

III. ANALYSIS OBJECTIVES

HCM analyses produce information for decision making. Users of the manual generally are trying to achieve one of three objectives: identify problems, select countermeasures (a priori evaluation), or evaluate previous actions (post hoc).

Problems usually are identified when performance measures for a network or a facility—or a portion of one—do not meet established standards. For example, when the service on a facility falls below LOS D, the resultant queuing might interfere with operation upstream. Although the HCM is well suited for predicting performance measures, an analyst studying current conditions should make direct field measurements of the performance attributes. These direct measurements then can be applied in the same manner as predicted values to determine LOS. The HCM, however, is particularly useful when a current situation is being studied in the context of future conditions, or when an entirely new element of the system is being considered for implementation.

Once a problem is identified in measurable terms, the analyst can establish the likely underlying causes and countermeasures, with the goal of making operational improvements. For example, an analyst might identify a problem with pedestrian queuing at an intersection. Review of the physical conditions leads to several alternative countermeasures, including removal of sidewalk furniture or expanding the sidewalk area. These countermeasures can be tested for any attribute of the facility that is reflected in the HCM models. For example, an analyst can compare alternatives for intersection control, certain geometric design improvements, or improvements in traffic signal timing.

Historically, there is little evidence that the HCM has been used to evaluate the effectiveness of actions once they have been implemented, but it can be useful for this. However, it is imperative to make direct field measurements of the appropriate performance measures while working within the general framework of the HCM process.

LEVELS OF ANALYSIS

The levels of analyses commonly performed by users of the HCM can be grouped into three categories: operational, design, and planning.

Operational analyses are applications of the HCM generally oriented toward current or anticipated conditions. They aim at providing information for decisions on whether there is a need for minor, typically low-cost, improvements that can be implemented quickly. Occasionally, an analysis is made to determine if a more extensive planning study is needed. Sometimes the focus is on a network, or a part of one, that is approaching oversaturation or an undesirable LOS: When, in the near term, is the facility likely to fail? Answering this question requires an estimate of the service flow rate allowable under a specified LOS.

HCM analyses also help in making decisions about operating conditions. Typical alternatives often involve the following: lane-use configurations, application of traffic control devices, signal timing and phasing, spacing and location of bus stops, frequency of bus service, and addition of an HOV lane or a bicycle lane. The analysis produces operational measures for a comparison of the alternatives.

Because of the immediate, short-term focus of operational analyses, it is possible to provide detailed inputs to the models. Many of the inputs may be based on field measurements of traffic, physical features, and control devices. Generally, the use of default values is inappropriate at this level of analysis.

Design analyses apply the HCM primarily to establish the detailed physical features that will allow a new or modified facility to operate at a desired LOS. Design projects usually are targeted for mid- to long-term implementation. Not all the physical features that a designer must determine are reflected in the HCM models. Typically, analysts using the HCM are seeking to determine such elements as the basic number of lanes required and the need for auxiliary or turning lanes. However, an analyst also can use the HCM to establish values for elements such as lane width, steepness of grade, the length

Why an analyst might want to use the HCM

Operational, design, and planning analyses

of added lanes, the size of pedestrian queuing areas, sidewalk and walkway widths, and the dimensions of bus turnouts.

The data required for design analyses are fairly detailed and are based substantially on proposed design attributes. However, the intermediate- to long-term focus of the work will require use of some default values. This simplification is justified in part by the limits on the accuracy and precision of the traffic predictions with which the analyst will be working.

Planning analyses are applications of the HCM generally directed toward strategic issues; the time frame usually is long-term. Typical studies address the possible configuration of a highway system (or portion of one); a set of bus routes; the expected effectiveness of a new rail service; or the likely impact of a proposed development. An analyst often must estimate the future times at which the operation of the current and committed systems will fall below the desired LOS. Planning studies also can assess proposed systemic policies, such as lane-use control for heavy vehicles, application of systemwide freeway ramp metering, and the use of demand-management techniques, such as congestion pricing.

Exhibit 3-4 demonstrates the general relationship between the levels of analysis and their objectives. Each of the methodological chapters (Part III of the HCM) has one basic method adapted to facilitate each of the levels of analysis. Planning analyses generally are simplified by using more default values than analyses of design and operations.

EXHIBIT 3-4. LEVELS AND OBJECTIVES OF TYPICAL HCM ANALYSES

Level of Analysis	Analysis Objective		
	Problem Identification	Countermeasure Selection (A Priori)	Evaluation (Post Hoc)
Operational	Primary	Primary	Primary
Design	Not applicable	Primary	Secondary
Planning	Secondary	Primary	Not applicable

HCM ANALYSES AS PART OF A BROADER PROCESS

Since its first edition in 1950, the HCM has provided transportation analysts with the analytical tools to estimate traffic operational measures such as speed, density, and delay. It also has provided insights and specific tools for estimating the effects of various traffic, roadway, and other conditions on the capacity of facilities. In the past 10 to 15 years, the calculated values from the HCM increasingly have been used in other transportation work, such as project analysis both in terms of the environment and in terms of user costs and benefits. This practice of using estimated or calculated values from HCM work as the foundation for estimating user costs and benefits in terms of economic value, environmental changes (especially air and noise), and even implications on safety, is particularly pronounced in transportation priority programs and in the justification of projects. A good description of what non-HCM users do with HCM-produced material is found in a handbook, *Environmental and Energy Considerations* (1, p. 447):

The environmental analyst is required carefully and objectively to examine project data provided by transportation planners and designers, review existing environment laws and regulations which may affect the project, make appropriate calculations of impact, compare impact values against acceptable criteria, and recommend mitigation where needed.

In a similar manner, the economic analysis of transportation improvements depends heavily on information generated directly through use of the HCM. From an authoritative source of traditional road user benefit and cost analysis, the following excerpt indicates the degree to which such analyses depend on the HCM:

Environmental impact analysis

Many of the highway user cost factors in this manual are shown as a function of either traffic speed or of the ratio of traffic volume to highway capacity (v/c ratio). The key highway design and traffic characteristics that define capacity and traffic speed can be translated into these parameters through the use of such documents as the Highway Capacity Manual (2, p. 1).

This indicates the strong link between economic analysis and HCM results.

A paper in *Transportation Quarterly* identifies the need for measures of performance that take into account person movement through a system or area (3). The paper suggests that by taking both accessibility and mobility into account, an areawide measure of service level can be developed. Also, many environmental analyses (e.g., of ozone formation) and economic analyses (e.g., of vehicle kilometers of travel or system hours of travel) can be conducted only from a systemwide or areawide perspective.

The three performance measures that play key roles in programs related to the Clean Air Act Amendments of 1990 and in related air quality monitoring are vehicle kilometers of travel, vehicle trips, and average travel speeds. These measures also are applicable to assessments of air quality (1). This manual provides a measure of average travel speeds for many facility types, but in some cases uses another measure (such as density) to describe LOS. The Intermodal Surface Transportation Efficiency Act regulations of 1991 specify that the movement of people and not just vehicles should be measured in the ongoing monitoring programs. Part IV of this manual addresses person movement in the context of corridor and areawide analyses.

The economic analysis of highway improvements is an important decision-making tool. A recent analysis of a highway widening project (4) referred to the HCM (1985 edition), using average running speed along the highway in question as the important variable in the model. In addition to running speed and delay, the model's major component was the change in number of accidents from before to after the highway improvement. It is noteworthy that some 95 percent of the benefits ascribed to the project came from delay savings and from reductions in vehicle operating costs—both measures calculated with the foundation of HCM speed data.

In summary, almost all economic analyses and all air and noise environmental analyses have relied directly on one or more measures estimated or produced with HCM calculations. Exhibit 3-5 lists the performance measures from this manual that are applicable to environmental or economic analyses.

Economic analysis

IV. REFERENCES

1. *Environmental and Energy Considerations*. Transportation Engineering Handbook, Institute of Transportation Engineers, Washington, D.C., 1991.
2. *A Manual of User Benefit Analysis of Highway and Bus Transit Improvements*. American Association of State Highway and Transportation Officials, Washington, D.C., 1977.
3. Ewing, R. Measuring Transportation Performance. *Transportation Quarterly*, Winter, 1995, pp. 91–104.
4. Wildenthal, M. T., J. L. Buffington, and J. L. Memmott. Application of a User Cost Model To Measure During and After Construction Costs and Benefits: Highway Widening Projects. In *Transportation Research Record 1450*, TRB, National Research Council, Washington, D.C., 1995, pp. 38–43.

EXHIBIT 3-5. HCM PERFORMANCE MEASURES FOR ENVIRONMENTAL AND ECONOMIC ANALYSES

	Chapter	Performance Measure (*Service Measure)	Appropriate for Use		
			Air	Noise	Economic
15	Urban Streets	Travel speed*	√	√	√
		Running time	√		√
		Intersection control delay	√		√
16	Signalized Intersections	Control delay*	√		√
		v/c ratio	√		√
17	Unsignalized Intersections	Control delay*	√		√
		Queue length	√	√	√
		v/c ratio	√		√
18	Pedestrians	Space*			
		Pedestrian delay*			
		Speed			√
		v/c ratio			√
19	Bicycles	Hindrance*			
		Events			
		Control delay*			√
		Travel speed*			√
20	Two-Lane Highways	Percent time-spent-following*			
		Speed*	√	√	√
21	Multilane Highways	Density*			
		Speed	√	√	√
		v/c ratio	√		√
22	Freeway Facilities	Density			
		Veh-h delay			√
		Speed	√	√	√
		Travel time			√
23	Basic Freeway Segments	Density*			
		Speed	√	√	√
		v/c ratio	√		√
24	Freeway Weaving	Density*			
		Weaving speed	√	√	√
		Nonweaving speed	√	√	√
25	Ramps and Ramp Junctions	Density*			
		Speed	√	√	√
26	Interchange Ramp Terminals	Control delay*	√		√
27	Transit	Service frequency*	√	√	√
		Hours of service*	√	√	√
		Passenger loading*	√	√	√
		Reliability*	√	√	√

CHAPTER 4

DECISION MAKING

CONTENTS

I. INTRODUCTION4-1

II. DECISION MAKING4-1

 Types of Decisions to Which the HCM Applies4-1

 Operational4-1

 Design4-2

 Planning4-2

 Roles of Performance, Effectiveness, and Service Measures and LOS4-2

III. PRESENTING RESULTS TO FACILITATE INTERPRETATION4-3

 Selecting Appropriate Measures4-3

 Understanding Sensitivity of Measures4-4

 Graphic Representation of Results4-4

IV. REFERENCES4-6

EXHIBITS

Exhibit 4-1. Example of a Graphic Display of LOS4-4

Exhibit 4-2. Example of a Thematic Graphic Display of LOS4-5

Exhibit 4-3. Example of a Cost-Effectiveness Graph4-5

I. INTRODUCTION

This chapter explains how to use the results of the *Highway Capacity Manual* (HCM) analyses in making decisions for planning, designing, and operating transportation facilities. It begins with the types of decisions to which the HCM usually is applied; discusses the role of measures of effectiveness (MOEs), level of service (LOS), and other performance measures; and concludes with some guidelines and examples on the presentation of results to facilitate interpretation.

II. DECISION MAKING

TYPES OF DECISIONS TO WHICH THE HCM APPLIES

Chapter 3 has described the analysis levels of operational, design, and planning. This section now turns to the types of decisions frequently associated with each of these levels. Combining service measures with performance measures allows the user to match the evaluation process to the problem at hand. However, decisions related to safety cannot be made effectively using the methodologies and performance measures in the HCM.

Operational

Operational analyses generally identify the existence and nature of a problem. Therefore, in making any decision, an analyst first considers whether a given element, facility, area, or system has a potential problem requiring study. In this case, the analyst simply decides if there is or will be a problem. This is what highway needs studies do. The prediction models of the HCM can be used even if the performance cannot be directly measured in the field. The analyst often uses the HCM as a framework to document a problem about which the agency has been alerted by the public or by other agencies.

However, operational analyses often do not end with the confirmation of a problem. They usually also entail a decision on how the problem might be remedied (i.e., through countermeasures). Typically, several alternatives for improvement are proposed, leading to the next decision. One alternative must be selected as the recommended plan. The HCM can be used to predict the change in performance measures for each alternative, to help in selecting and recommending a plan.

Decisions that use results from the HCM include choosing among alternatives for intersection controls, for signal phasing and timing arrangements, and for minor changes to control and marking (e.g., location of parking and bus stops, reconfiguring the number and the use of lanes, frequency of bus service, and relocating or eliminating street furniture for pedestrians), as well as choosing among a combination of actions.

There also may be a need to decide on the feasibility of a proposed operational improvement. The addition of exclusive turning lanes or the extension of existing turning lanes can be considered at intersections. Another example is that a bicycle lane or a high-occupancy vehicle lane might be recommended for placement within the current right-of-way of an urban street. HCM analyses can determine if the space lost to other modes of travel (i.e., pedestrians and other vehicles) will result in an unacceptably low LOS, making the alternative unfeasible.

HCM methods are used to estimate performance measures for assessing alternative actions. Combined with other factors as desired, these then can assist decision makers in comparing alternatives and choosing the most appropriate course.

Examples of decisions for which the HCM can be used

Design

Design determinations for which the HCM is used most commonly involve decisions on the number of lanes, or the amount of space, needed to operate a facility at a desired LOS. For example, if a basic freeway segment is to be designed for an LOS with a service flow rate of 2,000 passenger cars per hour per lane (pc/h/ln) and the demand flow rate is 4,500 pc/h, the number of lanes required is calculated as 2.25 (from 4,500/2,000). Based on this information only, the analyst might choose to design the segment with three lanes. However, the segment may be one of several alternative designs under consideration. Others might have better geometrics, closer to base conditions, and might result in a higher service flow rate, indicating a need for only two lanes.

This is the simplest form of design determination found in the HCM. The relationship between service flow rate and geometrics and controls is much more complex for other facility types covered—computing the number of lanes required is not a simple matter. The HCM can be used to select among alternative designs either by comparing the LOS at which each alternative would operate or by finding the attributes of the design that result in a targeted LOS.

Planning

Problem identification

HCM analyses are useful for such planning decisions as determining the need to improve a system (e.g., a highway network). This kind of analysis is similar to an operational analysis, except that it requires less detail for the inputs and uses a greater number of default values. The decision not only involves whether improvements are needed, but if so, what type and where. This is determined by testing a series of alternatives and comparing their performance measures. The measures produced by the HCM methodologies either will play a role as criteria for decision making, or they will act as interim inputs to a planning model that will generate its own performance measures. Ultimately, the HCM methods produce results that support decision making.

Alternative analyses and design determination

Planning decisions involving the HCM often relate to the feasibility of a new commercial or residential development. For example, if a shopping center is proposed for a location, the HCM analyses can be used to decide if the traffic generated by the development would result in an undesirable quality of service. This decision involves the determination of service measures, LOS, and other appropriate performance measures (e.g., v/c ratio and queue lengths). If the development is found unfeasible as proposed, due to an unacceptable impact on street or intersection operation, the HCM also can be used to assess alternative improvements to make it feasible. In this way, the HCM can be used in deciding what should be required of a new commercial or residential development as well as cost-sharing for any public improvements in conjunction with the development. For example, the developer might be required to change the location, number, or geometrics of access points based on tests made using the HCM.

Planning decisions

Planning analyses also can be performed to decide on the feasibility of a proposed policy. For example, if a city is considering a policy to provide special lanes for bicycles or high-occupancy vehicles, scenarios can be tested to allow decision makers to arrive at the most appropriate requirements for the policy.

ROLES OF PERFORMANCE, EFFECTIVENESS, AND SERVICE MEASURES AND LOS

As described in Chapter 2, operations on each facility type or element of the overall transportation system can be characterized by a set of performance measures, both qualitative and quantitative. Quantitative measures estimated using the analytical methods of this manual are termed measures of effectiveness (MOEs). For each facility type, a single MOE has been identified as the service measure that defines the operating LOS for the specific facility. (More than one MOE is used in the LOS determination for transit facilities and for two-lane highways).

Analysis and decision making using the HCM methods almost always involves estimating or determining a service measure and the related LOS. Parts III and IV provide methods for generating performance measures in addition to the specific service measure; these can be useful inputs in decision making. In some cases, performance measures can be more important to the decision than the LOS rating. An example is the length of queue caused by oversaturation. If the analysis predicts a problem due to a queue backup into an upstream intersection, the next steps are to generate and select alternatives to resolve the problem. Another example is the volume/capacity (v/c) ratio for signalized intersections. Although delay is used to establish the LOS, the v/c ratio sometimes can indicate potential problems, even when the LOS is acceptable.

Each of the methodological chapters provides a different set of performance measures, summarized in Chapter 9. Users of this manual should become familiar with the performance measures that can be estimated using the HCM, and with how the performance measures can enhance decision making.

III. PRESENTING RESULTS TO FACILITATE INTERPRETATION

SELECTING APPROPRIATE MEASURES

Several performance measures can result from HCM analyses. Determining the most appropriate measures to use for a decision depends on the particular case. However, decision-making situations generally can be divided into those involving the public (e.g., city councils or community groups) and those involving technicians (e.g., state or local engineering staff or transit planners).

The HCM is highly technical and complex. The results of the analyses can be difficult for people to interpret for decision making, unless the data are carefully organized and presented. In general, the results should be presented as simply as possible. This might include using a small set of performance measures and providing the data in an aggregate form, without losing the ability to relate to the underlying variations and factors that have generated the results.

The LOS concept was created, in part, to make the presentation of results easier to understand than if the numerical values of the MOEs and service measures were reported directly. It is easier to understand a grading scale similar to that of the traditional school report card than to deal with measures such as density and v/c ratio. Although there are limitations to their usefulness, LOS ratings remain a part of the HCM because of their acceptance by the public and elected officials. Decision makers who are not analytically oriented often prefer to have a single number or letter represent a condition. It is generally not effective to provide representatives of the public with a large set of differing measures or with a frequency distribution for a specific performance measure. If the analyst has several measures available, it is preferable to select the one that best fits the situation and keep the others in reserve until needed.

Decision makers who represent the public usually prefer measures that their constituents can understand; the public can relate to LOS grades. Unit delay (e.g., seconds per vehicle) and travel speed also are readily understood. However, v/c, density, percent time spent following, and vehicle hours of travel are not measures to which the public easily relates. When selecting the measures to present, therefore, it is important for the analyst to recognize the orientation of the decision maker and the context in which the decision will be made. In general, these measures can be differentiated as system-user or system-manager oriented. When making a presentation to technical members of a public agency, such as highway engineers and planners, it might be necessary to use more

LOS is only one of several ways to evaluate operational conditions

Performance measures selected should be related to the problem being addressed

Evaluate how results change with input assumptions

Present results to make them very plain (obvious) to the audience

than one performance measure, especially when providing both the system-user and system-manager perspectives.

UNDERSTANDING SENSITIVITY OF MEASURES

Once one or more performance measures have been selected for reporting analysis results, decision making can be improved by demonstrating how the numerical values (or the LOS letter grade) change when one or more of the assumed input values change. It can be important for the decision maker to know how an assumed increase of 15 percent in future traffic volume (compared with the standard forecast volume) will affect delay and LOS at a signalized intersection. By providing a central value along with values based on upward and downward assumptions on key input variables (especially volume), the analyst ensures that decision making is based on a full understanding of sensitivities. The *Traffic Engineering Handbook (1)* provides examples of tabular presentations of sensitivity results for signalized intersections.

GRAPHIC REPRESENTATION OF RESULTS

Historically, data and analysis results have been presented primarily in tables. However, results sometimes are best presented as pictures and only supplemented as necessary with the underlying numbers. Graphs and charts should not be used to decorate data or to make dull data entertaining; they should be conceived and fashioned to aid in the interpretation of the meaning behind the numbers (2).

Most of the performance measures in the HCM are quantitative, continuous, variables. LOS grades, however, are qualitative measures of performance; they do not lend themselves to graphing. When placed on a scale, LOS grades must be given an equivalent numeric value, as shown in Exhibit 4-1, which presents the LOS for a group of intersections. The letter grade is indicated, and shaded areas are defined as unacceptable LOS that do not meet the objective of LOS D. The size of the indicator at each intersection is intended to show the relative delay values for the indicated LOS.

EXHIBIT 4-1. EXAMPLE OF A GRAPHIC DISPLAY OF LOS

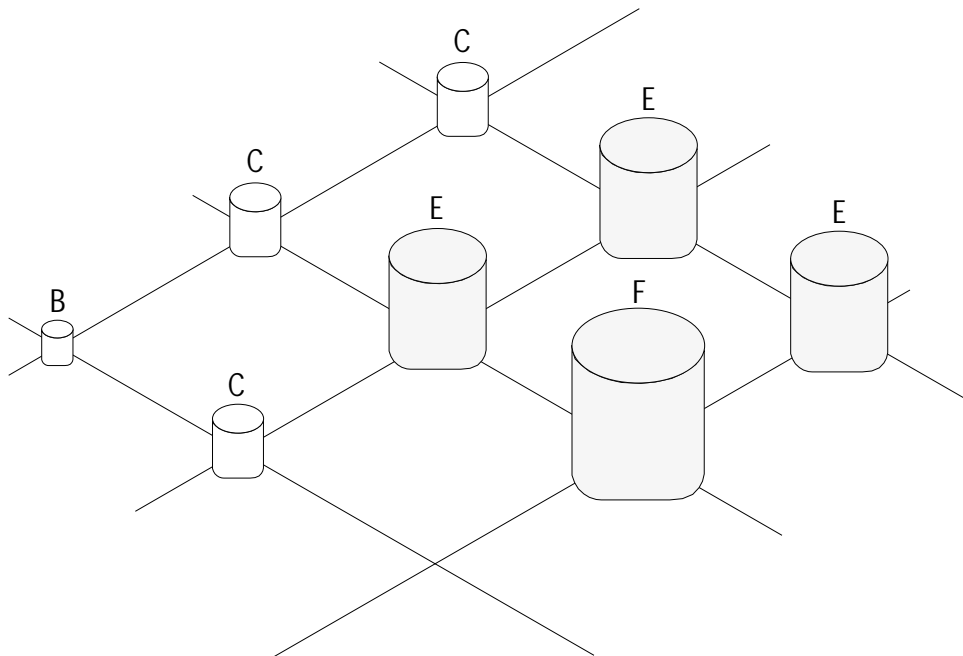

The issue is whether the change in value between successive grades of LOS (i.e., the interval) should all be shown as equal. For instance, is it appropriate for the LOS Grades A through F to be converted to a scale of 0 through 5? Should the numerical equivalent assigned to the difference of the thresholds between LOS A and B be the same as the difference between LOS E and F? These questions have not been addressed in the research. Furthermore, LOS F is not given an upper bound. Therefore, a graph of LOS should be considered ordinal, not interval, because the numeric differences between levels of service would not appear significant.

However, it is difficult to refrain from comparing the differences. A scale representing the relative values of the LOS grades would have to incorporate the judgment of the analyst and the opinions of the public or of decision makers—a difficult task. A thematic style of graphic presentation, however, avoids this issue. In Exhibit 4-2, for example, shading is used to highlight time periods and basic freeway segments that do not meet the objective LOS (in this case, D).

EXHIBIT 4-2. EXAMPLE OF A THEMATIC GRAPHIC DISPLAY OF LOS

Start Time	Segment I	Segment II	Segment III	Segment IV
5:00 p.m.	A	B	B	A
5:15 p.m.	B	B	D	A
5:30 p.m.	B	B	F	A
5:45 p.m.	B	D	F	A
6:00 p.m.	B	F	F	A
6:15 p.m.	D	F	E	A
6:30 p.m.	D	E	C	A
6:45 p.m.	B	B	B	A

Simple graphics often can facilitate decision making among available alternatives. For example, in the cost-effectiveness graph shown in Exhibit 4-3, the estimated delays resulting from alternative treatments have been plotted against their associated cost. The graph shows more clearly than a tabulation of the numbers that Alternative III both is more costly and creates higher delay than Alternative II. This eliminates Alternative III.

EXHIBIT 4-3. EXAMPLE OF A COST-EFFECTIVENESS GRAPH

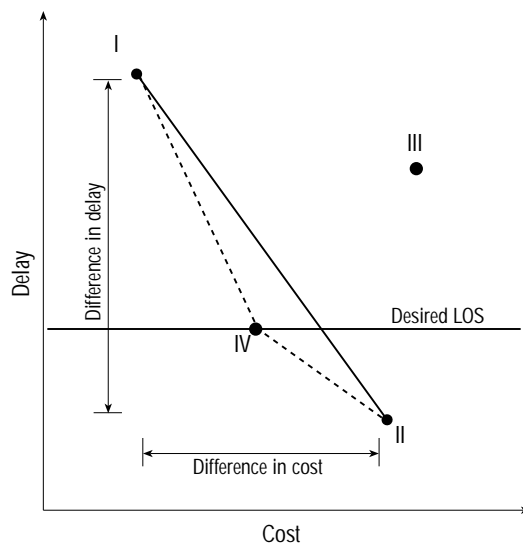

Whether Alternative I or II should be chosen, however, is a matter for the decision maker's judgment. Alternative II is more expensive than Alternative I, but is predicted to deliver a significantly lower delay. A useful measure for decision makers is provided by the slope of the line between the alternatives, which shows the seconds of delay saved per dollar of cost.

For this example, assume that Alternative IV provides the minimum acceptable LOS at significantly less cost than Alternative III. The dashed lines in Exhibit 4-3 indicate the relative cost-effectiveness of moving from I to IV or IV to II. The steepest slope, I to IV, signifies a high level of cost-effectiveness. The two alternatives that meet or exceed the LOS objective are II and IV. The most appropriate alternative for selection, therefore, is Alternative IV.

The HCM provides valuable assistance in making transport management decisions in a wide range of situations. It offers the user a selection of performance measures to meet a variety of needs. The analyst should recognize that using the HCM involves a bit of art along with the science. Sound judgment is needed not only for interpreting the values produced, but also in summarizing and presenting the results.

IV. REFERENCES

1. *Traffic Engineering Handbook*. Institute of Transportation Engineering, Washington, D.C., 1992.
2. Tufte, E. R. *The Visual Display of Quantitative Information*. Graphics Press, Cheshire, Connecticut, 1983.

CHAPTER 5

GLOSSARY

This chapter defines the terms used in the manual.

- Acceleration lane** - A paved auxiliary lane, including tapered areas, allowing vehicles to accelerate when entering the through-traffic lane of the roadway.
- Access point** - An intersection, driveway, or opening on the right-hand side of a roadway. An entry on the opposite side of a roadway or a median opening also can be considered as an access point if it is expected to influence traffic flow significantly in the direction of interest.
- Access-point density** - The total number of access points on a roadway divided by the length of the roadway and then averaged over a minimum length of 5 km.
- Accuracy** - The degree of a measure's conformity to a standard or true value.
- Adjustment** - An additive or subtractive quantity that adjusts a parameter for a base condition to represent a prevailing condition.
- Adjustment factor** - A multiplicative factor that adjusts a parameter for a base condition to represent a prevailing condition.
- Aggregate delay** - The summation of delays for multiple lane groups, usually aggregated for an approach, an intersection, or an arterial route.
- Alighting time** - The time required for a passenger to leave a transit vehicle, expressed as time per passenger or total time for all passengers.
- All-way stop-controlled** - An intersection with stop signs at all approaches. The driver's decision to proceed is based on the rules of the road (e.g., the driver on the right has the right-of-way) and also on the traffic conditions of the other approaches.
- Analysis period** - A single time period during which a capacity analysis is performed on a transportation facility. If the demand exceeds capacity during an analysis period, consecutive analysis periods can be selected to account for initial queue from the previous analysis period. Also referred to as time interval.
- Analytical model** - A model that relates system components using theoretical considerations tempered, validated, and calibrated by field data.
- Angle loading area** - A bus bay design, similar to an angled parking space, requiring buses to back up to exit and allowing more buses to stop in the given linear space. Typically used when buses must occupy berths for a long period of time (e.g., at an intercity bus terminal).
- Annual average daily traffic** - The total volume of traffic passing a point or segment of a highway facility in both directions for one year divided by the number of days in the year.
- Approach** - A set of lanes at an intersection that accommodates all left-turn, through, and right-turn movements from a given direction.
- Approach grade** - The grade of an intersection approach, expressed as a percentage, with positive values for upgrade and negative for downgrade.
- Area type** - A geographic parameter reflecting the variation of saturation flows in different areas.
- Arrival rate** - The mean of the statistical distribution of vehicles arriving at a point or uniform segment of a lane or roadway.
- Arrival type** - Six assigned categories for determining the quality of progression at a signalized intersection.
- Arterial** - A signalized street that primarily serves through-traffic and that secondarily provides access to abutting properties, with signal spacings of 3.0 km or less.
- Articulated bus or articulated trolleybus** - An extralong, high-capacity bus or trolleybus with a rear body section or sections flexibly but permanently connected to the forward section. The vehicle can bend for curves but does not require an interior barrier between its sections.

Acceleration lane—Articulated bus or articulated trolleybus

- Auxiliary lane** - An additional lane on a freeway to connect an on-ramp and an off-ramp.
- Average travel speed** - The length of the highway segment divided by the average travel time of all vehicles traversing the segment, including all stopped delay times.
- Back of queue** - The distance between the stop line of a signalized intersection and the farthest reach of an upstream queue, expressed as a number of vehicles. The vehicles previously stopped at the front of the queue are counted even if they begin moving.
- Base condition** - The best possible characteristic in terms of capacity for a given type of transportation facility; that is, further improvements would not increase capacity; a condition without hindrances or delays.
- Base saturation flow rate** - The maximum steady flow rate—expressed in passenger cars per hour per lane—at which previously stopped passenger cars can cross the stop line of a signalized intersection under base conditions, assuming that the green signal is available and no lost times are experienced.
- Basic freeway segment** - A length of freeway facility whose operations are unaffected by weaving, diverging, or merging.
- Berth** - A position for a bus to pick up and discharge passengers, including curb bus stops and other types of boarding and discharge facilities.
- Bicycle** - A vehicle with two wheels tandem, propelled by human power, and usually ridden by one person.
- Bicycle facility** - A road, path, or way specifically designated for bicycle travel, whether exclusively or with other vehicles or pedestrians.
- Bicycle lane** - A portion of a roadway designated by striping, signing, and pavement markings for the preferential or exclusive use of bicycles.
- Bicycle path** - A bikeway physically separated from motorized traffic by an open space or barrier, either within the highway right-of-way or within an independent right-of-way.
- Bicycle speed** - The riding speed of bicycles, in kilometers per hour or meters per second.
- Boarding time** - The time for a passenger to board a transit vehicle, expressed as time per passenger or total time for all passengers.
- Body ellipse** - The space provided per pedestrian on a pedestrian facility, expressed as square meters per pedestrian.
- Bottleneck** - A road element on which demand exceeds capacity.
- Breakdown** - The onset of a queue development on a freeway facility.
- Breakdown flow** - Also called forced flow, occurs either when vehicles arrive at a rate greater than the rate at which they are discharged or when the forecast demand exceeds the computed capacity of a planned facility.
- Bus** - A self-propelled, rubber-tired road vehicle designed to carry a substantial number of passengers (at least 16) and commonly operated on streets and highways.
- Bus lane** - A highway or street lane reserved primarily for buses during specified periods. It may be used by other traffic under certain circumstances, such as making a right or left turn, or by taxis, motorcycles, or carpools that meet the requirements of the jurisdiction's traffic laws.
- Bus platoon** - A convoy of several buses, with each bus following the operating characteristics of the one in front.
- Bus stop** - An area in which one or more buses load and unload passengers. It consists of one or more loading areas and may be on line or off line.
- Busway** - A right-of-way restricted to buses by a physical separation from other traffic lanes.
- Calibration** - The process of comparing model parameters with real-world data to ensure that the model realistically represents the traffic environment. The objective is to minimize the discrepancy between model results and measurements or observations.
- Capacity** - The maximum sustainable flow rate at which vehicles or persons reasonably can be expected to traverse a point or uniform segment of a lane or roadway during a specified time period under given roadway, geometric, traffic, environmental, and

control conditions; usually expressed as vehicles per hour, passenger cars per hour, or persons per hour.

- Captive riders** - Transit riders, such as people with disabilities, the elderly, young adolescents, and adults without driver's licenses, who do not have alternative means of travel.
- Change interval** - The yellow plus all-red interval that occurs between phases of a traffic signal to provide for clearance of the intersection before conflicting movements are released.
- Circulating flow** - The volume of traffic on the principal roadway of a roundabout at a given time.
- Circulating roadway** - The continuous-flow section of a roundabout that requires other vehicles entering the roadway to yield.
- Circulation area** - The portion of a sidewalk street corner used by moving pedestrians passing through the area; in square meters.
- Clearance lost time** - The time, in seconds, between signal phases during which an intersection is not used by any traffic.
- Clearance time** - The time loss at a transit stop, not including passenger dwell times. This parameter can be the minimum time between one transit vehicle leaving a stop and the following vehicle entering and can include any delay waiting for a sufficient gap in traffic to allow the transit vehicle to reenter the travel lane.
- Climbing lane** - A passing lane added on an upgrade to allow traffic to pass heavy vehicles whose speeds are reduced.
- Collector street** - A surface street providing land access and traffic circulation within residential, commercial, and industrial areas.
- Commuter rail** - The portion of passenger railroad operations that carries passengers within urban areas, or between urban areas and their suburbs; unlike rapid rail transit, the passenger cars generally are heavier, the average trip lengths are usually longer, and the operations are carried out over tracks that are part of the area's railroad system.
- Composite grade** - A series of adjacent grades along a highway that cumulatively has a more severe effect on operations than each grade separately.
- Compound left-turn protection** - A signal phasing scheme that provides both a protected and permitted phase in each cycle for a left turn. See also *protected plus permitted* and *permitted plus protected*.
- Conflicting approach** - The approach opposite the subject approach at an all-way stop-controlled intersection.
- Conflicting flow rate** - The flow rate of traffic that conflicts with a specific movement at an unsignalized intersection.
- Conflicting movements** - The traffic streams in conflict at an unsignalized intersection.
- Congested flow** - A traffic flow condition caused by a downstream bottleneck.
- Constrained operation** - An operating condition in a weaving segment, involving geometric and traffic constraints, that prevents weaving vehicles from occupying a large portion of the lanes available to achieve balanced operation.
- Control condition** - The traffic controls and regulations in effect for a segment of street or highway, including the type, phasing, and timing of traffic signals; stop signs; lane use and turn controls; and similar measures.
- Control delay** - The component of delay that results when a control signal causes a lane group to reduce speed or to stop; it is measured by comparison with the uncontrolled condition.
- Corridor** - A set of essentially parallel transportation facilities designed for travel between two points. A corridor contains several subsystems, such as freeways, rural (or two-lane) highways, arterials, transit, and pedestrian and bicycle facilities.
- Coverage** - The geographical area that a transit system serves, normally based on acceptable walking distances from loading points.

Captive riders—Coverage

Crawl speed—Design speed

- Crawl speed** - The maximum sustained speed that can be maintained by a specified type of vehicle on a constant upgrade of a given percent; in kilometers per hour.
- Critical density** - The density at which capacity occurs for a given facility, usually expressed as vehicles per kilometer per lane.
- Critical gap** - The minimum time, in seconds, between successive major-stream vehicles, in which a minor-street vehicle can make a maneuver. Also see *Pedestrian critical gap*.
- Critical lane group** - The lane groups that have the highest flow ratio for a given signal phase.
- Critical speed** - The speed at which capacity occurs for a facility, usually expressed as kilometers per hour.
- Critical volume-to-capacity ratio** - The proportion of available intersection capacity used by vehicles in critical lane groups.
- Cross flow** - A pedestrian flow that is approximately perpendicular to and crosses another pedestrian stream. The smaller of the two flows is the cross-flow condition.
- Crosswalk** - A marked area for pedestrians crossing the street at an intersection or designated midblock location.
- Crown line** - A lane marking that connects from the entrance gore area directly to the exit gore area.
- Crush load** - The maximum number of passengers that can be accommodated on a transit vehicle.
- Cycle** - A complete sequence of signal indications.
- Cycle length** - The total time for a signal to complete one cycle.
- Deceleration lane** - A paved auxiliary lane, including tapered areas, allowing vehicles leaving the through-traffic lane of the roadway to decelerate.
- Default value** - A representative value that may be appropriate in the absence of local data.
- Delay** - The additional travel time experienced by a driver, passenger, or pedestrian.
- Demand** - The number of users desiring service on the highway system, usually expressed as vehicles per hour or passenger cars per hour.
- Demand-responsive service** - Passenger cars, vans, or buses with fewer than 25 seats, dispatched by a transit operator in response to calls from passengers or their agents.
- Demand starvation** - A condition when portions of the green time at a downstream intersection cannot be used because conditions at an upstream intersection prevent vehicles from reaching the stop line downstream at an interchange ramp terminal.
- Demand to capacity ratio** - The ratio of demand flow rate to capacity for a traffic facility.
- Density** - The number of vehicles on a roadway segment averaged over space, usually expressed as vehicles per kilometer or vehicles per kilometer per lane. Also see *Pedestrian density*.
- Departure headway** - The average headway in seconds between two consecutive vehicles departing from a lane at an all-way stop-controlled intersection.
- Descriptive model** - A mathematical model that applies concepts or theoretical principles to represent the behavior of a system.
- Design application** - Using capacity analysis procedures to determine the size (number of lanes) required for a specified level of service.
- Design category** - A type of urban street defined by geometric features and roadside environment.
- Design hour** - An hour with a traffic volume that represents a reasonable value for designing the geometric and control elements of a facility.
- Design-hour factor (K-factor)** - The proportion of the 24-h volume that occurs during the design hour.
- Design speed** - A speed used to design the horizontal and vertical alignments of a highway.

Deterministic model - A mathematical model that is not subject to randomness. The result of one analysis can be repeated with certainty.

Diamond interchange - An interchange that results in two or more closely spaced surface intersections, so that one connection is made to each freeway entry and exit, with one connection per quadrant.

Directional design-hour volume - The traffic volume for the design hour in the peak direction of flow, in vehicles per hour.

Directional distribution - A characteristic of traffic, that volume may be greater in one direction than in the other during any particular hour on a highway.

Directional flow rate - The flow rate of a highway in one direction.

Directional segment - A length of two-lane highway in one travel direction, with homogeneous cross sections and relatively constant demand volume and vehicle mix.

Directional split - The directional distribution of hourly volume on a highway, expressed in percentages.

Diverge - A movement in which a single lane of traffic separates into two lanes without the aid of traffic control devices.

Double-stream door - A transit vehicle door, generally 1.14 to 1.37 m wide, that permits two passengers to board, alight, or board and alight simultaneously.

Downstream - The direction of traffic flow.

Downtown street - A surface facility providing access to abutting property in an urban area.

Drive-through (pull-through) loading area - A bus bay design for compact areas, providing several adjacent loading islands, between which buses stop, drive through, and then exit.

Driver population - A parameter that accounts for driver characteristics and their effects on traffic.

Duration of congestion - A measure of the maximum amount of time that congestion occurs anywhere in the transportation system.

Dwell time - The time a transit unit (vehicle or train) spends at a station or a stop, measured from stopping to starting.

Effective green time - The time during which a given traffic movement or set of movements may proceed; it is equal to the cycle length minus the effective red time.

Effective red time - The time during which a given traffic movement or set of movements is directed to stop; it is equal to the cycle length minus the effective green time.

Effective walkway width - The width, in meters, of a walkway usable by pedestrians, or the total walkway width minus the width of unusable buffer zones along the curb and building line.

85th-percentile speed - A speed value that is less than 15 percent of a set of field measured speeds.

Empirical model - A model that describes system performance based on the statistical analysis of field data.

Entrance ramp - A ramp that allows traffic to enter a freeway.

Equilibrium distance - The distance between the next upstream ramp and the subject ramp, or between the next downstream ramp and the subject ramp, that produces a P_{FM} or P_{FD} value indicating that the subject ramp is isolated.

Event - A meeting or a passing on a bicycle facility.

Event-based model - A simulation model that advances from one event to the next, skipping over intervening points in time when no event occurs.

Exclusive bus lane - A highway or street lane reserved for buses.

Exclusive turn lane - A designated left- or right-turn lane or lanes used only by vehicles making those turns.

Exit ramp - A ramp for traffic to depart from a freeway.

Deterministic model—Exit ramp

Extension of effective green time—Gore area

- Extension of effective green time** - The amount of the change and clearance interval at the end of the phase for a lane group, usable for movement of its vehicles.
- Extent of congestion** - The maximum geographic extent of congestion on the transportation system at any one time.
- Facility** - A length of highway composed of connected sections, segments, and points.
- Failure rate** - The probability that a bus will find all available loading areas occupied by other buses at a bus stop.
- Far-side stop** - A transit stop that requires transit units to cross an intersection before stopping to serve passengers.
- Fixed obstruction** - Obstructions along a roadway, including light poles, signs, trees, abutments, bridge rails, traffic barriers, and retaining walls.
- Fixed-route service** - Service provided by transit vehicles on a repetitive, fixed schedule along a specific route, picking up and delivering passengers to specific locations; each fixed route serves an assigned origin and destination.
- Flared approach** - A shared right-turn lane that allows right-turning vehicles to complete their movement while other vehicles are occupying the lane.
- Flow rate** - The equivalent hourly rate at which vehicles, bicycles, or persons pass a point on a lane, roadway, or other trafficway; computed as the number of vehicles, bicycles, or persons passing the point, divided by the time interval (usually less than 1 h) in which they pass; expressed as vehicles, bicycles, or persons per hour.
- Flow ratio** - The ratio of the actual flow rate to the saturation flow rate for a lane group at an intersection.
- Follow-up time** - The time between the departure of one vehicle from the minor street and the departure of the next vehicle using the same gap under a condition of continuous queuing, in seconds.
- Free flow** - A flow of traffic unaffected by upstream or downstream conditions.
- Free-flow speed** - (1) The theoretical speed of traffic, in kilometers per hour, when density is zero, that is, when no vehicles are present; (2) the average speed of vehicles over an urban street segment without signalized intersections, under conditions of low volume; (3) the average speed of passenger cars over a basic freeway or multilane highway segment under conditions of low volume.
- Freeway** - A multilane, divided highway with a minimum of two lanes for the exclusive use of traffic in each direction and full control of access without traffic interruption.
- Freeway facility** - An aggregation of sections comprising basic freeway segments, ramp segments, and weaving segments.
- Fully actuated control** - A signal operation in which vehicle detectors at each approach to the intersection control the occurrence and length of every phase.
- Functional category** - An urban street defined by the traffic service it provides.
- Functional class** - A transportation facility defined by the traffic service it provides.
- Gap** - The time, in seconds, for the front bumper of the second of two successive vehicles to reach the starting point of the front bumper of the first.
- Gap acceptance** - The process by which a minor-street vehicle accepts an available gap to maneuver.
- Gate** - A point at which a major facility crosses the boundary of a corridor.
- Gate tree** - A list of segments connected to the entry gate of a corridor.
- General terrain** - A classification used for analysis in lieu of a specific grade.
- Geometric condition** - The spatial characteristics of a facility, including approach grade, the number and width of lanes, lane use, and parking lanes.
- Geometric delay** - The component of delay that results when geometric features cause vehicles to reduce their speed in negotiating a facility.
- Gore area** - The area located immediately between the left edge of a ramp pavement and the right edge of the roadway pavement at a merge or diverge area.

Green time - The duration, in seconds, of the green indication for a given movement at a signalized intersection.

Green time ratio - The ratio of the effective green time of a phase to the cycle length.

Group critical gap - The minimum time during which a platoon of pedestrians will not attempt to cross a stop-controlled intersection, expressed in seconds.

Growth factor - A percentage increase applied to current traffic demands to estimate future demands.

Headway - (1) The time, in seconds, between two successive vehicles as they pass a point on the roadway, measured from the same common feature of both vehicles (for example, the front axle or the front bumper); (2) the time, usually expressed in minutes, between the passing of the front ends of successive transit units (vehicles or trains) moving along the same lane or track (or other guideway) in the same direction.

Heavy rail - A transit system using trains of high-performance, electrically powered rail cars operating in exclusive right-of-way.

Heavy vehicle - A vehicle with more than four wheels touching the pavement during normal operation.

High-occupancy vehicle (HOV) - A vehicle with a defined minimum number of occupants (>1); HOVs often include buses, taxis, and carpools, when a lane is reserved for their use.

Hindrance - A concept related to the comfort and convenience of bicyclists, used to derive level of service for a bicycle facility. Often, the number of events is used as a surrogate for hindrance.

Impedance - The reduction in the capacity of lower-priority movements, caused by the congestion of higher-priority movements at a stop-controlled approach.

Incident - Any occurrence on a roadway that impedes the normal flow of traffic.

Incident delay - The component of delay that results from an incident, compared with the no-incident condition.

Incremental delay - The second term of lane group control delay, it accounts for nonuniform arrivals and temporary random delays as well as delays caused by sustained periods of oversaturation.

Influence area - (1) An area that incurs operational impacts of merging vehicles in Lanes 1 and 2 of the freeway and the acceleration lane for 450 m from the merge point downstream; (2) an area that incurs operational impacts of diverging vehicles in Lanes 1 and 2 of the freeway and the deceleration lane for 450 m from the diverge point upstream.

Initial queue - The unmet demand at the beginning of an analysis period, either observed in the field or carried over from the computations of a previous analysis period.

Initial queue delay - The third term of lane group control delay refers to the delay due to a residual queue identified in a previous analysis period and persisting at the start of the current analysis period. This delay results from the additional time required to clear the initial queue.

Intelligent transportation system (ITS) - A transportation technology that enhances the safety and efficiency of vehicles and roadway systems.

Intensity of congestion - A measure of the total number of person-hours of delay and mean trip speed or mean delay per person-trip.

Interchange density - The average number of interchanges per kilometer, computed for 10 km of freeway including the basic freeway segment.

Interchange ramp terminal - A junction with a surface street to serve vehicles entering or exiting a freeway.

Internal link - The segment between two signalized intersections at an interchange ramp terminal.

Green time—Internal link

Internal zone—Load factor

- Internal zone** - A diamond-shaped area identified in a corridor analysis for each arterial street segment that lies between intersections. An internal zone represents the geographic area likely to generate trips to each segment.
- Interrupted flow** - A category of traffic facilities characterized by traffic signals, stop signs, or other fixed causes of periodic delay or interruption to the traffic stream.
- Intersection delay** - The total additional travel time experienced by drivers, passengers, or pedestrians as a result of control measures and interaction with other users of the facility, divided by the volume departing from the corresponding cross section of the facility.
- Interval** - A period of time in which all traffic signal indications remain constant.
- Isolated intersection** - An intersection at least 1.6 km from the nearest upstream signalized intersection.
- Jam density** - The density at which congestion stops all movement of persons or vehicles, usually expressed as vehicles per kilometer per lane or pedestrians per square meter.
- Kiss and ride** - An access mode to transit allowing passengers (usually commuters) to be driven to a transit stop to board a transit unit and then to be met after their return.
- Lane 1** - The highway lane adjacent to the shoulder.
- Lane 2** - The highway lane adjacent and to the left of Lane 1.
- Lane balance** - The number of lanes leaving a diverge point is equal to the number of lanes approaching it, plus one.
- Lane distribution** - A parameter used when two or more lanes are available for traffic in a single direction, and the volume distribution varies widely, depending on traffic regulation, traffic composition, speed and volume, the number of and location of access points, the origin–destination patterns of drivers, the development environment, and local driver habits.
- Lane group** - A set of lanes established at an intersection approach for separate capacity and level-of-service analysis.
- Lane group delay** - The control delay for a given lane group.
- Lane utilization** - The distribution of vehicles among lanes when two or more lanes are available for a movement; however, as demand approaches capacity, uniform lane utilization develops.
- Lane width** - The arithmetic mean of the lane widths of a roadway in one direction, expressed in meters.
- Lateral clearance** - (1) The total left- and right-side clearance from the outside edge of travel lanes to fixed obstructions on a multilane highway; (2) the right-side clearance distance from the rightmost travel lane to fixed obstructions on a freeway.
- Level of service** - A qualitative measure describing operational conditions within a traffic stream, based on service measures such as speed and travel time, freedom to maneuver, traffic interruptions, comfort, and convenience.
- Level terrain** - A combination of horizontal and vertical alignments that permits heavy vehicles to maintain approximately the same speed as passenger cars; this generally includes short grades of no more than 1 to 2 percent.
- Light rail transit (LRT)** - A metropolitan electric railway system operating single cars or short trains along exclusive rights-of-way at ground level, on aerial structures, in subways, or occasionally in streets; an LRT also can board and discharge passengers at track or car floor level.
- Linear loading area** - A bus bay design in which buses stop directly behind each other, so that the bus in front must leave its bay before the following bus can exit; often used when buses occupy a bay only for a short time (e.g., at an on-street bus stop).
- Link** - A segment of highway ending at a major intersection on an urban street or at a ramp merge or diverge point on a freeway. Links have a node at each end.
- Load factor** - The number of passengers occupying a transit vehicle, divided by the number of seats on the vehicle.

Loading area - (1) A branch from, or widening of, a road that permits buses to stop, without obstructing traffic, while laying over or while passengers board and alight; (2) a specially designed or designated location at a transit stop, station, terminal, or transfer center at which a bus stops to allow passengers to board and alight; (3) a lane in a garage facility for parking or storing buses, often for maintenance.

Loading island - (1) A pedestrian refuge within the right-of-way and traffic lanes of a highway or street, designated for transit stops, to protect transit passengers from traffic while awaiting boarding or alighting; (2) a protected spot for the loading and unloading of passengers within a rail transit or bus station; (3) a passenger loading platform in the middle of the street, level with the street or more usually raised to curb height, for streetcar and light rail systems.

Local bus - A bus that stops for passengers within 80 m of the stop line of an intersection approach.

Loop ramp - A ramp requiring vehicles to execute a left turn by turning right, accomplishing a 90-degree left turn by making a 270-degree right turn.

Lost time - The time, in seconds, during which an intersection is not used effectively by any movement; it is the sum of clearance lost time plus start-up lost time.

Low floor bus - A bus without steps at its entrances and exits.

Macroscopic model - A mathematical model that employs traffic flow rate variables.

Mainline - The primary through roadway as distinct from ramps, auxiliary lanes, and collector-distributor roads.

Major diverge segment - A segment in which one freeway segment with multiple lanes diverges, to form two primary freeway segments.

Major merge segment - A segment in which two primary freeway segments, each with multiple lanes, merge to form a single freeway segment.

Major street - The street not controlled by stop signs at a two-way stop-controlled intersection.

Major weaving segment - A weaving segment with at least three entry and exit legs, each with two or more lanes.

Maximum load point - The point on a transit line or route at which the passenger volume is the greatest. There is one maximum load point in each direction.

Measure of effectiveness - A quantitative parameter indicating the performance of a transportation facility or service.

Meeting - An encounter of bicycles or pedestrians moving in the opposite direction of the subject bicycle flow.

Merge - A movement in which two separate lanes of traffic combine to form a single lane without the aid of traffic signals or other right-of-way controls.

Mesoscopic model - A mathematical model for the movement of clusters or platoons of vehicles, incorporating equations to indicate how these clusters interact.

Microscopic model - A mathematical model that captures the movement of individual vehicles.

Midblock stop - A transit stop located at a point away from intersections.

Minor arterial - A functional category of a street allowing trips of moderate length within a relatively small geographical area.

Minor movement - A vehicle making a specific directional entry into an unsignalized intersection from a minor street.

Minor street - The street controlled by stop signs at a two-way stop-controlled intersection; also referred to as a *side street*.

Mixed-traffic bus facility - Buses operating in mixed traffic with automobiles.

Mountainous terrain - A combination of horizontal and vertical alignments causing heavy vehicles to operate at crawl speeds for significant distances or at frequent intervals.

Loading area—Mountainous terrain

Movement capacity—
Paid area

- Movement capacity** - The capacity of a specific traffic stream at a stop-controlled intersection approach, assuming that the traffic has exclusive use of a separate lane, in passenger cars per hour.
- Multilane highway** - A highway with at least two lanes for the exclusive use of traffic in each direction, with no control or partial control of access, but that may have periodic interruptions to flow at signalized intersections no closer than 3.0 km.
- Multimodal** - A transportation facility for different types of users or vehicles.
- Multiple weaving segment** - A segment formed when one merge is followed by two diverge points, or two merge points are followed by one diverge point.
- Near-side stop** - A transit stop located on the approach side of an intersection. The transit units stop to serve passengers before crossing the intersection.
- No-passing zone** - A segment of a two-lane, two-way highway along which passing is prohibited in one or both directions.
- Node** - The endpoint of a link; also used interchangeably with point.
- Nonweaving flow** - The traffic movements in a weaving segment that are not engaged in weaving movements.
- Normative model** - A mathematical model that identifies a set of parameters that provide the best system performance.
- Off-line loading** - A transit unit (vehicle or train) stops outside the main track or travel lane, so that its passengers can board and alight and other units can pass.
- Off-line model** - A mathematical model in which the output neither directly nor immediately influences traffic operations.
- Off-line stop** - A location outside the main track or travel lane at which a transit unit (vehicle or train) stops, so that passengers can board and alight and other units can pass.
- Off-ramp** - See *Exit ramp*.
- Off-street path** - A path physically separated from highway traffic for the use of pedestrians, bicycles, and nonmotorized traffic.
- Offset** - The difference, in seconds, between the start of green time at the two signalized intersections of a diamond interchange for through traffic on the internal link or the time between the start of individual green times and a specified time datum in a system of signalized intersections.
- On-line loading** - A station stop for transit units on the main track or travel lane.
- On-line model** - A model that influences the control system operation in real time.
- On-line stop** - A transit unit stop in the main track or travel lane.
- On-ramp** - See *Entrance ramp*.
- Open fare collection system** - A system for collecting transit fares that does not have turnstiles or fare gates.
- Operating margin** - The amount of time that a train can run behind schedule without interfering with following trains.
- Operational application** - A use of capacity analysis to determine the level of service on an existing or projected facility, with known or projected traffic, roadway, and control conditions.
- Opposing approach** - The approach approximately 180 degrees opposite the subject approach at an all-way stop-controlled intersection.
- Opposing flow rate** - The flow rate for the direction of travel opposite to the direction under analysis.
- Overflow queue** - Queued vehicles left over from a green phase at a signalized intersection.
- Oversaturation** - A traffic condition in which the arrival flow rate exceeds capacity.
- Paid area** - (1) An area that a passenger may enter only after paying a fare or showing credentials; (2) a station area set off by barriers or gates to restrict access to transit only to those who have paid fares or secured passes.

Paratransit - Transportation services that are more flexible and personalized than conventional fixed-route, fixed-schedule services; however, such exclusive services as charter bus trips are not considered paratransit. The vehicles usually are low- or medium-capacity highway vehicles, and the service often is adjustable to individual users' requirements.

Parclo - See *Partial cloverleaf interchange*.

Park and ride - An access mode to transit in which patrons drive private automobiles or ride bicycles to a transit station, transit stop, or carpool or vanpool waiting area, parking in the areas provided.

Partial cloverleaf interchange - Also called a parclo, an interchange with one or two loop ramps.

Partial diamond interchange - A diamond interchange with fewer than four ramps, so that not all of the freeway-street or street-freeway movements are served.

Passenger-car equivalent - The number of passenger cars displaced by a single heavy vehicle of a particular type under specified roadway, traffic, and control conditions.

Passenger service time - The time required for a passenger to board or alight from a transit vehicle, in seconds per passenger.

Passing - An encounter with a bicycle or pedestrian moving in the same direction as the subject bicycle flow on a bicycle facility.

Passing lane - A lane added to improve passing opportunities in one direction of travel on a conventional two-lane highway.

Passing sight distance - The visibility distance required for drivers to execute safe passing maneuvers in the opposing traffic lane of a two-lane, two-way highway.

Peak-hour factor - The hourly volume during the maximum-volume hour of the day divided by the peak 15-min flow rate within the peak hour; a measure of traffic demand fluctuation within the peak hour.

Pedestrian - An individual traveling on foot.

Pedestrian critical gap - The minimum time during which a single pedestrian will not attempt to cross an intersection, expressed in seconds.

Pedestrian density - The number of pedestrians per unit of area within a walkway or queuing area, expressed as pedestrians per square meter.

Pedestrian effective green time - The minimum effective green time required to serve a given pedestrian demand, expressed in seconds.

Pedestrian flow rate - The number of pedestrians passing a point per unit of time, usually expressed as pedestrians per 15 min or pedestrians per minute.

Pedestrian queuing area - Places such as elevators, transit platforms, and street crossings, in which pedestrians stand temporarily, while waiting to be served.

Pedestrian space - The average area provided for pedestrians in a moving pedestrian stream or pedestrian queue, in square meters per pedestrian.

Pedestrian start-up time - The time for a platoon of pedestrians to get under way following the beginning of the Walk interval, expressed in seconds.

Pedestrian walking speed - The average walking speed of pedestrians, in meters per second.

Percent time-spent-following - The average percent of total travel time that vehicles must travel in platoons behind slower vehicles due to inability to pass on a two-lane highway.

Performance-based planning - A way of relating agency planning and project implementation to public benefits.

Performance measure - A quantitative or qualitative characteristic describing the quality of service provided by a transportation facility or service.

Period of unmet demand - The length of time within an analysis period during which the unmet demand is greater than zero.

Permitted plus protected - Compound left-turn protection that displays the permitted phase before the protected phase.

Paratransit—Permitted plus protected

Permitted turn—Queue discharge flow

- Permitted turn** - Left or right turn at a signalized intersection that is made against an opposing or conflicting vehicular or pedestrian flow.
- Person capacity** - The maximum number of persons, in persons per hour, that reasonably can be expected to be carried past a given point on a highway or transit right-of-way during a given time period, under specified operating conditions, without unreasonable delay, hazard, or restriction.
- Phase** - The part of the signal cycle allocated to any combination of traffic movements receiving the right-of-way simultaneously during one or more intervals.
- Planning application** - A use of capacity analysis to estimate the level of service, the volume that can be accommodated, or the number of lanes required, using estimates, HCM default values, and local default values as inputs.
- Platoon** - A group of vehicles or pedestrians traveling together as a group, either voluntarily or involuntarily because of signal control, geometrics, or other factors.
- Platoon ratio** - A parameter useful in quantifying arrival type. Platoon ratio is calculated by dividing the proportion of all vehicles arriving during green by the g/C ratio of the subject movement.
- Point** - A boundary between segments, usually places at which traffic enters, leaves, or crosses a facility.
- Point-deviation service** - Public transportation service in which the transit vehicle arrives at designated stops on a prearranged schedule but does not follow a specific route.
- Potential capacity** - The capacity of a specific movement at a stop-controlled intersection approach, assuming that it is unimpeded by other movements and has exclusive use of a separate lane, in vehicles per hour.
- Precision** - The range of accurate and acceptable numerical answers.
- Prepositioning** - When one or more turning movements are necessary to occupy a lane of the lane group.
- Pretimed control** - A signal control in which the cycle length, phase plan, and phase times are preset to repeat continuously.
- Prevailing condition** - The geometric, traffic, and control conditions during the analysis period.
- Principal arterial** - A major surface street with relatively long trips between major points, and with through-trips entering, leaving, and passing through the urban area.
- Progression adjustment factor** - A factor used to account for the effect of signal progression on traffic flow; applied only to uniform delay.
- Protected plus permitted** - Compound left-turn protection at a signalized intersection that displays the protected phase before the permitted phase.
- Protected turn** - The left or right turns at a signalized intersection that are made with no opposing or conflicting vehicular or pedestrian flow allowed.
- Quality of service** - A performance indicator of a traveler's perceived satisfaction with the trip.
- Quantity of service** - A measure of the utilization of the transportation system.
- Queue** - A line of vehicles, bicycles, or persons waiting to be served by the system in which the flow rate from the front of the queue determines the average speed within the queue. Slowly moving vehicles or people joining the rear of the queue are usually considered part of the queue. The internal queue dynamics can involve starts and stops. A faster-moving line of vehicles is often referred to as a moving queue or a platoon.
- Queue carryover** - The queued vehicles left over from the analysis period due to demand exceeding capacity.
- Queue discharge** - A flow with high density and low speed, in which queued vehicles start to disperse. Usually denoted as Level of Service F.
- Queue discharge flow** - A traffic flow that has passed through a bottleneck and is accelerating to the free-flow speed of the freeway.

Queue storage ratio - The parameter that uses three parameters (back of queue, queued vehicle spacing, and available storage space) to determine if blockage will occur.

Ramp - A short segment of roadway connecting two traffic facilities.

Ramp junction - A short segment of highway along which vehicles transfer from an entrance ramp to the main roadway or from the main roadway to an exit ramp.

Ramp meter - A traffic signal that controls the entry of vehicles from a ramp onto a limited access facility; the signal allows one or two vehicles to enter on each green or green flash.

Ramp roadway - See *Ramp*.

Ramp segment - See *Ramp*.

Ramp-freeway terminal - The roadway segment over which an entrance or an exit ramp joins the mainline of a freeway.

Ramp-street terminal - The roadway segment over which an entrance or an exit ramp joins with a surface street.

Ramp-weave segment - A weaving segment formed by a one-lane entrance ramp followed by a one-lane exit ramp joined by a continuous auxiliary lane.

Random positioning - Through vehicles can use any lane of the subject lane group.

Rank - The hierarchy of right-of-way among conflicting traffic streams at a two-way stop-controlled intersection.

Rapid bus - A bus that operates on an exclusive or reserved right-of-way permitting higher speeds. On limited access roads it can include reverse lane operations.

Rapid transit - Rail systems operating on exclusive right-of-way, i.e., heavy rail or metro.

Real-time model - A model that keeps pace with actual time.

Recreational vehicle - A heavy vehicle, generally operated by a private motorist, for transporting recreational equipment or facilities; examples include campers, boat trailers, and motorcycle or jet-ski trailers.

Red time - The period, expressed in seconds, in the signal cycle during which, for a given phase or lane group, the signal is red.

Residual queue - The unmet demand at the end of an analysis period, resulting from operation while demand exceeded capacity.

Roadside obstruction - An object or barrier along a roadside or median that affects traffic flow, whether continuous (e.g., a retaining wall) or not continuous (e.g., light supports or bridge abutments).

Roadway characteristic - A geometric characteristic of a street or highway, including the type of facility, number and width of lanes (by direction), shoulder widths and lateral clearances, design speed, and horizontal and vertical alignments.

Roadway occupancy - The proportion of roadway length covered by vehicles, used to identify the proportion of time a roadway cross section is occupied by vehicles. Because it is easier to measure in the field, roadway occupancy is used as a surrogate for density in control systems.

Rolling terrain - A combination of horizontal and vertical alignments causing heavy vehicles to reduce their speed substantially below that of passenger cars but not to operate at crawl speeds for a significant amount of time.

Roundabout - An unsignalized intersection with a circulatory roadway around a central island with all entering vehicles yielding to the circulating traffic.

Route-deviation service - A public transportation service that operates along a public way on a fixed route but not on a fixed schedule. It is a form of paratransit.

Running speed - The distance a vehicle travels divided by running time, in kilometers per hour.

Running time - The portion of the travel time during which a vehicle is in motion.

Rural - An area with widely scattered development and a low density of housing and employment.

Queue storage ratio—Rural

Saturation flow rate—
Simple left turn
protection

Saturation flow rate - The equivalent hourly rate at which previously queued vehicles can traverse an intersection approach under prevailing conditions, assuming that the green signal is available at all times and no lost times are experienced, in vehicles per hour or vehicles per hour per lane.

Saturation headway - The average headway between vehicles occurring after the fourth vehicle in the queue and continuing until the last vehicle in the initial queue clears the intersection.

Sawtooth loading area - A bus bay design with the curb indented in a sawtooth pattern, allowing buses to enter and exit bus bays independently of other buses. Often used at transit centers.

Segment - A portion of a facility on which a capacity analysis is performed; it is the basic unit for the analysis, a one-directional distance. A segment is defined by two endpoints.

Semiactuated control - A signal control in which some approaches (typically on the minor street) have detectors, and some of the approaches (typically on the major street) have no detectors.

Service area - (1) The jurisdiction in which a transit property operates; (2) the geographic region in which a transit system either provides service or is required to provide service.

Service coverage - See *Coverage*.

Service flow rate - The maximum hourly rate at which vehicles, bicycles, or persons reasonably can be expected to traverse a point or uniform segment of a lane or roadway during a given time period (usually 15 min) under prevailing roadway, traffic, environmental, and control conditions, while maintaining a designated level of service; expressed as vehicles per hour or vehicles per hour per lane.

Service frequency - The number of transit units (vehicles or trains) on a given route or line, moving in the same direction, that pass a given point within a specified interval of time, usually 1 h; see also *Headway*.

Service measure - A specific performance measure used to assign a level of service to a set of operating conditions for a transportation facility or service.

Service time - The average time that a vehicle on the subject approach is serviced at an all-way stop-controlled intersection, depending on arrival rates of the opposing and conflicting approaches.

Service volume - The maximum hourly rate at which vehicles, bicycles, or persons reasonably can be expected to traverse a point or uniform segment of a roadway during an hour under specific assumed conditions while maintaining a designated level of service.

Shared-lane capacity - The capacity of a lane, in vehicles per hour, at an unsignalized intersection that is shared by two or three movements.

Shock wave - The compression wave that moves upstream through traffic as vehicles arriving at a queue slow down abruptly, or the decompression wave of thinning traffic that moves downstream from the point of a capacity reduction on a freeway.

Shoulder - A portion of the roadway contiguous with the traveled way for accommodation of stopped vehicles, emergency use, and lateral support of the subbase, base, and surface courses.

Shoulder bypass lane - A portion of the paved shoulder opposite the minor-road leg at a three-leg intersection, marked as a lane for through traffic to bypass vehicles that are slowing or stopped to make a left turn.

Side street - See *Minor street*.

Signalization condition - A phase diagram illustrating the phase plan, cycle length, green time, change interval, and clearance time interval of a signalized intersection.

Simple left turn protection - A signal phasing scheme that provides a single protected phase in each cycle for a left turn.

Simple weaving segment - A segment formed by a single merge point followed by a single diverge point.

Simulation model - A computer program that uses mathematical models to conduct experiments with traffic events on a transportation facility or system over extended periods of time.

Simulation model descriptor - A fundamental descriptor (state variable, event, time step logic, and processing logic) used in combination with others to represent a unified and consistent simulation model.

Single-point diamond interchange - A diamond interchange that combines all the ramp movements into a single signalized intersection.

Single-stream door - A door on a transit vehicle that allows passenger flow in only one direction at a time.

Skip-stop service - A transit operation in which alternate units stop at alternate sets of stations on the same route. Each set consists of some joint and some alternate stations.

Space - See *Pedestrian space*.

Space mean speed - (1) The harmonic mean of speeds over a length of roadway; (2) an average speed based on the average travel time of vehicles to traverse a segment of roadway; in kilometers per hour.

Spacing - The distance, in meters, between two successive vehicles in a traffic lane, measured from the same common feature of the vehicles (e.g., rear axle, front axle, or front bumper).

Specific grade - A single grade of a roadway segment or extended roadway segment expressed in percentage.

Speed - A rate of motion expressed as distance per unit of time.

Split-diamond interchange - Diamond interchanges in which freeway entry and exit ramps are separated at the street level, creating four intersections.

Standee - A passenger standing in a transit vehicle.

Start-up lost time - The additional time, in seconds, consumed by the first few vehicles in a queue at a signalized intersection above and beyond the saturation headway, because of the need to react to the initiation of the green phase and to accelerate.

Static flow model - A mathematical model in which the traffic flow rate is constant.

Stochastic model - A mathematical model that employs random variables for at least one input parameter.

Stop time - A portion of control delay when vehicles are at a complete stop.

Street corner - The area encompassed within the intersection of two sidewalks.

Streetcar - An electrically powered rail car that is operated singly or in short trains in mixed traffic on track in city streets.

Study period - A duration of time on which to base capacity analyses of a transportation facility.

Subject approach - The approach under study at two-way and all-way stop-controlled intersections.

Suburban - An area with a mixture of densities for housing and employment, where high-density nonresidential development is intended to serve the local community.

Suburban street - A street with low-density driveway access on the periphery of an urban area.

System level of service - The quality of service provided by the transportation system.

System performance measure - A parameter that measures the efficiency of the transportation system.

System performance report card - A list of measures depicting the use of the transportation system, for decision making.

System speed - A space mean speed, in kilometers per hour, of vehicles both in the ramp influence area and in the outer lanes of a 450-m freeway segment.

Simple weaving segment—
System speed

Taper area—Traveler satisfaction

- Taper area** - An area characterized by a reduction or increase in pavement width to direct traffic.
- Terrain type** - See *General terrain*.
- Through vehicles** - All vehicles passing directly through a street segment and not turning.
- Time interval** - See *Analysis period*.
- Time interval scale factor** - The ratio of the total freeway entrance demands to the freeway exit counts in each time interval.
- Time mean speed** - The arithmetic average of individual vehicle speeds passing a point on a roadway or lane, in kilometers per hour.
- Time-based model** - A model in which time advances from one point to the next.
- Time-space domain** - A graphical display of a freeway facility with a horizontal scale of distance along the freeway, with traffic moving from left to right, and with the freeway divided into sections.
- Time-varying flow model** - A simulation model in which flow changes with time.
- Total delay** - The sum of all components of delay for any lane group, including control delay, traffic delay, geometric delay, and incident delay . See also *Aggregate delay*.
- Total lateral clearance** - The total width of the left side plus the right side along one direction of a roadway.
- Total lost time** - The time per signal cycle during which the intersection is effectively not used by any movement; this occurs during the change and clearance intervals and at the beginning of most phases.
- Traffic condition** - A characteristic of traffic flow, including distribution of vehicle types in the traffic stream, directional distribution of traffic, lane use distribution of traffic, and type of driver population on a given facility.
- Traffic delay** - The component of delay that results when the interaction of vehicles causes drivers to reduce speed below the free-flow speed.
- Traffic pressure** - A parameter that reflects driver aggressiveness due to heavier volumes or long delays in a confined area.
- Transit accessibility** - A measure of pedestrian, bicycle, automobile, and Americans with Disabilities Act accessibility to transit.
- Transit availability** - A measure of a transit system's capability for use by potential passengers, including the hours the system is in operation, route spacing, and accessibility for the physically handicapped.
- Transit quality of service** - The overall measured or perceived quality of transit service from the passenger's point of view.
- Transit reliability** - A measure of the time performance and the regularity of headways between successive transit vehicles that affect the amount of time passengers must wait at a transit stop as well as the consistency of a passenger's arrival time at a destination.
- Transit stop** - An area where passengers await, board, alight, and transfer between transit units (vehicles or trains). It is usually indicated by distinctive signs and by curb or pavement markings and may provide service information, shelter, seating, or any combination of these.
- Transit-supportive area** - An area with sufficient population or employment density to warrant at least hourly transit service.
- Travel speed** - The average speed, in kilometers per hour, of a traffic stream computed as the length of a highway segment divided by the average travel time of the vehicles traversing the segment.
- Travel time** - The average time spent by vehicles traversing a highway segment, including control delay, in seconds per vehicle or minutes per vehicle.
- Traveler satisfaction** - A measure of the quality of a trip from the perspective of the traveler.

- Trolleybus** - An electrically propelled bus that obtains power from an overhead wire system. The power-collecting apparatus allows the bus to maneuver in mixed traffic over several lanes.
- Truck** - A heavy vehicle engaged primarily in the transport of goods and materials or in the delivery of services other than public transportation.
- Turnout** - A short segment of a lane—usually a widened, unobstructed shoulder area—added to a two-lane, two-way highway, allowing slow-moving vehicles to leave the main roadway and stop so that faster vehicles can pass.
- Two-lane Class I highway** - A two-lane highway that generally serves long-distance trips or provides connecting links between facilities that serve long-distance trips.
- Two-lane Class II highway** - A two-lane highway that generally serves relatively short trips, the beginning and ending portions of longer trips, or trips for which sightseeing activities play a significant role in route choice.
- Two-lane highway** - A roadway with a two-lane cross section, one lane for each direction of flow, on which passing maneuvers must be made in the opposing lane.
- Two-sided weaving segment** - A weaving segment in which vehicles entering the highway approach on the right and vehicles departing the highway depart on the left, or vice versa; weaving vehicles must cross the mainline highway flow.
- Two-stage gap acceptance** - A process used by drivers entering an unsignalized intersection from the minor street and reaching the median area in a first move, then completing the entry with a second move.
- Two-way left-turn lane** - A lane in the median area that extends continuously along a street or highway and is marked to provide a deceleration and storage area, out of the through-traffic stream, for vehicles traveling in either direction to use in making left turns at intersections and driveways.
- Two-way stop-controlled** - The type of traffic control at an intersection where drivers on the minor street or a driver turning left from the major street wait for a gap in the major-street traffic to complete a maneuver.
- Unconstrained operation** - An operating condition when the geometric constraints on a weaving segment do not limit the ability of weaving vehicles to achieve balanced operation.
- Uncontrolled ramp terminal** - A ramp terminal without a traffic control device.
- Undersaturation** - A traffic condition in which the arrival flow rate is lower than the capacity or the service flow rate at a point or uniform segment of a lane or roadway.
- Uniform delay** - The first term of the equation for lane group control delay, assuming uniform arrivals.
- Uninterrupted flow** - A category of facilities that have no fixed causes of delay or interruption external to the traffic stream; examples include freeways and unsignalized sections of multilane and two-lane rural highways.
- Unit extension** - The minimum gap, in seconds, between successive vehicles moving on a traffic-actuated approach to a signalized intersection that will cause the signal controller to terminate the green display.
- Unit width flow rate** - The pedestrian flow rate expressed as pedestrians per minute per meter of walkway or crosswalk width.
- Unmet demand** - The number of vehicles on a signalized lane group that have not been served at any point in time as a result of operation in which demand exceeds capacity, in either the current or previous analysis period. This does not include the normal cyclical queue formation on the red and discharge on the green phase. See also *Initial queue* and *Residual queue*.
- Unsignalized intersection** - An intersection not controlled by traffic signals.
- Upstream** - The direction from which traffic is flowing.
- Urban** - An area typified by high densities of development or concentrations of population, drawing people from several areas within a region.

Urban street—Zone

- Urban street** - A street with relatively high density of driveway access located in an urban area and with traffic signals no farther than 3.0 km apart.
- Urban street class** - A category of urban street based on functional and design categories.
- Urban street segment** - A length of urban street (in one direction) from one signal to the next, including the downstream signalized intersection but not the upstream signalized intersection.
- Utility** - A measure of the value a traveler places on a trip choice.
- Utility equation** - A mathematical function for evaluating the use of highway facilities; the numerical values depend on the attributes of the travel options and on the characteristics of the traveler.
- Validation** - Determining whether the selected model is appropriate for the given conditions and for the given task; it compares model prediction with measurements or observations.
- Variability** - The probability of congestion or a confidence interval for measures of congestion (intensity, duration, and extent).
- Vehicle capacity** - (1) The maximum number of passengers that a transit vehicle is designed to accommodate comfortably, seated and standing; also known as normal vehicle capacity or total vehicle capacity; (2) the maximum number of vehicles that can be accommodated in a given time by a transit facility.
- Volume** - The number of persons or vehicles passing a point on a lane, roadway, or other traffic-way during some time interval, often 1 h, expressed in vehicles, bicycles, or persons per hour.
- Volume to capacity ratio** - The ratio of flow rate to capacity for a transportation facility.
- Walkway** - A facility provided for pedestrian movement and segregated from vehicular traffic by a curb, or provided for on a separate right-of-way.
- Wave speed** - The speed at which a shock wave travels upstream or downstream through traffic.
- Weave type** - A classification scheme that categorizes weaving configuration into one of the three types (Types A, B, C).
- Weaving** - The crossing of two or more traffic streams traveling in the same direction along a significant length of highway, without the aid of traffic control devices (except for guide signs).
- Weaving configuration** - The organization and continuity of lanes in a weaving segment, which determines lane-changing characteristics.
- Weaving diagram** - A schematic drawing of flows in a weaving segment, used in analysis.
- Weaving flow** - The traffic movements in a weaving segment that are engaged in weaving movements.
- Weaving length** - The length from a point on the merge gore at which the right edge of the freeway shoulder lane and the left edge of the merging lane are 0.6 m apart to a point on the diverge gore at which the edges are 3.7 m apart.
- Weaving segment** - A length of highway over which traffic streams cross paths through lane-changing maneuvers, without the aid of traffic signals; formed between merge and diverge points.
- Weaving width** - The total number of lanes between the entry and exit gore areas, including the auxiliary lane, if present.
- Work zone** - A segment of highway in which maintenance and construction operations impinge on the number of lanes available to traffic or affect the operational characteristics of traffic flowing through the segment.
- Zebra-striped crosswalk** - A crosswalk painted with diagonal stripes at an unsignalized intersection, in which pedestrians have the right-of-way.
- Zone** - A geographic aggregation defined by land use, which generates trips within a corridor.

CHAPTER 6

SYMBOLS

This chapter lists and defines the symbols and abbreviations used in the manual, along with their units if applicable. If the same symbol has more than one meaning, the chapter or chapters of the specific use are cited in parentheses () following the definition.

<i>A</i>	1. Passenger waiting area size, m ² (27). 2. Access points (21).
<i>a</i>	1. Adjustment factor for two-stage gap acceptance (17). 2. Coefficient for estimating base percent time spent following (20). 3. Weaving intensity factor calibration constant (24). 4. Adjacent-lane impedance factor (27).
<i>AADT</i>	Annual average daily traffic, veh/day
<i>AC</i>	Urban street class
<i>AI</i>	Added initial time per actuation, s
<i>a_n(t)</i>	Acceleration of nth vehicle at time t
<i>a_p</i>	Design pedestrian area occupancy, m ² /p
<i>A_{pbT}</i>	Permitted phase adjustment for pedestrian/bicycle blockage
<i>AT</i>	Arrival type
<i>ATS</i>	Average travel speed for both directions of travel combined on two-lane highways, km/h
<i>ATS_c</i>	Average travel speed for all two-lane highway directional segments combined, km/h
<i>ATS_d</i>	Average travel speed in the analysis direction for the entire segment without the passing lane, km/h
<i>ATS_{pl}</i>	Average travel speed for the entire segment including the passing lane, km/h
<i>AVM</i>	Adjusted vehicle minimum time, s
<i>AVO</i>	Average vehicle occupancy
<i>AWDT</i>	Average weekday daily traffic, veh/day
<i>B</i>	1. Begin platoon event time; the time that the dispersing platoon begins to pass through the subject two-way stop-controlled intersection (17). 2. Bus lane vehicle capacity, buses/h (27).
<i>b</i>	1. Bunching factor (16). 2. Coefficient for estimating base percent time spent following (20). 3. Weaving intensity factor calibration constant (24).
<i>B(a)</i>	Sum of gradients for counted segments
<i>B_{bb}</i>	Maximum number of buses per berth per hour, buses/h
<i>BFFS</i>	Base free-flow speed, km/h
<i>BPTSF</i>	Base percent time-spent-following, %
<i>BPTSF_d</i>	Base percent time-spent-following in the analysis direction, %
<i>B_s</i>	Maximum number of buses per bus stop per hour, buses/h
<i>C</i>	1. Signal cycle length, s. 2. Capacity, veh/h (30).
<i>c</i>	1. Total lane group capacity, veh/h. 2. Two-way segment capacity, normally 3,200 pc/h for a two-way segment and 1,700 pc/h for a directional segment (20). 3. Weaving intensity factor calibration constant (24).
<i>C(a)</i>	Sum of square of gradients for counted segments
<i>c_a</i>	Approach capacity at roundabouts, veh/h
<i>CAF</i>	Capacity adjustment factor
<i>c_b</i>	1. Capacity of bicycle lane, bicycle/h (19). 2. Bus capacity, buses/h (27).
<i>CBD</i>	Central business district
<i>CF</i>	Acceleration/deceleration correction factor

A—CF

c_1-d_j

c_I	Capacity for Stage I of two-stage gap acceptance
c_{II}	Capacity for Stage II of two-stage gap acceptance
c_L	1. Lane group capacity per lane, veh/h (16). 2. Capacity of major-street left-turn lane, veh/h (30).
$c_{m,x}$	Movement capacity of Minor Movement x, veh/h
C_{max}	Maximum cycle length, s
C_{min}	Minimum cycle length, s
$Cost$	Out-of-pocket cost for trip, cents
$c_{p,x}$	Potential capacity of Minor Movement x, veh/h
c_r	Capacity of right turns at specific intersection, veh/h
CS	Sum of critical phase volumes, veh/h
c_s	Capacity of stop-controlled approach, veh/h
c_{SH}	Capacity of a shared lane, veh/h
c_T	Available capacity in the analysis period, veh/h
$c_{T,x}$	Total capacity for Movement x considering a two-stage gap acceptance, veh/h
CV	Critical phase volume, veh/h
c_v	Coefficient of variation of headways of transit serving a particular route arriving at a stop
CVS	Sum of critical volume to saturation flow rate ratio
D	1. Density, veh/km, pc/km/h, or veh/km/ln (7). 2. Proportion of peak-hour traffic in peak direction (8). 3. Total initial queue delay due to an initial queue incurred in the average cycle, s (16). 4. Density of all vehicles in the weaving segment, pc/km/ln (24). 5. Diverge from traffic at an interchange (26). 6. Movement at a downstream intersection (26). 7. Number of doors available in the peak hour (27). 8. Mean delay for subject lane group, s/veh (30). 9. Node delay for link, s (30).
d	1. Control delay, s/veh (11, 15, 16). 2. Demand, veh/h (22). 3. Weaving intensity factor calibration constant (24). 4. Mean trip delay, s/person (29). 5. Direction of analysis index (29).
d_1	Uniform delay, s/veh
d_2	Incremental delay, s/veh
d_3	Initial queue delay, s/veh
D_a	Mean delay for subject approach, s/veh
d_A	Approach delay, s/veh
d_{ad}	Acceleration/deceleration correction delay, s
d_b	Control delay, s/bicycle
D_c	Number of doors per car
d_{CI}	Combined interchange delay, s/veh
$DDHV$	Directional design-hour volume, veh/h
DF	Adjustment factor for progression to compute zero-flow control delay at signalized intersection
DHV	Design-hour volume, bicycles/h
D_i	Delay incurred by vehicles in the initial queue, s/veh
d_j	Intersection control delay, s/veh
d_j	1. Lane group delay, s/veh (16). 2. Average control delay for Lane Group i, s/veh (26).
$diff_i$	Computed differences for the entry legs
$diff_j$	Computed differences for the exiting legs
d_{INT}	Average control delay per vehicle for the interchange, s/veh
D_j	Jam density, veh/km or veh/km/ln
d_j	1. Pedestrian control delay at Intersection j, s (18). 2. Average bicycle delay at Intersection j, s (19).

DL	Detector length, m
D_l	Estimated delay for left turns, s/veh
D_m	Delay per person-trip for modal subsystem, s
d_n	Distance to subject vehicle n
d_{n-1}	Distance from subject vehicle n to vehicle ahead n - 1
D_o	1. Optimum density, veh/km or veh/km/ln (7). 2. Zero-flow control delay at signalized intersection, h (30).
d_p	Average pedestrian delay, s
D_p	Delay per person-trip for Point p, s
D_{ped}	Pedestrian density, p/m ²
DQ	Total delay due to excess demand or queuing delay, veh-h
D_R	Density of flow within the ramp influence area, pc/km/ln
D_r	Estimated delay for right turns, s/veh
d_{rank1}	Average control delay to Rank 1 vehicles, s/veh
DS	Detector setback, m
D_s	1. Intermediate speed determination variable for diverge area (25). 2. Delay per person-trip for segment, s (28).
d_s	1. Storage density, veh/km/ln (7, 29, 30). 2. Saturated delay, s (16). 3. Deceleration rate, m/s ² , also used as a surrogate for twice the average acceleration from zero to maximum velocity (27).
d_{sep}	Average control delay for the separate lane case, s/veh
d_{SH}	Average control delay for the shared lane case, s/veh
D_{so}	Oversaturation delay corresponding to a zero initial queue, s/veh
D_t	Estimated delay for through vehicles, s/veh
d_T	Delay for transit passengers, h
du	Dwelling unit
d_u	Undersaturated delay, s
d_{vq}	Time-in-queue per vehicle, s
D_x	Delay per person-trip for Segment x, s
E	1. End platoon event time; the time that the dispersing platoon completes passage through the subject two-way stop-controlled intersection. 2. East intersection (26).
e	Extension of green time, s
EB	Eastbound approach or movement
E_{L1}	Through-car equivalents for permitted left turns
E_{L2}	Through-car equivalents for opposing movements of permitted left turns
e_o	Unit extension time setting, s
E_R	Passenger-car equivalent for recreational vehicles
E_T	1. Passenger-car equivalent for heavy vehicles in the lane group (16). 2. Passenger-car equivalent for trucks; sometimes includes buses (20, 21, 22, 23, 24, 25)
E_{TC}	Passenger-car equivalent for trucks that use crawl speeds
EW	Sum of the volume to saturation flow rate ratio for the critical phase pair for the east-west street
F	1. A parameter for basic dispersion model calculated as $[1 + (t_a)^{-1}]$ (17). 2. Total number of events on the path, events/h (18, 19).
f_A	Adjustment to account for effect of access points on base free-flow speed
f_a	Adjustment factor for area type
FAR	Floor area ratio
f_b	Bus-bus interference adjustment factor
$f_{B\%}$	Percentile back of queue factor

$DL-f_{B\%}$

f_{bb} — $g(a)$

f_{bb}	Adjustment factor for the blocking effect of local buses that stop within the intersection area
$f_{d/np}$	Adjustment for the combined effect of directional distribution of traffic and the percentage of no-passing zones on percent time-spent-following, %
f_{DL}	Planning left-turn adjustment factor
FFS	Free-flow speed, km/h
FFS_d	Free-flow speed in the analysis direction, km/h
f_G	Grade adjustment factor for two-lane highways
f_g	Adjustment factor for approach grade
f_{HV}	Heavy-vehicle adjustment factor
f_{ID}	Adjustment for interchange density, km/h
f_k	Impedance adjustment factor
f_l	Bus stop location factor for bus lane capacity
f_{LC}	Adjustment for lateral clearance, km/h
f_{Lpb}	Pedestrian adjustment factor for left-turn movements
f_{LS}	Adjustment to base free-flow speed to account for effect of lane width and shoulder width, km/h
f_{LT}	Adjustment factor for left turns in the lane group
f_{LU}	Adjustment factor for lane utilization
f_{LUo}	Lane utilization factor for the opposing flow of permitted left turns
f_{LW}	Adjustment for lane width, km/h
F_m	Number of opposing events, events/h
f_M	Adjustment for median type, km/h
f_m	1. Left-turn adjustment factor applied only to the lane from which left turns are made (16). 2. Mixed traffic adjustment factor (27).
f_{min}	Minimum left-turn adjustment factor applied only to the lane from which left turns are made
f_N	Adjustment for number of lanes, km/h
f_{np}	Adjustment to account for the effect of percentage of no-passing zones on free-flow speed
F_p	Number of passing events, events/h
f_p	1. Adjustment factor for the existence of parking lane and parking activity adjacent to the lane group (10, 16). 2. Driver population factor (21, 23, 25, 30). 3. Bus-passing activity factor (27).
f_{PA}	Supplemental adjustment factor for platoon arrival during the green
f_{pb}	Pedestrian blockage factor, or the proportion of time that one lane on an approach is blocked during one hour
f_{pl}	Factor for the effect of a passing lane on percent time-spent-following and average travel time
f_q	Queue calibration factor for randomness in arrivals
f_r	Right-turn adjustment factor for bus lane capacity
f_{Rpb}	Pedestrian/bicycle adjustment factor for right-turn movements
f_{RT}	Adjustment factor for right turns in the lane group
f_s	Skip-stop speed adjustment factor
f_W	Adjustment factor for lane width
f_x	A capacity adjustment factor for Movement x that accounts for the impeding effects of higher-ranked movements
G	1. Approach grade, % (16). 2. Green time, s (16). 3. Percent grade divided by 100 (17). 4. Green time for phase, if WALK + FDW is not installed, s (18).
g	1. Effective green time for lane group or for movement, s (15). 2. Effective green time for pedestrians, s (18).
$g(a)$	Gradient of a segment (29)

g_{diff}	The larger of (a) the difference between g_q and g_f and (b) zero, s
g_e	Extension to the protected green time that occurs while the controller waits for a gap in the arriving traffic long enough to terminate the phase, s
g_{eff}	Effective green time of a signalized intersection upstream of a two-way stop-controlled intersection, s
g_f	Portion of the green time in which a through vehicle in a shared lane would not be blocked by a left-turn vehicle waiting for the opposing movement to clear, s
G_i	Green time, s
g_j	Effective green time, s
$G(i,j)$	Gradient matrix for corridor analysis (29)
G_{max}	Maximum gradient, or the largest absolute ratio of the gradient to the estimated number of trips (29)
g_o	Effective green time for the opposing flow, s
G_p	Minimum pedestrian green time, s
g_p	Pedestrian green time (Walk + Don't Walk), s
g_{prot}	Protected phase effective green time, s
g_q	1. Portion of the permitted green time blocked by a queue of opposing vehicles, s (16). 2. Total time to discharge the queue at a signalized intersection upstream of a two-way stop-controlled intersection, s (17).
g_{q1}	The time to discharge the vehicles that arrive during red at a signalized intersection upstream of a two-way stop-controlled intersection, s
g_{q2}	The time to discharge the vehicles that arrive during green and join the back of queue at a signalized intersection upstream of a two-way stop-controlled intersection, s
GR	Gap reduction rate
g_s	Portion of the protected green time required to service the queue of vehicles that accumulated on the previous phase, s
g_u	Portion of the permitted green time not blocked by a queue of opposing vehicles, s
H	Number of hours in analysis period
h	1. Saturation headway, s (7). 2. Time period index (29).
h	hour
h_{adj}	Headway adjustment to account for the proportion of left turns, right turns, and heavy vehicles, s
h_{bs}	Minimum block-signalized section train headway, s
h_d	Departure headway, s
H_i	Duration of congestion for Link i , h
h_{min}	Minimum train headway, s
h_{os}	Minimum on-street section train headway, s
h_s	Scheduled headway, s
h_{si}	Saturation headway for degree of conflict Case i
h_{st}	Minimum single-track section train headway, s
HV	Percent heavy vehicles, %
l	1. Incremental delay adjustment for the filtering or metering by upstream signals (10, 15, 16). 2. Survey count interval for field control delay study (16). 3. Adjustment factor for type, intensity, and location of the work activity to compute capacity on freeway facilities, pc/h/ln (22).
i	Vehicle movements subscript of Rank 1
l_s	Interval between vehicle-in-queue counts, s
IVT	In-vehicle time, min

g_{diff} —IVT

J—L_{down}

<i>J</i>	Calibration parameter
<i>j</i>	Vehicle movements subscript of Rank 2
<i>K</i>	1. The proportion of annual average daily traffic occurring in the analysis period. 2. Adjustment factor to utilize bus stops fully in a skip-stop operation (27). 3. Parameter (30).
<i>k</i>	1. Incremental delay adjustment factor for the actuated control (10, 15, 16). 2. Vehicle movements subscript of Rank 3 (17). 3. Constant to adjust degree of conflict case probability to account for interdependence of headways (17).
<i>k_B</i>	Second term queued vehicles adjustment factor related to early arrivals
<i>kg</i>	kilogram
<i>k_i</i>	Sum of known trips originating at <i>i</i>
<i>k_j</i>	Sum of known trips destined to <i>j</i>
<i>km</i>	kilometer
<i>k_{min}</i>	Minimum factor to compute incremental delay adjustment for actuated signal
<i>kW</i>	kilowatt
<i>L</i>	1. Length of a highway segment, km (7). 2. Lost time per cycle or total lost time, s (10, 16). 3. Urban street segment or section length, km (15). 4. Crosswalk length, m (16, 18). 5. Length of weaving segment, m (24). 6. Length of the link (i-j) from the upstream stop line to the downstream stop line, m (26). 7. Left-side movement at an interchange (26). 8. Train length, m (27). 9. Analysis section length, km (27). 10. Length of segment, km (29). 11. Link length, km (30).
<i>l</i>	1. Vehicle movements subscript of Rank 4 (17). 2. Queue storage length per vehicle, veh (26). 3. Segment index (29).
<i>L₁</i>	Distance for one-block stop pattern, m
<i>l₁</i>	Start-up lost time, s
<i>L₂</i>	Distance for multiple-block stop pattern, m
<i>l₂</i>	Clearance lost time, s
<i>L_A</i>	Total length of the acceleration lane, m
<i>L_a</i>	Available queue storage distance, m
<i>L_{A1}</i>	Length of first acceleration lane on a two-lane on-ramp, m
<i>L_{A2}</i>	Length of second acceleration lane on a two-lane on-ramp, m
<i>L_{aa}</i>	Length of added approach lane, km
<i>L_{ad}</i>	Length of added departure lane, km
<i>L_{Aeff}</i>	Length of effective acceleration lane on a two-lane on-ramp, m
<i>LC_L</i>	Width of lateral clearance from the left edge of travel lanes to obstructions in the roadway median, m
<i>LC_R</i>	Width of lateral clearance from the right edge of travel lane to roadside obstruction, m
<i>L_D</i>	Length of deceleration lane, m
<i>L_d</i>	1. Detector length, m (16). 2. Length of two-lane highway downstream of the passing lane and beyond its effective length, km (20).
<i>L_{D1}</i>	Length of first deceleration lane on a two-lane off-ramp, m
<i>L_{D2}</i>	Length of second deceleration lane on a two-lane off-ramp, m
<i>L_{de}</i>	Downstream length of two-lane highway within the effective length of the passing lane, km
<i>L'_{de}</i>	Actual distance from end of passing lane to end of analysis segment, km
<i>L_{Deff}</i>	Length of effective deceleration lane on a two-lane on-ramp, m
<i>L_{down}</i>	Distance from the subject ramp to the downstream adjacent ramp, m

L_{EQ}	Equilibrium distance between upstream or downstream ramp and the subject ramp, m
L_h	Average queue spacing in a stationary queue, m
L_i	Length of Segment i, m
l_j	Total start-up lost time, s
ln	lane
L_{pl}	Length of the passing lane including tapers, km
L_s	Length of left- or right-lane storage bay, m
L_{st}	Length of single-track section, m
LT	Left turn
L_T	Total length of the urban street under analysis, m
L_t	Total length of the analysis segment, km
LTC	Left-turn vehicles per cycle, veh
L_u	Length of two-lane highway upstream of the passing lane, km
L_{up}	Distance from the subject ramp to the upstream adjacent ramp, m
L_v	Vehicle length, m
LW	Lane width, m
M	1. Circulation area per pedestrian or pedestrian space, m^2/p (11, 18). 2. Median type (21). 3. Merge with traffic at an interchange (26).
m	1. Number of vehicles that can be stored in median of intersection during two-stage gap acceptance, veh (17). 2. Move-up time, s (17).
m	meter
MF	Mainline flow rate, veh/h
min	minute
MnA	Minimum allowable gap, s
MnV	Minimum vehicle phase time, s
M_s	Intermediate speed determination variable for merge area
MxG	Maximum green time, s
Mxl	Maximum initial interval, s
N	1. Number of lanes. 2. Last vehicle in queue (7). 3. Number of through lanes at an intersection (15). 4. Number of lanes open through the short-term work zone (22). 5. Total number of lanes in the weaving segment (24). 6. Number of stops or stations in the analysis section (27).
n	1. Number of travel times observed (7). 2. Minimum number of observations to meet accuracy goal of mean (9). 3. Fractional added through lane (10). 4. Maximum number of opposing vehicles that could arrive during g_{diff} (16). 5. Number of vehicles that can be stored in flared right-turn approach, veh (17).
$N(i)$	Node i with the upstream segment numbered segment (i - 1) and the downstream segment numbered (i)
N_B	Local buses stopping at intersection, buses/h
NB	Northbound approach or movement
N_c	1. Size of typical pedestrian crossing platoon, p (11, 18). 2. Number of cycles surveyed (16). 3. Number of cars per train (27).
N_{cd}	Number of channels per door for moving passengers
N_{eb}	Number of effective loading areas
N_j	Number of analysis subperiods
N_{LG}	Number of lanes in the lane group
N_{LT}	Number of exclusive left-turn lanes
N_m	Parking activity per hour, maneuvers/h
n_{Max}	The maximum value of n, the number of vehicles that can be stored in the flared right-turn approach, above which it will operate like a separate lane

$L_{EQ} - n_{Max}$

$N_{nw} - P_c$

N_{nw}	Number of lanes used by nonweaving vehicles
N_O	Number of outside lanes in one direction (not including acceleration or deceleration lanes or Lanes 1 and 2)
N_o	Number of opposing lanes
N_p	1. Spatial distribution of pedestrians, p-m (18). 2. Number of buses making the maneuver from the curb lane to the adjacent lane (27).
N_{ped}	Number of pedestrians crossing during an interval, p
N_{rec}	Number of cross-street receiving lanes
N_{RT}	Number of exclusive right-turn lanes
NS	Sum of the volume to saturation flow rate ratio for the critical phase for the north-south street
N_s	1. Number of alternating skip stops in sequence (27). 2. Number of stations on single-track section (27).
N_{TH}	Number of through lanes
N_{turn}	Number of turning lanes
N_{tv}	Number of vehicles during the green phase, veh
N_w	Number of lanes used by weaving vehicles if unconstrained operation is to be achieved
$N_w(max)$	Maximum number of lanes that can be used by weaving vehicles for a given configuration
OCC_{bicg}	Average bicycle occupancy
OCC_{pedg}	Average pedestrian occupancy
OCC_{pedu}	Pedestrian occupancy after the opposing queue clears
OCC_r	Relevant average pedestrian and bicycle occupancy
$OFRF$	Off-ramp flow rate, veh/h
$ONRF$	On-ramp flow rate, veh/h
OVT	Out-of-vehicle travel time, min
P	1. Proportion of all vehicles arriving during green (15, 16, 26). 2. Primary phase (16). 3. Bicycle or pedestrian directional split (19). 4. Maximum single-track capacity in passengers per peak-hour direction (27). 5. Total number of person trips (29). 6. Number of transit passengers onboard, p (29). 7. Length of subperiod, h (30).
p	pedestrian, passenger, or person
p	Proportion of total flow rate traveling in the subject direction
p'	Adjustment to the major-street left turn, minor-street through movement impedance factor
p''	Product of the probabilities of queue-free states of Rank 1 and Rank 2 vehicles
$p_{o,x}^*$	A factor indicating the probability there will be no queue in the shared lane for major-street Movements 1 and 4, where x is the particular movement being considered
P_{15}	Passenger volume during the peak 15 min
p_1	First parameter for percentile back of queue factor
p_2	Second parameter for percentile back of queue factor
p_3	Third parameter for percentile back of queue factor
P_a	1. Alighting passengers per bus through the busiest door during the peak 15 min, p (27). 2. Proportion of travelers preferring Option a (28).
P_{adj}	Adjusted probability of degree of conflict
P_b	Boarding passengers per bus through the busiest door during the peak 15 min, p
$P_{b1} \dots P_{bn}$	Boarding passenger volume per transit vehicle for each route served by the waiting area during the peak 15 min, p
P_c	Maximum allowed passenger load per car, p

pc	Passenger car
P_d	1. Transit passenger volume through the busiest door during the peak 15 min, p (27). 2. Number of transit passengers experiencing delay, p (29).
$P[C_i]$	Probability of degree of conflict case C_i
PF	Progression adjustment factor
PF_2	Adjustment factor for the effects of progression in the first term queued vehicles
P_{FD}	An adjustment factor to compute v_{12} at diverge influence area
P_{FM}	An adjustment factor to compute v_{12} at merge influence area
PHD	Total person-hours of delay
PHF	Peak-hour factor
PHT	Person-hours of travel in corridor, veh-h
PHT_f	Person-hours of travel under free-flow condition, p-h
PHT_T	Person-hours traveled on transit, h
P_{HV}	Proportion of heavy vehicles
P_i	Proportion of the analysis period for major-street flow Regime i
$PkmT$	Person-kilometers of travel, person-km
P_L	Proportion of left-turning vehicles in the shared lane
P_{LT}	Proportion of left-turn volume in the lane group
P_{LTA}	Proportion of left protected green time to the total left green time
P_{LTo}	Proportion of left turns in opposing single-lane approach
P_m	Loading level, p/m
P_{ov}	Minimum phase time, s
$p_{o,x}$	Probability that conflicting movement x will operate in a queue-free state
P_R	Proportion of recreational vehicles in the traffic stream
P_{RT}	Proportion of right-turn volume in the lane group
P_{RTA}	Proportion of right protected green time to the total right green time
P_T	Proportion of trucks in the traffic stream; also can include buses (21)
P_{TC}	Proportion of all trucks in the traffic stream that use crawl speeds on a specific downgrade
P_{THO}	Proportion of through and right-turning vehicles in opposing single-lane approach
$PTSF$	Percent time-spent-following, %
$PTSF_c$	Percent time-spent-following for all segments combined, %
$PTSF_d$	Percent time-spent-following in the analysis direction, %
$PTSF_{pl}$	Percent time-spent-following for the entire segment including the passing lane, %
$PTSF_x$	Percent time-spent-following for Segment x , %
Q	1. Average number of vehicles in queue, veh (7, 16). 2. Queue left over at end of previous time period, veh (29). 3. Capacity of basic freeway segment, multilane highway, or two-lane highway, pc/h/ln (30).
q	Vehicle arrival rate throughout the cycle, veh/s
$Q\%$	Percentile back of queue, veh
Q'_p	Queue size at the end of the permitted green period adjusted with sneakers, veh
Q'_t	Vehicles arriving at the subject location during Time Slice t
Q_1	First term queued vehicles, veh
Q_2	Second term queued vehicles, veh
Q_{95}	95th-percentile queue at a two-way stop-controlled intersection, veh
Q_a	Queue at beginning of a green arrow, veh
q_a	Arrival rate, veh/s

pc— q_a

$Q_b - R_{po}$

Q_b	Initial queue at the start of the analysis period, veh
Q_{bL}	Lane group initial queue at the start of the analysis period per lane, veh
Q_f	Left-turn movement free queue or queue size at the end of the interval g_f , veh
Q_g	Flow departing from upstream signalized intersection during green phase
q_g	Green arrival time, veh/s
Q_{ga}	Queue size at the beginning of the protected green (green arrow) period, veh
QL	Queue length, km
Q_M	Maximum queue length, veh
Q_{ob}	Bicycle flow rate in the opposing direction, bicycles/h
Q_p	Queue size at the end of the permitted green period, veh
Q_Q	Average queue length while queue is present, veh
Q_q	Queue size at the end of the interval g_q , veh
Q_r	Residual queue or queue at the end of the effective green time, veh
q_r	Red arrival time, veh/s
qr_o	Opposing queue ratio, the proportion of opposing flow rate originating in opposing queues
Q_{sb}	Bicycle flow rate in the same direction, bicycles/h
Q_{sep}	Average queue length for the separate lane case for flared right-turn calculations, veh
Q_{SH}	Average queue length for the shared-lane case for flared right-turn calculations, veh
Q_t	Vehicles departing from an upstream signalized intersection during time slice t
Q_{tco}	Total time spent by pedestrians waiting to cross the minor street during one cycle, p-s
Q_{tdo}	Total time spent by pedestrians waiting to cross the major street during one cycle, p-s
Q_u	Queue at beginning of unsaturated green, veh
$Queue(0)$	Initial queue remaining from the preceding time period
R	1. Radius of corner curb, m (18). 2. Adjustment for ramps to compute capacity on freeway facilities, veh/h (22). 3. Weaving ratio; the ratio of the smaller weaving flow to total flow in the weaving segment (24). 4. Right-side movement at an interchange (26). 5. Segment traversal time, h (29). 6. Link traversal time, h (30). 7. Parameter (30).
r	1. Effective red time, s (7, 10, 16). 2. Segment rank used in algorithms to adjust for excess demand (29). 3. Ratio of off-peak demand to peak demand rate (30).
R_c	Link traversal time when demand equals capacity, h
R_d	Ratio of busiest door usage to average door usage
R_f	Segment free-flow traversal time, h
R_i	1. Ratio of desired to actual entering volume for Entry Leg i (10). 2. Red time, s (10).
r_i	Effective red time, s
R_j	Ratio of desired to actual exiting volume for Exit Leg j
R_{mi}	The minor-street red phase, or the Don't Walk phase for pedestrian signals, s
R_{mj}	The major-street red phase, or the Don't Walk phase for pedestrian signals, s
R_o	Link travel time at free-flow link speed, h
R_p	Platoon ratio
R_{po}	Platoon ratio for the opposing flow based on opposing arrival type

R_Q	Average queue storage ratio
r_q	Queue at the end of effective red time, veh
$R_{Q\%}$	Percentile queue storage ratio
RS	Reference sum flow rate, veh/h
RT	Right turn
$RTOR$	Right turn on red
S	1. Average travel speed, km/h (7). 2. Pedestrian speed, m/min (18). 3. Average passenger-car travel speed, km/h (21, 23). 4. Space mean speed of all vehicles in the weaving segment, km/h (24). 5. Space mean speed of the ramp influence area, km/h (25). 6. Mean segment speed, km/h (29). 7. Link speed, km/h (30).
s	1. Saturation flow rate, veh/h or veh/h/ln. 2. Estimated standard deviation for the sample (9). 3. Adjusted saturation flow per through lane, veh/h (15).
s	second
S_A	1. Average travel speed of through vehicles in the segment or the entire section, km/h (15). 2. Approach speed at a signalized intersection, km/h (16). 3. Average pedestrian travel speed, m/s (18).
S_{ats}	Bicycle travel speed, km/h
SB	Southbound approach or movement
S_b	Mean bicycle speed on the path, m/s
s_b	Saturation flow rate of the bicycle lane, bicycles/h
SC	Urban street class
S_f	1. Speed for a given flow rate, km/h (7). 2. Free-flow speed of train, km/h (27). 3. Segment free-flow speed, km/h (29).
S_{FF}	Free-flow speed of the freeway approaching the merge or diverge area, km/h
S_{FM}	Mean speed of traffic measured in the field, km/h
S_{FR}	The free-flow speed of the ramp at the point of the merge area, km/h
S_{FT}	Free-flow speed of transit on facility, km/h
S_i	1. Pedestrian walking speed over Segment i, m-s (18). 2. Bicycle running speed over Segment i, km/h (19). 3. Mean speed of Link i, km/h (30).
s_j	Saturation flow rate, veh/h
SL	Urban street section length, km
s_L	Lane group saturation flow rate, veh/h
s_j	Adjusted saturation flow rate per lane, veh/h
s_{LT}	Filter saturation flow rate of permitted left turns, veh/h/ln
SM	Speed margin (constant)
S_{max}	1. Maximum speed reached, m/s (11). 2. Maximum speed expected in a weaving segment, km/h (24).
S_{min}	Minimum speed expected in a weaving segment, km/h
s_N	Northbound approach service time to all-way stop-controlled intersection, s
S_{nw}	Space mean speed of nonweaving vehicles in the weaving segment, km/h
S_O	1. Space mean speed of vehicles traveling in outer lanes, km/h (25). 2. Base bus speed, km/h (27).
S_o	1. Optimum speed, km/h (7). 2. Link free-flow speed, km/h (30).
s_o	Base saturation flow rate, pc/h/ln
S_p	Average pedestrian speed, m/s; mean pedestrian speed on the path, m/s (18)
s_p	Protected phase departure rate, veh/s
S_{ped}	Pedestrian speed, m/min

$R_Q - S_{ped}$

S_{prog} —TL

S_{prog}	Platoon speed from upstream signalized intersection to two-way stop-controlled intersection, m/s
S_R	1. Space mean speed, km/h (7). 2. Space mean speed of vehicles within the ramp influence area, km/h (25).
s_s	Permitted phase departure rate, veh/s
S_T	1. Time mean speed, km/h (7). 2. Actual speed of transit on facility including all delays, km/h (29).
ST	Urban street section (or segment) travel time, s
S_t	1. Bus travel speed, km/h (27). 2. Train travel speed, km/h (27).
s_{TH}	Saturation flow rate of through traffic, veh/h/ln
s_W	1. Westbound approach service time to all-way stop-controlled intersection, s (17). 2. Space mean speed of weaving vehicles in the weaving segment, km/h (24).
T	1. Duration of analysis period, h. 2. Total crosswalk occupancy time, p-s (18). 3. Through movement (26). 4. Maximum number of trains per hour (27). 5. Duration of analysis subperiod, h (29). 6. The expected duration of the demand, h (30).
t	1. Duration of initial queue in the analysis period, h (16). 2. Total crossing time for pedestrians, s (18). 3. Mean trip time, min/p (29).
t'	Length of time during which dispersing platoon passes the subject two-way stop-controlled intersection
$t_{3,LT}$	Critical gap adjustment factor for intersection geometry (T-intersection)
t_a	1. Average travel time over a length of a highway segment, h (7). 2. Travel time from the upstream signalized intersection to the subject two-way stop-controlled intersection, s (17). 3. Passenger alighting time, s/p (27).
t_b	Passenger boarding time, s/p
t_{br}	Operator and braking system reaction time, s
T_c	Time to clear initial queue present at the start of analysis period, s
t_c	1. Single pedestrian critical gap, s (11, 18). 2. Vehicular critical gap time at a two-way stop-controlled intersection, s (17). 3. Clearance time between successive buses or trains, s (27).
$t_{c,base}$	Base critical gap, s
$t_{c,G}$	Critical gap adjustment for approach grade, s
$t_{c,HV}$	Critical gap adjustment for heavy vehicles, s
$t_{c,T}$	Critical gap adjustment for each part of a two-stage gap acceptance process
t_d	Dwell time, s
t_f	Follow-up time, or the time span between the departure of one vehicle from the minor street and the departure of the next vehicle, s
$t_{f,base}$	Base follow-up time, s
$t_{f,HV}$	Follow-up time adjustment for heavy vehicles, s
t_G	Group critical gap, s
TH	Through
T_i	Number of trips originating at Point i
t_i	1. Travel time of the <i>i</i> th vehicle to traverse the section, h (7). 2. Start-up lost time for <i>i</i> th vehicle, s (7).
T_{ij}	Number of trips going from Origin Point i to Destination Point j
T'_{ij}	Estimated number of trips between Origin Zone i and Destination Zone j (29)
T_j	Number of trips leaving Destination j
t_{jl}	Jerk limiting time, s
TL	Total intersection lost time, s

t_L	Lost time per phase or movement lost time, s
TLC	Total lateral clearance, m
t_o	Time duration the detector is occupied by a passing vehicle, s
t_{oc}	Door opening and closing time, s
t_{om}	Operating margin time, s
T_p	Number of person-trips using Point p
t_{pf}	Passenger flow time, s/p
$t_{p,i}$	Duration of the blocked period for either the through movement or the protected left-turn movement to a two-way stop-controlled intersection, s
t_Q	Time duration of queue, s
T_R	Total running time on all segments, in a defined urban street section, s
t_r	Running time, s
$t_{r,0}$	Base bus running time, min/km
$t_{r,1}$	Bus running time losses, min/km
TS	Available time-space, $m^2\cdot s$
T_s	Number of person-trips using Segment s
t_s	1. Service time, s (17). 2. Pedestrian start-up time, s (11, 18).
TS_c	Total time-space available for circulating pedestrians, $m^2\cdot s$
TS_E	Effective time-space, $m^2\cdot s$
t_{st}	Time to cover single-track section, s
TS_{tv}	Time-space occupied by turning vehicles, $m^2\cdot s$
TT	Urban street field travel time, s
T_t	Platoon travel time from upstream signalized intersection to subject two-way stop-controlled intersection, s
t_t	Total travel time, s
TT_{15}	Total travel time for all vehicles on the analysis segment during the peak 15-min period, veh-h
TT_x	Total travel time for Segment x, veh-h
$TWLTL$	Two-way left-turn lane
T_x	Number of person-trips using Segment x
U	Movement at an upstream intersection
u	Initial queue delay parameter
U_a	Utility function valued for Option a
U_j	Utility function valued for Option j
<i>Utility</i>	Measure of the traveler's perceived value of an alternative
V	Hourly volume, veh/h or veh/h/ln
v	1. Vehicular flow rate for peak 15-min period, veh/h or veh/h/ln. 2. Pedestrian unit flow rate, p/min/m (18). 3. Pedestrian volume on the subject roadway, p/15-min (18). 4. Total bicycle flow rate, both directions, bicycles/h (19). 5. Arrival flow rate at the downstream intersection, veh/h (26). 6. Demand rate for current time period (29).
v_5	Anticipated approach flow rate in Lane 5 of the freeway, pc/h
v_{12}	Flow rate entering Lanes 1 and 2 immediately upstream of the merge influence area or at the beginning of the deceleration lane in the diverge influence area, pc/h
V_{15}	Volume during the peak 15 min of the peak hour, veh/15-min
v_{15}	Peak 15-min pedestrian flow rate, p/15-min
$v(a)$	Counted volume for Segment a
$v'(a)$	Estimated volume for Segment a
v_A	Approach flow rate, veh/h
v_a	Approach flow rate at roundabouts, veh/h
V_b	Bicycle hourly volume, bicycles/h
v_b	1. Bicycle flow rate, bicycles/h (19). 2. Bus flow rate, buses/h (27).

t_L-v_b

V_{bic} — V_{nw}

V_{bic}	Approach bicycle volume, bicycles/h
V_{bicg}	Bicycle flow rate during the green interval for 1 h, bicycles/h
V_{bo}	Flow rate of bicycles in the opposing direction, bicycles/h
V_{bs}	Flow rate of bicycles in the subject direction, bicycles/h
v/c	Volume to capacity ratio
V_c	Circulating flow rate at roundabouts, veh/h
V_{CL}	Critical lane flow rate, veh/h
V_{co}	Number of pedestrians waiting to cross the minor street during one cycle, p/cycle
$V_{c,x}$	The conflicting flow rate for Movement x, that is, the total flow rate conflicting with Movement x, veh/h or p/h
V_D	Total flow rate on the downstream adjacent ramp from the subject ramp, pc/h
v_d	Passenger-car equivalent flow rate for the peak 15-min period in the analysis direction, pc/h
V_{do}	Number of pedestrians waiting to cross the major street during one cycle, p/cycle
veh	vehicle
V_{ep}	Flow rate in the separate lanes on minor street approach; used to compute capacity for flared right-turn approach
V_f	Observed flow rate for the period when field data were obtained, veh/h
V_F	Maximum total flow rate approaching a merge or diverge area on the freeway, pc/h or pc/h/ln
V_{F4eff}	Effective approaching flow rate for a four-lane freeway segment, pc/h
V_{FO}	Maximum total flow rate departing from a merge or diverge area on the freeway, pc/h
v_g	Unadjusted flow rate for the lane group, veh/h
v_{g1}	Unadjusted flow rate on the single lane in the lane group with the highest volume
VHD	Vehicle-hours of delay, h
VHT	Vehicle-hours of travel, veh-h
v_j	1. Adjusted flow rate for Lane Group i, veh/h (10). 2. Incoming pedestrian volume for the subject crosswalk, p/cycle (18). 3. Flow rate for Movement i under base conditions during peak 15 min, pc/h (25). 4. Demand flow rate for Lane Group i, veh/h (26).
V_{iq}	Total vehicles in queue for field control delay study
$VkmT$	Vehicle-kilometers of travel, veh-km
$VkmT_{15}$	Total travel on the analysis segment during the peak 15-min period, veh-km
$VkmT_{60}$	Total travel on the analysis segment during the peak hour, veh-km
$VkmT_x$	Total travel for Segment x, veh-km
V_L	Left-turn movement volume, veh/h
v_L	1. Lane group flow rate per lane, veh/h (16). 2. Minor left-turn flow rate, veh/h (17).
v_l	Lane group flow rate including initial queue, veh/h
V_{LS}	Left-turn movement maximum sneakers, veh
V_{LT}	Left volume per lane, veh/h/ln
v_{LT}	Adjusted left-turn flow rate, veh/h
v_m	Maximum flow rate, veh/h or veh/h/ln
V_n	Desired speed for Vehicle n
$v_n(t)$	Speed of nth vehicle at time t
V_{n-1}	Vehicle ahead of subject Vehicle n
V_{nw}	Total nonweaving flow in the weaving segment, pc/h

V_o	Demand volume for the full peak hour in the opposing direction of travel, veh/h	$V_o - W_E$
v_o	1. Opposing flow rate for permitted left turns, veh/h (16). 2. Outgoing pedestrian volume for the subject crosswalk, p/cycle (18). 3. Flow rate of bicycles in the opposing direction, bicycles/h (19). 4. Passenger-car equivalent flow rate for the peak 15-min period in the opposing direction of travel, pc/h (20). 5. Sum of approach volumes on nonsubject approaches, veh/h (30).	
v_{o1}	Larger of the two outer, or nonweaving, flows in the weaving segment, pc/h	
v_{o2}	Smaller of the two outer, or nonweaving, flows in the weaving segment, pc/h	
V_{OA}	Average per lane demand related to flow in the outer lanes, pc/h/ln	
V_{oe}	Effective opposing flow rate, veh/h	
V_{olc}	Adjusted opposing flow rate per lane per cycle, veh	
V_p	1. Pedestrian flow rate, p/s (11). 2. Pedestrian unit flow rate, p/min/m (18). 3. Peak 15-min passenger-car equivalent flow rate, pc/h/ln (20, 21, 23, 24, 25).	
V_{ped}	1. Unit flow rate, p/min/m (11). 2. Conflicting pedestrian flow rate, p/h (16).	
V_{pedg}	Pedestrian flow rate during the green interval for 1 h, p/h	
V_{po}	Flow rate of pedestrians in the opposing direction, p/h	
V_{prog}	Progressed flow rate from upstream signalized intersection to compute the effect of upstream signals	
V_{ps}	Flow rate of pedestrians in the subject direction, p/h	
V_R	Right-turn movement volume, veh/h	
VR	Volume ratio; the ratio of weaving to total flow in the weaving segment	
V_R	Total ramp flow rate, pc/h	
V_r	Volume of right turns at a specific intersection, veh/h	
V_{R12}	Maximum total flow entering the ramp influence area, pc/h	
V_{RT}	Right-turn volume per lane, veh/h/ln	
V_s	Flow rate of bicycles in the subject direction, bicycles/h	
V_{SH}	Flow rate in the shared lanes; used to compute capacity for flared right-turn approach	
V_{stop}	Stopped vehicles count for field control delay study	
V_T	Through movement volume, veh/h	
V_{TH}	Through volume per lane, veh/h/ln	
V_{tot}	1. Total approach volume, veh/h (10). 2. Total vehicles arriving for field control delay study (16).	
v_{tot}	Total number of circulating pedestrians in one cycle, p/cycle	
v_U	Total flow rate on the adjacent upstream ramp from the subject ramp, pc/h	
v_w	Total weaving flow in the weaving segment, pc/h	
v_{w1}	Larger of the two weaving flows in the weaving segment, pc/h	
v_{w2}	Smaller of the two weaving flows in the weaving segment, pc/h	
v_x	The flow rate for Movement x for vehicular flows and pedestrian flows, veh/h or p/h	
W	1. Average lane width, m. 2. Effective width of sidewalk, m (18). 2. West intersection (26).	
w	Lane width, m	
$WALK + FDW$	Effective pedestrian green time at a signalized intersection, s	
WB	Westbound approach or movement	
WDW	Pedestrian Walk plus flashing Don't Walk, s	
W_E	Effective walkway width, m	

$W_{nw} - \phi$

W_{nw}	Weaving intensity factor for prediction of nonweaving speed
W_o	Sum of widths and shy distances from obstructions on the walkway, m
W_T	Total walkway width, m
W_w	Weaving intensity factor for prediction of weaving speed
X	Volume to capacity ratio
x	1. Mean arrival rate, veh/h (7). 2. Degree of utilization, or $vh_d/3600$ (17).
\bar{x}	The mean value of the observation
X_b	Volume to capacity ratio of bicycle lanes (also termed degree of saturation)
X_c	Critical volume to capacity ratio for the intersection
X_{cm}	Critical volume to capacity ratio for planning procedure
x_i	The i th observation of the value
$x_n(t)$	Position of n th vehicle at time t
X_{perm}	Permitted phase volume to capacity ratio for leading or lagging left-turn movement with protected-plus-permitted phase
X_{prot}	Protected phase volume to capacity ratio for leading or lagging left-turn movement with protected-plus-permitted phase
X_u	Degree of saturation at upstream intersection
Y	Yellow plus all-red change and clearance interval (intergreen), s
y	Mean service rate, veh/h
Y_c	Sum of flow ratios for critical lane groups
Y_i	Change and clearance interval time, s
z	Subject approach volume divided by 1000, veh/h/1000
Z_a	The area under one tail of the normal curve beyond the acceptable levels of probability that a queue will form at a bus stop (27), or failure rate (29)
α	1. Platoon dispersion factor (17). 2. Constant to adjust degree of conflict case probability to account for interdependence of headways (17).
β	Dispersion factor, or $(1 + \alpha)^{-1}$
Δ	Minimum arrival (intrabunch) headway, s
Δt	Time interval or duration of one time step
Δv	Amount of change in speed
$\delta t / \delta x$	First derivative of travel time with respect to volume to capacity ratio
θ_{ij}	Offset between through movements at Intersections i and j at interchange ramp terminal, s
λ	Parameter for computing green extension time, veh/s
λ_x	Arrival rate for approach or Lane x
ξ	Maximum desirable error in the estimate of the mean
ϕ	Proportion of free (unbunched) vehicles

CHAPTER 7

TRAFFIC FLOW PARAMETERS

CONTENTS

I. INTRODUCTION 7-1

II. UNINTERRUPTED FLOW 7-1

 Volume and Flow Rate 7-1

 Speed 7-2

 Density 7-4

 Headway and Spacing 7-4

 Relationships Among Basic Parameters 7-5

III. INTERRUPTED FLOW 7-6

 Signal Control 7-7

 Stop- or Yield-Controlled Intersections 7-8

 Speed 7-9

 Delay 7-9

 Saturation Flow Rate and Lost Time 7-10

 Queuing 7-11

IV. REFERENCES 7-13

EXHIBITS

Exhibit 7-1. Typical Relationship Between Time Mean and Space Mean Speed 7-3

Exhibit 7-2. Generalized Relationships Among Speed, Density, and Flow Rate
on Uninterrupted-Flow Facilities 7-5

Exhibit 7-3. Conditions at Traffic Interruption in an Approach Lane of a
Signalized Intersection 7-7

Exhibit 7-4. Concept of Saturation Flow Rate and Lost Time 7-8

Exhibit 7-5. Queuing Diagram for Signalized Intersection 7-12

I. INTRODUCTION

Three basic variables—volume or flow rate, speed, and density—can be used to describe traffic on any roadway. In this manual, volume or traffic flow is a parameter common to both uninterrupted- and interrupted-flow facilities, but speed and density apply primarily to uninterrupted flow. Some parameters related to flow rate, such as spacing and headway, also are used for both types of facilities; other parameters, such as saturation flow or gap, are specific to interrupted flow.

II. UNINTERRUPTED FLOW

VOLUME AND FLOW RATE

Volume and flow rate are two measures that quantify the amount of traffic passing a point on a lane or roadway during a given time interval. These terms are defined as follows:

- Volume—the total number of vehicles that pass over a given point or section of a lane or roadway during a given time interval; volumes can be expressed in terms of annual, daily, hourly, or subhourly periods.
- Flow rate—the equivalent hourly rate at which vehicles pass over a given point or section of a lane or roadway during a given time interval of less than 1 h, usually 15 min. Volume and flow are variables that quantify demand, that is, the number of vehicle occupants or drivers (usually expressed as the number of vehicles) who desire to use a given facility during a specific time period. Congestion can influence demand, and observed volumes sometimes reflect capacity constraints rather than true demand.

The distinction between volume and flow rate is important. Volume is the number of vehicles observed or predicted to pass a point during a time interval. Flow rate represents the number of vehicles passing a point during a time interval less than 1 h, but expressed as an equivalent hourly rate. A flow rate is the number of vehicles observed in a subhourly period, divided by the time (in hours) of the observation. For example, a volume of 100 vehicles observed in a 15-min period implies a flow rate of 100 veh/0.25 h or 400 veh/h.

Volume and flow rate can be illustrated by the volumes observed for four consecutive 15-min periods. The four counts are 1,000, 1,200, 1,100, and 1,000. The total volume for the hour is the sum of these counts, or 4,300 veh. The flow rate, however, varies for each 15-min period. During the 15-min period of maximum flow, the flow rate is 1,200 veh/0.25 h, or 4,800 veh/h. Note that 4,800 vehicles do not pass the observation point during the study hour, but they do pass at that rate for 15 min.

Consideration of peak flow rates is important in capacity analysis. If the capacity of the segment of highway studied is 4,500 veh/h, capacity would be exceeded during the peak 15-min period of flow, when vehicles arrive at a rate of 4,800 veh/h, even though volume is less than capacity during the full hour. This is a serious problem, because dissipating a breakdown of capacity can extend congestion for up to several hours.

Peak flow rates and hourly volumes produce the peak-hour factor (PHF), the ratio of total hourly volume to the peak flow rate within the hour, computed by Equation 7-1:

$$PHF = \frac{\text{Hourly volume}}{\text{Peak flow rate (within the hour)}} \quad (7-1)$$

If 15-min periods are used, the PHF may be computed by Equation 7-2:

$$PHF = \frac{V}{4 \times V_{15}} \quad (7-2)$$

Basic concepts for uninterrupted-flow facilities: volume, flow rate, speed, density, headway, and capacity

Calculating a peak-hour factor

where

- PHF = peak-hour factor,
- V = hourly volume (veh/h), and
- V_{15} = volume during the peak 15 min of the peak hour (veh/15 min).

When the PHF is known, it can convert a peak-hour volume to a peak flow rate, as in Equation 7-3:

$$v = \frac{V}{PHF} \quad (7-3)$$

where

- v = flow rate for a peak 15-min period (veh/h),
- V = peak-hour volume (veh/h), and
- PHF = peak-hour factor.

Equation 7-3 does not need to be used to estimate peak flow rates if traffic counts are available; however, the chosen count interval must identify the maximum 15-min flow period. The rate then can be computed directly as 4 times the maximum 15-min count. When flow rates in terms of vehicles are known, a conversion to a flow rate in terms of passenger car equivalents (pce) can be computed using the PHF and the heavy vehicle factor.

SPEED

Although traffic volumes provide a method of quantifying capacity values, speed (or its reciprocal of travel time) is an important measure of the quality of the traffic service provided to the motorist. It is an important measure of effectiveness defining levels of service for many types of facilities, such as rural two-lane highways, urban streets, freeway weaving segments, and others.

Speed is defined as a rate of motion expressed as distance per unit of time, generally as kilometers per hour (km/h). In characterizing the speed of a traffic stream, a representative value must be used, because a broad distribution of individual speeds is observable in the traffic stream. In this manual, average travel speed is used as the speed measure because it is easily computed from observation of individual vehicles within the traffic stream and is the most statistically relevant measure in relationships with other variables. Average travel speed is computed by dividing the length of the highway, street section, or segment under consideration by the average travel time of the vehicles traversing it. If travel times $t_1, t_2, t_3, \dots, t_n$ (in hours) are measured for n vehicles traversing a segment of length L , the average travel speed is computed using Equation 7-4.

$$S = \frac{nL}{\sum_{i=1}^n t_i} = \frac{L}{\frac{1}{n} \sum_{i=1}^n t_i} = \frac{L}{t_a} \quad (7-4)$$

where

- S = average travel speed (km/h),
- L = length of the highway segment (km),
- t_i = travel time of the i th vehicle to traverse the section (h),
- n = number of travel times observed, and
- $t_a = \frac{1}{n} \sum_{i=1}^n t_i$ = average travel time over L (h).

The travel times in this computation include stopped delays due to fixed interruptions or traffic congestion. They are total travel times to traverse the defined roadway length.

Several different speed parameters can be applied to a traffic stream. These include the following:

Speed parameters

Average running speed—A traffic stream measure based on the observation of vehicle travel times traversing a section of highway of known length. It is the length of the segment divided by the average running time of vehicles to traverse the segment. Running time includes only time that vehicles are in motion.

Average travel speed—A traffic stream measure based on travel time observed on a known length of highway. It is the length of the segment divided by the average travel time of vehicles traversing the segment, including all stopped delay times. It is also a space mean speed.

Space mean speed—A statistical term denoting an average speed based on the average travel time of vehicles to traverse a segment of roadway. It is called a space mean speed because the average travel time weights the average to the time each vehicle spends in the defined roadway segment or space.

Time mean speed—The arithmetic average of speeds of vehicles observed passing a point on a highway; also referred to as the average spot speed. The individual speeds of vehicles passing a point are recorded and averaged arithmetically.

Free-flow speed—The average speed of vehicles on a given facility, measured under low-volume conditions, when drivers tend to drive at their desired speed and are not constrained by control delay.

For most of the procedures using speed as a measure of effectiveness in this manual, average travel speed is the defining parameter. For uninterrupted-flow facilities not operating at level of service (LOS) F, the average travel speed is equal to the average running speed.

Exhibit 7-1 shows a typical relationship between time mean and space mean speeds. Space mean speed is always less than time mean speed, but the difference decreases as the absolute value of speed increases. Based on the statistical analysis of observed data, this relationship is useful because time mean speeds often are easier to measure in the field than space mean speeds.

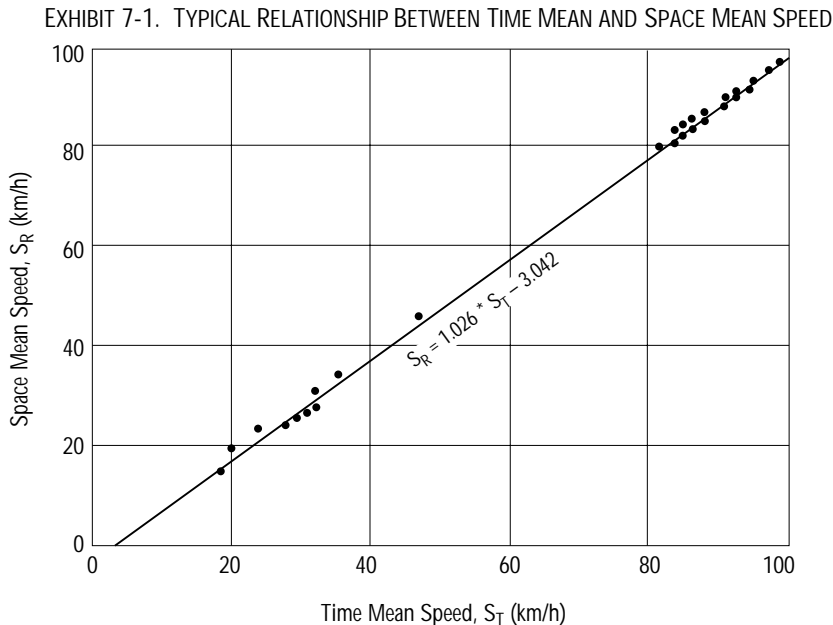

Source: Drake et al. (1).

It is possible to calculate both time mean and space mean speeds from a sample of individual vehicle speeds. For example, three vehicles are recorded with speeds of 40, 60, and 80 km/h. The time to traverse 1 km is 1.5 min, 1.0 min, and 0.75 min, respectively. The time mean speed is 60 km/h, calculated as $(40 + 60 + 80)/3$. The space mean speed is 55.4 km/h, calculated as $(60)[3 \div (1.5 + 1.0 + 0.75)]$.

- Average running speed
- Average travel speed
- Space mean speed
- Time mean speed
- Free-flow speed

For capacity analysis, speeds are best measured by observing travel times over a known length of highway. For uninterrupted-flow facilities operating in the range of stable flow, the length may be as short as 50 to 100 m for ease of observation.

As measures of effectiveness, speed criteria must recognize driver expectations and roadway function. For example, a driver expects a higher speed on a freeway than on an urban street. Lower free-flow speeds are tolerable on a roadway with more severe horizontal and vertical alignment, since drivers are not comfortable driving at high speeds. LOS criteria reflect these expectations.

DENSITY

Density is the number of vehicles (or pedestrians) occupying a given length of a lane or roadway at a particular instant. For the computations in this manual, density is averaged over time and is usually expressed as vehicles per kilometer (veh/km) or passenger cars per kilometer (pc/km).

Direct measurement of density in the field is difficult, requiring a vantage point for photographing, videotaping, or observing significant lengths of highway. Density can be computed, however, from the average travel speed and flow rate, which are measured more easily. Equation 7-5 is used for undersaturated traffic conditions.

$$D = \frac{v}{S} \quad (7-5)$$

where

- v = flow rate (veh/h),
- S = average travel speed (km/h), and
- D = density (veh/km).

A highway segment with a rate of flow of 1,000 veh/h and an average travel speed of 50 km/h would have a density of

$$D = \frac{1000 \text{ veh/h}}{50 \text{ km/h}} = 20 \text{ veh/km}$$

Density is a critical parameter for uninterrupted flow facilities because it characterizes the quality of traffic operations. It describes the proximity of vehicles to one another and reflects the freedom to maneuver within the traffic stream.

Roadway occupancy is frequently used as a surrogate for density in control systems because it is easier to measure. Occupancy in space is the proportion of roadway length covered by vehicles, and occupancy in time identifies the proportion of time a roadway cross section is occupied by vehicles.

HEADWAY AND SPACING

Spacing is the distance between successive vehicles in a traffic stream, measured from the same point on each vehicle (e.g., front bumper, rear axle, etc.). Headway is the time between successive vehicles as they pass a point on a lane or roadway, also measured from the same point on each vehicle.

These characteristics are microscopic, since they relate to individual pairs of vehicles within the traffic stream. Within any traffic stream, both the spacing and the headway of individual vehicles are distributed over a range of values, generally related to the speed of the traffic stream and prevailing conditions. In the aggregate, these microscopic parameters relate to the macroscopic flow parameters of density and flow rate.

Spacing is a distance, measured in meters. It can be determined directly by measuring the distance between common points on successive vehicles at a particular instant. This generally requires complex aerial photographic techniques, so that spacing usually derives from other direct measurements. Headway, in contrast, can be easily measured with stopwatch observations as vehicles pass a point on the roadway.

Computing density

The average vehicle spacing in a traffic stream is directly related to the density of the traffic stream, as determined by Equation 7-6.

$$\text{Density (veh/km)} = \frac{1000}{\text{spacing (m/veh)}} \quad (7-6)$$

The relationship between average spacing and average headway in a traffic stream depends on speed, as indicated in Equation 7-7.

$$\text{Headway (s/veh)} = \frac{\text{spacing (m/veh)}}{\text{speed (m/s)}} \quad (7-7)$$

This relationship also holds for individual headways and spacings between pairs of vehicles. The speed is that of the second vehicle in a pair of vehicles. Flow rate is related to the average headway of the traffic stream with Equation 7-8.

$$\text{Flow rate (veh/h)} = \frac{3600}{\text{headway (s/veh)}} \quad (7-8)$$

Relationships among density, speed and flow rate, and headway and spacing

RELATIONSHIPS AMONG BASIC PARAMETERS

Equation 7-5 cites the basic relationship among the three parameters, describing an uninterrupted traffic stream. Although the equation $v = S * D$ algebraically allows for a given flow rate to occur in an infinite number of combinations of speed and density, there are additional relationships restricting the variety of flow conditions at a location.

Exhibit 7-2 shows a generalized representation of these relationships, which are the basis for the capacity analysis of uninterrupted-flow facilities. The flow-density function is placed directly below the speed-density relationship because of their common horizontal scales, and the speed-flow function is placed next to the speed-density relationship because of their common vertical scales. Speed is space mean speed.

EXHIBIT 7-2. GENERALIZED RELATIONSHIPS AMONG SPEED, DENSITY, AND FLOW RATE ON UNINTERRUPTED-FLOW FACILITIES

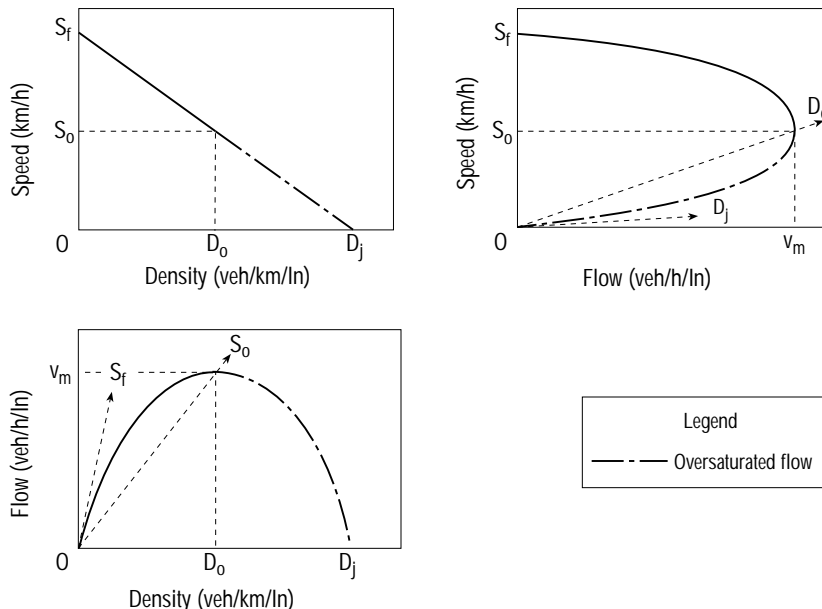

Source: Adapted from May (2).

Illustration of speed-density, flow-density, and speed-flow relationships

The form of these functions depends on the prevailing traffic and roadway conditions on the segment under study and on its length in determining density. Although the diagrams in Exhibit 7-2 show continuous curves, it is unlikely that the full range of the functions would appear at any particular location. Survey data usually show discontinuities, with part of these curves not present (2).

The curves of Exhibit 7-2 illustrate several significant points. First, a zero flow rate occurs under two different conditions. One is when there are no vehicles on the facility—density is zero, and flow rate is zero. Speed is theoretical for this condition and would be selected by the first driver (presumably at a high value). This speed is represented by S_f in the graphs.

The second is when density becomes so high that all vehicles must stop—the speed is zero, and the flow rate is zero, because there is no movement and vehicles cannot pass a point on the roadway. The density at which all movement stops is called jam density, denoted by D_j in the diagrams.

Between these two extreme points, the dynamics of traffic flow produce a maximizing effect. As flow increases from zero, density also increases, since more vehicles are on the roadway. When this happens, speed declines because of the interaction of vehicles. This decline is negligible at low and medium densities and flow rates. As density increases, these generalized curves suggest that speed decreases significantly before capacity is achieved. Capacity is reached when the product of density and speed results in the maximum flow rate. This condition is shown as optimum speed S_o (often called critical speed), optimum density D_o (sometimes referred to as critical density), and maximum flow v_m .

The slope of any ray line drawn from the origin of the speed-flow curve to any point on the curve represents density, based on Equation 7-5. Similarly, a ray line in the flow-density graph represents speed. As examples, Exhibit 7-2 shows the average free-flow speed and speed at capacity, as well as optimum and jam densities. The three diagrams are redundant, since if any one relationship is known, the other two are uniquely defined. The speed-density function is used mostly for theoretical work; the other two are used in this manual to define LOS.

As shown in Exhibit 7-2, any flow rate other than capacity can occur under two different conditions, one with a high speed and low density and the other with high density and low speed. The high-density, low-speed side of the curves represents oversaturated flow. Sudden changes can occur in the state of traffic (i.e., in speed, density, and flow rate). LOS A through E are defined on the low-density, high-speed side of the curves, with the maximum-flow boundary of LOS E placed at capacity; by contrast, LOS F, which describes oversaturated and queue discharge traffic, is represented by the high-density, low-speed part of the functions.

III. INTERRUPTED FLOW

Interrupted flow is more complex than uninterrupted flow because of the time dimension involved in allocating space to conflicting traffic streams. On an interrupted-flow facility, flow usually is dominated by points of fixed operation, such as traffic signals and stop signs. These controls have different impacts on overall flow.

The operational state of traffic at an interrupted traffic-flow facility is defined by the following measures:

- Volume and flow rate,
- Saturation flow and departure headways,
- Control variables (stop or signal control),
- Gaps available in the conflicting traffic streams, and
- Delay.

The discussion of volume and flow rate in the first part of this chapter also is applicable to interrupted-flow facilities. An important additional point is the screenline at which the traffic volume or flow rate is surveyed. Traditional intersection traffic counts yield only the number of vehicles that have departed the intersection. The maximum flow is

Basic concepts for interrupted-flow facilities: intersection control, saturation flow rate, lost time, and queuing

therefore limited to the capacity of the facility. When demand exceeds capacity and a queue is growing, it is advisable to survey traffic upstream, before the congestion.

SIGNAL CONTROL

The most significant source of fixed interruptions on an interrupted-flow facility is the traffic signal. Traffic signals periodically halt flow in each movement or set of movements. Movement on a given set of lanes is possible only for a portion of the total time, because the signal prohibits movement during some periods. Only the time during which the signal is effectively green is available for movement. For example, if one set of lanes at a signalized intersection receives a 30-s effective green time out of a 90-s total cycle, only 30/90 or 1/3 of total time is available for movement on the subject lanes. Thus, only 20 minutes of each hour are available for flow on the lanes. If the lanes can accommodate a maximum flow rate of 1,500 veh/h with the signal green for a full hour, they could accommodate a total rate of flow of only 500 veh/h, since only one-third of each hour is available as green.

Because signal timings are subject to change, it is convenient to express capacities and service flow rates for signalized intersections in terms of vehicles per hour (veh/h). In the previous example, the maximum flow rate is 1,500 veh/h. This can be converted to a real-time value by multiplying it by the ratio of effective green time to the cycle length for the signal.

When the signal turns green, the dynamics of starting a stopped queue of vehicles must be considered. Exhibit 7-3 shows a queue of vehicles stopped at a signal. When the signal turns green, the queue begins to move. The headway between vehicles can be observed as the vehicles cross the stop line of the intersection. The first headway would be the elapsed time, in seconds, between the initiation of the green and the crossing of the front wheels of the first vehicle over the stop line. The second headway would be the elapsed time between the crossing of front wheels of the first and of the second vehicles over the stop line. Subsequent headways are measured similarly.

EXHIBIT 7-3. CONDITIONS AT TRAFFIC INTERRUPTION IN AN APPROACH LANE OF A SIGNALIZED INTERSECTION

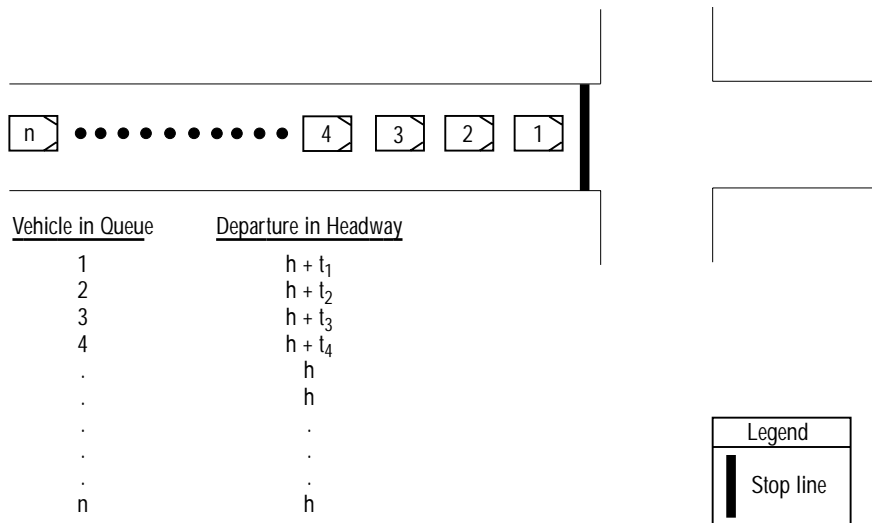

The driver of the first vehicle in the queue must observe the signal change to green and react to the change by releasing the brake and accelerating through the intersection. The first headway will be comparatively long, as a result. The second vehicle in the queue follows a similar process, except that the reaction and acceleration period can occur while the first vehicle is beginning to move. The second vehicle will be moving

Impact of signal control on maximum flow rate

Determining average headway

faster than the first as it crosses the stop line, because it has length in which to accelerate. Its headway will generally be less than that of the first vehicle. The third and fourth vehicles follow a similar procedure, each achieving a slightly lower headway than the preceding vehicle. After four vehicles, the effect of the start-up reaction and acceleration has dissipated. Successive vehicles then move past the stop line at a steady speed until the last vehicle in the original queue has passed. The headway for these vehicles will be relatively constant.

In Exhibit 7-3, this constant average headway, denoted as h , is achieved after four vehicles. The headways for the first four vehicles are, on the average, greater than h and are expressed as $h + t_i$, where t_i is the incremental headway for the i th vehicle due to the start-up reaction and acceleration. As i increases from 1 to 4, t_i decreases.

Exhibit 7-4 shows a conceptual plot of headways. In this manual, for practical reasons, the fifth vehicle following the beginning of a green is used as the starting point for saturation flow measurements.

EXHIBIT 7-4. CONCEPT OF SATURATION FLOW RATE AND LOST TIME

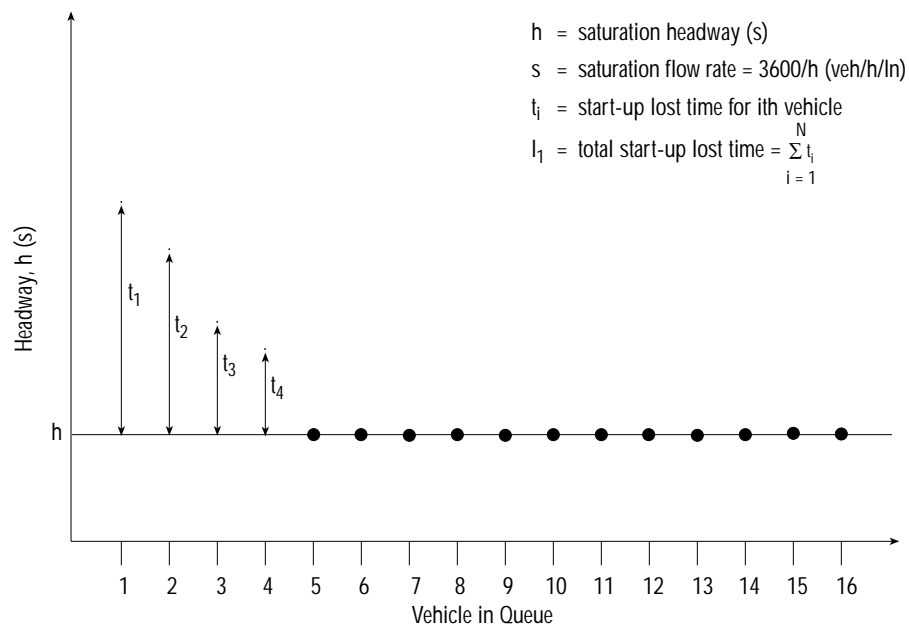

The value h represents the saturation headway, estimated as the constant average headway between vehicles after the fourth vehicle in the queue and continuing until the last vehicle that was in the queue at the beginning of the green has cleared the intersection. The saturation headway is the amount of time that a vehicle in the stopped queue takes to pass through a signalized intersection on the green signal, assuming that there is a continuous queue of vehicles moving through the intersection.

In this manual, the definition of saturation headway differs for interrupted-flow and uninterrupted-flow facilities. For interrupted flow, headway represents the time between the passage of the front axle of one vehicle and of the front axle of the next vehicle over a given cross section of the roadway; for uninterrupted-flow facilities, the vehicle reference points usually are the front bumpers of the vehicles.

STOP- OR YIELD-CONTROLLED INTERSECTIONS

The driver on a minor street or turning left from the major street of a two-way stop-controlled intersection faces a specific task: selecting a gap in the priority flow through which to execute the desired movement. The term gap refers to the space between the

vehicles on the roadway that has the right-of-way at an unsignalized intersection. Gap acceptance describes the completion of a vehicle's movement into a gap.

The capacity of a minor street approach depends on two factors:

- The distribution of available gaps in the major-street traffic stream, and
- The gap sizes required by minor-street drivers to execute their desired movements.

The distribution of available gaps in the major-street traffic stream depends on the total volume on the street, its directional distribution, the number of lanes on the major street, and the degree and type of platooning in the traffic stream. The gap sizes required by the minor-street drivers depend on the type of maneuver (left, through, right), the number of lanes on the major street, the speed of major-street traffic, sight distances, the length of time the minor-street vehicle has been waiting, and driver characteristics (eyesight, reaction time, age, etc.). The critical gap is the minimum time interval between the front bumpers of two successive vehicles in the major traffic stream that will allow the entry of one minor-street vehicle. When more than one minor-street vehicle uses one major-street gap, the time headway between the two minor-street vehicles is called follow-up time. In general, the follow-up time is shorter than the critical gap.

Roundabouts operate similarly to two-way stop-controlled intersections. In roundabouts, however, entering drivers scan only one stream of traffic—the circulating stream—for an acceptable gap.

At an all-way stop-controlled intersection, all drivers must come to a complete stop. The decision to proceed is based in part on the rules of the road, which suggest that the driver on the right has the right-of-way; it also is a function of the traffic condition on the other approaches. The departure headway for the subject approach is defined as the time between the departure of one vehicle and that of the next behind it. A departure headway is considered a saturation headway if the second vehicle stops behind the first at the stop line. If there is traffic on one approach only, vehicles can depart as rapidly as the drivers can safely accelerate into and clear the intersection. If traffic is present on other approaches, the saturation headway on the subject approach will increase, depending on the degree of conflict between vehicles.

As at signalized intersections, the front axles of two consecutive vehicles are the reference points for determining the saturation headways of the vehicles departing from the stop line of two-way and all-way stop-controlled intersection approaches. In measuring the unobstructed flow of vehicles on the major roadway at a two-way stop-controlled intersection, the reference points normally are the front bumpers.

SPEED

For interrupted-flow conditions, delay rather than speed is the primary measure of operations. However, speed measures similar to those for uninterrupted flow are helpful in determining the added travel time due to deceleration, movement in queues, and acceleration of vehicles passing through an intersection.

DELAY

Delay is a critical performance measure on interrupted-flow facilities. There are several types of delay, but in this manual, control delay is the principal service measure for evaluating LOS at signalized and unsignalized intersections. Although the definition of control delay is the same for signalized and unsignalized intersections, its application, including LOS threshold values, differs.

Control delay involves movements at slower speeds and stops on intersection approaches, as vehicles move up in the queue or slow down upstream of an intersection. Drivers frequently reduce speed when a downstream signal is red or there is a queue at the downstream intersection approach. Control delay requires the determination of a realistic average speed for each roadway segment. Any estimate of the average travel speed on urban streets implies the effects of control delay.

Critical gap and gap acceptance

Control delay

Computing saturation flow rate and lost time

At two-way stop-controlled and all-way stop-controlled intersections, control delay is the total elapsed time from a vehicle joining the queue until its departure from the stopped position at the head of the queue. The control delay also includes the time required to decelerate to a stop and to accelerate to the free-flow speed.

SATURATION FLOW RATE AND LOST TIME

Saturation flow rate is defined as the flow rate per lane at which vehicles can pass through a signalized intersection. By definition, it is computed by Equation 7-9:

$$s = \frac{3600}{h} \tag{7-9}$$

where

- s = saturation flow rate (veh/h), and
- h = saturation headway (s).

The saturation flow rate represents the number of vehicles per hour per lane that can pass through a signalized intersection if the green signal was available for the full hour, the flow of vehicles was never halted, and there were no large headways.

Each time a flow is stopped, it must start again, with the first four vehicles experiencing the start-up reaction and acceleration headways shown in Exhibit 7-3. In this exhibit, the first four vehicles in the queue encounter headways longer than the saturation headway, h. The increments, t_i , are called start-up lost times. The total start-up lost time for the vehicles is the sum of the increments, computed using Equation 7-10.

$$l_1 = \sum_{i=1}^N t_i \tag{7-10}$$

where

- l_1 = total start-up lost time (s),
- t_i = lost time for i th vehicle in queue (s), and
- N = last vehicle in queue.

Each stop of a stream of vehicles is another source of lost time. When one stream of vehicles stops, safety requires some clearance time before a conflicting stream of traffic is allowed to enter the intersection. This interval when no vehicles use the intersection is called clearance lost time, l_2 .

In practice, signal cycles provide for this clearance through change intervals, which can include yellow or all-red indications or both. Drivers generally cannot observe this entire interval but can use the intersection during some portion of it. The clearance lost time, l_2 , is the portion of this change interval not used by drivers.

The relationship between saturation flow rate and lost times is a critical one. For any given lane or movement, vehicles use the intersection at the saturation flow rate for a period equal to the available green time plus the change interval minus the start-up and clearance lost times. Because lost time is experienced with each start and stop of a movement, the total amount of time lost over an hour is related to the signal timing. For instance, if a signal has a 60-s cycle length, it will start and stop each movement 60 times per hour, and the total lost time per movement will be $60(l_1 + l_2)$.

Lost time affects capacity and delay. It might appear that the capacity of an intersection would increase with increased cycle length. But this is offset somewhat by the observation that the saturation headway, h, can increase if the length of a continuous green indication increases. Other intersection features, such as turning lanes, also can offset the reduction in capacity due to short cycles. Longer cycle lengths increase the number of vehicles in the queues and can cause the left-turn lane to overflow, reducing capacity by blocking the through-lanes.

As cycle length is increased, the control delay per vehicle also tends to increase, assuming that capacity is adequate. Delay, however, is a complex variable affected by many other variables besides cycle length.

QUEUING

When demand exceeds capacity at an approach to a signalized intersection at the start of an effective green period, a queue forms (2). Because of the arrival of vehicles during the red phases, some vehicles might not clear the intersection during the given green phase. A queue also forms when arrivals wait at a service area. The service can be the arrival of an accepted gap in a major-street traffic stream, the payment of tolls at a toll booth or of parking fees at a parking garage, and so forth. Back of queue refers to the number of vehicles queued at an approach to a signalized intersection due to the arrival patterns of vehicles and to vehicles unable to clear the intersection during a given green phase (i.e., overflow). Most queuing theory relates to undersaturated conditions.

To predict the characteristics of a queuing system mathematically, it is necessary to specify the following system characteristics and parameters (3):

- Arrival pattern characteristics, including the average rate of arrival and the statistical distribution of time between arrivals;
- Service facility characteristics, including service-time average rates and the distribution and number of customers that can be served simultaneously or the number of channels available; and
- Queue discipline characteristics, such as the means of selecting which customer is next.

In oversaturated queues, the arrival rate is higher than the service rate; in undersaturated queues, the arrival rate is less than the service rate. The length of an undersaturated queue can vary but will reach a steady state with the arrival of vehicles. By contrast, the length of an oversaturated queue never will reach a steady state but will increase with the arrival of vehicles.

An undersaturated queue at a signalized intersection is shown in Exhibit 7-5 (2). The exhibit assumes queuing on one approach with two signal phases. In each cycle, the arrival demand is less than the capacity of the approach; no vehicles wait longer than one cycle; and there is no overflow from one cycle to the next. Exhibit 7-5(a) specifies the arrival rate, v , in vehicles per hour and is constant for the study period. The service rate, s , has two states: zero when the signal is effectively red and up to saturation flow rate when the signal is effectively green. Note that the service rate is equal to the saturation flow rate only when there is a queue.

Exhibit 7-5(b) diagrams cumulative vehicles over time. The horizontal line, v , in Exhibit 7-5(a) becomes a solid sloping line in Exhibit 7-5(b), with the slope equal to the flow rate. Thus the arrival rate goes through the origin and slopes up to the right with a slope equal to the arrival rate. Transferring the service rate from Exhibit 7-5(a) to Exhibit 7-5(b) creates a different graph. During the red period, the service rate is zero, so the service is shown as a horizontal line in the lower diagram. At the start of the green period, a queue is present, and the service rate is equal to the saturation flow rate. This forms a series of triangles, with the cumulative arrival line as the top side of each triangle and the cumulative service line forming the other two sides.

Each triangle represents one cycle length and can be analyzed to calculate the time duration of the queue. It starts at the beginning of the red period and continues until the queue dissipates. Its value varies between the effective red time and the cycle length, and it is computed using Equation 7-11.

$$vt_Q = s(t_Q - r) \text{ or } t_Q = \frac{sr}{(s - v)} \quad (7-11)$$

where

$$t_Q = \text{time duration of queue (s),}$$

- v = mean arrival rate (veh/h),
- s = mean service rate (veh/h), and
- r = effective red time (s).

EXHIBIT 7-5. QUEUING DIAGRAM FOR SIGNALIZED INTERSECTION

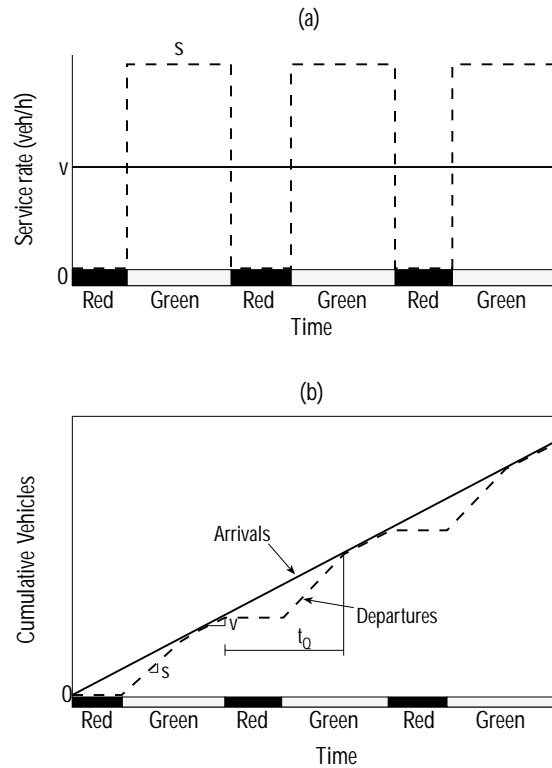

The queue length is represented by the vertical distance through the triangle. At the beginning of red, the queue length is zero and increases to its maximum value at the end of the red period. Then the queue length decreases until the arrival line intersects the service line, when the queue length equals zero. Three queue lengths can be derived using the relationship shown in Exhibit 7-5: the maximum queue length, the average queue length while queue is present, and the average queue length; these are shown in Equations 7-12, 7-13, and 7-14, respectively.

Assumptions of queue length

$$Q_M = \frac{vr}{3600} \tag{7-12}$$

$$Q_Q = \frac{vr}{7200} \tag{7-13}$$

$$Q = \frac{Q_M t_Q}{2C} \tag{7-14}$$

where

- Q_M = maximum queue length (veh),
- Q_Q = average queue length while queue is present (veh),
- Q = average queue length (veh),
- v = mean arrival rate (veh/h),
- r = effective red time (s),
- C = cycle length (s), and
- t_Q = time duration of queue (s).

The queuing characteristics can be modeled by varying the arrival rate, service rate, and timing plan. In real-life situations, arrival rates and service rates are constantly changing. These variations complicate the model, but the basic relationships do not change. Queue length can be estimated for planning purposes by assuming a storage density (the average density of vehicles in the queue) and then using the relationship shown in Equation 7-15 (4). Note that demand must be greater than capacity to use this relationship.

$$QL = \frac{T * (v - c)}{N * d_s} \quad (7-15)$$

where

- QL = queue length (km),
- T = duration of analysis period (h),
- v = demand (veh/h),
- c = capacity (veh/h),
- N = number of lanes, and
- d_s = storage density (veh/km/ln).

IV. REFERENCES

1. Drake, J. S., J. L. Schofer, and A. D. May, Jr. A Statistical Analysis of Speed-Density Hypotheses. In *Highway Research Record 154*, TRB, National Research Council, Washington, D.C., 1967, pp. 53–87.
2. May, A. D., Jr. *Traffic Flow Fundamentals*. Prentice-Hall, Englewood Cliffs, N.J., 1990.
3. Gerlough, D., and M. Huber. *Special Report 165: Traffic Flow Theory, A Monograph*. TRB, National Research Council, Washington, D.C., 1975.
4. Dowling, R. G., W. Kittelson, J. Zegeer, and A. Skabardonis. *NCHRP Report 387: Planning Techniques to Estimate Speeds and Service Volumes for Planning Applications*. TRB, National Research Council, Washington, D.C., 1997.

CHAPTER 8

TRAFFIC CHARACTERISTICS

CONTENTS

I. VEHICLE AND HUMAN FACTORS 8-1

 Motor Vehicle Characteristics 8-1

 Driver Characteristics 8-1

 Pedestrian Characteristics 8-2

 Bicycle Characteristics 8-2

 Bus and Light Rail Characteristics 8-2

II. DEMAND AND VOLUME 8-2

 Seasonal and Monthly Variations 8-3

 Daily Variations 8-4

 Hourly Variations 8-4

 Peak Hour and Analysis Hour 8-6

 Subhourly Variations in Flow 8-9

 Temporal Distributions 8-9

 Spatial Distributions 8-10

 Directional Distribution 8-11

 Lane Distribution 8-12

III. MEASURED AND OBSERVED VALUES 8-13

 Volumes and Flow Rates 8-17

 Freeways 8-17

 Multilane Highways 8-17

 Rural Two-Way, Two-Lane Highways 8-20

 Urban Streets 8-21

 Speed 8-21

 Trends 8-21

 Speed Variation by Time of Day 8-23

 Headway Distributions and Random Flow 8-25

 Saturation Flow and Lost Time at Signalized Intersections 8-26

 Saturation Flow at Unsignalized Intersections 8-28

 Bus and Passenger Flows 8-28

IV. REFERENCES 8-30

EXHIBITS

Exhibit 8-1. Motor Vehicle Weight and Power 8-1

Exhibit 8-2. Examples of Monthly Traffic Volume Variations for a Freeway 8-3

Exhibit 8-3. Examples of Monthly Traffic Volume Variations for the Same
Interstate Highway (Rural and Urban Segments) 8-4

Exhibit 8-4. Examples of Daily Traffic Variation by Type of Route 8-5

Exhibit 8-5. Daily Variation in Traffic by Vehicle Type for Right Lane of an
Urban Freeway 8-5

Exhibit 8-6. Examples of Hourly Traffic Variations for Rural Routes 8-6

Exhibit 8-7. Repeatability of Hourly Traffic Variations for Urban Streets 8-7

Exhibit 8-8. Ranked Hourly Volumes 8-8

Exhibit 8-9. Typical K-Factors 8-9

Exhibit 8-10. Relationship Between Short-Term and Hourly Flows 8-10

Exhibit 8-11. Directional Distribution Characteristics 8-11

Exhibit 8-12.	Observed Values of K and D on Selected Freeways and Expressways	8-12
Exhibit 8-13.	Lane Distribution by Vehicle Type.....	8-13
Exhibit 8-14.	Motor Vehicle Registration	8-14
Exhibit 8-15.	Rural Interstate Travel by Vehicle Type	8-15
Exhibit 8-16.	Annual Vehicle Kilometers of Travel	8-16
Exhibit 8-17.	Percent Distribution of Traffic by Vehicle Class	8-16
Exhibit 8-18.	Maximum Annual Average Daily Traffic Reported on Selected Interstate Routes (1990).....	8-18
Exhibit 8-19.	Reported Maximum Hourly One-Way Volumes on Selected Freeways	8-19
Exhibit 8-20.	Reported Maximum Lane Volumes on Selected Freeways	8-20
Exhibit 8-21.	Reported Maximum One-Way Volumes for Selected Multilane Highways	8-20
Exhibit 8-22.	Reported Maximum Volumes on Selected Two-Lane Rural Highways	8-21
Exhibit 8-23.	Reported Maximum Directional Volumes on Selected Urban Streets	8-22
Exhibit 8-24.	Speed Trends on Rural Interstate Highways	8-22
Exhibit 8-25.	National Spot Speed Trends for 90-km/h Facilities	8-23
Exhibit 8-26.	Speed and Volume Variations by Hour of Day (Weekdays).....	8-24
Exhibit 8-27.	Speed and Volume Variations by Hour of Day (Saturdays)	8-25
Exhibit 8-28.	Time Headway Distribution for Long Island Expressway	8-26
Exhibit 8-29.	Observed Saturation Flow Rates at Signalized Intersections	8-27
Exhibit 8-30.	Research Results on Queue Discharge Headways	8-28
Exhibit 8-31.	Observed Peak-Direction, Peak-Hour Passenger Volumes on U.S. and Canadian Bus Transit Routes—1995 Data	8-29
Exhibit 8-32.	Observed U.S. and Canadian Light Rail Transit Passenger Volumes, Peak Hour at the Peak Point for Selected Lines (1993–1996 Data)	8-30

I. VEHICLE AND HUMAN FACTORS

Three major components affect driving: the vehicle, the roadway/environment, and the driver. In this chapter, vehicle and driver characteristics and how they are affected by the environment and physical properties of the roadway are identified. The characteristics and performance of motor vehicles play a major role in defining the fundamentals of traffic flow and capacity. Human behavior also contributes to the characteristics of traffic flow on a facility.

MOTOR VEHICLE CHARACTERISTICS

This section summarizes the operating characteristics of motor vehicles that should be considered in analyzing a facility. The major considerations are vehicle types and dimensions, turning radii and offtracking, resistance to motion, power requirements, acceleration performance, and deceleration performance. Motor vehicles include passenger cars, trucks, vans, buses, recreational vehicles, and motorcycles. These vehicles have unique weight, length, size, and operational characteristics. The forces that must be overcome by motor vehicles if they are to move are rolling, air, grade, curve, and inertial resistance. The weight/power ratios are useful for indicating the overall performance in overcoming these forces. Exhibit 8-1 summarizes typical motor vehicle weight and power for different vehicle types.

Characteristics of various roadway users

EXHIBIT 8-1. MOTOR VEHICLE WEIGHT AND POWER

Motor Vehicles	Empty Weight with Driver (kg)	Nominal Power (kW)	Weight-to-Power Ratio (kg/kW)
Passenger car	1540	78	19.7
Large pickup truck	1905	130	14.7
Two-axle, six-tire truck	4535	130	34.9
Tractor-semitrailer	11,340	242	46.9

Source: *Traffic Engineering Handbook* (1).

Vehicle acceleration and deceleration rates are factors in designing traffic signal timing, computing fuel economy and travel time values, and estimating how normal traffic flow is resumed after a breakdown. Vehicle acceleration rates of passenger cars accelerating after a stop range between 1 and 4 m/s², while passenger car deceleration rates range between 2 and 8 m/s² (1).

DRIVER CHARACTERISTICS

Driving is a complex task involving a variety of skills. The most important of these skills involve taking in and processing information and making quick decisions based on this information. Driver tasks are categorized into three main elements: control, guidance, and navigation. Control involves the driver's interaction with the vehicle in terms of speed and direction (accelerating, braking, and steering). Guidance refers to maintaining a safe path and keeping the vehicle in the proper lane. Navigation means planning and executing a trip.

The perception and processing of information are important driver characteristics. About 90 percent of the information a driver receives is visual. A significant component in the successful processing and use of information is the speed with which this processing is done. One of the parameters that is used to quantify the speed of processing information is perception-reaction time, which represents how quickly a driver can respond to an emergency situation. The parameter called sight distance is directly associated with reaction time. There are three types of sight distance: stopping, passing, and decision. This parameter is used to determine geometric features of transportation facilities.

Other factors like nighttime driving, fatigue, driving under the influence of alcohol and drugs, elderly drivers, and police enforcement contribute to driver behavior on a transportation facility. All these factors can affect the operational parameters of speed, delay, and density.

PEDESTRIAN CHARACTERISTICS

Pedestrian speed is probably the most important characteristic of a pedestrian facility that is affected by individual pedestrian behavior and habit. Among several factors that influence walking speed are density, gender, size of platoon, percentage of elderly population, handicapped pedestrian population, and child pedestrian population. An average walking speed of 1.2 m/s is appropriate for typical groups of pedestrians. The amount of space required by a queued or standing pedestrian is 0.75 m². At signalized intersections pedestrian crossings must be assigned an amount of effective green time based on average walking speed.

BICYCLE CHARACTERISTICS

The bicycle and the bicyclist have very different characteristics and exhibit different operation than do drivers of motor vehicles. The typical speed of bicycles is about 25 km/h. Among other factors that affect bicycles are the type of bicycle, the bike path surface type, weather conditions, the grade of the path, and the mix of other nonmotorized users on the bike path.

BUS AND LIGHT RAIL CHARACTERISTICS

Bus and light rail capacity are affected by vehicle type, loading area performance, and dwell time of the bus or light rail vehicle. Each bus requires a certain amount of service time at stops that varies with the number of boarding and alighting passengers, door configuration, and fare collection method. The minimum safe spacing between buses in motion and the number of loading areas available at any stop also influence the total number of buses and persons that a given facility can carry.

The total passenger flow rate varies with bus capacity and the trade-off between seated capacity and standees. The largest number of seats and lowest number of standees should occur on longer suburban bus routes or on intercity bus routes where higher levels of comfort are essential. A typical 14-m urban transit bus can normally seat 43 passengers and carry up to 37 standees if the aisle circulation space is filled. Similarly, an 18-m articulated bus can carry 65 seated passengers and 55 standees. However, bus operator policy often limits the number of standees to levels below this theoretical capacity.

II. DEMAND AND VOLUME

In this manual, demand is the principal measure of the amount of traffic using a given facility. Thus, the term demand relates to vehicles arriving, while the term volume relates to vehicles discharging.

Traffic demand varies by month of the year, day of the week, hour of the day, and subhourly interval within the hour. These variations are important if highways are to effectively serve peak demands without breakdown. The effects of a breakdown may extend far beyond the time during which demand exceeds capacity and may take up to several hours to dissipate. Thus, highways minimally adequate to handle a peak-hour demand may be subject to breakdown if flow rates within the peak hour exceed capacity.

Seasonal peaks in traffic demand are also of importance, particularly for recreational facilities. Highways serving beach resort areas may be virtually unused during much of the year, only to be subject to oversaturated conditions during peak summer periods.

SEASONAL AND MONTHLY VARIATIONS

Seasonal fluctuations in traffic demand reflect the social and economic activity of the area being served by the highway. Exhibit 8-2 shows monthly variation patterns observed in Minnesota. Several significant characteristics are apparent:

- Monthly variations are more severe on rural routes than on urban routes,
- Monthly variations are more severe on rural routes serving primarily recreational traffic than on rural routes serving primarily business traffic, and
- Daily traffic patterns vary by month of year most severely for recreational routes.

EXHIBIT 8-2. EXAMPLES OF MONTHLY TRAFFIC VOLUME VARIATIONS FOR A FREEWAY

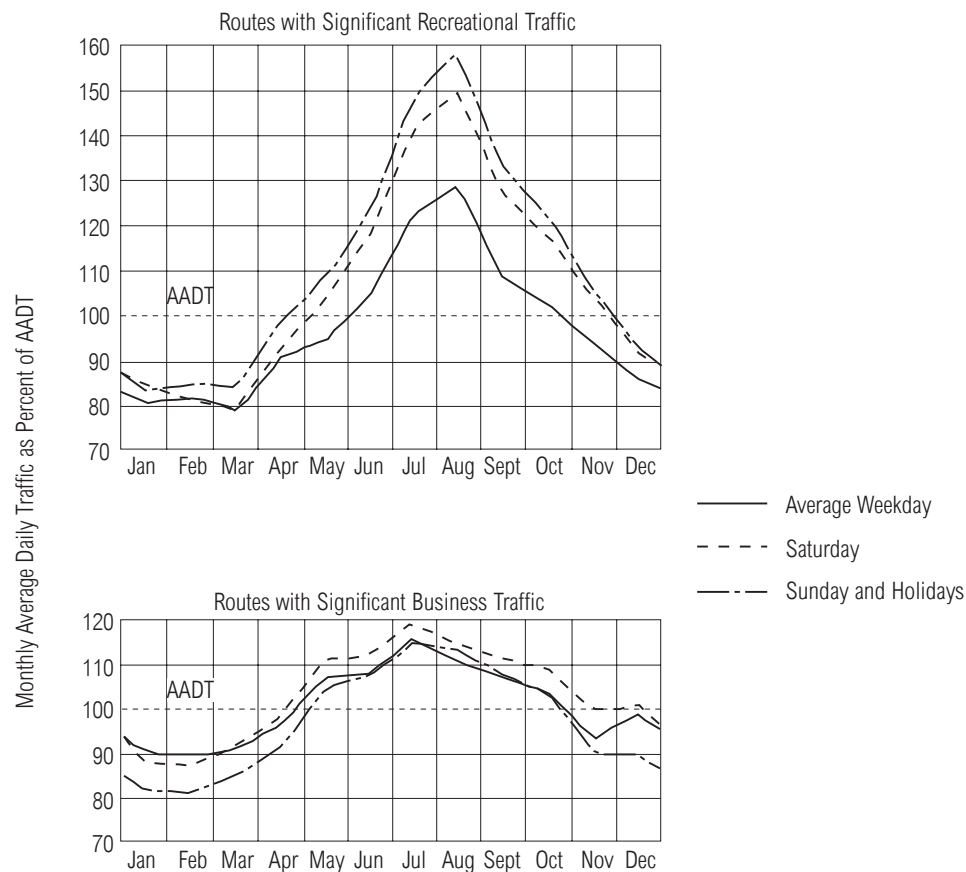

Volume variations by month and type of day

Source: Minnesota Department of Transportation.

These observations lead to the conclusion that commuter and business-oriented travel occurs in more uniform patterns and that recreational traffic creates the greatest variation in volume patterns.

The data for Exhibit 8-3 were collected on the same Interstate route. One segment is within 1.6 km of the central business district of a large metropolitan area. The other segment is within 80 km of the first but serves a combination of recreational and intercity business travel. The wide variation in seasonal patterns for the two segments underscores the effect of trip purpose and may also reflect capacity restrictions on the urban section.

EXHIBIT 8-3. EXAMPLES OF MONTHLY TRAFFIC VOLUME VARIATIONS FOR THE SAME INTERSTATE HIGHWAY (RURAL AND URBAN SEGMENTS)

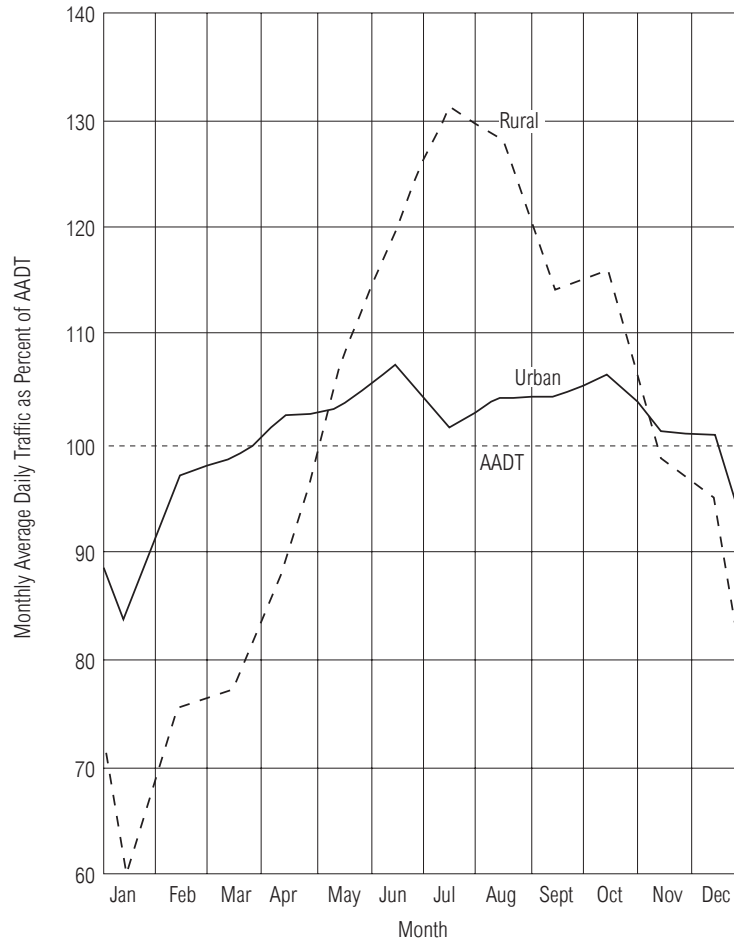

Source: Muranyi (2).

Time of peak demand will vary according to highway type

DAILY VARIATIONS

Volume variations by day of the week are also related to the type of highway on which observations are made. Exhibit 8-4 shows that weekend volumes are lower than weekday volumes for highways serving predominantly business travel, such as urban freeways. In comparison, peak traffic occurs on weekends on main rural and recreational highways. Furthermore, the magnitude of daily variation is highest for recreational access routes and lowest for urban commuter routes.

Exhibit 8-5 shows the variation in traffic by vehicle type for the shoulder lane of an urban freeway. Although the values shown in Exhibits 8-4 and 8-5 are typical of patterns that may be observed, they are not meant to substitute for local studies and analyses. The average daily traffic averaged over a full year is referred to as the annual average daily traffic, or AADT, and is often used in forecasting and planning.

HOURLY VARIATIONS

Typical hourly variation patterns are shown in Exhibit 8-6, where the patterns are related to highway type and day of the week. The typical morning and evening peak hours are evident for urban commuter routes on weekdays. The evening peak is generally somewhat more intense than the morning peak, as shown in Exhibit 8-6. On weekends, urban routes show a peak that is less intense and more spread out, occurring in early to midafternoon.

EXHIBIT 8-4. EXAMPLES OF DAILY TRAFFIC VARIATION BY TYPE OF ROUTE

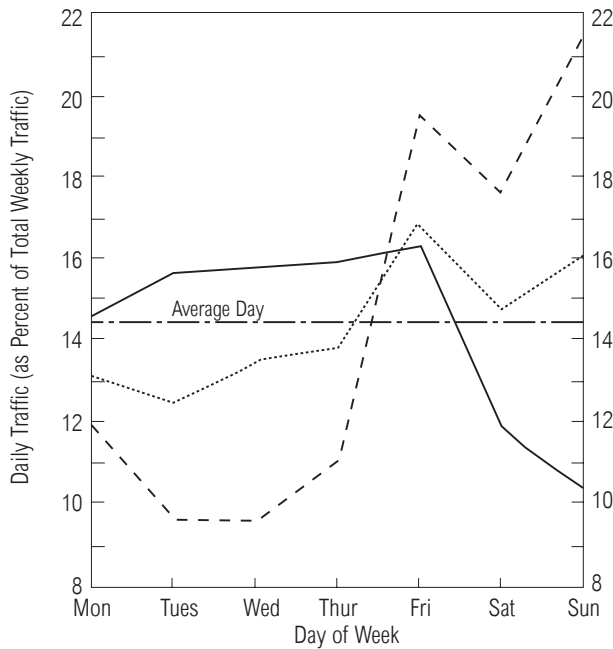

..... Main rural route I-35, Southern Minnesota, AADT 10,823, 4 lanes, 1980.
 - - - Recreational access route MN 169, North-Central Lake Region, AADT 3,863, 2 lanes, 1981.
 — Suburban freeway, four freeways in Minneapolis-St. Paul, AADTs 75,000-130,000, 6-8 lanes, 1982.
 - - - Average day.
 Source: Minnesota Department of Transportation.

EXHIBIT 8-5. DAILY VARIATION IN TRAFFIC BY VEHICLE TYPE FOR RIGHT LANE OF AN URBAN FREEWAY

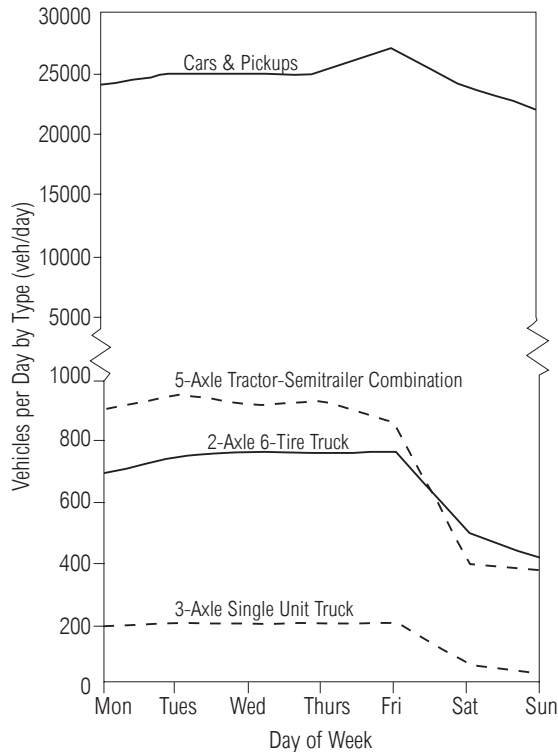

Data were collected on I-494, 4 lanes, in Minneapolis-St. Paul.
 Source: Minnesota Department of Transportation.

Variation by day of week and route type for various types of vehicles

Traffic variation during the day by day of week

EXHIBIT 8-6. EXAMPLES OF HOURLY TRAFFIC VARIATIONS FOR RURAL ROUTES

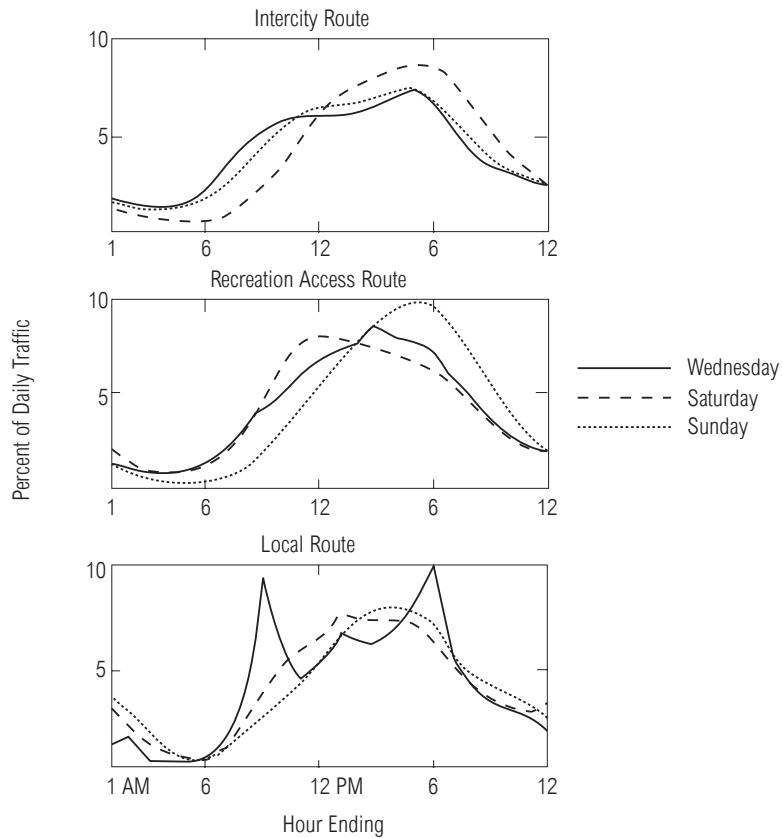

Source: *Transportation and Traffic Engineering Handbook* (3).

Recreational routes also have single daily peaks. Saturday peaks on such routes tend to occur in the late morning or early afternoon (as travelers go to their recreational destination) and in late afternoon or early evening on Sundays (as they return home).

The repeatability of hourly variations is of great importance. The stability of peak-hour demand affects the feasibility of using such values in design and operational analysis of highways and other transportation facilities. Exhibit 8-7 shows data obtained in metropolitan Toronto. The area between the dotted lines indicates the range within which one can expect 95 percent of the observations to fall. Whereas the variations by hour of the day are typical for urban areas, the relatively narrow and parallel fluctuations among the days of the study indicate the repeatability of the basic pattern. The observations shown were obtained from detectors measuring traffic in one direction only, as evidenced by the single peak hour shown for either morning or afternoon.

It is again noted that the data of Exhibits 8-6 and 8-7 are typical of observations that can be made. The patterns illustrated, however, vary in response to local travel habits and environments, and these examples should not be used as a substitute for locally obtained data.

PEAK HOUR AND ANALYSIS HOUR

Capacity and other traffic analyses focus on the peak hour of traffic volume, because it represents the most critical period for operations and has the highest capacity requirements. The peak-hour volume, however, is not a constant value from day to day or from season to season.

EXHIBIT 8-7. REPEATABILITY OF HOURLY TRAFFIC VARIATIONS FOR URBAN STREETS

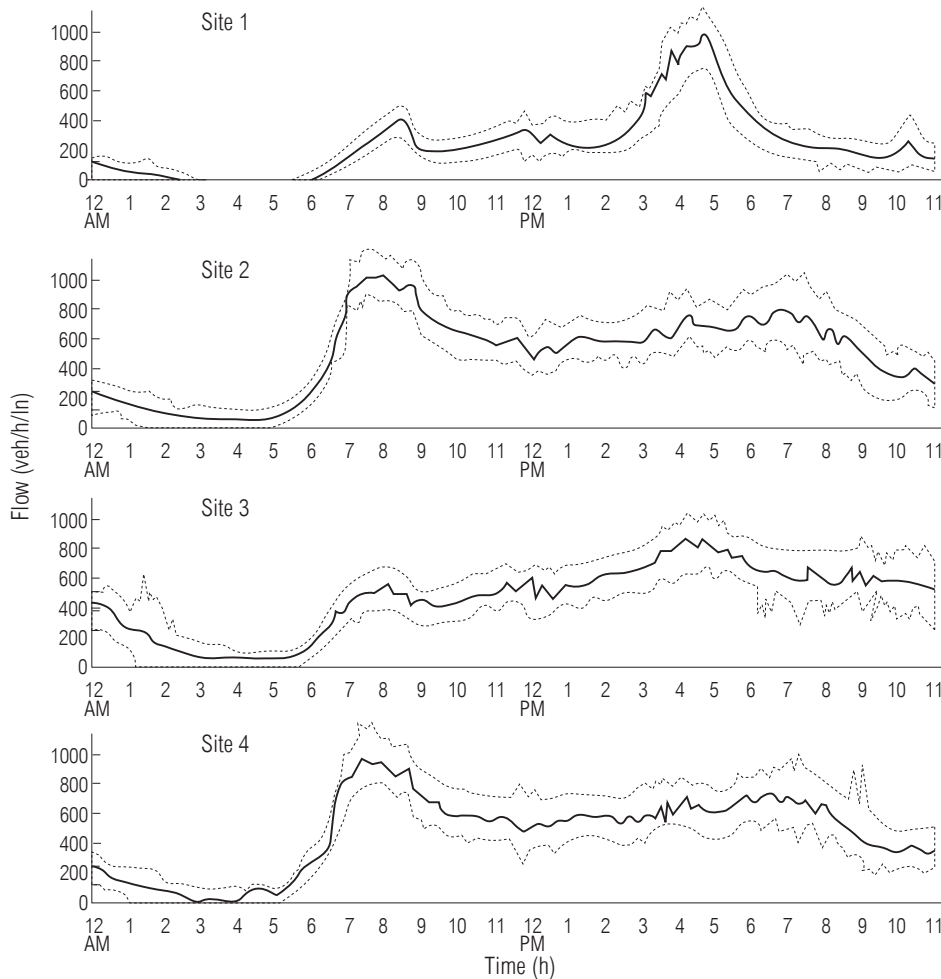

Note:
 a. Sites 2 and 4 are one block apart on same street, in same direction.
 b. All sites are two moving lanes in one direction.
 Source: McShane and Crowley (4).

Repeatability of hourly patterns

If the highest hourly volumes for a given location were listed in descending order, a large variation in the data would be observed, depending on the type of facility. Rural and recreational routes often show a wide variation in peak-hour volumes. Several extremely high volumes occur on a few selected weekends or in other peak periods, and traffic during the rest of the year is at much lower volumes, even during the peak hour. Urban streets, on the other hand, show less variation in peak-hour traffic. Most users are daily commuters or frequent users, and occasional and special event traffic are at a minimum. Furthermore, many urban routes are filled to capacity during each peak hour, and variation is therefore severely constrained.

Exhibit 8-8 shows hourly volume relationships measured on a variety of highway types in Minnesota. Recreational facilities show the widest variation in peak-hour traffic. Their values range from 30 percent of AADT in the highest hour of the year to about 15.3 percent of AADT in the 200th-highest hour of the year and 8.3 percent in the 1,000th-highest hour of the year. Main rural facilities also display a wide variation. The highest hour comprises 17.9 percent of the AADT, decreasing to 10 percent in the 100th-highest hour and 6.9 percent in the 1,000th-highest hour. Urban radial and circumferential facilities show far less variation. The range in percent of AADT covers a narrow band,

Concept of peak hour and analysis hour

from approximately 11.5 percent for the highest hour to 7 to 8 percent for the 1,000th-highest hour. Exhibit 8-8 is based on all hours, not just peak hours of each day, and shows only the highest 1,100 hours of the year.

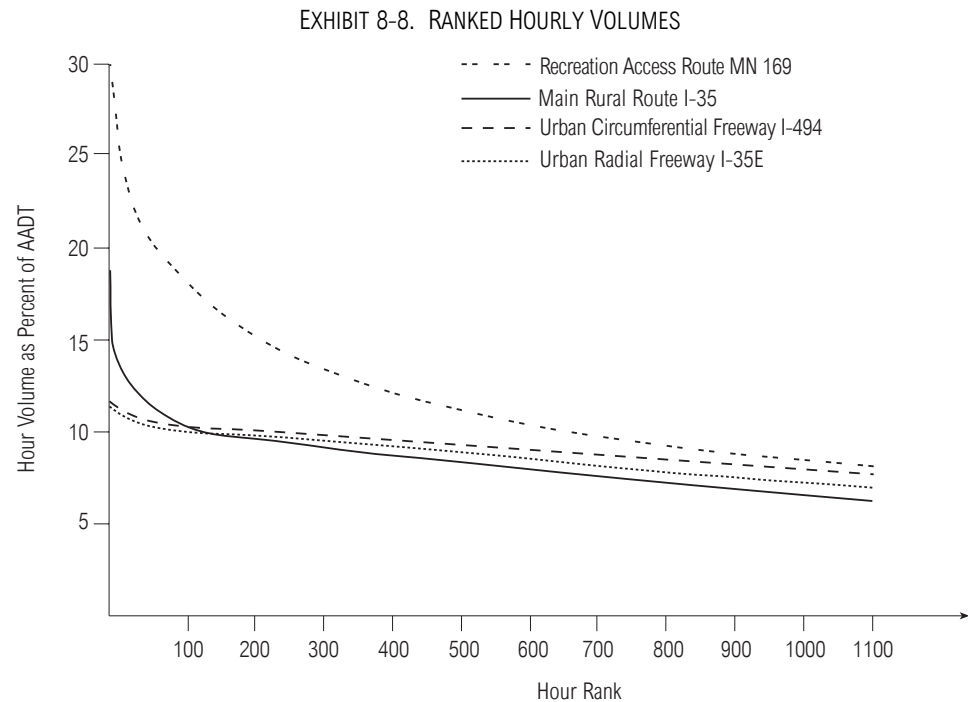

Source: Minnesota Department of Transportation.

Selection of a peak demand usually implies that a small portion of the demand during a year will not be adequately served

The selection of an appropriate hour for planning, design, and operational purposes is a compromise between providing an adequate level of service (LOS) for every (or almost every) hour of the year and economic efficiency. Customary practice in the United States is to base rural highway design on an hour between the 30th- and the 100th-highest hour of the year. This range generally encompasses the knee of the curve (the area in which the slope of the curve changes from sharp to flat). For rural highways, the knee has often been assumed to occur at the 30th-highest hour, which is often used as the basis for estimates of design-hour volume. For urban roadways, a design hour for the repetitive weekday peak periods is common.

Past studies (5,6) have emphasized the difficulty in locating a distinct knee on hourly volume curves. These curves illustrate the point that arbitrary selection of an analysis hour between the 30th- and the 100th-highest hours is not a rigid criterion and indicate the need for local data on which to base informed judgments.

The selection of analysis hour must consider the impact on design and operations of higher-volume hours that are not accommodated. The recreational access route curve of Exhibit 8-8 shows that the highest hours of the year have more than twice the volume of the 100th hour, whereas the highest hours of an urban radial route are only about 15 percent higher than the volume in the 100th hour. Use of a design criterion set at the 100th hour would create substantial congestion on a recreational access route during the highest-volume hours but would have less effect on an urban facility. Another consideration is the LOS objective. A route designed to operate at LOS B can absorb larger amounts of additional traffic than a route designed to operate at LOS D during those hours of the year with higher volumes than the design hour. As a general guide, the most repetitive peak volumes may be used for the design of new or upgraded facilities. The LOS during higher-volume periods should then be tested as to the acceptability of the resulting traffic conditions.

The proportion of AADT occurring in the analysis hour is referred to as the K-factor, expressed as a decimal fraction:

- The K-factor generally decreases as the AADT on a highway increases;
- The reduction rate for high K-factors is faster than that for lower values;
- The K-factor decreases as development density increases; and
- The highest K-factors generally occur on recreational facilities, followed by rural, suburban, and urban facilities, in descending order.

The K-factor should be determined, if possible, from local data for similar facilities with similar demand characteristics. Exhibit 8-9 presents an example of K-factors developed for Florida (7).

K-factor defined

EXHIBIT 8-9. TYPICAL K-FACTORS

Area Type	K-Factor
Urbanized	0.091
Urban	0.093
Transitioning/Urban	0.093
Rural Developed	0.095
Rural Undeveloped	0.100

Source: Florida Department of Transportation (7).

The area types in Exhibit 8-9 are defined as follows:

- Urbanized areas are those designated by the U.S. Bureau of the Census.
- Urban areas are places with a population of at least 5,000 not already included in an urbanized area.
- Transitioning areas are the areas outside of, or urbanized areas expected to be included in, an urbanized area within 20 years.
- Rural areas are whatever is not urbanized, urban, or transitioning.

SUBHOURLY VARIATIONS IN FLOW

Volume forecasts for long-range planning studies are frequently expressed in terms of AADT (vehicles per day), subsequently reduced to hourly volumes. The analysis of LOS is based on peak rates of flow occurring within the peak hour. Most of the procedures in this manual are based on peak 15-min flow rates. Exhibit 8-10 shows the substantial short-term fluctuation in flow rate that can occur during an hour.

In Exhibit 8-10 the maximum 5-min rate of flow is 2,232 veh/h, whereas the maximum rate of flow for a 15-min period is 1,980 veh/h. The full hour volume is only 1,622 veh/h. A design for a peak 5-min flow rate would result in substantial excess capacity during the rest of the peak hour. A design for the peak-hour volume would result in oversaturated conditions for a substantial portion of the hour.

Consideration of these peaks is important. Congestion due to inadequate capacity occurring for only a few minutes can take substantial time to dissipate because of the dynamics of breakdown flow. Fifteen-min flow rates have been selected as the basis for most procedures of this manual. The relationship between the peak 15-min flow rate and the full hourly volume is given by the peak-hour factor (PHF). Whether the design hour is measured, established from the analysis of peaking patterns, or based on modeled demand, the PHF is applied to determine design-hour flow rates.

PHFs in urban areas generally range between 0.80 and 0.98. Lower values signify greater variability of flow within the subject hour, and higher values signify less flow variation. PHFs over 0.95 are often indicative of high traffic volumes, sometimes with capacity constraints on flow during the peak hour.

TEMPORAL DISTRIBUTIONS

The proportion of total daily traffic that occurs in the peak hour is defined by the K-factor. For many rural and urban highways, this factor falls between 0.09 and 0.10.

Variation in traffic within the hour

For highway sections with high peak periods and relatively low off-peak flows, the K-factor may exceed 0.10. Conversely, for highways that demonstrate consistent and heavy flows for many hours of the day, K-factors lower than 0.09 are often observed.

EXHIBIT 8-10. RELATIONSHIP BETWEEN SHORT-TERM AND HOURLY FLOWS

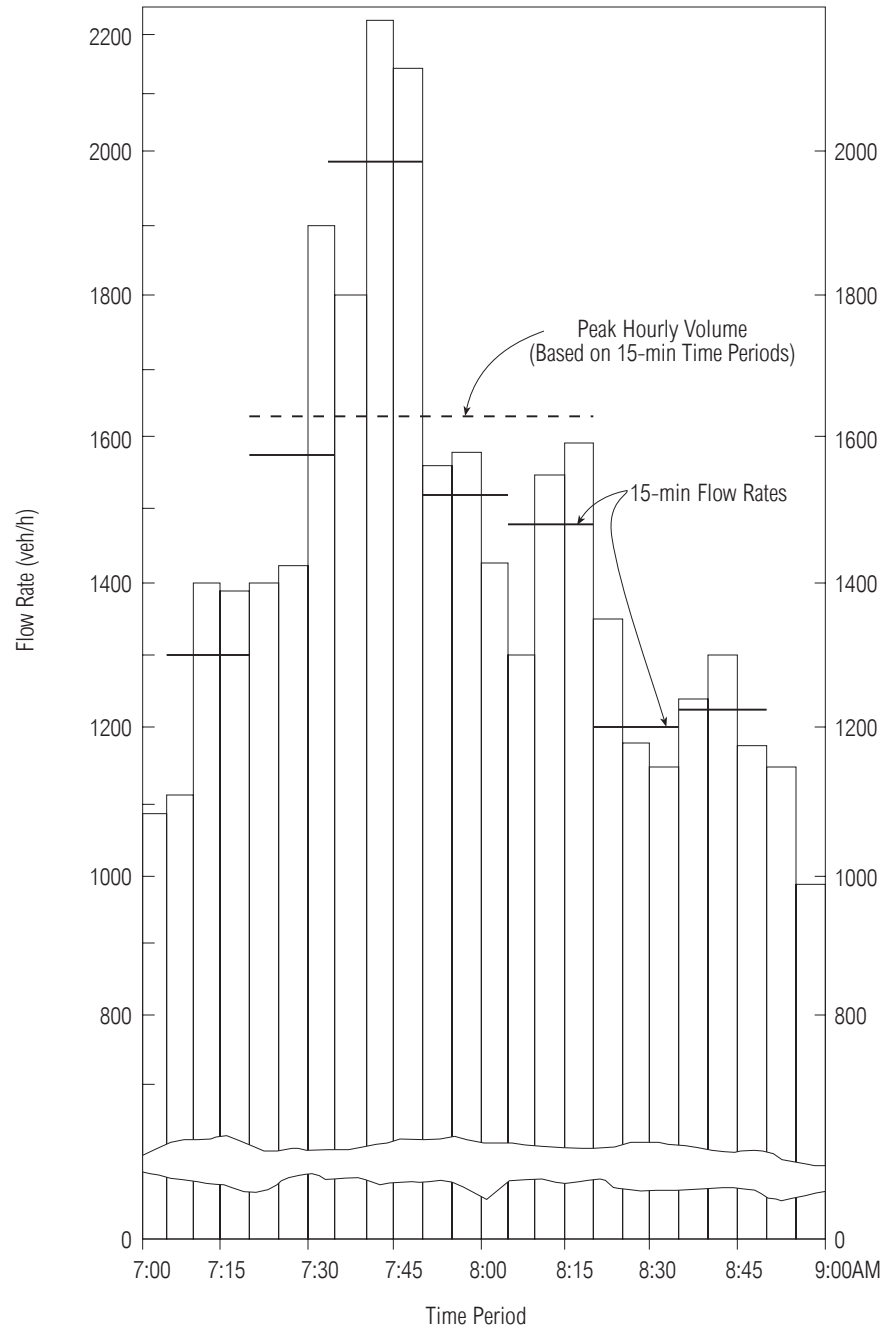

Source: Minnesota Department of Transportation.

SPATIAL DISTRIBUTIONS

Traffic volume varies in space as well as time. The two critical spatial characteristics in capacity analysis are directional distribution and volume distribution by lane. Volume may also vary longitudinally along various segments of a facility, but this does not

explicitly affect capacity analysis computation because each facility segment serving different traffic demands is analyzed separately.

Directional Distribution

During any particular hour, traffic volume may be greater in one direction than in the other. An urban radial route, serving strong directional demands into the city in the morning and out at night, may display as much as a 2:1 imbalance in directional flows. Recreational and rural routes may also be subject to significant directional imbalances, which must be considered in analyses. Exhibit 8-11 gives the directional distribution on various highway types in Minnesota.

Concept of directional distribution

EXHIBIT 8-11. DIRECTIONAL DISTRIBUTION CHARACTERISTICS

Highest Hour of the Year	Percentage of Traffic in Peak Direction		
	Type of Facility		
	Urban Circumferential	Urban Radial	Rural
1st	53	66	57
10th	53	66	53
50th	53	65	55
100th	50	65	52

Source: Minnesota Department of Transportation.

Directional distribution is an important factor in highway capacity analysis. This is particularly true for two-lane rural highways. Capacity and level of service vary substantially on the basis of directional distribution because of the interactive nature of directional flows on such facilities. Procedures for two-lane highways include explicit consideration of directional distribution.

Whereas there is no explicit consideration of directional distribution in the analysis of multilane facilities, the distribution has a dramatic effect on both design and LOS. As indicated in Exhibit 8-11, up to two-thirds of the peak-hour traffic on urban radial routes has been observed to be moving in one direction. Unfortunately, this peak occurs in one direction during the morning and in the other in the evening. Thus, both directions of the facility must be adequate for the peak directional flow. This characteristic has led to the use of reversible lanes on some urban streets.

Directional distribution is not a static characteristic. It changes from year to year and by hour of the day, day of the week, and season. Development in the vicinity of highway facilities often induces traffic growth that changes the existing directional distribution.

The proportion of traffic moving in the peak direction of travel during peak hours is denoted as D. The K-factor, the proportion of AADT occurring in the analysis hour, was discussed previously. These two factors are used to estimate the peak-hour traffic volume in the peak direction using Equation 8-1:

$$DDHV = AADT * K * D \tag{8-1}$$

where

- DDHV = directional design-hour volume (veh/h),
- AADT = annual average daily traffic (veh/day),
- K = proportion of AADT occurring in the peak hour, and
- D = proportion of peak-hour traffic in the peak direction.

The product of the factors K and D is given for a number of facilities in Exhibit 8-12. The product gives the proportion of AADT occurring in the maximum direction of the peak hour.

EXHIBIT 8-12. OBSERVED VALUES OF K AND D ON SELECTED FREEWAYS AND EXPRESSWAYS

City and 1990 Urbanized Area Population	Facility	Year Count Taken	Number of Lanes	Annual Avg. Daily Traffic (2-Way)	Volumes in Peak Direction		Avg. Volume Per Lane (veh/h/ln)
					Vehicles (1-Way)	% 2-Way AADT (K * D)	
Atlanta, GA 2,157,806	I-20 E. of CBD at Moreland Ave.	1984	8	99,900	7794	7.8	1948
	I-20 at Martin Luther King Jr. Drive	1984	8	91,200	5198 ^a	5.7 ^a	1299 ^a
	I-75 N. of CBD at University Ave.	1984	8	146,050	8179	5.6 ^a	2045 ^a
	I-75 N. of CBD (N. of I-85)	1984	8	82,830	5135	6.2 ^a	1284 ^a
	I-85 N. of I-75 at Monroe Dr.	1984	8	95,300	6765	7.1	1641
Boston, MA 2,775,370	I-93 N. of I-495	1984	6	76,500	5200	6.8	1733
	SE Expressway at Southampton St.	1982	6	143,300	6860	4.8	2286
	I-95 E. of Rt. 128 N. of Middlesex	1984	8	125,050	7282	5.8	1823
Denver, CO 1,517,977	I-25 S. of I-70	1984	8	175,000	7500	4.3	1875
	I-70, Colorado Blvd. to Dahlia	1984	6	114,000	4650	4.1	1550
	U.S. 6 W. of Federal Blvd.	1985	6	112,000	5835	5.2	1945
Detroit, MI 3,697,529	I-96 Jeffers Freeway at Warren	1980	8	67,600	6270	9.3	1568
	Lodge at E. Grant Blvd.	1981	6	111,450	5660	4.2	1558
Houston, TX 2,901,851	I-10 E. of Taylor St.	1985	10	151,000	7600	5.0	1520
	I-10 E. of McCarty	1985	8	110,200	7530	6.8	1882
	I-610 at Ship Channel	1985	10	103,200	5540	5.4	1108
Milwaukee, WI 1,226,293	N.-S. Freeway at Wisconsin	1984	8	118,080	5730	4.5	1342
	N.-S. Freeway at Greenfield	1984	8	110,050	6380	5.8	1595
	E.-W. Freeway at 26th St.	1984	6	121,150	5700	4.7	1900
	Zoo Freeway at Wisconsin	1984	6	110,730	4760	4.3	1581
	Airport Freeway at 68th	1984	6	81,020	3940	4.9	1313
New York, NY 16,044,012	Holland Tunnel	1982	4	73,200	2700	3.7	1350
San Francisco, CA 3,629,516	I-80 Oakland Bay Bridge	1984	10	223,000	8898	4.0	1780
Washington, D.C. 3,363,061	I-66 Theodore Roosevelt Bridge	1984	6	86,200	7413 ^a	8.6 ^a	2471 ^a
	Anacostia Freeway at Howard Rd.	1984	6	121,700	6085 ^a	5.0 ^a	2028 ^a

Note:

a. Values are based on K * D value for 1975.

Source: Levinson (8).

If average annual daily traffic is not known, it can be estimated from average weekday traffic using Equation 8-2 derived from the Highway Performance Monitoring System (HPMS) (9).

$$AADT = \frac{AWDT}{1.07} \tag{8-2}$$

where

AADT = annual average daily traffic (veh/day), and

AWDT = average weekday daily traffic (veh/day).

Lane Distribution

When two or more lanes are available for traffic in a single direction, the distribution in lane use varies widely. The volume distribution by lane depends on traffic regulations, traffic composition, speed and volume, the number and location of access points, the origin-destination patterns of drivers, the development environment, and local driver habits.

Because of these factors, there are no typical lane distributions. Data indicate that the peak lane on a six-lane freeway, for example, may be the shoulder, middle, or median lane, depending on local conditions.

Concept of lane distribution

Exhibit 8-13 gives daily lane distribution data for various vehicle types on selected freeways. The data are illustrative and are not intended to represent typical values.

EXHIBIT 8-13. LANE DISTRIBUTION BY VEHICLE TYPE

Highway	Vehicle Type	Percent Distribution By Lane		
		Lane 1 ^b	Lane 2	Lane 3
Lodge Freeway, Detroit	Light ^a	29.2	38.4	32.4
	Single-Unit Trucks	30.8	61.5	7.7
	Combinations	88.5	2.9	8.6
	All Vehicles	30.9	37.8	31.3
I-95, Connecticut Turnpike	Light ^a	34.6	40.9	24.5
	All Vehicles	37.1	40.4	22.5
I-4, Orlando, Florida	All Vehicles	29.9	31.7	38.4

Notes:

a. Passenger cars, panel trucks, and pickup trucks.

b. Lane 1 = shoulder lane; lanes numbered from shoulder to median.

Source: Huber and Tracy (10); Florida Department of Transportation, 1993.

The trend indicated in Exhibit 8-13 is reasonably consistent throughout North America. Heavier vehicles tend toward the right-hand lanes, partially because they may operate at lower speeds than other vehicles and partially because of regulations prohibiting them from using leftmost lanes.

III. MEASURED AND OBSERVED VALUES

The methodologies in this manual are based on calibrated national average traffic characteristics observed over a range of facilities. Observations of these characteristics at specific locations will vary somewhat from national averages because of unique features of the local driving environment.

The number of motor vehicles in the United States has been steadily increasing, with over 200 million registered vehicles in 1996. The increase during the 10-year period from 1986 was more than 17 percent (Exhibit 8-14). The number of passenger cars decreased during that period by 0.3 million, and the number of trucks grew by almost 30 million, with most of them in the light truck category. The number of motorcycles decreased from 5.2 million to 3.9 million.

On the rural Interstate system, automobiles and light trucks and buses account for 77 percent of average daily traffic volumes, with heavy trucks and buses representing the remainder (Exhibit 8-15). Annual travel on the roadways of the United States reached an estimated 4.0 trillion vehicle-km, or about three times the level reported in 1960, as shown in Exhibit 8-16. Travel grew about 47 percent during the 1960s, another 38 percent in the 1970s, and another 41 percent in the 1980s. Travel in urban areas accounted for 2.4 trillion vehicle-km in 1996, or 61 percent of the total, compared with 44 percent in 1960. The amount of travel in urban areas increased by almost 45 percent in the 1980s, faster than in rural regions, where growth was still very significant at 27 percent.

Exhibit 8-17 lists percentages of traffic distribution based on (a) vehicle classification data collected by states and compiled by the Federal Highway Administration and (b) information from the Bureau of the Census' Truck Inventory and Use Survey (TIUS) on the use of light trucks (11). The percentages in Exhibit 8-17 are daily values with peak-hour conditions being half or less than half of the numbers.

The levels and characteristics of traffic demand are constantly changing

EXHIBIT 8-14. MOTOR VEHICLE REGISTRATION

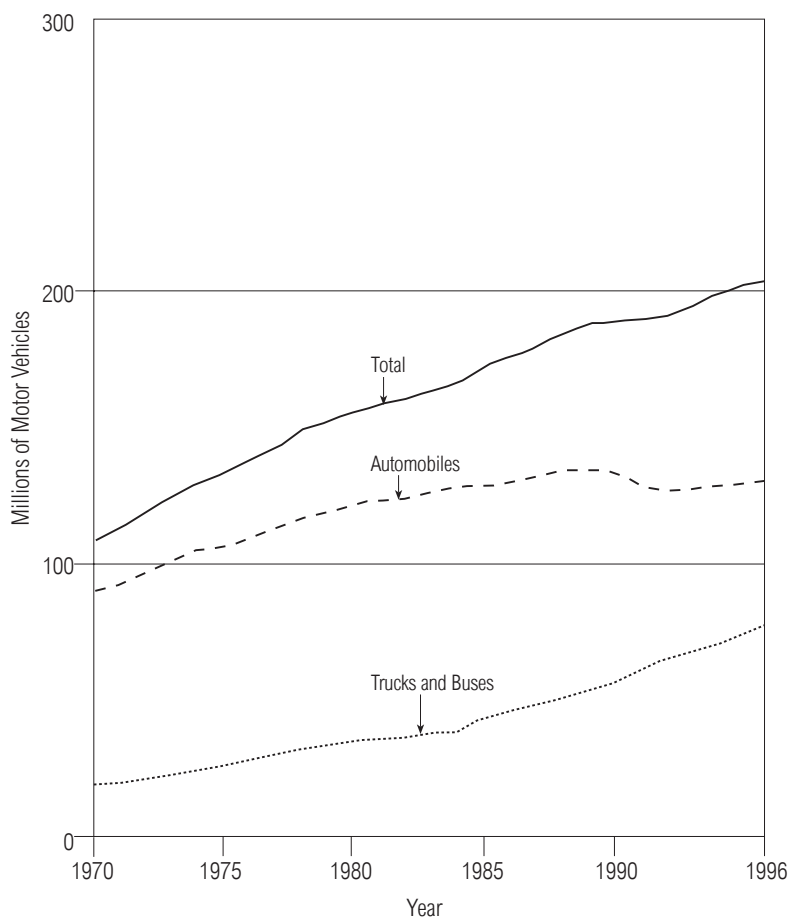

Vehicle Type	1986	1996	Percent Change 1986 to 1996
Automobiles	130.0	129.7	-0.2
Buses	0.6	0.7	16.7
Trucks	45.1	75.9	68.3
P&C Light Trucks ^a	38.8	67.9	75.0
P&C Truck Tractors ^a	1.1	1.4	27.3
Other Single-Unit Trucks and Publicly Owned Trucks	5.2	6.6	26.9
Total	175.7	206.4	17.5
Motorcycles ^b	5.2	3.9	-25.0

Notes:

a. Private and commercial.

b. Motorcycles not included in total.

Source: *Our Nation's Highways, Selected Facts and Figures*, Federal Highway Administration, 1996.

EXHIBIT 8-15. RURAL INTERSTATE TRAVEL BY VEHICLE TYPE

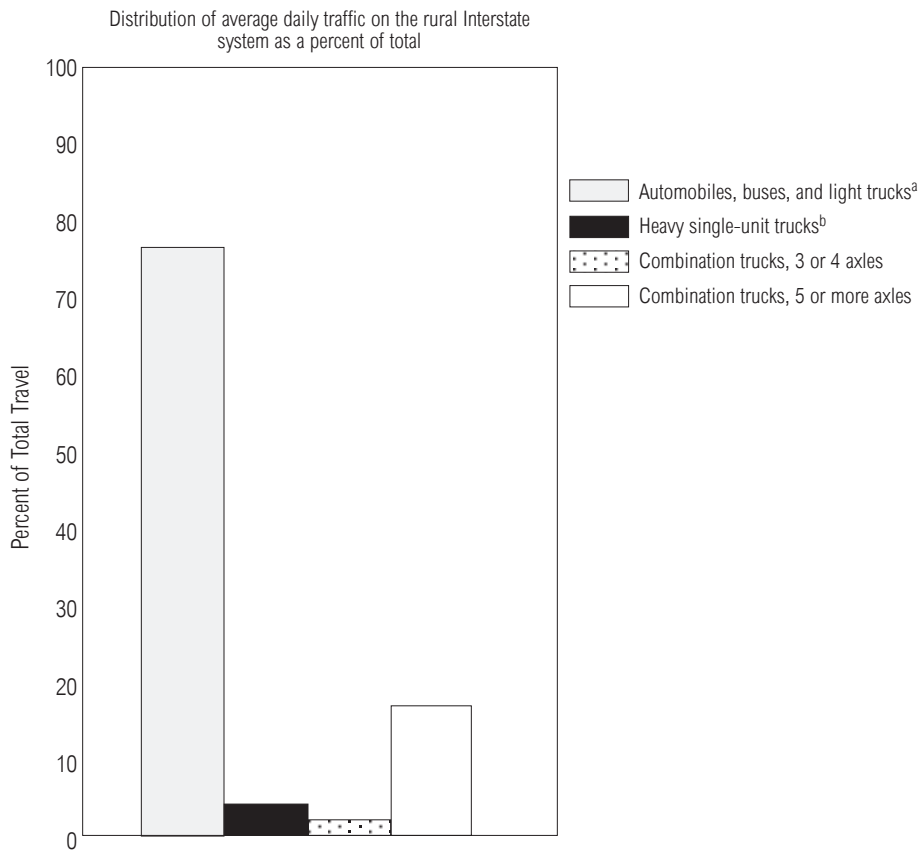

Notes:

a. All 2-axle, 4-tire trucks. Includes pickup trucks, panel trucks, vans, and other vehicles (campers, motor homes, etc.)

b. All vehicles on a single frame having either 2 axles and 6 tires or 3 or more axles (including camping and recreational vehicles and motor homes).

Source: *Our Nation's Highways, Selected Facts and Figures*, Federal Highway Administration, 1996.

EXHIBIT 8-16. ANNUAL VEHICLE KILOMETERS OF TRAVEL

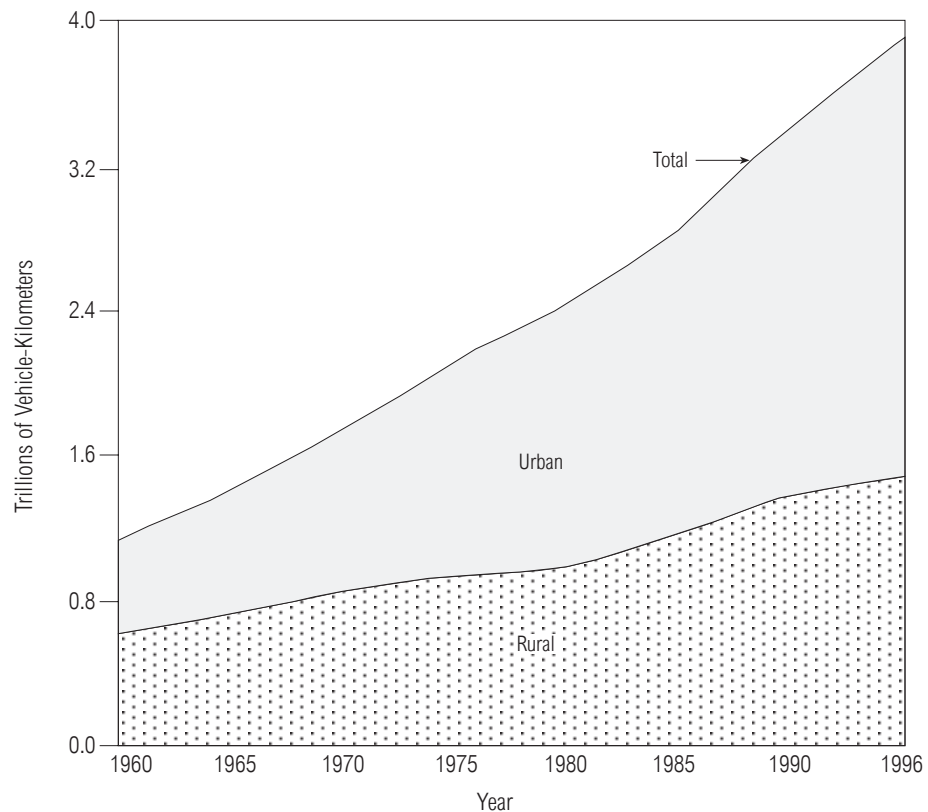

Source: *Our Nation's Highways, Selected Facts and Figures*, Federal Highway Administration, 1996.

EXHIBIT 8-17. PERCENT DISTRIBUTION OF TRAFFIC BY VEHICLE CLASS

Functional Class	Noncommercial Vehicles (%)	Commercial Vehicles			Total (%)
		Four-Tire (%)	Single-Unit (%)	Combination (%)	
Rural					
Interstate	81.6	3.3	2.9	12.2	100
Other principal arterials	87.2	4.7	3.2	4.9	100
Minor arterial, collector and local	88.5	5.3	3.6	2.6	100
Average - rural	86.6	4.7	3.4	5.3	100
Urban					
Interstate	88.2	5.5	1.8	4.5	100
Other freeways and expressways	90.5	5.5	1.7	2.3	100
Other principal arterials	89.5	6.6	1.7	2.2	100
Minor arterials	90.4	6.4	1.7	1.5	100
Collectors	90.3	6.4	1.8	1.5	100
Local	91.0	6.4	1.8	0.8	100
Average - urban	89.8	6.2	1.7	2.3	100

Source: *Quick Response Freight Manual* (11).

VOLUMES AND FLOW RATES

Capacity is defined in terms of the maximum flow rate that can be accommodated by a given traffic facility under prevailing conditions. The determination of capacity involves the observation of highways of various types operating under high-volume conditions.

The direct observation of capacity is difficult to achieve for several reasons. The recording of a high, or even a maximum, volume or flow rate for a given facility does not ensure that a higher flow could not be accommodated at another time. Furthermore, capacity is sometimes not a stable operating condition.

The highest reported volumes and flow rates on facilities throughout the United States and Canada are identified in the following sections. The observations may or may not represent the absolute capacities of the subject highways and reflect prevailing conditions at the locations in question. These observations are a sample of high volumes recorded by state and local highway agencies and do not suggest that there are no other facilities experiencing similar, or even higher, volumes. In some cases, auxiliary lanes may be present, resulting in lower actual flows per lane than shown in the figures.

The data were collected from the literature and from surveys conducted by the Committee on Highway Capacity and Quality of Service of the Transportation Research Board and by the Federal Highway Administration over a number of years.

Freeways

The reported average annual daily traffic volumes on selected Interstate highways are given in Exhibit 8-18. Most of these high-volume freeways are found in the largest metropolitan areas. Daily traffic volumes on these heavily used highways exceed 200,000 veh/day. Exhibit 8-19 contains a sample of the maximum reported hourly one-way volumes and the average volumes per lane on rural and urban freeways in the United States. Most volumes in this table exceed 2,000 veh/h/ln, with several freeways featuring average lane volumes of more than 2,400 veh/h/ln. The highest reported lane volumes on selected freeways are given in Exhibit 8-20.

Freeway capacity analysis procedures of this manual use a rate of flow of 2,400 pc/h/ln for freeways with free-flow speeds of 120 km/h and 2,300 pc/h/ln for freeways with free-flow speeds of 110 km/h as the capacity under base conditions. Exhibit 8-19 contains observations of values higher than this standard, but these are the maximums reported on a given freeway and are not expected to be achieved on most other freeway segments.

Multilane Highways

The observation of multilane rural highways operating under capacity conditions is difficult, because such operations rarely occur. Exhibit 8-21, however, contains some data for four-lane, six-lane, and eight-lane highways in suburban settings operating with uninterrupted-flow conditions.

EXHIBIT 8-18. MAXIMUM ANNUAL AVERAGE DAILY TRAFFIC REPORTED ON SELECTED INTERSTATE ROUTES (1990)

Location	Section Length (km)	Annual Average Daily Traffic (veh/day)	Average Daily Traffic Per Lane (veh/day/lane)
14-Lane Routes			
I-405, Los Angeles-Long Beach, California	4.072	328,500	23,464
I-95, New Jersey Turnpike, NE New Jersey	0.982	270,491	19,321
I-95, George Washington Bridge, New York	0.756	270,400	19,314
12-Lane Routes			
I-5, Los Angeles-Long Beach, California	0.805	304,000	25,333
I-405, Los Angeles-Long Beach, California	3.154	288,200	24,017
I-90, Chicago, Illinois	1.658	275,883	22,990
I-5, Seattle-Everett, Washington	2.028	254,172	21,181
I-8, San Diego, California	2.028	253,600	21,133
I-15, San Diego, California	4.635	219,300	18,275
I-280, San Francisco-Oakland, California	3.026	208,900	17,408
I-95, Northeastern New Jersey	3.042	208,768	17,379
10-Lane Routes			
I-10, Los Angeles-Long Beach, California	5.552	330,600	33,060
I-405, Los Angeles-Long Beach, California	5.633	314,000	31,400
I-5, Los Angeles-Long Beach, California	3.380	263,600	26,360
I-80, San Francisco-Oakland, California	7.564	242,000	24,200
I-210, Los Angeles-Long Beach, California	8.272	231,200	23,120
I-95, Northeastern New Jersey	2.607	222,229	22,223
I-395, Washington, District of Columbia	0.772	220,455	22,046
I-610, Houston, Texas	2.181	216,390	21,639
H-1, Honolulu, Hawaii	2.720	209,158	20,916
8-Lane Routes			
I-5, Los Angeles-Long Beach, California	4.329	280,700	35,088
I-94, Chicago, Illinois	4.828	258,800	32,350
I-580, San Francisco-Oakland, California	2.816	250,000	31,250
I-10, Los Angeles-Long Beach, California	9.382	241,000	30,125
I-90, Chicago, Illinois	2.897	224,600	28,075
I-285, Atlanta, Georgia	0.338	212,060	26,508
I-635, Dallas-Fort Worth, Texas	7.612	210,497	26,312
I-395, Northern Virginia	2.849	208,590	26,074
6-Lane Routes			
I-880, San Francisco-Oakland, California	4.667	223,200	37,200
I-610, Houston, Texas	0.489	216,390	36,065
I-680, San Francisco-Oakland, California	0.644	210,000	35,000

Source: Federal Highway Administration.

EXHIBIT 8-19. REPORTED MAXIMUM HOURLY ONE-WAY VOLUMES ON SELECTED FREEWAYS

Location	Total Volume (veh/h)	Avg. Vol. Per Lane (veh/h/ln)
4-Lane Freeways		
I-66, Fairfax, Virginia	5301	2650
U.S. 71, Kansas City, Missouri	5256	2628
I-59, Birmingham, Alabama	4802	2401
I-35W, Minneapolis, Minnesota	4690	2345
I-225, Denver, Colorado	4672	2336
I-287, Morris Co., New Jersey	4624	2312
I-295, Washington, D.C.	4480	2240
I-235, Des Moines, Iowa	4458	2229
I-71, Louisville, Kentucky	4446	2223
I-55, Jackson, Mississippi	4436	2218
I-35, Kansas City, Kansas	4398	2199
CA 4, Contra Costa County, California	4342	2171
I-45, Houston, Texas	4240	2120
I-64, Charleston, West Virginia	4152	2077
U.S. 4/NH 16, Newington, New Hampshire	4083	2041
I-564, Norfolk, Virginia	3962	1982
Northern State Parkway, New York	3840	1920
I-93, Windham, New Hampshire	3804	1902
6-Lane Freeways		
I-495, Montgomery Co., Maryland	7495	2498
U.S. 6, Denver, Colorado	7378	2459
I-5, Portland, Oregon	7188	2396
I-35W, Minneapolis, Minnesota	6909	2303
CA 17, San Jose, California	6786	2262
Texas 121, Bedford, Texas	6673	2224
I-35E, Dallas, Texas	6611	2203
Garden State Parkway, New Jersey	6608	2203
I-5 Seattle-Everett, Washington	6533	2177
I-15, Salt Lake City, Utah	6357	2119
I-24, Nashville, Tennessee	6280	2093
NJ 3, Secaucus, New Jersey	6251	2083
I-287, Somerset Co., New Jersey	6151	2050
I-290, Hillside, Illinois	6149	2047
I-90, Northwest Tollway, Illinois	6120	2040
I-80, Omaha, Nebraska	6113	2038
I-40, Nashville, Tennessee	6104	2035
Southern State Parkway, New York	5610	1870
8-Lane Freeways		
I-635, Dallas, Texas	9090	2272
Garden State Parkway, New Jersey	8911	2228
I-495, Montgomery Co., Maryland	8793	2198
I-25, Denver, Colorado	8702	2175
I-495, Fairfax, Virginia	8610	2152
I-405, Los Angeles, California	8360	2090
I-5, Seattle, Washington	8295	2073
U.S. 50, Sacramento, California	8284	2071
U.S. 59, Houston, Texas	8268	2067
I-35W, Minneapolis, Minnesota	8168	2042
I-80, W. Paterson, New Jersey	6851	1712
I-71, Columbus, Ohio	6682	1670
Tunnels		
I-279, Fort Pitt Tunnel, Pittsburgh, Pennsylvania (4-lane)	4278	2139
I-376, Squirrel Hill Tunnel, Pittsburgh, Pennsylvania (4-lane)	3922	1961
I-895, Harbor Tunnel, Baltimore, Maryland (4-lane)	3166	1584
SR 1A, Callahan Tunnel, Boston, Massachusetts (2-lane, half of one-way pair)	3059	1530
I-95, Fort McHenry Tunnel, Baltimore, Maryland (8-lane)	5840	1460

Source: HCQS Survey, Federal Highway Administration.

EXHIBIT 8-20. REPORTED MAXIMUM LANE VOLUMES ON SELECTED FREEWAYS

Location	Avg. Volume Per Lane (veh/h/ln)	Volume In Peak Lane (veh/h/ln)
4-Lane Freeways		
I-70, Wheeling, West Virginia	-	2552
I-55, Jackson, Mississippi	2218	2542
I-235, Des Moines, Iowa	2229	2466
6-Lane Freeways		
I-40, Nashville, Tennessee	2035	2664
I-5, Seattle, Washington	2177	2630
I-24, Nashville, Tennessee	2093	2500
8-Lane Freeways		
I-5, Seattle, Washington	2073	2596
I-70, Columbus, Ohio	-	2298
I-71, Columbus, Ohio	1670	2088

Source: HCQS Survey and Federal Highway Administration.

EXHIBIT 8-21. REPORTED MAXIMUM ONE-WAY VOLUMES FOR SELECTED MULTILANE HIGHWAYS

Location	Total Volume (veh/h)	Avg. Volume Per Lane (veh/h/ln)
4-Lane Highways		
U.S. 101, Sonoma County, California	4124	2062
Utah 201, Salt Lake City, Utah	3989	1995
SR 17, Bergen County, New Jersey	3776	1888
U.S. 301, Prince Georges County, Maryland	3304	1652
6-Lane Highways		
U.S. 46, Passaic County, New Jersey	5596	1865
SR 3, Passaic County, New Jersey	5348	1783
U.S. 1, Essex County, Massachusetts	4776	1592
8-Lane Highways		
Almaden Expressway, San Jose, California	5428	1357

Source: HCQS Survey, Federal Highway Administration.

Rural Two-Way, Two-Lane Highways

Two-lane, two-way rural highways in the United States and Canada rarely operate at volumes approaching capacity, and thus the observation of capacity operations for such highways in the field is difficult.

A sampling of high-volume observations is given in Exhibit 8-22, but it is emphasized that none may be taken to represent capacity for the facilities shown. Observations on two-lane, two-way rural highways in Europe have been reported at far higher volumes. Volumes of more than 2,700 veh/h have been observed in Denmark, more than 2,800 in France, more than 3,000 in Japan, and more than 2,450 in Norway. Some of these volumes have contained significant numbers of trucks, some as high as 30 percent of the traffic stream (12).

EXHIBIT 8-22. REPORTED MAXIMUM VOLUMES ON SELECTED TWO-LANE RURAL HIGHWAYS

Location	Total Volume (veh/h)	Peak Dir. Volume (veh/h)	Off-Peak Dir. Volume (veh/h)
Highways			
Madera-Olsen Rd., Simi Valley, California	3107	1651	1456
Madera-Olsen Rd., Simi Valley, California	3027	1839	1188
Hwy. 1, Banff, Alberta, Canada	2450	-	-
Hwy. 35/115, Kirby, Ontario, Canada	2250	-	-
Wasatch Blvd., Salt Lake City, Utah	2198	1504	694
Hwy. 35, Kirby, Ontario, Canada	2050	-	-
U.S. 50, Lake Tahoe, California	1796	1386	410
NJ 50, Cape May Co., New Jersey	1714	1445	269
Hwy. 1, Banff-Yoho, Alberta-British Columbia, Canada	1517	-	-
Hwy. 4, Contra Costa, California	3350	1920	1430
Bridges/Tunnels			
U.S. 158, Nags Head, North Carolina	3195	-	-
Midtown Tunnel, Norfolk/Portsmouth, Virginia	2920	1827	1093
Sagamore Bridge, Hudson, New Hampshire	2701	-	-
TH 15, St. Cloud, Minnesota	2242	1146	1096
Underwood Bridge, Hampton, New Hampshire	1960	1041	919
Staley Viaduct, Decatur, Illinois	1919	971	948

Source: HCQS Survey and Federal Highway Administration.

Urban Streets

Since flow on urban streets is uninterrupted only on segments between intersections, the interpretation of high-volume observations is not as straightforward as for uninterrupted-flow facilities. Signal timing plays a major role in the capacity of such facilities, limiting the portion of time that is available for movement along the urban street at critical intersections. The volumes reported in Exhibit 8-23 are shown with the green to cycle time ratios in effect for the subject segments. Flow rates in vehicles per hour are estimated by taking the reported volumes and dividing by the reported green to cycle ratio. The prevailing conditions on urban streets may vary greatly, and such factors as curb parking, transit buses, lane widths, upstream intersections, and other factors may substantially affect operations and observed volumes.

Note that the comparison of maximum flow rates in vehicles per hour per lane varies widely. These observations did not include such factors as left- and right-turn lanes, which may enhance the capacity of the intersection approach, nor were other prevailing conditions cited. Capacity of the urban street is generally limited by the capacity of signalized intersections, with segment characteristics seldom playing a major role in the determination of capacity.

SPEED

Trends

Nationwide speed trends though 1994 are shown in Exhibit 8-24 for Interstate rural highways. In 1973–1974, in response to a severe fuel shortage, the 55-mi/h (88.5-km/h) national speed limit was introduced, and a sharp decline in speeds was observed. Exhibit 8-25 confirms the increasing speed trends on highways in the United States. All of the highways referenced in Exhibit 8-25 had a 55-mi/h (88.5-km/h) speed limit when the data were reported.

EXHIBIT 8-23. REPORTED MAXIMUM DIRECTIONAL VOLUMES ON SELECTED URBAN STREETS

Location	Total Volume (veh/h)	Avg. Volume Per Lane (veh/h/ln)	g/C Ratio	Total Flow Rate (veh/h)	Avg. Flow Rate Per Lane (veh/h/ln)
4-Lane Urban Streets					
Ill. 83, DuPage Co., Illinois	3819	1910	0.80	4774	2387
So. Virginia St. (US 395), Reno, Nevada	2831	1415	0.62	4566	2282
Tara Blvd., Clayton, Georgia	2137	1068	0.47	4547	2272
Dougall Ave. SB, Windsor, Ontario, Canada	2240	1120	0.60	3733	1867
Antoine, Houston, Texas	2310	1155	0.65	3553	1777
Woodway WB, Houston, Texas	2156	1078	0.76	2836	1418
5-Lane Urban Streets					
North Shepard NB, PM, Houston, Texas	2100	1050	0.60	3500	1750
6-Lane Urban Streets					
Col. 2, Denver, Colorado	3435	1145	0.50	6870	2290
US 74/NC 27, Charlotte, North Carolina	4882	1627	0.80	6102	2034
Almaden Expressway, San Jose, California	3960	1320	0.66	6000	2000
Ygnacio Valley Road, Walnut Creek, California	3790	1263	0.65	5831	1943
Southwest Trafficway, Kansas City, Missouri	3492	1164	0.60	5820	1940
U.S. 19, Clearwater, Florida	4305	1435	0.75	5740	1913
Ward Parkway, Kansas City, Missouri	3477	1159	0.61	5700	1900
Seward Highway, Anchorage, Alaska	3177	1059	0.70	4538	1513
8-Lane Urban Streets					
Telegraph Rd., Detroit, Michigan	4400	1100	0.60	7333	1833
FM 1093, Houston, Texas	4500 ^a	1125	0.70	6429	1607
FM 1093, Houston, Texas	4268 ^a	1067	0.70	6097	1524

Note:

a. 2.7-m-wide lanes.

Source: HCQS Survey, Federal Highway Administration, Case Studies in Access Management, Draft Final Report, 1992.

EXHIBIT 8-24. SPEED TRENDS ON RURAL INTERSTATE HIGHWAYS

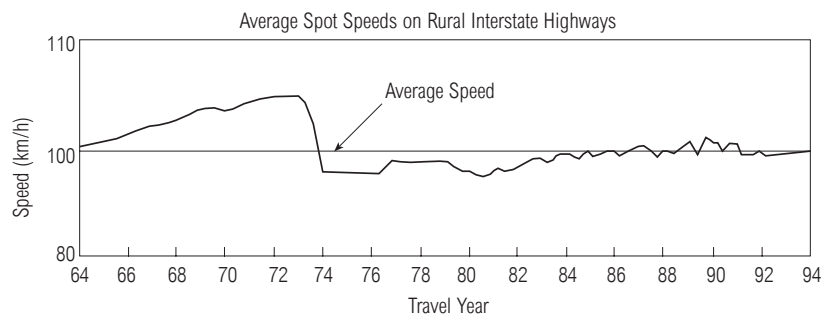

Note:

The data from 1965 to 1979 represent free-moving traffic on level, uncongested sections of the rural Interstate system. Beginning with 1980, the data represent all vehicle travel on the rural Interstate system.

Source: 1994 revision of Chapters 1 and 2 of the *Highway Capacity Manual*.

EXHIBIT 8-25. NATIONAL SPOT SPEED TRENDS FOR 90-km/h FACILITIES

Fiscal Year	Average Speed (km/h)	Median Speed (km/h)	85th Percentile Speed (km/h)	Percent > 90 km/h
Urban Interstate Highways				
1985	92.1	92.4	103.0	64.1
1987	93.3	93.3	104.3	67.4
1989	94.8	94.9	106.4	71.3
1991	94.6	94.6	106.4	69.8
Rural Interstate Highways				
1985	95.8	95.6	106.4	75.4
1987	96.1	96.8	107.0	73.7
1989	96.7	97.0	108.1	76.8
1991	96.4	95.6	108.1	75.5
Rural Streets				
1985	88.4	88.8	99.3	50.5
1987	90.0	90.3	101.1	54.3
1989	90.4	90.8	101.5	56.0
1991	90.8	90.6	101.5	54.5
Urban Principal Streets				
1985	86.1	86.3	97.4	42.1
1987	86.9	87.1	97.7	44.7
1989	87.9	88.7	98.7	47.7
1991	86.9	86.7	97.8	42.2

Note:

All highways have 90-km/h speed limit.

Source: Highway Statistics, Federal Highway Administration, 1992.

Aside from the general interest in the speed limit issue, these speed trends affect the procedures presented in this manual. Uninterrupted-flow procedures incorporate national average speed-flow and speed-density trends. The exact shape of these curves and the calibration of speeds (especially at the free-flow end of the relationships) reflect current trends. Curves used in this manual allow for average speeds of up to 120 km/h in response to the observed increase in driver-selected speeds under free-flow conditions.

Speed Variation by Time of Day

Exhibits 8-26 and 8-27 show variations of speed with time of day, along with hourly volume variations, over a 24-h period for I-35W in Minneapolis. Exhibit 8-26 shows the weekday pattern, whereas Exhibit 8-27 shows a similar distribution for Saturdays.

In these exhibits note that speed remains relatively constant despite significant changes in volume. In Exhibit 8-26, speed shows a marked response to volume increases only when the volume exceeds approximately 1,600 veh/h/ln. This trend is illustrated later and is an important characteristic in the procedures of this manual. If speed does not vary with flow rate over a broad range of flows, it becomes difficult to use speed as the sole measure for defining level of service. This important characteristic is the major reason why such measures as density have been introduced as primary measures of effectiveness for uninterrupted-flow facilities, with speed playing a secondary role.

Speed is not significantly affected by volume over a wide range of demand

EXHIBIT 8-26. SPEED AND VOLUME VARIATIONS BY HOUR OF DAY (WEEKDAYS)

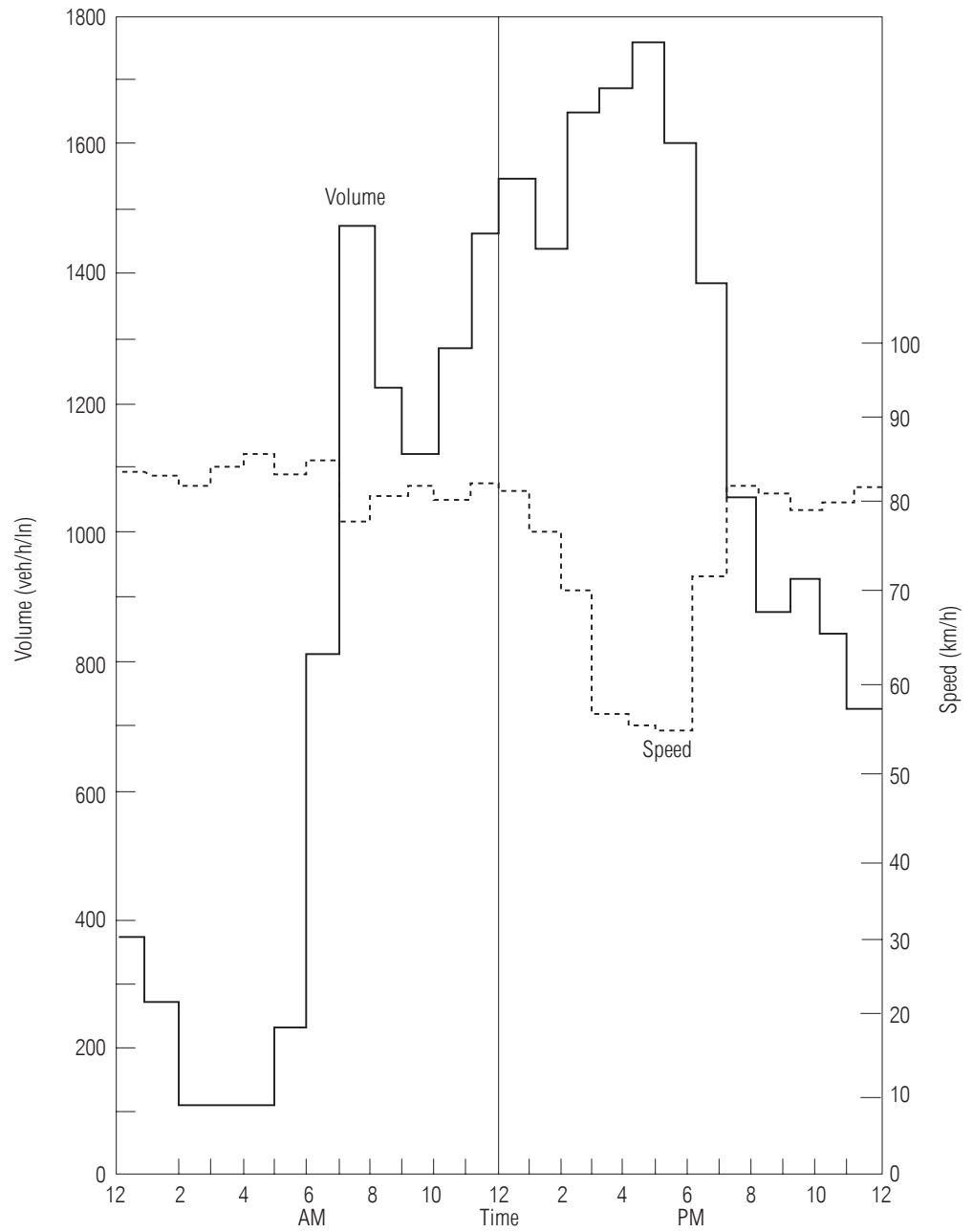

Source: Minnesota Department of Transportation.

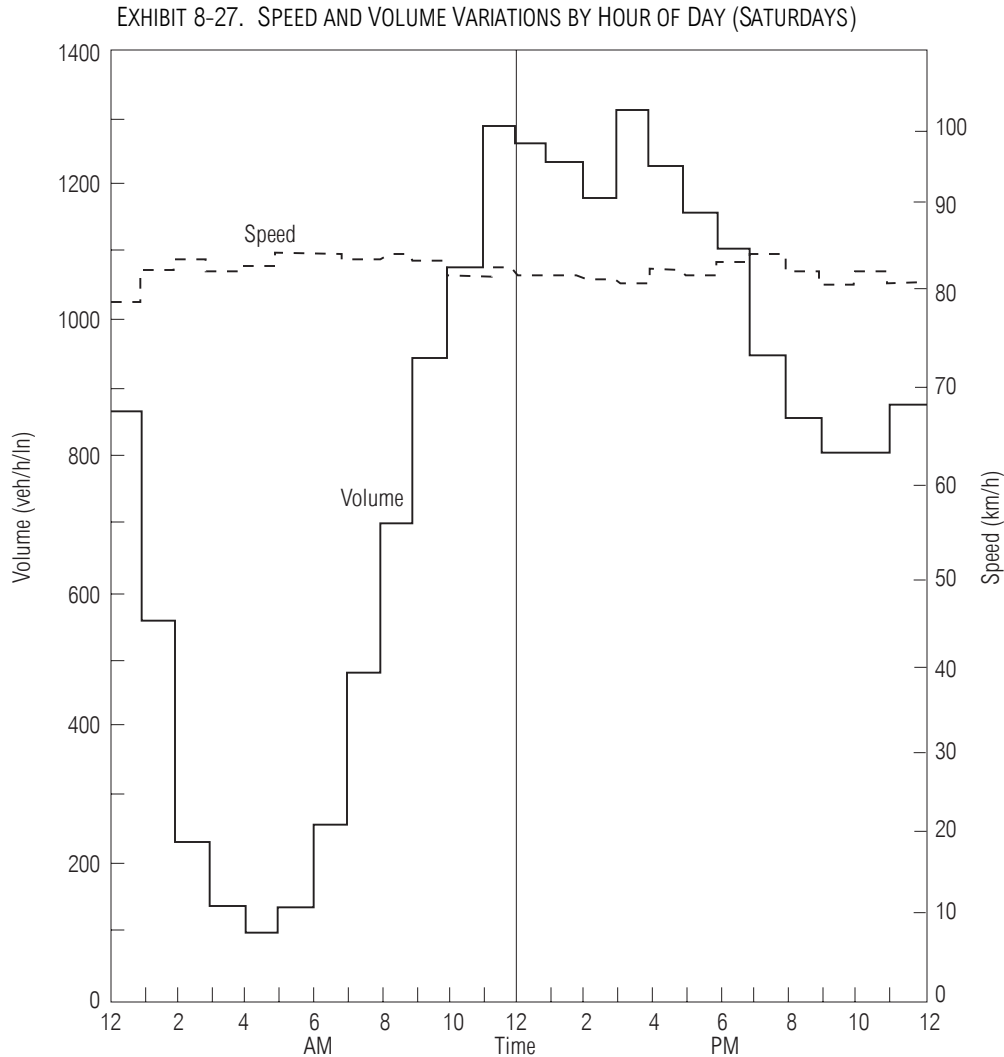

Source: Minnesota Department of Transportation.

HEADWAY DISTRIBUTIONS AND RANDOM FLOW

The average headway in a lane is the reciprocal of the flow rate. Thus, at a flow of 1,200 veh/h/ln, the average headway is $3,600/1,200$ or 3 s. Vehicles do not, however, travel at constant headways. Vehicles tend to travel in groups, or platoons, with varying headways between successive vehicles. An example of the distribution of headways observed on the Long Island Expressway is shown in Exhibit 8-28. Lane 3 has the most uniform headway distribution, as evidenced by the range of values and the high frequency of the modal value, which is the peak of the distribution curve. The distribution of Lane 2 is similar to that of Lane 3, with slightly greater scatter (range from 0.5 to 9.0 s). Lane 1 shows a much different pattern: it is more dispersed, with headways ranging from 0.5 to 12.0 s, and the frequency of the modal value is only about one-third of that for the other lanes. This indicates that flow rate in the shoulder lane is usually lower than flow rates in the adjacent lanes when the total flows are moderate to high on the facility.

Exhibit 8-28 shows relatively few headways less than 1.0 s. A vehicle traveling at 95 km/h (26 m/s) would have a spacing of 26 m with a 1.0-s headway, and only 13 m with a 0.5-s headway. This effectively reduces the space between vehicles (rear bumper to front bumper) to only 7.5 to 9.0 m. This spacing (also called gap) would be extremely difficult to maintain.

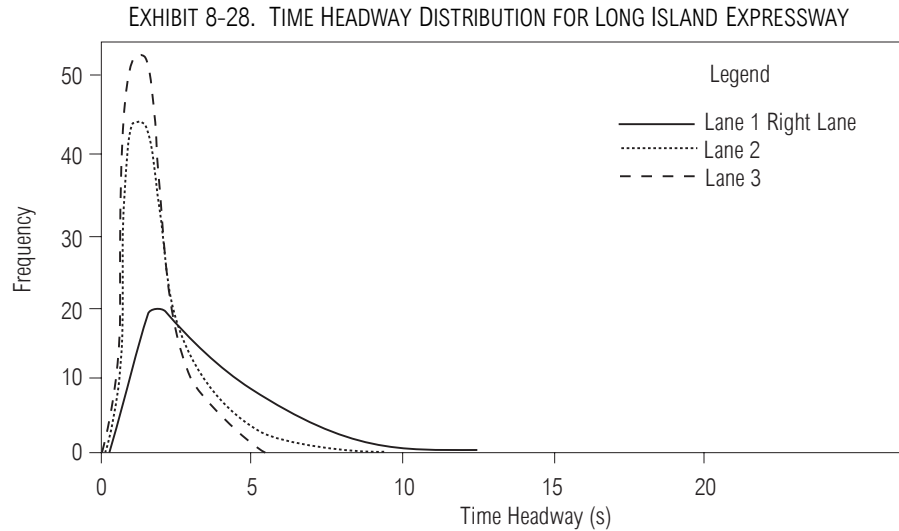

Source: Berry and Gandhi (13).

Drivers react to this intervehicle spacing, which they perceive directly, rather than to measures of headway. The latter include the length of the vehicle, which became smaller for passenger cars in the vehicle mix of the 1980s. In the 1990s, a larger vehicle mix is observed due to the popularity of sport utility vehicles. If drivers maintain essentially the same intervehicle spacing and car lengths continue to increase, some decreases in capacity could conceivably result.

If traffic flow were truly random, small headways (less than 1.0 s) could theoretically occur. Several mathematical models have been developed that recognize the absence of small headways in most traffic streams (14).

SATURATION FLOW AND LOST TIME AT SIGNALIZED INTERSECTIONS

The basic concepts of saturation headway, saturation flow rate, and start-up and change interval lost times were introduced elsewhere in this chapter. Exhibit 8-29 summarizes the results of representative past and recent studies. The table indicates that saturation headways have been shortening in the last decade, and consequently saturation flow rates have been increasing. This trend has been observed by both practicing professionals and researchers (28). In the table, saturation headway ranges from a low of 1.8 s to a high of 2.4 s, corresponding to a range of saturation flow rates of 2,000 to 1,500 pc/h/ln.

Exhibit 8-30 shows vehicle headway by position in the queue resulting from several past studies. It shows that, in most studies, the saturation headway does not become established until the sixth or seventh vehicle in the queue, indicating that the first five or six vehicles experience some start-up lost time. In discussing the results of Exhibit 8-30 (28), it was noted that the variation in discharge headways of the first several vehicles depended on the choice of a screenline for measuring headways rather than any real difference in the observed headways. Stop lines or curb lines have been used in combination with the front bumper, front or rear axles, or rear bumper. Caution is therefore advisable in comparing values of discharge headways from different studies. This manual uses the stop line as the screenline and the front wheels (or axle) as the measurement benchmark. Some other national practices apply different definitions or measurement techniques of saturation flow (15, 28–32). For that reason, the values quoted in international literature are not quite comparable (30, 31). The Canadian survey technique (31), however, allows the estimation of saturation flow rates for situations with queues as short as four to five vehicles. Saturation flow rates cited in various sources may also be influenced by the choice of vehicle positions and by the definition of lost time (16).

Saturation flow rates have been increasing with time

EXHIBIT 8-29. OBSERVED SATURATION FLOW RATES AT SIGNALIZED INTERSECTIONS

Date of Study	City or State	Sample Size	Saturation Flow Measurement Starting With Queue Position Number	Start-Up Lost Time (s)	Saturation Flow Rate (pc/h/ln)	Saturation Headway (s)
1967	Los Angeles, Santa Monica, California	6 Int.	5	2.05	1470	2.45
1971	Ames, Iowa	4 Int.	4	0.75	1572	2.29
1976	Nationwide		5	-	1682	2.14
1983	Lexington, Kentucky		4	1.40	1651	2.18
1986	Lawrence, Kansas		5	3.04	1827	1.97
1986	Austin, Dallas, Houston	8 h 3 Int.	6	-	2000	1.8
1986	Chicago, Houston, Los Angeles	7 Int.		1.31	1875	1.92
1987	Houston (peak)	30 h 2 Int.	5	-	1896	1.9
1987	Houston (off peak)	30 h 2 Int.	5	-	1832	1.97
1987	Los Angeles (peak)	34 h 2 Int.	5	-	1936	1.86
1987	Los Angeles (off peak)	34 h 2 Int.	5	-	1785	2.02
1988	Chicago	6.25 h 10 Int.	4	-	2000	1.8
1988	California, New York, Texas (single lane)	5 Int.	5	-	1791	2.01
1988	California, Illinois, New York, Texas (multilane)	7 Int.	5	-	1937	1.86
1989	College Station, Texas	30 h 2 Int.	4	1.31	1905	1.89
1991	Dallas	25 h 4 Int.	5	-	1910	1.88
1992	Florida	16 Int.	-	-	1840	1.96

Sources: References 15–27.

Although most studies of intersection discharge headways have focused on the observation of the first 10 to 12 vehicles, there is some indication that the saturation headway may increase somewhat when green time becomes quite long. This effect implies that green phases longer than 40 or 50 s may not be proportionally as efficient as shorter phases (31).

Research (33) has shown the significance of prevailing conditions of lane width, parking, transit interference, pedestrian interference, turning movements, flow composition, signal progression, and other factors, all of which influence saturation flow values. For base conditions, including 3.6-m lanes, all through vehicles, all passenger cars, no parking, no transit interference, and low pedestrian volumes, the procedures of Chapter 16 recommend a saturation flow rate of 1,900 pc/h/ln, corresponding to a saturation flow headway of 1.9 s.

Start-up lost times were also measured during the studies identified in Exhibit 8-29 and other research projects (34) for a variety of conditions, including city size (population), location within the city, signal timing, speed limit, and other factors. Typical observed values range from 1.0 s to about 2.0 s. The variation in the data in Exhibit 8-29 and the importance of prevailing conditions suggest that local data collection be performed to determine saturation flow rates and lost times, which can lead to more accurate computations.

Saturation flow rates may decrease with long green times

EXHIBIT 8-30. RESEARCH RESULTS ON QUEUE DISCHARGE HEADWAYS

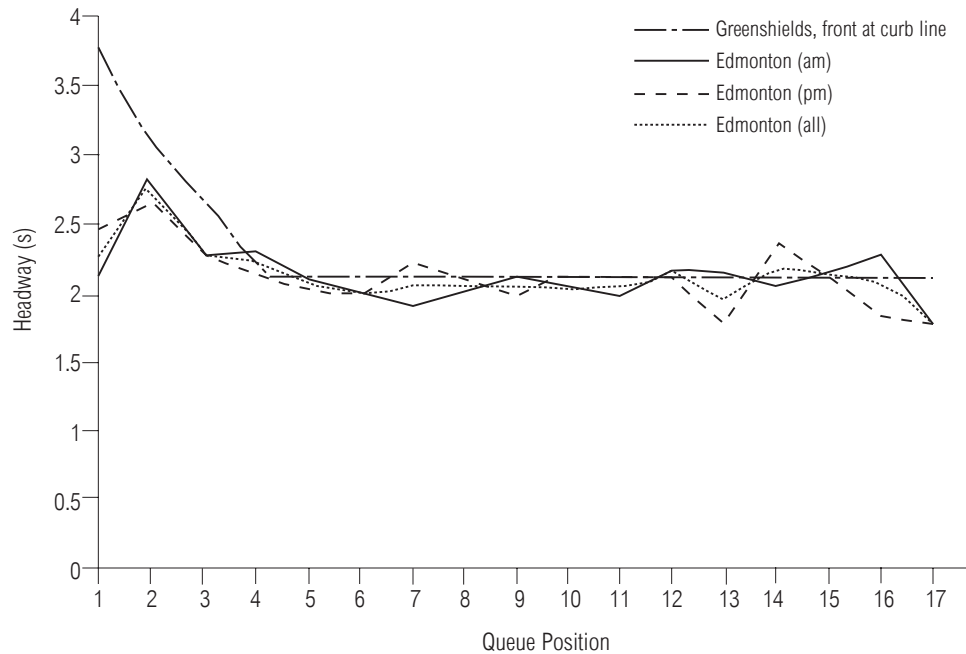

Source: Teply and Jones (28).

SATURATION FLOW AT UNSIGNALIZED INTERSECTIONS

Saturation flow at a stop line on all-way stop-controlled intersections depends on the presence of vehicles on other approaches. When no traffic is present on other intersection approaches, the saturation flow rate on a single-lane approach is reported at 1,100 veh/h (35). For an intersection with four evenly loaded approaches and base conditions, 2,000 veh/h is reported (35).

BUS AND PASSENGER FLOWS

The highest bus volumes experienced in a transit corridor in North America, 735 buses per hour through the Lincoln Tunnel and on the Port Authority Midtown Bus Terminal access ramps in the New York metropolitan area, are achieved on exclusive rights-of-way where buses make no stops (and where an 800-berth bus terminal is provided to receive these and other buses) (36). Where bus stops or layovers are involved, reported bus volumes are much lower. Exhibit 8-31 shows bus flow experience for North American cities.

When intermediate stops are made, bus volumes rarely exceed 120 buses per hour. However, volumes of 180 to 200 buses per hour are feasible where buses may use two or more lanes to allow bus passing. An example is Hillside Avenue in New York City. Two parallel bus lanes in the same direction, such as along Madison Avenue in New York, and the 5th and 6th Avenue Transit Mall in Portland, Oregon, also achieve this flow rate. Up to 45 buses one-way in a single lane in 15 min (a flow rate of 180 buses per hour) were observed on Chicago's State Street Mall; however, this flow rate was achieved by advance marshaling of buses into platoons of three buses and by auxiliary rear-door fare collection during the evening peak hours to expedite passenger loading.

Several downtown streets where there are two or three boarding positions per stop and where passenger boarding is not concentrated at a single stop carry bus volumes of 80 to 100 buses per hour. This frequency corresponds to about 5,000 to 7,500 passengers per hour, depending on passenger loads.

Exclusive busway volumes

Bus malls

EXHIBIT 8-31. OBSERVED PEAK-DIRECTION, PEAK-HOUR PASSENGER VOLUMES ON U.S. AND CANADIAN BUS TRANSIT ROUTES—1995 DATA

Location	Facility	Peak-Hour, Peak-Direction Buses	Peak-Hour, Peak-Direction Passengers	Average Passengers per Bus
New Jersey	Lincoln Tunnel	735 ^a	32,600	44
New York City	Madison Avenue	180	10,000	55
New York City	Long Island Expy.	165	7840	48
New York City	Gowanus Expy.	150	7500	35
Northern Virginia	Shirley Highway	160	5000	35
San Francisco	Bay Bridge	135	5000	37
Ottawa	West Transitway	225	11,100	49
Pittsburgh	East Busway	105	5400	51
Portland, OR	6th Avenue	175	8500	50
Newark	Broad Street	150	6000	40

Note:

a. No stops.

Source: Levinson and St. Jacques (36).

These bus volumes provide initial capacity ranges that are suitable for general planning purposes. They compare with maximum streetcar volumes on city streets in the 1920s, which approached 150 cars per track per hour, under conditions of extensive queuing and platoon loading at heavy stops (37). However, the streetcars had two operators and large rear platforms where boarding passengers could assemble. Peak-hour bus flows observed at 13 major bus terminals in the United States and Canada range from 2.5 buses per berth at the George Washington Bridge Terminal in New York to 19 buses per berth at the Eglinton Station, Toronto.

The high berth productivity in Toronto reflects the special design of the terminal (with multiple positions in each berthing area), the wide doors on the buses using the terminal, and other factors. The relatively low productivity at the New York terminals reflects the substantial number of intercity buses using the terminals (which occupy berths for longer periods of time) and the single entrance doors provided on many suburban buses. This experience suggests an average of 8 to 10 buses per berth per hour for commuter operations. Intercity berths typically can accommodate one or two buses per hour.

The operating experience for typical light rail transit and streetcar lines in the United States and Canada is given in Exhibit 8-32. This exhibit lists typical peak-hour, peak-direction passenger volumes, service frequencies, and train lengths for principal U.S. and Canadian light rail transit lines.

Historic streetcar volumes

Buses occupy loading areas at bus terminals for much longer periods of time than they occupy loading areas at on-street bus stops

EXHIBIT 8-32. OBSERVED U.S. AND CANADIAN LIGHT RAIL TRANSIT PASSENGER VOLUMES, PEAK HOUR AT THE PEAK POINT FOR SELECTED LINES (1993–1996 DATA)

City	Location (May be Trunk with Several Routes)	Trains/h	Cars/h	Avg. Headway (s)	Pass/Peak Hour Direction	Pass/m of Car Length
Calgary	South Line	11	33	320	4950	6.8
Denver	Central	12	24	300	3000	4.7
Edmonton	Northeast LRT	12	36	300	3220	4.0
Los Angeles	Blue Line	9	18	400	2420	5.4
Boston	Green Line Subway ^a	45	90	80	9600	5.3
Newark	City Subway	30	30	120	1760	4.6
Philadelphia	Norristown	8	8	450	480	3.3
Philadelphia	Subway-Surface ^a	60	60	60	4130	5.0
San Francisco	Muni Metro ^a	23	138	156	13,100	4.8
Sacramento	Sacramento LRT	4	12	900	1310	4.9
Toronto	Queen at Broadway ^a	51	51	70	4300	6.1
Portland, OR	Eastside MAX	9	16	400	1980	5.1

Note:

a. Trunks with multiple-berth stations.

In a single hour a route may have different lengths of trains and/or trains with cars of different lengths or seating configurations. Data represent the average car. In calculating the passengers per meter of car length, the car length is reduced by 9% to allow for space lost to driver cabs, stairwells, and other equipment.

Source: Parkinson and Fisher (38).

IV. REFERENCES

1. *Traffic Engineering Handbook*, 4th ed. Prentice-Hall, Englewood Cliffs, N.J., 1992.
2. Muranyi, T. C. A Method of Estimating Traffic Behavior on All Routes in a Metropolitan County. In *Highway Research Record 41*, HRB, National Research Council, Washington, D.C., 1963, pp. 61–78.
3. *Transportation and Traffic Engineering Handbook*, 2nd ed. Prentice-Hall, Englewood Cliffs, N.J., 1982.
4. McShane, W. R., and K. W. Crowley. Regularity of Some Detector-Observed Arterial Traffic Volume Characteristics. In *Transportation Research Record 596*, TRB, National Research Council, Washington, D.C., 1976, pp. 33–37.
5. Crabtree, J. D., and J. A. Deacon. Highway Sizing. In *Transportation Research Record 869*, TRB, National Research Council, Washington, D.C., 1982, pp. 6–14.
6. Werner, A., and T. Willis. Cost-Effective Level of Service and Design Criteria. In *Transportation Research Record 699*, TRB, National Research Council, Washington, D.C., 1979, pp. 1–7.
7. *Florida's Level of Service Standards and Guidelines Manual for Planning*. Systems Planning Office, Florida Department of Transportation, Tallahassee, 1995.
8. Levinson, H. *Characteristics of Urban Transportation Demand—A Handbook for Transportation Planners*. Urban Mass Transportation Administration, U.S. Department of Transportation, 1978.
9. *Development of Diurnal Traffic Distribution and Daily, Peak, and Off-Peak Vehicle Speed Estimation Procedures for Air Quality Planning*. Final Report, Work Order B-94-06. Comsis, Federal Highway Administration, Washington, D.C., April 1996.

10. Huber, M. J., and J. L. Tracy. Operating Characteristics of Freeways. In *NCHRP Report 60: Effects of Illumination on Operating Characteristics of Freeways*, HRB, National Research Council, Washington, D.C., 1968, pp. 3–48.
11. *Quick Response Freight Manual, Travel Model Improvement Program*. U.S. Department of Transportation, 1996.
12. *Two-Lane Rural Roads: Design and Traffic Flow*. Organization for Economic Cooperation and Development, Paris, France, 1972.
13. Berry D. S., and P. K. Gandhi. Headway Approach to Intersection Capacity. In *Highway Research Record 453*, HRB, National Research Council, Washington, D.C., 1973, pp. 56–60.
14. Gerlough, D. L., and M. J. Huber. *Special Report 165: Traffic Flow Theory: A Monograph*. TRB, National Research Council, Washington, D.C., 1975.
15. King, G. F., and M. Wilkinson. Relationship of Signal Design to Discharge Headway, Approach Capacity, and Delay. In *Transportation Research Record 615*, TRB, National Research Council, Washington, D.C., 1976, pp. 37–44.
16. Zegeer, J. D. Field Validation of Intersection Capacity Factors. In *Transportation Research Record 1091*, TRB, National Research Council, Washington, D.C., 1986, pp. 67–77.
17. Gerlough, D. L., and F. A. Wagner. *NCHRP Report 32: Improved Criteria for Traffic Signals at Individual Intersections*. HRB, National Research Council, Washington, D.C., 1967.
18. Carstens, R. L. Some Parameters at Signalized Intersections. *Traffic Engineering*, Aug. 1971.
19. Agent, K., and J. Crabtree. *Analysis of Lost Times at Signalized Intersections*. Kentucky Transportation Research Program, University of Kentucky, Lexington, 1983.
20. Lee, J., and R. L. Chen. Engineering Headway at Signalized Intersections in a Small Metropolitan Area. In *Transportation Research Record 1091*, TRB, National Research Council, Washington, D.C., 1986, pp. 117–126.
21. Molina, C. J., C. J. Messer, and D. B. Fambro. *Passenger Car Equivalencies for Large Trucks at Signalized Intersections*. TTI Research Report 397-2. Texas Transportation Institute, Texas A&M University, College Station, 1987.
22. Fambro, D. B., E. C. P. Chang, and C. J. Messer. *NCHRP Report 339: Effects of the Quality of Traffic Signal Progression on Delay*. TRB, National Research Council, Washington, D.C., 1991.
23. Prevedouros, P. D., and P. P. Jovanis. Validation of Saturation Flows and Progression Factors for Traffic-Actuated Signals. In *Transportation Research Record 1194*, TRB, National Research Council, Washington D.C., 1988, pp. 147–159.
24. Roess, R. P., J. M. Papayannopoulos, J. M. Ulerio, and H. S. Levinson. *Levels of Service in Shared-Permissive Left-Turn Lane Groups at Signalized Intersections*. Report DTFH 61-87-C-00012. Transportation Training and Research Center, Polytechnic University, Brooklyn, N.Y., 1989.
25. Short, J. T. *Effects of Dips and Bumps on Saturation Flow Rates at Signalized Intersections*. Thesis. Texas A&M University, College Station, 1989.
26. Gaston, G. D. *An Operation Analysis of Protected Lead-Lag Left Turn Phasing*. Thesis. Texas A&M University, College Station, 1991.
27. Zegeer, J. *Data Collected for Florida Department of Transportation*. 1992.
28. Tepley, S., and A. M. Jones. Saturation Flow: Do We Speak the Same Language? In *Transportation Research Record 1320*, TRB, National Research Council, Washington, D.C., 1991, pp. 144–153.
29. Akcelik, R. *Traffic Signal: Capacity and Timing Analysis*. Research Report ARR 123. Australian Road Research Board, Victoria, 1981.

30. Teply, S. (ed.). *Canadian Capacity Guide for Signalized Intersections*, 1st ed. Institute of Transportation Engineers, District 7, Canada, and University of Alberta, Edmonton, Alberta, Canada, 1984.
31. Teply, S., D. Allingham, D. Richardson, and B. Stephenson. *Second Edition of the Canadian Capacity Guide for Signalized Intersections*. Institute of Transportation Engineers, District 7, Canada, 1995.
32. Richtlinien fuer Lichtsignalanlagen, Forschungsgesellschaft fuer Strassen- und Verkehrswesen. Köln, Germany, 1992.
33. Agent, K., and J. Crabtree. *Analysis of Saturation Flow at Signalized Intersections*. Kentucky Transportation Research Program, University of Kentucky, Lexington, Feb. 1983.
34. Bonneson, J. Change Interval Timing and Lost Time for Single Point Urban Interchanges. *Journal of Transportation Engineering*, Vol. 118, No. 5, 1992.
35. *Transportation Research Circular 373: Interim Materials on Unsignalized Intersection Capacity*. TRB, National Research Council, Washington, D.C., 1991.
36. Levinson, H. S., and K. R. St. Jacques. Bus Lane Capacity Revisited. In *Transportation Research Record 1618*, TRB, National Research Council, Washington, D.C., 1998, pp. 189–199.
37. Blake, H. W., and W. Jackson. *Electric Railway Transportation*. McGraw-Hill Book Company, New York, 1924.
38. Parkinson, T., and I. Fisher. *TCRP Report 13: Rail Transit Capacity*. TRB, National Research Council, Washington, D.C., 1996.

CHAPTER 9

ANALYTICAL PROCEDURES OVERVIEW

CONTENTS

I. INTRODUCTION9-1

II. OVERVIEW OF ANALYTICAL PROCEDURES9-1

III. PRECISION AND ACCURACY OF THE MANUAL9-2

 Precision and Accuracy Framework9-2

 Constraint of Prior Research Results9-3

 Calculation Precision Versus Display Precision9-6

 Implied Precision from Displayed Results9-6

 Directives from TRB Committee9-6

 Specific Components for Presentation Guideline9-6

 Input Values9-6

 Adjustment Factors9-7

 Example Service Volume Tables9-7

 Free-Flow Speed9-7

 Speeds9-7

 Volume to Capacity Ratios9-7

 Delay9-7

 Pedestrian Space9-7

 Occurrences and Events9-7

 General Factors9-7

 Displayed Results9-7

 Average Values9-8

 Sensitivity to Input Variables9-8

IV. HOURLY AND DAILY VOLUME EQUIVALENCIES9-8

V. USE OF DEFAULT VALUES9-9

VI. SERVICE VOLUME TABLES9-9

VII. REFERENCE9-10

APPENDIX A. DEVELOPING LOCAL DEFAULTS9-10

APPENDIX B. DEVELOPING SERVICE VOLUME TABLES9-11

EXHIBITS

Exhibit 9-1. Structure of HCM 2000 Methodologies9-4

Exhibit 9-2. Typical Default Values for PHF, K, and D9-9

Exhibit A9-1. Example Default Stratification Scheme9-10

I. INTRODUCTION

In this chapter, a brief overview of the analytical procedures in this manual, their organization into chapters, and guidance on their general application are provided.

The analytical procedures in this manual can be used for a number of applications covering a broad range of facility types. The facility types are distributed among five categories: urban streets, pedestrian and bicycle facilities, highways, freeways, and transit.

In Chapters 10 through 14, for each of the five categories, general concepts are presented, required inputs for each methodology are identified, reasonable approximations for specific parameters are suggested for use if local data are not available, and example service volume tables are provided. The Part II chapters also contain special procedures used to supplement the planning applications defined in the Part III chapters.

Chapters 10–14 of Part II present general concepts

II. OVERVIEW OF ANALYTICAL PROCEDURES

For the analytical methods defined in Part III, the calculations of average speed, density, and delay will provide insight into the level of service for what is considered a steady-state condition. This means that the outputs provided by the computational methods are considered representative for the length or area of the analysis and for the duration of the analysis period. Thus, the *Highway Capacity Manual* (HCM) methods are generally not appropriate (unless the analyst performs a special intervention) for the evaluation of inclement weather conditions, accidents or construction activities, queues that are building over both time and space, or the possible effects of vehicle guidance or driver guidance systems typical of intelligent transportation systems. However, some guidelines are identified in Chapter 22 to address these conditions.

The Part III methods have been designed to be sensitive to roadway, traffic, and control characteristics of the facility. However, the methods cannot predict the effects of changes in the posted speed limit, the level of police enforcement, safety features, driver education, or vehicle performance.

A ground transportation system is composed of six modal and facility type subsystems located in a defined study area or corridor. The six subsystems are freeway, urban street, rural highway, transit, pedestrian, and bicycle. Each transportation subsystem is composed of two or more individual facilities. The facilities within each subsystem are all of a single type (freeway, urban street, rural highway) or mode (transit, pedestrian, bicycle). Each facility is in turn made up of segments and points. For example, a freeway contains basic, weaving, and ramp merge/diverge segments. An urban street contains street segments and intersections (points).

A segment is a length of facility where demand and capacity are relatively constant. Each segment begins and ends at a point. Segments are generally directional; for example, each stretch of two-way street is composed of two one-way segments. The exception to this is two-lane highways, where each segment is bidirectional but can be split into two directional segments for analysis. A point is a very short length of facility where demand or capacity changes abruptly from conditions on the upstream or downstream segment.

Analysis of the transportation system proceeds from estimates of travel times and delays at the segment and point levels using the methods described in Part III. Segment and point delays and travel times are converted to total person hours of delay or travel time and then summed to obtain facility estimates.

Part III, Chapters 15–27, presents methodologies

A facility is composed of segments and points

Part IV, Chapters 28–30, presents corridor and areawide analyses

Part V contains information on simulation and other models

For analyses that combine facility types or that address a corridor or expanded area, the analyst must consult Part IV. Part V contains useful information on applications of simulation and other models to complement the use of HCM 2000 methodologies.

Exhibit 9-1 illustrates the content, by chapter, of the analytical sections of this manual. Outputs from computations based on the methodologies are also indicated.

Most of the analytical processes require estimates of hourly demand in one direction. The section on equivalency of hourly and daily volumes provides guidance on determining directional hourly volumes from average daily traffic volumes. The analytical procedures in Part III (Chapters 15 through 27) require information on the geometric design, control, and demand for the facility being analyzed. The following sections provide some brief guidance on the development of local default values for input data that are difficult to obtain. Generic default values that may be used for specific facility analyses in the absence of local values are provided in Chapters 10 through 14.

Some of the analytical procedures can be quite complex. Analysts may wish to develop tables of maximum service volumes for typical highway facilities in their area. The tables may be used in planning studies to roughly size a facility when resources do not permit more detailed analyses. Guidance on the development of local service volume tables is provided in Appendix B. Examples of service volume tables are given in Chapters 10 through 14.

III. PRECISION AND ACCURACY OF THE MANUAL

The presentation of numerical values and calculations in this manual is based on a long history of evolving methodologies for assessing capacity and quality of service. The first HCM was produced in 1950. It was followed by a series of manuals, the last update being the 1997 HCM. A large number of researchers and research projects in the past 50 years have contributed to the methodologies presented in this, the 2000 edition. To provide a better understanding of the framework in which this edition was developed, the accuracy and precision of numerical values are discussed.

The terms accuracy and precision are independent but complementary concepts. Accuracy relates to achieving a correct answer, while precision relates to the size of the estimation range of the parameter in question. As an example of accuracy, consider a method that is applied to estimate a performance measure. If the performance measure is delay, an accurate method would provide an estimate closely approximating the actual delay that occurs under field conditions. The precision of such an estimate is the range that would be acceptable from an analyst's perspective in providing an accurate estimate. Such a range might be expressed as the central value for the estimated delay plus or minus several seconds. In general, the inputs used for the methodologies in this manual are from field observations or estimates of future conditions. In either case, and particularly for future conditions, the inputs can only be expected to be accurate to within 5 or 10 percent of the true value. Thus, the computations performed cannot be expected to be extremely accurate, and the final results must be considered as estimates that are accurate and precise only within the limits of the input values used.

To provide numerical values and computational results that are relatively easy to use and that indicate the presumed accuracy and precision, a framework of guidelines was established during preparation of this manual. In the following sections, an explanation of this framework is given.

PRECISION AND ACCURACY FRAMEWORK

The user of the HCM should be aware of the limitations of the accuracy and precision of the methodologies in the manual. Such awareness will help the user to

interpret the results of an analysis and to use the results to make a decision on design or operation of a transportation facility.

Many of the models in the HCM are based on theoretically derived relationships, which include assumptions and contain parameters that must be calibrated on the basis of field data. Other models in the HCM are primarily statistical. Both types require data collected at a sampling of sites. The degree to which the models reflect reality is often stated in terms of the accuracy and precision of the model. Accuracy and precision are terms used to express the probable error associated with an estimate.

Frequently, after a model is developed, it is validated by comparing the estimates from the model with values measured in the field from an independent set of sites. A regression line fitted to the plot of points for field-measured versus model-estimated values will result in a line with a slope different from 45 degrees. The difference can be considered the relative accuracy of the model. The dispersion of the points around the regression line can be considered the precision of the model. The measure of dispersion with which many analysts are familiar is the R^2 value. These statistics, based on field and predicted data, indicate the limitations of the models in predicting with great precision and accuracy.

Few of the models in the HCM have well-documented measures of accuracy and precision. Typically, when research is completed and statistical relationships are reported, the Committee on Highway Capacity and Quality of Service will exercise its judgment in modifying the results.

Prediction error from other sources may also result when the user applies the HCM. For example, the accuracy of results may be reduced by the use of default values for one or more of the parameters in the models. In addition, there are limitations on the accuracy and precision of traffic inputs used in these models. Traffic measurements and predictions, including magnitude and mix of traffic, have inherent limitations on accuracy.

The limitations on the accuracy and validity of predictions of performance measures should be recognized in applying the results of an analysis. For instance, small differences between the values of performance measures for alternative designs should not always be assumed to be real (statistically significant) differences. Furthermore, if the predicted value for a measure of effectiveness is near, but below, a critical threshold, there is some probability that it will in fact be higher than predicted and exceed the critical threshold. The HCM user should recognize, therefore, that judgment is required in applying the results of analyses. One basis for that judgment is a good understanding of the structure and basis of the models used in this manual.

Constraint of Prior Research Results

The methodologies in this manual have been developed by a number of researchers working on many research projects. Few of these projects have presented results with accompanying statements on precision and accuracy. Rather, most of the methods have involved the use of mean or average values for parameters. Results have been presented in a variety of forms with regard to the use of tables, graphs, and interpolated values. The number of digits to the right of the decimal point in factors, calculated values of performance measures, and threshold values used to define level of service has also varied. In general, it was considered prudent to follow the presented results and the significant figures used in prior research rather than to change the recommended values arbitrarily. Whenever possible, the tabulated factors and adjustments and the final calculated values of performance measures used in the reported research were maintained for the methods in this manual.

Several factors result in limitation on the accuracy and precision of HCM analysis

Research precision and accuracy

Exhibit 9-1. Structure of HCM 2000 Methodologies

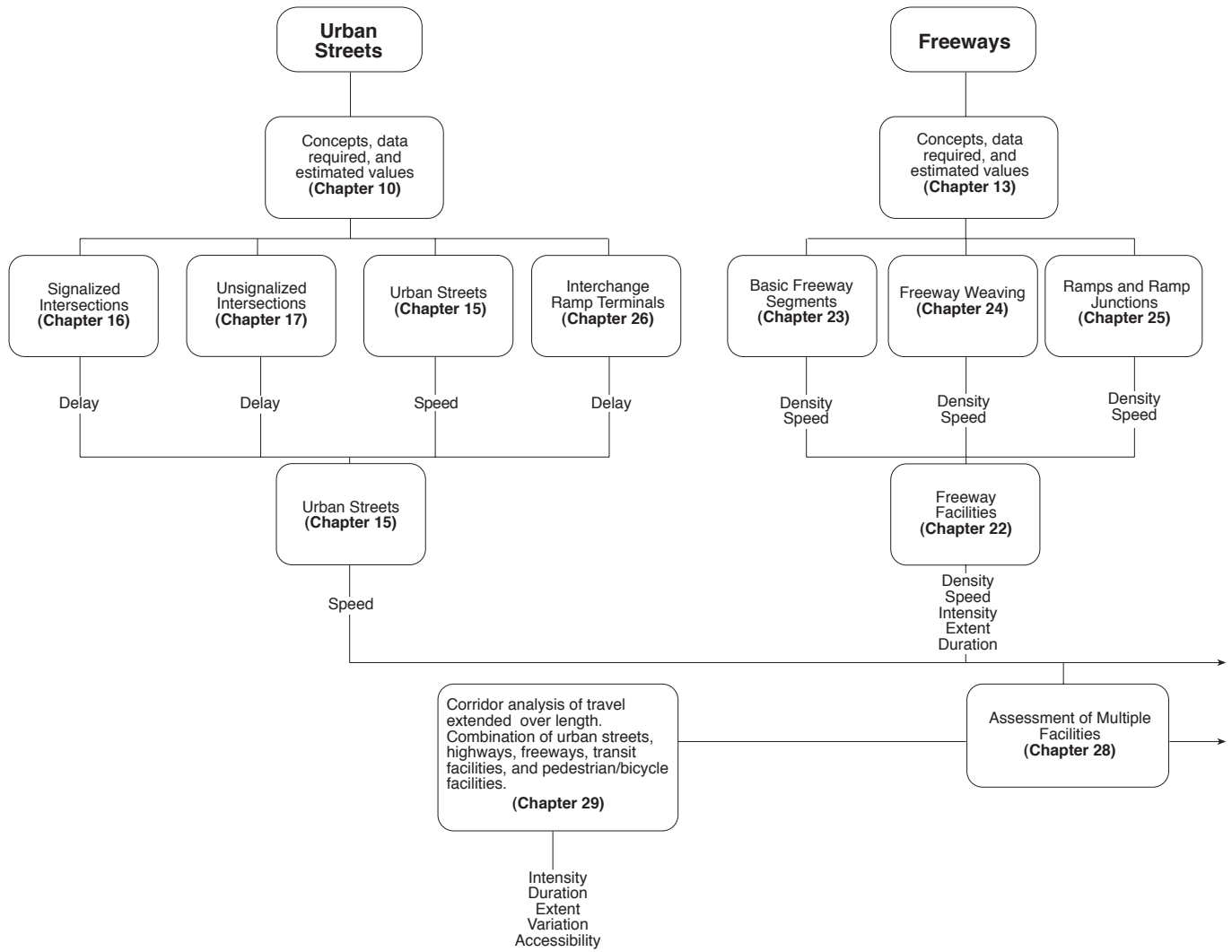

Discussion of simulation models and their applications with numerical exercises (Chapter 31).

Exhibit 9-1 (continued). Structure of HCM 2000 Methodologies

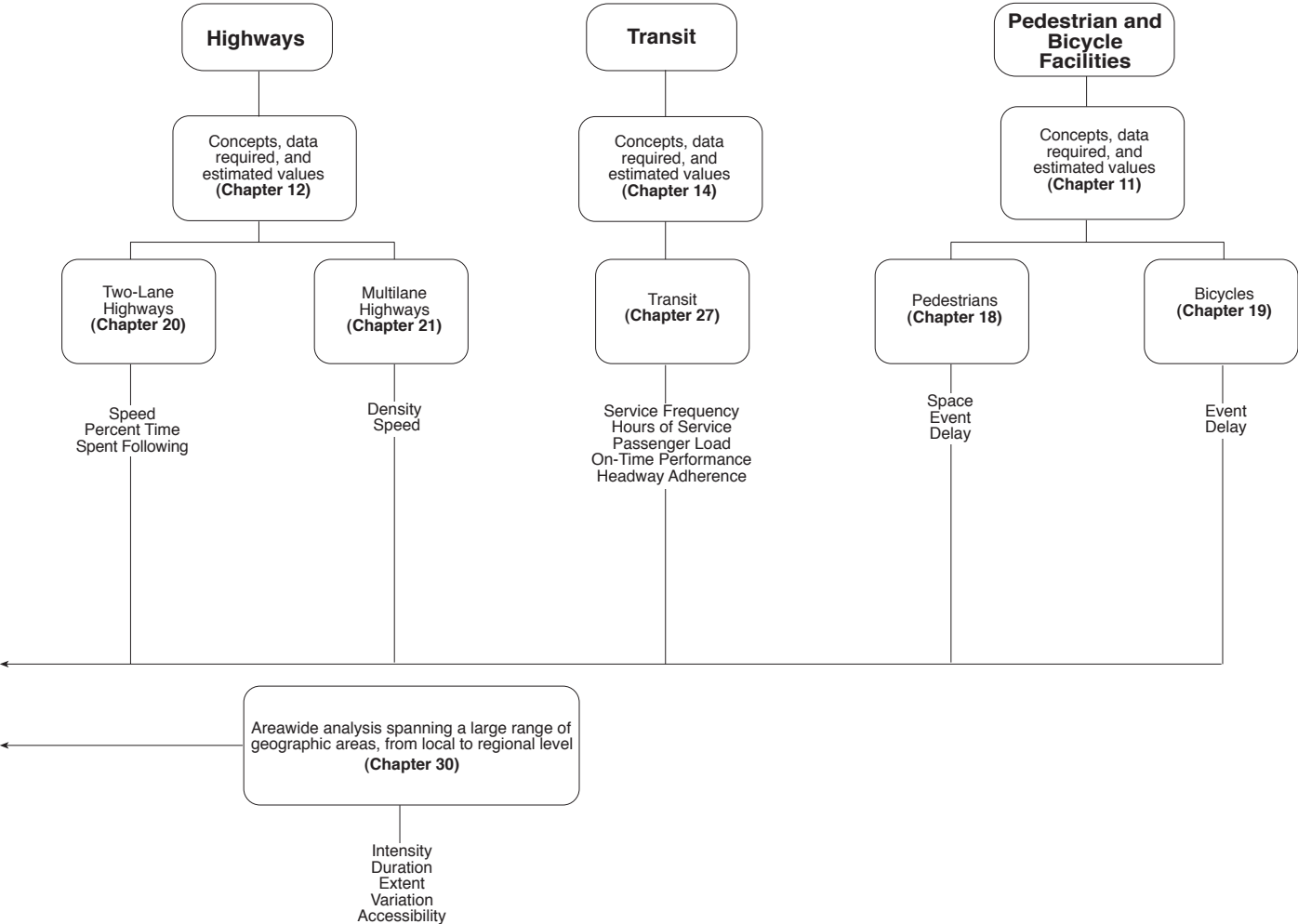

Precision in calculation differs from precision in presenting final results

Calculation Precision Versus Display Precision

The extensive use of personal computers has allowed calculations of capacity and level of service to be carried to a large number of digits to the right of the decimal point. Because of this ease of calculation, there is a need to state clearly that the final result of calculations done manually and carried to the suggested number of significant figures might be slightly different from the result of calculations performed on a computer. This difference has been explicitly recognized in this manual. For example, lists of factors are often displayed with three or four digits to the right of the decimal point to more closely adhere to the calculation protocol inherent in computers.

Implied Precision from Displayed Results

The typical interpretation given to a value such as 2.0 is that the value is in a precision range of two significant figures and that results from calculations should be rounded to this level of precision. Occasionally, particularly in the running text of the manual, editorial flexibility allows a zero to be dropped from the number of digits. In most cases, however, the number of the digits to the right of the decimal point does imply that a factor or numerical value has been calculated to that level of precision.

Directives from TRB Committee

Prior to publication of this manual, the Committee on Highway Capacity and Quality of Service (A3A10) developed guidelines for the presentation of results. The guidelines were presented in mid-1997 in the form of advice to the preparers of this manual. Several recommendations were included and were particularly aimed at the exhibits and values shown and used in Chapter 16, Signalized Intersections. This advice was considered, along with the factors mentioned above, in developing the HCM.

Specific Components for Presentation Guideline

The overall objective of the guideline is to present tabular values and calculated results in a consistent manner throughout the manual. Another objective is to use a number of significant digits that is reasonable and indicates to the analyst that the results are not extremely precise but take on the precision and accuracy associated with the input variables. As stated earlier, such accuracies for traffic volume counts and measurement of geometric conditions seldom are better than a central value plus or minus 5 percent. Prediction to a future time frame presents even greater differences between the assumed input values and what will actually occur at that time horizon. The guideline for this manual recognizes that rounding intermediate results in a series of calculations for a given method is not appropriate and can be more confusing than worthwhile. The third objective of the guideline is that prior research results, advice, and recommendations of the Committee on Highway Capacity and Quality of Service and the standard practice of the profession in these calculations are to be respected.

Input Values

Following is a list of representative (not exhaustive) input variables and the suggested number of digits for each.

- Volume (whole number);
- Grade (whole number);
- Lane width (one decimal place);
- Percentage of heavy vehicles (whole number);
- Peak-hour factor (two decimal places);
- Arrival type (category, 1 to 6);
- Pedestrian volume (whole number);
- Bicycle volume (whole number);
- Parking maneuvers (whole number);

Conventions for display of results in the HCM

- Bus stopping (whole number);
- Green, yellow, all-red, and cycle times (one decimal place);
- Lost time/phase (whole number); and
- Minimum pedestrian time (one decimal place).

Adjustment Factors

Factors interpolated from tabular material can use one more decimal place than presented in the table. Factors generated from equations can be taken to three decimal places.

Example Service Volume Tables

In rounding volumes for service volume tables, a precision of no greater than the nearest 10 vehicles or passenger cars should be used. Rounding to the nearest 50 or 100 (three significant digits) is strongly recommended if threshold values determining specific levels of service are not affected.

Free-Flow Speed

For base free-flow speeds, show the value to the nearest 1 km/h. For free-flow speeds that have been adjusted for various conditions and are thus considered an intermediate calculation, show speed to the nearest 0.1 km/h.

Speeds

For threshold values that define levels of service, show speed to the nearest 1 km/h. For intermediate calculations of speed, use one decimal place.

Volume to Capacity Ratios

Show v/c ratios with two decimal places.

Delay

In computing delay, show results with one decimal place. In presenting delay as a threshold value in level-of-service tables, show a whole number.

Pedestrian Space

To conform with recommended research results, show pedestrian space values with one decimal place.

Occurrences and Events

For all event-based items, use values to a whole number. These items include parking maneuvers, bus stops, events along a pedestrian or bicycle path, and number of cycles in a given time period.

General Factors

In performing all calculations on a computer, the full precision available should be used. Intermediate calculation outputs should be displayed to three significant digits throughout. For the measure that defines level of service, the number of significant digits presented should exceed by one the number of significant digits shown in the level-of-service table.

Displayed Results

For the example problems of Part III, manual calculations were performed. Once the value of an intermediate calculation is entered into a worksheet, that rounded value is used for all remaining calculations. As the computations progress, the analyst may round the values to indicate that the precision of the final results is less than implied by the intermediate calculations. The analyst can refer to the example problems of Chapters 16

Concept of an average value

and 21 for specific examples of rounding and display of calculations and results for interrupted- and uninterrupted-flow facilities, respectively.

AVERAGE VALUES

Three concepts are implicit in all of the material presented in this manual, and they should be understood by HCM users. Unless otherwise noted or defined, numerical values are mean values for the given parameter. Thus, a measure of speed or delay is the mean value for the population of vehicles (or persons) being analyzed. Similarly, a lane width for two or more lanes is the mean (average) width of the lanes. The word “average” or “mean” is only occasionally carried along in the text or exhibits to reinforce this otherwise implicit fact.

The terms demand and volume tend to be used interchangeably in this manual for undersaturated flow conditions. For oversaturated conditions, when demand is greater than capacity, demand is the appropriate term. Several chapters in Part III, including Chapter 16, “Signalized Intersections,” and Chapter 22, “Freeway Facilities,” address the condition of demand being greater than capacity.

Another significant concept implicit in these materials is that the level-of-service threshold values, the adjustment factors used in the computations, and the calculated values of performance measures are assumed to represent conditions that have a reasonable expectation of being observed regularly in North America rather than the most extreme that might be encountered.

SENSITIVITY TO INPUT VARIABLES

Impact of input quality on results

The analyst should recognize that the quality of the results depends on the quality of the input data. Default values will produce less accurate results than field-measured data. Generic default values suggested in this manual will produce less accurate results than locally developed default values.

IV. HOURLY AND DAILY VOLUME EQUIVALENCIES

Capacity and other traffic analyses frequently focus on the peak hour of traffic for the peak direction because it represents high capacity requirements. Because planning applications frequently deal with annual average daily traffic (AADT), three important factors (K, D, and PHF) are needed to provide a means to convert between daily and hourly directional volumes. These factors are discussed in greater detail in Chapter 8, and their general application is presented below.

Calculation of analysis period flow

Most of the procedures in this manual are based on peak 15-min flow rates. Because traffic does not flow evenly over an hour, subhourly peaking should be accounted for when the analysis is in terms other than 15-min flows. The relationship between the peak 15-min flow rate and the full hourly volume is given by the peak-hour factor (PHF). To convert peak 15-min flow rates to hourly volumes, the flow rate is multiplied by the PHF.

For vehicle traffic, the proportion of AADT occurring in the analysis hour is referred to as the K-factor. As presented in Chapter 8, the K-factor is highly dependent on the analysis hour selected, the specific characteristics of the roadway, and the location of the roadway. In converting hourly volumes to daily volumes, the hourly volume is divided by the K-factor. During any particular hour, traffic volume will likely be greater in one direction than in the other. Directional distribution (D) is an important factor in capacity and quality of service analysis. To convert hourly directional volumes to daily volumes, the hourly directional volumes are divided by the D-factor. For planning and design applications, AADT is typically given. To convert the AADT to an equivalent hourly volume, the AADT is multiplied by both the K-factor and the D-factor.

Most of the analytical procedures use the peak 15-min flow rate. This rate is obtained by dividing the hourly volume by the PHF. Service volume results, expressed in 15-min flow rates, must be multiplied by the PHF to obtain the equivalent hourly volume. This has been done, where appropriate, for the example service volume tables in Chapters 10 through 14, so that all volumes shown are equivalent hourly volumes. Exhibit 9-2 gives default values for K, D, and PHF that may be used in the absence of local field data.

EXHIBIT 9-2. TYPICAL DEFAULT VALUES FOR PHF, K, AND D

Factor	Area	
	Urban	Rural
PHF	0.92	0.88
K	0.09	0.10
D	0.60	0.60

V. USE OF DEFAULT VALUES

Planning applications of the computation methods are described in Part III. Guidance for estimating input values and selecting default values for planning applications is given in Part II (Chapters 10 through 14). The analyst should observe the following suggestions when generating inputs to the analytical procedures.

- If the input variable can be observed in the field, measure it in the field.
 - In performing a planning application for a facility not yet built, measure a similar facility in the area that has conditions similar to those of the proposed facility.
 - If neither of the first two sources is available, rely on local policy or typical local/state values.
 - If none of the above sources is available, default values provided in Part II (Chapters 10 through 14) of this manual may be used.
- The development of local default values is discussed in Appendix A.

Alternative if no field data can be obtained

VI. SERVICE VOLUME TABLES

The methods in this manual are frequently applied to identify the operating level of service given a demand volume of traffic. Conversely, the analyst often desires to know the maximum service volume for a facility operating with a specific level of service. Service volume tables can be prepared to facilitate this type of analysis. Such tables use locally generated default values (or, alternatively, defaults suggested in this manual) for most or all of the required inputs. The analyst performs a series of computations to fill in the tabular values. Caution should be used in applying service volume tables because of the assumptions made in generating the tables. Footnotes to the service volume tables describe the assumptions used to generate the values. Appendix B explains the steps involved. Note that service volume tables for various facility types are included in Chapters 10 through 14. Other examples of service volume tables can be found in Florida's *Level of Service Handbook (1)*.

Service volume tables are valid only under the conditions for which they were developed

How to establish default values for local conditions

VII. REFERENCE

1. *Level of Service Handbook*. System Planning Office, Florida Department of Transportation, Tallahassee, 1998.

APPENDIX A. DEVELOPING LOCAL DEFAULTS

The best method for determining local default values for traffic parameters is to measure a sample of facilities in the field. If this is not feasible, an informal survey of local highway operating agencies can be conducted to determine their standard design practices for new facilities and the condition of the facilities currently in place. Facilities can be stratified by area type and facility type to ensure reliable default values. The choice of categories is a local decision. Exhibit A9-1 provides an example framework for stratifying defaults.

EXHIBIT A9-1. EXAMPLE DEFAULT STRATIFICATION SCHEME

Area Type	Facility Type					
	Interstate Freeway	Other Freeway	State Highway	Non-State Highway	Principal Arterials	Minor Arterials/Collectors
Central business district						
Suburban						
Rural						

The default value for each category is the arithmetic mean of the observations. The variation in the observed value for each category should be compared with the difference in the means for each category. Analysis of variance techniques can be used to determine whether categories should be consolidated. Note that the stratification framework can be used for roadway, traffic, and control parameters.

The sample size required for each category is determined by the desired accuracy in the resulting input estimate and the variation in the observed values. Equation A9-1, adapted from a statistics textbook (1), gives the minimum sample size that will allow the analyst to compute the mean and estimate the margin of error in the estimated mean with 90 percent or better confidence.

$$n \geq \frac{4s^2}{(\xi)^2} \tag{A9-1}$$

where

- n = minimum number of observations to meet accuracy goal for mean;
- ξ = maximum desirable error in the estimate of the mean (at the desired confidence level); and
- s = estimated standard deviation for the sample, computed using Equation A9-2.

$$s^2 = \frac{\sum(x_i - \bar{x})^2}{(n - 1)} \tag{A9-2}$$

where

- x_i = i th observation of the value, and
- \bar{x} = mean value of the observations.

For sample sizes less than 5, the equation will provide less than 90 percent confidence in the margin of error. A higher confidence level can be obtained by substituting $2t(s^2)$ for $4(s^2)$ in the equation, where t is the Student's t -statistic for the desired confidence level.

In practice, one does not know whether an adequate sample size has been obtained until after the data have been collected and the sample variance has been computed. However, the analyst can use prior experience to estimate the likely standard deviation.

To demonstrate the use of Equation A9-1, assume that a local base saturation flow rate is desired. Fifteen observations of prevailing saturation flow rates (see Appendix H of Chapter 16 for methodology) have been collected at four local intersections. The standard deviation of the sample is 45. It has been determined that the maximum desirable estimated error in the mean is 5 percent. Are more than the initial 15 observations needed, and if so, how many are required in total?

$$s = 45$$

$$\xi = 5$$

$$n \geq \frac{4s^2}{(\xi)^2} = \frac{4 * (45)^2}{(5)^2} = 324$$

Therefore, 15 observations are not enough. At least 324 observations are needed.

REFERENCE

1. Wonnacott, T. H., and R. J. Wonnacott. *Introductory Statistics for Business and Economics*. John Wiley and Sons, New York, 1990.

APPENDIX B. DEVELOPING SERVICE VOLUME TABLES

Service volume tables can be generated by facility type and area type by using the estimated values and appropriate software to back-solve for the maximum volumes for each level of service. The procedure is as follows:

1. Determine all nonvolume input values to be used in developing the service volume table. Develop categories of facilities and area types and select input values (e.g., PHF, percentage of heavy vehicles, urban area, suburban area) to be used. Repeat the following steps for each facility and area category.
 2. Identify the range in the number of lanes to be tested.
 3. Identify the desired level of service (LOS) measure of effectiveness values for LOS A through E from the chapters of Part III (for example, a density of 10 pc/km/ln is the maximum density for LOS A for a basic freeway segment).
 4. Select the first category of facility type, area type, and the number of lanes for which to compute the maximum service volumes.
 5. Start the search for the maximum service volume for the LOS A threshold according to the appropriate methodology.
 6. Compute the LOS measure (i.e., delay, speed, or density) for the first iteration volume (lower volume than the LOS A threshold) (label this Vol 1).
 7. If the result exceeds the LOS A threshold value, then LOS A is unachievable. Go to the next higher LOS threshold (for LOS B) and repeat Steps 5, 6, and 7 until an achievable LOS is found. Then go on to the next steps.
 8. Select a second iteration volume (label this Vol 2).
 9. Compute the LOS measure (delay, speed, or density).
 10. If the resulting LOS measure is lower than the LOS threshold, repeat Steps 1 and 2 with a volume twice the original estimate. Repeat until the volume is found to be greater than the desired LOS threshold.

A methodology for developing service volume tables

11. Use the bisection method (or another more efficient numerical method) to progressively narrow the uncertainty in the service volume until it is within the desired bounds. The following steps describe the bisection method (*I*).
12. Compute the volume halfway between Vol 1 and Vol 2. Label this volume Vol 3.
13. Compute the LOS measure (delay, speed, or density) for Vol 3.
14. If the LOS result for Vol 3 is higher than the desired LOS threshold, drop Vol 1 and relabel Vol 3 as the new Vol 1.
15. If the LOS result for Vol 3 is lower than the desired LOS threshold, drop Vol 2 and relabel Vol 3 as the new Vol 2.
16. Is the range between Vol 1 and Vol 2 acceptable? If so, stop and use the average of Vol 1 and Vol 2 as the service volume estimate. If not, repeat Steps 12 through 16.

REFERENCE

1. Courage, K. G., and J. Z.-Y. Luh. Computation of Signalized Intersection Service Volumes Using the 1985 Highway Capacity Manual. In *Transportation Research Record 1194*, TRB, National Research Council, Washington, D.C., 1988, pp. 179–190.

CHAPTER 10

URBAN STREET CONCEPTS

CONTENTS

I.	INTRODUCTION	10-1
II.	URBAN STREETS	10-1
	Flow Characteristics	10-3
	Free-Flow Speed	10-3
	Running Speed	10-3
	Travel Speed	10-4
	Time-Space Trajectory	10-4
	Levels of Service	10-4
	Required Input Data and Estimated Values	10-5
	Urban Street Class	10-5
	Length	10-7
	Free-Flow Speed	10-7
	Signal Density	10-8
	Peak-Hour Factor	10-8
	Length of Analysis Period	10-8
	Service Volume Table	10-9
III.	SIGNALIZED INTERSECTIONS	10-9
	Signalized Intersection Flow Characteristics	10-9
	Traffic Signal Characteristics	10-14
	Saturation Flow Rate	10-15
	Signalized Intersection Capacity	10-15
	Level of Service	10-15
	Required Input Data and Estimated Values	10-17
	Lane Additions and Drops at Intersections	10-17
	Exclusive Turn Lanes	10-17
	Exclusive Left-Turn Lanes	10-18
	Exclusive Right-Turn Lanes	10-18
	Number of Lanes	10-18
	Other Features	10-18
	Intersection Turning Movements	10-19
	Default Values in Absence of Turning Movement Data	10-19
	Turning Movement Estimation	10-19
	Peak-Hour Factor	10-21
	Length of Analysis Period	10-21
	Intersection Control Type	10-21
	Cycle Length	10-21
	Lost Time and Estimation of Signal Phasing	10-22
	Effective Green Ratio	10-23
	Arrival Type	10-23
	Progression Adjustment Factor	10-23
	Incremental Delay Adjustment	10-24
	Upstream Filtering/Metering Adjustment Factor	10-24
	Base Saturation Flow Rate	10-24
	Adjusted Saturation Flow Rates	10-24
	Lane Widths	10-24
	Heavy Vehicles	10-25
	Grades	10-25

	Parking Maneuvers	10-25
	Local Buses	10-25
	Pedestrians	10-26
	Area Type	10-26
	Lane Utilization	10-26
	Service Volume Table	10-26
IV.	UNIGNALIZED INTERSECTIONS	10-27
	Characteristics of TWSC Intersections	10-27
	Flow at TWSC Intersections	10-27
	Gap Acceptance Models	10-28
	Availability of Gaps	10-28
	Usefulness of Gaps	10-28
	Relative Priority of Various Streams at the Intersection	10-28
	Capacity of TWSC Intersections	10-29
	Characteristics of AWSC Intersections	10-30
	Flow at AWSC Intersections	10-30
	Characteristics of Roundabouts	10-31
	Performance Measures	10-31
	Required Input Data and Estimated Values	10-32
	Two-Way Stop-Controlled Intersections	10-32
	Intersection Geometry	10-32
	Control	10-32
	Volumes	10-33
	All-Way Stop-Controlled Intersections	10-33
	Intersection Geometry	10-33
	Volumes	10-33
	Roundabouts	10-34
	Intersection Geometry	10-34
	Volumes	10-34
	Service Volume Tables	10-34
V.	REFERENCES	10-35
APPENDIX A.	QUICK ESTIMATION METHOD FOR SIGNALIZED INTERSECTIONS	10-36
	Input Requirements	10-36
	Determination of Left-Turn Treatment	10-37
	Lane Volume Computations	10-42
	Signal Timing Estimation	10-43
	Phasing Plan Development	10-43
	Computation of Critical Sum	10-44
	Estimation of Total Lost Time	10-45
	Cycle Length Estimation	10-45
	Green Time Estimation	10-45
	Computation of Critical v/c Ratio	10-46
	Computation of Delay	10-46
APPENDIX B.	WORKSHEETS	10-47
	Quick Estimation Input Worksheet	
	Left-Turn Treatment Worksheet	
	Quick Estimation Lane Volume Worksheet	
	Quick Estimation Control Delay and LOS Worksheet	

EXHIBITS

Exhibit 10-1.	Typical Speed Profiles of Vehicles on Urban Streets	10-4
Exhibit 10-2.	Required Input Data for Urban Streets	10-5
Exhibit 10-3.	Urban Street Class Based on Functional and Design Categories	10-6
Exhibit 10-4.	Functional and Design Categories	10-6
Exhibit 10-5.	Free-Flow Speed by Urban Street Class	10-8
Exhibit 10-6.	Signal Density by Urban Street Class	10-8
Exhibit 10-7.	Example Service Volumes for Urban Streets	10-10
Exhibit 10-8.	Fundamental Attributes of Flow at Signalized Intersections	10-11
Exhibit 10-9.	Symbols, Definitions, and Units for Fundamental Variables of Traffic Flow at Signalized Intersections	10-12
Exhibit 10-10.	Relationship Among Actual Green, Lost-Time Elements, Extension of Effective Green, and Effective Green	10-13
Exhibit 10-11.	Lost Time Application for Compound Left-Turn Phasing	10-14
Exhibit 10-12.	Required Data for Signalized Intersections	10-17
Exhibit 10-13.	Turn Volumes Probably Requiring Exclusive Left-Turn Lanes at Signalized Intersections	10-18
Exhibit 10-14.	Origin-Destination Labels for Intersection Turning Movements	10-19
Exhibit 10-15.	Intersection Control Type and Peak-Hour Volumes	10-21
Exhibit 10-16.	Default Cycle Lengths by Area Type	10-21
Exhibit 10-17.	Default Lost Time per Cycle by Left Phase Type	10-22
Exhibit 10-18.	Progression Quality and Arrival Type	10-23
Exhibit 10-19.	Adjusted Saturation Flow Rate by Area Type	10-24
Exhibit 10-20.	Parking Maneuver Defaults	10-25
Exhibit 10-21.	Bus Frequency Defaults	10-25
Exhibit 10-22.	Defaults for Pedestrian Flows	10-26
Exhibit 10-23.	Default Lane Utilization Adjustment Factors	10-26
Exhibit 10-24.	Example Service Volumes for Signalized Intersection	10-27
Exhibit 10-25.	Analysis Cases for AWSC Intersections	10-30
Exhibit 10-26.	Basic Roundabout Geometrics	10-32
Exhibit 10-27.	Minimum Approach Volumes (veh/h) for Left-Turn Lanes on Two- Lane Highways at Unsignalized Intersections	10-33
Exhibit 10-28.	Example of Minor Street Service Volumes for T-Intersection Two-Way Stop Intersection	10-34
Exhibit 10-29.	Example of Minor Street Service Volumes for Four-Leg Intersection, Two-Way Stop	10-35
Exhibit 10-30.	Example of Approach Service Volumes for All-Way Stop Intersections for Single Approach	10-35
Exhibit A10-1.	Input Data Requirements for Quick Estimation Method	10-37
Exhibit A10-2.	Quick Estimation Input Worksheet	10-38
Exhibit A10-3.	Left-Turn Treatment Worksheet	10-39
Exhibit A10-4.	Quick Estimation Lane Volume Worksheet	10-40
Exhibit A10-5.	Quick Estimation Control Delay and LOS Worksheet	10-41
Exhibit A10-6.	Shared-Lane, Left-Turn Adjustment Computation for Quick Estimation	10-43
Exhibit A10-7.	Phase Plans for Quick Estimation Method	10-44
Exhibit A10-8.	Phase Plan Summary for Quick Estimation Method	10-44
Exhibit A10-9.	Intersection Status Criteria for Signalized Intersection Planning Analysis	10-46

I. INTRODUCTION

In this chapter, capacity and quality of service concepts for urban streets are introduced. The term “urban streets,” as used in this manual, refers to urban arterials and collectors, including those in downtown areas. Methodologies found in Chapter 15 (Urban Streets), Chapter 16 (Signalized Intersections), and Chapter 17 (Unsignalized Intersections) can be used in conjunction with this chapter.

II. URBAN STREETS

In the hierarchy of street transportation facilities, urban streets (including arterials and collectors) are ranked between local streets and multilane suburban and rural highways. The difference is determined principally by street function, control conditions, and the character and intensity of roadside development.

Arterial streets are roads that primarily serve longer through trips. However, providing access to abutting commercial and residential land uses is also an important function of arterials. Collector streets provide both land access and traffic circulation within residential, commercial, and industrial areas. Their access function is more important than that of arterials, and unlike arterials their operation is not always dominated by traffic signals.

Downtown streets are signalized facilities that often resemble arterials. They not only move through traffic but also provide access to local businesses for passenger cars, transit buses, and trucks. Turning movements at downtown intersections are often greater than 20 percent of total traffic volume because downtown flow typically involves a substantial amount of circulatory traffic.

Pedestrian conflicts and lane obstructions created by stopping or standing taxicabs, buses, trucks, and parking vehicles that cause turbulence in the traffic flow are typical of downtown streets. Downtown street function may change with the time of day; some downtown streets are converted to arterial-type operation during peak traffic hours.

Multilane suburban and rural highways differ from urban streets in the following ways: roadside development is not as intense, density of traffic access points is not as high, and signalized intersections are more than 3.0 km apart. These conditions result in a smaller number of traffic conflicts, smoother flow, and dissipation of the platoon structure associated with traffic flow on an arterial or collector with traffic signals.

The urban streets methodology described in this chapter and in Chapter 15 can be used to assess the mobility function of the urban street. The degree of mobility provided is assessed in terms of travel speed for the through-traffic stream. A street’s access function is not assessed by this methodology. The level of access provided by a street should also be considered in evaluating its performance, especially if the street is intended to provide such access. Oftentimes, factors that favor mobility reflect minimal levels of access and vice versa.

The functional classification of an urban street is the type of traffic service the street provides. Within the functional classification, the arterial is further classified by its design category. Illustrations 10-1 through 10-4 show typical examples of four design categories that are described in the following sections.

Functional class defined

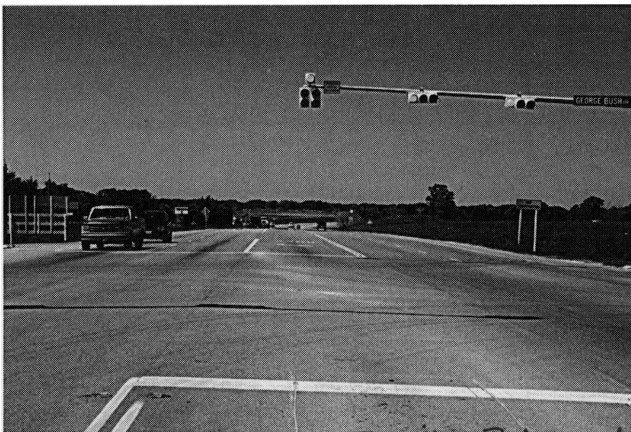

ILLUSTRATION 10-1. Typical high-speed design.



ILLUSTRATION 10-2. Typical suburban design.

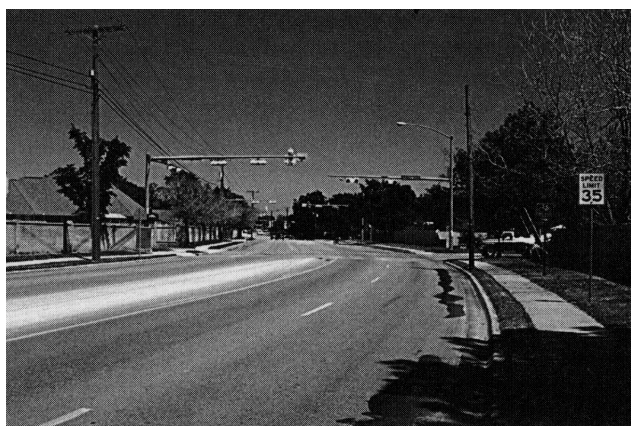

ILLUSTRATION 10-3. Typical intermediate design.



ILLUSTRATION 10-4. Typical urban design.

FLOW CHARACTERISTICS

The speed of vehicles on urban streets is influenced by three main factors: street environment, interaction among vehicles, and traffic control. As a result, these factors also affect quality of service.

The street environment includes the geometric characteristics of the facility, the character of roadside activity, and adjacent land uses. Thus, the environment reflects the number and width of lanes, type of median, driveway/access-point density, spacing between signalized intersections, existence of parking, level of pedestrian activity, and speed limit.

The interaction among vehicles is determined by traffic density, the proportion of trucks and buses, and turning movements. This interaction affects the operation of vehicles at intersections and, to a lesser extent, between signals.

Traffic control (including signals and signs) forces a portion of all vehicles to slow or stop. The delays and speed changes caused by traffic control devices reduce vehicle speeds; however, such controls are needed to establish right-of-way.

Free-Flow Speed

The street environment affects the driver's speed choice. When vehicle interaction and traffic control are not factors, the speed chosen by the average driver is referred to as the free-flow speed (FFS). FFS is the average speed of the traffic stream when traffic volumes are sufficiently low that drivers are not influenced by the presence of other vehicles and when intersection traffic control (i.e., signal or sign) is not present or is sufficiently distant as to have no effect on speed choice. As a consequence, FFS is typically observed along midblock portions of the urban street segment.

Running Speed

A driver can seldom travel at the FFS. Most of the time, the presence of other vehicles restricts the speed of a vehicle in motion because of differences in speeds among drivers or because downstream vehicles are accelerating from a stop and have not yet reached FFS. As a result, vehicle speeds tend to be lower than the FFS during moderate to high-volume conditions.

One speed characteristic that captures the effect of interaction among vehicles is the average running speed. This speed is computed as the length of the segment divided by the average running time. The running time is the time taken to traverse the street segment, less any stop-time delay.

Travel Speed

The presence of traffic control on a street segment tends to reduce vehicle speeds below the average running speed. A speed characteristic that captures the effect of traffic control is average travel speed. This speed is computed as the length of segment divided by the average travel time. The travel time is the time taken to traverse the street segment, inclusive of any stop-time delay.

Time-Space Trajectory

Exhibit 10-1 shows simplified time-space trajectories of representative vehicles along one lane of an urban street. The slope of each line reflects the corresponding vehicle speed at a given time. Steeper slopes represent higher speeds; horizontal slopes represent stopped vehicles.

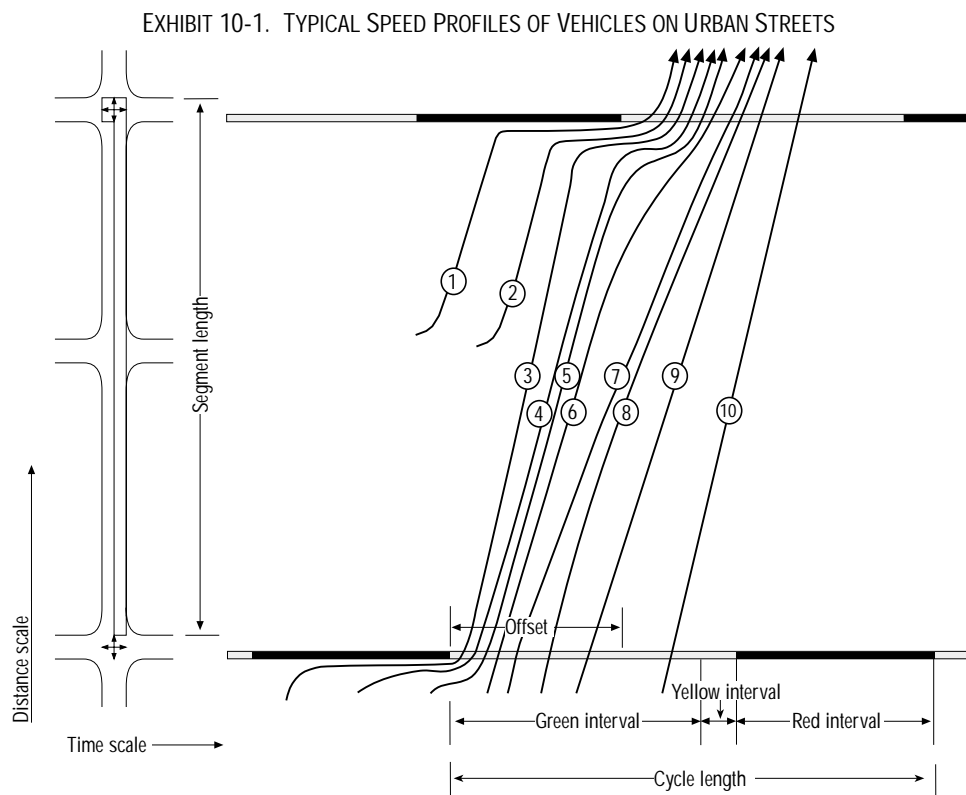

Vehicles 1 and 2 turned onto the street from side streets, while the other vehicles were discharged from the upstream signal. Vehicles 1, 2, and 3 arrived at the downstream signal during the red interval and had to stop. Vehicle 4 could have arrived at the stop line on the green but had to stop because it was blocked by Vehicle 3, which was not yet in motion.

Vehicles 5, 6, and 7 did not stop but had to reduce their speeds because they were affected by the stoppages caused by the signal. Vehicle 8 was slowed by Vehicle 7. The speeds of Vehicles 9 and 10 were not affected by the presence of other vehicles or the downstream traffic control.

LEVELS OF SERVICE

The average travel speed for through vehicles along an urban street is the determinant of the operating level of service (LOS). The travel speed along a segment, section, or entire length of an urban street is dependent on the running speed between

signalized intersections and the amount of control delay incurred at signalized intersections.

Urban street LOS is based on average through-vehicle travel speed for the segment, section, or entire urban street under consideration. The following general statements characterize LOS along urban streets. Refer to Exhibit 15-2 for speed ranges for each LOS.

LOS A describes primarily free-flow operations at average travel speeds, usually about 90 percent of the FFS for the given street class. Vehicles are completely unimpeded in their ability to maneuver within the traffic stream. Control delay at signalized intersections is minimal.

LOS B describes reasonably unimpeded operations at average travel speeds, usually about 70 percent of the FFS for the street class. The ability to maneuver within the traffic stream is only slightly restricted, and control delays at signalized intersections are not significant.

LOS C describes stable operations; however, ability to maneuver and change lanes in midblock locations may be more restricted than at LOS B, and longer queues, adverse signal coordination, or both may contribute to lower average travel speeds of about 50 percent of the FFS for the street class.

LOS D borders on a range in which small increases in flow may cause substantial increases in delay and decreases in travel speed. LOS D may be due to adverse signal progression, inappropriate signal timing, high volumes, or a combination of these factors. Average travel speeds are about 40 percent of FFS.

LOS E is characterized by significant delays and average travel speeds of 33 percent or less of the FFS. Such operations are caused by a combination of adverse progression, high signal density, high volumes, extensive delays at critical intersections, and inappropriate signal timing.

LOS F is characterized by urban street flow at extremely low speeds, typically one-third to one-fourth of the FFS. Intersection congestion is likely at critical signalized locations, with high delays, high volumes, and extensive queuing.

LOS is based on average through-vehicle travel speed for the urban street segment

REQUIRED INPUT DATA AND ESTIMATED VALUES

Estimating speed, delay, and LOS for an urban street or an intersection requires geometric data and demand data. Signal control data will be discussed in the signalized intersections section. Exhibit 10-2 gives default values for input parameters in the absence of local data.

EXHIBIT 10-2. REQUIRED INPUT DATA FOR URBAN STREETS

Item	Default
Geometric Data	
Urban street class	Exhibits 10-3, 10-4
Length	-
Free-flow speed	Exhibit 10-5
Intersection Control Data	
Signal density	Exhibit 10-6
Intersection delay	See Section III of this chapter

The analyst should note that taking field measurements for use as inputs to an analysis is the most reliable way to generate parameter values. Default values should be considered only when this is not feasible.

Urban Street Class

The urban street classification system is somewhat different from that used by the American Association of State Highway and Transportation Officials (AASHTO) (1).

AASHTO's functional classes are based on travel volume, mileage, and the characteristic of service the urban street is intended to provide. The analysis method in this manual makes use of the AASHTO distinction between principal arterial and minor arterial. But a second classification step is used herein to determine the appropriate design category for the arterial. The design category depends on the posted speed limit, signal density, driveway/access-point density, and other design features. The third step is to determine the appropriate urban street class on the basis of a combination of functional category and design category. Exhibits 10-3 and 10-4 are useful for establishing urban street class.

Four urban street classes are defined in this manual. The classes are designated by number (i.e., I, II, III, and IV) and reflect unique combinations of street function and design, as shown in Exhibit 10-3. The functional component is separated into two categories: principal arterial and minor arterial. The design component is separated into four categories: high-speed, suburban, intermediate, and urban. The characteristics associated with each category are described in the remainder of this section. Exhibit 10-4 summarizes these characteristics.

EXHIBIT 10-3. URBAN STREET CLASS BASED ON FUNCTIONAL AND DESIGN CATEGORIES

Design Category	Functional Category	
	Principal Arterial	Minor Arterial
High-Speed	I	N/A
Suburban	II	II
Intermediate	II	III or IV
Urban	III or IV	IV

EXHIBIT 10-4. FUNCTIONAL AND DESIGN CATEGORIES

Criterion	Functional Category	
	Principal Arterial	Minor Arterial
Mobility function	Very important	Important
Access function	Very minor	Substantial
Points connected	Freeways, important activity centers, major traffic generators	Principal arterials
Predominant trips served	Relatively long trips between major points and through-trips entering, leaving, and passing through the city	Trips of moderate length within relatively small geographical areas

Criterion	Design Category			
	High-Speed	Suburban	Intermediate	Urban
Driveway/access density	Very low density	Low density	Moderate density	High density
Arterial type	Multilane divided; undivided or two-lane with shoulders	Multilane divided; undivided or two-lane with shoulders	Multilane divided or undivided; one-way, two-lane	Undivided one-way, two-way, two or more lanes
Parking	No	No	Some	Significant
Separate left-turn lanes	Yes	Yes	Usually	Some
Signals/km	0.3–1.2	0.6–3.0	2–6	4–8
Speed limit	75–90 km/h	65–75 km/h	50–65 km/h	40–55 km/h
Pedestrian activity	Very little	Little	Some	Usually
Roadside development	Low density	Low to medium density	Medium to moderate density	High density

A principal arterial serves major through movements between important centers of activity in a metropolitan area and a substantial portion of trips entering and leaving the

area. It also connects freeways with major traffic generators. In smaller cities (population under 50,000), its importance is derived from the service provided to traffic passing through the urban area. Service to abutting land is subordinate to the function of moving through traffic.

A minor arterial connects and augments the principal arterial system. Although its main function is traffic mobility, it performs this function at a lower level and places more emphasis on land access than does the principal arterial. A system of minor arterials serves trips of moderate length and distributes travel to geographical areas smaller than those served by the principal arterial.

The urban street is further classified by its design category. Exhibit 10-3 shows urban street classes based on functional and design categories.

High-speed design represents an urban street with a very low driveway/access-point density, separate left-turn lanes, and no parking. It may be multilane divided or undivided or a two-lane facility with shoulders. Signals are infrequent and spaced at long distances. Roadside development is low density, and the speed limit is typically 75 to 90 km/h. This design category includes many urban streets in suburban settings.

Suburban design represents a street with a low driveway/access-point density, separate left-turn lanes, and no parking. It may be multilane divided or undivided or a two-lane facility with shoulders. Signals are spaced for good progressive movement (up to three signals per kilometer). Roadside development is low to medium density, and speed limits are usually 65 to 75 km/h.

Intermediate design represents an urban street with a moderate driveway/access-point density. It may be a multilane divided, an undivided one-way, or a two-lane facility. It may have some separate or continuous left-turn lanes and some portions where parking is permitted. It has a higher density of roadside development than the typical suburban design and usually has two to six signals per kilometer. Speed limits are typically 50 to 65 km/h.

Urban design represents an urban street with a high driveway/access-point density. It frequently is an undivided one-way or two-way facility with two or more lanes. Parking is usually permitted. Generally, there are few separate left-turn lanes, and some pedestrian interference is present. It commonly has four to eight signals per kilometer. Roadside development is dense with commercial uses. Speed limits range from 40 to 55 km/h.

In addition to the above definitions, Exhibit 10-4 can be used as an aid in the determination of functional and design categories. Once the functional and design categories have been determined, the urban street classification may be established by referring to Exhibit 10-3.

In practice, there are sometimes ambiguities in determining the proper categories. The measurement or estimation of the free-flow speed is a great aid in this determination, because each urban street class has a characteristic range of free-flow speeds, as shown in Chapter 15.

Length

The portion of the urban street being analyzed should be at least 1.5 km long in a downtown area and 3.0 km long elsewhere for the LOS speed criteria to be meaningful. Study lengths shorter than 1.5 km should be analyzed as individual intersections and the LOS assessed according to individual intersection criteria.

Free-Flow Speed

The free-flow speed is used to determine the urban street class and to estimate the segment running time. If FFS cannot be measured in the field, the analyst should attempt to take measurements on a similar facility in the same area or should resort to established local policies. Lacking any of these options, the analyst might rely on the posted speed limit (or some value around that limit) or on default values in this manual.

High-speed design defined

Suburban design defined

Intermediate design defined

Urban design defined

Measure free-flow speed as far as possible from nearest signal or stop-controlled intersection and at flows < 200 veh/h/ln

Free-flow speed on an urban street is the speed that a vehicle travels under low-volume conditions when all the signals on the urban street are green for the entire trip. Thus, all delay at signalized intersections, even under low flow conditions, is excluded from the computation of urban street FFS. The best location to measure urban street FFS is midblock and as far as possible from the nearest signalized or stop-controlled intersection. This measurement should be made under low flow conditions (less than 200 veh/h/ln). Exhibit 10-5 gives default FFS by urban street class for use in the absence of local data.

EXHIBIT 10-5. FREE-FLOW SPEED BY URBAN STREET CLASS

Urban Street Class	Default (km/h)
I	80
II	65
III	55
IV	45

Signal Density

Signal density defined

Signal density is the number of signalized intersections in the study portion of the urban street divided by its length. If signalized intersections are used to define both the beginning and the ending points of the study portion of the urban street, then the number of signals in the study portion should be reduced by one in computing the signal density. Exhibit 10-6 gives defaults by urban street class that may be used in the absence of local data.

EXHIBIT 10-6. SIGNAL DENSITY BY URBAN STREET CLASS

Urban Street Class	Default (signals/km)
I	0.5
II	2
III	4
IV	6

Peak-Hour Factor

In the absence of field measurements of peak-hour factor (PHF), approximations can be used. For congested conditions, 0.92 is a reasonable approximation for PHF. For conditions in which there is fairly uniform flow throughout the peak hour but a recognizable peak does occur, 0.88 is a reasonable estimate for PHF.

Length of Analysis Period

The analytical procedures for estimating speed for an urban street depend on the estimation of delay for the signalized and unsignalized intersections on the street. The delay equations for signalized and unsignalized intersections are most accurate when the demand is less than capacity for the selected analysis period. If the demand exceeds capacity, the intersection delay equations will estimate the delay for all vehicles arriving during the analysis period but will not determine the effect of the excess demand (the residual queue for the next period) on the vehicles arriving during the next analysis period.

The typical analysis period is 15 min. However, if demand creates a residual queue for the 15-min analysis period (i.e., v/c greater than 1.00), the analyst should consider the use of multiple analysis periods or a single longer analysis period to improve the delay estimate.

If a multiple-period analysis is selected, the analyst must carry over the residual queue from one period to the next as discussed in Chapter 16, Appendix F (Extension of Signal Delay Models to Incorporate the Effect of an Initial Queue). The analyst will have to modify or adapt these procedures in the case of unsignalized intersections. Speed, delay, and LOS can then be computed for each analysis period. The analyst must determine how to report these results, since averaging LOS across multiple analysis periods may obscure some of the results.

If a single longer analysis period is selected (such as 1 h), the analyst should use caution in performing the analysis and interpreting the results. The peak-hour factor (which normally is used to compute the peak 15-min flow rate from a 1-h volume) may have to be modified to provide the appropriate flow rate for the longer analysis period. The analyst must also recognize that LOS criteria for urban streets, signalized intersections, and unsignalized intersections were developed for a 15-min analysis period. Conditions that persist for longer periods (presumably with worse peak conditions within those periods) may no longer meet the 15-min LOS criteria provided in this manual.

SERVICE VOLUME TABLE

Exhibit 10-7 is an example service volume table for the four urban street classes. This table is useful for estimates of how many vehicles an urban street can carry at a given level of service, for a particular class and number of lanes (per direction). It is most accurate when the defaults shown in Exhibit 10-7 are applicable. If conditions on a given street vary considerably from those used to create this table, the tabular values are not appropriate.

III. SIGNALIZED INTERSECTIONS

The capacity of an urban street is related primarily to the signal timing and the geometric characteristics of the facility as well as to the composition of traffic on the facility. Geometrics are a fixed characteristic of a facility. Thus, while traffic composition may vary somewhat over time, the capacity of a facility is generally a stable value that can be significantly improved only by initiating geometric improvements.

At signalized intersections, the additional element of time allocation is introduced into the concept of capacity. A traffic signal essentially allocates time among conflicting traffic movements that seek to use the same space. The way in which time is allocated significantly affects the operation and the capacity of the intersection and its approaches.

In analyzing a signalized intersection, the physical unit of analysis is the lane group. A lane group consists of one or more lanes on an intersection approach. The outputs from application of the method in this manual are reported on the basis of each lane group.

SIGNALIZED INTERSECTION FLOW CHARACTERISTICS

For a given lane group at a signalized intersection, three signal indications are displayed: green, yellow, and red. The red indication may include a short period during which all indications are red, referred to as an all-red interval, which with the yellow indication forms the change and clearance interval between two green phases.

Exhibit 10-8 provides a reference for much of the discussion in this section. It presents some fundamental attributes of flow at signalized intersections. The diagram represents a simple situation of a one-way approach to a signalized intersection having two phases in the cycle.

Lane group defined

EXHIBIT 10-7. EXAMPLE SERVICE VOLUMES FOR URBAN STREETS
(SEE FOOTNOTES FOR ASSUMED VALUES)

This table contains approximate values. It is meant for illustrative purposes only. The values are highly dependent on the assumptions used. It should not be used for operational analyses or final design. This table was derived using assumed values listed in the footnote.

Lanes	Service Volumes (veh/h)				
	A	B	C	D	E
Class I					
1	N/A	740	920	1010	1110
2	N/A	1490	1780	1940	2120
3	N/A	2210	2580	2790	3040
4	N/A	2970	3440	3750	4060
Class II					
1	N/A	N/A	620	820	860
2	N/A	N/A	1290	1590	1650
3	N/A	N/A	1920	2280	2370
4	N/A	N/A	2620	3070	3190
Class III					
1	N/A	N/A	600	790	840
2	N/A	N/A	1250	1530	1610
3	N/A	N/A	1870	2220	2310
4	N/A	N/A	2580	2960	3080
Class IV					
1	N/A	N/A	270	690	790
2	N/A	N/A	650	1440	1520
3	N/A	N/A	1070	2110	2180
4	N/A	N/A	1510	2820	2900

Notes

N/A - not achievable given assumptions below.

This table was derived from the conditions listed in the following table.

	Class			
	I	II	III	IV
Signal density (sig/km)	0.5	2	3	6
Free-flow speed (km/h)	80	65	55	45
Cycle length (s)	110	90	80	70
Effective green ratio	0.45	0.45	0.45	0.45
Adj. sat. flow rate	1850	1800	1750	1700
Arrival type	3	4	4	5
Unit extension (s)	3	3	3	3
Initial queue	0	0	0	0
Other delay	0	0	0	0
Peak-hour factor	0.92	0.92	0.92	0.92
% lefts, % rights	10	10	10	10
Left-turn bay	Yes	Yes	Yes	Yes
Lane utilization factor	According to Exhibit 10-23, Default Lane Utilization Factors			

EXHIBIT 10-8. FUNDAMENTAL ATTRIBUTES OF FLOW AT SIGNALIZED INTERSECTIONS

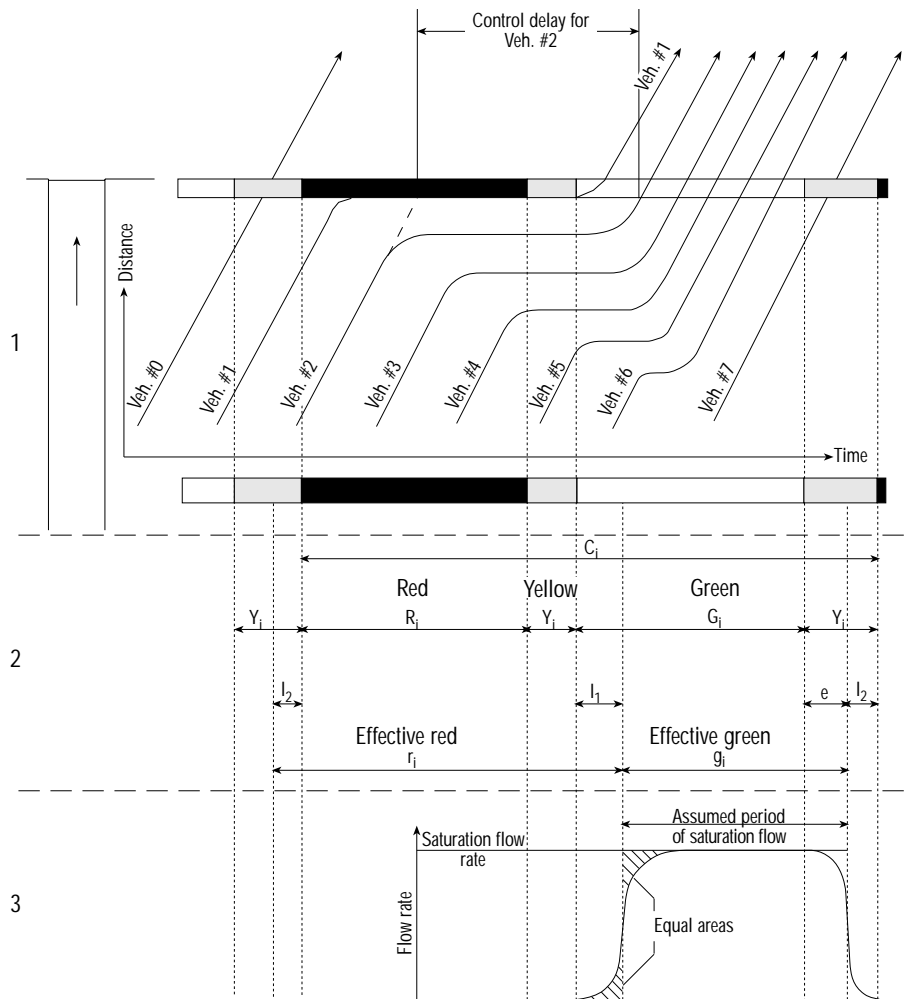

The exhibit is divided into three parts. The first part shows a time-space plot of vehicles on the northbound approach to the intersection. The intervals for the signal cycle are indicated in the diagram. The second part repeats the timing intervals and labels the various time intervals of interest with the symbols used throughout this chapter. The third part is an idealized plot of flow rate passing the stop line, indicating how saturation flow is defined. Further definitions of these variables and other basic terms are provided in Exhibit 10-9.

The signal cycle for a given lane group has two simplified components: effective green and effective red. Effective green time is the time that may be used by vehicles on the subject lane group at the saturation flow rate. Effective red time is defined as the cycle length minus the effective green time.

It is important that the relationship between the actual green, yellow, and red times shown on signal faces and the effective green and red times be understood. Each time a movement is started and stopped, two lost times are experienced. At the beginning of movement, the first several vehicles in the queue experience start-up losses that result in movement at less than the saturation flow rate (Exhibit 10-8). At the end of a movement, a portion of the change and clearance interval (yellow and all-red) is not used for vehicular movement.

Effective green defined
 Effective red defined

EXHIBIT 10-9. SYMBOLS, DEFINITIONS, AND UNITS FOR FUNDAMENTAL VARIABLES OF TRAFFIC FLOW AT SIGNALIZED INTERSECTIONS

Name	Symbol	Definition	Unit
Change and clearance interval	Y_i	The yellow plus all-red interval that occurs between phases of a traffic signal to provide for clearance of the intersection before conflicting movements are released	s
Clearance lost time	l_2	The time between signal phases during which an intersection is not used by any traffic	s
Control delay	d_i	The component of delay that results when a control signal causes a lane group to reduce speed or to stop; it is measured by comparison with the uncontrolled condition	s
Cycle		A complete sequence of signal indications	
Cycle length	C_i	The total time for a signal to complete one cycle	s
Effective green time	g_i	The time during which a given traffic movement or set of movements may proceed; it is equal to the cycle length minus the effective red time	s
Effective red time	r_i	The time during which a given traffic movement or set of movements is directed to stop; it is equal to the cycle length minus the effective green time	s
Extension of effective green time	e	The amount of the change and clearance interval, at the end of the phase for a lane group, that is usable for movement of its vehicles	s
Green time	G_i	The duration of the green indication for a given movement at a signalized intersection	s
Interval		A period of time in which all traffic signal indications remain constant	
Lost time	t_L	The time during which an intersection is not used effectively by any movement; it is the sum of clearance lost time plus start-up lost time	s
Phase		The part of the signal cycle allocated to any combination of traffic movements receiving the right-of-way simultaneously during one or more intervals	
Red time	R_i	The period in the signal cycle during which, for a given phase or lane group, the signal is red	s
Saturation flow rate	s_i	The equivalent hourly rate at which previously queued vehicles can traverse an intersection approach under prevailing conditions, assuming that the green signal is available at all times and no lost times are experienced	veh/h
Start-up lost time	l_1	The additional time consumed by the first few vehicles in a queue at a signalized intersection above and beyond the saturation headway, because of the need to react to the initiation of the green phase and to accelerate	s
Total lost time	L	The total lost time per cycle during which the intersection is effectively not used by any movement, which occurs during the change and clearance intervals and at the beginning of most phases	s

Start-up and clearance lost times are combined and considered to occur at the start of a lane group movement

At the beginning of green, the start-up losses are called start-up lost time (l_1). At the beginning of the yellow, when vehicles tend to continue to enter the intersection for a short period of time, an extension of effective green (e) is experienced. When this extension of green has been exhausted, the remainder of the change and clearance interval is considered to be clearance lost time (l_2). The lost time for a lane group, t_L , is the sum of the start-up and clearance lost times.

Research (2) has shown that start-up lost time (l_1) is about 2 s and that the extension of effective green (e) is about 2 s (sometimes longer under congested conditions). Thus, the relationship shown in Equation 10-1 exists for typical conditions, and the relationship

among actual green, lost time, extension of effective green, and effective green is shown in Exhibit 10-10. When $l_1 = 2$ and $e = 2$ (typical), then $t_L = Y_i$.

$$t_L = l_1 + l_2 = l_1 + Y_i - e \tag{10-1}$$

EXHIBIT 10-10. RELATIONSHIP AMONG ACTUAL GREEN, LOST-TIME ELEMENTS, EXTENSION OF EFFECTIVE GREEN, AND EFFECTIVE GREEN

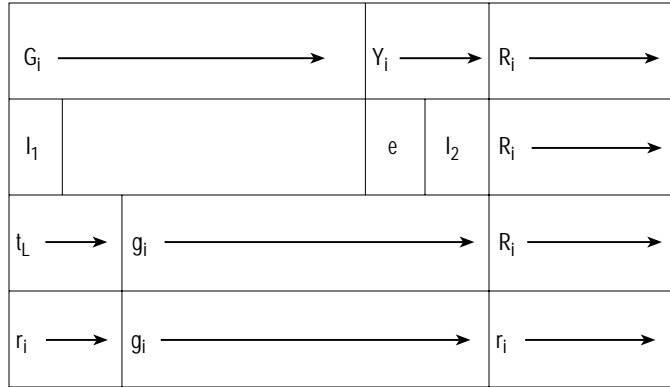

As shown in Exhibit 10-10, the lost time for the movement is deducted from the beginning of the actual green phase. Thus, a small portion of G_i becomes part of the effective red, r_i . This portion is equal to the lost time for the movement, t_L . Because all of the lost time for the movement is deducted at the beginning of the green, effective green can be assumed to run through the end of the yellow-plus-all-red change and clearance interval, Y_i . Thus, for any given movement, effective green time is computed by Equation 10-2 and effective red time by Equation 10-3.

$$g_i = G_i + Y_i - t_L \tag{10-2}$$

$$r_i = R_i + t_L \tag{10-3}$$

The simplified concept of applying all of the lost time at the beginning of a movement makes it easier to analyze more complex signalization involving protected-plus-permitted left-turn phasing. As a general rule, a lost time, t_L , is applied each time a movement is started. Thus, where a given movement starts in a protected phase and continues through a permitted phase (or vice versa), only one lost time is deducted. No lost time is assumed to occur at the boundary between the permitted and protected phases for continuing movements.

Exhibit 10-11 diagrams a more complex situation involving a protected-plus-permitted and permitted-plus-protected compound left-turn phasing, a classic lead-lag phasing scheme in which left turns are protected in Phase 1a [eastbound (EB)] and Phase 1c [westbound (WB)] and permitted during the common Phase 1b. The question of how many lost times are included in such a phase sequence is important. Using the general rule that the entire lost time for a movement is applied at the time the movement begins, the following may be determined:

- In Phase 1a, the EB through and left-turn movements begin. Thus, a lost time is applied to both movements.
- In Phase 1b, the EB through and left-turn movements continue. No lost times are assigned to the continuing movements in this phase. The WB through and left-turn movements begin in this phase, and a lost time is applied to these movements.
- In Phase 1c, only the WB through and left turns continue. Because these movements did not start in this phase, no lost time is applied here. Further, because no movements begin in Phase 1c, no lost time is applied to any movement in Phase 1c.

A lost time is applied each time a movement is started

- In Phase 2, northbound (NB) and southbound (SB) movements begin, and a lost time is applied.

EXHIBIT 10-11. LOST TIME APPLICATION FOR COMPOUND LEFT-TURN PHASING

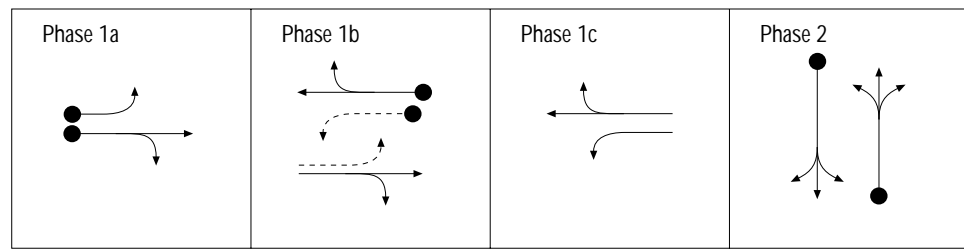

● — Indicates lost time applied

Total lost time is the sum of lost time for the path through the critical movements

The total lost time in the signal cycle, L , is also important. This is the total lost time involved in the critical path through the signal cycle. Determining the critical path and finding L are discussed in Chapter 16.

TRAFFIC SIGNAL CHARACTERISTICS

Modern traffic signals allocate time in a variety of ways, from the simplest two-phase pretimed mode to the most complex multiphase actuated mode.

There are three types of traffic signal controllers:

- Pretimed, in which a sequence of phases is displayed in repetitive order. Each phase has a fixed green time and change and clearance interval that are repeated in each cycle to produce a constant cycle length.
- Fully actuated, in which the timing on all of the approaches to an intersection is influenced by vehicle detectors. Each phase is subject to a minimum and maximum green time, and some phases may be skipped if no demand is detected. The cycle length for fully actuated control varies from cycle to cycle.
- Semiactuated, in which some approaches (typically on the minor street) have detectors and some of the approaches (typically on the major street) have no detectors.

While these equipment-based definitions have persisted in traffic engineering terminology, the evolution of traffic control technology has complicated their function from the analyst's perspective. For purposes of capacity and level-of-service analysis, it is no longer sufficient to use the controller type as a global descriptor of the intersection operation. Instead, an expanded set of these definitions must be applied individually to each lane group.

Each traffic movement may be served by a phase that is either actuated or nonactuated. Signal phases may be coordinated with neighboring signals on the same route, or they may function in an isolated mode without influence from other signals. Nonactuated phases generally operate with fixed minimum green times, which may be extended by reassigning unused green time from actuated phases with low demand, if such phases exist.

Actuated phases are subject to being shortened on cycles with low demand. On cycles with no demand, they may be skipped entirely, or they may be displayed for their minimum duration. With systems in which the nonactuated phases are coordinated, the actuated phases are also subject to early termination (force off) to accommodate the progression design for the system.

Not only the allocation of green time but also the manner in which turning movements are accommodated within the phase sequence significantly affects capacity and operations at a signalized intersection. Signal phasing can provide for protected, permitted, or not opposed turning movements.

A permitted turning movement is made through a conflicting pedestrian or bicycle flow or opposing vehicle flow. Thus, a left-turn movement concurrent with the opposing through movement is considered to be permitted, as is a right-turn movement concurrent with pedestrian crossings in a conflicting crosswalk. Protected turns are those made without these conflicts, such as turns made during an exclusive left-turn phase or a right-turn phase during which conflicting pedestrian movements are prohibited. Permitted turns experience the friction of selecting and passing through gaps in a conflicting vehicle or pedestrian flow. Thus, a single permitted turn often consumes more of the available green time than a single protected turn. Either permitted or protected turning phases may be more efficient in a given situation, depending on the turning and opposing volumes, intersection geometry, and other factors.

Turning movements that are not opposed do not receive a dedicated left-turn phase (i.e., a green arrow), but because of the nature of the intersection, they are never in conflict with through traffic. This condition occurs on one-way streets, at T-intersections, and with signal phasing plans that provide complete separation between all movements in opposite directions (i.e., split-phase operation). Such movements must be treated differently in some cases because they can be accommodated in shared lanes without impeding the through traffic. Left turns that are not opposed at any time should be distinguished from those that may be unopposed during part of the signal cycle and opposed during another part. Left turns that are opposed during any part of the sequence will impede through traffic in shared lanes.

SATURATION FLOW RATE

Saturation flow rate is a basic parameter used to derive capacity. It is defined in Exhibits 10-8 and 10-9. It is essentially determined on the basis of the minimum headway that the lane group can sustain across the stop line as the vehicles depart the intersection. Saturation flow rate is computed for each of the lane groups established for the analysis. A saturation flow rate for prevailing conditions can be determined directly from field measurement and can be used as the rate for the site without adjustment. If a default value is selected for base saturation flow rate, it must be adjusted for a variety of factors that reflect geometric, traffic, and environmental conditions specific to the site under study.

SIGNALIZED INTERSECTION CAPACITY

Capacity at intersections is defined for each lane group. The lane group capacity is the maximum hourly rate at which vehicles can reasonably be expected to pass through the intersection under prevailing traffic, roadway, and signalization conditions. The flow rate is generally measured or projected for a 15-min period, and capacity is stated in vehicles per hour (veh/h).

Traffic conditions include volumes on each approach, the distribution of vehicles by movement (left, through, and right), the vehicle type distribution within each movement, the location and use of bus stops within the intersection area, pedestrian crossing flows, and parking movements on approaches to the intersection. Roadway conditions include the basic geometrics of the intersection, including the number and width of lanes, grades, and lane use allocations (including parking lanes). Signalization conditions include a full definition of the signal phasing, timing, and type of control, and an evaluation of signal progression for each lane group. The analysis of capacity at signalized intersections (Chapter 16) focuses on the computation of saturation flow rates, capacities, v/c ratios, and level of service for lane groups.

LEVEL OF SERVICE

Level of service for signalized intersections is defined in terms of control delay, which is a measure of driver discomfort, frustration, fuel consumption, and increased travel time. The delay experienced by a motorist is made up of a number of factors that

Permitted turning movement

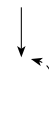

Protected turning movement

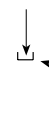

Lane group capacity defined

Control delay is the service measure that defines LOS

relate to control, geometrics, traffic, and incidents. Total delay is the difference between the travel time actually experienced and the reference travel time that would result during base conditions: in the absence of traffic control, geometric delay, any incidents, and any other vehicles. Specifically, LOS criteria for traffic signals are stated in terms of the average control delay per vehicle, typically for a 15-min analysis period. Delay is a complex measure and depends on a number of variables, including the quality of progression, the cycle length, the green ratio, and the v/c ratio for the lane group.

The critical v/c ratio is an approximate indicator of the overall sufficiency of an intersection. The critical v/c ratio depends on the conflicting critical lane flow rates and the signal phasing. The computation of the critical v/c ratio is described in detail in Appendix A and in Chapter 16.

Back of queue defined

The average back of queue is another performance measure that is used to analyze a signalized intersection. The back of queue is the number of vehicles that are queued depending on arrival patterns of vehicles and vehicles that do not clear the intersection during a given green phase. The computation of average back of queue is explained in Appendix G of Chapter 16.

Levels of service are defined to represent reasonable ranges in control delay.

LOS A describes operations with low control delay, up to 10 s/veh. This LOS occurs when progression is extremely favorable and most vehicles arrive during the green phase. Many vehicles do not stop at all. Short cycle lengths may tend to contribute to low delay values.

LOS B describes operations with control delay greater than 10 and up to 20 s/veh. This level generally occurs with good progression, short cycle lengths, or both. More vehicles stop than with LOS A, causing higher levels of delay.

Cycle failure occurs when a given green phase does not serve queued vehicles, and overflows occur

LOS C describes operations with control delay greater than 20 and up to 35 s/veh. These higher delays may result from only fair progression, longer cycle lengths, or both. Individual cycle failures may begin to appear at this level. Cycle failure occurs when a given green phase does not serve queued vehicles, and overflows occur. The number of vehicles stopping is significant at this level, though many still pass through the intersection without stopping.

LOS D describes operations with control delay greater than 35 and up to 55 s/veh. At LOS D, the influence of congestion becomes more noticeable. Longer delays may result from some combination of unfavorable progression, long cycle lengths, and high v/c ratios. Many vehicles stop, and the proportion of vehicles not stopping declines. Individual cycle failures are noticeable.

LOS E describes operations with control delay greater than 55 and up to 80 s/veh. These high delay values generally indicate poor progression, long cycle lengths, and high v/c ratios. Individual cycle failures are frequent.

LOS F describes operations with control delay in excess of 80 s/veh. This level, considered unacceptable to most drivers, often occurs with oversaturation, that is, when arrival flow rates exceed the capacity of lane groups. It may also occur at high v/c ratios with many individual cycle failures. Poor progression and long cycle lengths may also contribute significantly to high delay levels.

Delays in the range of LOS F (unacceptable) can occur while the v/c ratio is below 1.0. Very high delays can occur at such v/c ratios when some combination of the following conditions exists: the cycle length is long, the lane group in question is disadvantaged by the signal timing (has a long red time), and the signal progression for the subject movements is poor. The reverse is also possible (for a limited duration): a saturated lane group (i.e., v/c ratio greater than 1.0) may have low delays if the cycle length is short or the signal progression is favorable, or both.

Thus, the designation LOS F does not automatically imply that the intersection, approach, or lane group is over capacity, nor does an LOS better than E automatically imply that unused capacity is available.

The method in this chapter and Chapter 16 requires the analysis of both capacity and LOS conditions to fully evaluate the operation of a signalized intersection.

REQUIRED INPUT DATA AND ESTIMATED VALUES

Exhibit 10-12 gives default values for input parameters in the absence of local data. If intersection saturation flow is to be estimated as well, then additional saturation flow adjustment data are required. The analyst should note that taking field measurements for use as inputs to an analysis is the most reliable means of generating parameter values. Default values should be considered only when this is not feasible.

EXHIBIT 10-12. REQUIRED DATA FOR SIGNALIZED INTERSECTIONS

Item	Default
Geometric Data	
Exclusive turn lanes	Exhibit 10-13
Demand Data	
Intersection turning movements	-
PHF	0.92
Length of analysis period	0.25 h
Intersection Data	
Control type	-
Cycle	Exhibit 10-16
Lost time	Exhibit 10-17
g/C	-
Arrival type (AT)	3 uncoordinated, 4 coordinated
Unit extension time (UE)	3.0 s
Actuated control adjustment factor (k)	0.40 (planning)
Upstream filtering adjustment factor (l)	1.00
Adjusted saturation flow rate	Exhibit 10-19
Saturation Flow Data	
Base saturation flow rate	1900 pc/h/ln
Lane widths	3.6 m
Heavy vehicles	2 %
Grades	0 %
Parking maneuvers	Exhibit 10-20
Local bus	Exhibit 10-21
Pedestrians	Exhibit 10-22
Area type	-
Lane utilization	Exhibit 10-23

Lane Additions and Drops at Intersections

Short through-lane additions on the approaches to an intersection and short through-lane drops exiting the intersection may not function as full through lanes. The analyst should take this into consideration in determining the equivalent number of through lanes for the approach and in selecting the lane utilization factor for the approach.

Exclusive Turn Lanes

This section summarizes suggestions for establishing the geometric design of an intersection when it has not been defined by existing conditions or by state or local practice (3). These suggestions may also be applied when analysis indicates intersection deficiencies that are to be corrected by changes in geometric design. However, nothing in this section should be construed as constituting a strict guideline or standard. This material should not be used in place of applicable state and local standards, guidelines,

policies, or practice. Rather it is presented here to indicate general possibilities for improvement of signalized intersections.

Exclusive Left-Turn Lanes

The presence of exclusive left-turn lanes is determined by the volume of left-turn traffic, opposing volumes, and safety considerations (4). For analyses of future conditions requiring assumptions about lane configurations, Exhibit 10-13 shows relationships between left-turn volumes and the probable need for left-turn lanes in the absence of local data (5).

EXHIBIT 10-13. TURN VOLUMES PROBABLY REQUIRING EXCLUSIVE LEFT-TURN LANES AT SIGNALIZED INTERSECTIONS

Turn Lane	Minimum Turn Volume (veh/h)
Single exclusive left-turn lane	100
Double exclusive left-turn lanes	300

Exclusive left-turn lanes are also required when an exclusive left-turn phase is warranted at a signalized intersection. In the absence of forecast turn volumes, the analyst should assume that exclusive left-turn lanes will be the standard design for all future intersections, except possibly in the central business district (CBD) (if severe right-of-way constraints exist), on a one-way street, or where the operating jurisdiction does not typically construct such lanes.

Exclusive Right-Turn Lanes

Although right turns are generally made more efficiently than left turns, exclusive right-turn lanes are often provided for many of the same reasons that left-turn lanes are used. Right turns may face a conflicting pedestrian or bicycle flow, but they do not face a conflicting vehicular flow. In general, an exclusive right-turn lane should be considered if the right-turn volume exceeds 300 veh/h and the adjacent mainline volume exceeds 300 veh/h/ln.

Number of Lanes

The number of lanes required on an approach depends on a variety of factors, including the signal design. In general, enough main roadway lanes should be provided to prevent the total of the through plus right-turn volume (plus left-turn volume, if present) from exceeding 450 veh/h/ln. This is a very general suggestion. Higher volumes can be accommodated on major approaches if a substantial portion of available green time can be allocated to the subject approach. If the number of lanes is unknown, the foregoing value is a reasonable starting point for analysis.

Other Features

If lane widths are unknown, the 3.6-m standard lane width should be assumed unless known restrictions prevent such width. Parking conditions consistent with local practice should be assumed. If no information exists, no curb parking and no local buses should be assumed for analysis purposes.

The storage bay length of exclusive turn lanes should be sufficient to handle the turning traffic without reducing the safety or capacity of the approach. A method for estimating the required length of the storage bay is presented in Appendix G of Chapter 16.

Intersection Turning Movements

Intersection turning movements are used in the analysis of signalized intersections on urban streets. If signal timing is not known, then the turning movements may also be used to estimate the effective green ratios (g/C) and cycle length for each intersection.

Default Values in Absence of Turning Movement Data

An urban street analysis can be performed in the absence of intersection turning movement data if the analyst can obtain directional volume counts for the urban street and estimate the average percentage of turning vehicles on the street approaches at the intersections. Peak-hour volumes by direction can be estimated from average daily traffic (ADT). The estimated percentage of turns is used to reduce the total urban street approach volume at intersections where exclusive turn lanes are provided. The percentage of turns made from exclusive lanes at an intersection is subject to local conditions. In the complete absence of local information, default values of 10 percent to represent right turns and 10 percent for left turns as a percentage of the total approach traffic are suggested.

If some of the intersections have exclusive lanes and some do not, the delay at each intersection along the urban street should be computed and summed to obtain the intersection delay for the section. If this is not feasible, the analyst can divide the intersections into two categories: intersections with exclusive lanes and intersections without exclusive lanes. The delay can be computed for each category of intersection, multiplied by the number of intersections in that category, and summed to obtain intersection delay on the urban street.

Turning Movement Estimation

Peak-hour turning movement counts or forecasts are the best source of information on turning movements. In the absence of such information, turning movements can be estimated from approach and departure volumes for each leg of the intersection.

Each approach to the intersection is considered an origin. Each departure leg is a destination as shown in Exhibit 10-14. The problem then becomes one of estimating the origin-destination (O-D) table given the entering and exiting volume on each leg of the intersection.

EXHIBIT 10-14. ORIGIN-DESTINATION LABELS FOR INTERSECTION TURNING MOVEMENTS

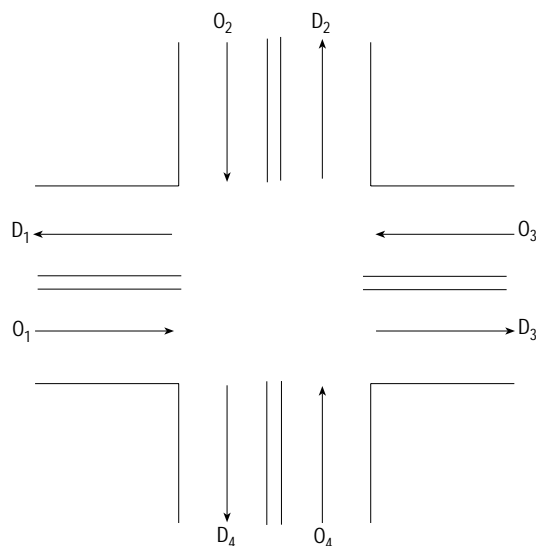

See Chapter 9 for means of estimating peak demands from ADT

This estimation procedure is derived from research (6). The procedure assumes that the number of vehicles going from one leg to another is directly proportional to the total volume entering the one leg and the total volume exiting on the other leg. This assumption may not be valid when other factors or geometric situations are present, such as a nearby freeway on-ramp, which may attract a much higher than normal trip volume. Equation 10-4 is used to estimate the turning movement O-D matrix:

$$T_{ij} = \frac{T_i * T_j}{\sum_i T_{ij}} \quad (10-4)$$

where

- T_{ij} = number of trips going from origin leg i to destination leg j,
- T_i = number of trips originating at origin i, and
- T_j = number of trips leaving at destination j.

U-turns ($T_{i=j}$) trips are assigned a value of zero unless the analyst is aware of a reason for U-turns to be a significant number. Note that Equation 10-4 does not ensure that the final estimates of total trips exiting each leg of the intersection will match the initial value. An iterative procedure can be used to increase or reduce the T_{ij} as necessary to ensure that the sum of the T_{ij} is close to the initial demand estimates for each entering and departing leg of the intersection. This procedure is known as a matrix balancing process (7).

The steps of the iterative procedure use Equations 10-5, 10-6, 10-7, and 10-8.

Step 1. Compute the ratio of desired to actual exiting volume for each departure leg.

$$R_j = \frac{T_j}{\sum_i T_{ij}} \quad (10-5)$$

where

- R_j = ratio of desired to actual exiting volume for exit leg j,
- T_j = desired exiting volume for exit leg j, and
- T_{ij} = current estimate of volume going from origin i to destination j.

Step 2. Multiply all T_{ij} for that exit leg by ratio R_j . Repeat for each exit leg.

Step 3. Compute ratio of desired to actual entering volumes for each entering leg i.

$$R_i = \frac{T_i}{\sum_j T_{ij}} \quad (10-6)$$

where

- R_i = ratio of desired to actual entering volume for entry leg i,
- T_i = desired entering volume for entry leg i, and
- T_{ij} = current estimate of volume going from origin i to destination j.

Step 4. Multiply all T_{ij} for that entry leg by ratio R_i . Repeat for each entry leg.

Step 5. Determine whether the user-specified number of iterations has been exhausted or the user-specified closure criterion is met for all entry and exit legs.

$$\text{diff}_i = T_i - \sum_j T_{ij} \quad \text{for entry legs} \quad (10-7)$$

$$\text{diff}_j = T_j - \sum_i T_{ij} \quad \text{for exit legs} \quad (10-8)$$

Step 6. If any of the computed differences is greater than the closure criterion (a closure criterion of 10 veh/h is suggested) and the iteration limit has not been exceeded, then go back to Step 1.

Peak-Hour Factor

Refer to the peak-hour factor discussion in this chapter under Section II, Urban Streets, Required Input Data and Estimated Values.

Length of Analysis Period

Refer to the length of analysis period discussion in this chapter under Section II, Urban Streets, Required Input Data and Estimated Values.

Intersection Control Type

The intersection control type for an existing facility is known, by definition. In the case of future facilities, the likely intersection control types can be forecast using Exhibit 10-15 and the forecast two-way peak-hour volumes on the major and minor streets. Note that this exhibit is based on a set of specific assumptions, which are identified in a footnote.

EXHIBIT 10-15. INTERSECTION CONTROL TYPE AND PEAK-HOUR VOLUMES
(SEE FOOTNOTE FOR ASSUMED VALUES)

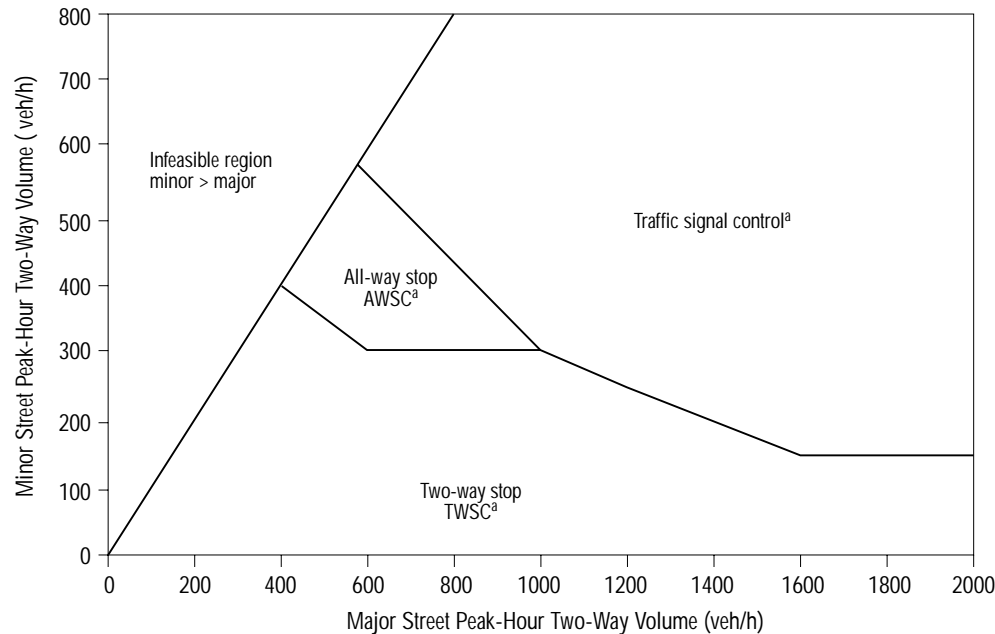

Notes

a. Roundabouts may be appropriate within portion of these ranges.

Source: Adapted from *Traffic Control Devices Handbook* (8, pp. 4–18) - peak-direction, 8-h warrants converted to two-way peak-hour volumes assuming ADT equals twice the 8-h volume and peak hour is 10 percent of daily. Two-way volumes assumed to be 150 percent of peak-direction volume.

Cycle Length

Greater accuracy can be achieved when using the computational methodology if the cycle length for each intersection along the urban street is known or can be calculated on the basis of intersection-specific data. In the absence of a known cycle length or intersection-specific data, the cycle lengths for signalized intersections along an urban street can be estimated using the default values in Exhibit 10-16.

EXHIBIT 10-16. DEFAULT CYCLE LENGTHS BY AREA TYPE

Area Type	Default (s)
CBD	70
Other	100

If the results of the urban street or intersection analysis indicate that the critical volume/capacity ratios for one or more intersections will be greater than 1.00, then the analyst should perform an overall review of geometrics, signal timing, and signal phasing and should consider increasing the cycle length until the $v/c \leq 1.00$. Special analysis procedures for actuated signals are given in Appendix B of Chapter 16. A simpler approach is also presented in Appendix A of this chapter.

Lost Time and Estimation of Signal Phasing

The total lost time in the signal cycle can be obtained from Exhibit 10-17 on the basis of whether left turns are protected or permitted for the major street and the minor street.

EXHIBIT 10-17. DEFAULT LOST TIME PER CYCLE BY LEFT PHASE TYPE

Major Street	Minor Street	Number of Phases	L (s)
Protected	Protected	4	16
Protected	Permitted	3	12
Permitted	Protected	3	12
Permitted	Permitted	2	8

Note:
Protected and permitted refer to left turns.

Unopposed left turns (left turns made from a one-way street or from the unopposed leg of a T-intersection) are treated as permitted, while protected plus permitted left turns can be treated as protected when using Exhibit 10-17. Exhibit 10-17 shows that 4 s of lost time occurs between phases of the signal. Note that the term “phase” is used here as it is defined in this manual and should not be confused with the term “NEMA phase,” which is used in traffic-actuated control to refer to the green time for a single movement. Thus, an eight-phase NEMA controller (which has protected left turns for all four approaches) has four phases.

The actual left-turn treatment should be used, if known, in determining the lost time. If this is unknown, the choice should be made using local policies or practices. Many agencies use the product of the left-turn and opposing through traffic volumes as an indicator of the need for protected phasing. The following criteria and thresholds may be used to determine whether a left turn is likely to need a protected left-turn phase.

Left turns should be considered for protected phases if any of the following criteria is met:

- More than one turning lane is provided,
- The left turn has a demand in excess of 240 veh/h over 1 h, or
- The cross product of left-turn demand and the opposing through demand for 1 h exceeds 50,000 for one opposing through lane, 90,000 for two opposing through lanes, or 110,000 for three or more opposing through lanes.

Note that these thresholds should only be used for planning applications. For design and operational purposes many other factors should be considered, including accident experience, field observations, and conditions that may exist outside of the analysis period. The *Traffic Control Devices Handbook* (8, pp. 4–18) has more information on left-turn phase warrants.

Unprotected left turns from exclusive lanes receive no explicit assignment of green time because they are assumed to be accommodated by green time for the concurrent through movement.

Split phase operation provides complete separation between movements in opposing directions by allowing all movements from only one approach to proceed at the same time. This alternative can be assumed for planning purposes only if

- A pair of opposing approaches is physically offset by more than 20 m,

Criteria for consideration of providing a protected left-turn phase

- A protected left-turn phase must be provided to two opposing single-lane approaches, or
- Both opposing left turns are protected and one of the left turns is accommodated with an exclusive lane plus an optional lane for through and left-turning traffic.

Effective Green Ratio

It is best to use the actual effective green time ratio (g/C) for each movement. In the case of semiactuated and fully actuated signals, the g/C ratios are measured in the field and averaged over several signal cycles during the analysis period. The next best method is to estimate the g/C ratio from intersection turning movements, as described in Appendix A and Appendix B of Chapter 16.

A through g/C for each intersection is desirable; however, for planning purposes, a weighted g/C may be appropriate. The weighted g/C of an urban street is the average of the critical intersection through g/C and the average of all the other g/C's for the urban street. For example, if there are four signals with a through g/C of 0.50 and one signal with a through g/C of 0.40, the weighted average g/C for the urban street is 0.45. The weighted g/C takes into account the adverse effect of the critical intersection and the overall quality of flow for the urban street. An overall default of 0.45 may be used for the major street through movement, but it should be recognized that appropriate ratios can vary depending on characteristics of the urban street.

Weighted g/C for urban street

Arrival Type

The quality of progression is used to determine the arrival type as shown in Exhibit 10-18. The arrival type is used to adjust the computed delay for traffic at each signal. If the arrival type is unknown, a default value of 3 is used for uncoordinated movements and a default value of 4 is used for coordinated movements. Exhibit 15-4 provides a more precise means of determining the arrival type when the proportion of vehicles arriving on green is known.

EXHIBIT 10-18. PROGRESSION QUALITY AND ARRIVAL TYPE

Progression Quality	Arrival Type	Conditions Under Which Arrival Type Is Likely To Occur
Very poor	1	Occurs for coordinated operation on two-way street where one direction of travel does not receive good progression. Signals are spaced less than 500 m apart.
Unfavorable	2	A less extreme version of Arrival Type 1. Signals spaced at or more than 500 m but less than 1000 m apart.
Random arrivals	3	Isolated signals spaced at or more than 1000 m apart (whether or not coordinated).
Favorable	4	Occurs for coordinated operation, often only in one direction on a two-way street. Signals are typically between 500 m and 1000 m apart.
Highly favorable	5	Occurs for coordinated operation. More likely to occur with signals less than 500 m apart.
Exceptional	6	Typical of one-way streets in dense networks and central business districts. Signal spacing is typically under 250 m.

Progression Adjustment Factor

Exhibit 16-12 in Chapter 16 provides guidance on selecting the progression adjustment factor (PF) on the basis of arrival type. The PF = 1.00 for Arrival Type 3. The PF for Arrival Type 4 is 0.84, when g/C is equal to 0.45.

Incremental Delay Adjustment

The incremental delay adjustment (or actuated control adjustment factor), k , is set to 0.50 for pretimed signal control. The same value is used for the nonactuated movements at an intersection with actuated control or semiactuated control.

For the actuated movements, the factor can vary from 0.04 to 0.50, depending on the unit extension for each vehicle actuation and the volume/capacity ratio (X) for the movement. The value of the adjustment factor increases as the volume/capacity ratio increases. Exhibit 15-8 provides guidance on the selection of k given the unit extension and the degree of saturation. In the absence of this information, the analyst may use a value of 0.40 for k , which corresponds to a unit extension of 3 s and a volume/capacity ratio between 0.85 and 0.90. For operational analyses in Chapter 16, the value of k should be based on the computed v/c ratio.

Upstream Filtering/Metering Adjustment Factor

The incremental delay adjustment term (I) accounts for the effects of upstream signals metering arrivals at the study intersection. If the nearest upstream signal is 1.0 km or more away from the subject movement at the study intersection, then I is set to 1.0. Otherwise, I varies from 0.92 to 0.09, decreasing with increasing degree of saturation for the upstream signal. In the absence of this information, the analyst may use a value of 1.0, which applies to isolated intersections, for I .

Base Saturation Flow Rate

This manual uses a default base saturation flow rate of 1,900 pc/h/ln. This value may be increased or decreased on the basis of local field measurements. Approaches with lower approach speeds (less than 50 km/h) often have lower base saturation flow rates, on the order of 1,800 pc/h/ln. Approaches with higher approach speeds (greater than 80 km/h) may have base saturation flow rates higher than 1,900 pc/h/ln.

Adjusted Saturation Flow Rates

The adjusted saturation flow rate per lane is used to compute the delay to through movements at each intersection due to signal control. Initial estimates of the adjusted saturation flow rate for through lanes can be obtained from Exhibit 10-19.

EXHIBIT 10-19. ADJUSTED SATURATION FLOW RATE BY AREA TYPE

Area Type	Default Value (veh/h/ln)	Range (veh/h/ln)
CBD	1700	1600–1800
Other	1800	1700–1950

These adjusted saturation flow rates can also be used for intersection analyses. However, if local data are available on the specific geometry and demand conditions on each approach of an intersection, then the adjusted saturation flow rates can be estimated more accurately. Chapter 15 provides a more accurate method for computing adjusted saturation flow rates when additional data are available.

Lane Widths

The typical lane width is 3.6 m. Urban street lane widths can be as narrow as 3.0 m. The lane closest to a raised median may be extra wide to allow for some shy distance between vehicles and the median. The rightmost lane may be several meters wider than the standard. Lanes wider than 6.0 m should be evaluated to determine whether drivers use the lane as two lanes or as a single wide lane. Drivers making right turns from a wide through lane next to the curb may often form a second queue next to the through vehicles. In this case, the wide through lanes might be analyzed as two lanes: a standard-width through lane plus a narrow exclusive right-turn lane.

The default base saturation flow rate is 1,900 pc/h/ln

The lane width used for the analysis excludes parking lanes (occupied by parked vehicles). Bicycle lanes that are striped to allow right-turning vehicles to enter them for the last several meters before the intersection may be included in the overall lane width of the curb lane.

Heavy Vehicles

The local highway performance management system can be used to obtain local information on the percentage of heavy vehicles by facility and area type. The breakdown between recreational vehicles, trucks, and buses is not used in the computation of adjusted saturation flow rates at signalized intersections. In the absence of local data, a default value of 2 percent heavy vehicles (including all types) may be used for urban streets.

Grades

The approach grade becomes important only when it is significantly steeper than 4 percent. The maximum grades encountered on urban streets typically range from 6 to 11 percent but can reach 31 percent in extreme situations, such as in San Francisco, California. The analyst, in the absence of specific local data, may use 0 percent for essentially flat approaches, 3 percent for moderate grades, and 6 percent for relatively steep grades.

Parking Maneuvers

The number of parking maneuvers per hour is best measured in the field. In the absence of such data, it can be estimated from the number of parking spaces within 80 m of the stop line and the average turnover rate for each space. The number of spaces within 80 m of the stop line is estimated assuming 8 m per space. Each turnover (one car leaving and one car arriving) generates two parking maneuvers. Exhibit 10-20 gives default values for maneuvers per hour, based on 80 percent occupancy of the spaces. These default values may be used in the absence of local data.

EXHIBIT 10-20. PARKING MANEUVER DEFAULTS

Street Type	Number of Spaces in 80 m	Parking Time Limit (h)	Turnover Rate per Hour	Maneuvers per Hour
Two-way	10	1	1	16
		2	0.5	8
One-way	20	1	1	32
		2	0.5	16

Note:

Assumed parking space occupancy of 80 percent.

Local Buses

The number of buses per hour stopping at bus stops within 80 m of the stop line can be estimated from bus schedules for existing conditions. In the absence of such data, the default values in Exhibit 10-21 may be used for intersections where buses are expected to stop.

EXHIBIT 10-21. BUS FREQUENCY DEFAULTS

Area Type	Average Bus Headway (min)	Buses Stopping/h
CBD	5	12
Other	30	2

Pedestrians

Field counts are the best source of information on pedestrian flows. In the absence of counts the defaults listed in Exhibit 10-22 may be used. The analyst should recognize the tendency of field observers to underestimate pedestrian flows when casually observing intersection operations. Relatively infrequent appearances of pedestrians at the intersection, such as one pedestrian per cycle or one pedestrian per minute, can add up to fairly significant hourly pedestrian flows of 60 p/h.

EXHIBIT 10-22. DEFAULTS FOR PEDESTRIAN FLOWS

Area Type	Pedestrian Volume (p/h)
CBD	400
Other	50

Area Type

Only two area types are recognized for signalized intersection analysis: CBD and other. The base saturation flow rate for an intersection is reduced 10 percent for CBD conditions compared with other areas. This adjustment is in addition to the saturation flow reductions for the higher number of parking maneuvers, pedestrians, and bus stops typical of CBDs.

Lane Utilization

The assumed lane utilization can be based on default values unless field data are available or the analyst is aware of special conditions (such as short lane drops or a downstream freeway on-ramp) that might cause drivers to distribute themselves unevenly across the available lanes on the approach. As demand approaches capacity, the analyst may use lane utilization factors closer to 1.0, which would indicate a more uniform use of the available lanes and less opportunity for drivers to freely select their lane. Exhibit 10-23 summarizes lane utilization adjustment factors for different lane group movements and numbers of lanes.

EXHIBIT 10-23. DEFAULT LANE UTILIZATION ADJUSTMENT FACTORS

Lane Group Movements	No. of Lanes in Lane Group	Traffic in Most Heavily Traveled Lane (%)	Lane Utilization Adjustment Factor (f_{LU})
Through or shared	1	100.0	1.000
	2	52.5	0.952
	3 ^a	36.7	0.908
Exclusive left turn	1	100.0	1.000
	2 ^a	51.5	0.971
Exclusive right turn	1	100.0	1.000
	2 ^a	56.5	0.885

Note:

a. If lane group has more lanes than shown in this exhibit, it is recommended that surveys be made or the smallest f_{LU} shown for that type of lane group be used.

SERVICE VOLUME TABLE

Exhibit 10-24 shows the example service volumes (veh/h) that can be accommodated by a given LOS and number of through lanes to provide the desired LOS on an approach (assuming that all other approaches have the same hourly volume). The values are based on assumptions given in a footnote to the exhibit.

EXHIBIT 10-24. EXAMPLE SERVICE VOLUMES FOR SIGNALIZED INTERSECTION
(SEE FOOTNOTE FOR ASSUMED VALUES)

Through Lanes	LOS				
	A	B	C	D	E
	Service Volumes (veh/h)				
1	N/A	130	350	530	590
2	N/A	200	860	1090	1220
3	N/A	N/A	1230	1510	1680

Notes

N/A - not achievable given assumptions listed below.

This table is derived from the following assumptions.

- a. Entries are total hourly volumes for subject approach including turns.
- b. All approaches of intersection have the same demand as the subject approach.
- c. Left turns equal to 10% of approach demand. Right turns equal to 10% of approach demand.
- d. Phasing is protected lefts with exclusive left-turn lane in addition to through lanes.
- e. All approaches are two-way streets.
- f. Peak-hour factor = 0.92.
- g. Saturation flow for each approach is computed assuming the following defaults: lane width = 3.6 m, percent heavy vehicles = 2%, grades = 0%, parking = 8/h, bus = 2/h, pedestrians = 50/h, area type = CBD, lane utilization = 1.05 for 2 lane, 1.10 for 3 lanes, base saturation flow rate = 1900 pc/h/ln. These assumptions result in adjusted saturation flow rates of 1770 for the left-turn lanes and 1560 veh/h/ln for the through lanes.
- h. Lost time is 16 s.
- i. No upstream signal ($I = 1.0$).
- j. Pretimed signal ($k = 0.50$).
- k. Arrival type = 3.
- l. Analysis period (T) = 0.25 h.
- m. Initial queue = 0.
- n. Signal timing set to maximize service volumes subject to pedestrian clearance time requirements, minimum phase lengths, and maximum signal length of 150 s.
- o. Cycle lengths are as follows.

Through Lanes	LOS A	LOS B	LOS C	LOS D	LOS E
1	N/A	60 s	60 s	110 s	150 s
2	N/A	70 s	80 s	110 s	150 s
3	N/A	N/A	80 s	100 s	150 s

Note that minimum cycle lengths to serve pedestrians are 60 s for single-lane approach intersection, 70 s for two-lane approach intersection, and 80 s for a three-lane approach intersection. Minimum pedestrian clearance times are 3 s per through lane plus 3 s for left-turn lane plus 6 s walk display. Minimum left-turn phase was set at 6 s plus phase change and clearance interval of 4 s.

IV. UNSIGNALIZED INTERSECTIONS

Three types of unsignalized intersections are addressed in this manual: two-way stop-controlled (TWSC), all-way stop-controlled (AWSC), and roundabouts.

CHARACTERISTICS OF TWSC INTERSECTIONS

TWSC intersections are common in the United States and abroad. Stop signs are used to control vehicle movements at such intersections. At TWSC intersections, the stop-controlled approaches are referred to as the minor street approaches; they can be either public streets or private driveways. The intersection approaches that are not controlled by stop signs are referred to as the major street approaches.

A three-leg intersection is considered to be a standard type of TWSC intersection if the single minor street approach (i.e., the stem of the T configuration) is controlled by a stop sign. Three-leg intersections where two of the three approaches are controlled by stop signs are a special form of unsignalized intersection control.

FLOW AT TWSC INTERSECTIONS

TWSC intersections assign the right-of-way among conflicting traffic streams according to the following hierarchy:

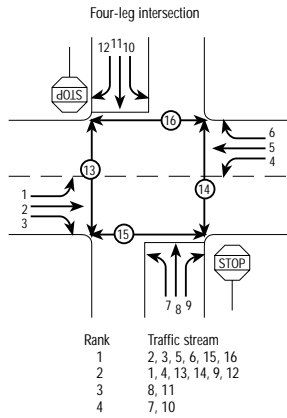

- Rank 1 All conflicting movements yield the right-of-way to any through or right-turning vehicle on the major street approaches. The major street through and right-turning movements are the highest-priority movements at a TWSC intersection.
- Rank 2 Vehicles turning left from the major street onto the minor street yield only to conflicting major street through and right-turning vehicles. All other conflicting movements at a TWSC intersection yield to these major street left-turning movements. Vehicles turning right from the minor street onto the major street yield only to conflicting major street through movements.
- Rank 3 Minor street through vehicles yield to all conflicting major street through, right-turning, and left-turning movements.
- Rank 4 Minor street left-turning vehicles yield to all conflicting major street through, right-turning, and left-turning vehicles and to all conflicting minor street through and right-turning vehicles.

Even though the hierarchy described above suggests that the highest-priority movements experience no delay as they travel through a TWSC intersection, experience shows that their right-of-way is sometimes preempted by other conflicting movements. Such preemptions most often occur during periods of congestion when vehicles in the conflicting movements are experiencing long delays and queues (or when separate left-turn bays are not provided on the major street).

GAP ACCEPTANCE MODELS

Gap acceptance models begin with the recognition that TWSC intersections give no positive indication or control to the driver on the minor street as to when it is safe to leave the stop line and enter the major traffic stream. The driver must determine both when a gap in the major stream is large enough to permit safe entry and when it is the driver's turn to enter on the basis of the relative priority of the competing traffic streams. This decision-making process has been formalized into what is commonly known as gap acceptance theory. Gap acceptance theory includes three basic elements: the size and distribution (availability) of gaps in the major traffic stream, the usefulness of these gaps to the minor stream drivers, and the relative priority of the various traffic streams at the intersection.

Availability of Gaps

The first element to consider is the proportion of gaps of a particular size in the major traffic stream offered to the driver entering from the minor stream, as well as the pattern of arrival times of vehicles. The distribution of gaps between the vehicles in the different streams has a major effect on the performance of the intersection.

Usefulness of Gaps

The second element to consider is the extent to which drivers find gaps of a particular size useful when attempting to enter the intersection. It is generally assumed in gap acceptance theory that drivers are both consistent and homogeneous. In reality, this assumption is not entirely correct. Studies have demonstrated that different drivers have different gap acceptance thresholds and even that the gap acceptance threshold of an individual driver often changes over time (9). In this manual the critical gap and follow-up times are considered representative of a statistical average of the driver population in the United States.

Relative Priority of Various Streams at the Intersection

Different streams have different ranking in a priority hierarchy. The gap acceptance process evaluates them with impedance terms through the order of departures. Typically, gap acceptance processes assume that drivers on the major road or stream are unaffected

Critical gap is the minimum time between successive major street vehicles where minor street vehicles make a maneuver

Follow-up time is the time span between the departure of one vehicle from the minor street and the departure of the next vehicle using the same gap

by the minor stream drivers. If this is not the case, the gap acceptance process has to be modified.

CAPACITY OF TWSC INTERSECTIONS

At TWSC intersections, drivers on the controlled approaches are required to select gaps in the major street flow through which to execute crossing or turning maneuvers on the basis of judgment. In the presence of a queue, each driver on the controlled approach must also use some time to move into the front-of-queue position and prepare to evaluate gaps in the major street flow. Thus, the capacity of the controlled legs is based on three factors: the distribution of gaps in the major street traffic stream, driver judgment in selecting gaps through which to execute the desired maneuvers, and the follow-up time required by each driver in a queue.

The basic capacity model assumes that gaps in the conflicting stream are randomly distributed. When traffic signals on the major street are within 0.4 km of the subject intersection, flows may not be random but will likely have some platoon structure.

Pedestrians crossing an intersection impede lower-ranked minor street vehicles, but only one lane at a time. This is because vehicles performing a given through or turning movement tend to pass in front of or behind pedestrians once a driver's target lane is clear. Pedestrian flows are counted somewhat differently than are vehicle flows. If the typical pattern is for pedestrians to walk individually, each pedestrian is counted individually in the pedestrian flow. However, if pedestrians tend to cross in groups, the number of groups is counted. The important factor is to determine the number of blockages. In most cases, this will be a combination of individual pedestrians and groups of pedestrians. Thus, as defined for the purpose of determining the pedestrian impedance, the pedestrian volume is the sum of individual pedestrians crossing individually and groups of pedestrians crossing together during the analysis time period.

The existence of a raised or striped median or a two-way left-turn lane (TWLTL) on the major street often causes some degree of a gap acceptance phenomenon known as "two-stage gap acceptance." For example, the existence of a raised or striped median causes a significant proportion of the minor street drivers to first cross part of the major street approach and then pause in the middle of the road to wait for another gap in the other approach. If a TWLTL exists on the major street, the minor street left-turn vehicle usually merges into the TWLTL first, then seeks a usable gap on the other approach while slowly moving some distance along the TWLTL. Both of these behaviors can increase capacity.

The geometric elements near the stop line on the stop-controlled approaches of many intersections may result in a higher capacity than the shared-lane capacity equation may predict. This is because, at such approaches, two vehicles may occupy or depart from the stop line simultaneously as a result of a large curb radius, a tapered curb, or a parking prohibition. The magnitude of this effect will depend in part on the turning movement volumes and the resultant probability of two vehicles being simultaneously at the stop line and on the storage length available to feed the second position at the stop line.

Often, two or three movements share a single lane on the minor approach. With this lane sharing, vehicles from different movements do not have simultaneous access to gaps, nor can more than one vehicle from the sharing movements use the same gap, which influences capacity.

The existence of nearby signalized intersections (i.e., traffic signals on the major street within 0.4 km of the subject intersection) typically causes vehicles to arrive at the intersection in platoons. This influences the size and distribution of available gaps and may cause an increase in the minor street capacity. The greater the number of vehicles traveling in platoons, the higher the minor street capacity for a given opposing volume. This is due to the greater proportion of large gaps that more than one minor street vehicle can use. If signalized intersections exist upstream of the subject intersection in both directions, the effect is much more complex.

CHARACTERISTICS OF AWSC INTERSECTIONS

AWSC intersections require every vehicle to stop at the intersection before proceeding. Since each driver must stop, the judgment as to whether to proceed into the intersection is a function of traffic conditions on the other approaches. If no traffic is present on the other approaches, a driver can proceed immediately after the stop is made. If there is traffic on one or more of the other approaches, a driver proceeds only after determining that there are no vehicles currently in the intersection and that it is the driver's turn to proceed.

FLOW AT AWSC INTERSECTIONS

Field observations indicate that AWSC intersections operate in either a two-phase or a four-phase pattern, based primarily on the complexity of the intersection geometry. Flows are determined by a consensus of right-of-way that alternates between the north-south and east-west streams (for a single-lane approach) or proceeds in turn to each intersection approach (for a multilane approach intersection).

If traffic is present on the subject approach only, vehicles depart as rapidly as individual drivers can safely accelerate into and clear the intersection. This is illustrated as Case 1 in Exhibit 10-25.

EXHIBIT 10-25. ANALYSIS CASES FOR AWSC INTERSECTIONS

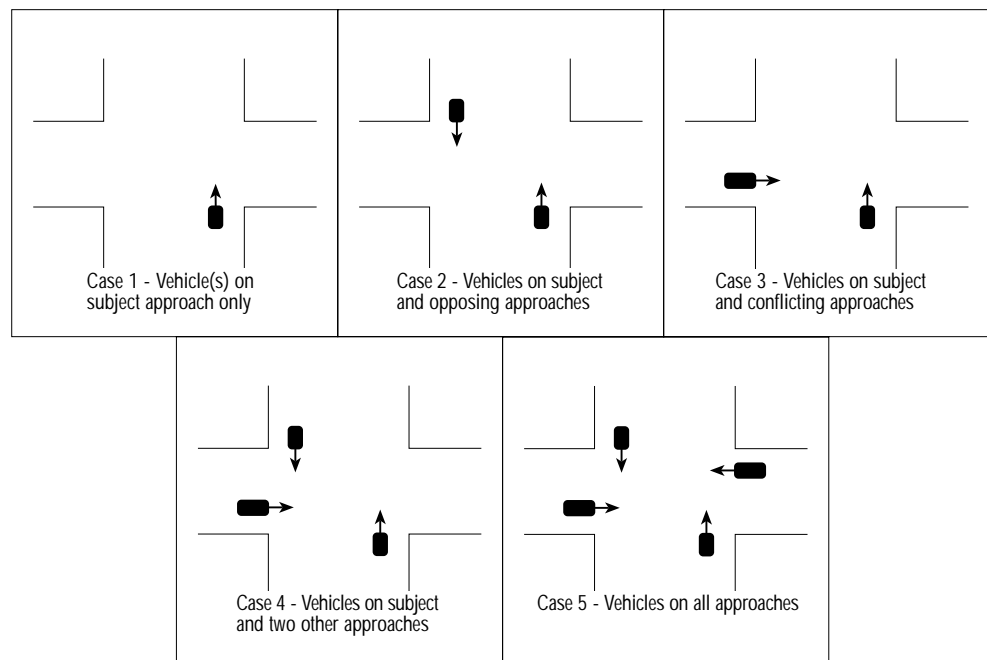

If traffic is present on the other approaches, as well as on the subject approach, the saturation headway on the subject approach will increase somewhat, depending on the degree of conflict that results between the subject approach vehicles and the vehicles on the other approaches. In Case 2 some uncertainty is introduced with a vehicle on the opposing approach, and thus the saturation headway will be greater than for Case 1. In Case 3, vehicles on one of the conflicting approaches further restrict the departure rate of vehicles on the subject approach, and the saturation headway will be longer than for Cases 1 or 2. In Case 4, two vehicles are waiting on opposing or conflicting approaches. When all approaches have vehicles as in Case 5, saturation headways are even longer than in the other cases, since the potential for conflict between vehicles is greatest. The increasing degree of potential conflict translates directly into both longer driver decision

times and saturation headways. Since no traffic signal controls the stream movement or allocates the right-of-way to each conflicting traffic stream, the rate of departure is controlled by the interactions between the traffic streams themselves.

CHARACTERISTICS OF ROUNDABOUTS

Three main features of roundabouts are illustrated in Exhibit 10-26: the central island, the circulating roadway, and the splitter island (10). A roundabout is distinguished from a traffic circle in general by the following characteristics:

- Vehicles entering a roundabout are required to yield to vehicles within the circulating roadway. Because of right-of-way constraints, some small traffic circles are unable to deflect vehicle paths properly to achieve the desired speed reduction.
- The circulating vehicles are not subjected to any other right-of-way conflicts, and weaving is kept to a minimum. This provides the means by which the priority is distributed and alternated among vehicles. A vehicle entering as a subordinate vehicle immediately becomes a priority vehicle until it exits the roundabout. Some traffic circles impose control measures within the circulating roadway or are designed with weaving areas to resolve conflicts between movements.
- Some small circles do not control speed because of the small central island diameter and because the radius of the vehicle path is large.
- No parking is allowed on the circulating roadway. Parking maneuvers, if allowed, would prevent the roundabout from operating in a manner consistent with its design. Some larger traffic circles permit parking within the circulating roadway.
- No pedestrian activities take place on the central island. Pedestrians are not expected to cross the circulating roadway. Some larger traffic circles provide for pedestrians crossing to, and activities on, the central island.
- All vehicles circulate counterclockwise (in countries with a drive right policy), passing to the right of the central island. In some small traffic circles (sometimes called mini-traffic circles) left-turning vehicles are expected to pass to the left of the central island.
- Roundabouts are designed to properly accommodate specified design vehicles. Some smaller traffic circles are unable to accommodate large vehicles, usually because of right-of-way constraints.
- Roundabouts have raised splitter islands on all approaches. Splitter islands are an essential safety feature, required to separate traffic moving in opposite directions and to provide refuge for pedestrians. Some smaller traffic circles do not provide raised splitter islands.
- When pedestrian crossings are provided for on the approach roads, they are placed approximately one car length back from the entry point. Some traffic circles accommodate pedestrians in other places, such as the yield point.
- Vehicle speed into and through roundabouts is controlled by the physical features of a roundabout and not by signs or pavement markings.

PERFORMANCE MEASURES

Four measures are used to describe the performance of TWSC intersections: control delay, delay to major street through vehicles, queue length, and v/c ratio. The primary measure that is used to provide an estimate of LOS is control delay. This measure can be estimated for any movement on the minor (i.e., the stop-controlled) street. By summing delay estimates for individual movements, a delay estimate for each minor street movement and minor street approach can be achieved.

For AWSC intersections, the average control delay (in seconds per vehicle) is used as the primary measure of performance. Control delay is the increased time of travel for a vehicle approaching and passing through an AWSC intersection, compared with a free-flow vehicle if it were not required to slow or stop at the intersection.

EXHIBIT 10-26. BASIC ROUNDABOUT GEOMETRICS

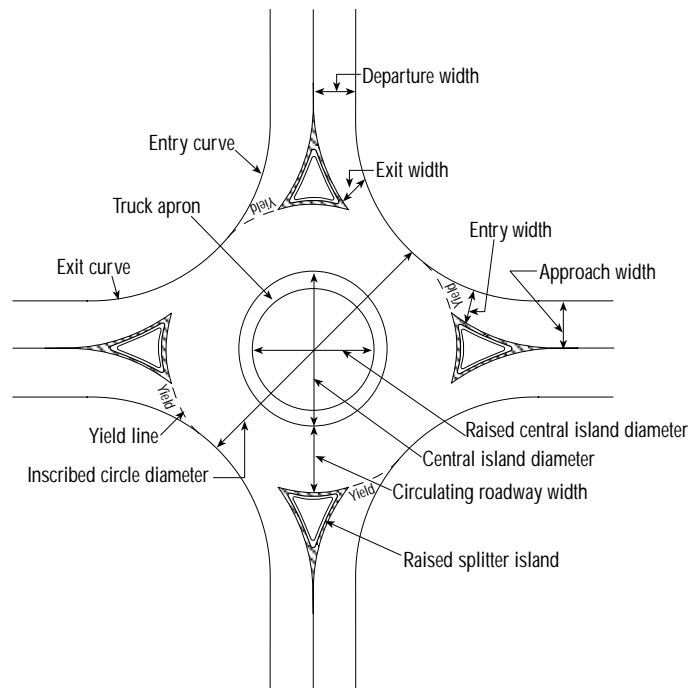

REQUIRED INPUT DATA AND ESTIMATED VALUES

Unsignalized intersections require basic input data. The data requirements are summarized below for TWSC intersections, AWSC intersections, and roundabouts.

Two-Way Stop-Controlled Intersections

Intersection Geometry

Major street through lanes—Through lanes include those shared by through and turning traffic. Separate left-turn or right-turn lanes are not included in this lane count.

Major street left-turn lanes—The major street left-turn lanes affect the estimated delay for major street through traffic. Exhibit 10-27 can be used to decide whether left-turn lanes are likely to be in place in the future at unsignalized TWSC intersections on two-lane highways.

Minor street lanes—The analyst must provide the number and use of the lanes on the minor street approaches. Any shared lanes should be noted. These data affect the capacity of the minor street movements.

Channelization—Raised or painted islands that separate conflicting flows from each other should be noted. They affect the impedance adjustments and calculation of conflicting traffic flows.

Approach grade—Grades are needed for all approaches and are expressed as a percentage, with positive values for upgrades and negative values for downgrades. The grade affects the calculation of critical gaps.

Control

Movement controls—The analyst should note which movements are stop-controlled and which are yield-controlled (if any). These data affect the calculation of conflicting traffic flows.

EXHIBIT 10-27. MINIMUM APPROACH VOLUMES (veh/h) FOR LEFT-TURN LANES ON TWO-LANE HIGHWAYS AT UNSIGNALIZED INTERSECTIONS

Opposing Volume	5% Left Turns	10% Left Turns	20% Left Turns	30% Left Turns
Free-Flow Speed = 60 km/h				
800	330	240	180	160
600	410	305	225	200
400	510	305	275	245
200	640	470	350	305
100	720	515	390	340
Free-Flow Speed = 80 km/h				
800	280	210	165	135
600	350	260	195	170
400	430	320	240	210
200	550	400	300	270
100	615	445	335	295
Free-Flow Speed = 100 km/h				
800	230	170	125	115
600	290	210	160	140
400	365	270	200	175
200	450	330	250	215
100	505	370	275	240

Source: AASHTO *Policy on Geometric Design of Highways and Streets* (1, p. 791).

Volumes

Turning movement volumes—The peak-hour turning volumes are required for all intersection approaches. Vehicle classification is used to calculate the percentage of heavy vehicles.

Peak-hour factor (PHF)—The peak-hour volumes must be divided by the PHF before beginning the computations. If the analyst has peak 15-min flow rates, these flow rates can be entered directly with the PHF set to 1.00.

Length of study period (T)—Refer to urban street description of length of study period in this chapter under required input data and estimated values.

All-Way Stop-Controlled Intersections

Intersection Geometry

The number and configuration of lanes on each approach are used to determine the complexity of the analysis and to select applicable geometry groups.

Volumes

Turning movement volumes—Peak-hour turning volumes by movement for all intersection approaches are required, including vehicle classification (to calculate the percentage of heavy vehicles).

Peak-hour factor (PHF)—The peak-hour volumes must be divided by the PHF before beginning the computations. If the analyst has peak 15-min flow rates, these flow rates can be entered directly with the PHF set to 1.00.

Length of study period (T)—Refer to urban street description of length of study period in this chapter under required data and estimated values.

Roundabouts

Intersection Geometry

The geometric layout of the intersection must be consistent with the characteristics of a single-lane roundabout (see Chapter 17, “Unsignalized Intersections,” for details).

Volumes

Turning movement volumes—Peak-hour turning volumes by movement for all intersection approaches are required.

Peak-hour factor (PHF)—For the analysis to reflect conditions during the peak 15 min, the peak-hour volumes must be divided by the PHF before beginning the computations. If the analyst has peak 15-min flow rates, these flow rates can be entered directly with the PHF set to 1.00.

SERVICE VOLUME TABLES

Exhibits 10-28 and 10-29 show the number of lanes required to achieve a desired LOS for a TWSC intersection. The LOS shown in these example tables reflects conditions for the worst movement at the intersections, which is usually the left turn from the stop-controlled minor street. These example service volumes reflect the specific assumptions listed in the exhibit footnotes. Exhibit 10-28 is for a T-intersection and gives example service volumes for a single-lane approach on the minor street. Exhibit 10-29 gives example service volumes for four-leg intersections with varying lane configurations and two-way hourly volumes on the major street approaches ranging between 500 and 1,500 veh/h.

Exhibit 10-30 can be used to estimate the number of through lanes for each approach required to achieve a desired LOS for an AWSC intersection. Since the intersection is all-way stop controlled, each vehicle is required to stop before proceeding. Adding left-turn or right-turn pockets will not significantly reduce delay. The entries in the exhibit are maximum hourly approach volumes for any one of the four approaches to the intersection. These example service volumes reflect the specific assumptions found in the exhibit footnotes.

EXHIBIT 10-28. EXAMPLE OF MINOR STREET SERVICE VOLUMES FOR T-INTERSECTION
TWO-WAY STOP INTERSECTION
(SEE FOOTNOTE FOR ASSUMED VALUES)

This table contains approximate values. It is meant for illustrative purposes only. The values are highly dependent on the assumptions used. It should not be used for operational analyses or final design. This table was derived using assumed values listed in the footnote.

Major Street 2-Way Volume (veh/h)	LOS				
	A	B	C	D	E
	Minor Street Approach Service Volumes for Single-Lane Approach (veh/h)				
200	110	450	630	700	760
400	N/A	280	460	530	590
600	N/A	150	320	390	440
800	N/A	40	210	270	320
1000	N/A	N/A	120	180	230

Note:
Assumptions: minor street left turns and right turns are equal; major street left turns and right turns are each 10% of the approach volume; PHF = 0.92; heavy vehicles = 2%; grade = 0%; pedestrian flow = 0; no flared minor approach; no channelization; 50/50 split of major street traffic; two-lane major street; major street left-turn pocket.
N/A = not achievable under given conditions.

EXHIBIT 10-29. EXAMPLE OF MINOR STREET SERVICE VOLUMES FOR FOUR-LEG INTERSECTION, TWO-WAY STOP
(SEE FOOTNOTE FOR ASSUMED VALUES)

Major Street 2-Way Volume (veh/h)	LOS				
	A	B	C	D	E
Minor Street Approach Service Volumes (veh/h), Major Street = 1 Lane Plus Turn Pockets, Minor Street = 1 Lane, No Turn Pockets					
500	N/A	90	220	260	300
1000	N/A	N/A	30	70	100
1500	N/A	N/A	N/A	N/A	N/A
Minor Street Approach Service Volumes (veh/h), Major Street = 1 Lane Plus Turn Pockets, Minor Street = 1 Lane, Plus Turn Pockets					
500	N/A	170	370	420	470
1000	N/A	N/A	60	130	180
1500	N/A	N/A	N/A	N/A	10
Minor Street Approach Service Volumes (veh/h), Major Street = 2 Lane Plus Turn Pockets, Minor Street = 1 Lane, No Turn Pockets					
500	N/A	120	240	300	340
1000	N/A	N/A	40	100	130
1500	N/A	N/A	N/A	N/A	20
Minor Street Approach Service Volumes (veh/h), Major Street = 2 Lane Plus Turn Pockets, Minor Street = 1 Lane, Plus Turn Pockets					
500	N/A	240	440	500	550
1000	N/A	N/A	110	180	230
1500	N/A	N/A	N/A	N/A	40

Note:
Assumptions: both approach legs of minor streets have same volume. Minor street left turns and right turns are equal to 33% of total minor street approach volume. Major street left turns and right turns are each 10% of the approach volume; PHF = 0.92; a default PCE of 1.10 was used; no flared minor approach; no channelization; no heavy vehicles.
N/A = not achievable under given conditions.

EXHIBIT 10-30. EXAMPLE OF APPROACH SERVICE VOLUMES FOR ALL-WAY STOP INTERSECTIONS FOR SINGLE APPROACH
(SEE FOOTNOTE FOR ASSUMED VALUES)

	LOS				
	A	B	C	D	E
Through Lanes	Approach Service Volumes (veh/h)				
1	170	260	310	340	350
2	180	320	430	480	520

Note:
Assumptions: equal demand on all approaches, identical lanes on all four approaches, PHF = 0.92, 10% left turns, 10% right turns, and no heavy vehicles.

This table contains approximate values. It is meant for illustrative purposes only. The values are highly dependent on the assumptions used. It should not be used for operational analyses or final design. This table was derived using assumed values listed in the footnote.

This table contains approximate values. It is meant for illustrative purposes only. The values are highly dependent on the assumptions used. It should not be used for operational analyses or final design. This table was derived using assumed values listed in the footnote.

V. REFERENCES

1. American Association of State Highway and Transportation Officials, *A Policy on Geometric Design of Highways and Streets*. Washington, D.C., 1990.
2. Messer, C. J., and J. A. Bonneson. *Capacity of Interchange Ramp Terminals*. Final Report, NCHRP Project 3-47. Texas A&M Research Foundations, College Station, April 1997.

3. Messer, C. J. *Guidelines for Signalized Left-Turn Treatments, Implementation Package*. FHWA-IP-81-4. Federal Highway Administration, U.S. Department of Transportation, 1981.
4. Koepke, F. J., and H. S. Levinson. *NCHRP Report 348: Access Management Guidelines for Activity Centers*. TRB, National Research Council, Washington, D.C., 1992.
5. Harwood, D. W., M. T. Pietrucha, M. D. Wooldridge, R. E. Brydia, and K. Fitzpatrick. *NCHRP Report 375: Median Intersection Design*. TRB, National Research Council, Washington, D.C., 1995.
6. Pedersen, N. J., and D. R. Samdahl. *NCHRP Report 255: Highway Traffic Data for Urbanized Area Project Planning and Design*. TRB, National Research Council, Washington, D.C., 1982.
7. Ortuzar, J. D., and L. G. Willumsen. *Modeling Transport*, 2nd ed. John Wiley and Sons, New York, 1994.
8. *Traffic Control Devices Handbook*. Federal Highway Administration, U.S. Department of Transportation, 1983.
9. Kittelson, W. K., and M. A. Vandehey. Delay Effects on Driver Gap Acceptance Characteristics at Two-Way Stop-Controlled Intersections. In *Transportation Research Record 1320*, TRB, National Research Council, Washington, D.C., 1991, pp. 154-159.
10. Kyte, M., Z. Tian, Z. Mir, Z. Hameedmansoor, W. Kittelson, M. Vandehey, B. Robinson, W. Brilon, L. Bondzio, N. Wu, and R. Troutbeck. *Capacity and Level of Service at Unsignalized Intersections*. Final Report, NCHRP Project 3-46. April 1996.

APPENDIX A. QUICK ESTIMATION METHOD FOR SIGNALIZED INTERSECTIONS

X_{cm} is the measure of effectiveness for quick estimation methods

A quick estimation method for determining the critical v/c ratio, X_{cm} , signal timing, and delay for a signalized intersection is described in this appendix. This procedure can be used when only minimal data are available for the analysis and only approximate results are desired.

The quick estimation method consists of six steps: assembly of the input data, determination of left-turn treatment, lane volume computations, estimation of signal timing plan, calculation of the critical v/c ratio, and calculation of average vehicle delay.

INPUT REQUIREMENTS

The overall data requirements are summarized in Exhibit A10-1. The input worksheet is shown in Exhibit A10-2. Some of the input requirements may be met by assumed values or default values that represent reasonable values for operating parameters. Other data items are site specific and must be obtained in the field. The objective of using the quick estimation method is to minimize the need for collection of detailed field data.

The calculations integrated into the quick estimation method and specifically indicated in the worksheets include several default values for variables. The values have been selected to be generally representative and to simplify the analysis. The computations for the quick estimation method must be based on the traffic volumes and lane configuration of each approach to the intersection.

The worksheets for computation are shown in Exhibits A10-2, A10-3, A10-4, and A10-5. The first step is to input geometric data and all volume-related parameters on the

input worksheet. Critical lane volume (V_{CL}) and left-turn volume (V_{LT}) are obtained according to the method discussed below.

EXHIBIT A10-1. INPUT DATA REQUIREMENTS FOR QUICK ESTIMATION METHOD

Data Item	Comments
Volumes	By movement as projected
Lanes	Left, through, or right; exclusive or shared
Adjusted saturation flow rate	Includes all adjustments for PHF, CBD, grades, etc.
Left-turn treatment (phasing plan)	Use actual treatment, if known. See discussion of phasing plan development.
Cycle length (min and max)	Use actual value, if known. May be estimated using signal operations worksheet.
Lost time	May be estimated using signal operations worksheet
Green times	Use actual values, if known. May be estimated using signal operations worksheet.
Coordination	Isolated intersection versus intersection influenced by upstream signals
Peak-hour factor	Use default value of 0.90 if not known
Parking	On-street parking is or is not present
Area type	Signal is or is not in CBD

DETERMINATION OF LEFT-TURN TREATMENT

The signal timing needs of permitted left turns are not considered in the syntheses of the traffic signal timing plan in the quick estimation technique. Therefore, failure to assume protected left-turn phases for heavy left-turn flow rates will generally produce an overly optimistic assessment of the critical v/c ratio and intersection operations.

Exhibit A10-3 provides a procedure for determining whether a permitted left turn should be protected instead in the quick estimation of intersection operations. This left-turn treatment check is not necessary if the left turn is unopposed or if the analyst wishes to analyze only protected left turns. Above all, the left-turn treatment checks should not be used as the sole determinant of the need for protected left-turn phasing.

Even if the analyst already knows that permitted left-turn treatment will be implemented, this left-turn treatment check must still be used to check that the left-turn treatment does not conflict with the assumptions on which this quick estimation method is based. The more robust methodology presented in Chapter 16, "Signalized Intersections," should be used whenever the analyst wishes to analyze an intersection with permitted left turns that fails the left-turn treatment checks in Exhibit A10-3.

The determination of the recommended left-turn treatment is accomplished in four steps. The first step recommends left-turn protection if there is more than one left-turn lane on the approach. The second step recommends left-turn protection if there are more than 240 veh/h (unadjusted) turning left. The third step recommends left-turn protection if the cross-product of the unadjusted left turn and opposing mainline volumes exceeds the minimum values shown in Exhibit A10-3. The opposing mainline volume is usually the summation of the opposing through and right-turning vehicles. If the analyst recognizes that the opposing approach geometry is such that left-turn vehicles can safely ignore the opposing right-turn vehicles, the opposing right-turn vehicles can be excluded. Such situations occur if there is an exclusive right-turn lane on the opposing approach and the right-turning vehicles have their own lane to turn into on the cross street without interfering with the left-turning vehicles.

The final step compares the left-turn demand with the average number that can sneak through on the yellow phase and recommends left-turn protection if the opposing flows are high enough to result in a left-turn equivalence factor (computed later) exceeding 3.5.

Do not use this quick estimation method as the sole basis for determining need for protected left-turn phasing

Once it is determined that left-turn protection is recommended for a given approach, the subsequent checks for that approach are unnecessary.

EXHIBIT A10-2. QUICK ESTIMATION INPUT WORKSHEET

QUICK ESTIMATION INPUT WORKSHEET															
General Information						Site Information									
Analyst	_____					Intersection	_____								
Agency or Company	_____					Area Type	<input type="checkbox"/> CBD	<input type="checkbox"/> Other							
Date Performed	_____					Jurisdiction	_____								
Analysis Time Period	_____					Analysis Year	_____								
Intersection Geometry															
															
Volume and Signal Input															
		EB			WB			NB			SB				
		LT	TH	RT ¹	LT	TH	RT ¹	LT	TH	RT ¹	LT	TH	RT ¹		
Volume, V (veh/h)															
Proportion of LT or RT (P _{LT} or P _{RT}) ²			-			-			-			-			
Parking (Yes/No)															
Left-turn treatment (permitted, protected, not opposed) (if known)															
Peak-hour factor, PHF	_____														
Cycle length	Minimum, C _{min}	_____ s					Maximum, C _{max}	_____ s					or	Given, C	_____ s
Lost time/phase	_____ s														
Notes															
<ol style="list-style-type: none"> 1. RT volumes, as shown, exclude RTOR. 2. P_{LT} = 1.000 for exclusive left-turn lanes, and P_{RT} = 1.000 for exclusive right-turn lanes. Otherwise, they are equal to the proportions of turning volumes in the lane group. 															

EXHIBIT A10-3. LEFT-TURN TREATMENT WORKSHEET

LEFT-TURN TREATMENT WORKSHEET												
General Information												
Description _____												
Check #1. Left-Turn Lane Check												
Approach	EB	WB	NB	SB								
Number of left-turn lanes												
Protect left turn (Y or N)?												
If the number of left-turn lanes on any approach exceeds 1, then it is recommended that the left turns on that approach be protected. Those approaches with protected left turns need not be evaluated in subsequent checks.												
Check #2. Minimum Volume Check												
Approach	EB	WB	NB	SB								
Left-turn volume												
Protect left turn (Y or N)?												
If left-turn volume on any approach exceeds 240 veh/h, then it is recommended that the left turns on that approach be protected. Those approaches with protected left turns need not be evaluated in subsequent checks.												
Check #3. Minimum Cross-Product Check												
Approach	EB	WB	NB	SB								
Left-turn volume, V_L (veh/h)												
Opposing mainline volume, V_O (veh/h)												
Cross-product ($V_L * V_O$)												
Opposing through lanes												
Protected left turn (Y or N)?												
Minimum Cross-Product Values for Recommending Left-Turn Protection <table style="margin: auto; border: none;"> <tr> <td style="text-align: center;">Number of Through Lanes</td> <td style="text-align: center;">Minimum Cross-Product</td> </tr> <tr> <td style="text-align: center;">1</td> <td style="text-align: center;">50,000</td> </tr> <tr> <td style="text-align: center;">2</td> <td style="text-align: center;">90,000</td> </tr> <tr> <td style="text-align: center;">3</td> <td style="text-align: center;">110,000</td> </tr> </table>					Number of Through Lanes	Minimum Cross-Product	1	50,000	2	90,000	3	110,000
Number of Through Lanes	Minimum Cross-Product											
1	50,000											
2	90,000											
3	110,000											
If the cross-product on any approach exceeds the above values, then it is recommended that the left turns on that approach be protected. Those approaches with protected left turns need not be evaluated in subsequent checks.												
Check #4. Sneaker Check												
Approach	EB	WB	NB	SB								
Left-turn volume, V_L (veh/h)												
Sneaker capacity = $7200/C$												
Left-turn equivalence												
Protected left turn (Y or N)?												
If the left-turn equivalence factor is 3.5 or higher (computed in Exhibit A10-4, quick estimation lane volume worksheet) and the unadjusted left turn is greater than the sneaker capacity, then it is recommended that the left turns on that approach be protected.												
Notes												
1. If any approach is recommended for left-turn protection but the analyst wishes to analyze it as permitted, the planning application may give overly optimistic results. The analyst should instead use the more robust method described in Chapter 16, Signalized Intersections. 2. All volumes used in this worksheet are unadjusted hourly volumes.												

EXHIBIT A10-4. QUICK ESTIMATION LANE VOLUME WORKSHEET

QUICK ESTIMATION LANE VOLUME WORKSHEET			
General Information			
Description/Approach _____			
Right-Turn Movement			
	Exclusive RT Lane	Shared RT Lane	
RT volume, V_R (veh/h)			
Number of exclusive RT lanes, N_{RT}		use 1	
RT adjustment factor, ¹ f_{RT}			
RT volume per lane, V_{RT} (veh/h/ln) $V_{RT} = \frac{V_R}{(N_{RT} \times f_{RT})}$			
Left-Turn Movement			
LT volume, V_L (veh/h)			
Opposing mainline volume, V_O (veh/h)			
Number of exclusive LT lanes, N_{LT}			
LT adjustment factor, ² f_{LT}			
LT volume per lane, ³ V_{LT} (veh/h/ln) $V_{LT} = \frac{V_L}{(N_{LT} \times f_{LT})}$	Permitted LT <u>use 0</u>	Protected LT _____	Not Opposed LT _____
Through Movement			
	Permitted LT	Protected LT	Not Opposed LT
Through volume, V_T (veh/h)			
Parking adjustment factor, f_p			
Number of through lanes, N_{TH}			
Total approach volume, ⁴ V_{tot} (veh/h) $V_{tot} = \frac{[V_{RT}(\text{shared}) + V_T + V_{LT}(\text{not opp})]}{f_p}$			
Through Movement with Exclusive LT Lane			
Through volume per lane, V_{TH} (veh/h/ln) $V_{TH} = \frac{V_{tot}}{N_{TH}}$			
Critical lane volume, ⁵ V_{CL} (veh/h) $\text{Max}[V_{LT}(\text{exclusive}), V_{TH}]$			
Through Movement with Shared LT Lane			
Proportion of left turns, P_{LT}		Does not apply	Does not apply
LT equivalence, E_{LT} (Exhibit C16-3)		Does not apply	Does not apply
LT adjustment, f_{DL} (Exhibit A10-6)			use 1.0
Through volume per lane, V_{TH} (veh/h/ln) $V_{TH} = \frac{V_{tot}}{(N_{TH} \times f_{DL})}$			
Critical lane volume, ⁵ V_{CL} (veh/h) $\text{Max}[V_{RT}(\text{exclusive}), V_{TH}]$			
Notes			
1. For RT shared or single lanes, use 0.85. For RT double lanes, use 0.75. 2. For LT single lanes, use 0.95. For LT double lanes, use 0.92. For a one-way street or T-intersection, use 0.85 for one lane and 0.75 for two lanes. 3. For unopposed LT shared lanes, $N_{LT} = 1$. 4. For exclusive RT lanes, $V_{RT}(\text{shared}) = 0$. If not opposed, add V_{LT} to V_T and set $V_{LT}(\text{not opp}) = 0$. 5. V_{LT} is included only if LT is unopposed. $V_{RT}(\text{exclusive})$ is included only if RT is exclusive.			

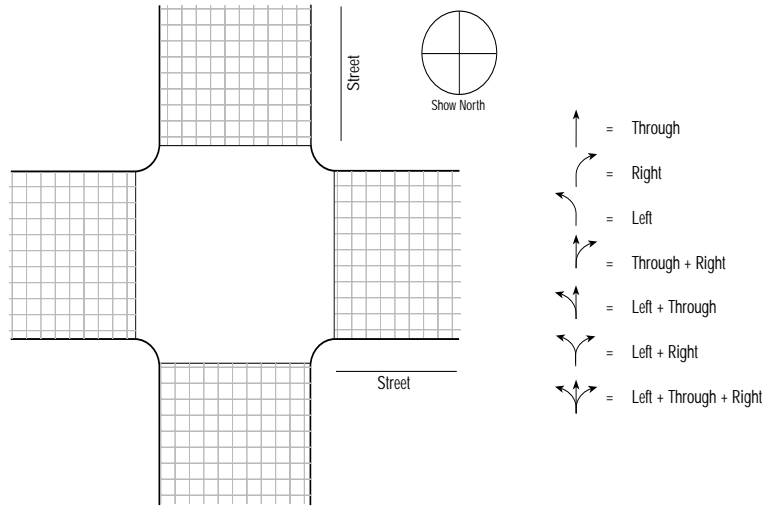
EXHIBIT A10-5. QUICK ESTIMATION CONTROL DELAY AND LOS WORKSHEET

QUICK ESTIMATION CONTROL DELAY AND LOS WORKSHEET				
General Information				
Description _____				
East-West Phasing Plan				
Selected plan (Exhibit A10-8) _____	Phase No. 1	Phase No. 2	Phase No. 3	
Movement codes				
Critical phase volume, CV (veh/h)				
Lost time/phase, t_L (s)				
North-South Phasing Plan				
Selected plan (Exhibit A10-8) _____	Phase No. 1	Phase No. 2	Phase No. 3	
Movement codes				
Critical phase volume, CV (veh/h)				
Lost time/phase, t_L (s)				
Intersection Status Computation				
Critical sum, CS (veh/h) $CS = \sum CV$				
Lost time/cycle, L (s) $L = \sum t_L$				
Reference sum flow rate RS (veh/h) ¹				
Cycle length, C (s) $C = \frac{L}{1 - \left[\frac{\min(CS, RS)}{RS} \right]}$ $C_{min} \leq C \leq C_{max}$				
Critical v/c ratio, X_{cm} $X_{cm} = \frac{CS}{RS \left(1 - \frac{L}{C}\right)}$				
Intersection status (Exhibit A10-9)				
Green Time Calculation				
East-West Phasing	Phase No. 1	Phase No. 2	Phase No. 3	
Green time, g (s) $g = \left[(C - L) \left(\frac{CV}{CS} \right) + t_L \right]$				
North-South Phasing	Phase No. 1	Phase No. 2	Phase No. 3	
Green time, g (s) $g = \left[(C - L) \left(\frac{CV}{CS} \right) + t_L \right]$				
Control Delay and LOS				
	EB	WB	NB	SB
Lane group				
Lane group adjusted volume from lane volume worksheet, V (veh/h)				
Green ratio, g/C				
Lane group saturation flow rate, s (veh/h) $s = RS \cdot \text{number of lanes in lane group}$				
v/c ratio, X $X = \frac{V/s}{g/C}$				
Lane group capacity, c (veh/h) $c = \frac{V}{X}$				
Progression adjustment factor, PF (Exhibit 16-12)				
Uniform delay, d_1 (s/veh) (Equation 16-11)				
Incremental delay, d_2 (s/veh) (Equation 16-12)				
Initial queue delay, d_3 (s/veh) (Appendix F, Ch. 16)				
Delay, $d = d_1(PF) + d_2 + d_3$ (s/veh)				
Delay by approach, d_A (s/veh) $\frac{\sum(d_i)V_i}{\sum V_i}$				
Approach flow rate, V_A (veh/h)				
Intersection delay, d_I (s/veh) $d_I = \frac{\sum(d_i)V_i}{\sum V_A}$	Intersection LOS (Exhibit 16-2)			
Notes				
1. $RS = 1710(PHF)(f_a)$, where f_a is area adjustment factor (0.90 for CBD and 1.0 for all others).				

LANE VOLUME COMPUTATIONS

The purpose of the lane volume worksheet (Exhibit A10-4) is to establish the individual lane flow rates (in veh/h/ln) on all approaches. This information is used on the control delay and LOS worksheet to synthesize the signal timing plan. The lane volume worksheet contains additional items such as left-turn treatment alternatives, parking adjustments, left-turn equivalence, and adjustment factors for shared lanes with permitted left turns. The directional designations refer to the movements as they approach the intersection.

Each of the three left-turn treatment alternatives identified must be processed differently in computing the lane volumes. Therefore, the lane volume worksheet contains three columns, each representing one of the alternatives. Only one of the three columns should be used for each approach. The following instructions cover the procedure for completing all of the items on the lane volume worksheet.

Right-turn volumes (veh/h) (with the estimated right-turn-on-red volume having been removed from the total) from either a shared through and right-turn lane or from an exclusive turn lane should be entered. The right-turn adjustment factor is 0.85 for a single lane or a shared lane and 0.75 for two lanes. The total right-turn volume should be divided by the product of the number of exclusive right-turn lanes and the right-turn adjustment factor.

The next worksheet computation involves the left-turn volume. In the case of protected-plus-permitted phasing with an exclusive left-turn lane, two vehicles per cycle should be removed from the left-turn volume to account for the effect of sneakers. If the cycle length has not been established, the maximum allowable cycle length should be used. To prevent unreasonably short protected left-turn phases, this volume adjustment step should not reduce the left-turn volume to a value below four vehicles per cycle. The opposing mainline volume is the total approach volume minus the left-turn volume from exclusive lanes or from a single lane (veh/h). The number of exclusive left-turn lanes is the number of lanes exclusively designated to accommodate the left-turn volumes. The left-turn adjustment factor applies only to protected left turns from exclusive left-turn lanes or to left turns that are not opposed. This factor is given as 0.95 for single lanes and 0.92 for double lanes. If the left-turn movement is not opposed because of a one-way street or T-intersection, pedestrian interference must be considered. The corresponding value of 0.85 for one lane and 0.75 for two lanes is used. The total left-turn volume is divided by the product of the number of exclusive left-turn lanes and the left-turn adjustment factor. The left-turn volume is entered directly if there is no exclusive left-turn lane. The result is expressed in units of veh/h/ln. Zero should always be entered if the left turns are permitted.

Total through volume for the approach, excluding left and right turns, is placed in the appropriate row to correspond to the applicable treatment for left turns (permitted, protected, or not opposed). The parking adjustment factor and the number of through lanes are noted. Exclusive turn lanes should be excluded. For an unopposed shared lane, the total approach volume is the sum of the shared-lane right-turn volume, the through volume, and the left-turn volume. Through-lane volume is then computed by dividing total approach volume by the number of through lanes. Critical lane volume is normally the same as through-lane volume, unless the right turn has an exclusive lane or the left turn is not opposed and either of these movements is more critical than the through movement. If both conditions apply, the critical lane volume will be the largest of the left-lane volume, exclusive right-lane volume, and through-lane volume.

The computation of critical lane volume in the case of shared left-turn lanes is more complicated and requires a more detailed computational procedure. The total approach volume is computed in nearly the same manner as for exclusive left-turn lanes. The proportion of left turns in a lane group is self-explanatory. Left-turn equivalence is one of the factors needed to compute the applicable formulas in Appendix C of Chapter 16 for shared-lane permitted left turns. It is not used at all when the left turn is protected. The

Left-turn flow rate is adjusted for left-turn sneakers

left-turn adjustment factor for through traffic, f_{DL} , is computed according to Exhibit A10-6. This reduction factor is applied to the through volumes to account for the effect of left-turning vehicles waiting for a gap in the opposing traffic to make the turn. Note that for lanes that are not opposed, the factor is 1.0 because these vehicles will have gaps through which to turn.

EXHIBIT A10-6. SHARED-LANE, LEFT-TURN ADJUSTMENT COMPUTATION FOR QUICK ESTIMATION

Permitted Left Turn	
Lane groups with two or more lanes:	Subject to a minimum value that applies at very low left-turning volumes when some cycles will have no left-turn arrivals:
$f_{DL} = \frac{(N_{TH} - 1) + e^{\left(\frac{-N_{TH}V_L E_{L1}}{600}\right)}}{N_{TH}}$	$f_{DL(min)} = \frac{(N_{TH} - 1) + e^{\left(\frac{-V_L C_{max}}{3600}\right)}}{N_{TH}}$
Lane groups with only one lane for all movements:	
$f_{DL} = e^{\left[-0.02(E_{L1} + 10P_{LT})\frac{V_L C_{max}}{3600}\right]}$	
Protected-Plus-Permitted Left Turn (one direction only)	
If $V_o < 1220$	If $V_o \geq 1220$
$f_{DL} = \frac{1}{1 + \left(\frac{P_{LT}(235 + 0.435V_o)}{1400 - V_o}\right)}$	$f_{DL} = \frac{1}{1 + 4.525P_{LT}}$

The through-lane volume is then computed. Note that the number of lanes is reduced by the shared left-turn adjustment factor to account for the effect of the left-turning vehicles.

In the exclusive left-turn lane case, the critical lane volume is the maximum of either the through-lane volume or the right-turn volume from an exclusive right-turn lane. If one or more left turns have been designated as permitted (i.e., no protected phase has been assigned), the need for a protected phase should be reexamined at this point.

As indicated in Chapter 16, Appendix C, values for the left-turn equivalency above 3.5 imply that left-turn capacity is derived substantially from sneakers. Therefore, if the left-turn equivalency is greater than 3.5 and the left-turn volume is greater than two vehicles per cycle, it is likely that the subject left turn will not have adequate capacity without a protected phase.

SIGNAL TIMING ESTIMATION

The purpose of this step is to estimate a feasible signal timing plan for the intersection. The signal timing plan is required to estimate delay. Note that the signal timing plan estimated using the method described below is not necessarily the optimal timing plan. The timing plan is estimated in five substeps: phasing plan development, computation of critical sum, estimation of total lost time, cycle length estimation, and effective green time estimation.

Phasing Plan Development

The phase plan is selected from six alternatives presented in Exhibit A10-7. If the phasing plan is not known, the selection is made on the basis of the user-specified left-turn protection and the dominant left-turn movements identified from the left-turn treatment worksheet (Exhibit A10-3).

EXHIBIT A10-7. PHASE PLANS FOR QUICK ESTIMATION METHOD

Phase Plan	Eastbound	Westbound	Northbound	Southbound
1	Permitted	Permitted	Permitted	Permitted
	Permitted	Not Opposed	Permitted	Not Opposed
	Not Opposed	Permitted	Not Opposed	Permitted
2a	Permitted	Protected	Permitted	Protected
2b	Protected	Permitted	Protected	Permitted
3a	Protected ^a	Protected	Protected ^a	Protected
3b	Protected	Protected ^a	Protected	Protected ^a
4	Not Opposed	Not Opposed	Not Opposed	Not Opposed

Note:

- a. Dominant left turn for each opposing movement.

Computation of Critical Sum

When the phase plan has been selected, the movement codes, critical phase volume (CV), and lost time per phase are entered on the quick estimation control delay and LOS worksheet. The critical phase volume is the volume for the movement that requires the most green time during the phase. If two opposing lefts are moving during the same phase, the critical phase volume is the higher-volume left turn. The appropriate choice for critical lane volume is given in the phase plan summary shown in Exhibit A10-8, along with a code that identifies the movements that are allowed to proceed on each phase. For example, NBSBTH indicates that the northbound and southbound through movements have the right-of-way on the specified phase. Exhibit A10-8 also indicates the lost time to be assigned to each phase.

The movement codes and CVs must be determined for each phase from Exhibit A10-8 and entered on the quick estimation control delay and LOS worksheet. When all phases have been completed, the critical sum (CS) of the CVs is entered on the next line.

EXHIBIT A10-8 PHASE PLAN SUMMARY FOR QUICK ESTIMATION METHOD

Phase Plan	Phase No.	Lost Time (s)	East-West		North-South	
			Movement Code	Critical Volume	Movement Code	Critical Volume
1	1	4	EBWBTH	Max(EBTH, EBLT, WBTH, WBLT)	NBSBTH	Max(NBTH, NBLT, SBTH, SBLT)
2a	1	4	WBTHLT	WBLT	SBTHLT	SBLT
	2	4	EBWBTH	Max(WBTH-WBLT, EBTH)	NBSBTH	Max(SBTH-SBLT, NBTH)
2b	1	4	EBTHLT	EBLT	NBTHLT	NBLT
	2	4	EBWBTH	Max(EBTH-EBLT, WBTH)	NBSBTH	Max(NBTH-NBLT, SBTH)
3a	1	4	EBWBTLT	WBLT	NBSBLT	SBLT
	2	0	EBTHLT	EBLT-WBLT	NBTHLT	NBLT-SBLT
	3	4	EBWBTH	Max(WBTH, EBTH-(EBLT-WBLT))	NBSBTH	Max(SBTH, NBTH-(NBLT-SBLT))
3b	1	4	EBWBTLT	EBLT	NBSBLT	NBLT
	2	0	WBTHLT	WBLT-EBLT	SBTHLT	SBLT-NBLT
	3	4	EBWBTH	Max(EBTH, WBTH-(WBLT-EBLT))	NBSBTH	Max(NBTH, SBTH-(SBLT-NBLT))
4	1	4	EBTHLT	Max(EBTH, EBLT)	NBTHLT	Max(NBTH, NBLT)
	2	4	WBTHLT	Max(WBTH, WBLT)	SBTHLT	Max(SBTH, SBLT)

Estimation of Total Lost Time

The total lost time per cycle is computed on the quick estimation control delay and LOS worksheet. For planning purposes, a lost time value of 4 s per phase is assumed, in which any movement is both started and stopped. For example, if Phase Plan 1 were selected for both streets, then there would be a total of 8 s of lost time per cycle (4 s for each street). When the lost times have been determined for each phase, the total lost time per cycle (L) may be computed and entered on the quick estimation control delay and LOS worksheet.

Cycle Length Estimation

A cycle length that will accommodate the observed flow rates with a specified degree of saturation is computed by Equation A10-1. If the cycle length is known, that value should be used.

$$C = \frac{L}{1 - \left[\frac{\min(CS, RS)}{RS} \right]} \quad (A10-1)$$

where

- C = cycle length (s),
- L = total lost time (s),
- CS = critical sum (veh/h),
- RS = reference sum flow rate ($1,710 * PHF * f_a$) (veh/h),
- PHF = peak-hour factor, and
- f_a = area type adjustment factor (0.90 if CBD, 1.00 otherwise).

RS is the reference sum of phase flow rates representing the theoretical maximum value that the intersection could accommodate at an infinite cycle length. The recommended value for the reference sum, RS , is computed as an adjusted saturation flow rate. The value of 1,710 is about 90 percent of the base saturation flow rate of 1,900 pc/h/ln. The objective is to produce a 90 percent v/c ratio for all critical movements.

The CS volume is the sum of the critical phase volume for each street. The critical phase volumes are identified in the quick estimation control delay and LOS worksheet on the basis of the phasing plan selected from Exhibit A10-8.

The cycle length determined from this equation should be checked against reasonable minimum and maximum values. The cycle length must not exceed a maximum allowable value set by the local jurisdiction (such as 150 s), and it must be long enough to serve pedestrians (use 60 s if local data are not available).

Green Time Estimation

The total cycle time is divided among the conflicting phases in the phase plan on the basis of the principle of equalizing the degree of saturation for the critical movements. The lost time per cycle must be subtracted from the total cycle time to determine the effective green time per cycle, which must then be apportioned among all phases. This is based on the proportion of the critical phase flow rate sum for each phase determined in a previous step.

The effective green time (including change and clearance time) for each phase can be computed using Equation A10-2.

$$g = \left[(C - L) \left(\frac{CV}{CS} \right) \right] \quad (A10-2)$$

where

- g = effective green time (s),
- CV = critical phase flow rate (veh/h),
- CS = critical sum (veh/h),

- C = cycle length (s), and
- L = total lost time per cycle (s).

The analyst should note that this method of estimating green time will not necessarily minimize the overall delay at the intersection.

COMPUTATION OF CRITICAL v/c RATIO

The critical v/c ratio, X_{cm} , is an approximate indicator of the overall sufficiency of the intersection geometrics. The computational method involves the summation of conflicting critical lane flow rates for the intersection. The computations depend on traffic signal phasing, which in turn depends on the type of protection assigned to each left-turn movement. The quick estimation critical v/c ratio, X_{cm} , is the ratio of the critical sum, CS, to the sum of the critical lane flow rates that can accommodate demand at the given cycle length and is computed by Equation A10-3.

$$X_{cm} = \frac{CS}{RS \left(1 - \frac{L}{C}\right)} \tag{A10-3}$$

where

- X_{cm} = critical v/c ratio,
- CS = critical sum (veh/h),
- L = total lost time (s),
- C = cycle length (s), and
- RS = reference sum (veh/h/ln).

The critical sum is the sum of the critical phase volumes per lane at the intersection. A phasing plan identifying the protected left turns at the intersection must be known or developed for the intersection to compute the critical sum. The computation of the critical phase volumes per lane and the critical sum and the development of an estimated phasing plan are described in the section on the estimation of a signal timing plan.

The reference sum was derived on the basis of minimum acceptable operational conditions and typical traffic flow conditions. More refined saturation flow rates are computed by using the methodology of Chapter 16.

Although it is not appropriate to assign an LOS to the intersection on the basis of X_{cm} , it is appropriate to evaluate the operational status of the intersection for quick estimation purposes. Exhibit A10-9 expresses the intersection status as over, at, near, or under capacity.

EXHIBIT A10-9. INTERSECTION STATUS CRITERIA FOR SIGNALIZED INTERSECTION PLANNING ANALYSIS

Critical v/c Ratio (X_{cm})	Relationship to Capacity
$X_{cm} \leq 0.85$	Under capacity
> 0.85 - 0.95	Near capacity
> 0.95 - 1.00	At capacity
$X_{cm} > 1.00$	Over capacity

COMPUTATION OF DELAY

First, the lane groups are established for all approaches. Lane grouping is explained in Chapter 16. Exhibit 16-5 shows different types of lane groups for analysis. Lane group volumes are computed by summing the adjusted volumes obtained from the quick estimation lane volume worksheet (Exhibit A10-4) for each lane group on each approach. The green ratio (g/C) is computed using green time and cycle length values from the top portion of the quick estimation control delay and LOS worksheet. The lane group

saturation flow rate is equal to the reference sum times the number of lanes in the lane group. The lane group v/c ratio is calculated using adjusted lane group volumes and lane group saturation flow rates computed previously and g/C ratios. Lane group capacity is calculated using lane group adjusted volumes and lane group v/c ratios. The progression adjustment factor for uniform delay calculation, PF, is selected from Exhibit 16-12. For quick estimation purposes, the analyst may assume Arrival Type 3 for an uncoordinated signal and Arrival Type 4 for coordinated operation (for coordinated lane groups only).

The final step is to compute the various components of control delay using Equations 16-10 through 16-15 in Chapter 16, "Signalized Intersections." This chapter provides guidance on selecting default values for parameters used in the delay equations. Delay by approach, approach volumes, and intersection delay require the delay to be averaged across actual volumes on the quick estimation method input worksheet, not adjusted volumes used to compute capacity. The values V_A and V used in these equations should be computed using unadjusted volumes that are inputs on the quick estimation method input worksheet.

Note that this procedure does not provide sufficient information for the computation of delay for permitted left turns from an exclusive turn lane. The analyst may ignore this delay in the computations or may use the more detailed capacity and LOS procedure provided in Chapter 16, "Signalized Intersections." In addition, the quick estimation method does not include the delay associated with the two sneakers per cycle, which has been subtracted from the left-turn volumes for permitted and protected/permitted left turns.

APPENDIX B. WORKSHEETS

QUICK ESTIMATION INPUT WORKSHEET

LEFT-TURN TREATMENT WORKSHEET

QUICK ESTIMATION LANE VOLUME WORKSHEET

QUICK ESTIMATION CONTROL DELAY AND LOS WORKSHEET

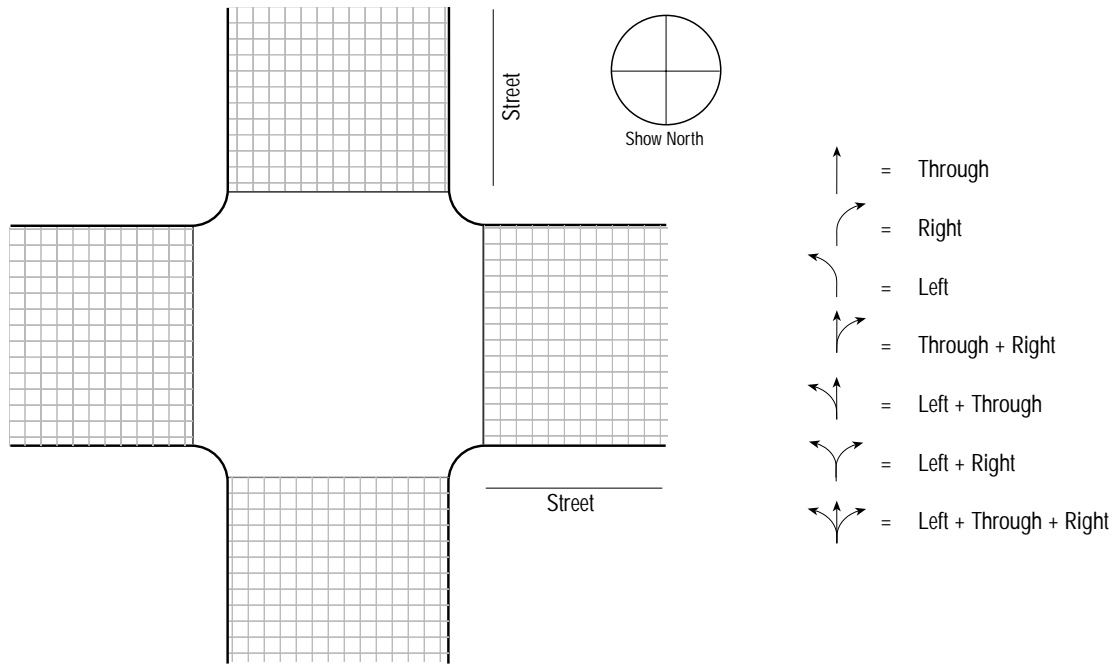
QUICK ESTIMATION INPUT WORKSHEET													
General Information						Site Information							
Analyst _____						Intersection _____							
Agency or Company _____						Area Type	<input type="checkbox"/> CBD						<input type="checkbox"/> Other
Date Performed _____						Jurisdiction _____							
Analysis Time Period _____						Analysis Year _____							
Intersection Geometry													
													
Volume and Signal Input													
	EB			WB			NB			SB			
	LT	TH	RT ¹	LT	TH	RT ¹	LT	TH	RT ¹	LT	TH	RT ¹	
Volume, V (veh/h)													
Proportion of LT or RT (P_{LT} or P_{RT}) ²		-			-			-			-		
Parking (Yes/No)													
Left-turn treatment (permitted, protected, not opposed) (if known)													
Peak-hour factor, PHF _____													
Cycle length	Minimum, C_{min} _____ s						Maximum, C_{max} _____ s			or			Given, C _____ s
Lost time/phase	_____ s												
Notes													
1. RT volumes, as shown, exclude RTOR.													
2. $P_{LT} = 1.000$ for exclusive left-turn lanes, and $P_{RT} = 1.000$ for exclusive right-turn lanes. Otherwise, they are equal to the proportions of turning volumes in the lane group.													

LEFT-TURN TREATMENT WORKSHEET												
General Information												
Description _____												
Check #1. Left-Turn Lane Check												
Approach	EB	WB	NB	SB								
Number of left-turn lanes												
Protect left turn (Y or N)?												
If the number of left-turn lanes on any approach exceeds 1, then it is recommended that the left turns on that approach be protected. Those approaches with protected left turns need not be evaluated in subsequent checks.												
Check #2. Minimum Volume Check												
Approach	EB	WB	NB	SB								
Left-turn volume												
Protect left turn (Y or N)?												
If left-turn volume on any approach exceeds 240 veh/h, then it is recommended that the left turns on that approach be protected. Those approaches with protected left turns need not be evaluated in subsequent checks.												
Check #3. Minimum Cross-Product Check												
Approach	EB	WB	NB	SB								
Left-turn volume, V_L (veh/h)												
Opposing mainline volume, V_o (veh/h)												
Cross-product ($V_L * V_o$)												
Opposing through lanes												
Protected left turn (Y or N)?												
Minimum Cross-Product Values for Recommending Left-Turn Protection <table style="margin: auto; border: none;"> <tr> <td style="padding: 5px;">Number of Through Lanes</td> <td style="padding: 5px;">Minimum Cross-Product</td> </tr> <tr> <td style="padding: 5px; text-align: center;">1</td> <td style="padding: 5px; text-align: center;">50,000</td> </tr> <tr> <td style="padding: 5px; text-align: center;">2</td> <td style="padding: 5px; text-align: center;">90,000</td> </tr> <tr> <td style="padding: 5px; text-align: center;">3</td> <td style="padding: 5px; text-align: center;">110,000</td> </tr> </table>					Number of Through Lanes	Minimum Cross-Product	1	50,000	2	90,000	3	110,000
Number of Through Lanes	Minimum Cross-Product											
1	50,000											
2	90,000											
3	110,000											
If the cross-product on any approach exceeds the above values, then it is recommended that the left turns on that approach be protected. Those approaches with protected left turns need not be evaluated in subsequent checks.												
Check #4. Sneaker Check												
Approach	EB	WB	NB	SB								
Left-turn volume, V_L (veh/h)												
Sneaker capacity = $7200/C$												
Left-turn equivalence, E_{L1} (Exhibit C16-3)												
Protected left turn (Y or N)?												
If the left-turn equivalence factor is 3.5 or higher (computed in Exhibit A10-4, quick estimation lane volume worksheet) and the unadjusted left turn is greater than the sneaker capacity, then it is recommended that the left turns on that approach be protected.												
Notes												
<ol style="list-style-type: none"> 1. If any approach is recommended for left-turn protection but the analyst wishes to analyze it as permitted, the planning application may give overly optimistic results. The analyst should instead use the more robust method described in Chapter 16, Signalized Intersections. 2. All volumes used in this worksheet are unadjusted hourly volumes. 												

QUICK ESTIMATION LANE VOLUME WORKSHEET			
General Information			
Description/Approach _____			
Right-Turn Movement			
	Exclusive RT Lane	Shared RT Lane	
RT volume, V_R (veh/h)			
Number of exclusive RT lanes, N_{RT}		use 1	
RT adjustment factor, ¹ f_{RT}			
RT volume per lane, V_{RT} (veh/h/ln) $V_{RT} = \frac{V_R}{(N_{RT} \times f_{RT})}$			
Left-Turn Movement			
LT volume, V_L (veh/h)			
Opposing mainline volume, V_O (veh/h)			
Number of exclusive LT lanes, N_{LT}			
LT adjustment factor, ² f_{LT}			
LT volume per lane, ³ V_{LT} (veh/h/ln) $V_{LT} = \frac{V_L}{(N_{LT} \times f_{LT})}$	Permitted LT <u>use 0</u>	Protected LT _____	Not Opposed LT _____
Through Movement			
	Permitted LT	Protected LT	Not Opposed LT
Through volume, V_T (veh/h)			
Parking adjustment factor, f_p			
Number of through lanes, N_{TH}			
Total approach volume, ⁴ V_{tot} (veh/h) $V_{tot} = \frac{[V_{RT}(\text{shared}) + V_T + V_{LT}(\text{not opp})]}{f_p}$			
Through Movement with Exclusive LT Lane			
Through volume per lane, V_{TH} (veh/h/ln) $V_{TH} = \frac{V_{tot}}{N_{TH}}$			
Critical lane volume, ⁵ V_{CL} (veh/h) $\text{Max}[V_{LT}, V_{RT}(\text{exclusive}), V_{TH}]$			
Through Movement with Shared LT Lane			
Proportion of left turns, P_{LT}		Does not apply	Does not apply
LT equivalence, E_{L1} (Exhibit C16-3)		Does not apply	Does not apply
Planning LT adjustment, f_{DL} (Exhibit A10-6)			use 1.0
Through volume per lane, V_{TH} (veh/h/ln) $V_{TH} = \frac{V_{tot}}{(N_{TH} \times f_{DL})}$			
Critical lane volume, ⁵ V_{CL} (veh/h) $\text{Max}[V_{RT}(\text{exclusive}), V_{TH}]$			
Notes			
1. For RT shared or single lanes, use 0.85. For RT double lanes, use 0.75. 2. For LT single lanes, use 0.95. For LT double lanes, use 0.92. For a one-way street or T-intersection, use 0.85 for one lane and 0.75 for two lanes. 3. For unopposed LT shared lanes, $N_{LT} = 1$. 4. For exclusive RT lanes, $V_{RT}(\text{shared}) = 0$. If not opposed, add V_{LT} to V_T and set $V_{LT}(\text{not opp}) = 0$. 5. V_{LT} is included only if LT is unopposed. $V_{RT}(\text{exclusive})$ is included only if RT is exclusive.			

QUICK ESTIMATION CONTROL DELAY AND LOS WORKSHEET				
General Information				
Description _____				
East-West Phasing Plan				
Selected plan (Exhibit A10-8) _____	Phase No. 1	Phase No. 2	Phase No. 3	
Movement codes				
Critical phase volume, CV (veh/h)				
Lost time/phase, t_L (s)				
North-South Phasing Plan				
Selected plan (Exhibit A10-8) _____	Phase No. 1	Phase No. 2	Phase No. 3	
Movement codes				
Critical phase volume, CV (veh/h)				
Lost time/phase, t_L (s)				
Intersection Status Computation				
Critical sum, CS (veh/h) $CS = \sum CV$				
Lost time/cycle, L (s) $L = \sum t_L$				
Reference sum flow rate RS (veh/h) ¹				
Cycle length, C (s) $C_{min} \leq C \leq C_{max}$	$C = \frac{L}{1 - \left[\frac{\min(CS, RS)}{RS} \right]}$			
Critical v/c ratio, X_{cm}	$X_{cm} = \frac{CS}{RS \left(1 - \frac{L}{C} \right)}$			
Intersection status (Exhibit A10-9)				
Green Time Calculation				
East-West Phasing	Phase No. 1	Phase No. 2	Phase No. 3	
Green time, g (s) $g = \left[(C - L) \left(\frac{CV}{CS} \right) + t_L \right]$				
North-South Phasing	Phase No. 1	Phase No. 2	Phase No. 3	
Green time, g (s) $g = \left[(C - L) \left(\frac{CV}{CS} \right) + t_L \right]$				
Control Delay and LOS				
	EB	WB	NB	SB
Lane group				
Lane group adjusted volume from lane volume worksheet, V (veh/h)				
Green ratio, g/C				
Lane group saturation flow rate, s (veh/h) $s = RS \cdot \text{number of lanes in lane group}$				
v/c ratio, X $X = \frac{V/s}{g/C}$				
Lane group capacity, c (veh/h) $c = \frac{V}{X}$				
Progression adjustment factor, PF (Exhibit 16-12)				
Uniform delay, d_1 (s/veh) (Equation 16-11)				
Incremental delay, d_2 (s/veh) (Equation 16-12)				
Initial queue delay, d_3 (s/veh) (Appendix F, Ch. 16)				
Delay, $d = d_1(PF) + d_2 + d_3$ (s/veh)				
Delay by approach, d_A (s/veh) $\frac{\sum(d)(V)}{\sum V}$				
Approach flow rate, V_A (veh/h)				
Intersection delay, d_1 (s/veh) $d_1 = \frac{\sum(d_A)(V_A)}{\sum V_A}$	Intersection LOS (Exhibit 16-2)			
Notes				
1. $RS = 1710(PHF)(f_a)$, where f_a is area adjustment factor (0.90 for CBD and 1.0 for all others).				

CHAPTER 11

PEDESTRIAN AND BICYCLE CONCEPTS

CONTENTS

I. INTRODUCTION	11-1
II. PEDESTRIANS	11-1
Pedestrian Capacity Terminology	11-1
Principles of Pedestrian Flow	11-1
Pedestrian Speed-Density Relationships	11-2
Flow-Density Relationships	11-2
Speed-Flow Relationships	11-3
Speed-Space Relationships	11-4
Pedestrian Space Requirements	11-4
Pedestrian Walking Speed	11-4
Pedestrian Start-Up Time and Capacity	11-4
Effective Walkway Width	11-6
Pedestrian Type and Trip Purpose	11-6
Performance Measures	11-7
Pedestrian Platoons	11-8
Required Input Data and Estimated Values	11-11
Length of Sidewalk	11-12
Effective Width	11-12
Street Corner Radius	11-12
Crosswalk Length	11-13
Analysis Period	11-13
Number of Pedestrians in a Platoon	11-13
Pedestrian Walking Speed	11-13
Pedestrian Start-Up Time	11-13
Service Volume Table	11-14
III. BICYCLES	11-14
Bicycle Lane	11-14
Bicycle Capacity Terminology	11-14
Performance Measures	11-14
Uninterrupted Bicycle Flow	11-16
Interrupted Bicycle Flow	11-17
Required Data and Estimated Values	11-17
Length	11-18
Bicycle Path Width	11-18
Analysis Period	11-18
Peak-Hour Factor	11-18
Bicycle Speed	11-18
Service Volume Tables	11-18
IV. REFERENCES	11-20

EXHIBITS

Exhibit 11-1. Relationships Between Pedestrian Speed and Density	11-2
Exhibit 11-2. Relationships Between Pedestrian Flow and Space	11-3
Exhibit 11-3. Relationships Between Pedestrian Speed and Flow	11-3
Exhibit 11-4. Relationships Between Pedestrian Speed and Space	11-4

Exhibit 11-5.	Pedestrian Body Ellipse for Standing Areas and Pedestrian Walking Space Requirement.....	11-5
Exhibit 11-6.	Typical Free-Flow Walking Speed Distributions	11-6
Exhibit 11-7.	Cross-Flow Traffic: Probability of Conflict.....	11-7
Exhibit 11-8.	Pedestrian Walkway LOS.....	11-9
Exhibit 11-9.	Queuing Area LOS	11-10
Exhibit 11-10.	Minute-by-Minute Variations in Pedestrian Flow	11-10
Exhibit 11-11.	Relationship Between Platoon Flow and Average Flow	11-11
Exhibit 11-12.	Required Input Data and Default Values for Pedestrians.....	11-12
Exhibit 11-13.	Default Sidewalk Widths.....	11-12
Exhibit 11-14.	Default Street Corner Radius	11-12
Exhibit 11-15.	Default Start-Up Time.....	11-13
Exhibit 11-16.	Examples of Service Volume for a Pedestrian Sidewalk	11-14
Exhibit 11-17.	LOS Criteria for Uninterrupted Bicycle Facilities	11-15
Exhibit 11-18.	Bicycle LOS and Speed-Flow Relationships for Uninterrupted Flow	11-16
Exhibit 11-19.	Required Input Data and Default Values for Bicycle Paths	11-17
Exhibit 11-20.	Default Bicycle Path Widths	11-18
Exhibit 11-21.	Frequency of Events on Shared Two-Lane (2.4 m) Bicycle Facility.....	11-19
Exhibit 11-22.	Frequency of Events on Shared Three-Lane (3.0 m) Bicycle Facility.....	11-20

I. INTRODUCTION

This chapter introduces capacity, level of service (LOS), and quality-of-flow concepts for pedestrian and bicycle facilities. This chapter can be used in conjunction with Chapter 18, which provides a methodology for assessing pedestrian facilities, and Chapter 19, which provides a methodology for assessing bicycle facilities. These chapters deal with pedestrian and bicycle facilities, and not with the impacts of pedestrians and bicycles on motor vehicles.

II. PEDESTRIANS

PEDESTRIAN CAPACITY TERMINOLOGY

The following are important terms used for pedestrian facility capacity and LOS analysis:

- Pedestrian speed is the average pedestrian walking speed, generally expressed in units of meters per second.
- Pedestrian flow rate is the number of pedestrians passing a point per unit of time, expressed as pedestrians per 15 min or pedestrians per minute. Point refers to a line of sight across the width of a walkway perpendicular to the pedestrian path.
- Pedestrian flow per unit of width is the average flow of pedestrians per unit of effective walkway width, expressed as pedestrians per minute per meter (p/min/m).
- Pedestrian density is the average number of pedestrians per unit of area within a walkway or queuing area, expressed as pedestrians per square meter (p/m²).
- Pedestrian space is the average area provided for each pedestrian in a walkway or queuing area, expressed in terms of square meters per pedestrian. This is the inverse of density, and is often a more practical unit for analyzing pedestrian facilities.
- Platoon refers to a number of pedestrians walking together in a group, usually involuntarily, as a result of signal control and other factors.

PRINCIPLES OF PEDESTRIAN FLOW

The qualitative measures of pedestrian flow are similar to those used for vehicular flow, such as the freedom to choose desired speeds and to bypass others. Other measures related specifically to pedestrian flow include the ability to cross a pedestrian traffic stream, to walk in the reverse direction of a major pedestrian flow, to maneuver generally without conflicts and changes in walking speed, and the delay experienced by pedestrians at signalized and unsignalized intersections.

Additional environmental factors that contribute to the walking experience and therefore to perceived level of service are the comfort, convenience, safety, security, and economy of the walkway system. Comfort factors include weather protection, climate control, arcades, transit shelters, and other pedestrian amenities. Convenience factors include walking distances, pathway directness, grades, sidewalk ramps, directional signing, directory maps, and other features making pedestrian travel easy and uncomplicated.

Safety is provided by the separation of pedestrians from vehicular traffic on the same horizontal plane, with malls and other vehicle-free areas, and vertically above and below with overpasses and underpasses. Traffic control devices can provide time separation between pedestrian and vehicular traffic. Security features include lighting, open lines of sight, and the degree and type of street activity.

Key terms defined

The economics of pedestrian facilities relate to the user costs incurred by travel delays and inconvenience, and to commercial values and retail development influenced by pedestrian accessibility.

These supplemental factors can affect pedestrian perceptions of the overall quality of the street environment. Although the automobile user has reasonable control over most of these factors, the pedestrian has virtually no control over them. This chapter emphasizes LOS analysis of pedestrian flow measures, such as speed, space, and delay. Environmental factors also can be considered as influences on pedestrian activity.

Pedestrian Speed-Density Relationships

The fundamental relationship between speed, density, and volume for pedestrian flow is analogous to vehicular flow. As volume and density increase, pedestrian speed declines. As density increases and pedestrian space decreases, the degree of mobility afforded to the individual pedestrian declines, as does the average speed of the pedestrian stream.

Exhibit 11-1 shows the relationship between speed and density for three pedestrian classes as reported in the literature (1).

EXHIBIT 11-1. RELATIONSHIPS BETWEEN PEDESTRIAN SPEED AND DENSITY

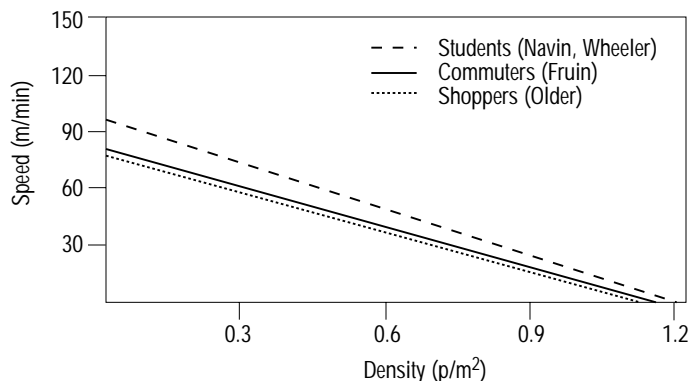

Flow-Density Relationships

The relationship among density, speed, and flow for pedestrians is similar to that for vehicular traffic streams, and is expressed in Equation 11-1.

$$v_{ped} = S_{ped} * D_{ped} \tag{11-1}$$

where

- v_{ped} = unit flow rate (p/min/m),
- S_{ped} = pedestrian speed (m/min), and
- D_{ped} = pedestrian density (p/m²).

The flow variable in this expression is the unit width flow, defined earlier. An alternative, more useful expression uses the reciprocal of density, or space, as follows:

$$v_{ped} = \frac{S_{ped}}{M} \tag{11-2}$$

where

$$M = \text{pedestrian space (m}^2\text{/p)}.$$

The basic relationship between flow and space, recorded by several researchers, is illustrated in Exhibit 11-2 (1).

Similarities of pedestrian movement to vehicular traffic

EXHIBIT 11-2. RELATIONSHIPS BETWEEN PEDESTRIAN FLOW AND SPACE

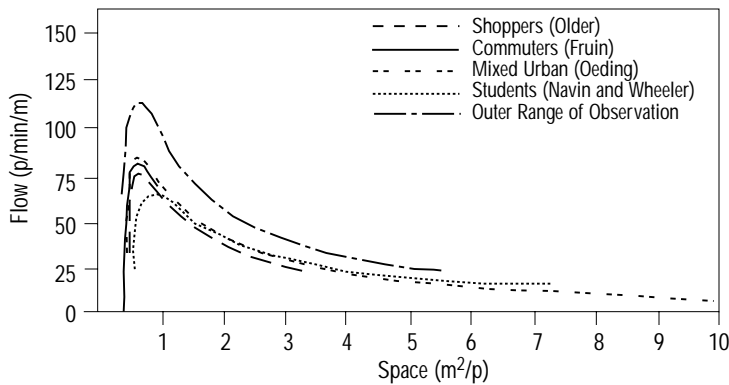

Source: Adapted from Pushkarev and Zupan (1).

The conditions at maximum flow represent the capacity of the walkway facility. From Exhibit 11-2, it is apparent that all observations of maximum unit flow fall within a narrow range of density, with the average space per pedestrian varying between 0.4 and 0.9 m²/p. Even the outer range of these observations indicates that maximum flow occurs at this density, although the actual flow in this study is considerably higher than in the others. As space is reduced to less than 0.4 m²/p, the flow rate declines precipitously. All movement effectively stops at the minimum space allocation of 0.2 to 0.3 m²/p.

These relationships show that pedestrian traffic can be evaluated qualitatively by using LOS concepts similar to vehicular traffic analysis. At flows near capacity, an average of 0.4 to 0.9 m²/p is required for each moving pedestrian. However, at this level of flow, the limited area available restricts pedestrian speed and freedom to maneuver.

Speed-Flow Relationships

Exhibit 11-3 illustrates the relationship between pedestrian speed and flow. These curves, similar to vehicle flow curves, show that when there are few pedestrians on a walkway (i.e., low flow levels), there is space available to choose higher walking speeds. As flow increases, speeds decline because of closer interactions among pedestrians. When a critical level of crowding occurs, movement becomes more difficult, and both flow and speed decline.

EXHIBIT 11-3. RELATIONSHIPS BETWEEN PEDESTRIAN SPEED AND FLOW

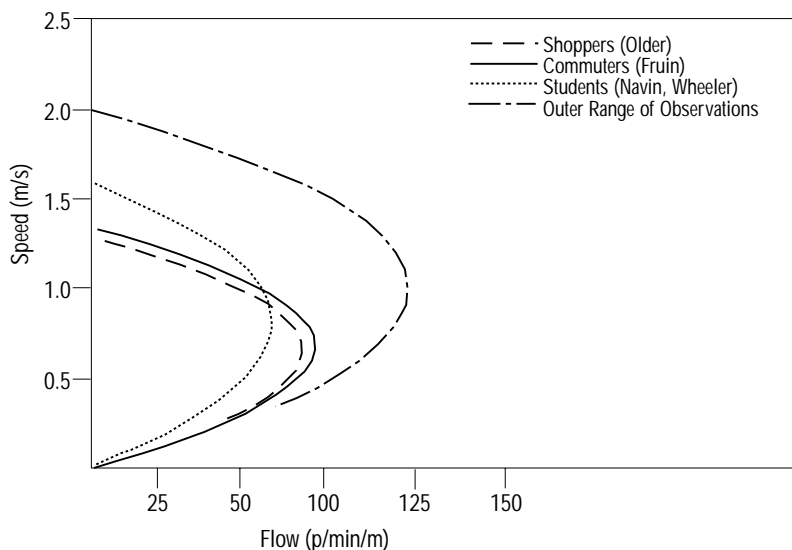

Source: Adapted from Pushkarev and Zupan (1).

Speed-Space Relationships

Exhibit 11-4 also confirms the relationships of walking speed and available space, and suggests some points of demarcation for developing LOS criteria. The outer range of observations shown in Exhibit 11-4 indicates that at an average space of less than 1.5 m²/p, even the slowest pedestrians cannot achieve their desired walking speeds. Faster pedestrians, who walk at speeds of up to 1.8 m/s, are not able to achieve that speed unless average space is 4.0 m²/p or more.

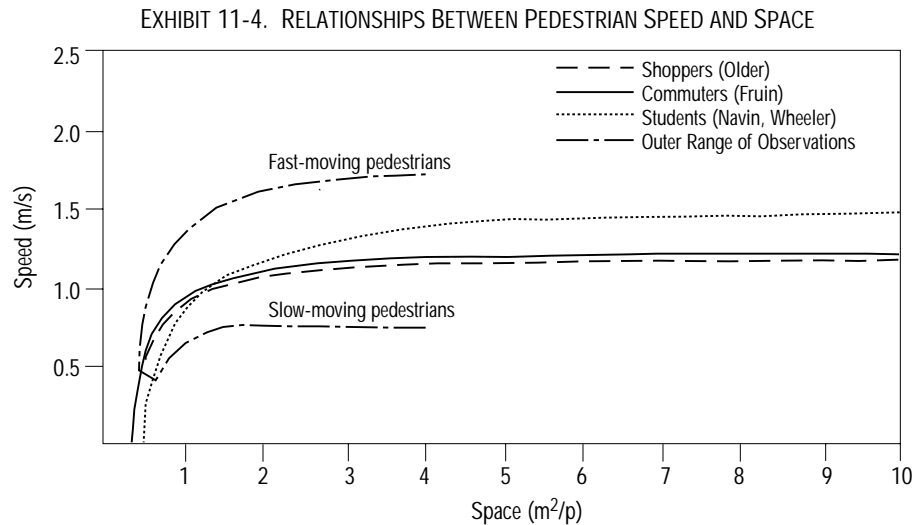

Source: Adapted from Pushkarev and Zupan (1).

PEDESTRIAN SPACE REQUIREMENTS

Pedestrian facility designers use body depth and shoulder breadth for minimum space standards, at least implicitly. A simplified body ellipse of 0.50 m x 0.60 m, with total area of 0.30 m² is used as the basic space for a single pedestrian, as shown in Exhibit 11-5a. This represents the practical minimum for standing pedestrians. In evaluating a pedestrian facility, an area of 0.75 m² is used as the buffer zone for each pedestrian.

A walking pedestrian requires a certain amount of forward space. This forward space is a critical dimension, since it determines the speed of the trip and the number of pedestrians that are able to pass a point in a given time period. The forward space in Exhibit 11-5b is categorized into a pacing zone and a sensory zone (2).

PEDESTRIAN WALKING SPEED

Pedestrian walking speed is highly dependent on the proportion of elderly pedestrians (65 years old or more) in the walking population. If 0 to 20 percent of pedestrians are elderly, the average walking speed is 1.2 m/s on walkways (3). If elderly people constitute more than 20 percent of the total pedestrians, the average walking speed decreases to 1.0 m/s. In addition, a walkway upgrade of 10 percent or more reduces walking speed by 0.1 m/s. On sidewalks, the free-flow speed of pedestrians is approximately 1.5 m/s (3). There are several other conditions that could reduce average pedestrian speed, such as a high percentage of slow-walking children in the pedestrian flow.

PEDESTRIAN START-UP TIME AND CAPACITY

A pedestrian start-up time of 3 s is a reasonable midrange value for evaluating crosswalks at traffic signals. A capacity of 75 p/min/m or 4,500 p/h/m is a reasonable value for a pedestrian facility if local data are not available. At capacity, a walking speed of 0.8 m/s is considered a reasonable value. Exhibit 11-6 shows a typical distribution of free-flow walking speeds in terminals.

Factors affecting walking speed

EXHIBIT 11-5. PEDESTRIAN BODY ELLIPSE FOR STANDING AREAS AND PEDESTRIAN WALKING SPACE REQUIREMENT

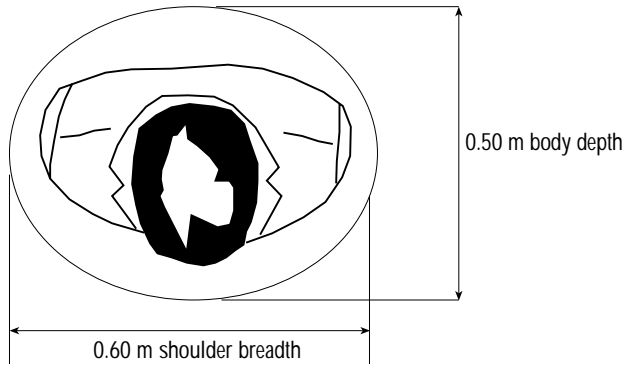

(a) Pedestrian body ellipse

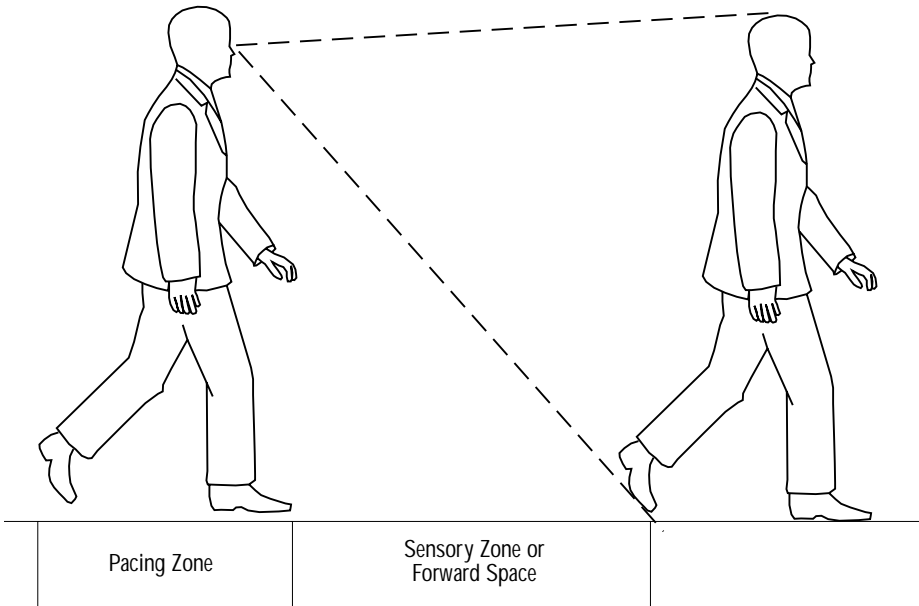

(b) Pedestrian walking space requirement

Source: Adapted from Fruin (2).

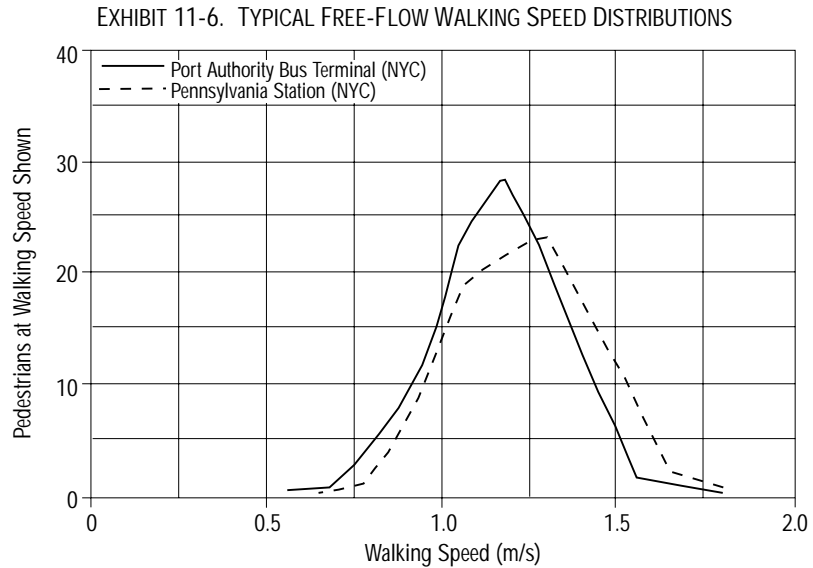

Source: Adapted from Fruin (2).

EFFECTIVE WALKWAY WIDTH

The concept of a pedestrian lane has been used to analyze pedestrian flow, similar to analyzing a highway lane. However, the lane concept should not be used for pedestrian analysis, because studies have shown that pedestrians do not walk in organized lanes. The lane concept is meaningful only for determining how many persons can walk abreast in a given width of walkway, for example, in determining the minimum sidewalk width to permit two pedestrians to pass each other conveniently.

To avoid interference when two pedestrians pass each other, each should have at least 0.8 m of walkway width (I). When pedestrians who know each other walk close together, each occupies a width of 0.7 m, allowing considerable likelihood of contact due to body sway. Lateral spacing less than this occurs only in the most crowded situations.

Clear walkway width refers to the portion of a walkway that can be used effectively for pedestrian movements. Moving pedestrians shy away from the curb and do not press closely against building walls. Therefore, this unused space must be discounted when analyzing a pedestrian facility. Also, a strip preempted by pedestrians standing near a building, or near physical obstructions, such as light poles, mail boxes, and parking meters, should be excluded.

The degree to which single obstructions, such as poles, signs, and hydrants, influence pedestrian movement and reduce effective walkway width is not extensively documented. Although a single point of obstruction would not reduce the effective width of an entire walkway, it would have an effect on its immediate vicinity.

PEDESTRIAN TYPE AND TRIP PURPOSE

The analysis of pedestrian flow generally is based on the mean, or average, walking speeds of groups of pedestrians. Within any group, or among groups, there can be considerable differences in flow characteristics due to trip purpose, land use, type of group, age, and other factors.

Pedestrians going to and from work, using the same facilities day after day, walk at higher speeds than shoppers, as shown in Exhibit 11-1. Older or very young persons tend to walk at a slower speed than other groups. Shoppers not only tend to walk slower than commuters, but also can decrease the effective walkway width by stopping to window shop and by carrying packages. The analyst should adjust for pedestrian behavior that deviates from the regular patterns represented in the basic speed, volume, and density curves.

Clear walkway width

PERFORMANCE MEASURES

The LOS criteria for pedestrian flow are based on subjective measures, which can be imprecise. However, it is possible to define ranges of space per pedestrian, flow rates, and speeds, which then can be used to develop quality-of-flow criteria.

Speed is an important LOS criterion because it can be observed and measured easily, and because it is a descriptor of the service pedestrians perceive. At speeds of 0.7 m/s or less, most pedestrians resort to an unnatural shuffling gait. Exhibit 11-4 shows that this speed corresponds to a space per pedestrian in the range of 0.6 to 0.7 m²/p. At 1.5 m²/p or less, even the slowest walkers are forced to slow down. The fastest walkers cannot reach their chosen speed of 1.8 m/s until the available space is more than 4 m²/p. As shown in Exhibit 11-2, these three space values, 0.6, 1.5, and 4 m²/p, correspond approximately to the maximum flow at capacity, at two-thirds of capacity, and at one-third of capacity, respectively.

There are other significant indicators of service levels. For example, a pedestrian's ability to cross a pedestrian stream is impaired at space values less than 3.5 m²/p, as shown in Exhibit 11-7 (2). Above that level, the probability of stopping or breaking the normal walking gait is reduced to zero. Below 1.5 m²/p, virtually every crossing movement encounters a conflict. Similarly, the ability to pass slower pedestrians is unimpaired above 3.5 m²/p, but becomes progressively more difficult as space allocations drop to 1.8 m²/p, the point at which passing becomes virtually impossible.

Conflict in crossing pedestrian streams

EXHIBIT 11-7. CROSS-FLOW TRAFFIC: PROBABILITY OF CONFLICT

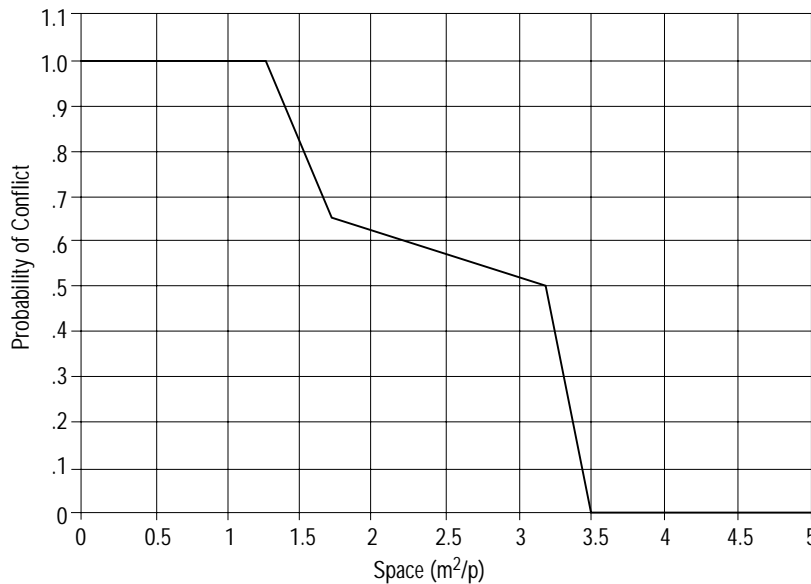

Source: Adapted from Fruin (2).

Another LOS indicator is the ability to maintain flow in the minor direction when opposed by a major pedestrian flow. For pedestrian streams of roughly equal flow in each direction, there is little reduction in the capacity of the walkway compared with one-way flow, because the directional streams tend to separate and occupy a proportional share of the walkway. However, if the directional split is 90 percent versus 10 percent, and space is 1.0 m²/p, capacity reductions of about 15 percent have been observed. This reduction results from the inability of the minor flow to use a proportionate share of the walkway.

Maintaining flow in minor (opposing) direction

Photographic studies show that pedestrian movement on sidewalks is affected by other pedestrians, even when space is more than 4 m²/p. At 6 m²/p, pedestrians have been observed walking in a checkerboard pattern, rather than directly behind or alongside each other. These same observations suggest that up to 10 m²/p are necessary before

Average space available

completely free movement occurs without conflicts, and that at 13 m²/p, individual pedestrians are no longer influenced by others (4). Bunching or platooning does not completely disappear until space is about 50 m²/p or higher. Graphic illustrations and descriptions of walkway LOS are shown in Exhibit 11-8. These LOS criteria are based on average flow and do not consider platoon flow.

The concept of using the average space available to pedestrians as a walkway LOS measure also can be applied to queuing or waiting areas. In these areas, the pedestrian stands temporarily, waiting to be served. The LOS of the waiting area is related to the average space available to each pedestrian and the degree of mobility allowed. In dense, standing crowds, there is little room to move, but limited circulation is possible as the average space per pedestrian increases.

LOS descriptions for queuing areas (with standing pedestrians) are based on average pedestrian space, personal comfort, and degrees of internal mobility and are shown on Exhibit 11-9. Standing areas in the LOS E category of 0.2 to 0.3 m²/p are encountered only in the most crowded elevators or transit vehicles. LOS D, at 0.3 to 0.6 m²/p, also typically describes crowding, but with some internal maneuverability. This commonly occurs on sidewalks when groups of pedestrians wait to cross at street corners. Waiting areas that require more space for circulation, such as theater lobbies and transit platforms, must meet a higher LOS.

PEDESTRIAN PLATOONS

The average flow rates at different LOS are of limited usefulness, unless reasonable time intervals are specified. Exhibit 11-10 illustrates that average flow rates can be misleading. The data shown are for two locations in New York City, but the pattern is generally characteristic of concentrated central business districts (CBD). The maximum 15-min flow rates averaged 4.5 and 6.0 p/min/m of effective walkway width during the periods measured. However, Exhibit 11-10 shows that flow during a 1-min interval can be more than double the rate in another, particularly at relatively low flows. Even during the peak 15-min period, incremental variations of 50 to 100 percent frequently occurred from one minute to the next.

Depending on traffic patterns, a facility designed for average flow can afford lower quality of flow for a portion of its pedestrian traffic. However, it is not prudent to design for extreme peak 1-min flows that occur only 1 or 2 percent of the time. A relevant time period should be determined through closer evaluation of the short-term fluctuations of pedestrian flow.

Short-term fluctuations are present in most unregulated pedestrian traffic flows because of the random arrivals of pedestrians. On sidewalks, these random fluctuations are exaggerated by the interruption of flow and queue formation caused by traffic signals. Transit facilities can create added surges in demand by releasing large groups of pedestrians in short time intervals, followed by intervals during which no flow occurs. Until they disperse, pedestrians in these types of groups move together as a platoon. Illustration 11-1 depicts platoon flow at an intersection crosswalk. Platoons also can form if passing is impeded because of insufficient space, and faster pedestrians must slow down behind slow walkers.

Although the magnitude and frequency of platoons should be verified by field studies, the LOS in platoons is generally one level lower than the average flow criteria, except for some cases of LOS A and E, which encompass a wide range of pedestrian flow rates. Selecting a design to accommodate either average flows over a longer period or the surges in demand occurring in platoons requires an evaluation of pedestrian convenience, available space, costs, and policy considerations.

LOS in platoons is generally one level lower than the average flow criteria for LOS

EXHIBIT 11-8. PEDESTRIAN WALKWAY LOS

LOS A

Pedestrian Space > 5.6 m²/p *Flow Rate* ≤ 16 p/min/m

At a walkway LOS A, pedestrians move in desired paths without altering their movements in response to other pedestrians. Walking speeds are freely selected, and conflicts between pedestrians are unlikely.

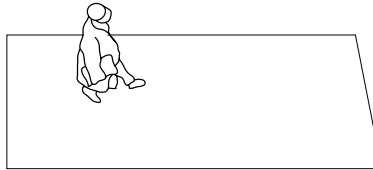

LOS B

Pedestrian Space > 3.7–5.6 m²/p *Flow Rate* > 16–23 p/min/m

At LOS B, there is sufficient area for pedestrians to select walking speeds freely, to bypass other pedestrians, and to avoid crossing conflicts. At this level, pedestrians begin to be aware of other pedestrians, and to respond to their presence when selecting a walking path.

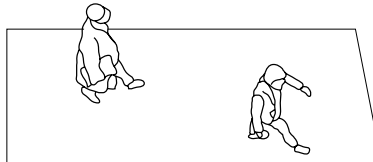

LOS C

Pedestrian Space > 2.2–3.7 m²/p *Flow Rate* > 23–33 p/min/m

At LOS C, space is sufficient for normal walking speeds, and for bypassing other pedestrians in primarily unidirectional streams. Reverse-direction or crossing movements can cause minor conflicts, and speeds and flow rate are somewhat lower.

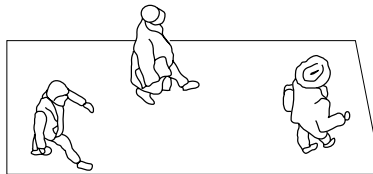

LOS D

Pedestrian Space > 1.4–2.2 m²/p *Flow Rate* > 33–49 p/min/m

At LOS D, freedom to select individual walking speed and to bypass other pedestrians is restricted. Crossing or reverse-flow movements face a high probability of conflict, requiring frequent changes in speed and position. The LOS provides reasonably fluid flow, but friction and interaction between pedestrians is likely.

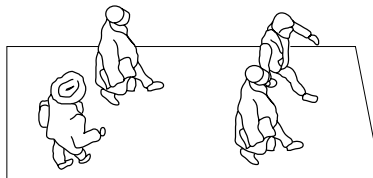

LOS E

Pedestrian Space > 0.75–1.4 m²/p *Flow Rate* > 49–75 p/min/m

At LOS E, virtually all pedestrians restrict their normal walking speed, frequently adjusting their gait. At the lower range, forward movement is possible only by shuffling. Space is not sufficient for passing slower pedestrians. Cross- or reverse-flow movements are possible only with extreme difficulties. Design volumes approach the limit of walkway capacity, with stoppages and interruptions to flow.

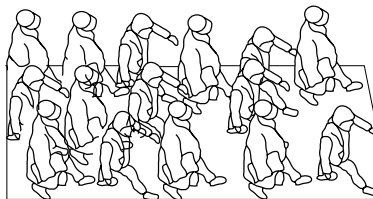

LOS F

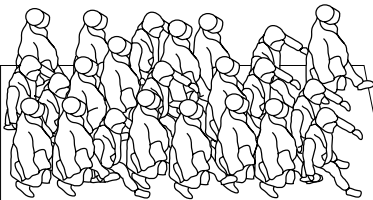

Pedestrian Space ≤ 0.75 m²/p *Flow Rate* varies p/min/m

At LOS F, all walking speeds are severely restricted, and forward progress is made only by shuffling. There is frequent, unavoidable contact with other pedestrians. Cross- and reverse-flow movements are virtually impossible. Flow is sporadic and unstable. Space is more characteristic of queued pedestrians than of moving pedestrian streams.

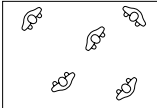

Source: Adapted from Fruin (2).

EXHIBIT 11-9. QUEUING AREA LOS

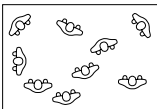
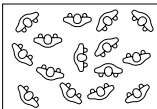
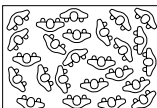
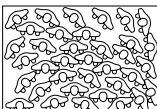
<p>LOS A <i>Average Pedestrian Space</i> > 1.2 m²/p Standing and free circulation through the queuing area is possible without disturbing others within the queue.</p>	
<p>LOS B <i>Average Pedestrian Space</i> > 0.9–1.2 m²/p Standing and partially restricted circulation to avoid disturbing others in the queue is possible.</p>	
<p>LOS C <i>Average Pedestrian Space</i> > 0.6–0.9 m²/p Standing and restricted circulation through the queuing area by disturbing others in the queue is possible; this density is within the range of personal comfort.</p>	
<p>LOS D <i>Average Pedestrian Space</i> > 0.3–0.6 m²/p Standing without touching is possible; circulation is severely restricted within the queue and forward movement is only possible as a group; long-term waiting at this density is uncomfortable.</p>	
<p>LOS E <i>Average Pedestrian Space</i> > 0.2–0.3 m²/p Standing in physical contact with others is unavoidable; circulation in the queue is not possible; queuing can only be sustained for a short period without serious discomfort.</p>	
<p>LOS F <i>Average Pedestrian Space</i> ≤ 0.2 m²/p Virtually all persons within the queue are standing in direct physical contact with others; this density is extremely uncomfortable; no movement is possible in the queue; there is potential for panic in large crowds at this density.</p>	

Source: Adapted from Fruin (2).

EXHIBIT 11-10. MINUTE-BY-MINUTE VARIATIONS IN PEDESTRIAN FLOW

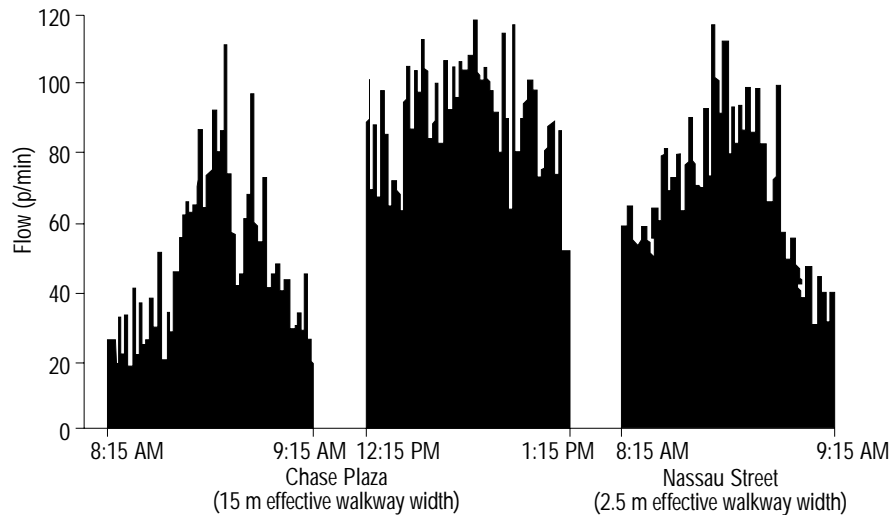

Source: Adapted from Pushkarev and Zupan (1).



ILLUSTRATION 11-1. Platoon flow occurs when pedestrians who know each other walk together.

The scatter diagram shown in Exhibit 11-11 compares the platoon flow rate (i.e., the rate of flow within platoons of pedestrians) to the average flow rate for periods of 5- to 6-min duration. The dashed line approximates the upper limit of platoon flow observations.

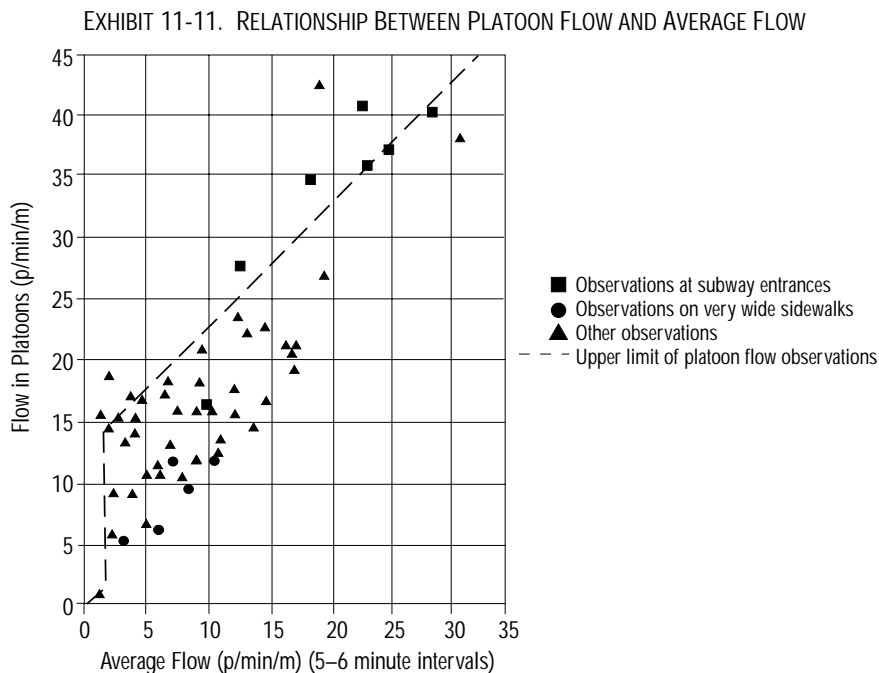

Source: Adapted from Pushkarev and Zupan (1).

REQUIRED INPUT DATA AND ESTIMATED VALUES

Exhibit 11-12 lists default values that may be used for input parameters in the absence of local data. The analyst should note that taking field measurements for use as inputs is the most reliable means of generating parameter values. Only when this is not feasible should default values be considered.

EXHIBIT 11-12. REQUIRED INPUT DATA AND DEFAULT VALUES FOR PEDESTRIANS

Item	Default
Geometric Data	
Length of sidewalk	-
Effective width	1.5 m
Street corner radius	Exhibit 11-14
Crosswalk length ^a	-
Demand Data	
Analysis period	-
Number of pedestrians in a platoon	Equation 11-3
Pedestrian walking speed	1.2 m/s
Pedestrian start-up time	3.0 s
Intersection Data ^a	

Note:

- a. Refer to Chapter 10.

Length of Sidewalk

Chapter 10 describes the required input data and the estimated values of segment length on urban streets. The length of a sidewalk can be approximately equal to the length of an urban street.

Effective Width

The American Association of State Highway and Transportation Officials (AASHTO) recommends that clear sidewalk width should be 1.5 m minimum (5). Widths of 2.4 m or greater may be necessary in commercial areas. If there are roadside appurtenances on the sidewalk adjacent to the curb, additional width is necessary to secure the clear width. Default values listed in Exhibit 11-13 may be used in the absence of local data.

EXHIBIT 11-13. DEFAULT SIDEWALK WIDTHS

Condition	Width (m)
Buffer zone between curb and sidewalk	1.5
No buffer zone between curb and sidewalk	2.1

The effective width of signalized and unsignalized crosswalks varies according to local standards. If local data are not available, a default value of 3.6 m may be used for crosswalk width.

Street Corner Radius

The street corner radius depends on several factors, including the speed of vehicles, the angle of the intersection, the types of vehicles in the turning volume, and right-of-way limitations on the connecting sidewalks. For example, radius requirements for trucks and buses are much larger than for passenger cars. Exhibit 11-14 lists default street corner radii that may be used when the analyst does not have actual measurements.

EXHIBIT 11-14. DEFAULT STREET CORNER RADIUS

Vehicular Traffic Composition	Radius (m)
Trucks and buses in turning volume	13.0
No trucks and buses in turning volume	7.3

AASHTO criteria

Crosswalk Length

Crosswalk length is the sum of widths of approach lanes, the median, and the adjacent outbound lanes. Urban street lane width is discussed in Chapter 10.

Analysis Period

Planning, design, policies, and resources determine the length of an analysis period. The duration of an analysis period for pedestrians is typically 15 min. It is difficult to predict flow patterns like platoons based on a longer analysis period. A midblock walkway should be counted for several different 15-min time periods during the day to establish variations in directional flows. For new locations or future conditions, forecasts of the flows should follow the procedure presented in Chapter 8.

Number of Pedestrians in a Platoon

At signalized intersection crossings, an upstream signal can increase or decrease pedestrian delay at a downstream signal, depending on the offset and the green time at the upstream signal. Thus, the number of platoons at a signalized intersection depends on signal timing and the offset of the green time from the upstream signal.

The number of pedestrians in an unsignalized intersection crossing is determined by pedestrian and vehicle flow rates (ϕ). Equation 11-3 may be used to estimate the number of pedestrians in a platoon.

$$N_c = \frac{v_p e^{v_p t_c} + v e^{-v t_c}}{(v_p + v) e^{(v_p - v) t_c}} \quad (11-3)$$

where

- N_c = size of typical pedestrian crossing platoon (p),
- v_p = pedestrian flow rate (p/s),
- v = vehicular flow rate (veh/s), and
- t_c = single pedestrian critical gap (s).

Pedestrian Walking Speed

Pedestrians exhibit a wide range of walking speeds, varying from 0.8 m/s to 1.8 m/s. Elderly pedestrians generally will be in the slower portion of this range. The *Manual on Uniform Traffic Control Devices* (7) assumes a walking speed of 1.2 m/s for crosswalk signal timing. Walking speeds at midblock are faster than at intersections. They are faster for men than for women, and they are affected by steep grades. Air temperature, time of day, trip purpose, and ice and snow also affect pedestrian walking speeds.

Pedestrian Start-Up Time

Researchers have studied the start-up times of more than 4,000 compliant pedestrians (8). Platoons did not affect the start-up times for either older or younger pedestrians. Start-up time default values are listed in Exhibit 11-15 and may be used in the absence of local data. A reasonable overall default value of 3.0 s may be used in the absence of local data.

EXHIBIT 11-15. DEFAULT START-UP TIME

	50th Percentile Start-Up Time (s)	85th Percentile Start-Up Time (s)
Younger male	1.8	-
Younger female	2.0	-
Older male	2.4	3.7
Older female	2.6	4.0

SERVICE VOLUME TABLE

Exhibit 11-16 provides sample service pedestrian volumes for a sidewalk with 1.5-m effective width.

EXHIBIT 11-16. EXAMPLES OF SERVICE VOLUME FOR A PEDESTRIAN SIDEWALK

LOS	15-min Pedestrian Volume
A	360
B	525
C	750
D	1100
E	1700

Note:
Assumes effective sidewalk width of 1.5 m.

This table contains approximate values and is for illustrative purposes only. The values are highly dependent on the assumptions used. It should not be used for operational analyses or final design. This table was derived using the assumed values listed in the footnote.

III. BICYCLES

BICYCLE LANE

Although bicyclists are not as regimented as vehicles, they tend to operate in distinct lanes of varying widths. The capacity and LOS of a bicycle facility depends on the number of effective lanes used by bicycles. This is far more important than the total width of the bicycle facility or of the individual lanes.

Wherever possible, an analysis of a facility should include a field evaluation of the number of effective lanes in use. When this is not possible, or when planning future facilities, a standard width for a bicycle lane is approximately 1.2 m (9). AASHTO recommends that separated bicycle paths be 3 m wide with a minimum width of 2.4 m in low-volume conditions (9).

Research demonstrates that three-lane bicycle facilities operate more efficiently than two-lane bicycle facilities, affording considerably better quality of service to users (10). This is due primarily to increased opportunities for passing and for maneuvering around other bicyclists and pedestrians. This reinforces the value of determining the number of effective lanes as the principal input for analyzing a bicycle facility.

BICYCLE CAPACITY TERMINOLOGY

Because of the severe deterioration of LOS at flow levels well below capacity, the concept of capacity has little utility in the design and analysis of bicycle paths and other facilities. Capacity is rarely observed on bicycle facilities. Values for capacity therefore reflect sparse data, generally from Europe, or from simulations.

Studies from Europe report capacity values of 1,600 bicycles/h/ln for two-way facilities, and 3,200 bicycles/h/ln for one-way facilities (10). These values are for facilities serving bicycle traffic exclusively under uninterrupted-flow conditions. Although reported here for completeness, these values do not represent reasonable operating conditions, and would result in operations at LOS F. Under interrupted-flow conditions, a saturation flow rate of 2,000 bicycles/h/ln is recommended for a one-direction bicycle lane.

PERFORMANCE MEASURES

Many of the familiar measures of effectiveness are not well-suited to the description of service quality to bicyclists, whether on exclusive or shared facilities. Studies of bicycle speed, for example, show that, as for vehicles, speeds remain relatively

The concept of a bicycle lane is neither well defined nor developed. Field observations are recommended when feasible.

Capacity is not a critical concept for uninterrupted-flow bicycle facilities, which rarely operate close to capacity in the United States

insensitive to flow rates over a wide range of flows. Density, particularly applied to facilities shared with pedestrians and others, is difficult to assess.

The concept of hindrance is related more directly to the comfort and convenience of bicyclists (10). When traveling on a bikeway, two significant parameters can be easily observed and identified. These are the number of users (other bicyclists, pedestrians, et al.) moving in the same direction and passed by the bicyclist, and the number of users moving in the opposing direction and encountered by the bicyclist.

Each of these events causes some discomfort and inconvenience to the bicyclist. Hindrance was originally defined as the fraction of users over 1.0 km of a path experiencing hindrance from passing and meeting maneuvers. This criterion is strongly related to the time a bicyclist is involved in an event. Exhibit 11-17 shows the criteria for LOS in terms of hindrance.

EXHIBIT 11-17. LOS CRITERIA FOR UNINTERRUPTED BICYCLE FACILITIES

LOS	Hindrance (%)
A	≤ 10
B	> 10–20
C	> 20–40
D	> 40–70
E	> 70–100
F	100

Hindrance has unique characteristics as a measure. First, the percentage of time a bicyclist is involved in an event depends on assumptions about the amount of time consumed during an event. Though the limitation for LOS E is 100 percent, this does not represent capacity operation. Further, since the hindrance cannot exceed 100 percent, the value does not get larger at LOS F. What does increase, however, is the number of events experienced by the bicyclist. For this reason, direct use of hindrance is difficult in a computational methodology.

The number of events is used as a surrogate for hindrance (10). Models can be constructed to predict the number of events encountered by a bicyclist in various scenarios, based on assumed distributions of bicyclist and pedestrian speeds; this can, in turn, be related to a hindrance measure.

A LOS based on hindrance, or on surrogate events, has a unique characteristic. The LOS E/F boundary of 100 percent hindrance is achieved at a flow level well below the facility capacity. As on two-lane highways, service quality on bicycle facilities deteriorates at relatively low effective v/c ratios. As happens at signalized intersections, LOS F can be achieved with v/c ratios of less than 1.00. Although these cases offer some analogies, the impact is more severe with bicycle facilities. Exhibit 11-18 depicts this phenomenon. In Exhibit 11-18, LOS F occurs when bicyclists reach a level of hindrance considered unacceptable. This occurs at a flow level less than capacity, perhaps considerably less.

The concepts described in this section apply to uninterrupted-flow bicycle facilities. LOS for bicycles on interrupted facilities are related to measures of delay or average travel speed, consistent with the approaches taken for vehicular traffic on similar facilities.

Hindrance as a performance measure

Hindrance is difficult to measure directly. A surrogate, the number of events encountered by a bicyclist per unit of time, is used instead.

EXHIBIT 11-18. BICYCLE LOS AND SPEED-FLOW RELATIONSHIPS FOR UNINTERRUPTED FLOW

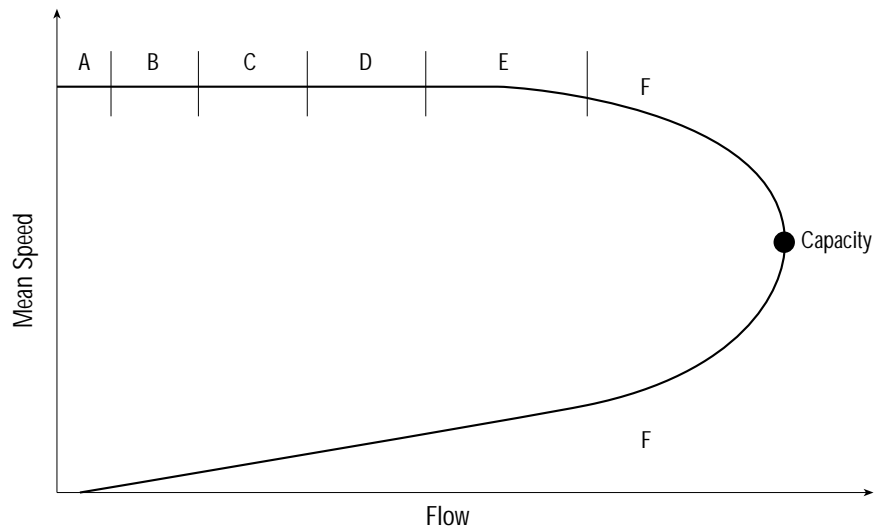

UNINTERRUPTED BICYCLE FLOW

Uninterrupted bicycle facilities include both exclusive and shared bicycle paths that are physically separated from vehicular roadways and do not have points of fixed interruption (except at terminal points) within the path. Illustration 11-2 shows an exclusive off-street bicycle facility, while Illustration 11-3 shows a mixed-use, off-street bicycle path. Exhibit 11-17 provides LOS criteria for uninterrupted bicycle facilities.



ILLUSTRATION 11-2. Exclusive, off-street bicycle path.



ILLUSTRATION 11-3. Off-street shared bicycle path.

INTERRUPTED BICYCLE FLOW

Interrupted bicycle facilities include on-street bicycle lanes that pass through signalized and unsignalized intersections, with or without exclusive right-turn lanes for motor vehicle traffic. Only on-street bicycle facilities are included in this category; even though off-street bicycle facilities occasionally have signals or stop signs at crossings, these types of intersections are not common in the United States and have not been researched extensively. An example of bicycle lane treatment at a signalized intersection with an exclusive right-turn lane is shown in Illustration 11-4.

Control delay is the measure used to determine LOS, just as for motor vehicles at signalized and unsignalized intersections. Delay is especially important to bicyclists, since they are exposed to the elements. Excessive delays on designated bicycle facilities can cause disregard of traffic-control devices or encourage the use of alternate routes not intended for bicyclists.



ILLUSTRATION 11-4. Bicycle lane treatment at a signalized intersection.

REQUIRED DATA AND ESTIMATED VALUES

Exhibit 11-19 lists default values that may be used for input parameters in the absence of local data. The analyst should note that taking field measurements is the most reliable means of generating parameter values. Only when this is not feasible should default values be considered.

EXHIBIT 11-19. REQUIRED INPUT DATA AND DEFAULT VALUES FOR BICYCLE PATHS

Item	Default
Geometric Data	
Length	-
Bicycle path width	2.4 m
Demand Data	
Analysis period	-
Peak-hour factor (PHF)	0.80
Bicycle speed	25 km/h
Intersection Data (refer to Chapter 10)	

Length

Refer to the description of length under the required input data and estimated values for urban streets. The length of a bicycle path can be approximately equal to the length of an urban street.

Bicycle Path Width

AASHTO recommends a bicycle path width of 3.0 m with 2.4 m as a minimum requirement (9). Most facilities in the United States operate as two-lane bicycle paths (2.4 m wide). Exhibit 11-20 lists default widths for two-lane and three-lane bicycle paths.

EXHIBIT 11-20. DEFAULT BICYCLE PATH WIDTHS

	Width (m)
Two-lane path	2.4
Three-lane path	3.0

Analysis Period

Planning and design procedures and policies, and agency resources determine the analysis period. For bicycles, the analysis period is typically 15 min. It is established in a way similar to the vehicular analysis period described in Chapter 10.

Peak-Hour Factor

Bicycle traffic has been observed to have peaking characteristics different from those generally associated with vehicular traffic. Peaks tend to be sharper and more pronounced, especially in the vicinity of a university campus. Daily and even hourly volumes might not appear substantial until peaking is considered. One study in Madison, Wisconsin, measured peak-hour volumes as 10 to 15 percent of the total daily volumes at some locations (11). Another study measured bicycle peak-hour factors between 0.52 and 0.82 at various locations (12). A default value of 0.80 may be used for bicycle PHF in the absence of local data.

Bicycle Speed

As with motor vehicle traffic, bicycle speeds on uninterrupted facilities are not affected by volume over a large initial range. A default value of 25 km/h may be used as the average bicycle running speed in the absence of local data (13). Bicycle speed is affected by factors such as separation from vehicular and pedestrian traffic, presence of commercial and residential driveways, adjacent on-street parking, lateral obstructions, grades, and other local conditions. Trip purpose, age and physical condition of the cyclist, and environmental conditions such as wind, rain, and reduced visibility also can affect bicycle speed.

SERVICE VOLUME TABLES

Exhibits 11-21 and 11-22 provide LOS criteria for a two-way shared bicycle facility operating as two-lane and three-lane, respectively. Exhibit 11-21 provides criteria for bicycles that can be used to determine LOS for a one-way shared facility using pedestrian and bicycle volumes.

Note that for many values drawn from Exhibit 11-22, the resulting LOS is F. For bicycle flow rates of 500 and 600 bicycles/h, there are no conditions when level of service F does not occur on two-way shared paths. This emphasizes the deterioration in service at relatively low flow levels. This trend worsens when pedestrians and other users share an off-street path.

EXHIBIT 11-21. FREQUENCY OF EVENTS ON SHARED TWO-LANE (2.4 m) BICYCLE FACILITY^a

Bicycle Volume (bicycles/h)	Directional Split of Bicycles (same:opposite)	Total Frequency of Events (events/h) and LOS							
		Two-Way Pedestrian Volumes							
		0 p/h ^b	LOS	20 p/h ^b	LOS	40 p/h ^b	LOS	80 p/h ^b	LOS
100	30:70	76	C	131	D	186	E	296	F
	40:60	68	C	123	D	178	E	288	F
	50:50	59	B	114	D	169	E	279	F
	60:40	51	B	106	D	161	E	271	F
	70:30	43	B	98	C	153	E	263	F
200	30:70	151	E	206	F	261	F	371	F
	40:60	135	D	190	E	245	F	355	F
	50:50	119	D	174	E	229	F	339	F
	60:40	103	D	158	E	213	F	323	F
	70:30	86	C	141	D	196	F	306	F
400	30:70	303	F	358	F	413	F	523	F
	40:60	270	F	325	F	380	F	490	F
	50:50	238	F	293	F	348	F	458	F
	60:40	205	F	260	F	315	F	425	F
	70:30	173	E	228	F	283	F	393	F
800	30:70	605	F	660	F	715	F	825	F
	40:60	540	F	595	F	650	F	760	F
	50:50	475	F	530	F	585	F	695	F
	60:40	410	F	465	F	520	F	630	F
	70:30	345	F	400	F	455	F	565	F

Note:

- a. An event is a bicycle meeting or passing a pedestrian or bicycle.
- b. 50:50 directional split is assumed for pedestrians.

This table contains approximate values and is for illustrative purposes only. The values are highly dependent on the assumptions used. It should not be used for operational analyses or final design. This table was derived using the assumed values listed in the footnote.

This table contains approximate values and is for illustrative purposes only. The values are highly dependent on the assumptions used. It should not be used for operational analyses or final design. This table was derived using the assumed values listed in the footnote.

EXHIBIT 11-22. FREQUENCY OF EVENTS ON SHARED THREE-LANE (3.0 m) BICYCLE FACILITY^a

Bicycle Volume (bicycles/h)	Directional Split of Bicycles (same:opposite)	Total Frequency of Events (events/h) and LOS							
		Two-Way Pedestrian Volumes							
		0 p/h ^b	LOS	20 p/h ^b	LOS	40 p/h ^b	LOS	80 p/h ^b	LOS
100	30:70	76	A	131	B	186	C	296	D
	40:60	68	A	123	B	178	C	288	D
	50:50	59	A	114	B	169	C	279	D
	60:40	51	A	106	B	161	C	271	D
	70:30	43	A	98	B	153	C	263	D
200	30:70	151	C	206	C	261	D	371	E
	40:60	135	B	190	C	245	D	355	E
	50:50	119	B	174	C	229	D	339	E
	60:40	103	B	158	C	213	D	323	E
	70:30	86	A	141	C	196	C	306	E
400	30:70	303	E	358	E	413	F	523	F
	40:60	270	D	325	E	380	F	490	F
	50:50	238	D	293	D	348	E	458	F
	60:40	205	C	260	D	315	E	425	F
	70:30	173	C	228	D	283	D	393	F
800	30:70	605	F	660	F	715	F	825	F
	40:60	540	F	595	F	650	F	760	F
	50:50	475	F	530	F	585	F	695	F
	60:40	410	F	465	F	520	F	630	F
	70:30	345	E	400	F	455	F	565	F

Note:

- a. An event is a bicycle meeting or passing a pedestrian or bicycle.
- b. 50:50 directional split is assumed for pedestrians.

IV. REFERENCES

1. Pushkarev, B., and J. Zupan. *Urban Space for Pedestrians*. MIT Press, Cambridge, Mass., 1975.
2. Fruin, J. *Pedestrian Planning and Design*. Elevator World, Mobile, Ala., 1990.
3. Roupail, N., J. Hummer, P. Allen, J. Milazzo. *Recommended Procedures for Chapter 13, Pedestrians, of the Highway Capacity Manual*. Report FHWA-RD-98-107. FHWA, U.S. Department of Transportation, Washington, D.C. (in preparation).
4. Hall, D. *The Hidden Dimensions*. Doubleday and Co., New York, N.Y., 1966.
5. American Association of State Highway and Transportation Officials. *A Policy on Geometric Design of Highways and Streets*. Washington, D.C., 1994.
6. Gerlough, D., M. Huber. *Special Report 165: Traffic Flow Theory: A Monograph*. TRB, National Research Council, Washington, D.C., 1975.
7. *Manual on Uniform Traffic Control Devices*. Federal Highway Administration, Washington, D.C., 1988.
8. Knoblauch, R. L., M. T. Pietrucha, and M. Nitzburg. Field Studies of Pedestrian Walking Speed and Start-Up Time. In *Transportation Research Record 1538*, TRB, National Research Council, Washington, D.C., 1996, pp. 27–38.
9. American Association of State Highway and Transportation Officials. *Guide for the Development of Bicycle Facilities*. Washington, D.C., 1991.

10. Botma, H. Method to Determine Levels of Service for Bicycle Paths and Pedestrian–Bicycle Paths. In *Transportation Research Record 1502*, TRB, National Research Council, Washington, D.C., 1995, pp. 38–44.
11. Hunter, W. W., and H. F. Huang. User Counts on Bicycle Lanes and Multi-Use Trails in the United States. In *Transportation Research Record 1502*, TRB, National Research Council, Washington D.C., 1995, pp. 45–57.
12. Niemeier, D. Longitudinal Analysis of Bicycle Count Variability: Results and Modeling Implications. *Journal of Transportation Engineering*, Vol. 122, No. 3, May/June 1996, pp. 200–206.
13. Rouphail, N., J. Hummer, P. Allen, and J. Milazzo. *Recommended Procedures for Chapter 14, Bicycles, of the Highway Capacity Manual*. Report FHWA-RD-98-108. FHWA, U.S. Department of Transportation, Washington, D.C. (in preparation).

CHAPTER 12

HIGHWAY CONCEPTS

CONTENTS

I.	INTRODUCTION	12-1
II.	MULTILANE HIGHWAYS	12-1
	Multilane Highway Capacity	12-2
	Free-Flow Speed	12-2
	Relationships Between Highway Types	12-3
	Speed-Flow and Density-Flow Relationships	12-3
	Factors Affecting FFS	12-3
	Lane Width and Lateral Clearance	12-4
	Median Type	12-5
	Access Points	12-6
	Other Factors	12-6
	Factors Affecting Flow Rate	12-7
	Heavy Vehicles	12-7
	Driver Population	12-7
	LOS	12-7
	Required Input Data and Estimated Values	12-8
	Lane Width and Lateral Clearance	12-8
	Median	12-9
	Access-Point Density	12-9
	Specific Grade or General Terrain	12-9
	Base FFS	12-10
	Length of Analysis Period	12-10
	PHF	12-10
	Percentage of Heavy Vehicles	12-10
	Driver Population Factor	12-10
	Service Volume Table	12-10
III.	TWO-LANE HIGHWAYS	12-11
	Classification of Two-Lane Highways	12-12
	Base Conditions	12-13
	Basic Relationships	12-13
	Passing Lanes on Two-Lane Highways	12-15
	LOS	12-15
	Required Input Data and Estimated Values	12-17
	Highway Classes	12-17
	Lane Width and Shoulder Width	12-17
	Access-Point Density	12-17
	Specific Grade or General Terrain	12-17
	Percentage of No-Passing Zones	12-17
	Base FFS	12-18
	Length of Passing Lane	12-18
	Length of Analysis Period	12-18
	PHF	12-18
	Directional Split	12-18
	Percentage of Heavy Vehicles	12-18
	Service Volume Table	12-19
IV.	REFERENCES	12-19

EXHIBITS

Exhibit 12-1. Speed-Flow Relationships on Multilane Highways 12-4

Exhibit 12-2. Density-Flow Relationships on Multilane Highways 12-4

Exhibit 12-3. Required Input Data for Multilane Highways 12-9

Exhibit 12-4. Default Access-Point Density 12-9

Exhibit 12-5. Example Service Volumes for Multilane Highways 12-11

Exhibit 12-6. Speed-Flow and Percent Time-Spent-Following Flow Relationships for Two-Way Segments with Base Conditions 12-14

Exhibit 12-7. Speed-Flow and Percent Time-Spent-Following Flow Relationships for Directional Segments with Base Conditions 12-15

Exhibit 12-8. Plan View of a Typical Passing Lane 12-15

Exhibit 12-9. Required Input Data: Two-Lane Highways 12-17

Exhibit 12-10. Summary of Two-Lane Highway Classes 12-17

Exhibit 12-11. Default Values for Percentage of No-Passing Zones 12-18

Exhibit 12-12. Optimal Lengths of Passing Lanes 12-18

Exhibit 12-13. Default Values for Directional Split on Two-Lane Highways 12-18

Exhibit 12-14. Default Heavy-Vehicle Percentages on Two-Lane Highways 12-19

Exhibit 12-15. Example Service Volumes for a Class I Two-Lane Rural Highway 12-19

I. INTRODUCTION

This chapter introduces capacity and quality-of-service concepts for highway facilities with points of access that are not fully controlled. This chapter can be used in conjunction with Chapter 20, which provides a methodology for two-lane highways, and Chapter 21, which provides a methodology for multilane highways.

II. MULTILANE HIGHWAYS

Multilane highways generally have posted speed limits of 60 to 90 km/h. They usually have a total of four or six lanes, counting both directions, often with medians or two-way left-turn lanes (TWLTL); however, they also may be undivided.

Multilane highways typically are located in suburban communities, leading into central cities, or along high-volume rural corridors connecting two cities or two significant activities that generate a substantial number of daily trips. Such highways often have traffic signals; but traffic signals spaced at 3.0 km or less typically create urban street conditions.

Traffic volumes on multilane highways vary but might range from 15,000 to 40,000 veh/day. In some cases, volumes as high as 100,000 veh/day have been observed when access across the median is restricted and when all major crossings are grade separated.

Illustrations 12-1 through 12-4 show typical multilane highways.

Traffic signals spaced at 3.0 km or less create urban street conditions



ILLUSTRATION 12-1. Divided multilane highway in a rural environment.



ILLUSTRATION 12-2. Divided multilane highway in a suburban environment.



ILLUSTRATION 12-3. Undivided multilane highway in a rural environment.

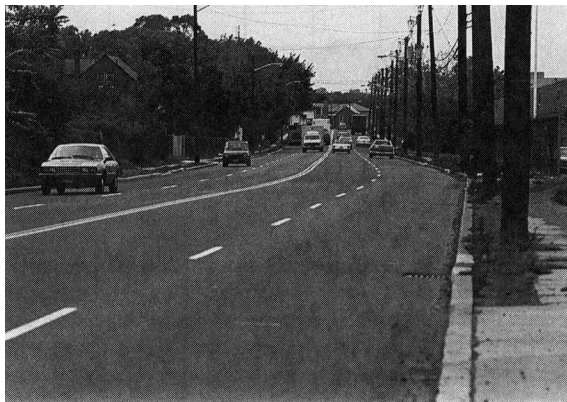

ILLUSTRATION 12-4. Undivided multilane highway in a suburban environment.

Multilane highways can be similar to freeways or can approach urban street conditions

MULTILANE HIGHWAY CAPACITY

Multilane highways in suburban and rural settings have different operational characteristics from freeways, urban streets, and two-lane highways. Most notably, multilane highways are not completely access controlled—they can have at-grade intersections and occasional traffic signals.

Friction caused by opposing vehicles on undivided highways and the access to roadside development contribute to a different operational setting from that of freeways. Multilane highways range from the uninterrupted flow of freeways to the flow conditions on urban streets, which are frequently interrupted by signals.

The capacity of a multilane highway is the maximum sustained hourly flow rate at which vehicles reasonably can be expected to traverse a uniform segment under prevailing roadway and traffic conditions.

FREE-FLOW SPEED

Free-flow speed (FFS) is the speed of traffic at low volume and low density. It is the speed at which drivers feel comfortable traveling under the physical, environmental, and traffic-control conditions on an uncongested section of multilane highway. Free-flow speeds will be lower on sections of highway with restricted vertical or horizontal alignments. FFS tend to be lower when posted speed limits are lower. The importance of

FFS is that it is the starting point for analyzing capacity and level of service (LOS) for uninterrupted-flow conditions.

Field determination of FFS requires travel time studies during periods of low-to-moderate volume. Operating speed, as defined in previous capacity manuals and in documents produced by the American Association of State Highway and Transportation Officials, is similar to FFS under low-volume conditions. For multilane highways, the upper limit for low volume is 1,400 passenger cars per hour per lane (pc/h/ln).

The FFS for multilane highways is the mean speed of passenger cars under low-to-moderate traffic flow. The LOS for multilane highways is based on density, which is calculated by dividing per-lane flow by speed.

RELATIONSHIPS BETWEEN HIGHWAY TYPES

Certain characteristics distinguish multilane suburban and rural highways from freeways. Vehicles may enter or leave multilane highways at intersections and driveways, and they can encounter traffic signals.

Design standards for multilane highways tend to be lower than those for freeways, although a multilane highway approaches freeway conditions as its access points and turning volumes approach zero. Moreover, the visual setting and the developed frontage along multilane highways have a greater impact on drivers than they do along freeways.

The multilane highway is similar to urban streets in many respects, although it lacks the regularity of traffic signals and tends to have greater control on the number of access points per kilometer. Also, its design standards are generally higher than those for urban streets. The speed limits on multilane highways are often 10 to 20 km/h higher than speed limits on urban streets. Pedestrian activity, as well as parking, is minimal, unlike on urban streets.

Multilane highways differ substantially from two-lane highways, principally because a driver on a multilane highway is able to pass slower-moving vehicles without using lanes designated for oncoming traffic. Multilane highways also tend to be located near urban areas and often connect urban areas; they usually have better design features than two-lane highways, including horizontal and vertical curvature.

SPEED-FLOW AND DENSITY-FLOW RELATIONSHIPS

The speed-flow and density-flow relationships for a typical uninterrupted-flow segment on a multilane highway under either base or nonbase conditions in which the FFS is known are shown in Exhibits 12-1 and 12-2. Because drivers on multilane highways allow for potential conflicts with turning traffic—even when there are no access points in the immediate vicinity—the operating characteristics may be slightly less favorable than for a freeway.

As indicated in Exhibit 12-1, the speed of traffic on a multilane highway is not affected by traffic volume with a flow rate of less than 1,400 pc/h/ln. As the exhibit shows, the capacity of a multilane highway under base conditions is 2,200 pc/h/ln for highways with an FFS of 100 km/h. For flow rates of 1,400 to 2,200 pc/h/ln, the speed on a multilane highway with an FFS of 100 km/h drops by 12 km/h. Exhibit 12-2 shows that density varies continuously throughout the range of flow rates.

The capacity value of 2,200 pc/h/ln represents the maximum 15-min flow rate accommodated under base conditions for highways with an FFS of 100 km/h. Capacities on specific multilane highways may vary.

FACTORS AFFECTING FFS

Several traffic control, physical, and traffic conditions affect the FFS along a multilane highway. These conditions are described in the following sections.

Field studies of FFS

EXHIBIT 12-1. SPEED-FLOW RELATIONSHIPS ON MULTILANE HIGHWAYS

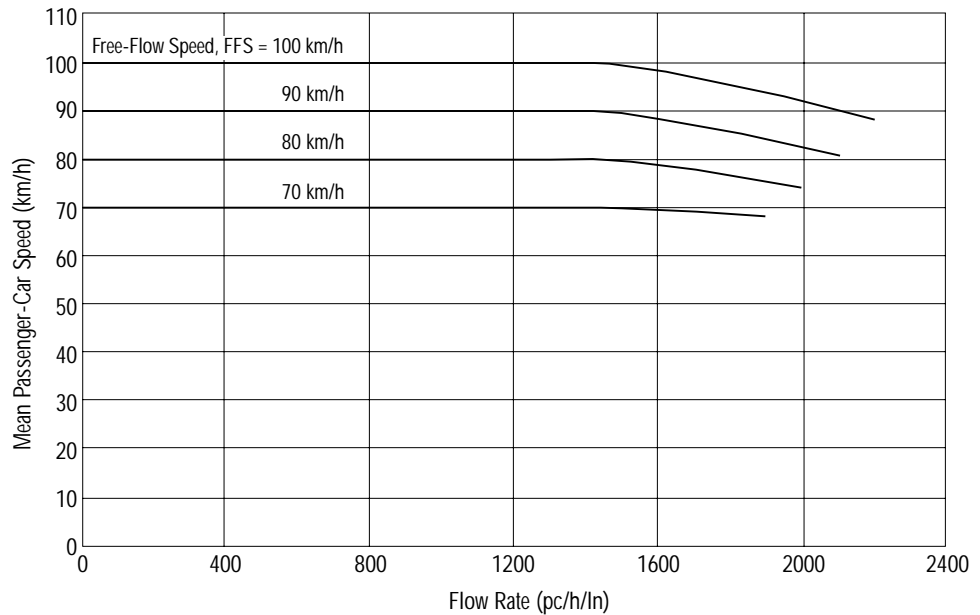
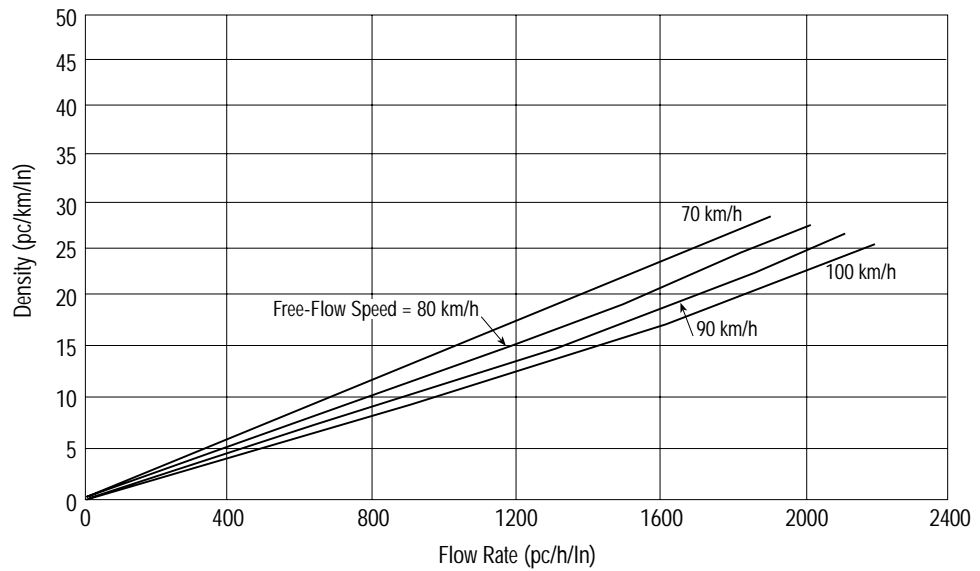

EXHIBIT 12-2. DENSITY-FLOW RELATIONSHIPS ON MULTILANE HIGHWAYS



Lane Width and Lateral Clearance

Two adjustments reflect the effect of a constricted cross section on free-flow speeds. The adjustments relate to the average width of lanes and the combined lateral clearance along the right side and the median of a multilane highway. Lane widths less than 3.6 m reduce travel speeds; however, widths of more than 3.6 m are not considered to increase speed above the base level.

For lateral clearance, a total clearance—that is, the left side plus the right side along one direction of roadway—of 3.6 m or more is considered the base condition. A combined lateral clearance of less than 3.6 m has a negative influence on travel speeds.

Whether roadside and median objects and barriers present true obstructions is a matter of judgment. These obstructions might be continuous—such as a retaining wall—or not continuous—such as light supports or bridge abutments. In some cases, drivers become accustomed to certain types of obstructions, so that the effect on traffic flow becomes negligible. For example, continuous reinforced-concrete and W-beam barriers have little or no impact on speeds, even when less than 1.8 m from the travel lanes. Illustrations 12-5 through 12-8 show various types of roadside and median treatments that can affect the flow on multilane highways.

Median Type

Typically, there are three types of medians along multilane rural and suburban highways:

- Undivided medians composed of a striped centerline;
- TWLTL medians composed of a full-width lane; and
- Medians composed of a raised curb, barrier, or natural terrain or landscaping.

A raised curb in the median, even when interrupted with regular openings should be considered a raised median; however, short sections of raised or flush median (less than 150 m long) should not.



ILLUSTRATION 12-5. Bridge pier in center of normally undivided suburban multilane highway.



ILLUSTRATION 12-6. Inadequate shoulder width and other obstructions along multilane highway.

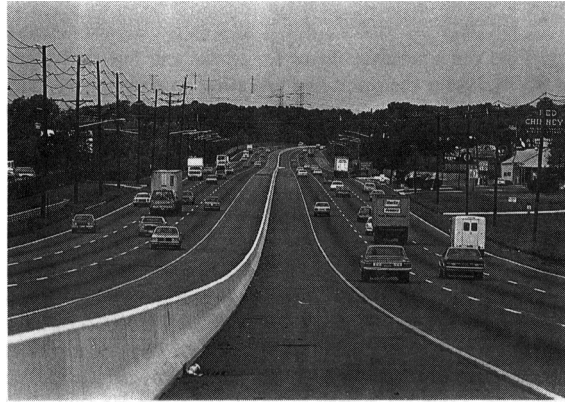

ILLUSTRATION 12-7. Divided multilane highway with high design standards.



ILLUSTRATION 12-8. Divided multilane highway with TWLTL and adequate shoulder width.

Access Points

An important influence on FFS is the number of access points along the right side of the roadway. The amount of activity at each point contributes to changes in travel speed, but drivers also adjust their travel speed simply because the access points are there.

The placement of intersections or driveways along a multilane highway therefore reduces travel speeds. For every six access points per kilometer in one direction, travel speed on a multilane highway decreases by 4.0 km/h (1).

Typically, only access points on the right of the roadway are taken into account. Intersections, driveways, or median openings on the opposite side that are expected to have a significant effect on traffic flow in the direction of interest may be included when determining access-point density.

Other Factors

The design speed of the principal physical elements of a multilane roadway—especially horizontal and vertical alignments—also can influence travel speeds. Design speed, however, is difficult to assess in the field; therefore several alternative methods for estimating FFS along a section of multilane highway are described in Chapter 21. The design speed, along with the associated horizontal and vertical alignments, is implicit in these methods. However, if a multilane highway has extreme horizontal or vertical conditions, FFS should be determined from field observation and field study.

Posted speed limits normally influence the FFS of passenger cars (2). Typically, the mean speed of passenger cars is above the posted speed limit for multilane highways.

Posted speed limits

The posted speed limit correlates significantly with the speed at which vehicles move along the highway. When no other estimate is available, the FFS can be calculated based on the posted speed limit.

Vehicular speeds, and the proportion of vehicles exceeding the speed limit, are affected by speed enforcement. However, several studies (3–5) have found that enforcement effects are limited, both temporally and spatially. The effect of enforcement depends on its type and duration. In general, a stationary enforcement activity affects no more than a 13 to 15 km of roadway; moreover, its effect decays exponentially downstream. Nonetheless, the speeds at the site may be affected for up to 2 to 3 days afterwards. If the roadway is located in a community that regularly enforces speed limits, local measurements can be used to calibrate the relationship between 85th-percentile speed and FFS. These measurements should be taken, therefore, when the average anticipated enforcement efforts are under way.

FACTORS AFFECTING FLOW RATE

The volume estimate is adjusted by factors relating to both the composition and fluctuation of traffic, so that all roadways can be compared with an equivalent measure of passenger cars per hour per lane (pc/h/ln).

The basis for traffic volumes is a 15-min peak-period flow during a peak hour of the day. Therefore, volumes in two time periods are required: a peak-hour volume and the flow rate within the peak 15 min of the peak hour. The hourly volume divided by the peak-hour factor (PHF) yields a flow rate. The PHF is the ratio of total hourly volume to four times the highest 15-min volume within the peak hour.

Peak-hour factor

Heavy Vehicles

The second adjustment to the volume relates to heavy vehicles—the number of trucks, buses, and recreational vehicles (RVs) are converted into an equivalent number of passenger cars. Two categories of heavy vehicles are used: trucks and RVs. For analysis purposes, buses on multilane highways are categorized as trucks.

Converting heavy vehicles to equivalent passenger cars is especially important when analyzing sections of highway with grades. On level terrain and for near-capacity conditions, trucks, buses, and RVs tend to operate like passenger cars, so that the equivalency factor approaches 1.

Driver Population

The base conditions for multilane highway flow include a driver population primarily of commuters. Studies have shown that commuter and noncommuter driver populations do not display the same characteristics. Capacities for recreational traffic can be up to 20 percent lower than for commuter traffic on the same highway; however, the FFS does not seem to be similarly affected. If this possible effect of driver population is taken into account, locally derived data should be obtained and used carefully, according to the methodology for multilane highways.

LOS

A multilane highway is characterized by three performance measures:

- Density, in terms of passenger cars per kilometer per lane;
- Speed, in terms of mean passenger car speed; and
- Volume to capacity ratio.

Each of these measures indicates how well the highway accommodates traffic flow.

Density is the assigned primary performance measure for estimating LOS. The three measures of speed, density, and flow or volume are interrelated. If the values of two of these measures are known, the remaining measure can be computed.

LOS A describes completely free-flow conditions. The operation of vehicles is virtually unaffected by the presence of other vehicles, and operations are constrained only

Density defines LOS for multilane highways

by the geometric features of the highway and by driver preferences. Maneuverability within the traffic stream is good. Minor disruptions to flow are easily absorbed without a change in travel speed.

LOS B also indicates free flow, although the presence of other vehicles becomes noticeable. Average travel speeds are the same as in LOS A, but drivers have slightly less freedom to maneuver. Minor disruptions are still easily absorbed, although local deterioration in LOS will be more obvious.

In LOS C, the influence of traffic density on operations becomes marked. The ability to maneuver within the traffic stream is clearly affected by other vehicles. On multilane highways with an FFS above 80 km/h, the travel speeds reduce somewhat. Minor disruptions can cause serious local deterioration in service, and queues will form behind any significant traffic disruption.

At LOS D, the ability to maneuver is severely restricted due to traffic congestion. Travel speed is reduced by the increasing volume. Only minor disruptions can be absorbed without extensive queues forming and the service deteriorating.

LOS E represents operations at or near capacity, an unstable level. The densities vary, depending on the FFS. Vehicles are operating with the minimum spacing for maintaining uniform flow. Disruptions cannot be dissipated readily, often causing queues to form and service to deteriorate to LOS F. For the majority of multilane highways with FFS between 70 and 100 km/h, passenger-car mean speeds at capacity range from 68 to 88 km/h but are highly variable and unpredictable.

LOS F represents forced or breakdown flow. It occurs either when vehicles arrive at a rate greater than the rate at which they are discharged or when the forecast demand exceeds the computed capacity of a planned facility. Although operations at these points—and on sections immediately downstream—appear to be at capacity, queues form behind these breakdowns. Operations within queues are highly unstable, with vehicles experiencing brief periods of movement followed by stoppages. Travel speeds within queues are generally less than 48 km/h. Note that the term LOS F may be used to characterize both the point of the breakdown and the operating condition within the queue.

Although the point of breakdown causes the queue to form, operations within the queue generally are not related to deficiencies along the highway segment.

REQUIRED INPUT DATA AND ESTIMATED VALUES

Exhibit 12-3 lists the default values that may be used for input parameters in the absence of local data. However, taking field measurements for use as inputs to an analysis is the most reliable means of generating parameter values. Only when this is not feasible should default values be considered.

Lane Width and Lateral Clearance

Field inspection, aerial photos, as-built plans, and local highway operating agency policies are sources of information for existing facilities. The standard lane width for new highway construction in the United States is 3.6 m. The standard shoulder width is 1.8 m (6). These standards may be reduced to accommodate special historical, environmental, or topographical constraints. In Canada, the standard lane width is 3.7 m.

Default values of 3.6 m for lane widths and 1.8 m for lateral clearance may be used in the absence of field data or local data. If lane widths vary within a segment, either the segment should be split into subsegments of uniform widths or the distance-weighted average of the lane widths should be computed and used to determine the effects on FFS.

For a detailed discussion of flow breakdown on uninterrupted-flow facilities, see Chapter 13, "Freeway Concepts"

EXHIBIT 12-3. REQUIRED INPUT DATA FOR MULTILANE HIGHWAYS

Required Data	Default
Geometric Data	
Number of lanes	-
Lane width	3.6 m
Lateral clearance	1.8 m
Median (Yes/No)	-
Access-point density	Exhibit 12-4
Specific grade or general terrain	Level
Base FFS	100 km/h
Demand	
Length of analysis period	15 min
PHF	0.88 rural, 0.92 urban
Heavy vehicles (%)	10% rural, 5% urban
Driver population factor	1.00

The same weighted averaging method may be used if there are only minor variations in lane width within a segment, or for varying shoulder or median widths. However, if variations in lane or shoulder widths extend for 760 m or more, the segment should be divided into shorter segments with consistent physical features.

Median

Either a divided or undivided highway must be selected for analysis. In estimating FFS, there is no distinction among two-way left-turn lanes, unpaved medians, landscaped medians, and medians with barriers—all are considered divided highways. An undivided highway has an FFS about 3 km/h slower than that of a divided highway. The FFS affects the facility’s estimated capacity.

Access-Point Density

Access-point density is the total number of active intersections and driveways on the right side of the road divided by the length of the facility. The density should be averaged over a minimum of 5 km if data are available. In the absence of local data, default values from Exhibit 12-4 may be used.

EXHIBIT 12-4. DEFAULT ACCESS-POINT DENSITY

Development Type	Default Value	Access Points/km (one side)
Rural	5	0–6
Low-Density Suburban	10	7–12
High-Density Suburban	15	≥ 13

Specific Grade or General Terrain

The general terrain type can be used instead of the specific grade, if there is no single grade on the segment that extends for more than 1.6 km or that exceeds 3 percent for more than 0.8 km.

The maximum extended grade for rural highways ranges between 5 percent and 8 percent (6) in mountainous terrain. Lower maximum grades of 3 percent to 5 percent are specified for highways in level terrain. The higher grades within each range typify lower-speed facilities with FFS less than 80 km/h.

If field measurement is not possible, and construction plans are not available, extended grades can be approximated using the analyst’s general knowledge of the local

terrain. In the absence of local data, default values of 3 percent may be used for an extended grade in otherwise level terrain, 5 percent for an extended grade in rolling terrain, and 7 percent for an extended grade in mountainous terrain.

Base FFS

If field measurements are unavailable, FFS can be estimated by applying adjustments to a base FFS. A base FFS of 100 km/h may be used for a rural or a suburban multilane highway. The base FFS must be reduced to account for the effects of lateral clearance at the shoulder and median, median type, lane width, and density of access points.

Length of Analysis Period

The planning, design, and analysis policies, and the available resources of an agency will determine the length of the analysis period or periods. The analyst may want to evaluate the peak hours occurring during the morning commute, midday, and evening commute on a typical weekday, or perhaps a peak hour during a Saturday or Sunday if the roadway segment carries a high volume of weekend recreational traffic. Within each hour analyzed, the highest 15-min volume is of primary interest. A PHF is applied to convert the hourly volume to a peak 15-min flow rate. Chapter 8 describes a procedure to compute peak direction and peak-hour demand from an average daily traffic volume.

PHF

The ratio of hourly demand to four times the peak 15-min demand typically ranges from 0.75 to 0.95. The higher values tend to occur as demand approaches capacity on the facility. Default values of 0.88 for rural areas and 0.92 for urban areas may be used in the absence of local data.

Percentage of Heavy Vehicles

The local Highway Performance Management System (HPMS) may be used to obtain local information on the percentage of heavy vehicles by facility and area type. If the relative proportions of RVs, trucks, and buses are not known, the heavy vehicles can be considered trucks when determining passenger-car equivalents and computing the heavy-vehicle adjustment factor. In the absence of local data, a default value of 5 percent heavy vehicles—including all types—may be used for urban areas, and 10 percent for rural areas.

Driver Population Factor

The reciprocal of the driver population factor is used to increase the flow rate to account for a driver population not familiar with the multilane highway. The factor should normally be 1.00 but can be reduced to 0.85 for the analysis of weekend conditions in a recreational area.

SERVICE VOLUME TABLE

Exhibit 12-5 can be used to estimate the number of lanes required to provide a desired LOS for default conditions. The impact of different FFS, the truck percentage, and the type of terrain also can be determined from this exhibit.

EXHIBIT 12-5. EXAMPLE SERVICE VOLUMES FOR MULTILANE HIGHWAYS
(SEE FOOTNOTE FOR ASSUMED VALUES)

FFS (km/h)	Number of Lanes	Terrain	Service Volumes (veh/h)				
			A	B	C	D	E
100	2	Level	1200	1880	2700	3450	4060
		Rolling	1140	1800	2570	3290	3870
		Mountainous	1040	1640	2350	3010	3540
	3	Level	1800	2830	4050	5180	6100
		Rolling	1710	2700	3860	4940	5810
		Mountainous	1570	2470	3530	4520	5320
80	2	Level	960	1510	2190	2920	3520
		Rolling	910	1440	2090	2790	3360
		Mountainous	830	1310	1910	2550	3070
	3	Level	1440	2260	3290	4390	5290
		Rolling	1370	2160	3140	4180	5040
		Mountainous	1250	1970	2870	3830	4610

Notes:

Assumptions: highway with 100-km/h FFS has 5 access points/km; highway with 80-km/h FFS has 15 access points/km; lane width = 3.6 m; shoulder width > 1.8 m; divided highway; PHF = 0.88; 5 percent trucks; and regular commuters.

This table contains approximate values. It is meant for illustrative purposes only. The values are highly dependent on the assumptions and should not be used for operational analyses or final design. This table was derived from the assumed values listed in the footnote.

III. TWO-LANE HIGHWAYS

A two-lane highway is an undivided roadway with two lanes, one for use by traffic in each direction. Passing a slower vehicle requires use of the opposing lane as sight distance and gaps in the opposing traffic stream permit. As volumes and geometric restrictions increase, the ability to pass decreases and platoons form. Motorists in platoons are subject to delay because they are unable to pass. Illustration 12-9 shows a typical view of a two-lane, two-way rural highway.



ILLUSTRATION 12-9. Typical two-lane, two-way highway in a rural environment.

Two-lane highways are a key element in the highway systems of most countries. They perform a variety of functions, are located in all geographic areas, and serve a wide range of traffic. Any consideration of operating quality must account for these disparate functions.

Traffic operations on two-lane, two-way highways differ from those on other uninterrupted-flow facilities. Lane changing and passing are possible only in the face of oncoming traffic in the opposing lane. Passing demand increases rapidly as traffic volumes increase, and passing capacity in the opposing lane declines as volumes increase. Therefore, on two-lane highways, unlike other types of uninterrupted-flow facilities, normal traffic flow in one direction influences flow in the other direction. Motorists must adjust their travel speeds as volume increases and the ability to pass declines.

Efficient mobility is the principal function of major two-lane highways that connect major traffic generators or that serve as primary links in state and national highway networks. These routes tend to serve long-distance commercial and recreational travelers, and long sections may pass through rural areas without traffic-control interruptions. Consistent high-speed operations and infrequent passing delays are desirable for these facilities.

Other paved, two-lane rural highways serve for accessibility. They provide all-weather access to an area, often for relatively low traffic volumes. Cost-effective access is the dominant consideration. Although beneficial, high speed is not the principal concern. Delay—as indicated by the formation of platoons—is more relevant as a measure of service quality.

Two-lane roads also serve scenic and recreational areas in which the vista and environment are meant to be experienced and enjoyed without traffic interruption or delay. A safe roadway is desired, but high-speed operation is neither expected nor desired. For these reasons, there are two performance measures to describe service quality for two-lane highways: percent time-spent-following and average travel speed.

Percent time-spent-following represents the freedom to maneuver and the comfort and convenience of travel. It is the average percentage of travel time that vehicles must travel in platoons behind slower vehicles due to the inability to pass. Percent time-spent-following is difficult to measure in the field. However, the percentage of vehicles traveling with headways of less than 3 s at a representative location can be used as a surrogate measure.

Average travel speed reflects the mobility on a two-lane highway: it is the length of the highway segment divided by the average travel time of all vehicles traversing the segment in both directions during a designated interval.

LOS criteria use both these performance measures. On major two-lane highways, for which efficient mobility is paramount, both percent time-spent-following and average travel speed define LOS. However, roadway alignments with reduced design speeds will limit the LOS that can be achieved. On highways for which accessibility is paramount and mobility less critical, LOS is defined only in terms of percent time-spent-following, without consideration of average travel speed.

CLASSIFICATION OF TWO-LANE HIGHWAYS

Two-lane highways are categorized into two classes for analysis:

- Class I—These are two-lane highways on which motorists expect to travel at relatively high speeds. Two-lane highways that are major intercity routes, primary arterials connecting major traffic generators, daily commuter routes, or primary links in state or national highway networks generally are assigned to Class I. Class I facilities most often serve long-distance trips or provide connecting links between facilities that serve long-distance trips.

- Class II—These are two-lane highways on which motorists do not necessarily expect to travel at high speeds. Two-lane highways that function as access routes to Class I facilities, serve as scenic or recreational routes that are not primary arterials, or pass through rugged terrain generally are assigned to Class II. Class II facilities most often serve relatively short trips, the beginning and ending portions of longer trips, or trips for which sightseeing plays a significant role.

Percent time-spent-following defined

Car-following criterion is 3 s

Average travel speed defined

Class I highways

Class II highways

The classes of two-lane roads closely relate to their functions—most arterials are considered Class I, and most collectors and local roads are considered Class II. However, the primary determinant of a facility's classification in an operational analysis is the motorist's expectations, which might not agree with the functional classification. For example, an intercity route that passes through rugged mountainous terrain might be described as Class II instead of Class I if motorists recognize that a high-speed route is not feasible in that corridor.

The LOS for Class I highways on which efficient mobility is paramount is defined in terms of both percent time-spent-following and average travel speed. On Class II highways, mobility is less critical, and LOS is defined only in terms of percent time-spent-following. Drivers generally tolerate higher levels of percent time-spent-following on a Class II facility than on a Class I facility, because Class II highways usually serve shorter trips and different trip purposes.

BASE CONDITIONS

The base conditions for a two-lane highway are the absence of restrictive geometric, traffic, or environmental factors. Base conditions are not the same as typical or default conditions. The methodology in Chapter 20 accounts for the effects of geometric, traffic, or environmental conditions that are more restrictive than the base conditions. The base conditions include

- Lane widths greater than or equal to 3.6 m;
- Clear shoulders wider than or equal to 1.8 m;
- No no-passing zones;
- All passenger cars;
- No impediments to through traffic, such as traffic control or turning vehicles; and
- Level terrain.

For the analysis of two-way flow (i.e., both directions), a 50/50 directional split of traffic is also considered a base condition. Most directional distribution on rural two-lane highways ranges from 50/50 to 70/30. On recreational routes, the directional distribution may be as high as 80/20 or more during holiday or other peak periods. Some variation in speed and percent time-spent-following occurs with changing directional distribution and volume. For directional analysis (i.e., separate analysis of each direction), directional distribution is not a base condition.

Traffic can operate ideally only if lanes and shoulders are wide enough not to constrain speeds. Lane and shoulder widths less than the base values of 3.6 m and 1.8 m, respectively, are likely to reduce speeds and may increase percent time-spent-following.

The frequency of no-passing zones is used to characterize roadway design and to analyze expected traffic conditions along a two-lane highway. A no-passing zone is any zone marked for no passing or any section of road with a passing sight distance of 300 m or less. The average percentage of no-passing zones in both directions along a section is used for the analysis of two-way flow. The percentage of no-passing zones for a particular direction of travel is used in directional analysis.

No-passing zones typically range from 20 to 50 percent of a rural two-lane highway. Values approaching 100 percent can be found on sections of winding, mountainous roads. No-passing zones have a greater effect in mountainous terrain than in level or rolling terrain. Heavy platoon formation along a highway section also can cause greater-than-expected operational problems on an adjacent downstream section with restricted passing opportunities.

BASIC RELATIONSHIPS

Exhibit 12-6 shows the relationship of flow rate, average travel speed, and percent time-spent-following for base conditions on an extended two-way facility (7).

Highway geometric features include a general description of longitudinal section characteristics and specific roadway cross-section information. Longitudinal section

For Class I highways, two criteria define LOS: percent time-spent-following and average travel speed. For Class II highways, LOS is based only on percent time-spent-following.

No-passing zone

The sight distance value of 300 m is equivalent to that used by the Manual on Uniform Traffic Control Devices for passing and no-passing zones on highways with an 85th-percentile speed of 90 km/h

characteristics are described by the average percentage of the highway with no-passing zones in either direction. Roadway cross-section data include lane width and usable shoulder width. Geometric data and design speed are considered in estimating the FFS.

EXHIBIT 12-6. SPEED-FLOW AND PERCENT TIME-SPENT-FOLLOWING FLOW RELATIONSHIPS FOR TWO-WAY SEGMENTS WITH BASE CONDITIONS

Analysis of two-way flow usually is performed on extended lengths; but directional analysis is applied to relatively short, uniform segments

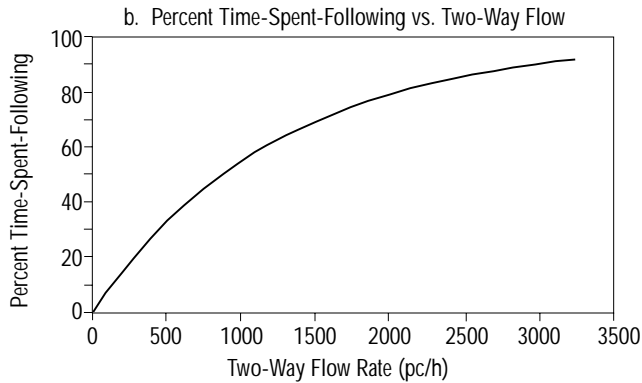
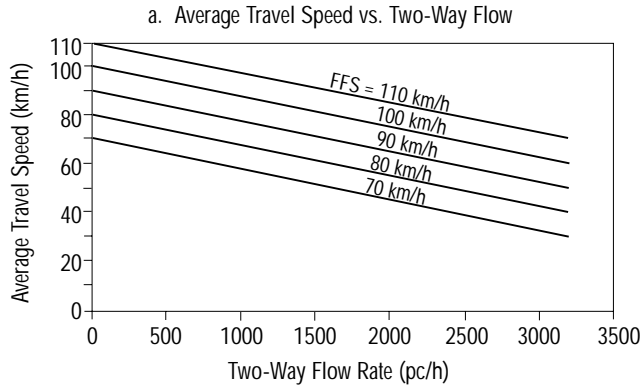

Two-way segments and directional segments

Two-lane highways can be analyzed either as two-way segments obtaining traffic performance measures for both directions of travel combined, or as directional segments, with each direction of travel considered separately. Separate analysis by direction is appropriate for steep grades and for segments with passing lanes.

Exhibit 12-7 illustrates the relationship of flow rate, average travel speed, and percent time-spent-following for base conditions of a directional segment of a two-way facility (7). These relationships are conceptually analogous to the relationships for the two-way segments in Exhibit 12-6; however, the relationships for directional segments incorporate the effect of the opposing flow rate on the average travel speed and percent time-spent-following. In Exhibit 12-7(a), the y-intercept represents the FFS in the analysis direction, incorporating the effect of the demand flow rate in the opposing direction. Exhibit 12-7(b) graphs the relationships between directional flow rate and percent time-spent-following when opposing flow rates range from 200 to 1,600 pc/h.

EXHIBIT 12-7. SPEED-FLOW AND PERCENT TIME-SPENT-FOLLOWING FLOW RELATIONSHIPS FOR DIRECTIONAL SEGMENTS WITH BASE CONDITIONS

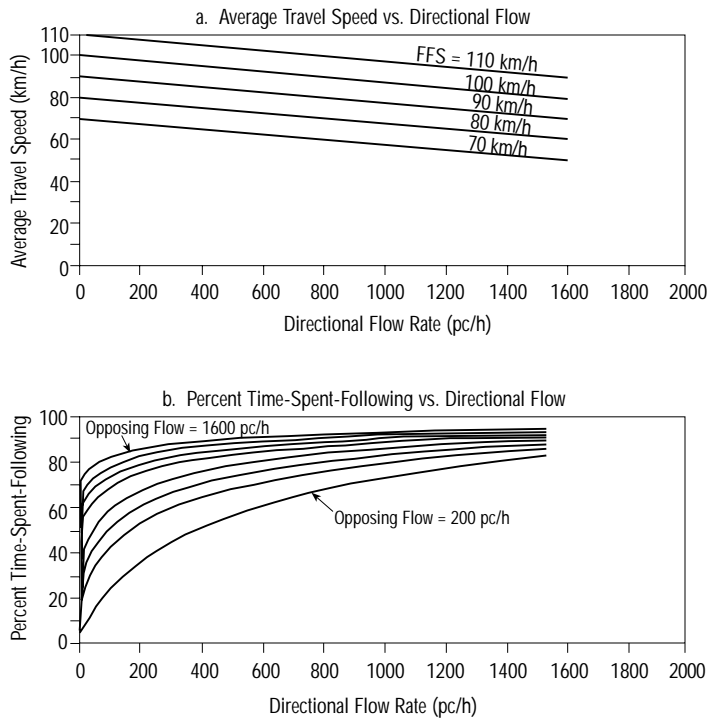

PASSING LANES ON TWO-LANE HIGHWAYS

A passing lane is a lane added in one direction of travel on a conventional two-lane highway to improve opportunities for passing. The addition of a passing lane to a two-lane highway provides a three-lane cross section with two lanes in one direction of travel and one lane in the other. Exhibit 12-8 illustrates a typical passing lane on a two-lane highway. Depending on local practice, traffic in the opposing direction may be prohibited from passing or may be permitted to pass if adequate sight distance is available, as shown in Exhibit 12-8. On some two-lane highways, passing lanes are provided intermittently or at intervals for each direction of travel. On other highways, added passing lanes alternate continuously between the two directions of travel. Passing lanes also can be provided in both directions of travel at the same location, resulting in a short section of four-lane undivided highway with improved passing opportunities in both directions.

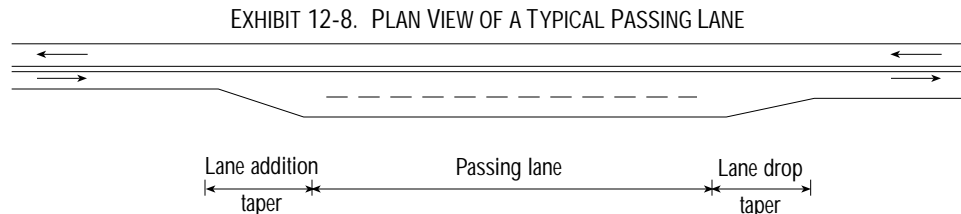

LOS

The primary measures of service quality for Class I two-lane highways are percent time-spent-following and average travel speed. For Class II two-lane highways, service

quality is based only on percent time-spent-following. LOS criteria are defined for peak 15-min flow periods and are intended for application to segments of significant length.

LOS A describes the highest quality of traffic service, when motorists are able to travel at their desired speed. Without strict enforcement, this highest quality would result in average speeds of 90 km/h or more on two-lane highways in Class I. The passing frequency required to maintain these speeds has not reached a demanding level, so that passing demand is well below passing capacity, and platoons of three or more vehicles are rare. Drivers are delayed no more than 35 percent of their travel time by slow-moving vehicles. A maximum flow rate of 490 pc/h total in both directions may be achieved with base conditions. On Class II highways, speeds may fall below 90 km/h, but motorists will not be delayed in platoons for more than 40 percent of their travel time.

LOS B characterizes traffic flow with speeds of 80 km/h or slightly higher on level-terrain Class I highways. The demand for passing to maintain desired speeds becomes significant and approximates the passing capacity at the lower boundary of LOS B. Drivers are delayed in platoons up to 50 percent of the time. Service flow rates of 780 pc/h total in both directions can be achieved under base conditions. Above this flow rate, the number of platoons increases dramatically. On Class II highways, speeds may fall below 80 km/h, but motorists will not be delayed in platoons for more than 55 percent of their travel time.

LOS C describes further increases in flow, resulting in noticeable increases in platoon formation, platoon size, and frequency of passing impediments. The average speed still exceeds 70 km/h on level-terrain Class I highways, even though unrestricted passing demand exceeds passing capacity. At higher volumes the chaining of platoons and significant reductions in passing capacity occur. Although traffic flow is stable, it is susceptible to congestion due to turning traffic and slow-moving vehicles. Percent time-spent-following may reach 65 percent. A service flow rate of up to 1,190 pc/h total in both directions can be accommodated under base conditions. On Class II highways, speeds may fall below 70 km/h, but motorists will not be delayed in platoons for more than 70 percent of their travel time.

LOS D describes unstable traffic flow. The two opposing traffic streams begin to operate separately at higher volume levels, as passing becomes extremely difficult. Passing demand is high, but passing capacity approaches zero. Mean platoon sizes of 5 to 10 vehicles are common, although speeds of 60 km/h still can be maintained under base conditions on Class I highways. The proportion of no-passing zones along the roadway section usually has little influence on passing. Turning vehicles and roadside distractions cause major shock waves in the traffic stream. Motorists are delayed in platoons for nearly 80 percent of their travel time. Maximum service flow rates of 1,830 pc/h total in both directions can be maintained under base conditions. On Class II highways, speeds may fall below 60 km/h, but in no case will motorists be delayed in platoons for more than 85 percent of their travel time.

At LOS E, traffic flow conditions have a percent time-spent-following greater than 80 percent on Class I highways and greater than 85 percent on Class II. Even under base conditions, speeds may drop below 60 km/h. Average travel speeds on highways with less than base conditions will be slower, even down to 40 km/h on sustained upgrades. Passing is virtually impossible at LOS E, and platooning becomes intense, as slower vehicles or other interruptions are encountered.

The highest volume attainable under LOS E defines the capacity of the highway, generally 3,200 pc/h total in both directions. Operating conditions at capacity are unstable and difficult to predict. Traffic operations seldom reach near capacity on rural highways, primarily because of a lack of demand.

LOS F represents heavily congested flow with traffic demand exceeding capacity. Volumes are lower than capacity and speeds are highly variable.

REQUIRED INPUT DATA AND ESTIMATED VALUES

Exhibit 12-9 lists default values for input parameters that may be used in the absence of local data. However, taking field measurements for use as inputs to an analysis is the most reliable means of generating parameter values. Only when this is not feasible should the default values be considered.

EXHIBIT 12-9. REQUIRED INPUT DATA: TWO-LANE HIGHWAYS

Required Data	Default
Geometric Data	
Highway class	Exhibit 12-10
Lane width	3.6 m
Shoulder width	1.8 m
Access-point density	Exhibit 12-4
Specific grade or general terrain	Level
Percent no-passing	Exhibit 12-11
Base FFS	-
Length of passing lane	Exhibit 12-12
Demand	
Length of analysis period	15 min
PHF	0.88 rural, 0.92 urban
Directional split	Exhibit 12-13
Heavy vehicles percentages	Exhibit 12-14

Highway Classes

Two-lane highways are categorized into two classes. The general description of these classes is summarized in Exhibit 12-10.

EXHIBIT 12-10. SUMMARY OF TWO-LANE HIGHWAY CLASSES

Class	Description
I	Highways on which motorists expect to travel at relatively high speeds, including major intercity routes, primary arterials, and daily commuter routes
II	Highways on which motorists do not necessarily expect to travel at high speeds, including access routes, scenic and recreational routes that are not primarily arterials, and routes through rugged terrain

Lane Width and Shoulder Width

Refer to the description of lane width and lateral clearance under the required input data and estimated values for multilane highways.

Access-Point Density

Refer to the description of access-point density under the required input data and estimated values for multilane highways.

Specific Grade or General Terrain

Refer to the description of specific grade or general terrain under the required input data and estimated values for multilane highways.

Percentage of No-Passing Zones

The percentage of each segment length in which passing is prohibited should be estimated from local data. In the absence of such data, Exhibit 12-11 may be used.

EXHIBIT 12-11. DEFAULT VALUES FOR PERCENTAGE OF NO-PASSING ZONES

Terrain Type	No-Passing Zones (%)
Level	20
Rolling	50
Mountainous	80

Base FFS

The base FFS for a two-lane highway is observed at base conditions and ranges from 70 to 110 km/h, depending on the highway’s characteristics.

Length of Passing Lane

Passing lanes on two-lane highways range in length from 0.3 to 5.0 km (8). Research has shown that the optimal lengths for passing lanes range from 0.8 to 3.2 km, depending on the traffic flow rate, as shown in Exhibit 12-12.

EXHIBIT 12-12. OPTIMAL LENGTHS OF PASSING LANES

Directional Flow Rate (pc/h)	Optimal Passing Lane Length (km)
100	≤ 0.80
200	> 0.80–1.20
400	> 1.20–1.60
≥ 700	> 1.60–3.20

Source: Harwood and St. John (8).

Length of Analysis Period

Refer to the description of the length of analysis period under the required data and estimated values for multilane highways.

PHF

When feasible, the PHF should be determined from local field data. If field data are not available, the factors presented in Exhibit 12-9 may be used for two-way and directional two-lane highway analysis. In general, lower PHFs are typical of rural or off-peak conditions, but higher PHFs are typical of urban or suburban peak-hour conditions. Default PHF values of 0.88 for rural areas and 0.92 for urban areas may be used in the absence of local data.

Directional Split

Directional distribution is defined as 50/50 for base conditions. Most directional distributions on rural two-lane highways range from 50/50 to 70/30. On recreational routes, the directional distribution may be as high as 80/20 or more during holiday or other peak periods. Exhibit 12-13 lists default directional splits that may be used if field-observed data are not available.

EXHIBIT 12-13. DEFAULT VALUES FOR DIRECTIONAL SPLIT ON TWO-LANE HIGHWAYS

Type	Directional Split
Rural Highways	60/40
Urban Highways	60/40
Recreational Highways	80/20

Percentage of Heavy Vehicles

The local HPMS may be used to obtain local information on the percentage of heavy vehicles by facility and area type. When estimates of the traffic mix are not available,

Exhibit 12-14 presents default values that may be used for primary routes. Recreational routes typically would have a higher proportion of RVs and often a lower proportion of trucks than shown in Exhibit 12-14.

EXHIBIT 12-14. DEFAULT HEAVY-VEHICLE PERCENTAGES ON TWO-LANE HIGHWAYS

Type of Heavy Vehicle	Rural (%)	Urban (%)
Trucks (including buses)	14	2
RVs	4	0

SERVICE VOLUME TABLE

An example service volume table for Class I highways is provided in Exhibit 12-15. From the exhibit, the hourly volume that can be accommodated at a given LOS, terrain, and FFS can be determined under specified conditions.

EXHIBIT 12-15. EXAMPLE SERVICE VOLUMES FOR A CLASS I TWO-LANE RURAL HIGHWAY
(SEE FOOTNOTE FOR ASSUMED VALUES)

FFS (km/h)	Terrain	Service Volumes (veh/h)				
		A	B	C	D	E
110	Level	260	490	900	1570	2680
	Rolling	130	260	710	1490	2500
	Mountainous	40	160	310	610	1410
100	Level	260	490	900	1570	2680
	Rolling	130	260	710	1490	2500
	Mountainous	40	160	310	510	1410
90	Level	N/A	490	900	1570	2680
	Rolling	N/A	260	710	1490	2500
	Mountainous	N/A	160	310	510	1410
80	Level	N/A	N/A	490	1420	2680
	Rolling	N/A	N/A	280	1100	2500
	Mountainous	N/A	N/A	180	870	1410
70	Level	N/A	N/A	N/A	490	2680
	Rolling	N/A	N/A	N/A	280	2500
	Mountainous	N/A	N/A	N/A	180	1410

Note:
 Assumptions: 60/40 directional split; 20-, 40-, and 60-percent no-passing zones for level, rolling, and mountainous terrain, respectively; 14 percent trucks; and 4 percent RVs.
 N/A = not achievable for the given condition
 Source: Harwood et al. (7).

This table contains approximate values and is meant for illustrative purposes only. The values depend on the assumptions and should not be used for operational analyses or final design. This table was derived using assumed values listed in the footnote.

IV. REFERENCES

1. Reilly, W., D. Harwood, J. Schoen, and M. Holling. *Capacity and LOS Procedures for Rural and Urban Multilane Highways*. NCHRP Project 3-33 Final Report, JHK & Associates, Tucson, Ariz., May 1990.
2. Tignor, S.C. *Driver Speed Behavior on U.S. Streets and Highways*. Compendium of Technical Papers, Institute of Transportation Engineers, August 5–8, 1990.
3. Hool, J. N., S. Maghsoodloo, A. D. Veren, and D. D. Brown. Analysis of Selective Enforcement Strategy Effects on Rural Alabama Traffic Speeds. In *Transportation Research Record 910*, TRB, National Research Council, Washington, D.C., 1983, pp. 74–81.

4. Armour, M. The Effect of Police Presence on Urban Driving Speeds. *Australia Road Research*, Vol. 14, No. 3, Sept. 1984, pp. 142–148.
5. Hauer, E., and F. J. Ahlin. Speed Enforcement and Speed Choice. *Accident Analysis and Prevention*, Vol. 14, No. 4, 1982, pp. 267–278.
6. American Association of State Highway and Transportation Officials. *A Policy on Geometric Design of Highways and Streets*. Washington, D.C., 1990.
7. Harwood, D. W., A. D. May, I. B. Anderson, L. Leiman, and A. R. Archilla. *Capacity and Quality of Service of Two-Lane Highways*. Final Report, NCHRP Project 3-55(3), Midwest Research Institute, 1999 (forthcoming).
8. Harwood, D. W., and A. D. St. John. *Operational Effectiveness of Passing Lanes on Two-Lane Highways*. Report No. FHWA/RD-86/196, FHWA, U.S. Department of Transportation, Washington, D.C., 1986.

CHAPTER 13

FREEWAY CONCEPTS

CONTENTS

I.	INTRODUCTION	13-1
II.	BASIC FREEWAY SEGMENTS	13-1
	Freeway Capacity Terms	13-2
	Flow Characteristics	13-2
	Speed-Flow and Density-Flow Relationships	13-3
	Queue Discharge and Oversaturation	13-5
	Factors Affecting FFS	13-5
	Lane Width and Lateral Clearance	13-5
	Number of Lanes	13-6
	Interchange Density	13-6
	Other Factors	13-6
	Passenger-Car Equivalents	13-7
	Driver Population	13-7
	LOS	13-8
	Required Input Data and Estimated Values	13-11
	Lane Width and Lateral Clearance	13-11
	Interchange Density	13-11
	Specific Grade or General Terrain	13-11
	Base FFS and FFS	13-12
	Length of Analysis Period	13-12
	Peak-Hour Factor	13-12
	Heavy Vehicles	13-12
	Driver Population	13-12
	Service Volume Table	13-12
III.	FREEWAY WEAVING	13-13
	Weaving Configurations	13-14
	Type A Weaving Configuration	13-14
	Type B Weaving Configuration	13-15
	Type C Weaving Configuration	13-16
	Effects of Weaving Configuration	13-17
	Weaving Length	13-17
	Weaving Width	13-18
	Type of Operation	13-18
	Service Volume Table	13-20
IV.	RAMPS AND RAMP JUNCTIONS	13-20
	Ramp Components	13-20
	Operational Characteristics	13-21
	Important Parameters	13-22
	Capacity of Merge and Diverge Areas	13-22
	LOS	13-23
	Required Input Data and Estimated Values	13-24
	Ramp Lanes	13-24
	Length of Acceleration/Deceleration Lane	13-24
	Ramp FFS	13-24
	Length of Analysis Period	13-24
	PHF	13-25
	Percentage of Heavy Vehicles	13-25

Driver Population Factor	13-25
Service Volume Table	13-25
V. FREEWAY FACILITIES	13-26
Traffic Management Strategies	13-27
Freeway Traffic Management Process	13-27
Freeway Management Strategies	13-27
Capacity Management Strategies	13-28
Demand Management Strategies	13-28
Performance Measures	13-29
VI. REFERENCES	13-30

EXHIBITS

Exhibit 13-1. Example of Basic Freeway Segment	13-2
Exhibit 13-2. Speed-Flow Relationships for Basic Freeway Segments	13-3
Exhibit 13-3. Density-Flow Relationships for Basic Freeway Segments	13-4
Exhibit 13-4. Queue Discharge and Oversaturation	13-5
Exhibit 13-5. Required Input Data and Default Values for Basic Freeway Segments	13-11
Exhibit 13-6. Example Service Volumes for Basic Freeway Segments	13-13
Exhibit 13-7. Formation of a Weaving Segment	13-14
Exhibit 13-8. Type A Weaving Segments	13-15
Exhibit 13-9. Type B Weaving Segments	13-16
Exhibit 13-10. Type C Weaving Segments	13-17
Exhibit 13-11. Measuring the Length of a Weaving Segment	13-18
Exhibit 13-12. Maximum Use of Lanes by Weaving Vehicles	13-19
Exhibit 13-13. Example Service Volumes for Freeway Weaving Segments	13-20
Exhibit 13-14. On- and Off-Ramp Influence Areas	13-21
Exhibit 13-15. Capacity of Merge Areas	13-23
Exhibit 13-16. Capacity of Diverge Areas	13-23
Exhibit 13-17. Required Input Data and Default Values	13-24
Exhibit 13-18. Acceleration Lane Length Diagram	13-25
Exhibit 13-19. Deceleration Lane Length Diagram	13-25
Exhibit 13-20. Example Service Volumes for Single-Lane On- and Off-Ramps	13-26
Exhibit 13-21. Freeway Facility Segments	13-26

I. INTRODUCTION

In this chapter capacity and quality-of-service concepts for freeways are introduced. This chapter can be used in conjunction with the methodologies of Chapter 22 (Freeway Facilities), Chapter 23 (Basic Freeway Segments), Chapter 24 (Freeway Weaving), and Chapter 25 (Ramps and Ramp Junctions).

A freeway is defined as a divided highway with full control of access and two or more lanes for the exclusive use of traffic in each direction. Freeways provide uninterrupted flow. There are no signalized or stop-controlled at-grade intersections, and direct access to and from adjacent property is not permitted. Access to and from the freeway is limited to ramp locations. Opposing directions of flow are continuously separated by a raised barrier, an at-grade median, or a continuous raised median.

Operating conditions on a freeway primarily result from interactions among vehicles and drivers in the traffic stream and among vehicles, drivers, and the geometric characteristics of the freeway. Operations can also be affected by environmental conditions, such as weather or lighting, by pavement conditions, and by the occurrence of traffic incidents.

A tollway or toll road is similar to a freeway, except that tolls are collected at designated points along the facility. Although the collection of tolls usually involves interruptions of traffic, these facilities may generally be treated as freeways. However, special attention should be given to the unique characteristics, constraints, and delays caused by toll collection facilities.

The freeway system is the sum total of all freeway facilities in a given area. The analyst must realize that freeway facilities may have interactions with other freeway facilities as well as local streets and take care to consider interactions with these other facilities. The performance of the freeway may be affected when demand exceeds capacity on nearby parts of the local street or freeway system or when the capacity of the street or ramp metering system limits demand approaching the freeway.

If the street system cannot accommodate the demand exiting the freeway, the oversaturation of the street system may result in queues backing onto the freeway, which adversely affects freeway performance. In effect, the limited capacity of the street system reduces the effective capacity of the exit ramp. Therefore, whether the downstream street system capacity can accommodate the exiting freeway demand is an important factor in whether the freeway facility analysis reflects freeway performance. Likewise, the presence of ramp metering affects freeway demand and must be taken into consideration in analyzing a freeway facility.

Freeway facilities are also assumed to have no interaction with adjacent freeways. In reality, freeway facilities may have interactions with other freeway facilities, as they do with surface streets. Free-flow conditions must therefore exist upstream and downstream of the facility being analyzed. In other words, the analysis of a freeway facility can only address local oversaturation within its time-space domain, not systemwide effects outside of its time-space domain.

II. BASIC FREEWAY SEGMENTS

Basic freeway segments are outside of the influence area of ramps or weaving areas of the freeway. Exhibit 13-1 illustrates a basic freeway segment.

Freeway defined

Toll road as freeway

EXHIBIT 13-1. EXAMPLE OF BASIC FREEWAY SEGMENT

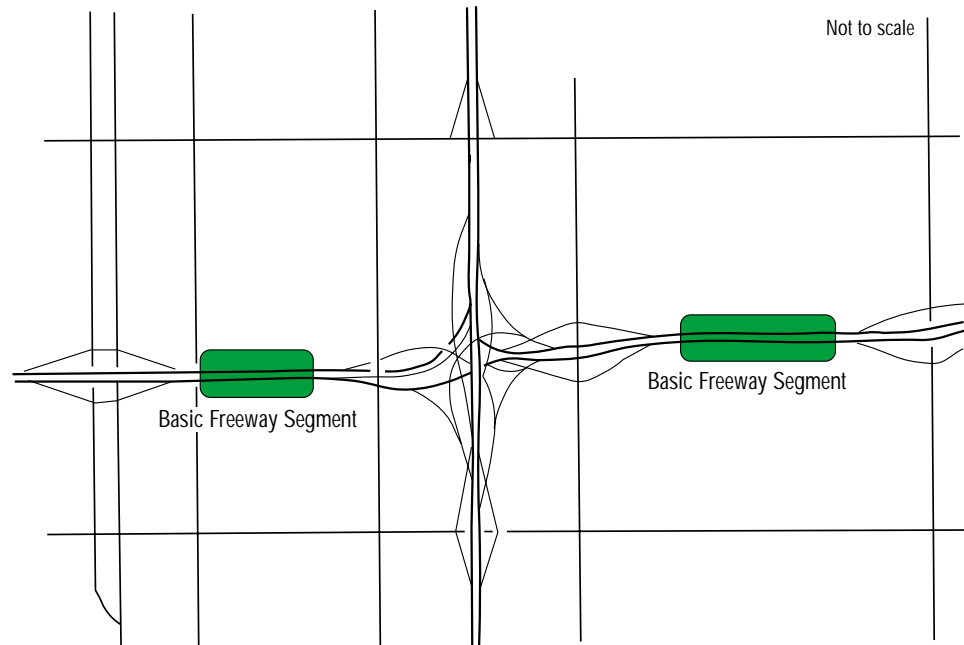

FREEWAY CAPACITY TERMS

- Freeway capacity: the maximum sustained 15-min flow rate, expressed in passenger cars per hour per lane, that can be accommodated by a uniform freeway segment under prevailing traffic and roadway conditions in one direction of flow.
- Traffic characteristics: any characteristic of the traffic stream that may affect capacity, free-flow speed, or operations, including the percentage composition of the traffic stream by vehicle type and the familiarity of drivers with the freeway.
- Roadway characteristics: the geometric characteristics of the freeway segment under study, including the number and width of lanes, right-shoulder lateral clearance, interchange spacing, vertical alignment, and lane configurations.
- Free-flow speed (FFS): the mean speed of passenger cars that can be accommodated under low to moderate flow rates on a uniform freeway segment under prevailing roadway and traffic conditions.
- Base conditions: an assumed set of geometric and traffic conditions used as a starting point for computations of capacity and level of service (LOS).

Capacity analysis is based on freeway segments with uniform traffic and roadway conditions. If any of the prevailing conditions change significantly, the capacity of the segment and its operating conditions change as well. Therefore, each uniform segment should be analyzed separately.

FLOW CHARACTERISTICS

Traffic flow within basic freeway segments can be highly varied depending on the conditions constricting flow at upstream and downstream bottleneck locations. Bottlenecks can be created by ramp merge and weaving segments, lane drops, maintenance and construction activities, accidents, and objects in the roadway. An incident does not have to block a travel lane to create a bottleneck. For example, disabled vehicles in the median or on the shoulder can influence traffic flow within the freeway lanes.

Freeway research has resulted in a better understanding of the characteristics of freeway flow relative to the influence of upstream and downstream bottlenecks. Traffic flow within a basic freeway segment can be categorized into three flow types: undersaturated, queue discharge, and oversaturated. Each flow type is defined within general speed-flow-density ranges, and each represents different conditions on the freeway.

- Undersaturated flow represents traffic flow that is unaffected by upstream or downstream conditions. This regime is generally defined within a speed range of 90 to 120 km/h at low to moderate flow rates and a range of 70 to 100 km/h at high flow rates.
- Queue discharge flow represents traffic flow that has just passed through a bottleneck and is accelerating back to the FFS of the freeway. Queue discharge flow is characterized by relatively stable flow as long as the effects of another bottleneck downstream are not present. This flow type is generally defined within a narrow range of 2,000 to 2,300 pc/h/ln, with speeds typically ranging from 55 km/h up to the FFS of the freeway segment. Lower speeds are typically observed just downstream of the bottleneck. Depending on horizontal and vertical alignments, queue discharge flow usually accelerates back to the FFS of the facility within 1 to 2 km downstream from the bottleneck. Studies suggest that the queue discharge flow rate from the bottleneck is lower than the maximum flows observed before breakdown. A typical value for this drop in flow rate is approximately 5 percent.
- Oversaturated flow represents traffic flow that is influenced by the effects of a downstream bottleneck. Traffic flow in the congested regime can vary over a broad range of flows and speeds depending on the severity of the bottleneck. Queues may extend several kilometers upstream from the bottleneck. Freeway queues differ from queues at intersections in that they are not static or “standing.” On freeways, vehicles move slowly through a queue, with periods of stopping and movement. Oversaturated flow is discussed further in the freeway facilities section of this chapter and in Chapter 22.

The three flow types on basic freeway segments are undersaturated, queue discharge, and oversaturated

Undersaturated flow defined

Queue discharge flow defined

Oversaturated flow defined

Speed-Flow and Density-Flow Relationships

Speed-flow and density-flow relationships for a typical basic freeway segment under either base conditions or non-base conditions in which FFS is known are shown in Exhibits 13-2 and 13-3 (1).

EXHIBIT 13-2. SPEED-FLOW RELATIONSHIPS FOR BASIC FREEWAY SEGMENTS

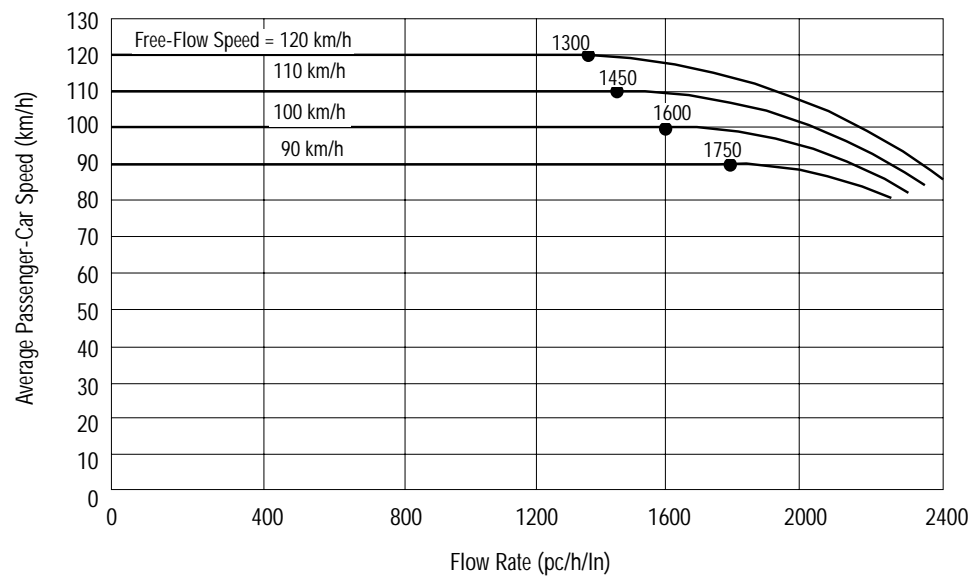
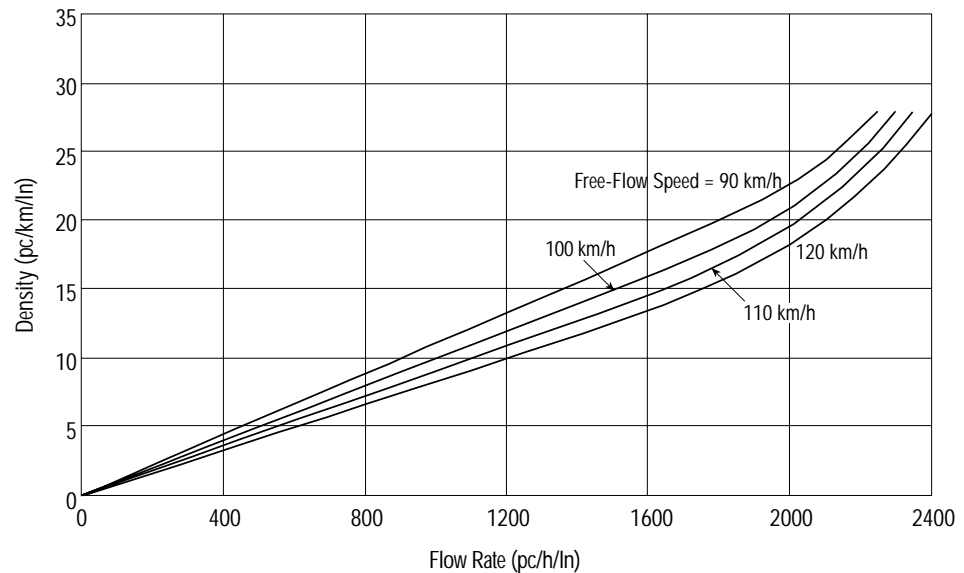

EXHIBIT 13-3. DENSITY-FLOW RELATIONSHIPS FOR BASIC FREEWAY SEGMENTS



All recent freeway studies indicate that speed on freeways is insensitive to flow in the low to moderate range. This is reflected in Exhibit 13-2, which shows speed to be constant for flows up to 1,300 pc/h/ln for a 120-km/h FFS. For lower free-flow speeds, the region over which speed is insensitive to flow extends to even higher flow rates. FFS is measured in the field as the average speed of passenger cars when flow rates are less than 1,300 pc/h/ln. Field determination of FFS is accomplished by performing travel time or spot speed studies during periods of low flows and low densities.

Although Exhibit 13-2 shows curves only for free-flow speeds of 120, 110, 100, and 90 km/h, a curve representing any FFS between 120 and 90 km/h can be defined by interpolation.

The research leading to these curves found that a number of factors affect free-flow speed (*f*). The factors include number of lanes, lane width, lateral clearance, and interchange density or spacing. Other factors believed to influence FFS, but for which little is known quantitatively, include horizontal and vertical alignment, speed limit, level of enforcement, lighting conditions, and weather.

Under base traffic and geometric conditions, freeways will operate with capacities as high as 2,400 pc/h/ln. This capacity is typically achieved on freeways with FFS of 120 km/h or greater. As the FFS decreases, there is a slight decrease in capacity. For example, the capacity of a basic freeway segment with a FFS of 90 km/h is expected to be approximately 2,250 pc/h/ln.

The average speed of passenger cars at flow rates that represent capacity is expected to range from 86 km/h (FFS of 120 km/h or greater) to 80 km/h for a segment with a 90-km/h FFS. Note that the higher the free-flow speed, the greater the drop in speed as flow rates move toward capacity. Thus, for a 120-km/h FFS, there is a 34-km/h drop from low-volume conditions to capacity conditions. The drop is only 10 km/h for a freeway with a 90-km/h FFS.

As indicated in Exhibit 13-2, the point at which an increase in flow rate begins to affect the average passenger car speed varies from 1,300 to 1,750 pc/h/ln. Speed will be reduced beginning at 1,300 pc/h/ln for freeway segments with free-flow speeds of 120 km/h. For lower-FFS facilities, the average speed begins to diminish at higher flow rates.

Interpolation is used to derive values between the curves

Queue Discharge and Oversaturation

Unlike free flow, queue discharge and congested flow have not been extensively studied, and these traffic flow types can be highly variable. However, freeway research performed since 1990 has provided valuable insight into possible speed-flow relationships that describe these two flow regimes. Exhibit 13-4 presents one suggested relationship and is displayed here for informational purposes only (2).

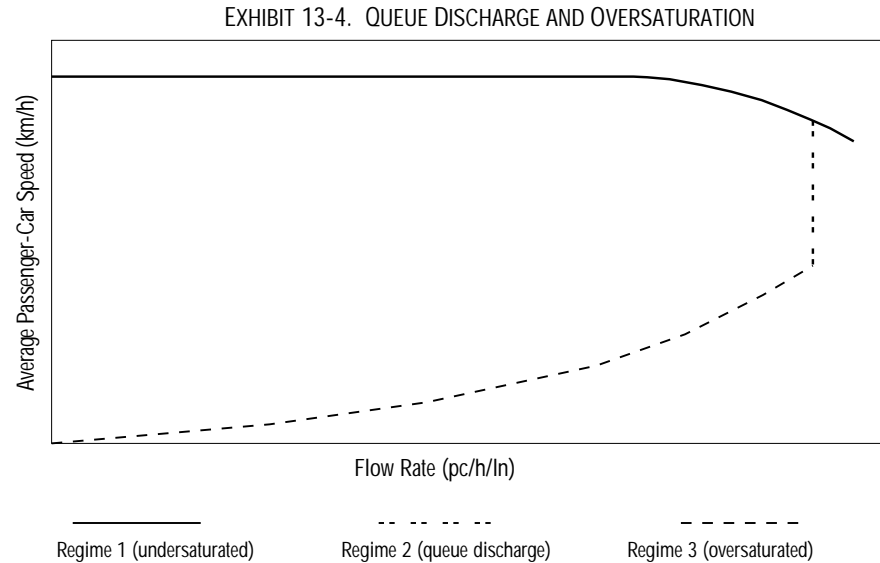

Source: Adapted from Hall et al. (2).

Analysts are cautioned that although the relationship in Exhibit 13-4 may provide a general predictive model for speed under queue discharge and oversaturated flows, it should be considered conceptual at best. Further research is needed to better define flow in these two regimes.

FACTORS AFFECTING FFS

The FFS of a freeway depends on traffic and roadway conditions. These conditions are described below.

Lane Width and Lateral Clearance

When lane widths are less than 3.6 m, drivers are forced to travel closer to one another laterally than they would normally desire. Drivers tend to compensate for this by reducing their travel speed.

The effect of restricted lateral clearance is similar. When objects are located too close to the edge of the median and roadside lanes, drivers in these lanes will shy away from them, positioning themselves further from the lane edge. This has the same effect as narrow lanes, which force drivers closer together laterally. Drivers compensate by reducing their speed. The closeness of objects has been found to have a greater effect on drivers in the rightmost travel lane than on those in the median lane.

Drivers in the median lane appear to be unaffected by lateral clearance when minimum clearance is 0.6 m, whereas drivers in the right (shoulder) lane are affected when lateral clearance is less than 1.8 m. Illustration 13-1 shows the influence of lane width and lateral clearance on lateral placement of vehicles. Illustration 13-2 shows a freeway segment considered to meet or exceed base conditions with respect to lane width and lateral clearance.

Lateral clearance is measured from edge of travel lane to curb, guardrail, or other physical obstruction

Note how vehicles shy away from both roadside and median barriers, driving as close to the lane marking as possible. The existence of narrow lanes compounds the problem, making it difficult for two vehicles to travel alongside each other.

This cross section illustrates base conditions of lane width and lateral clearance. The concrete median barrier does not cause vehicles to shift their lane position and therefore would not be considered an obstruction.

The horizontal and vertical geometry may influence free-flow speed



ILLUSTRATION 13-1.



ILLUSTRATION 13-2.

Number of Lanes

The number of lanes on a freeway segment influences FFS. As the number of lanes increases, so does the opportunity for drivers to position themselves to avoid slower-moving traffic. In typical freeway driving, traffic tends to be distributed across lanes according to speed. Traffic in the median lane typically moves faster than in the lane adjacent to the right shoulder. Thus, a four-lane freeway (two lanes in each direction) provides less opportunity for drivers to move around slower traffic than does a freeway with 6, 8, or 10 lanes. Decreased maneuverability tends to reduce the average speed of vehicles.

Interchange Density

Freeway segments with closely spaced interchanges, such as those in heavily developed urban areas, operate at lower FFS than suburban or rural freeways where interchanges are less frequent. The merging and weaving associated with interchanges affect the speed of traffic. Speeds generally decrease with increasing frequency of interchanges. The ideal average interchange spacing over a reasonably long section of freeway (8 to 10 km) is 3 km or greater. The minimum average interchange spacing considered possible over a substantial length of freeway is 1 km.

Other Factors

The design speed of the primary physical elements of a freeway can affect travel speed. In particular, the horizontal and vertical alignments may contribute to the FFS of a given freeway segment. If a freeway has significant horizontal or vertical conditions, the analyst is encouraged to determine FFS from field observation and field study.

PASSENGER-CAR EQUIVALENTS

The concept of vehicle equivalents is based on observations of freeway conditions in which the presence of heavy vehicles, including trucks, buses, and recreational vehicles (RVs), creates less than base conditions. The lesser conditions include longer and more frequent gaps of excessive length both in front of and behind heavy vehicles. Also, the speed of vehicles in adjacent lanes and their spacing may be affected by these generally slower-moving large vehicles. Finally, physical space taken up by a large vehicle is typically two to three times greater in terms of length than that taken up by a typical passenger car. To allow the analysis method for freeway capacity to be based on a consistent measure of flow, each heavy vehicle is converted into an equivalent number of passenger cars. The conversion results in a single value for flow rate in terms of passenger cars per hour per lane. The conversion factor used depends on the proportion of heavy vehicles in the traffic stream as well as the length and severity of the upgrade or downgrade.

Illustrations 13-3 and 13-4 show the effect of trucks and other heavy vehicles on freeway traffic.

DRIVER POPULATION

Studies have noted that noncommuter driver populations do not display the same characteristics as regular commuters. For recreational traffic, capacities have been observed to be as much as 10 to 15 percent lower than for commuter traffic traveling on the same segment, but FFS does not appear to be similarly affected. If the analyst elects to account for this possible effect, locally derived data should be obtained and used in the analysis.



ILLUSTRATION 13-3.



ILLUSTRATION 13-4.

Note the formation of large gaps in front of slow-moving trucks climbing the grade

Even on relatively level terrain, the development of large gaps in front of trucks or other heavy vehicles is common

LOS

Although speed is a major concern of drivers as related to service quality, freedom to maneuver within the traffic stream and proximity to other vehicles are equally noticeable concerns. These qualities are related to the density of the traffic stream. Unlike speed, density increases as flow increases up to capacity, resulting in a measure of effectiveness that is sensitive to a broad range of flows.

Operating characteristics for the six LOS are shown in Illustrations 13-5 through 13-10. The LOS are defined to represent reasonable ranges in the three critical flow variables: speed, density, and flow rate.

LOS A describes free-flow operations. Free-flow speeds prevail. Vehicles are almost completely unimpeded in their ability to maneuver within the traffic stream. The effects of incidents or point breakdowns are easily absorbed at this level.

LOS B represents reasonably free flow, and free-flow speeds are maintained. The ability to maneuver within the traffic stream is only slightly restricted, and the general level of physical and psychological comfort provided to drivers is still high. The effects of minor incidents and point breakdowns are still easily absorbed.

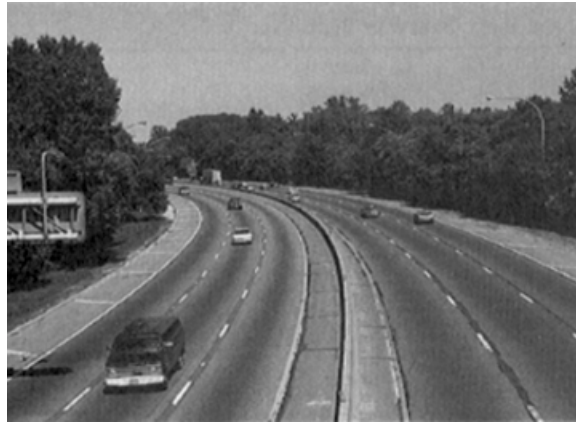

ILLUSTRATION 13-5. LOS A.



ILLUSTRATION 13-6. LOS B.



ILLUSTRATION 13-7. LOS C.



ILLUSTRATION 13-8. LOS D.



ILLUSTRATION 13-9. LOS E.



ILLUSTRATION 13-10. LOS F.

LOS C provides for flow with speeds at or near the FFS of the freeway. Freedom to maneuver within the traffic stream is noticeably restricted, and lane changes require more care and vigilance on the part of the driver. Minor incidents may still be absorbed, but the local deterioration in service will be substantial. Queues may be expected to form behind any significant blockage.

LOS D is the level at which speeds begin to decline slightly with increasing flows and density begins to increase somewhat more quickly. Freedom to maneuver within the traffic stream is more noticeably limited, and the driver experiences reduced physical and psychological comfort levels. Even minor incidents can be expected to create queuing, because the traffic stream has little space to absorb disruptions.

At its highest density value, LOS E describes operation at capacity. Operations at this level are volatile, because there are virtually no usable gaps in the traffic stream. Vehicles are closely spaced leaving little room to maneuver within the traffic stream at speeds that still exceed 80 km/h. Any disruption of the traffic stream, such as vehicles entering from a ramp or a vehicle changing lanes, can establish a disruption wave that propagates throughout the upstream traffic flow. At capacity, the traffic stream has no ability to dissipate even the most minor disruption, and any incident can be expected to produce a serious breakdown with extensive queuing. Maneuverability within the traffic stream is extremely limited, and the level of physical and psychological comfort afforded the driver is poor.

LOS F describes breakdowns in vehicular flow. Such conditions generally exist within queues forming behind breakdown points. Breakdowns occur for a number of reasons:

- Traffic incidents can cause a temporary reduction in the capacity of a short segment, so that the number of vehicles arriving at the point is greater than the number of vehicles that can move through it.
- Points of recurring congestion, such as merge or weaving segments and lane drops, experience very high demand in which the number of vehicles arriving is greater than the number of vehicles discharged.
- In forecasting situations, the projected peak-hour (or other) flow rate can exceed the estimated capacity of the location.

Note that in all cases, breakdown occurs when the ratio of existing demand to actual capacity or of forecast demand to estimated capacity exceeds 1.00. Operations immediately downstream of such a point, however, are generally at or near capacity, and downstream operations improve (assuming that there are no additional downstream bottlenecks) as discharged vehicles move away from the bottleneck.

LOS F operations within a queue are the result of a breakdown or bottleneck at a downstream point. LOS F is also used to describe conditions at the point of the breakdown or bottleneck and the queue discharge flow that occurs at speeds lower than

the lowest speed for LOS E, as well as the operations within the queue that forms upstream. Whenever LOS F conditions exist, they have the potential to extend upstream for significant distances.

REQUIRED INPUT DATA AND ESTIMATED VALUES

Exhibit 13-5 gives default values for input parameters in the absence of local data. The analyst should note that taking field measurements for use as inputs to an analysis is the most reliable means of generating parameter values. Only when this is not feasible should default values be considered.

EXHIBIT 13-5. REQUIRED INPUT DATA AND DEFAULT VALUES FOR BASIC FREEWAY SEGMENTS

Required Data	Defaults
Geometric Data	
Number of lanes	-
Lane width	3.6 m
Lateral clearance	3.0 m
Interchange density	-
Specific grade or general terrain	Level
Base free-flow speed	120 km/h rural, 110 km/h urban
Demand Data	
Length of analysis period	15 min
Peak-hour factor	0.88 rural, 0.92 urban
Percentage of heavy vehicles	10% rural, 5% urban
Driver population factor	1.00

Lane Width and Lateral Clearance

The standard lane width for new freeway construction in the United States is 3.6 m. The standard shoulder width is 3.0 m, but this can be increased to 3.6 m for high-speed highways carrying large numbers of trucks (3, p. 338). These standards may be reduced to accommodate special historical or environmental constraints.

Lane width data are needed only if it is known that the lanes are significantly narrower than 3.6 m. Shoulder widths are significant only if narrower than 1.8 m. Default values of 3.6 m for lane widths and 1.8 m for shoulder widths may be used in the absence of local data unless the analyst is aware of any overriding circumstances (such as mountainous topography, historic structures, or a physical obstruction) that might restrict the facility width.

In the case of minor variations in lane widths or shoulder widths within a segment, the analyst should compute the average of the lane widths and use this average to compute the effects on free-flow speed. Where variations in lane or shoulder widths extend 760 m or more, the segment should be divided to provide segments with consistent physical features.

Interchange Density

The mean number of interchanges per kilometer is computed for at least a 10-km length of freeway in which the segment is located. The interchange density becomes significant for speed estimation purposes only when the density exceeds 0.5 interchanges per kilometer (an average spacing of 2 km or less).

Specific Grade or General Terrain

The general terrain type of analysis can be used instead of specific grades wherever no single grade on the segment extends for more than 0.8 km or exceeds 3 percent for

more than 0.4 km. The rate of grade along significant grades can be obtained from geological survey maps.

The maximum extended grade for freeways is usually 6 percent (3, p. 585). If field measurement is not possible and construction plans are not available, extended grades can be approximated on the basis of the analyst's general knowledge of the local terrain. Default values of 2 percent grade for an extended grade on Interstate freeways, 4 percent for an extended grade in rolling terrain, and 6 percent for an extended grade in mountainous terrain may be used in the absence of local data.

Base FFS and FFS

If field measurements are unavailable, FFS can be estimated by applying adjustments to a base free-flow speed (BFFS). The BFFS is 120 km/h for rural freeways and is 100 km/h for urban/suburban freeways. The BFFS is reduced for the effects of lane width, right-side lateral clearance, number of lanes, and density of interchanges.

Analysts should be careful not to assume that the FFS for a freeway is equal to its posted speed limit or the field-measured 85th percentile speed. The FFS is the mean speed measured in the field when volumes are less than 1,300 pc/h/ln.

Length of Analysis Period

The planning, design, and analysis policies and the available resources of an agency will determine the selection of the analysis period(s). The analyst may desire to evaluate the peak hours occurring during the morning commute, at midday, and during the evening commute on a typical weekday or during a peak hour on a Saturday or Sunday if the roadway segment carries a high volume of weekend recreational traffic. Within each hour analyzed, the highest 15-min volume is of primary interest. A peak-hour factor (PHF) is applied to the hourly volume to convert it to a peak 15-min flow rate. A procedure to compute peak-direction, peak-hour demand from an average daily traffic volume is described in Chapter 8.

Peak-Hour Factor

In the absence of field measurements of PHF, approximations can be used. For congested conditions, 0.95 is a reasonable approximation. The PHF tends to be higher for oversaturated conditions and lower for undersaturated conditions. Default values of 0.92 for urban areas and 0.88 for rural areas may be used in the absence of local data.

Heavy Vehicles

The percentage of heavy vehicles in rolling and mountainous terrain should be obtained from locally available data for similar facilities and demand conditions. If the proportion of RVs, trucks, and buses is not known, all the heavy vehicles can be considered to be trucks for the purposes of selecting passenger-car equivalents and computing the heavy-vehicle adjustment factor. Default values of 5 percent heavy vehicles for urban areas and 10 percent heavy vehicles for rural areas may be used in the absence of local data.

Driver Population

The reciprocal of the driver population factor is used to increase the flow rate to account for a driver population not familiar with the freeway facility. The factor should normally be 1.00 but can be reduced to 0.85 for the analysis of weekend conditions in a recreational area.

SERVICE VOLUME TABLE

Exhibit 13-6 may be used to estimate the number of through lanes required to obtain a desired level of service for basic freeway segments under default conditions. The table can be used to test the effect of different interchange densities and is sensitive to the

Do not assume that FFS is equal to the speed limit

different operating characteristics of urban and rural freeways. The example service volumes in the exhibit are highly dependent on the assumptions given in the footnote.

EXHIBIT 13-6. EXAMPLE SERVICE VOLUMES FOR BASIC FREEWAY SEGMENTS
(SEE FOOTNOTE FOR ASSUMED VALUES)

	Number of Lanes	FFS (km/h)	Service Volumes (veh/h) for LOS				
			A	B	C	D	E
Urban	2	98	1230	1940	2820	3680	4110
	3	101	1900	2980	4340	5570	6200
	4	103	2590	4070	5920	7500	8310
	5	106	3320	5210	7550	9450	10,450
Rural	2	120	1440	2260	3150	3770	4120
	3	120	2160	3400	4720	5660	6180
	4	120	2880	4530	6300	7540	8240
	5	120	3600	5660	7870	9430	10,300

Notes:

Assumptions: Urban: 110-km/h base free-flow speed, 3.6-m-wide lanes, 1.8-m-wide shoulders, level terrain, 5 percent heavy vehicles, no driver population adjustment, 0.92 PHF, 0.63 interchanges per kilometer.

Rural: 120-km/h base free-flow speed, 3.6-m-wide lanes, 1.8-m-wide shoulders, level terrain, 5 percent heavy vehicles, no driver population adjustment, 0.88 PHF, 0.31 interchanges per kilometer.

This table contains approximate values. It is meant for illustrative purposes only. The values are highly dependent on the assumptions used. It should not be used for operational analyses or final design. This table was derived using assumed values given in the footnote.

III. FREEWAY WEAVING

Weaving is defined as the crossing of two or more traffic streams traveling in the same general direction along a significant length of highway without the aid of traffic control devices (with the exception of guide signs). Weaving segments are formed when a merge area is closely followed by a diverge area, or when an on-ramp is closely followed by an off-ramp and the two are joined by an auxiliary lane. Note that if a one-lane on-ramp is closely followed by a one-lane off-ramp and the two are not connected by an auxiliary lane, the merge and diverge movements are considered separately using procedures for the analysis of ramp terminals.

Weaving segments require intense lane-changing maneuvers as drivers must access lanes appropriate to their desired exit points. Thus, traffic in a weaving segment is subject to turbulence in excess of that normally present on basic freeway segments. The turbulence presents special operational problems and design requirements that are addressed by the procedures described in Chapter 24.

Exhibit 13-7 shows a weaving segment. If entry and exit roadways are referred to as legs, vehicles traveling from Leg A to Leg D must cross the path of vehicles traveling from Leg B to Leg C. Flows A-D and B-C are, therefore, referred to as weaving flows. Flows A-C and B-D may also exist, but they need not cross the path of other flows and are referred to as nonweaving flows.

Exhibit 13-7 shows a simple weaving segment formed by a single merge point followed by a single diverge point. Multiple weaving segments may be formed where one merge is followed by two diverge points or where two merge points are followed by one diverge point.

Lane changing is a key descriptor of weaving operation

EXHIBIT 13-7. FORMATION OF A WEAVING SEGMENT

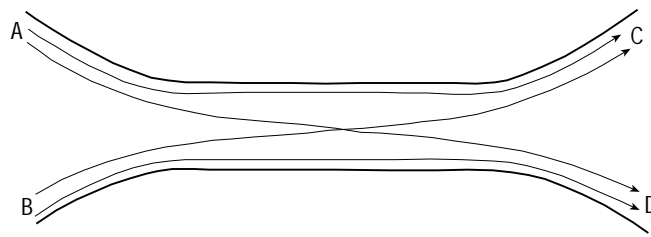

Three key geometric features affect weaving operation:

- Configuration
- Length
- Width

Weaving segments may exist on any type of facility: freeways, multilane highways, two-lane highways, interchange areas, urban streets, or collector-distributor roadways. Whereas the methodology of Chapter 24 was developed for freeways, guidance is given on adapting the procedure to weaving segments on multilane highways. No guidance is given for analysis of weaving on urban streets, which is considerably more complex and involves signalization issues. At present, there are no generally accepted procedures for the analysis of weaving on urban streets.

Three geometric variables influence weaving segment operations: configuration, length, and width. These variables are discussed in the following sections.

WEAVING CONFIGURATIONS

The most critical aspect of operations within a weaving segment is lane changing. Weaving vehicles, which must cross a roadway to enter on the right and leave on the left, or vice versa, accomplish these maneuvers by making the appropriate lane changes. The configuration of the weaving segment (i.e., the relative placement of entry and exit lanes) has a major effect on the number of lane changes required of weaving vehicles to successfully complete their maneuver. There is also a distinction between lane changes that must be made to weave successfully and additional lane changes that are discretionary (i.e., are not necessary to complete the weaving maneuver). The former must take place within the confined length of the weaving segment, whereas the latter are not restricted to the weaving segment itself.

The methodology of Chapter 24 identifies three major categories of weaving configurations: Type A, Type B, and Type C. Each has unique characteristics that are described below.

Type A Weaving Configuration

Exhibit 13-8 illustrates two subcategories of Type A weaving segments. The identifying characteristic of a Type A weaving segment is that all weaving vehicles must make one lane change to complete their maneuver successfully. All of these lane changes occur across a lane line that connects from the entrance gore area directly to the exit gore area. Such a line is referred to as a crown line. Type A weaving segments are the only such segments to have a crown line.

The most common form of Type A weaving segment is shown in Exhibit 13-8(a). The segment is formed by a one-lane on-ramp followed by a one-lane off-ramp, with the two connected by a continuous auxiliary lane. The lane line between the auxiliary lane and the right-hand freeway lane is the crown line for the weaving segment. All on-ramp vehicles entering the freeway must make a lane change from the auxiliary lane to the shoulder lane of the freeway. All freeway vehicles exiting at the off-ramp must make a lane change from the shoulder lane of the freeway to the auxiliary lane. This type of configuration is also referred to as a ramp-weave.

Exhibit 13-8(b) illustrates a major weaving segment that also has a crown line. A major weaving segment is formed when three or four of the entry and exit legs have multiple lanes. As in the case of a ramp-weave, all weaving vehicles, regardless of the direction of the weave, must execute one lane change across the crown line of the segment.

Type A: all weaving vehicles must make one lane change

EXHIBIT 13-8. TYPE A WEAVING SEGMENTS

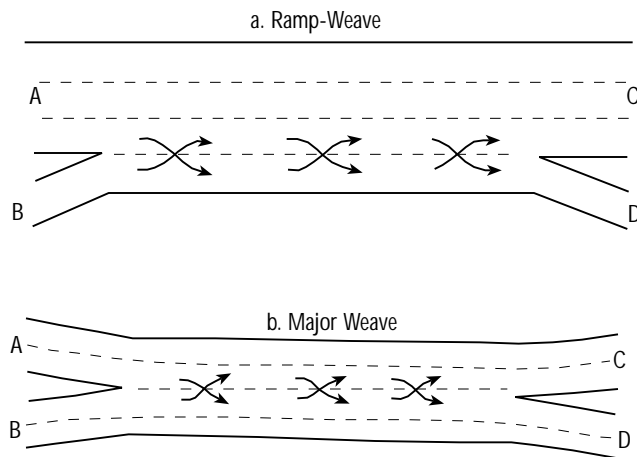

The two segments differ primarily in the effect of ramp geometrics on speed. For most ramp-weave segments, the design speed of the ramps is significantly lower than the design speed of the freeway. Thus, on- and off-ramp vehicles must accelerate or decelerate as they traverse the weaving segment. For major weaving segments, entry and exit legs often have design speeds that are similar to that of the mainline freeway, and such acceleration and deceleration are not required. It should be noted that the methodology of Chapter 24 was calibrated for ramp-weave configurations.

Because all weaving vehicles in a Type A configuration must execute a lane change across the crown line, weaving vehicles are generally confined to occupying the two lanes adjacent to the crown line. Some nonweaving vehicles will share these lanes. This will essentially limit the number of lanes that weaving vehicles can occupy.

Type B Weaving Configuration

Type B weaving segments are shown in Exhibit 13-9. All Type B weaving segments fall into the general category of major weaving segments in that such segments always have at least three entry and exit legs with multiple lanes (except for some collector-distributor configurations).

Once again, it is the lane changing required of weaving vehicles that characterizes the Type B configuration:

- One weaving movement can be made without making any lane changes, and
- The other weaving movement requires at most one lane change.

Exhibits 13-9(a) and 13-9(b) show two Type B weaving segments. In both cases, Movement B-C (entry on the right, departure on the left) may be made without executing any lane changes, whereas Movement A-D (entry on the left, departure on the right) requires only one lane change. Essentially, there is a continuous lane that allows for entry on the right and departure on the left. In Exhibit 13-9(a), this is accomplished by providing a diverging lane at the exit gore. From this lane, a vehicle may proceed down either exit leg without executing a lane change. This type of design is also referred to as lane balanced, that is, the number of lanes leaving the diverge is one more than the number of lanes approaching it.

In Exhibit 13-9(b), the same lane-changing scenario is provided by having a lane from Leg A merge with a lane from Leg B at the entrance gore. This is slightly less efficient than providing lane balance at the exit gore but produces similar numbers of lane changes by weaving vehicles.

The analysis of a major weave in the HCM is an approximation

Lane-changing characteristics for Type B

Lane balance defined

EXHIBIT 13-9. TYPE B WEAVING SEGMENTS

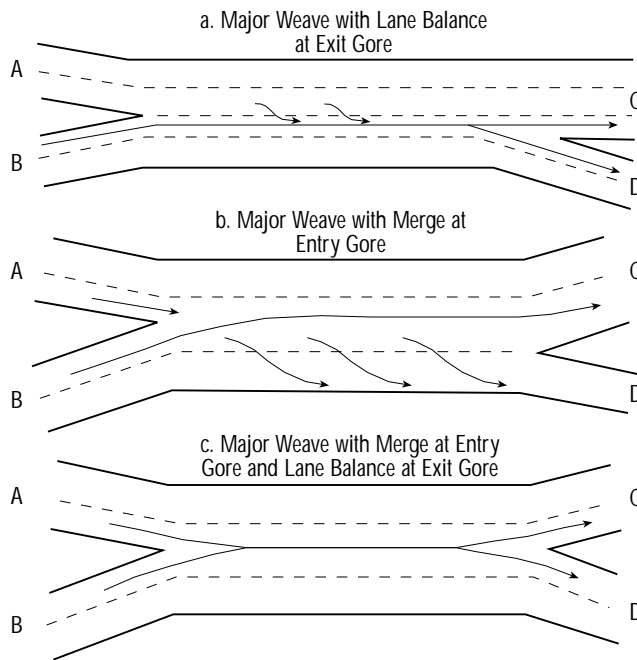

The configuration shown in Exhibit 13-9(c) is unique, having both a merge of two lanes at the entrance gore and lane balance at the exit gore. In this case, both weaving movements can take place without making a lane change. Such configurations are most often found on collector-distributor roadways as part of an interchange.

Type B weaving segments are extremely efficient in carrying large weaving flows, primarily because of the provision of a through lane for at least one of the weaving movements. Weaving movements can also be made with a single lane change from either of the lanes adjacent to the through lane. Thus, weaving vehicles can occupy a substantial number of lanes in the weaving segment and are not as restricted as in Type A segments.

Type C Weaving Configuration

Type C weaving segments are similar to those of Type B in that one or more through lanes are provided for one of the weaving movements. The distinguishing characteristic of a Type C weaving segment is that the other weaving movement requires a minimum of two lane changes for successful completion of a weaving maneuver. Thus, a Type C weaving segment is characterized by the following:

- One weaving movement may be made without making a lane change, and
- The other weaving movement requires two or more lane changes.

Exhibit 13-10 shows two types of Type C weaving segments. In Exhibit 13-10(a), Movement B-C does not require a lane change, whereas Movement A-D requires two lane changes. This type of segment is formed when there is neither merging of lanes at the entrance gore nor lane balance at the exit gore, and no crown line exists. Although such a segment is relatively efficient for weaving movements in the direction of the freeway flow, it cannot efficiently handle large weaving flows in the other direction.

Exhibit 13-10(b) shows a two-sided weaving segment. It is formed when a right-hand on-ramp is followed by a left-hand off-ramp, or vice versa. In such cases, the through freeway flow operates functionally as a weaving flow. Ramp-to-ramp vehicles must cross all lanes of the freeway to execute their desired maneuver. Freeway lanes are, in effect, through weaving lanes, and ramp-to-ramp vehicles must make multiple lane changes as they cross from one side of the freeway to the other. Although it is technically

Type C: one weaving maneuver requires at least two lane changes

Analysis of two-sided weaving in the HCM is only a rough approximation

a Type C configuration, there is little information concerning the operation of such segments. The methodology of Chapter 24 was calibrated for the type of segment in Exhibit 13-10(a) and provides only the roughest of approximations when applied to two-sided weaving segments.

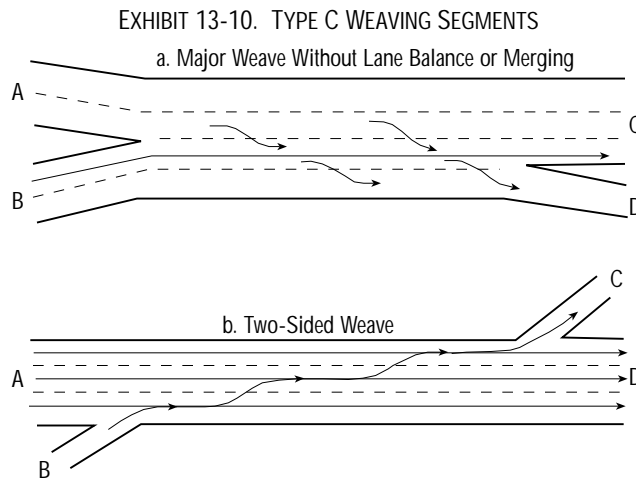

Effects of Weaving Configuration

The configuration of the weaving segment has a marked effect on operations because of its influence on lane-changing behavior. A weaving segment with 1,000 veh/h weaving across 1,000 veh/h in the other direction requires at least 2,000 lane changes per hour in a Type A segment, since each vehicle makes one lane change. In a Type B segment, only one movement must change lanes, reducing the number of required lane changes per hour to 1,000. In a Type C segment, one weaving flow would not have to change lanes, while the other would have to make at least two lane changes, for a total of 2,000 lane changes per hour.

Because of this, the models and algorithms of Chapter 24 are keyed to the type of configuration, with parameters that depend specifically on configuration. Thus, for a given number of lanes and length of segment, models will predict different operating characteristics for different configurations.

Configuration has a further effect on the proportional use of lanes by weaving and nonweaving vehicles. Since weaving vehicles must occupy specific lanes to efficiently complete their maneuvers, the configuration can limit the ability of weaving vehicles to use outer lanes of the segment. This effect is most pronounced for Type A segments, because weaving vehicles must primarily occupy the two lanes adjacent to the crown line. It is least severe for Type B segments, since these segments require the fewest lane changes for weaving vehicles, thus allowing more flexibility in lane use.

WEAVING LENGTH

Because weaving vehicles must execute all the required lane changes for their maneuver within the weaving segment boundary from the entry gore to the exit gore, the parameter of weaving length is important. The length of the weaving segment constrains the time and space in which the driver must make all required lane changes. Thus, as the length of a weaving segment decreases (configuration and weaving flow being constant), the intensity of lane changing, and the resulting turbulence, increases.

The measurement of weaving length is shown in Exhibit 13-11. Length is measured from a point at the merge gore where the right edge of the freeway shoulder lane and the left edge of the merging lane(s) are 0.6 m apart to a point at the diverge gore where the two edges are 3.7 m apart.

Configuration affects use of lanes

EXHIBIT 13-11. MEASURING THE LENGTH OF A WEAVING SEGMENT

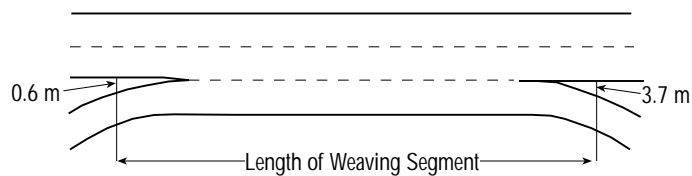

Segments may become so long that the procedure no longer applies

Procedures in Chapter 24 generally apply to weaving segments up to 750 m long. Weaving may exist in longer segments, but merging and diverging movements are often separated, with lane changing tending to concentrate near merge and diverge gore areas. Weaving turbulence may exist to some degree throughout longer segments, but operations are approximately the same as those for a basic freeway segment, except for the ramp influence areas near the entry and exit gore areas.

WEAVING WIDTH

The third geometric variable influencing the operation of the weaving segment is its width, which is defined as the total number of lanes between the entry and exit gore areas, including the auxiliary lane, if present. As the number of lanes increases, the throughput capacity increases. At the same time, the opportunity for lane changing also increases for discretionary lane changes that may take place within the weaving segment.

TYPE OF OPERATION

Whereas the total number of lanes in the weaving segment is important, the proportional use of those lanes by weaving and nonweaving vehicles is even more important. Under normal circumstances, weaving and nonweaving vehicles compete for space, and operations across all lanes tend to reach an equilibrium in which all drivers experience similar conditions. In a weaving segment, there is some segregation of weaving and nonweaving flows as nonweaving vehicles tend to stay in outside lanes and weaving vehicles tend to occupy the lanes involved in crossing the roadway. Nevertheless, there is substantial sharing of lanes by weaving and nonweaving vehicles.

Under normal circumstances, weaving and nonweaving vehicles will reach equilibrium operation in which weaving vehicles effectively occupy N_w lanes of the segment, with nonweaving vehicles occupying the remaining lanes.

In a very real sense, however, the lane configuration limits the total number of lanes that can be used by weaving vehicles because of the lane changes that must be made. The following statements describe this effect.

- Weaving vehicles may occupy all of a lane in which weaving is accomplished without a lane change.
- Weaving vehicles may occupy most of a lane from which a weaving maneuver can be accomplished with a single lane change.
- Weaving vehicles may occupy a small portion of a lane from which a weaving maneuver can be completed by making two lane changes.
- Weaving vehicles cannot occupy a measurable portion of any lane from which a weaving maneuver would require three or more lane changes.

This translates into limitations on the maximum number of lanes that weaving vehicles can occupy based on the configuration of the segment, as shown in Exhibit 13-12.

In a typical Type A configuration, almost all ramp vehicles are weaving (i.e., there is little ramp-to-ramp flow). Thus, the auxiliary lane is almost fully occupied by weaving vehicles. However, the shoulder lane of the freeway is shared by weaving and nonweaving vehicles. Studies have shown that weaving vehicles rarely occupy more than 1.4 lanes of a Type A configuration.

The relative use of lanes by weaving and nonweaving vehicles is an important consideration

Guidelines on lane use characteristics

EXHIBIT 13-12. MAXIMUM USE OF LANES BY WEAVING VEHICLES

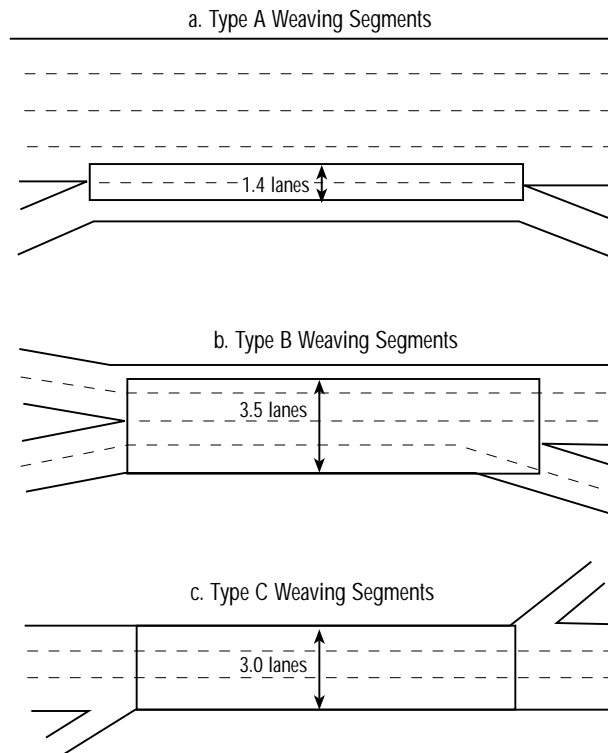

Type B configurations are far more flexible. There is always one through lane for weaving vehicles that can be fully occupied by those vehicles. In addition, the two lanes adjacent to the through lane can also be substantially used by weaving vehicles. There can be some usage of the next adjacent lanes as well. Studies have shown that weaving vehicles can occupy up to 3.5 lanes in a Type B configuration.

Type C configurations are somewhat more restrictive than Type B configurations, particularly for the movement requiring two or more lane changes. Weaving vehicles can still occupy all of the through lane and substantial portions of the lanes adjacent to the through lane. Partial use of other lanes, however, is usually quite restricted. Studies indicate that the practical limit on lane usage by weaving vehicles in a Type C configuration is 3.0.

In this discussion, two important parameters have been defined:

N_w = number of lanes weaving vehicles must occupy to achieve equilibrium operation with nonweaving vehicles, and

$N_w(max)$ = maximum number of lanes that can be occupied by weaving vehicles, based on geometric configuration.

The methodology of Chapter 24 includes models for determining values of N_w , whereas values of $N_w(max)$ have been specified herein. The comparison of the two values determines the type of operation that is present in the weaving segment.

Where $N_w \leq N_w(max)$, equilibrium operation will be established. This is referred to as unconstrained operation, because there are no constraints preventing the equilibrium from occurring. Where $N_w > N_w(max)$, weaving vehicles can only occupy $N_w(max)$ lanes. Thus, they will occupy less space than is needed to establish equilibrium, while nonweaving vehicles occupy more space than normal. Operations for weaving vehicles become worse, while those for nonweaving vehicles get better. This is referred to as constrained operation, because the configuration constrains weaving vehicles from establishing equilibrium with nonweaving vehicles.

Constrained and
unconstrained operation

Under unconstrained operation, weaving and nonweaving vehicles usually experience similar operational characteristics. In constrained operation, weaving vehicles often experience operating conditions that are markedly worse than those of nonweaving vehicles in the same segment. Thus, determining the type of operation is a key step in the Chapter 24 analysis methodology.

SERVICE VOLUME TABLE

The Chapter 24 methodology does not readily produce service volumes. The procedure is set up to determine LOS, with flows and geometrics being fully specified. Nevertheless, service volumes can be produced by trial-and-error computations of volume levels that result in threshold densities for the various LOS.

Service volumes depend on the type of configuration, the length of the segment, the volume ratio (the proportion of total flow that is weaving), the number of lanes in the segment, and the FFS of the freeway. Exhibit 13-13 gives example service volumes for weaving segments.

EXHIBIT 13-13. EXAMPLE SERVICE VOLUMES FOR FREEWAY WEAVING SEGMENTS
(SEE FOOTNOTE FOR ASSUMED VALUES)

Weaving Section Number of Lanes	Service Volumes (veh/h) for LOS				
	A	B	C	D	E
Type A					
3	1710	3010	3920	4740	5490
4	2280	4010	5230	6320	7330
5	2850	5010	6540	7930	9260
Type B					
3	1780	3290	4430	5490	6320
4	2380	4390	5900	7320	8430
5	2970	5490	7380	9140	10,540
Type C					
3	1790	3280	4380	5400	6320
4	2380	4370	5840	7200	8430

Note:
Assumptions: FFS = 120 km/h, PHF = 0.90, 5 percent trucks, level terrain, volume ratio = 0.20, weaving segment length = 300 m.

IV. RAMPS AND RAMP JUNCTIONS

A ramp is a length of roadway providing an exclusive connection between two highway facilities. On freeways, all entering and exiting maneuvers take place on ramps that are designed to facilitate smooth merging of on-ramp vehicles into the freeway traffic stream and smooth diverging of off-ramp vehicles from the freeway traffic stream onto the ramp. Computational procedures for the analysis of ramps are contained in Chapter 25 of this manual.

RAMP COMPONENTS

A ramp may consist of three geometric elements of interest: the ramp-freeway junction, the ramp roadway, and the ramp-street junction. A ramp-freeway junction is typically designed to permit high-speed merging or diverging with minimum disruption to the adjacent freeway traffic. The geometric characteristics of ramp-freeway junctions vary. The length and type (taper, parallel) of acceleration or deceleration lanes, FFS of

This table contains approximate values. It is meant for illustrative purposes only. The values are highly dependent on the assumptions used. It should not be used for operational analyses or final design. This table was derived using assumed values given in the footnote.

The focus of this section is on the ramp-freeway junction

the ramp in the immediate vicinity of the junction, sight distances, and other elements all influence ramp operations.

Geometric characteristics of ramp roadways vary from location to location. Ramps may vary in terms of number of lanes (usually one or two), design speed, grades, and horizontal curvature. The design of ramp roadways is seldom a source of operational difficulty unless a traffic incident causes disruption along their length. Ramp-street terminal problems can cause queuing along the length of a ramp, but this is generally not related to the design of the ramp roadway.

Freeway-to-freeway ramps have two ramp-freeway terminals and do not have a ramp-street terminal. However, many ramps connect limited-access facilities to local arterials and collectors. For such ramps, the ramp-street terminal is often a critical element in the overall design. Ramp-street junctions can permit uncontrolled merging and diverging movements, or they can take the form of an at-grade intersection. Queues forming at a ramp-street junction can, under extreme conditions, back up into the ramp-freeway junction and indeed onto the freeway mainline itself.

OPERATIONAL CHARACTERISTICS

A ramp-freeway junction is an area of competing traffic demands for space. Upstream freeway traffic competes for space with entering on-ramp vehicles in merge areas. On-ramp demand is usually generated locally, although urban streets may bring some drivers to the ramp from more distant origins.

In a merge area, individual on-ramp vehicles attempt to find gaps in the adjacent freeway lane traffic stream. Because most ramps are on the right side of the freeway, the freeway lane in which on-ramp vehicles seek gaps is designated as Lane 1 in this manual. By convention, freeway lanes are numbered from 1 to N, from the right shoulder to the median.

The action of individual merging vehicles entering the Lane 1 traffic stream creates turbulence in the vicinity of the ramp. Approaching freeway vehicles move toward the left to avoid this turbulence. Studies (4) have shown that the operational effect of merging vehicles is heaviest in Lanes 1 and 2 and the acceleration lane for a distance extending from the physical merge point to 450 m downstream. Exhibit 13-14 shows this influence area for on-ramp and off-ramp junctions.

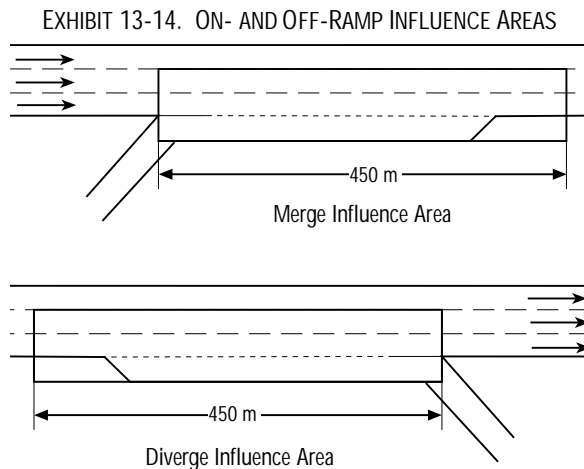
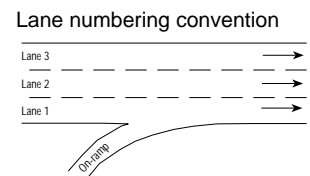

Interactions are dynamic in ramp influence areas. Approaching freeway vehicles will move left as long as there is capacity to do so. Whereas the intensity of ramp flow influences the behavior of freeway vehicles, general freeway congestion can also act to limit ramp flow, causing diversion to other interchanges or routes.

At off-ramps, the basic maneuver is a diverge, that is, a single traffic stream separating into two streams. Exiting vehicles must occupy the lane adjacent to the off-ramp (Lane 1 for a right-hand off-ramp). Thus, as the off-ramp is approached, diverge vehicles move right. This effects a redistribution of other freeway vehicles, as they move left to avoid the turbulence of the immediate diverge area. Studies (4) show that the area of greatest turbulence is the deceleration lane plus Lanes 1 and 2 for a distance extending 450 m upstream from the physical diverge point, as shown in Exhibit 13-14.

IMPORTANT PARAMETERS

A number of variables influence the operation of ramp-freeway junctions. They include all of the variables affecting basic freeway segment operation: lane widths, lateral clearances, terrain, driver population, and the presence of heavy vehicles. There are additional parameters of particular importance to the operation of ramp-freeway junctions, including length of acceleration/deceleration lane, ramp free-flow speed, and lane distribution of upstream traffic.

Length of acceleration and deceleration lanes

The length of the acceleration or deceleration lane has a significant effect on merging and diverging operations. Short lanes provide on-ramp vehicles with restricted opportunity to accelerate before merging and off-ramp vehicles with little opportunity to decelerate off-line. The result is that most acceleration and deceleration must take place on the mainline, which disrupts through vehicles. Short acceleration lanes also force many vehicles to slow significantly and even stop while seeking an appropriate gap in the Lane 1 traffic stream.

Ramp FFS

Many characteristics influence the free-flow speed of the ramp, including degree of curvature, number of lanes, grades, and sight distances, among others. FFS is an influential factor, since it determines the speed at which merging vehicles enter the acceleration lane and the speed at which diverging vehicles must enter the ramp. This, in turn, determines the amount of acceleration or deceleration that must take place. Ramp FFS generally vary between 30 and 80 km/h. Although FFS is best determined in the field, a default value of 55 km/h may be used where specific measurements or predictions are unavailable.

Upstream mainline lane distribution

Several factors influence the lane distribution of traffic immediately upstream of an on- or off-ramp: number of lanes on the facility, proximity of adjacent upstream and downstream ramps, and the activity on those ramps. As conditions force more approaching freeway flow into Lanes 1 and 2, merging and diverging maneuvers become more difficult. Therefore, estimation of the upstream freeway flow approaching in Lanes 1 and 2 of the freeway (which are the freeway lanes included in the merge and diverge influence areas) is important.

CAPACITY OF MERGE AND DIVERGE AREAS

Downstream capacity is not influenced by turbulence at an upstream merge

There is no evidence that merging or diverging maneuvers restrict the total capacity of the upstream or downstream basic freeway segments. Their influence is primarily to add or subtract demand at the ramp-freeway junction. Thus, the capacity of a downstream basic freeway segment is not influenced by turbulence in a merge area. The capacity will be the same as if the segment were a basic freeway segment. As on-ramp vehicles enter the freeway at a merge area, the total number of ramp and approaching freeway vehicles that can be accommodated is the capacity of the downstream basic freeway segment, as shown in Exhibit 13-15.

Upstream capacity is not influenced by turbulence at a downstream diverge

Similarly, the capacity of an upstream basic freeway segment is not influenced by the turbulence in a diverge area. The total capacity that may be handled by the diverge junction is limited either by the capacity of the approaching (upstream) basic freeway segment or by the capacity of the downstream basic freeway segment and the ramp itself, as shown in Exhibit 13-16. Most breakdowns at diverge areas occur because the capacity of the exiting ramp is insufficient to handle the ramp demand flow. This results in queuing that backs up into the freeway mainline.

EXHIBIT 13-15. CAPACITY OF MERGE AREAS

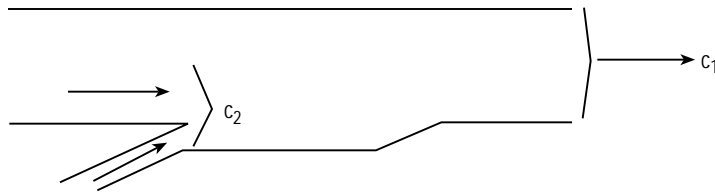

c_1 = capacity of merge area, controlled by the capacity of the downstream basic freeway segment.
 c_2 = maximum flow into the merge influence area (4,600 pc/h).

EXHIBIT 13-16. CAPACITY OF DIVERGE AREAS

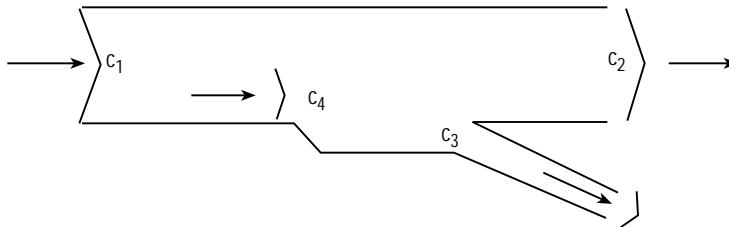

Total diverge capacity cannot be more than the upstream basic freeway capacity (c_1) or the total downstream capacity of the basic freeway (c_2) plus the ramp (c_3).
 c_4 = maximum freeway flow in Lanes 1 and 2 that may enter the diverge influence area (4,400 pc/h).

Another capacity value that affects ramp-freeway junction operation is an effective maximum number of freeway vehicles that can enter the ramp junction influence area without causing local congestion and local queuing. For on-ramps, the total entering flow in Lanes 1 and 2 of the freeway plus the on-ramp flow cannot exceed 4,600 pc/h. For off-ramps, the total entering flow in Lanes 1 and 2 of the freeway (which includes the off-ramp flow) cannot exceed 4,400 pc/h. Demands exceeding these values will cause local congestion and queuing. However, as long as demand does not exceed the capacity of the upstream or downstream freeway sections or the off-ramp, breakdown will normally not occur. Thus, this condition is not labeled as LOS F, but rather at an appropriate LOS based on density in the section.

If local congestion occurs because too many vehicles try to enter the merge (c_2 in Exhibit 13-15) or diverge (c_4 in Exhibit 13-16) influence area, the capacity of the merge or diverge area is unaffected. In such cases, more vehicles move to outer lanes (if they are available), and the lane distribution predicted by the methodology of Chapter 25 is approximate.

LOS

Levels of service in merge and diverge influence areas are defined in terms of density for all cases of stable operation, LOS A through E. LOS F exists when the demand exceeds the capacity of upstream or downstream freeway sections or the capacity of an off-ramp.

LOS A represents unrestricted operations. Density is low enough to permit smooth merging and diverging, with virtually no turbulence in the traffic stream. At LOS B, merging and diverging maneuvers become noticeable to through drivers, and minimal turbulence occurs. Merging drivers must adjust speeds to accomplish smooth transitions from the acceleration lane to the freeway. At LOS C, speed within the influence area begins to decline as turbulence levels become noticeable. Both ramp and freeway vehicles begin to adjust their speeds to accomplish smooth transitions. At LOS D, turbulence levels in the influence area become intrusive, and virtually all vehicles slow to

The HCM allows analysis of the capacity of the ramp influence area

accommodate merging and diverging. Some ramp queues may form at heavily used on-ramps, but freeway operation remains stable. LOS E represents conditions approaching capacity. Speeds reduce significantly, and turbulence is felt by virtually all drivers. Flow levels approach capacity, and small changes in demand or disruptions within the traffic stream can cause both ramp and freeway queues to form.

REQUIRED INPUT DATA AND ESTIMATED VALUES

Exhibit 13-17 gives default values for input parameters in the absence of local data. The analyst should note that taking field measurements for use as inputs to an analysis is the most reliable means of generating parameter values. Only when this is not feasible should default values be considered.

EXHIBIT 13-17. REQUIRED INPUT DATA AND DEFAULT VALUES

Item	Default
Geometric Data	
Ramp lanes	-
Acceleration lane length	180 m
Deceleration lane length	42 m
Ramp free-flow speed	55 km/h
Demand Data	
Demand volume	-
PHF	0.88 rural, 0.92 urban
Percentage of heavy vehicles	10% rural, 5% urban
Driver population factor	1.0

Ramp Lanes

The analyst should assume single-lane ramps unless there is an indication of particularly heavy ramp demand. Ramp demands in excess of 1,500 veh/h generally warrant a second lane (3, p. 87). A metered on-ramp may have two approach lanes to accommodate demand levels that could otherwise be accommodated by a single lane. One lane may be a high-occupancy vehicle (HOV) bypass lane.

Length of Acceleration/Deceleration Lane

The typical length of acceleration and deceleration lanes for ramps should be obtained from the design standards used by the highway operating agency. The length of the acceleration or deceleration lane is measured from the intersection of the edge of the travel way for the freeway and the ramp (Point A) and the downstream intersection of the freeway and ramp edges of the travel way (Point B). These features are shown in Exhibits 13-18 and 13-19. In the absence of design information or field measurements, a default value of 180 m may be used for the length of the acceleration lane, and a default value of 42 m may be used for the length of the deceleration lane.

Ramp FFS

Ramp free-flow speeds usually range between 30 and 80 km/h depending on the grade, alignment, and control. In the absence of field-observed or locally developed values, 55 km/h may be assumed.

Length of Analysis Period

Refer to basic freeway segment description of length of analysis period under required input data and estimated values.

EXHIBIT 13-18. ACCELERATION LANE LENGTH DIAGRAM

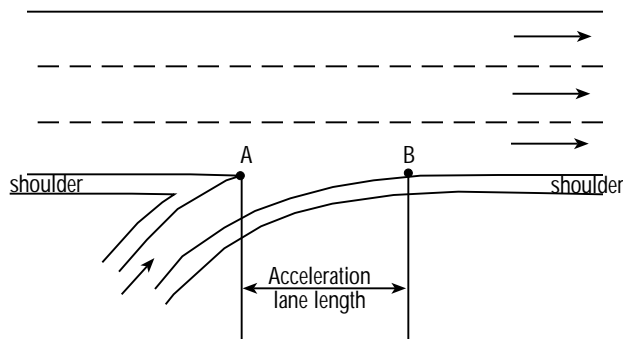
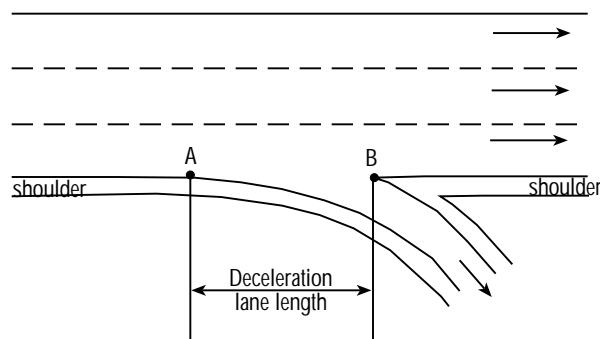

EXHIBIT 13-19. DECELERATION LANE LENGTH DIAGRAM

**PHF**

Refer to basic freeway segment description of peak-hour factor under required input data and estimated values.

Percentage of Heavy Vehicles

Refer to basic freeway segment description of percentage of heavy vehicles under required input data and estimated values.

Driver Population Factor

Refer to basic freeway segment description of driver population factor under required input data and estimated values.

SERVICE VOLUME TABLE

Service volumes for ramps are difficult to describe because of the number of variables that affect operations. Exhibit 13-20 gives example service volumes of a single lane on-ramp and off-ramp under a set of assumptions described in the footnote of the exhibit.

Service volumes for LOS A through D are based on conditions producing the limiting densities for these LOS. Service volumes for LOS E are based on the minimum of three limiting criteria: the capacity of the freeway, the maximum volume that can enter the ramp influence area, and the capacity of the ramp. In some cases, capacity constraints are more severe than density constraints. In such cases, some levels of service may not exist in practical terms for combinations of ramp and freeway volumes.

This table contains approximate values. It is meant for illustrative purposes only. The values are highly dependent on the assumptions used. It should not be used for operational analyses or final design. This table was derived using assumed values given in the footnote.

EXHIBIT 13-20. EXAMPLE SERVICE VOLUMES FOR SINGLE-LANE ON- AND OFF-RAMPS
(SEE FOOTNOTE FOR ASSUMED VALUES)

Mainline Number of Lanes	Service Volumes (veh/h) for LOS				
	A	B	C	D	E
On-Ramp					
2	N/A	290	1250	1760	1760
3	5	1660	1760	1760	1760
4	650	1760	1760	1760	1760
Off-Ramp					
2	N/A	N/A	530	1360	1760
3	N/A	350	1340	1760	1760
4	N/A	830	1660	1760	1760

Notes:

Assumptions: mainline FFS = 120 km/h, mainline volume = 2,000 veh/h/ln, ramp FFS = 55 km/h, acceleration lane length = 300 m, deceleration lane length = 50 m, level terrain for both ramp and freeway, 5 percent trucks, PHF = 0.90, lane width = 3.6 m, and standard shoulder widths.

Basic freeway segments are outside the influence of ramps or weaving
Refer to Chapter 22 for a more detailed discussion of freeway facilities

HOV facility with two or more lanes and limited access can be analyzed as a basic freeway segment

V. FREEWAY FACILITIES

A freeway facility is composed of three types of segments. Weaving segments are segments of the freeway where two or more vehicle flows must cross each other's path. They are usually formed when merge areas are followed by diverge areas. They are also formed when an on-ramp is followed by an off-ramp and the two are connected by an auxiliary lane. Ramp junctions are points at which on- and off-ramps join the freeway. The junction formed at this point is an area of turbulence due to concentrations of merging or diverging vehicles. Basic freeway segments are outside the influence area of ramps or weaving segments of the freeway.

HOV lanes are adjacent to general freeway lanes and are designated for use by buses and vehicles with two or more persons. If an HOV facility has two or more lanes in each direction all or part of the day and if access to the HOV facility is limited from adjacent freeway lanes (e.g., 1.6 km or greater access point spacing), these procedures may be used. Otherwise, HOV lane(s) will have lower lane capacities. Exhibit 13-21 shows segments of an extended freeway facility (5).

EXHIBIT 13-21. FREEWAY FACILITY SEGMENTS

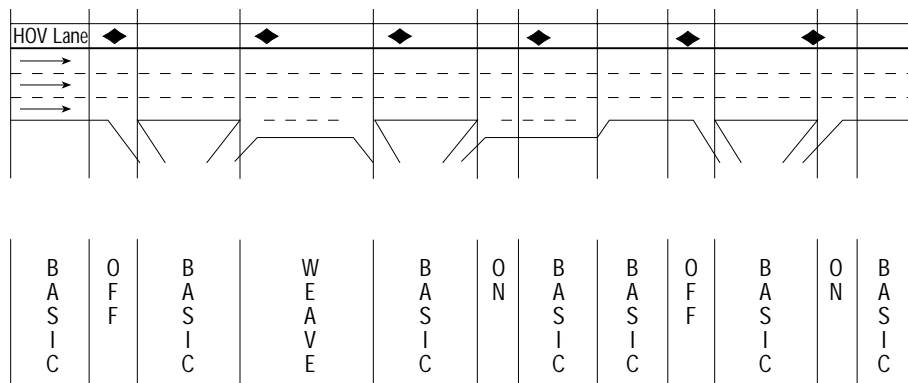

TRAFFIC MANAGEMENT STRATEGIES

Freeway traffic management is the implementation of strategies to improve freeway performance, especially when the number of vehicles desiring to use a portion of the freeway at a particular time exceeds its capacity. There are two approaches to improving system operation. Supply management strategies work on improving the efficiency and effectiveness of the existing freeway or adding additional freeway capacity. Demand management strategies work on controlling, reducing, eliminating, or changing the time of travel of vehicle trips on the freeway while providing a wider variety of mobility options to those who wish to travel. However, in actual application, some strategies may address both sides of the supply/demand equation. The important point is that there are two basic ways to improve system performance.

Demand management

Supply management strategies are intended to increase capacity. Capacity may be increased by building new pavement or by managing existing pavement. Supply management has been the traditional form of freeway system management for many years. Increasingly, the focus is turning to demand management as a tool to address freeway problems. Demand management programs include alternatives to reduce freeway vehicle demand by increasing the number of persons in a vehicle, diverting traffic to alternate routes, influencing the time of travel, or reducing the need to travel. Demand management programs must rely on incentives or disincentives to make these shifts in behavior attractive.

Supply management and demand management

Freeway traffic demand management strategies include the use of priority for high-occupancy vehicles, congestion pricing, and traveler information systems. Some alternative strategies such as ramp metering may restrict demand and possibly increase the existing capacity. In some cases, spot capacity improvements such as the addition of auxiliary lanes or minor geometric improvements may be implemented to better utilize overall freeway system capacity. In the remainder of this section the process of evaluating freeway management strategies and the most common freeway traffic management techniques will be presented. The freeway traffic management process is used to assess the effect on freeway performance that these strategies might produce.

Freeway Traffic Management Process

Freeway traffic management is the application of strategies that are intended to reduce the traffic using the facility or increase the capacity of the facility. Person demand can be shifted in time or space, vehicle demand can be reduced by a shift in mode, or total demand can be reduced by a variety of factors. Factors affecting total demand include changes in land use and elimination of trips due to telecommuting, reduced workweek, or a decision to forgo travel. By shifts of demand in time (e.g., leaving earlier), shifts of demand in space (e.g., taking an alternative route), shifts in mode, or changes in total demand, traffic on a freeway segment can be reduced. Likewise, if freeway capacity has been reduced (e.g., as the result of an incident that has closed a lane or adverse weather conditions), improved traffic management can return the freeway to normal capacity sooner, reducing the total delay to travelers.

Basic approach to evaluating management strategies

The basic approach used to evaluate traffic management is to compare alternative strategies. The base case would be operation of the facility without any freeway traffic management. The alternative case would be operation of the facility with the freeway traffic management strategy or strategies being evaluated. The alternative case could have different demands and capacities based on the conditions being evaluated. The evaluations could also be made for existing or future traffic demands. Combinations of strategies are also possible, but some combinations may be difficult to evaluate because of limited quantifiable data.

Freeway Management Strategies

Freeway traffic management strategies are implemented to make the most effective and efficient use of the freeway system. Activities that reduce capacity include incidents

(including traffic accidents, disabled or stalled vehicles, spilled cargo, emergency or unscheduled maintenance, traffic diversions, or adverse weather), construction activities, scheduled maintenance activities, and major emergencies (such as earthquakes or flooding). Activities that increase demand include special events. Freeway traffic management strategies that mitigate capacity reductions include incident management; traffic control plans for construction, maintenance activities, special events, and emergencies; and minor design improvements (e.g., auxiliary lanes, emergency pullouts, and accident investigation sites). Freeway traffic management strategies to reduce demand include plans for incidents, special events, construction, and maintenance activities; entry control/ramp metering; on-freeway HOV lanes; HOV bypass lanes on ramps; traveler information systems; and road pricing.

Capacity Management Strategies

Incident management

Incident management is the most significant freeway strategy generally used by operating agencies. Incidents can cause significant delays even on facilities that do not routinely experience congestion. It is generally believed that more than 50 percent of freeway congestion is the result of incidents. Strategies to mitigate the effects of incidents include early detection and quick response with the appropriate resources. During an incident, effective deployment of management resources can result in a significant reduction in the effects of the incident. Proper application of traffic control devices, including signage and channelization, is part of effective incident management. Quick removal of vehicles and debris is another part. Incident management may also include the use of accident investigation sites on conventional streets near freeways for follow-up activities.

Lane control signals

Lane control signals are a way to convey the status of individual freeway lanes to motorists. By providing positive guidance through incident sites and maintenance activities, the capacity of the location, as well as safety, may be maintained.

Geometrics

Geometric adjustments can be made to a freeway to enhance overall freeway capacity. Examples include the use of auxiliary lanes, the addition of capacity through the use of narrow lanes or shoulders to eliminate isolated bottlenecks, and the reconfiguration of ramps or ramp geometry.

Construction and maintenance

Construction and reconstruction activities also reduce freeway capacity. These reductions can be minimized through the use of effective traffic control plans. Maintenance activities are similar to construction and reconstruction activities except that the duration tends to be shorter. Scheduling this capacity reduction during periods of lower demand can mitigate the effects of the reduction.

Demand Management Strategies

Ramp closure and metering

The number of vehicles entering the freeway system is the primary determinant of freeway system performance. Entry control is the most straightforward way to limit freeway demand. Entry control can take the form of temporary or permanent ramp closure. Ramp metering, which can limit demand on the basis of a variety of factors that can be either preprogrammed or implemented in response to measured freeway conditions, is a more dynamic form of entry control. Freeway demand can be delayed (changed in time), diverted (changed in space to an alternative route), changed in mode (such as HOV), or eliminated (the trip avoided). The difficult issue in assessing ramp-metering strategies is estimating how demand will shift as a result of metering.

HOV alternatives

HOV alternatives such as mainline HOV lanes or ramp meter bypass lanes are intended to reduce the vehicle demand on the facility without changing the total number of person trips. Assessing these types of alternatives also requires the ability to estimate the number of persons who make a change of mode to HOV. In addition, it is necessary to know the origin and destination of the HOV travelers to determine what portions of the HOV facility they can use, since many HOV facilities have some form of restricted access.

Special events result in traffic demands that are based on the particular event. These occasional activities are amenable to the same types of freeway traffic management used for more routine activities such as daily commuting. In the case of special events, more planning and promotion are required than are typically needed for more routine activities.

Road pricing is a complex and evolving freeway traffic management alternative. Initially, road pricing involved a user fee to provide a means to finance highways. More recently, toll roads have been built as alternatives to congestion. Now, congestion-pricing schemes are being implemented to manage demand on various facilities or in some cases to sell excess capacity on HOV facilities. The congestion-pricing approach to demand management is to price the facility such that demand at critical points in time and space along the freeway is kept below capacity by encouraging some users during peak traffic periods to consider alternatives. Nontraditional road pricing schemes are still in their infancy, so little information is currently available on their effects compared with more traditional toll roads, which view tolls only as a means to recover facility costs.

PERFORMANCE MEASURES

Performance measures for freeway facilities can be summarized by the user in the form of time-space domain contour maps. The most common contour maps are based on speed and density. The contours on the maps join points of similar traffic performance values. For example, the valleys in the speed contour maps indicate time-space regions of lower-speed operations, whereas the ridges in the density contour maps indicate time-space regions of higher-density operations. Careful selection of speed and density contour threshold values associated with capacity operations will clearly indicate boundaries between undersaturated and oversaturated flow conditions. Other contour threshold values can be selected to further identify different levels of undersaturated and oversaturated flow conditions.

Contour maps can also be constructed for volume-to-capacity ratios and congestion status. The volume-to-capacity ratio contour map is helpful in identifying bottlenecks (v/c values of 1.00) and segments operating close to capacity (v/c values > 0.90). Congested portions of the freeway are identified by negative v/c ratios. The main purpose of the congestion status contour map is to provide the shapes and locations of congested regions. The vertical projection of the congested region denotes the duration of the congestion, whereas the horizontal projection of the congested region denotes the geographic extent of the congestion. An interesting means of summarizing the congestion status map is to calculate the area of the congested region on the contour map, which results in units of distance-hours of congestion.

Aggregating the estimated traffic performance measures over the entire length of the freeway facility provides facilitywide estimates for each 15-min time interval. Average and cumulative distributions of speed and density for each time interval can be determined, and patterns of their variation over the connected 15-min time intervals can be assessed. Trip times, vehicle kilometers (or person kilometers) of travel, and vehicle hours (or person-hours) of travel can be computed, and patterns of their variation over the connected 15-min time intervals can be assessed.

Aggregating the estimated segment traffic performance measures over the study time duration provides an assessment of the performance of each segment along the freeway facility. Average and cumulative distributions of speed and density for each segment can be determined, and patterns of their variation over connected freeway segments can be compared. Trip times, vehicle kilometers (or person kilometers) of travel, and vehicle hours (or person-hours) of travel can be assessed for each segment and compared.

The user can aggregate the estimated traffic performance measures over the entire time-space domain to provide an overall assessment of the entire freeway facility over the study time period. Average speeds, average trip times, vehicle kilometers (or person kilometers) of travel, and vehicle hours (or person-hours) of travel can be used to assess the overall traffic performance.

Special events

Road pricing

Time-space domain contour maps are effective tools for displaying performance measures

Frequency distributions are useful in displaying performance measures

VI. REFERENCES

1. Schoen, J., A. May, W. Reilly, and T. Urbanik. *Speed-Flow Relationships for Basic Freeway Sections*. Final Report, NCHRP Project 3-45. JHK & Associates, Tucson, Ariz., May 1995.
2. Hall, F. L., V. F. Hurdle, and J. H. Banks. Synthesis of Recent Work on the Nature of Speed-Flow and Flow-Occupancy (or Density) Relationships on Freeways. In *Transportation Research Record 1365*, TRB, National Research Council, Washington, D.C., 1992, pp. 12–18.
3. *A Policy on Geometric Design of Highways and Streets*. American Association of State Highway and Transportation Officials, Washington, D.C., 1990.
4. Roess, R., and J. Ulerio. *Capacity of Ramp-Freeway Junctions*. Final Report, NCHRP Project 3-37. Polytechnic University, Brooklyn, N.Y., Nov. 1993.
5. May, A. D., et al. *Capacity and Level of Service Analysis for Freeway Facilities, Fourth Interim Report*. SAIC Corp., March 1999.

CHAPTER 14

TRANSIT CONCEPTS

CONTENTS

I.	INTRODUCTION	14-1
	Role of Transit	14-1
	Transit Characteristics	14-1
	General Transit Capacity Concepts	14-3
	Definitions	14-3
	Vehicle Capacity	14-3
	Person Capacity	14-4
	Operator Policy	14-4
	Passenger Demand Characteristics	14-4
	Vehicle Capacity	14-5
	Dwell Time	14-5
II.	BUS CONCEPTS	14-7
	Types of Service	14-7
	Bus Capacity Concepts	14-7
	Loading Areas	14-7
	Bus Stops	14-9
	Bus Terminals	14-9
	On-Street Bus Stops	14-9
	Bus Stop Loading-Area Requirements	14-10
	Bus Lanes	14-11
	General Capacity Ranges	14-11
	Loading Areas	14-13
	Bus Stops	14-13
	Busways	14-13
	Exclusive Arterial-Street Bus Lanes	14-14
	Mixed-Traffic Lanes	14-15
	Bus Priority Treatments	14-15
	Bus Preferential Treatments at Intersections	14-15
	Signal Priority	14-17
	Queue Bypass	14-17
	Queue Jump	14-17
	Curb Extensions	14-18
	Boarding Islands	14-18
	Other Measures	14-18
	Person-Delay Considerations	14-18
III.	LIGHT-RAIL AND STREETCAR CONCEPTS	14-19
	General Capacity Ranges	14-20
	Rail Priority Treatments	14-22
IV.	QUALITY-OF-SERVICE CONCEPTS	14-23
	Definitions	14-23
	Transit Performance Measures	14-23
	Quality-of-Service Framework	14-24
	Transit Trip Decision Making	14-24
	Quality-of-Service Factors	14-26
	Service Coverage	14-26
	Pedestrian Environment	14-27
	Scheduling	14-27

Amenities	14-27
Transit Information	14-28
Transfers	14-28
Total Trip Time	14-28
Cost	14-28
Safety and Security	14-28
Passenger Loads	14-29
Appearance and Comfort	14-29
Reliability	14-29
Framework	14-29
Availability	14-30
Transit Stops	14-30
Route Segments	14-30
System	14-30
Comfort and Convenience	14-31
Transit Stops	14-31
Route Segments	14-31
System	14-31
V. REFERENCES	14-32

EXHIBITS

Exhibit 14-1. Peak-Hour North American CBD Transit Trips	14-2
Exhibit 14-2. Relationship Between Person and Vehicle Capacity	14-4
Exhibit 14-3. Influences on Transit Person Capacity	14-5
Exhibit 14-4. Calculating Transit Person Capacity	14-6
Exhibit 14-5. On-Line and Off-Line Bus Loading Areas	14-7
Exhibit 14-6. Bus Loading Area (Berth) Designs	14-8
Exhibit 14-7. On-Street Bus Stop Locations	14-10
Exhibit 14-8. Influences on Bus Vehicle Capacity	14-12
Exhibit 14-9. Estimated Vehicle Capacity of On-Street Loading Areas	14-13
Exhibit 14-10. Estimated Capacity of On-Line Linear Bus Stops	14-13
Exhibit 14-11. Examples of CBD Busway Capacities	14-14
Exhibit 14-12. Exclusive Bus-Lane Vehicle Capacity: Non-Skip-Stop Operation	14-15
Exhibit 14-13. Exclusive Bus-Lane Vehicle Capacity: Skip-Stop Operation	14-16
Exhibit 14-14. Mixed-Traffic-Lane Bus Vehicle Capacity	14-16
Exhibit 14-15. Bus-Signal Priority Systems	14-17
Exhibit 14-16. Comparison of Bus Preferential Treatments	14-19
Exhibit 14-17. Influences on Rail Vehicle Capacity	14-21
Exhibit 14-18. Typical Light-Rail Transit Person Capacities: 30 Trains/Track/h, 28- to 30-m Articulated Cars	14-22
Exhibit 14-19. Default Values for Single-Track Light-Rail and Streetcar Travel Time	14-22
Exhibit 14-20. Transit Performance Measure Categories and Examples	14-24
Exhibit 14-21. Transit Trip Decision Making: Transit Availability	14-25
Exhibit 14-22. Transit Trip Decision Making: Transit Convenience	14-26
Exhibit 14-23. Transit Quality-of-Service Framework	14-30

I. INTRODUCTION

This chapter introduces capacity and level-of-service (LOS) concepts for transit modes—bus, streetcar, and light rail—that operate on public streets and interact with other users of streets and highways. Transit modes that operate only on exclusive rights-of-way—such as rapid transit, commuter rail, and automated guideway transit—are not discussed here. All transit modes are addressed in more detail in the *Transit Capacity and Quality of Service Manual (1)*.

This chapter may be used in conjunction with Chapter 27 and Part IV of the HCM. Chapter 27 provides analytical procedures and applications for determining transit capacity and LOS for transit stops and route segments. Part IV of this manual integrates the application of transit system capacity and quality-of-service concepts into multimodal corridor and areawide analyses.

ROLE OF TRANSIT

Transit plays two major roles in North America. First, it accommodates choice riders—those who choose transit for their trip-making even though they have other means of travel, such as a motor vehicle. Many commuters choose transit because they are unwilling to deal with traffic congestion during peak periods. Choice riders dominate transit during the peak periods for work trips. In this way, transit increases the number of people who can be carried by urban transportation systems and reduces—or at least constrains—the growth of more than 4.36 billion person-hours (2) lost to urban traffic congestion annually in the United States. Transit is essential for mobility in the central business districts (CBD) of some major cities, which could not survive without it. Accommodating choice riders is especially critical in cities with high CBD densities and costly and limited parking.

The other major role of transit is providing basic mobility for segments of the population that are too young, too old, or otherwise unable to drive due to physical, mental, or financial situations. About 35 percent of the adult population in the United States and Canada do not have a driver's license (2) and must depend on others to transport them in autos, on transit, or on other modes, including walking, cycling, and taxis. This is the principal role of transit services provided specifically for people with disabilities and it is the dominant role of many smaller transit systems. These transit users have been called captive riders.

Rail service offers higher capacities than buses for heavily traveled corridors, and its use of fixed routes makes it more visible and attractive in densely populated areas. Light rail is characterized by a versatility of operation—it can operate separated from other traffic below grade, at grade, or on an elevated structure, as well as at grade in mixed traffic.

Exhibit 14-1 provides examples of peak-hour trips to the CBD by transit in selected North American cities. The variations in transit use reflect differences in population, CBD employment, extent of bus and rail transit services, and geographic characteristics.

TRANSIT CHARACTERISTICS

Several characteristics differentiate transit from the automobile in terms of availability and capacity. Although the automobile has widespread access to roadway facilities, transit service is available only in certain locations during certain times. Roadway capacity is available 24 h/day once constructed, but transit capacity is limited by the number of transit vehicles operated at a given time.

For more information on transit, see the TRB Transit Capacity and Quality of Service Manual

Rail service offers higher capacities than buses

Unlike the auto mode, transit availability is an important consideration

EXHIBIT 14-1. PEAK-HOUR NORTH AMERICAN CBD TRANSIT TRIPS

City	Year	Percent of Peak-Hour Trips by Transit
New York City	1988	87
Chicago	1983	77
Toronto	1994	64
Ottawa	1997	60
Montreal	1994	49
Philadelphia	1997	42
Vancouver	1997	40
Seattle	1997	40
Los Angeles	1980	39
Calgary	1997	39
Edmonton	1994	32
San Diego	1997	15

Sources: *Transit Capacity and Quality of Service Manual* (1), Levinson and St. Jacques (3), and Morrall and Bolger (4).

Transit passengers are typically pedestrians, bicyclists, or motorists for parts of their trips

Transit goals are to move large numbers of people, rather than large numbers of vehicles

All transit modes are addressed in the *Transit Capacity and Quality of Service Manual*

Transit passengers frequently rely on other modes to gain access to transit. Transit use is greatest where population densities are highest and pedestrian access is good. A typical transit user does not have transit service available at the door and must walk, bike, or drive to a transit stop and then must walk or bike from the transit discharge point to the destination. In contrast, suburban areas are mainly automobile-oriented, with employment and residents dispersed, often without sidewalks, and without direct access to many transit lines. If potential passengers cannot have access to transit from both their trip origin and destination, transit is not an option.

Finally, transit is about moving people rather than vehicles. Transit operations at their most efficient involve relatively few vehicles, each potentially carrying a relatively large number of passengers. In contrast, roadway analysis traditionally involves relatively large numbers of vehicles, each usually carrying only one occupant. When evaluating transit priority measures for transit and automobile users, it is the number of people affected that should be compared, rather than the number of vehicles.

This manual addresses only those major transit modes (in terms of passengers carried) that operate on streets and interact with other users of streets and highways. These modes include buses, streetcars, and light rail (see Illustration 14-1).



Bus (Los Angeles)

Light Rail (Baltimore)

Streetcar (San Francisco)

ILLUSTRATION 14-1. Transit modes covered in the *Highway Capacity Manual*.

Bus services can be provided by several vehicle types, ranging from minibuses to articulated and double-deck buses. Standard 12-m buses with more than 35 seats are the dominant type of bus in U.S. transit systems and comprise more than 80 percent of the national bus fleet. Articulated buses 18 m in length have been adopted by a few agencies, but their use is increasing as agencies seek to improve capacity and comfort with only small increases in operating costs. Double-deck buses have had tryouts but have not found widespread use in either Canada or the United States. A few transit agencies operate trolleybuses (both standard and articulated), powered from overhead electrical lines.

During the first half of the 20th century, streetcars were common in most larger North American cities but nearly disappeared in the 1950s as automobile use increased and the spreading suburbs could not be served efficiently by rail. The modern equivalents of the streetcar are the light-rail systems that have started up since 1978. The two modes are similar; however, light rail provides higher speeds and somewhat higher capacity than streetcars. Also, in North America, light-rail tracks usually are separated from general traffic, even when operating on the same street as other traffic, but streetcars sometimes share a lane with other traffic.

Streetcars can share a lane with other traffic; light rail trains are almost always separated from other traffic, even when running on-street

GENERAL TRANSIT CAPACITY CONCEPTS

Transit capacity is different from highway capacity. It deals with the movement of both people and vehicles; it depends on the size of the transit vehicles and how often they operate; and it reflects the interaction of passenger traffic and vehicle flow. Transit capacity depends on the operating policy of the transit agency, which specifies service frequencies and allowable passenger loadings. Accordingly, the traditional concepts applied to highway capacity must be adapted and broadened.

Definitions

Throughout this chapter and Chapter 27, a distinction is made between vehicle and person capacity. Vehicle capacity reflects the number of transit units (buses or trains) that can be served by a loading area, transit stop, guideway, or route during a specified period of time. Person capacity reflects the number of people that can be carried past a given location during a given time period under specified operating conditions, without unreasonable delay, hazard, or restriction, and with reasonable certainty. In this chapter and Chapter 27, the term capacity applies both to persons and vehicles.

Capacity, vehicle capacity, and person capacity

Exhibit 14-2 illustrates the two-dimensional nature of on-street urban transit capacity, using buses. It is possible to operate many buses, each carrying only a few passengers. Whether the buses are full or empty, a larger number of buses can have a negative impact on LOS in terms of highway capacity. Alternatively, a few vehicles could operate, each overcrowded. This represents a poor quality of service from the passenger perspective, and long waiting times would detract from user convenience.

Vehicle Capacity

Transit vehicle capacity is commonly determined for three locations: loading areas or berths; transit stops and stations; and bus lanes and transit routes. Each location directly influences the next. The vehicle capacity of a bus stop or rail station is controlled by the vehicle capacities of the loading areas, and the vehicle capacity of a bus lane or transit route is controlled by the vehicle capacity of the critical stops along the lane or route.

The two greatest influences on loading area vehicle capacity are the dwell time and the ratio of the green time to the cycle length (g/C ratio) for the street on which the transit operates. Dwell time and the g/C ratio also have major influences on the vehicle capacity of transit stops and routes. However, dwell time—the time required to serve passengers at the busiest door plus the time required to open and close the doors—has the greater influence on loading-area vehicle capacity.

Dwell times and g/C ratios have the greatest influence on loading area vehicle capacity

The amount of green time provided to a street controls the number of transit vehicles that theoretically can arrive at a loading area during an hour. In addition, the length of red in relation to a vehicle's dwell time also affects vehicle capacity: if passenger movements have finished, but the vehicle must wait for a traffic signal to turn green, vehicle capacity will be less than if the vehicle can leave immediately, so that another vehicle can use the loading area.

EXHIBIT 14-2. RELATIONSHIP BETWEEN PERSON AND VEHICLE CAPACITY

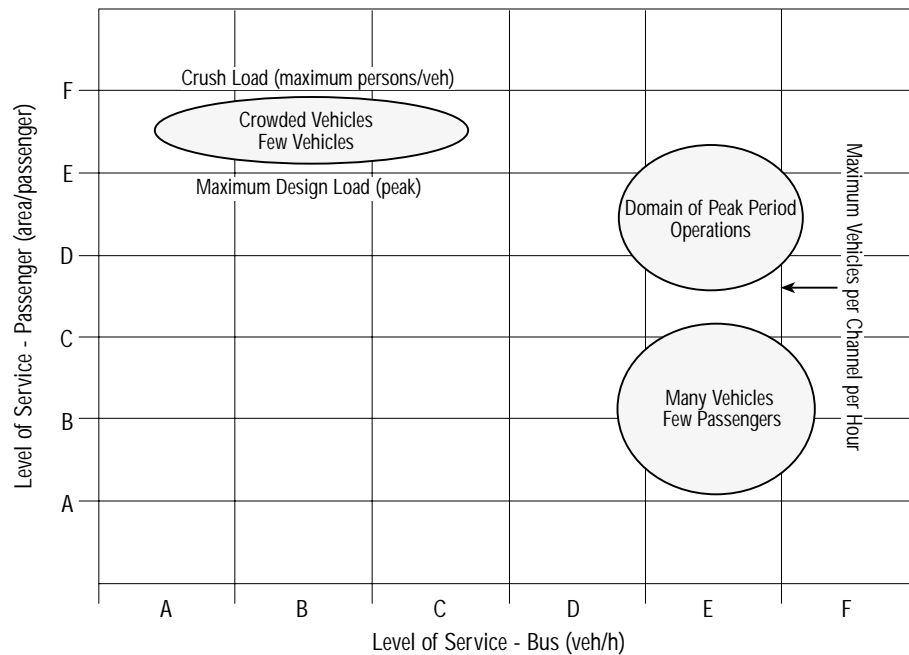

Person Capacity

Person capacity typically is calculated for transit stops and stations and for the maximum load point of a transit route or bus lane; it is calculated for three locations:

- Transit stops and stations,
- Transit routes at their maximum load points, and
- Bus lanes at their maximum load points.

Exhibit 14-3 shows the factors that control person capacity.

Operator Policy

A transit operator directly controls the maximum passenger loads allowed on transit vehicles and the service frequency. An operator with a policy requiring all passengers to be seated will have a lower potential person capacity for a given number of vehicles than an operator with a policy allowing standees. However, passengers experience a higher quality of service with the first operator. The service frequency determines how many passengers actually can be carried, even though a transit stop, transit route, or bus lane can serve more vehicles than actually are scheduled.

Passenger Demand Characteristics

How passenger demand is distributed spatially along a route and how it is distributed over time during the analysis period affects the number of boarding passengers that can be carried. Because of the spatial aspect of passenger demand, person capacity must be stated for a location (typically the maximum load point), not for a route or a street as a whole.

Passenger demand fluctuates during the peak hour. The peak-hour factor (PHF) reflects peak demand volumes typically over a 15-min period during the hour. A transit system should provide sufficient capacity to accommodate peak passenger demand. However, since peak demand is not sustained over the entire hour, and since every transit vehicle will not experience the same peak loadings, actual person capacity during the hour will be less than the peak 15-min demand volumes.

Increasing the maximum allowed passenger load increases person capacity but decreases quality of service

Person capacity is typically stated for the maximum load point

Peak-hour factors reflect fluctuations in passenger demand

EXHIBIT 14-3. INFLUENCES ON TRANSIT PERSON CAPACITY

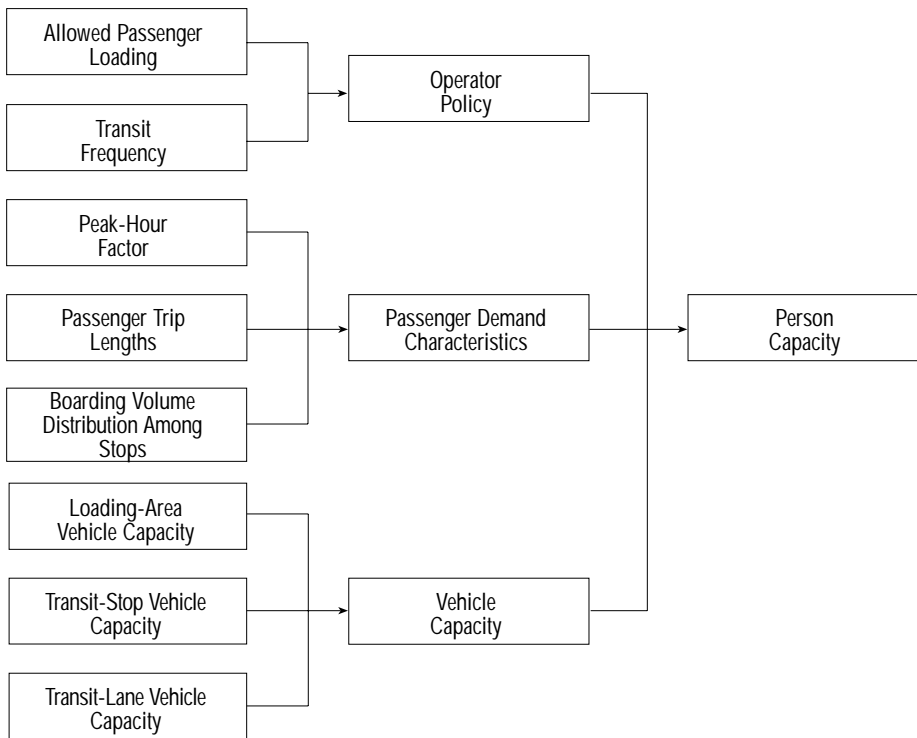

The average passenger trip length affects how many passengers can board a transit vehicle as it travels its route. If trips tend to be long with passengers boarding near the start of the route and alighting near the end, vehicles will not board as many passengers as when passengers board and alight at many locations. However, the total number of passengers onboard at the maximum load points may be similar for each route.

The distribution of boarding passengers among transit stops affects the dwell time of vehicles at each stop. If passenger boardings are concentrated at one stop, the vehicle capacity of a transit route or bus lane will be lower, since the dwell time at that stop will control the vehicle capacity (and, in turn, the person capacity) of the entire route or lane. Vehicle capacity (and person capacity at the maximum load point) is greater when passenger boarding volumes (and dwell times) are evenly distributed among stops.

Vehicle Capacity

The vehicle capacity of various transit facilities—loading areas, stops and stations, and bus lanes—sets an upper limit to the number of passengers that may use a transit stop or that may be carried past the maximum load point. The relationship between the vehicle capacity of transit facilities and the elements of person capacity is illustrated in Exhibit 14-4.

Dwell Time

Just as dwell times are key to determining capacity, passenger demand volumes and passenger service times are key to determining dwell times. Dwell times may be governed by boarding demand, alighting demand, or total interchanging passenger demand (i.e., at a major transfer point). In all cases, dwell time is proportionate to the boarding and alighting volumes times the service time per passenger. Dwell time also can influence a transit operator's service costs: if average vehicle speeds can increase by reducing dwell time, and if the cumulative change exceeds the route headway, then fewer vehicles may be required to provide the same service frequency.

Passenger trip length

Passenger distribution among transit stops

Person capacity is constrained by vehicle capacity

EXHIBIT 14-4. CALCULATING TRANSIT PERSON CAPACITY

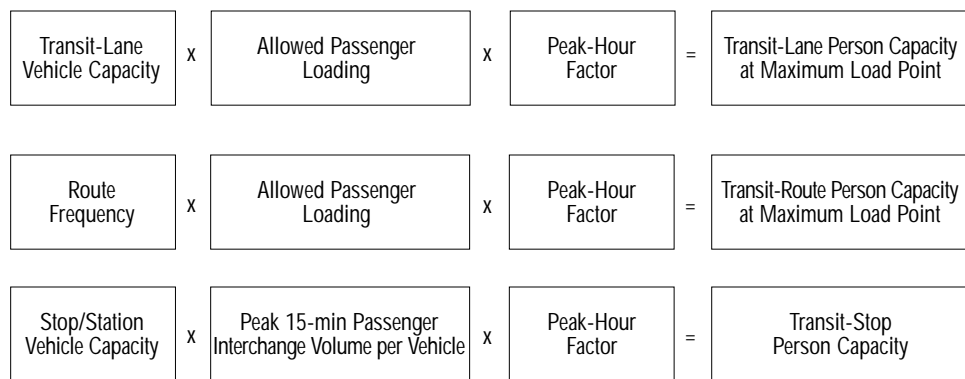

Influences on dwell time

There are six main influences on dwell time. Two relate to passenger demand; the others relate to passenger service time:

- Passenger demand and loading. The number of people boarding and alighting through the highest-volume door determines how long it will take to serve all passengers. If standees are present on a transit vehicle as it arrives at a stop, or if all seats are filled as passengers board, service times will be higher than normal because of congestion in the vehicle.
- Stop and station spacing. The fewer the stops along a route, the greater the number of passengers boarding at each stop. A balance must be found between too few stops and too many. Too few stops increase both the distance riders must walk to gain access to transit and the amount of time a vehicle occupies a loading area. Too many stops reduce overall travel speeds due to the time lost in accelerating and decelerating as well as waiting at traffic signals because stops were made.
- Fare payment procedures. The amount of time passengers spend paying fares is a major factor in the total time for passenger boarding. This time can be reduced by minimizing the number of bills and coins required to pay a fare; encouraging the use of prepaid tickets, tokens, passes, or smart cards; using a proof-of-payment fare collection system; or collecting fares before boarding. Besides eliminating the time required for each passenger to pay a fare onboard, proof-of-payment and paid-fare waiting-area collection systems allow an even distribution of boarding passengers among the vehicle doors, rather than concentrating them at a single door.
- Vehicle types. Low-floor buses decrease passenger service time by eliminating the need to ascend and descend steps. This particularly applies to routes frequently used by the elderly, persons with disabilities, or persons with strollers or bulky carry-on items. Wide doors also allow more passengers to board and alight simultaneously.
- On-board circulation. Encouraging people to exit via the rear doors of buses with more than one door decreases passenger congestion at the front door and reduces passenger service times.
- Wheelchair and bicycle boarding. Dwell time also can be affected by the time to board and disembark passengers in wheelchairs and for bicyclists to load and unload bicycles onto a bus-mounted bicycle rack.

Wheelchair and bicycle boarding times need to be considered when calculating dwell time

II. BUS CONCEPTS

TYPES OF SERVICE

Bus transit service can be either fixed route or demand responsive. Fixed-route service is ideal for large, densely populated urban areas. In less dense areas, which cannot support fixed-route service, demand-responsive transit can be an essential part of transportation for the nondriving population. With this type of service, the passenger calls a dispatcher, who then radios the caller's location to a driver. Generally taxicabs or vans provide this type of door-to-door service.

Demand-responsive service accounts for less than 0.1 percent of U.S. transit passengers. It is used primarily for custom services for senior citizens and persons with disabilities. A variant is route-deviation service. In selected low-density areas, buses operate on fixed routes according to a set schedule. Passengers may ask the driver for a deviation from the fixed route. These deviations usually are limited in distance and number per run. Passengers must telephone or prebook a route deviation beforehand.

Public transportation service in which the transit vehicle arrives at designated transit stops on a prearranged schedule but does not follow a specific route between stops is referred to as point-deviation service. This allows the vehicle to provide curbside service on request.

BUS CAPACITY CONCEPTS

Loading Areas

A loading area, or bus berth, is a space for buses to stop to pick up and discharge passengers. Bus stops, discussed below, contain one or more loading areas. The most common form of loading area is a linear bus stop along a street curb. In this case, loading areas either can be provided in the travel lane (i.e., on-line), so that following buses cannot pass the stopped bus; or they can be pullouts out of the travel lane (i.e., off-line), so that following buses may pass. Exhibit 14-5 depicts these two types of loading areas.

EXHIBIT 14-5. ON-LINE AND OFF-LINE BUS LOADING AREAS

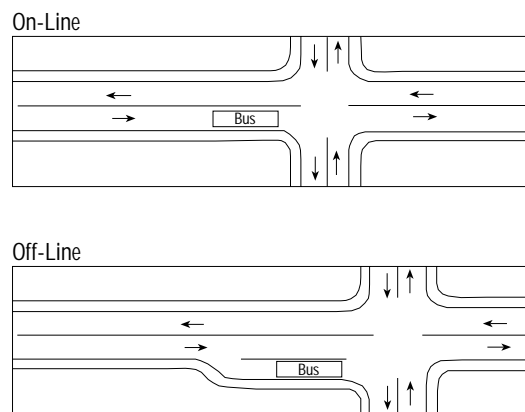

Source: Fitzpatrick et al. (5).

Loading areas in bus terminals may be linear or may take other forms. Angle berths are limited to one bus per berth and require the buses to back out. Drive-through berths are also feasible and may accommodate multiple vehicles. Shallow sawtooth berths are popular in urban transit centers, because they permit independent movements into and out of each berth. Exhibit 14-6 and Illustration 14-2 show common bus loading-area configurations. The National Transportation Safety Board recommends that transit facility designs incorporating sawtooth berths or other similar types of berths provide a

Fixed-route, demand-responsive, and route- and point-deviation service

On-line and off-line loading areas defined

Sawtooth, drive-through, and angle loading-area designs should provide positive protection (such as bollards) to shield pedestrians from errant buses

positive separation (such as bollards) along the roadway, to stop an errant bus at parking-area speed from intruding into the pedestrian area (6).

EXHIBIT 14-6. BUS LOADING AREA (BERTH) DESIGNS

Linear Berths

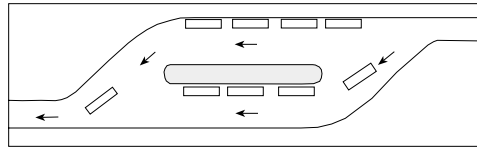

Sawtooth Berths

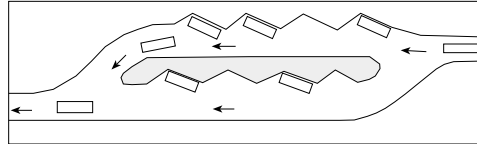

Angle Berths

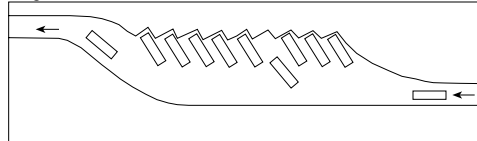

Drive-Through Berths

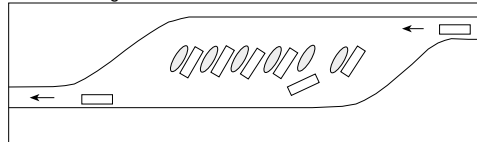

Linear (Miami)



Sawtooth (San Diego)



Drive-through (Copenhagen)



Angle (Newark Airport)

ILLUSTRATION 14-2. Bus loading area (berth) examples.

Linear berths are not as efficient as the other types and typically are used when buses occupy a berth for only a short time (for example, at an on-street bus stop). Sawtooth berths allow independent movements by buses into and out of berths and are commonly used at bus transfer centers. Angle berths, which require buses to back out,

typically are used when a bus occupies a berth for a long time (for example, at an intercity bus terminal). Drive-through berths allow bus stops to be located in a compact area, and also can allow all buses to wait with their front destination signs facing the direction from which passengers arrive (e.g., from a rail station exit).

The main elements that determine loading area capacity are dwell time, dwell-time variability, and clearance time. Dwell time was discussed earlier. Dwell-time variability recognizes that buses do not stop for the same amount of time at a stop because of fluctuations in passenger demand for buses and routes. The effect of variability in bus dwell times on bus capacity is reflected by the coefficient of variation of dwell times, which is the standard deviation of dwell-time observations divided by the mean dwell time. Dwell-time variability is influenced by the same factors that influence dwell time.

Once a bus closes its doors and prepares to depart from a stop, there is a period, known as the clearance time, during which the loading area is not available for use by the following bus. Part of this time is fixed, consisting of the time for a bus to start up and travel its own length, clearing the stop. For on-line stops, this is the only component of clearance time. For off-line stops, however, there is another component of clearance time: the time required for a suitable gap in traffic to allow the bus to reenter the traffic stream and accelerate. This reentry delay varies depending on the traffic volume in the curb lane—it increases as the traffic volumes increase. The delay also depends on the platooning effect due to upstream traffic signals. Some states have laws requiring motorists to yield to buses reentering a roadway; motorist compliance can reduce or even eliminate the reentry delay. Many bus operators forgo using off-line stops on busy streets to avoid reentry delay.

Bus Stops

A bus stop is an area where one or more buses load and unload passengers. It consists of one or more loading areas. Bus stop capacity is related to the capacity of the individual loading areas at the stop, loading area design (linear or nonlinear), and the number of loading areas. Off-line bus stops provide greater capacity than on-line stops for loading areas, but in mixed traffic, bus speeds may be reduced if heavy volumes delay the buses exiting a stop. On the other hand, skip-stop operations are possible with off-line stops, but not with on-line stops.

Bus Terminals

The design of off-street bus terminals and transfer centers involves additional considerations—not only estimates of passenger service times of buses, but also a clear understanding of how each bus route will operate. Therefore, schedule recovery times, driver relief times, and layovers to meet scheduled departure times become key in establishing loading area requirements and in sizing the facility. In addition, good operating practice suggests that each bus route, or geographically compatible groups of routes, should have a separate loading position clearly distinguished for passengers.

Loading-area space requirements should recognize the specific type of transit operations, fare collection practices, bus door configurations, passenger arrival patterns, amount of baggage, driver layover-recovery times, terminal design, and loading area configuration. They should reflect both scheduled and actual peak-period bus arrivals and departures, since intercity bus services regularly run extra vehicles during the busiest travel periods. Bus routes and service patterns also influence loading area requirements. Under good operating practices a maximum of two distinct routes (i.e., services) share a loading position.

On-Street Bus Stops

On-street bus stops typically are located curbside in one of three locations: (a) nearside, when the bus stops immediately before an intersection; (b) farside, when the bus stops immediately after an intersection; and (c) midblock, when the bus stops in the

Dwell-time variability

The time required for a bus to start up and travel its own length is fixed; re-entry delay for off-line stops depends on traffic volumes in the curb lane

Bus stop design for bus terminals must consider passengers and take into account longer loading area occupancies by buses

The three typical on-street bus stop locations are nearside, farside, and midblock

middle of a block, between intersections. Under certain circumstances, such as when buses share a stop with streetcars running in the center of the street, or when exclusive bus lanes are located in the center of the street, a bus stop may be located on a boarding island within the street rather than curbside. When boarding islands are used, pedestrian safety and Americans with Disabilities Act (ADA) accessibility issues should be carefully considered. Exhibit 14-7 depicts typical on-street bus stop locations.

EXHIBIT 14-7. ON-STREET BUS STOP LOCATIONS

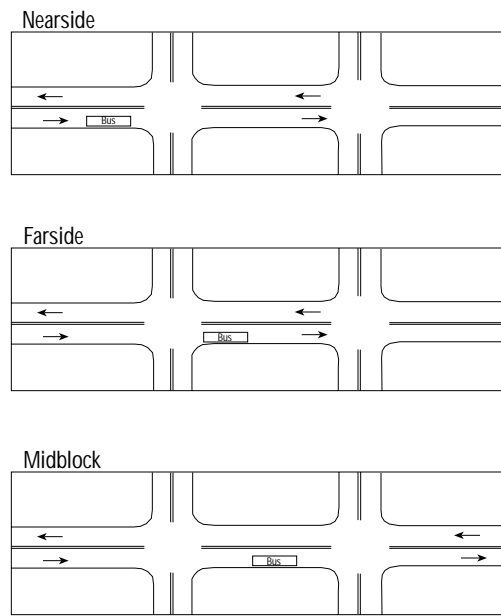

Source: Morrall and Bolger (4).

The bus stop location influences capacity, particularly when passenger vehicles are allowed to make right turns from the curb lane (as is the case in most situations, except for certain kinds of exclusive bus lanes). Farside stops have the least effect on capacity (when buses are able to use an adjacent lane to avoid right-turn queues), followed by midblock stops, and nearside stops.

Bus Stop Loading-Area Requirements

The key factors influencing the number of loading areas required at a bus stop are the following:

- **Bus volumes.** The number of buses scheduled to use a bus stop during an hour directly affects the number of buses that may need to use the stop. If loading areas are insufficient, buses will queue behind the stop, decreasing its vehicle capacity. This increases passenger travel times and decreases on-time reliability, negatively affecting quality of service.
- **Probability of queue formation.** The failure rate—the probability that queues of buses will form at a bus stop—is a design factor that should be considered when sizing a bus stop.
- **Loading area design.** With the exception of the linear model, loading area designs—such as sawtooth and drive through—are 100 percent effective: the bus-stop vehicle capacity equals the number of loading areas times the vehicle capacity of each loading area, since buses are able to maneuver in and out of the loading areas independently of other buses. Linear loading areas, on the other hand, decrease in effectiveness as the number of loading areas increases, because it is not likely that the loading areas will be used equally. Buses entering or leaving a linear loading area also may be blocked and delayed by buses stopped in adjacent loading areas.

Failure rate

Linear loading areas are less efficient than other loading area designs

- Traffic signal timing. The amount of green signal time provided to a street that buses operate on affects the maximum number of buses that potentially can arrive at a bus stop during an hour. The amount of red signal time influences how much additional time a bus occupies a stop after passenger movements are completed.

Bus Lanes

For the purpose of determining capacity, a bus lane is any lane on a roadway in which buses operate. It may be used exclusively by buses, or it may be shared with other traffic. The vehicle capacity of a bus lane is influenced by the capacity of the critical bus stop located along the lane, typically the stop with the highest volume of passengers. However, the critical stop also might have an insufficient number of loading areas. Bus lane capacity also is influenced by the following:

- Bus lane type. The vehicle capacity procedures identify three types of bus lanes (7). Type 1 bus lanes have no use of the adjacent lane; Type 2 bus lanes have partial use of the adjacent lane, which is shared with other traffic; and Type 3 bus lanes provide for exclusive use of two lanes by buses. The curb lane of Type 1 and 2 lanes may or may not be shared with other traffic. When the lane is primarily for mixed traffic, typically there is no formal designation of a bus lane either with signing or with pavement markings. The greater the degree of exclusivity of the bus lane and the greater the number of lanes available for buses to maneuver, the greater the bus lane capacity. Bus lane types are illustrated and discussed in more detail in Chapter 27.

- Skip-stop operation. Bus lane capacity can be increased by dispersing bus stops, so that only a portion of the buses use the bus lane stop at a particular set of stops. This block-skipping pattern allows for a faster trip and reduces the number of buses stopping at each stop, although it also increases the complexity of the bus system for new riders and may increase passenger walking distances to bus stops. Skip-stop operation is discussed further in Chapter 27.

- Platooning. When skip stops are used, gathering buses into platoons at the beginning of the skip-stop section maximizes the efficiency of the operation. Each platoon is assigned a group of stops, and the platooned buses travel as trains past the skip-stop section. The number of buses in each group ideally should equal the number of loading areas at each stop.

- Bus stop location. Farside stops provide the highest bus lane capacity, but other factors, such as conflicts with other vehicles, transfer opportunities, and traffic signal timing, also must be considered when siting bus stops.

Exhibit 14-8 summarizes the main elements that determine the bus vehicle capacity of loading areas, stops, and lanes.

GENERAL CAPACITY RANGES

This section provides estimates of vehicle capacity for loading areas, bus stops, and bus lanes, based on defaults applied to the capacity estimation procedures given in Chapter 27. Vehicle capacities shown are generally maximums based on a 25 percent failure rate (i.e., one in four buses will have to wait for a loading area when arriving at a stop). Schedule reliability concerns may dictate scheduling fewer buses than the maximums shown below. Person capacities may be obtained by multiplying the values given in the exhibits by the maximum allowed passenger load per vehicle (set by policy) times a PHF. The typical PHF for bus routes ranges from 0.60 to 0.95 (8,9). In general, capacities are governed by the busiest stop and by the distribution of passengers among stops.

Suggested peak-hour factors for use in calculating person capacity

Bus vehicle capacity is commonly calculated at three locations: loading areas (bus berths), bus stops, and bus lanes. The capacity of each of these locations is influenced by one or more elements (middle column), each of which in turn is influenced by a number of factors (left column).

EXHIBIT 14-8. INFLUENCES ON BUS VEHICLE CAPACITY

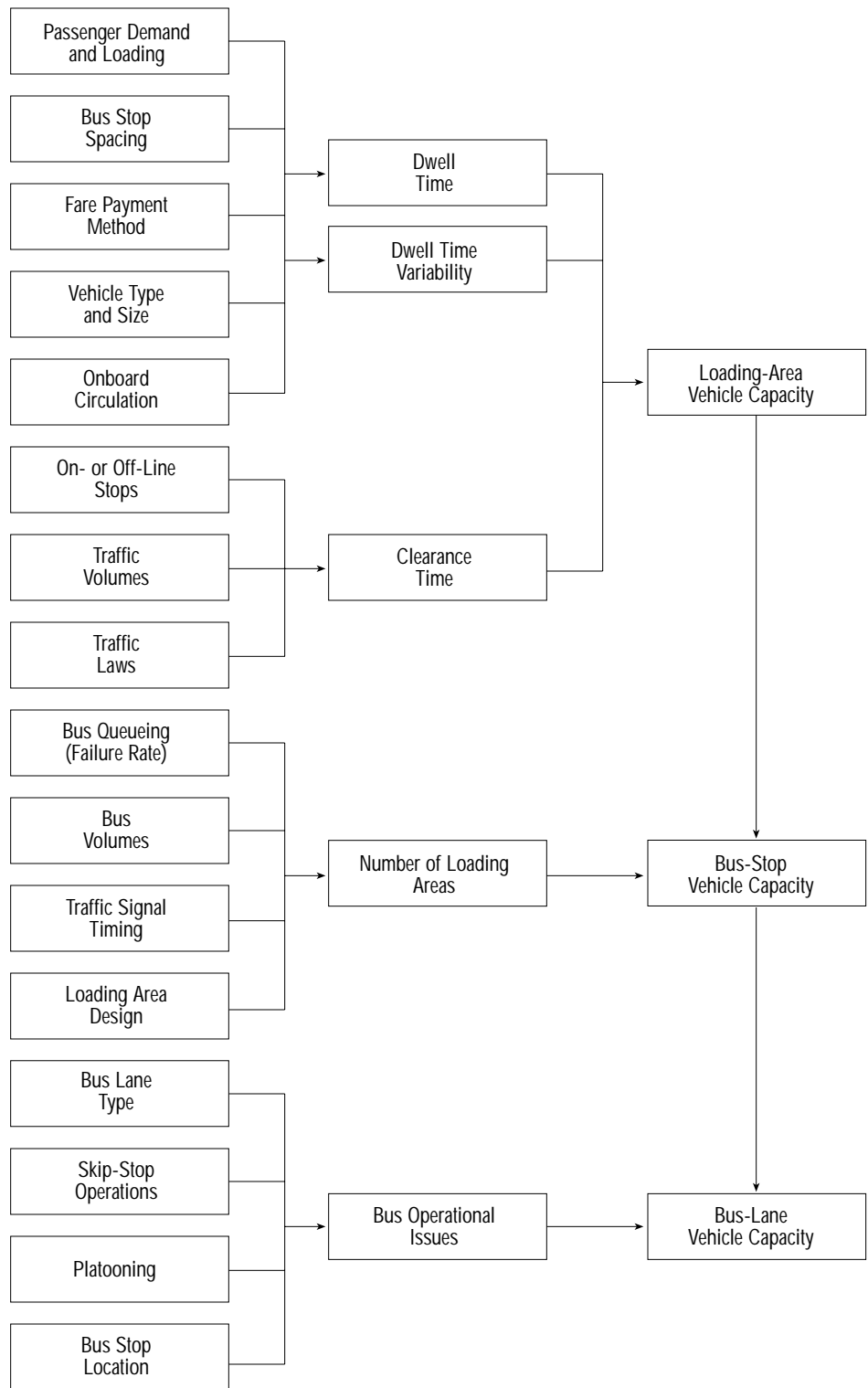

Loading Areas

Exhibit 14-9 identifies the estimated bus vehicle capacity at loading areas, based on various values of dwell time and the ratio of green traffic signal time to total cycle length (g/C ratio). Other values not provided in the exhibit may be interpolated.

EXHIBIT 14-9. ESTIMATED VEHICLE CAPACITY OF ON-STREET LOADING AREAS
(SEE FOOTNOTE FOR ASSUMED VALUES)

Dwell Time (s)	Capacity (buses/h)	
	g/C = 0.50	g/C = 1.00
15	63	100
30	43	63
45	32	46
60	26	36
75	22	30
90	19	25
105	16	22
120	15	20

Note:
Assumes 15-s clearance time, 25 percent queue probability, and 60 percent coefficient of variation of dwell times.

Maximum vehicle capacity of loading areas. Multiply by the peak 15-min passenger boardings and alightings per vehicle and a PHF to obtain person capacity.

Bus Stops

Exhibit 14-10 lists estimated vehicle capacities of on-line linear bus stops. Note that increasing the number of loading areas at a linear bus stop has an ever-decreasing effect on capacity as the number of loading areas increases (i.e., doubling the number of loading areas at a linear bus stop does not double capacity). Nonlinear designs are 100 percent efficient, since doubling the number of loading areas also doubles the capacity of the stop.

EXHIBIT 14-10. ESTIMATED CAPACITY OF ON-LINE LINEAR BUS STOPS
(SEE FOOTNOTE FOR ASSUMED VALUES)

Dwell Time (s)	Capacity (buses/h)									
	g/C 0.50	g/C 1.00	g/C 0.50	g/C 1.00	g/C 0.50	g/C 1.00	g/C 0.50	g/C 1.00	g/C 0.50	g/C 1.00
	Number of On-Line Linear Loading Areas									
	1	2	3	4	5					
30	43	63	79	117	105	154	113	167	115	170
60	26	36	48	67	64	89	69	96	70	98
90	19	25	35	47	46	62	49	67	50	69
120	15	20	27	36	36	48	39	52	39	53

Note:
Assumes 15-s clearance time, 25 percent queue probability, and 60 percent coefficient of variation of dwell times. To obtain the vehicle capacity of nonlinear on-line bus stops, multiply the single loading area values by the number of loading areas provided.

Vehicle capacity of on-line linear bus stops. Multiply by the maximum allowed passenger load per vehicle and a peak-hour factor to obtain maximum person capacity.

Busways

If a busway extends into the CBD and has a limited number of stations in the downtown area, the passenger distribution characteristics will be similar to those of a subway or other rail line. A reasonable design assumption is that 50 percent of the maximum load-point volume is served at the heaviest CBD busway station, assuming a minimum of three stops in the downtown area.

Busway vehicle and person capacities for central areas are given in Exhibit 14-11 for a variety of bus types and service conditions. Data on passenger service times and the effectiveness of linear loading areas are given in Chapter 27. The key assumptions used in the exhibit are:

Exclusive busways with a limited number of CBD stops have passenger distribution characteristics similar to those of subways

This exhibit presents vehicle and person capacities for busways under typical conditions, rather than maximum capacities

- Fares are prepaid at busway stations. This allows all doors to be used for loading, which greatly decreases the service time per passenger, since several passengers may board at the same time.
- Fifty percent of the maximum load-point passengers board at the heaviest stop. A PHF of 0.67 is assumed.
- No delays are due to signals (i.e., it is a grade-separated busway).
- The clearance time is 10 s. The design failure rate is 7.5 percent and a 60 percent coefficient of variation is assumed.
- Three linear loading areas are provided at each station.
- The maximum load-point passenger volume is limited to 40 passengers per bus for standard buses and 60 passengers per bus for articulated buses; this provides a seat for all passengers.

EXHIBIT 14-11. EXAMPLES OF CBD BUSWAY CAPACITIES
(SEE FOOTNOTE FOR ASSUMED VALUES)

Stations: On-Line/Off-Line	Loading Condition							
	A		B		C		D	
	On	Off	On	Off	On	Off	On	Off
	Passengers Boarding at Heaviest Station							
Boarding passengers per bus	20	20	20	20	20	20	30	30
Boarding time per passenger (s)	2.0	2.0	1.2	1.2	0.7	0.7	0.5	0.5
Dwell time (s)	40.0	40.0	24.0	24.0	14.0	14.0	15.0	15.0
	Vehicle Capacity							
Loading area capacity (bus/h)	42	42	65	65	100	100	95	95
Effective loading areas	2.45	2.60	2.45	2.60	2.45	2.60	2.45	2.60
Station capacity (bus/h)	103	109	159	169	245	260	233	247
	Passengers/Hour - Maximum Load Point							
Peak-flow rate (15 min * 4)	4120	4360	6360	6760	9800	10,400	13,980	14,820
Average peak hour (with PHF)	2760	2920	4260	4530	6570	6970	9370	9930

Notes:

Loading Condition A: single-door conventional bus, simultaneously loading and unloading.

Loading Condition B: two-door conventional bus, both doors loading or double-stream doors simultaneously loading and unloading.

Loading Condition C: four-door conventional bus, all double-stream doors loading.

Loading Condition D: six-door articulated bus, all doors loading.

Assumes 10-s clearance time, 7.5 percent failure rate, 60 percent coefficient of variation of dwell times, 3 linear loading areas, g/C = 1.0, PHF = 0.67, 50 percent of passengers board at heaviest CBD station, 40 seats per conventional bus, 60 seats per articulated bus, no standees allowed.

Exclusive Arterial-Street Bus Lanes

Exhibit 14-12 illustrates the effects of dwell time, right-turning volume from the bus lane, and conflicting pedestrian volumes on bus-lane vehicle capacity. It assumes conflicting pedestrian volumes ranging from 100 to 800/h, dwell times of 30 or 60 s, and right-turning volumes of 0 to 400 vehicles, as well as other assumptions, held constant, that are listed in the exhibit. Buses are assumed to stop at every bus stop in the CBD.

It can be seen that as dwell time decreases, bus vehicle capacity increases. Conflicting pedestrian volumes under 200/h have little effect on bus vehicle capacity, but have substantial effects at higher conflicting volumes, especially as right-turning volumes increase. However, when there are no right-turn conflicts, pedestrian volumes have no impact on vehicle capacity, and the lines for a given dwell time converge to a single point. It also can be seen that the lines for a given pedestrian volume converge toward a point at which the right-turn capacity is exceeded and the bus-lane vehicle capacity drops to zero. Between these two extremes, bus vehicle capacity steadily declines as right-turning volumes increase.

EXHIBIT 14-12. EXCLUSIVE BUS-LANE VEHICLE CAPACITY: NON-SKIP-STOP OPERATION
(SEE FOOTNOTE FOR ASSUMED VALUES)

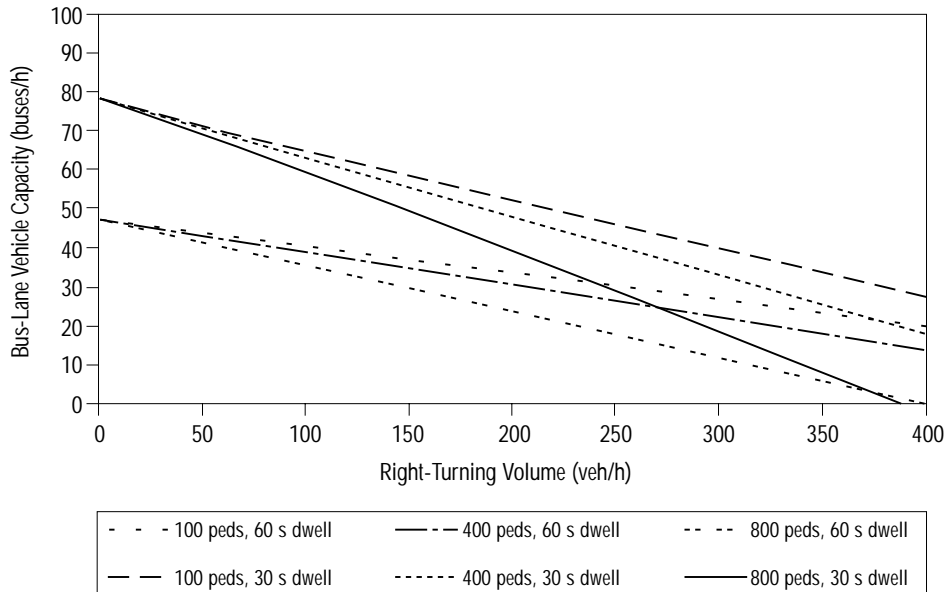

Note:
Assumes 15-s clearance time, 25 percent queue probability, 60 percent coefficient of variation of dwell times, permitted right-turn signal phasing, shared right-turn lane, $g/C = 0.5$, nearside stops, 2 linear berths, and bus volumes minimal in relation to right-turn volumes ($P_{RT} = 1.0$).

Exhibit 14-13 illustrates the same situations with the buses in a two-stop skip-stop operation and the adjacent lane assumed to have a v/c ratio of 0.5. For a given right-turning volume, the corresponding bus-lane vehicle capacity is about 67 percent higher than if skip stops were not used.

Mixed-Traffic Lanes

Exhibit 14-14 depicts the decline in bus vehicle capacity in mixed traffic when curb-lane volumes increase, as well as the variation in bus vehicle capacity by bus stop location. In mixed traffic, off-line linear stops may provide less bus vehicle capacity than on-line stops with identical dwell times, since the benefits of additional loading areas at off-line stops can be outweighed by the additional delay as buses reenter traffic.

BUS PRIORITY TREATMENTS

Bus Preferential Treatments at Intersections

When buses operate in mixed traffic, the interference decreases bus speeds and lowers overall bus-vehicle and person capacity. The bus preferential treatments described in this section compensate by removing or reducing sources of delay, increasing bus speeds. When considering bus preferential treatments, the total change in person delay (both for passengers in buses and for motorists) should be taken into account.

To compute person capacity, multiply the values shown in the exhibits by the allowed passenger load per bus and a peak-hour factor

In mixed traffic, on-line stops may provide greater capacity than off-line stops, depending on traffic volumes and the number of loading areas

Bus priority treatments provide faster, more reliable bus operations, improving passenger quality of service

EXHIBIT 14-13. EXCLUSIVE BUS-LANE VEHICLE CAPACITY: SKIP-STOP OPERATION
(SEE FOOTNOTE FOR ASSUMED VALUES)

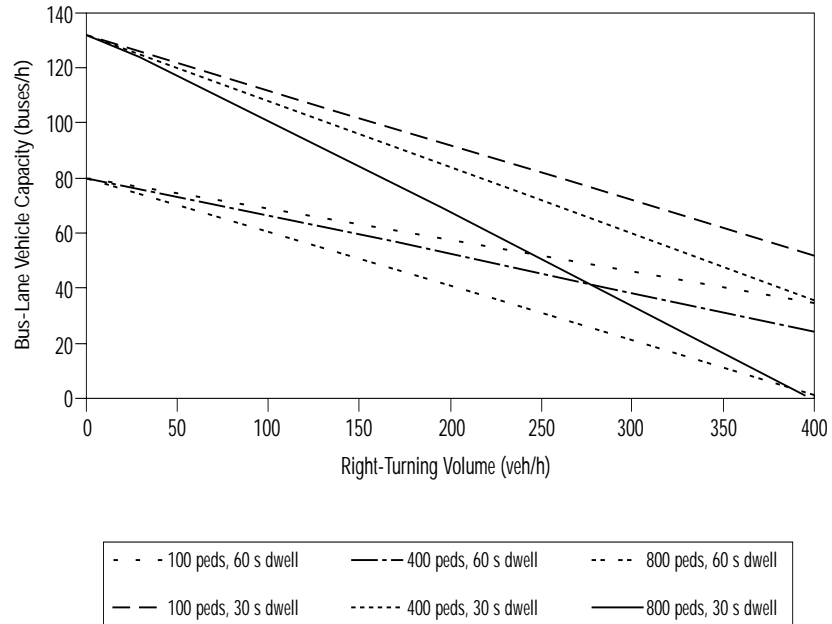

Note:
Assumes 15-s clearance time, 25 percent queue probability, 60 percent coefficient of variation of dwell times, permitted right-turn signal phasing, shared right-turn lane, $g/C = 0.5$, nearside stops, 2 linear berths, $v/c = 0.5$, and bus volumes minimal in relation to right-turn volumes ($P_{RT} = 1.0$).

EXHIBIT 14-14. MIXED-TRAFFIC-LANE BUS VEHICLE CAPACITY
(SEE FOOTNOTE FOR ASSUMED VALUES)

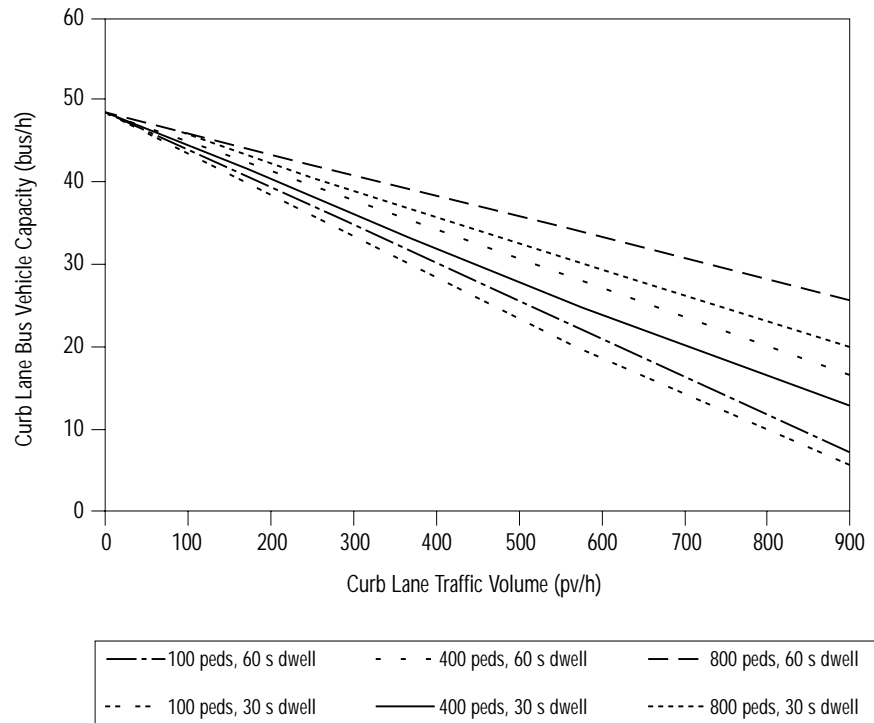

Note:
Assumes a Type 1 mixed bus lane, one linear loading area per stop, $g/C = 0.5$, 30-s dwell time, 25 percent failure rate, and a 60 percent coefficient of variation of dwell times.

To compute maximum person capacity, multiply the values shown by the allowed passenger load per bus and a PHF

The mixed-traffic bus-capacity procedures are an extension of the exclusive bus-lane capacity procedures developed by the Transit Cooperative Research Program A-7 project. The theoretical basis for mixed-traffic procedures has not been validated in the field.

Signal Priority

Bus-signal priority measures at signalized intersections include passive systems, which are pretimed treatments adjusted manually to determine the best transit benefit while minimizing the effect on other vehicles, and active systems, which adjust the signal timing after sensing the arrival of a bus. Exhibit 14-15 lists the most common bus-signal priority systems at intersections.

Bus-signal priority measures can be passive (pretimed) or active (operated when a bus is detected)

EXHIBIT 14-15. BUS-SIGNAL PRIORITY SYSTEMS

Treatment	Description
Passive Priority	
Adjust cycle length	Reduce cycle lengths at isolated intersections
Split phases	Apply multiple phases while maintaining original cycle length
Areawide timing plans	Preferential progression for buses through signal offsets
Bypass metered signals	Buses use special reserved lanes, special signal phases, or are rerouted to nonmetered signals
Active Priority ^a	
Phase extension	Increase phase time
Early start	Reduce other phase times
Special phase	Addition of a bus phase
Phase suppression	Skipped nonpriority phases
Preemption (unconditional)	Bus phase begins when all other intervals are satisfied
Preemption (conditional)	Same as above except certain conditions are used to determine when the bus phase should begin

Note:

a. Occurs after bus detection.

Source: Bullard and Nungesser (10).

Active priority should be implemented only at intersections operating at less than capacity, so that the changes to signal timing whenever a bus passes through the intersection do not worsen the intersection LOS. Automated systems that do not require bus driver intervention are preferable, since drivers might not always remember to activate the system. When coupled with two-way data communication and automatic vehicle location (AVL) equipment, on-bus signal priority systems can be set to activate signal priority only when a bus is behind schedule (11).

Queue Bypass

Queue bypasses allow buses to avoid queues of vehicles (such as those that develop at signalized intersections or freeway ramp meters) by providing a special lane. Queue bypass lanes can be shared with carpools and van pools.

Queue bypasses at freeway ramp meters allow buses to avoid delay

Queue Jump

Queue jumps allow buses to move past long queues of vehicles at signalized intersections by using right-turn lanes or long off-line bus stops. Buses are exempted from any right-turn requirements at the intersection.

Queue jumps allow buses to bypass long queues of vehicles at signalized intersections

A special right-lane signal provides a green indication for a brief time before the green for the adjacent general traffic lanes. The bus then exits the right lane and merges into the lane to the left, ahead of the other traffic still stopped for the signal. Alternatively, the bus can pull into the right-turn lane on a red signal and proceed to a farside off-line bus stop on green, avoiding the delay behind the queue in the regular lanes of the intersection.

Curb extensions allow the bus to stop in the travel lane and provide more room for transit amenities at the bus stop

Boarding islands allow buses to avoid congestion in the right lane but require careful consideration of pedestrian safety

The net change in person delay is an important consideration before implementing transit priority measures

Curb Extensions

Where streets have curbside parking and high traffic volumes, it may not be desirable for a bus to pull to the curb to stop, because it must then wait for a gap in traffic to pull back into the travel lane. In these situations, the curb can be extended into the parking lane so that buses can stop in the travel lane to pick up and discharge passengers. The additional area curbside can provide a clear area to load and unload wheelchair passengers in compliance with the ADA, to provide a bus shelter where otherwise there would not have been enough space, and to provide more room for passengers waiting for the bus. Curb extensions also can create more on-street parking, as the area before the bus stop, previously used for buses to pull to the curb, now can be used for additional parking. If there are bicycle lanes, they can be routed around the curb extension; but this can introduce potential bicycle-pedestrian conflicts. At intersections, curb extensions benefit pedestrians by reducing the width of street to cross.

Boarding Islands

Significant parking activity, stopped delivery vehicles, heavy right-turning traffic volumes, and other interferences often slow traffic in the right lane of a street with multiple lanes in the same direction. In these situations, buses might be able to travel faster in the lane to the left. Boarding islands allow bus stops between travel lanes; buses then can remain in a faster lane without merging to the right before every stop. However, pedestrian safety must be addressed in conjunction with boarding islands.

Other Measures

Other preferential treatments for transit at intersections include the following (11):

- Parking restrictions. When high parking turnover interferes with the flow of traffic on a street, restricting parking will improve transit and traffic flow. However, the impacts on adjacent land uses from the loss of on-street parking also must be considered. Parking restrictions sometimes are applied during peak hours, often in conjunction with bus lane operations.
- Bus stop relocation. On streets with good traffic signal progression for passenger vehicles, moving a bus stop from the nearside to the farside of an intersection may allow buses to use the signal timing to their advantage, passing through intersections on a green signal and dwelling on a red signal.
- Turn restriction exemptions. The most direct route for a bus might not be possible because of left-turn restrictions at intersections, particularly if there is no room to develop left-turn lanes. If this restriction is due to traffic congestion, rather than safety, it might be feasible to exempt buses from the restriction without a negative impact on the intersection's operation.
- Bus lanes, busways, and high-occupancy vehicle (HOV) lanes. Where there is a relatively high volume of buses operating on a roadway, coupled with a high degree of bus and general traffic congestion, exclusive bus lanes might be considered, to provide more attractive and reliable bus service. Most bus lanes take the form of reserved lanes on city streets, usually in the same direction as the general traffic flow. In North America, busways and reserved lanes on freeways are mainly in larger cities, usually with a large downtown employment and a heavy peak-hour bus ridership. HOV lanes either on freeways or on urban streets also can provide higher bus speeds.

Person-Delay Considerations

In many cases, providing transit priority involves tradeoffs among the various users of a roadway. A bus queue jump at a traffic signal, for example, provides a time-saving benefit for bus passengers but causes additional delay for motorists, their passengers, bicyclists, and some pedestrians. Any consideration of transit priority measures should include the net change in person delay to all roadway users as a result of the priority treatment. Of course, other factors, such as cost, change in transit quality of service, and

local policies encouraging transit use, also should be considered. Exhibit 14-16 summarizes the advantages and disadvantages of the bus preferential treatments presented in this section.

EXHIBIT 14-16. COMPARISON OF BUS PREFERENTIAL TREATMENTS

Treatment	Advantages	Disadvantages
Signal Priority	<ul style="list-style-type: none"> Reduces delay Improves reliability 	<ul style="list-style-type: none"> Risks interrupting coordinated traffic signal operation Risks lowering intersection LOS, if intersection is close to capacity Requires ongoing interjurisdiction coordination Buses on cross streets may incur added delay greater than the time saved by the favored route
Queue Bypass	<ul style="list-style-type: none"> Reduces delay from queues at ramp meters or other locations 	<ul style="list-style-type: none"> Bus lane must be available and longer than the back of queue
Queue Jump	<ul style="list-style-type: none"> Reduces delay to queues at signals Buses can leapfrog stopped traffic 	<ul style="list-style-type: none"> Right lane must be available and longer than the back of queue Right-turn or special transit signal required Reduces green time available to other intersection traffic Bus drivers must be alert for the short period of priority green time
Curb Extensions	<ul style="list-style-type: none"> Reduces delay due to merging back into traffic Increases riding comfort because buses don't need to pull in and out of stops Increases on-street parking by eliminating need for taper associated with bus pullouts Increases space for bus stop amenities Reduces pedestrian street crossing distances 	<ul style="list-style-type: none"> Requires at least two travel lanes in bus direction of travel to avoid blocking traffic while passengers board and alight Bicycle lanes require special consideration
Boarding Islands	<ul style="list-style-type: none"> Increases bus speed by allowing buses to use faster-moving left lane 	<ul style="list-style-type: none"> Requires at least two travel lanes in bus direction of travel and a significant speed difference between the two lanes Requires more right-of-way than other treatments Pedestrian and ADA accessibility, comfort, and safety issues must be carefully considered
Parking Restrictions	<ul style="list-style-type: none"> Increases bus and auto speeds by removing delays caused by automobile parking maneuvers 	<ul style="list-style-type: none"> May significantly impact adjacent land uses (both business and residential) Requires ongoing enforcement
Bus-Stop Relocation	<ul style="list-style-type: none"> Uses existing signal progression to bus' advantage 	<ul style="list-style-type: none"> May increase walking distance for passengers transferring to a cross-street bus
Turn Restriction Exemption	<ul style="list-style-type: none"> Increases bus speed by eliminating need for detours to avoid turn restrictions 	<ul style="list-style-type: none"> Potentially lowers intersection LOS Safety issues must be carefully considered
Exclusive Bus Lanes	<ul style="list-style-type: none"> Increases bus speed by reducing sources of delay Improves reliability Increases transit visibility 	<ul style="list-style-type: none"> Traffic and parking effects of eliminating a travel or parking lane must be carefully considered Requires ongoing enforcement

Source: Portland Office of Transportation (11).

III. LIGHT-RAIL AND STREETCAR CONCEPTS

This section provides a brief overview of peak-hour light-rail and streetcar transit ridership in the United States and Canada and its implications for passenger capacity. Streetcars operate exclusively on city streets. Light-rail transit (LRT) started as a modification, separating streetcar operation from street traffic to allow higher speeds.

LRT is characterized by versatility of operation—it can operate separated from other traffic below grade, at grade, on an elevated structure, or together with road vehicles on the surface (12). More detailed information on rail transit ridership and capacity is available in a variety of other resources (9,12–19).

LRT operations differ in station spacing and design, fare structure and collection methods, train length and propulsion, degree of access control, and markets served. Unlike streetcars, travel times between light-rail stations are relatively unaffected by increased passenger volumes or service.

GENERAL CAPACITY RANGES

The capacity of a rail line is determined by station (or stop) capacity or way capacity, whichever is smaller; in most cases, it is station capacity. Capacity depends on car size and station length, allowable standees, and the minimum spacing (or headway) between trains. This minimum headway is a function not only of dwell times at major stations, but also of train length, acceleration and deceleration rates, and train control systems. Exhibit 14-17 illustrates the main factors affecting rail vehicle capacity.

Time-space diagrams can be used to estimate the safe separation or minimum headway between trains. Sometimes theoretical approaches are used. A more common practice is to obtain the minimum spacing between trains based on actual experience, station dwell times, and signal control systems.

The passenger capacity of LRT depends on vehicle size, train length, and headway. However, the achievable LRT capacities also depend on design and policy considerations that reflect specific local constraints of station design, at-grade operations, and type of right-of-way.

If trains operate on-street, capacity estimates can be derived by adapting the equations for bus transit to the differing vehicle sizes, train lengths, and clearance. Capacity estimates for off-street operations may be derived from the approaches for rail transit, described in Chapter 27.

LRT trains usually are limited to a maximum of three cars for on-street operation. Longer trains usually cannot operate on city streets without simultaneously occupying more than the space between adjacent cross streets on short blocks, cannot clear at-grade intersections rapidly, and require long platform lengths at stations.

Minimum headways for light-rail systems depend on train length, platform and car design (high floor versus low floor), fare collection methods (prepayment versus pay on train), wheelchair accessibility, and headway controls (manual versus block signals). Manual operations can accommodate 80 to 100 single-unit cars per track per hour. When trains run under block signal controls, as is common with rapid-transit systems, 120-s headways are possible. Shorter headways can be realized with moving-block signals. Most North American light-rail systems are signaled for a minimum headway of 3 min.

At 120-s headways, a light-rail system operating on mainly reserved right-of-way with three-car trains would have a line capacity of up to 7,500 seated and 15,000 total passengers/h (30 three-car trains at 170 persons/car). Under single-vehicle manual operation at lower speeds, closer headways are feasible. At 60-s headways, single LRT units have a capacity of 4,000 seated and 10,000 total passengers/h (schedule load) (20). However, in practice these capacities are not realized because of lower ridership demands. Typical ranges in person capacities are listed in Exhibit 14-18.

Current operating experience in the United States and Canada suggests maximum realizable capacities of 12,000 to 15,000 persons/track/h. However, European experience shows up to 20,000 persons/h.

One of the variables determining capacity is light-rail and streetcar travel time when operating in two directions using a single track. Chapter 27 provides equations to calculate travel time on a single-track section. Exhibit 14-19 lists values for these variables, where local data are not available. The value of the maximum single-track section speed should be the most appropriate speed limit for that section. A 60-km/h

Train length is constrained by the length of a city block

speed limit is a suitable value for most protected, grade-separated lines. If the single-track section is on-street, then a speed at or below the vehicle speed limit should be used. If there are signalized intersections, an allowance of half the signal cycle should be added to the travel time for each such intersection, adjusted for any improvements possible from preemption.

EXHIBIT 14-17. INFLUENCES ON RAIL VEHICLE CAPACITY

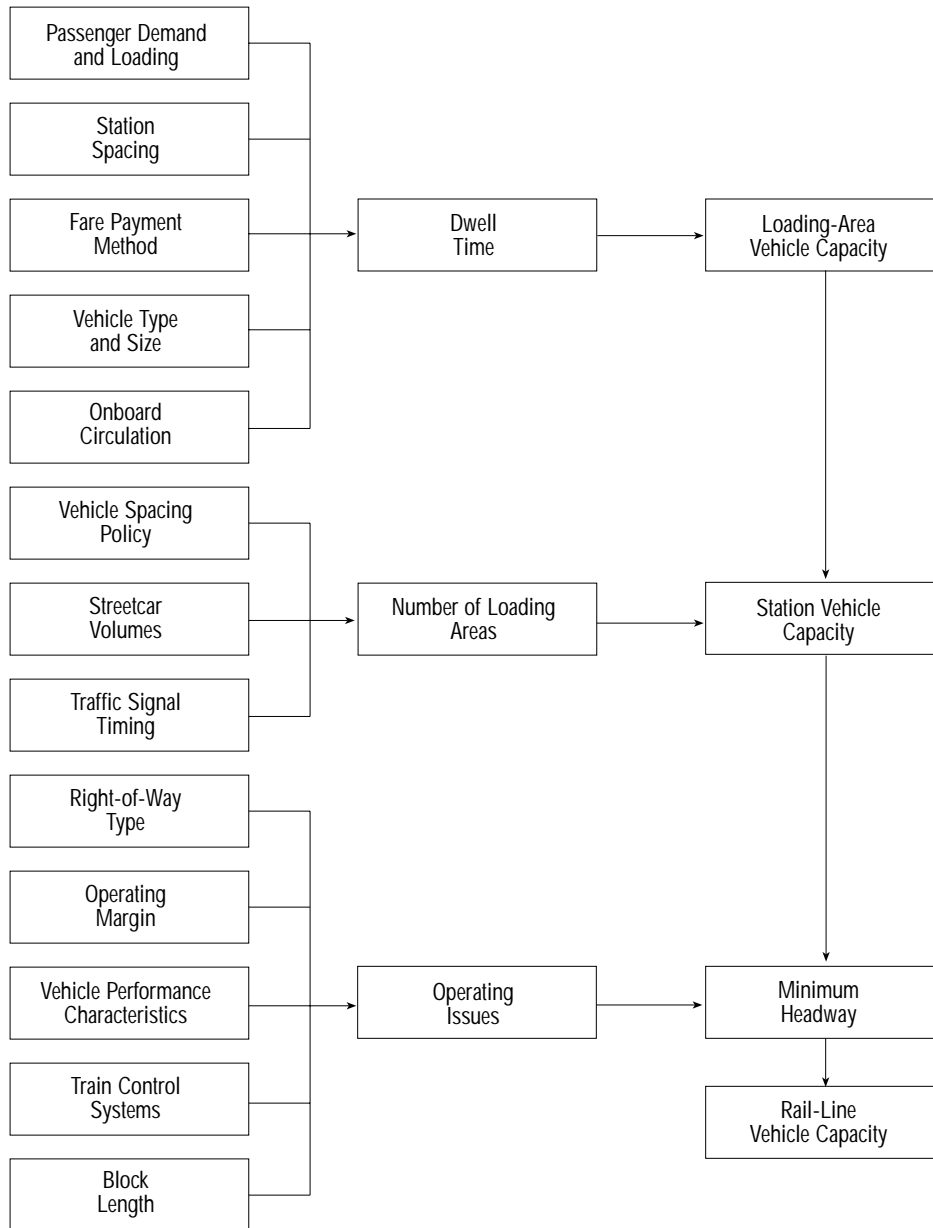

EXHIBIT 14-18. TYPICAL LIGHT-RAIL TRANSIT PERSON CAPACITIES: 30 TRAINS/TRACK/h, 28- TO 30-m ARTICULATED CARS

Cars/ Train	Passengers/Car				
	75 ^a	100	125	150	175
1	2250	3000	3750	4500	5250
2	4500	6000	7500	9000	10,500
3	6750	9000	11,250	13,500	15,750
4	9000	12,000	15,000	18,000	21,000

Note:

a. All passengers seated.

EXHIBIT 14-19. DEFAULT VALUES FOR SINGLE-TRACK LIGHT-RAIL AND STREETCAR TRAVEL TIME

Term	Default Value
Jerk limiting time	0.5 s
Brake system reaction time	1.5 s
Dwell time	15–25 s
Service braking rate	1.3 m/s ²
Speed margin	1.1–1.2
Operating margin	10–30 s

Source: Parkinson and Fisher (12).

RAIL PRIORITY TREATMENTS

Operating variability caused by traffic congestion has been reduced for the recently built on-street light-rail lines that operate in reserved lanes. Some older systems still operate extensively in mixed traffic and are subject to the variability in train throughput caused by a reduced effective green time for trains. Traffic queuing, left turns, and parallel parking can reduce LRT capacity.

Traffic signals can be a major impediment to LRT operation if they are not designed for the needs of LRT. Poor traffic signaling can make train operation slow, unreliable, and unattractive to potential passengers. These problems can be addressed through the use of signal priority or preemption and signal progression. Signal priority allows the light-rail train to extend a green phase or to speed the arrival of the next one. Depending on the frequency of intersections and traffic congestion, this can have a substantial impact on the flow of general traffic. As a result, LRT signal priority in congested areas is often limited in scope to avoid negative effects on other traffic.

Signal progression has supplanted priority or preemption for light-rail trains in many congested downtown areas. This technique gives trains a green window during which they can depart and travel to the next station on successive green signals. The benefits of progression increase with greater station spacing as less accumulated time is spent waiting for the progression to start at each station. The progression frequently is part of the normal traffic-signal phasing and is fully integrated with signaling for automobiles on cross streets. This reduces delays for transit and motorists alike. Station stops are accommodated by the train missing one traffic-signal cycle and then proceeding on the next. Ideally, the cycle length will be slightly longer than a long average dwell, allowing the majority of trains to leave shortly after passenger activity has ended.

IV. QUALITY-OF-SERVICE CONCEPTS

Quality of service reflects the passenger's perception of transit performance. It measures both the availability of transit service and its comfort and convenience. Quality of service depends on the operating decisions made by a transit system, especially concerning where, how often, and for how long service should be provided, and what kind it should be.

Quality of service is a measure of both availability and comfort and convenience

DEFINITIONS

In the North American transit industry, many definitions are not standardized or are specific to a particular system. Caution is needed with the terms quality of service and level of service, which carry a variety of meanings.

This manual uses the following definitions of transit performance measures, transit quality of service, service measures, and LOS:

- Transit performance measure. A quantitative or qualitative factor used to evaluate a particular aspect of transit service.
- Transit quality of service. The overall measured or perceived performance of transit service from the passenger's point of view.
- Transit service measure. A quantitative performance measure that best describes a particular aspect of transit service and represents the passenger's point of view. It is also known as a measure of effectiveness.
- LOS. Six designated ranges of values for a particular service measure, graded from A (best) to F (worst) based on a transit passenger's perception of a particular aspect of transit service.

TRANSIT PERFORMANCE MEASURES

There are as many different transit performance measures as there are transit systems. To understand what quality of service is, it is useful to know what it is not. Exhibit 14-20 illustrates one possible way that transit performance measures can be categorized and shows how quality of service fits into the spectrum of transit performance measures.

The operator point of view encompasses the measures routinely collected in the United States for the Federal Transit Administration's National Transit Database (formerly Section 15) annual reporting process. Most of these measures relate to economy or productivity. These measures are important to the operator, and indirectly to passengers, because they indicate the amount of service an operator can afford to provide on a route or on the system as a whole. The productivity measures (e.g., ridership) indirectly measure passenger satisfaction with the quality of service.

Operator point of view

The vehicle operation includes measures of vehicular speed and delay routinely calculated for streets and highways using the procedures given in this manual. This also includes measures of facility capacity in terms of the number of transit vehicles that can be accommodated.

Vehicle operation

The passenger point of view, or quality of service, directly measures passengers' perception of the availability, comfort, and convenience of transit. There are several possible performance measures, but availability and comfort and convenience are most appropriate for transit. LOS ranges developed for these and other service measures are presented in Chapter 27.

Passenger point of view

QUALITY-OF-SERVICE FRAMEWORK

Transit Trip Decision Making

Urban transport involves many individual decisions. Some decisions occur infrequently, such as planning the commute to a new job, or locating a home outside an area with transit service, or purchasing a second automobile. Some decisions, however, are made for every trip, through a two-step process illustrated in Exhibit 14-21 and Exhibit 14-22.

EXHIBIT 14-20. TRANSIT PERFORMANCE MEASURE CATEGORIES AND EXAMPLES

Transit performance measures apply to the operator, passenger, or vehicle

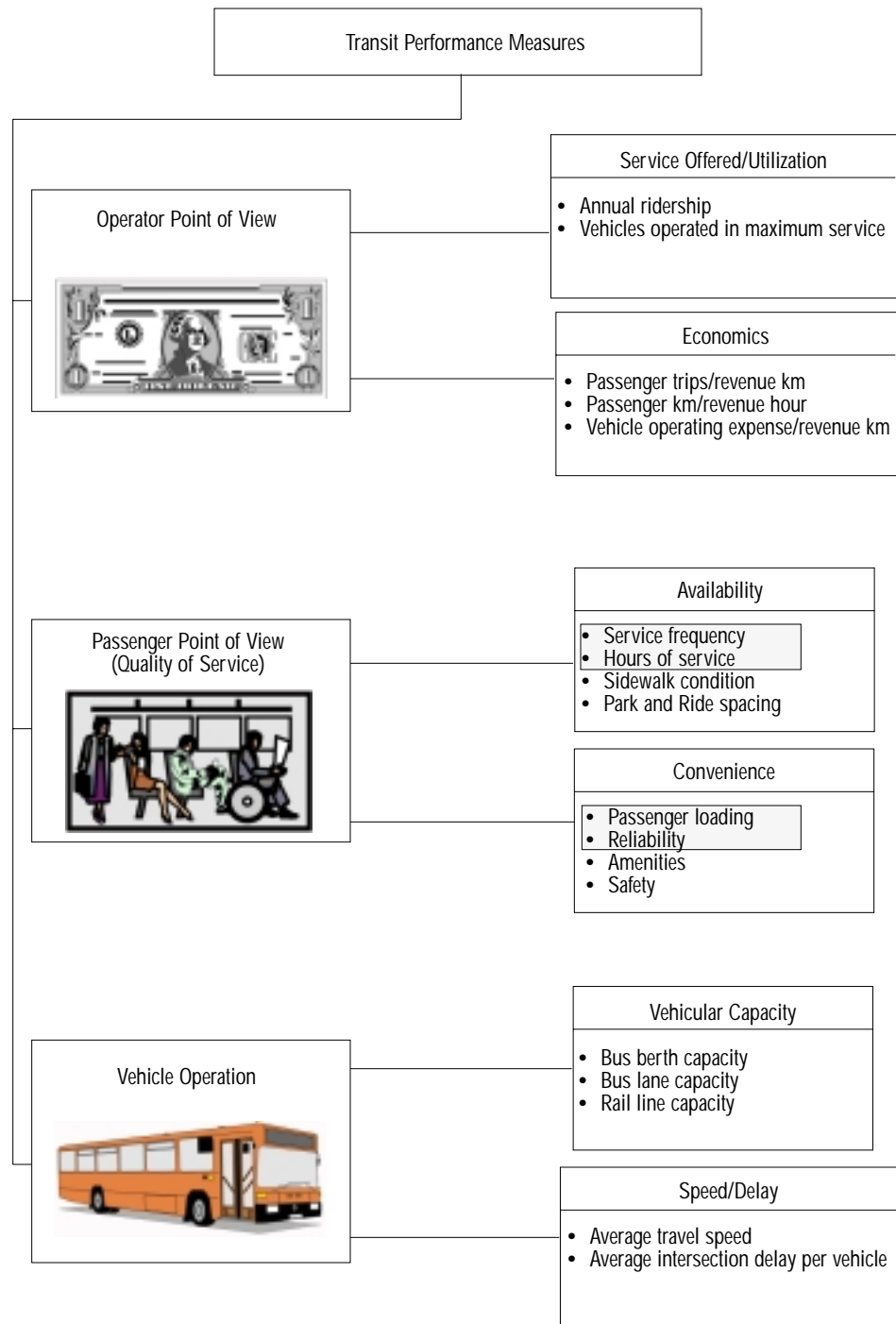

Quality of service reflects the passenger point of view. Levels of service are developed for some of these important passenger performance measures.

EXHIBIT 14-21. TRANSIT TRIP DECISION MAKING: TRANSIT AVAILABILITY

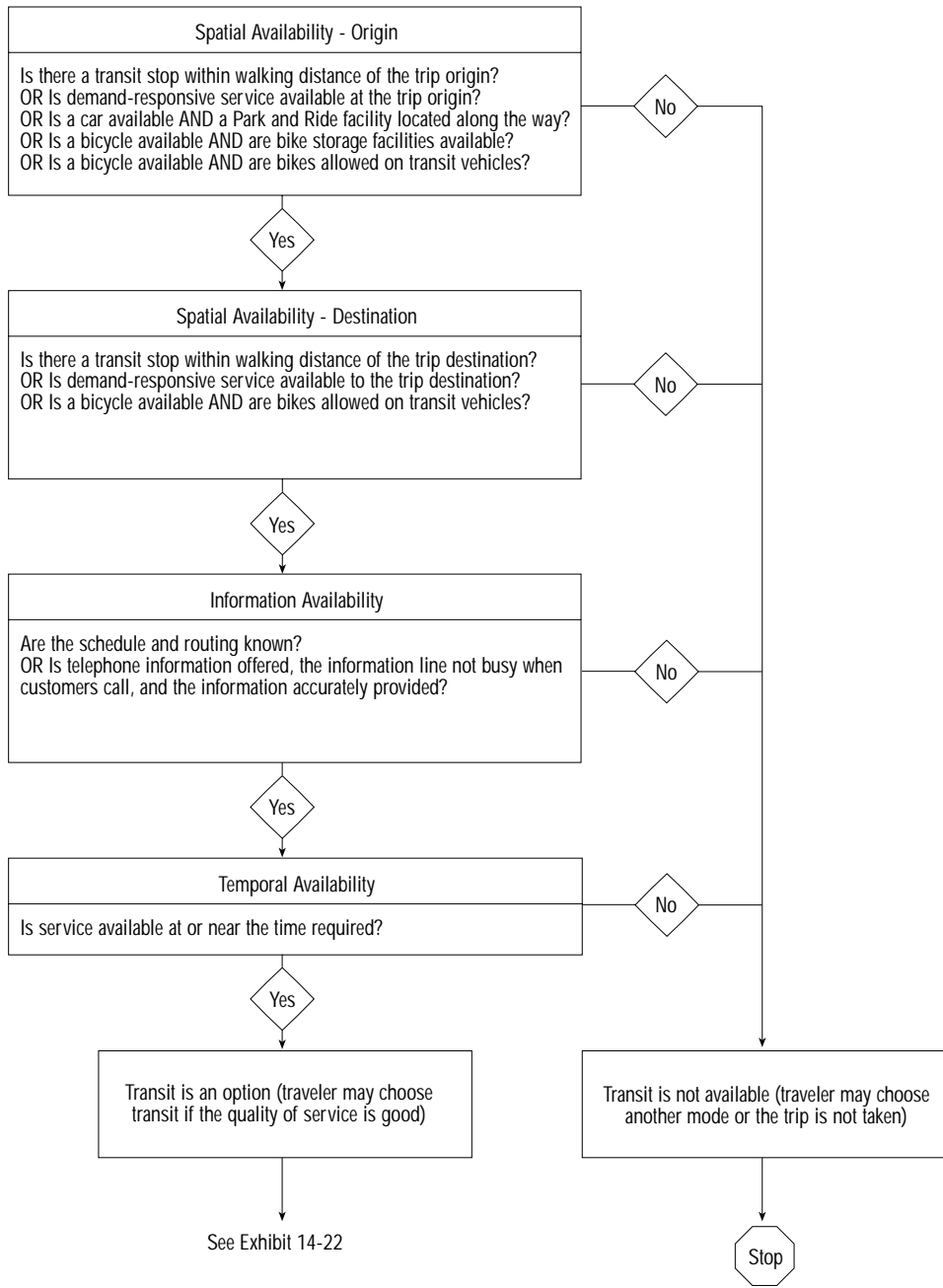

Is transit service available to a potential passenger?

If transit service is available, will a potential passenger find it convenient?

EXHIBIT 14-22. TRANSIT TRIP DECISION MAKING: TRANSIT CONVENIENCE

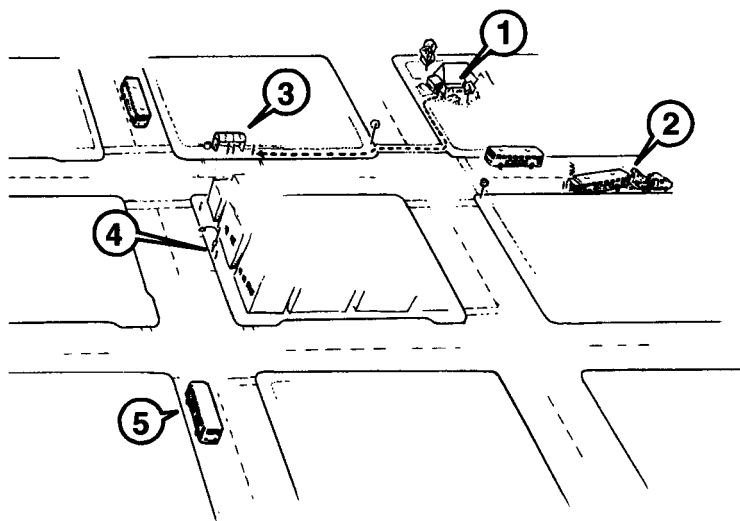

1. How long is the walk? Are there sidewalks and pedestrian signals?
2. Is the service reliable?
3. How long is the wait? Is there a shelter at the stop?
4. Are there security concerns—walking, waiting, or riding?
5. How crowded is the vehicle? Are the vehicles and shelters clean?
 - How much will the trip cost?
 - How many transfers are required?
 - How long will the total trip take? How long would it take with other modes?

The first step is to decide whether or not transit is a possibility—that is, to assess the availability of transit service. As Exhibit 14-21 indicates, there are several factors that enter into this determination. If any factor is not met, transit is not viable and the traveler must either use another mode or not make the trip. However, transit becomes an option if service is available at the trip origin and destination (or the traveler can use another mode to get to and from transit); if information is available on where, when, and how service is provided; and if service is provided at or near the time the trip needs to be made.

In the second step, the decision maker weighs the comfort and convenience of transit service against competing modes, as depicted in Exhibit 14-22. These questions do not necessitate an all-or-nothing outcome. Individuals apply differing values to each factor, and each person weighs the factors differently. Regular transit users familiar with the service tend to perceive transit more favorably than nonusers. In the end, the choice depends on the availability of other modes and how the quality of transit service compares.

Quality-of-Service Factors

Service Coverage

Whether or not transit service is provided near a person's origin and destination is key in use of transit. Ideally, transit service is provided within a reasonable walking distance of the origin and destination, or demand-responsive service is available. The reasonableness of the walking distance varies from source to source and depends on the situation. For example, people will walk farther to rail stations than to bus routes and the elderly will not walk as far as younger adults. As discussed later, potential barriers, such as wide or busy streets, hills, or the absence of pedestrian facilities, also play an important role. In general, 400 m or 5 min of walk time is the limit for a bus route's typical service area; for a rail transit station, these figures can double (21).

If transit service is located too far from a potential passenger, it may not be an option

If transit service is not provided near the origin, other options include driving to a park-and-ride lot or riding a bicycle to transit. Both of these options require that the transit operator provide additional facilities, such as parking lots, bicycle storage facilities, and bicycle racks.

However, if transit service is not provided near the destination, the choices are more limited. A bicycle might be carried in a bicycle rack, but a customer must have some degree of confidence that space will be available in the bike rack when the bus arrives. A small number of systems allow bicycles onboard transit vehicles (typically rail), but often not during peak commute hours or in the peak commute direction.

Pedestrian Environment

Even if a transit stop is located within a reasonable walking distance of an origin and destination, the walking environment may not be amenable. Lack of sidewalks or poorly maintained sidewalks, lack of street lighting, and steep terrain all discourage pedestrian travel. Wide or busy streets without signalized crosswalks at regular intervals, or without pedestrian refuges in the median, also discourage pedestrian travel. A lack of pedestrian refuges poses difficulties, too, for transit operators providing service on urban streets.

Passengers with disabilities must have sidewalk facilities, curb cuts, and bus-stop loading areas that comply with ADA standards for the entire distance between their origin and a transit stop and between their destination and a transit stop, to have access to fixed-route transit. Without these, passengers with disabilities must rely on paratransit service, which generally offers fewer choices in travel times, and usually costs substantially more to provide.

Scheduling

How often and when transit service is provided are important factors in the decision to use transit. The more frequent the service, the shorter the wait when a bus or train is missed or when the exact schedule is not known, and the greater the flexibility customers will have in selecting travel times. The number of hours during the day when service is provided is also important. It does not matter whether a transit stop is located within walking distance if service is not provided at the desired time of travel; transit then cannot be an option.

Amenities

The facilities provided at transit stops and stations and on transit vehicles help make transit more comfortable and convenient. Typical amenities include the following (5):

- Benches, so that passengers can sit while waiting;
- Shelters to protect from wind, rain, snow, and sun;
- Informational signage, identifying the routes, their destinations, and scheduled arrivals;
- Trash receptacles for litter;
- Telephones, so that passengers can make personal calls while waiting or emergency calls when necessary;
- Vending facilities, from newspaper racks at commuter bus stops to manned newsstands, flower stands, food carts, transit ticket and pass sales, and similar facilities at rail stations and bus transfer centers; and
- Air conditioned vehicles, to provide a comfortable ride during hot and humid weather.

Transit operators usually relate the kinds of amenities at a stop to the number of daily riders boarding there. Research has provided guidelines for installing transit amenities (5). These amenities and their space requirements should be considered when determining the size of passenger waiting areas at transit stops.

Driving or biking to transit may be an option

Service coverage must consider both ends of a trip

Even if transit service is theoretically located within walking distance of both origin and destination, the areas around the transit stops must provide a comfortable walking environment for transit to be considered available

Transit service must be available near the time of a trip or it cannot be an option

Transit stop amenities make transit service more comfortable and convenient
The kinds of amenities provided are generally related to the number of boarding passengers at a stop

Riders need to know where and when transit service is available and how to use it

Transfers can make service more efficient for operators but less convenient for passengers

A longer trip by transit than by automobile may be seen by passengers as being less convenient. This may be mitigated if the onboard transit time can be used productively.

Passengers' perceptions of safety must be considered in addition to actual conditions

Transit Information

Potential riders need to know where and when transit service is available before they can begin using the service. Regular riders also should be informed about service changes that affect them. This information can be provided by a variety of means:

- Printed maps, schedules, and brochures. Passengers can pick these up on transit vehicles, at transit facilities, and at local businesses.
- Posted information on vehicles and at transit facilities. As transit systems adopt AVL systems, they can display schedule information onboard buses, at bus stops, and at bus terminals.
- Telephone. Information should be available by phone at the convenience of potential passengers (including weekends and evenings).
- Personal computers. Transit information can be posted on the Internet, and users can subscribe to e-mail lists that automatically send out service changes and other announcements.

Transfers

Requiring transfers between routes adds to a passenger's total trip time; this can be minimized with timed transfers. A missed transfer also can increase the length of a transit trip. Required transfers increase the complexity of a transit trip for a first-time passenger. Transfer surcharges also inhibit ridership.

Total Trip Time

Total trip time includes the travel time from the origin to a transit stop, waiting time for a transit vehicle, travel time onboard a vehicle, travel time from transit to the destination, and any time required for transfers between routes during the trip. In general, both the absolute travel time and the travel time in relation to competing modes will factor in a traveler's decision about transit. However, the apparent inconvenience of a longer transit trip can be mitigated if the passenger can use the time onboard productively—for example, reading, preparing or reviewing work, or even catching up on sleep.

Total trip time is influenced by several factors, including the route spacing (affecting the walking distance to transit), the service frequency (affecting the waiting time), the frequency of stops, traffic congestion, signal timing, and the fare collection system (affecting time onboard).

Cost

Potential passengers weigh the cost and value of using transit against the out-of-pocket costs and value of using other modes. Out-of-pocket transit costs consist of the fare for each trip or the cost of a monthly pass. Out-of-pocket automobile costs, in contrast, only include road and bridge tolls and parking charges, because other automobile costs—such as fuel, maintenance, insurance, taxes, and the automobile's purchase price—generally are not part of the consideration for a particular trip. Thus, if a person does not have to pay a toll and parking is free, transit may appear less desirable because driving incurs no immediate out-of-pocket costs.

Safety and Security

Riders' perceptions—as well as the actual conditions—of the safety and security of transit enter into the mode-choice decision. Riders consider not only personal safety in relation to potential transit crime and vehicular crashes, but also such personal irritants as unruly passengers or someone else's loud radio. Security can be improved by placing stops in well-lit areas with public telephones available for emergency calls. Transit systems use a variety of methods to enhance security on transit vehicles, including uniformed and plainclothes police officers, community volunteer programs, two-way radios and silent alarms for emergency communication, and video cameras.

Passenger Loads

Transit is less attractive when passengers must stand for long periods of time, especially in crowds. Crowded vehicles also slow down transit operation, adding time for passengers to get on and off. Most transit agencies assess passenger crowding based on the occupancy relative to the number of seats, expressed as a load factor. A factor of 1.0 means that all seats are occupied. The importance of vehicle loading varies by the type of service. In general, transit provides load factors at or below 1.0 for long-distance commuting and high-speed, mixed-traffic operations. Inner-city service may approach a load factor of 2.0 or more, but other services will be between 1.0 and 2.0. Because the number of seats varies among otherwise identical rail vehicles operated by different transit systems, rail capacity calculations apply passengers per unit of vehicle length more often than load factors.

Appearance and Comfort

Having clean, graffiti-free transit stops, stations, and vehicles improves transit's image, even among nonriders. Some transit systems have established specific standards for transit facility appearance and cleanliness and also have established inspection programs (22,23). Passengers are interested in ride comfort, which includes seat comfort, temperature control, and minimizing the amount of vehicle acceleration and deceleration.

Reliability

Reliability affects the amount of time passengers must wait at a transit stop, as well as the consistency of a passenger's arrival time at a destination from day to day. Reliability encompasses on-time performance as well as the regularity of headways between successive transit vehicles. Uneven headways result in uneven passenger loadings, so that a transit vehicle arriving late picks up not only its regular passengers but others who have arrived early for the following vehicle. As a result, the vehicle falls further and further behind schedule. In contrast, the vehicles following will have lighter-than-normal passenger loads and will tend to run ahead of schedule.

Reliability is influenced by traffic conditions (in on-street, mixed-traffic operations), staff availability and vehicle maintenance (reflecting whether a vehicle can leave the yard or is likely to break down on the road), and by how well vehicle operators adhere to schedules.

Framework

Transit quality-of-service measures are divided into two main categories: availability, and comfort and convenience. According to the measures addressing spatial and temporal availability, if transit is located too far away or if it does not run at the times it is needed, a potential user would not consider the transit service available, and therefore the quality of service would be poor. However, if transit service is available, the quality measures to evaluate user perceptions of comfort and convenience can be applied.

The different elements of a transit system require different performance measures:

- Transit stops. Measures should address transit availability and convenience at a single location. The performance measures in this category will vary from one location to another, since they depend on passenger volumes, scheduling, routing, and stop and station design.
- Route segments. Measures should address availability and convenience along a portion of a route, which can range from two stops to the entire length. These measures will tend to stay the same for the length of a route segment, regardless of conditions at an individual stop.
- Systems. Measures should describe availability and convenience for more than one route in a specified area (e.g., a district, city, or metropolitan area) or for a specified type of service (e.g., fixed route vs. demand responsive). System measures also can address door-to-door travel.

The availability of seating on a transit vehicle is important for longer trips

Reliability includes both on-time performance and the consistency of headways between transit vehicles

Combining the two performance measure categories with the three transit system elements produces the matrix shown in Exhibit 14-23.

EXHIBIT 14-23. TRANSIT QUALITY-OF-SERVICE FRAMEWORK

Category	Service & Performance Measures		
	Transit Stop	Route Segment	System
Availability	<ul style="list-style-type: none"> • Frequency^a • Accessibility • Passenger loads 	<ul style="list-style-type: none"> • Hours of service^a • Accessibility 	<ul style="list-style-type: none"> • Service coverage • % person-minutes served
Comfort and Convenience	<ul style="list-style-type: none"> • Passenger loads^a • Amenities • Reliability 	<ul style="list-style-type: none"> • Reliability^a • Travel speed • Transit/auto travel time 	<ul style="list-style-type: none"> • Transit/auto travel time • Travel time • Safety

Note:

a. Service measure which defines the corresponding LOS in Chapter 27.

Some measures appear in more than one cell of the table, but only one service measure is assigned to each cell, as best representing the passenger’s point of view of availability or convenience. In total, there are four transit service measures: frequency, hours of service, passenger loads, and reliability.

Availability

Transit Stops

The spatial aspect of transit availability at a transit stop is a given. During a typical hour-long analysis period, the hours of service are also a given. Therefore, frequency is the service measure for this category.

Although not easy to quantify, transit stop accessibility by foot, bicycle, or automobile is also an important measure of availability; moreover, persons with disabilities require special consideration. Passenger loads determine whether there is room for additional passengers to board, another aspect of transit availability.

Route Segments

Of the three primary measures of transit availability as shown in Exhibit 14-23—frequency, hours of service, and service coverage—frequency is used for transit stops, and service coverage is a given, since the route exists. Therefore, hours of service become the service measure for route segments. This is appropriate, since more than one route, each operating with different frequencies and travel times, can serve the same origins and destinations. In these cases, the focus is on the total span of time during which a given pair of origins and destinations can be accessed.

As with transit stops, accessibility to transit routes by foot, bicycle, automobile, and wheelchair is important. Because pedestrian and bicycle access can vary significantly from one stop to the next, access by these modes is better addressed on a stop-by-stop basis. In contrast, in the same amount of time it takes to walk or bike to a stop, motorists can choose among several stops to drive to, park, and board transit. As long as one of these stops meets the needs, the motorist has access to transit. The vehicle equipment used along a route helps determine whether or not fixed-route transit service is available to persons with disabilities. All new U.S. transit buses must meet ADA requirements, but older buses in a fleet might not.

System

System availability measures relate to how many people have access to transit and how often. Service coverage within a transit area that has a population or job density to support at least hourly bus service (equivalent to a service frequency LOS E) is chosen as the service measure. Service coverage determines how many people within the service

Frequency as service measure

Hours of service as service measure

Service coverage as service measure

area have access to transit. Once the areas with service have been identified, frequency and hours of service can be used to determine the amount of service within smaller areas. The combination of frequency, hours of service, and service coverage together provide a reasonable planning-level assessment of the availability of transit service, requiring a minimum of data collection and analysis.

Comfort and Convenience

Transit Stops

Whether or not one can find a seat on a transit vehicle is an important measure of transit comfort. Passenger loads, the selected service measure, also influence boarding and alighting times, which in turn affect total dwell time and the capacity of transit routes.

The amenities provided at transit stops are another aspect of transit comfort but are not a service measure because they depend on the daily boarding volumes at a given stop. Achieving better levels of service would require facilities that might not be justified economically. Reliability is a measure of convenience at a transit stop but also applies to a transit route and will tend to have consistent values for a series of stops along a route segment.

Route Segments

Reliability is used as the service measure for route segments because it not only measures an aspect of service quality important to users, whether or not they get to their destination on time, but also affects other service measures. If transit vehicles arrive in a bunch, or not at all, the effective service frequency is reduced. Vehicles arriving late also have higher passenger loadings, since they pick up not only their regular passengers but others who have arrived early for the next vehicle.

Other measures of transit convenience on a route segment are the travel time difference between transit and automobile (used as the system service measure) and travel speed, both of which relate to the time it takes to make a trip by transit. Travel speed is also important to transit operators. For example, if bus speeds can increase sufficiently along a higher-frequency route to produce a time savings of one headway, the number of buses required to operate the route can decrease, along with the operating costs.

System

The travel time difference between transit and automobile (the absolute difference in travel time from origin to destination by automobile and by transit) is an important consideration in a passenger's decision to use transit. Systemwide, this measure can be calculated by sampling locations and trip purposes within the analysis area, or by using a transportation planning model that can calculate trip times for all combinations of origins and destinations by transit and by automobile, for a variety of trip purposes.

An alternative performance measure is travel time, useful for indicating when higher-speed service (such as limited-stop or express service) should be considered between two locations. Since travel time varies with the size of a community and the amount of traffic congestion (for transit modes operating in mixed traffic), travel time is not suitable as a service measure without defining different categories of city sizes. Safety, in terms of both accident and crime rates, affects the image of the entire transit system and is another systemwide comfort and convenience measure.

Chapter 27 presents specific threshold levels and applications for the service measures related to transit facilities (transit stops and route segments). Chapters 29 and 30 describe applications for service measures related to transit systems. Specific threshold levels for system-related transit service measures are found in the *Transit Capacity and Quality of Service Manual (1)*.

Passenger loads as service measure

Reliability as service measure

V. REFERENCES

1. *Transit Capacity and Quality of Service Manual*. Transit Cooperative Research Program (TCRP) Web Document No. 6, TRB, National Research Council, Washington, D.C., 1999. Online. Available: <http://www4.nationalacademies.org/trb/crp.nsf/all+projects/tcrp+a-15>
2. *National Transportation Statistics*. Bureau of Transportation Statistics. U.S. Department of Transportation, Washington, D.C., 1996.
3. Levinson, H. S., and K. R. St. Jacques. Bus Lane Capacity Revisited. In *Transportation Research Record 1618*, TRB, National Research Council, Washington, D.C., 1998, pp. 189–199.
4. Morrall, J., and D. Bolger. The Relationship Between Downtown Parking Supply and Transit Use. *ITE Journal*, Vol. 66, No. 2, February 1996, pp. 32–36.
5. Fitzpatrick, K., K. Hall, D. Perkinson, and L. Nowlin. *TCRP Report 19: Guidelines for the Location and Design of Bus Stops*. TRB, National Research Council, Washington, D.C., 1996.
6. *Highway Accident Summary Report: Bus Collision with Pedestrians, Normandy, Missouri, June 11, 1997*. Report PB98-916201, National Transportation Safety Board, Washington, D.C., 1998.
7. St. Jacques, K., and H. S. Levinson. *TCRP Report 26: Operational Analysis of Bus Lanes on Arterials*. TRB, National Research Council, Washington, D.C., 1997.
8. *Special Report 209: Highway Capacity Manual*. TRB, National Research Council, Washington, D.C., 1985.
9. Homburger, W. S. (ed.). *Transportation and Traffic Engineering Handbook*, 2nd ed. Prentice-Hall, Inc., Englewood Cliffs, N.J., 1982.
10. Bullard, D. L., and L. G. Nungesser. *Texas Public Transit Reference Manual*. Technical Report 1082-1F, Texas State Department of Highways and Public Transportation, Austin, 1985.
11. *City of Portland, Transit Preferential Streets Program Sourcebook: Guidelines for Implementing Transit Preferential Streets Measures*. Office of Transportation, Portland, Ore., 1997.
12. Parkinson, T., and I. Fisher. *TCRP Report 13: Rail Transit Capacity*. TRB, National Research Council, Washington D.C., 1996.
13. Atkinson, W. G. (ed.). *Canadian Transit Handbook*, 3rd ed. Canadian Urban Transit Association, Toronto, Ontario, Canada, 1993.
14. *Capacities and Limitations of Urban Transportation Modes: An Informational Report*. Institute of Traffic Engineers, Washington, D.C., 1965.
15. Pushkarev, B., and J. Zupan. *Where Rail Transit Works*. Regional Plan Association, New York, N.Y., 1978.
16. Pushkarev, B. S., J. M. Zupan, and R. Cumella. *Urban Rail in America: A Regional Plan Association Book*. Indiana University Press, Bloomington, 1982.
17. Rainville, W. S., W. S. Homburger, and D. C. Hyde. Preliminary Progress Report of Transit Subcommittee, Committee of Highway Capacity. *HRB Proc.*, Vol. 40, Highway Research Board, Washington, D.C., 1961, pp. 523–540.
18. Vuchic, V. R. *Urban Public Transportation: Systems and Technology*. Prentice-Hall Inc., Englewood Cliffs, N.J., 1981.
19. Vuchic, V., F. Day, and B. Anderson. *Theoretical and Practical Capacities of Transit Modes*. Intersociety Committee on Transportation, Atlanta, Ga., July 14–18, 1975.
20. Diamant, E. L. *Light Rail Transit: State of the Art Review*. Report No. DOT UT 50009, DeLeuw, Cather & Co., 1976.

21. O'Sullivan, S., and J. Morrall. Walking Distances to and from Light-Rail Transit Stations. In *Transportation Research Record 1538*, TRB, National Research Council, Washington, D.C., 1996, pp. 19–26.
22. Danaher, A., T. Parkinson, P. Ryus, and L. Nowlin. Appendix to Interim Report: Literature Review. In *TCRP A-15: Development of Transit Capacity and Quality of Service Principles, Practices, and Procedures*. Available from TCRP. TRB, National Research Council, Washington, D.C., 1997.
23. Weinstein, A., and R. Albom. Securing Objective Data on the Quality of the Passenger Environment for Transit Riders: Redesign of the Passenger Environment Measurement System for the Bay Area Rapid Transit District. In *Transportation Research Record 1618*, TRB, National Research Council, Washington, D.C., 1998, pp. 213–219.

CHAPTER 15

URBAN STREETS

CONTENTS

I. INTRODUCTION	15-1
Scope of the Methodology	15-1
Limitations of the Methodology	15-1
II. METHODOLOGY	15-1
LOS	15-2
Determining Urban Street Class	15-3
Determining Running Time	15-3
Determining Delay	15-3
Uniform Delay	15-5
Incremental Delay	15-5
Initial Queue Delay	15-5
Arrival Type and Platoon Ratio	15-5
Progression Adjustment Factor	15-6
Incremental Delay Adjustment for Actuated Controls	15-7
Upstream Filtering or Metering Adjustment Factor, I	15-8
Determining Travel Speed	15-8
Determining LOS	15-9
Sensitivity of Results to Input Variables	15-9
III. APPLICATIONS	15-12
Segmenting the Urban Street	15-13
Computational Steps	15-13
Planning Applications	15-14
Analysis Tools	15-15
IV. EXAMPLE PROBLEMS	15-15
Example Problem 1	15-16
Example Problem 2	15-18
Example Problem 3	15-20
Example Problem 4	15-22
Example Problem 5	15-24
APPENDIX A. PLANNING APPLICATION COMPUTATIONS	15-25
APPENDIX B. TRAVEL TIME STUDIES FOR DETERMINING LOS	15-27
APPENDIX C. WORKSHEETS	15-28
Urban Street Worksheet	
Travel-Time Field Worksheet	

EXHIBITS

Exhibit 15-1. Urban Street Methodology	15-2
Exhibit 15-2. Urban Street LOS by Class	15-3
Exhibit 15-3. Segment Running Time per Kilometer	15-4
Exhibit 15-4. Relationship Between Arrival Type and Platoon Ratio (R_p)	15-6
Exhibit 15-5. Progression Adjustment Factors for Uniform Delay Calculation	15-7
Exhibit 15-6. k-Value for Controller Type	15-8
Exhibit 15-7. Recommended I-Values for Lane Groups with Upstream Signals	15-8
Exhibit 15-8. Speed-Flow Curves for Class I Urban Streets	15-10
Exhibit 15-9. Speed-Flow Curves for Class II Urban Streets	15-10

Exhibit 15-10. Speed-Flow Curves for Class III Urban Streets	15-11
Exhibit 15-11. Speed-Flow Curves for Class IV Urban Streets	15-11
Exhibit 15-12. Change in Mean Speed for Arrival Types	15-12
Exhibit 15-13. Types of Urban Street Segments	15-13
Exhibit 15-14. Urban Street Worksheet	15-14
Exhibit A15-1. Urban Street LOS Calculations	15-26
Exhibit B15-1. Travel-Time Field Worksheet	15-28

I. INTRODUCTION

SCOPE OF THE METHODOLOGY

This chapter provides a methodology for analyzing urban streets. This methodology also may be used to analyze suburban streets that have a traffic signal spacing of 3.0 km or less. Both one-way and two-way streets can be analyzed with this methodology; however, each travel direction of the two-way street requires a separate analysis.

The methodology described in this chapter can be used to assess mobility on an urban street. The degree of mobility provided is assessed in terms of travel speed for the through-traffic stream. A street's access is not assessed with this methodology. However, the level of access provided by a street also should be considered when evaluating its performance, especially if the street is intended to provide access. Factors that favor mobility often reflect minimal levels of access and vice versa.

The methodology described in this chapter focuses on mobility; urban streets with mobility tend to be at least 3 km long (or in downtown areas, 1.5 km). A shorter street also may be analyzed; however, it is likelier that its primary function is access. Access can be evaluated to some degree through an analysis of the individual intersections along the street.

LIMITATIONS OF THE METHODOLOGY

The urban streets methodology does not directly account for the following conditions that can occur between intersections:

- Presence or lack of on-street parking;
- Driveway density or access control;
- Lane additions leading up to, or lane drops leading away from, intersections;
- The impact of grades between intersections;
- Any capacity constraints between intersections (such as a narrow bridge);
- Midblock medians and two-way left-turn lanes;
- Turning movements that exceed 20 percent of the total volume on the street;
- Queues at one intersection backing up to and interfering with the operation of an upstream intersection; and
- Cross-street congestion blocking through traffic.

Because any one of these conditions might have a significant impact on the speed of through traffic, the analyst should modify the methodology to incorporate the effects as best as possible.

II. METHODOLOGY

This methodology provides the framework for the evaluation of urban streets. If field data on travel times are available, this framework can be used to determine the street's level of service (LOS). Also, the direct measurement of the travel speed along an urban street can provide an accurate estimate of LOS without using the computations presented in this chapter.

Urban street traffic models can be used as alternative sources for field data, provided that the input parameters—such as running times and saturation flow rates—are determined according to the procedures in this manual, and that the calculated or estimated delay and the delay outputs are based on the definitions and equations in this manual or have been validated by field data. Exhibit 15-1 illustrates the basic method for determining LOS on an urban street.

Background and underlying concepts for this chapter are in Chapter 10

For queue estimation method, see Chapter 16, Appendix G

EXHIBIT 15-1. URBAN STREET METHODOLOGY

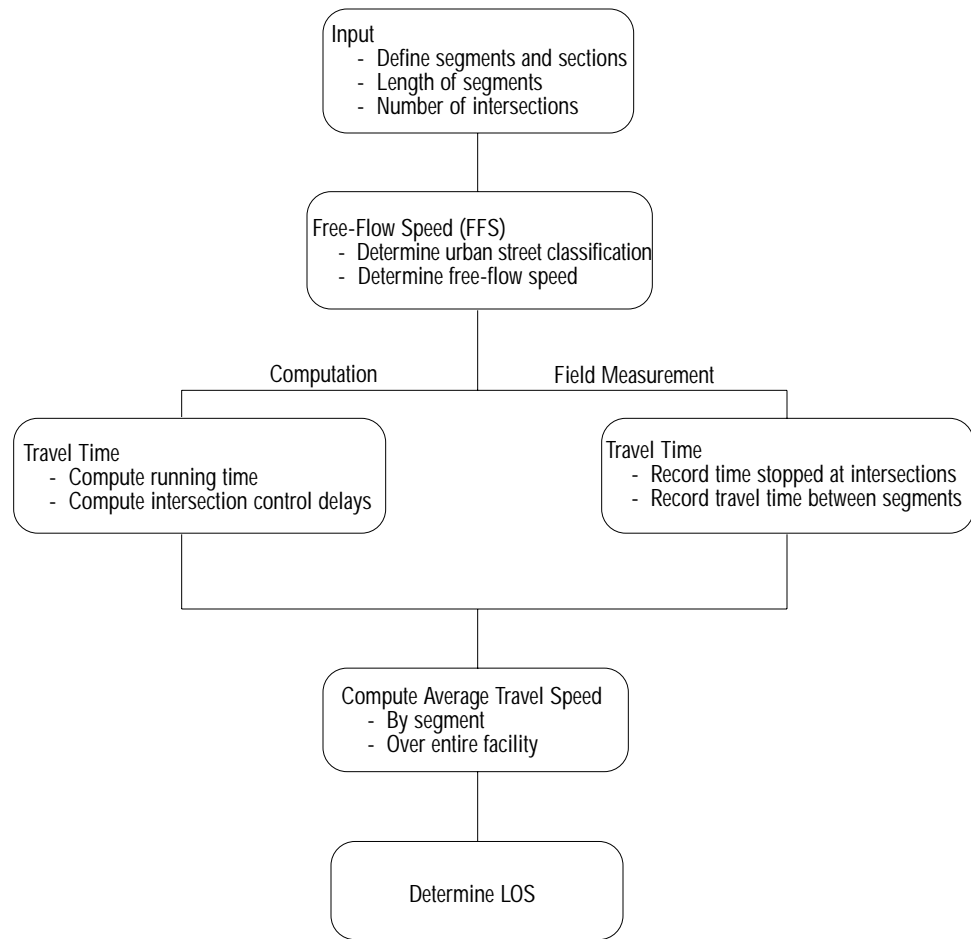

The analyst should be able to investigate the effect of signal spacing, street classification, and traffic flow on LOS. The methodology uses the signalized intersection procedure presented in Chapter 16 for the through-traffic lane group. By redefining the lane arrangement (e.g., presence or absence of left-turn lanes, number of lanes), the analyst can influence which traffic flow is in the through-traffic lane group as well as the capacity of the lane group. This redefinition, in turn, influences the street LOS by changing the intersection evaluation and possibly the street classification.

LOS

Urban street LOS is based on average through-vehicle travel speed for the segment or for the entire street under consideration. Travel speed is the basic service measure for urban streets. The average travel speed is computed from the running times on the urban street and the control delay of through movements at signalized intersections.

The control delay is the portion of the total delay for a vehicle approaching and entering a signalized intersection that is attributable to traffic signal operation. Control delay includes the delays of initial deceleration, move-up time in the queue, stops, and re-acceleration.

The LOS for urban streets is influenced both by the number of signals per kilometer and by the intersection control delay. Inappropriate signal timing, poor progression, and increasing traffic flow can degrade the LOS substantially. Streets with medium-to-high signal densities (i.e., more than one signal per kilometer) are more susceptible to these factors, and poor LOS might be observed even before significant problems occur. On the

Control delay

Through vehicles

other hand, longer urban street segments comprising heavily loaded intersections can provide reasonably good LOS, although an individual signalized intersection might be operating at a lower level. The term through vehicle refers to all vehicles passing directly through a street segment and not turning.

Exhibit 15-2 lists urban street LOS criteria based on average travel speed and urban street class. It should be noted that if demand volume exceeds capacity at any point on the facility, the average travel speed might not be a good measure of the LOS. The street classifications identified in Exhibit 15-2 are defined in the next section.

EXHIBIT 15-2. URBAN STREET LOS BY CLASS

Urban Street Class	I	II	III	IV
Range of free-flow speeds (FFS)	90 to 70 km/h	70 to 55 km/h	55 to 50 km/h	55 to 40 km/h
Typical FFS	80 km/h	65 km/h	55 km/h	45 km/h
LOS	Average Travel Speed (km/h)			
A	> 72	> 59	> 50	> 41
B	> 56-72	> 46-59	> 39-50	> 32-41
C	> 40-56	> 33-46	> 28-39	> 23-32
D	> 32-40	> 26-33	> 22-28	> 18-23
E	> 26-32	> 21-26	> 17-22	> 14-18
F	≤ 26	≤ 21	≤ 17	≤ 14

Travel speed defines LOS on urban streets

DETERMINING URBAN STREET CLASS

The first step in the analysis is to determine the urban street's class. This can be based on direct field measurement of the FFS or on an assessment of the subject street's functional and design categories. A procedure for measuring the FFS is described in Appendix B.

If the FFS measurements are not available, the street's functional and design categories must be used to identify its class. The functional category is identified first, followed by the design category. This identification uses the definitions provided in Chapter 10 and Exhibit 10-4. After determining the functional and design categories, the urban street class can be established using Exhibit 10-3.

DETERMINING RUNNING TIME

There are two principal components of the total time that a vehicle spends on a segment of an urban street: running time and control delay at signalized intersections. To compute the running time for a segment, the analyst must know the street's classification, its segment length, and its FFS. The segment running time then can be found by using Exhibit 15-3.

Within each urban street class there are several influences on actual running time. Exhibit 15-3 shows the effect of street length. In addition, the presence of parking, side friction, local development, and street use can affect running time. In this chapter, these also are assumed to influence the FFS. Direct observation of the FFS, therefore, includes the effect of these factors and, by implication, their effect on the running speed.

If it is not possible to observe the FFS on the actual or a comparable facility, default values are given in a note to Exhibit 15-3.

DETERMINING DELAY

Computing the urban street or section speed requires the intersection control delays. Because the function of an urban street is to serve through traffic, the lane group for through traffic is used to characterize the urban street.

Running time is estimated using FFS, urban street classification, and arterial segment length

EXHIBIT 15-3. SEGMENT RUNNING TIME PER KILOMETER

Urban Street Class	I			II			III		IV		
	90 ^a	80 ^a	70 ^a	70 ^a	65 ^a	55 ^a	55 ^a	50 ^a	55 ^a	50 ^a	40 ^a
Average Segment Length (m)	Running Time per Kilometer (s/km)										
100	b	b	b	b	b	b	-	-	-	129	159
200	b	b	b	b	b	b	88	91	97	99	125
400	59	63	67	66	68	75	75	78	77	81	96
600	52	55	61	60	61	67	d	d	d	d	d
800	45	49	57	56	58	65	d	d	d	d	d
1000	44	48	56	55	57	65	d	d	d	d	d
1200	43	47	54	54	57	65	d	d	d	d	d
1400	41	46	53	53	56	65	d	d	d	d	d
1600	40 ^c	45 ^c	51 ^c	51 ^c	55 ^c	65 ^c	d	d	d	d	d

Notes:

a. It is best to have an estimate of FFS. If there is none, use the table above, assuming the following default values:

For Class	FFS (km/h)
I	80
II	65
III	55
IV	45

- b. If a Class I or II urban street has a segment length less than 400 m, (a) reevaluate the class and (b) if it remains a distinct segment, use the values for 400 m.
 - c. For long segment lengths on Class I or II urban streets (1600 m or longer), FFS may be used to compute running time per kilometer. These times are shown in the entries for a 1600-m segment.
 - d. Likewise, Class III or IV urban streets with segment lengths greater than 400 m should first be reevaluated (i.e., the classification should be confirmed). If necessary, the values above 400 m can be extrapolated.
- Although this table does not show it, segment running time depends on traffic flow rates; however, the dependence of intersection delay on traffic flow rate is greater and dominates in the computation of travel speed.

The control delay for the through movement is the appropriate delay to use in an urban street evaluation. In general, the analyst should have this information because the intersections should have been evaluated individually as part of the overall analysis. Equation 15-1 is used to compute control delay. Equations 15-2 and 15-3 are used to compute uniform delay and incremental delay, respectively.

$$d = d_1(PF) + d_2 + d_3 \tag{15-1}$$

$$d_1 = \frac{0.5C \left(1 - \frac{g}{C}\right)^2}{1 - \left[\min(1, X) \frac{g}{C}\right]} \tag{15-2}$$

$$d_2 = 900T \left[(X - 1) + \sqrt{(X - 1)^2 + \frac{8kIX}{cT}} \right] \tag{15-3}$$

where

- d = control delay (s/veh);
- d_1 = uniform delay (s/veh);
- d_2 = incremental delay (s/veh);
- d_3 = initial queue delay, see Chapter 16 (s/veh);
- PF = progression adjustment factor (Exhibit 15-5);
- X = volume to capacity (v/c) ratio for the lane group (also termed degree of saturation);
- C = cycle length (s);
- c = capacity of lane group (veh/h);
- g = effective green time for lane group (s);
- T = duration of analysis period (h);

- k = incremental delay adjustment for the actuated control; and
 l = incremental delay adjustment for the filtering or metering by upstream signals.

Uniform Delay

Equation 15-2 gives an estimate of control delay assuming perfectly uniform arrivals and a stable flow. It is based on the first term of Webster's delay formulation and is accepted as an accurate depiction of delay for the ideal case of uniform arrivals. Values of X greater than 1.0 are not used in the computation of d_1 .

The v/c ratio (X) for a lane group cannot be greater than 1.0 to compute uniform delay

Incremental Delay

Equation 15-3 estimates the incremental delay due to nonuniform arrivals and individual cycle failures (i.e., random delay) as well as delay caused by sustained periods of oversaturation (i.e., oversaturation delay). The equation interrelates the degree of saturation (X) of the lane group, the duration of the analysis (T), the capacity of the lane group (c), and the signal control (k). The equation assumes that all demand flow has been serviced in the previous analysis period—that is, there is no initial queue. If there is, Appendix F of Chapter 16 offers procedures to account for the effect of an initial queue. The incremental delay term is valid for all degrees of saturation.

Initial Queue Delay

When a queue from the previous period is present at the start of the analysis, newly arriving vehicles experience initial queue delay. This delay results from the additional time required to clear the initial queue. Its magnitude depends on the size of the initial queue, the length of the analysis period, and the v/c ratio for that period. A procedure for determining the initial queue delay also is described in Appendix F of Chapter 16.

See also Appendix F of Chapter 16

Arrival Type and Platoon Ratio

A critical characteristic that must be quantified for the analysis of an urban street or signalized intersection is the quality of the progression. The parameter that describes this characteristic is the arrival type, AT, for each lane group. This parameter approximates the quality of progression by defining six types of dominant arrival flow.

Arrival Type 1 is characterized by a dense platoon of more than 80 percent of the lane group volume arriving at the start of the red phase. This arrival type represents network links that experience a poor rate of progression due to various conditions, including lack of coordination.

Arrival Type 2 is characterized by a moderately dense platoon that arrives in the middle of the red phase or by a dispersed platoon of 40 to 80 percent of the lane group volume arriving throughout the red phase. This arrival type represents an unfavorable progression along an urban street.

Arrival Type 3 consists of random arrivals in which the main platoon contains less than 40 percent of the lane group volume. This arrival type represents operations at noninterconnected, signalized intersections with highly dispersed platoons. It also may be used to represent a coordinated operation with minimal benefits of progression.

Arrival Type 4 consists of a moderately dense platoon that arrives in the middle of the green phase or of a dispersed platoon of 40 to 80 percent of the lane group volume arriving throughout the green phase. This arrival type represents a favorable progression along an urban street.

Arrival Type 5 is characterized by a dense to moderately dense platoon of more than 80 percent of the lane group volume arriving at the start of the green phase. This arrival type represents a highly favorable progression, which may occur on routes with a low-to-moderate number of side street entries and which receive high priority in signal timing.

Six arrival types

Arrival Type 6 is reserved for exceptional progression quality on routes with near-ideal characteristics. It represents dense platoons progressing over several closely spaced intersections with minimal or negligible side street entries.

Arrival type is best observed in the field but can be approximated by examining time-space diagrams for the street. The arrival type should be determined as accurately as possible because it has a significant impact on delay estimates and LOS determination. Although there are no definitive parameters to quantify arrival type, the ratio defined by Equation 15-4 is useful.

$$R_p = P \left(\frac{C}{g} \right) \tag{15-4}$$

where

- R_p = platoon ratio,
- P = proportion of all vehicles arriving during green,
- C = cycle length (s), and
- g = effective green time for movement (s).

The value for P may be estimated or observed in the field, whereas C and g are computed from the signal timing. The value of P may not exceed 1.0. The approximate ranges of R_p relate to arrival type as shown in Exhibit 15-4, which also suggests default values for use in subsequent computations.

EXHIBIT 15-4. RELATIONSHIP BETWEEN ARRIVAL TYPE AND PLATOON RATIO (R_p)

Arrival Type	Range of Platoon Ratio (R_p)	Default Value (R_p)	Progression Quality
1	≤ 0.50	0.333	Very poor
2	> 0.50–0.85	0.667	Unfavorable
3	> 0.85–1.15	1.000	Random arrivals
4	> 1.15–1.50	1.333	Favorable
5	> 1.50–2.00	1.667	Highly favorable
6	> 2.00	2.000	Exceptional

Progression Adjustment Factor

Good signal progression results in the arrival of a high proportion of vehicles on the green; poor signal progression results in the arrival of a low proportion of vehicles on the green. The progression adjustment factor, PF , applies to all coordinated lane groups, whether the control is pretimed or nonactuated in a semiactuated system. Progression primarily affects uniform delay; for this reason, the adjustment is applied only to d_1 . The value of PF may be determined by Equation 15-5.

$$PF = \frac{(1 - P)f_{PA}}{\left(1 - \frac{g}{C}\right)} \tag{15-5}$$

where

- PF = progression adjustment factor,
- P = proportion of all vehicles arriving during green,
- g/C = effective green-time ratio, and
- f_{PA} = supplemental adjustment factor for platoon arrival during the green.

The value of P may be measured in the field or estimated from the time-space diagram. The value of PF also may be computed from measured values of P using the default values for f_{PA} . Alternatively, Exhibit 15-5 may be used to determine PF as a function of the arrival type based on the default values for P and f_{PA} associated with each arrival type. If PF is estimated by Equation 15-5, its value may not exceed 1.0 for Arrival

Type 4 with extremely low values of g/C ; as a practical matter, PF should be assigned a maximum value of 1.0 for Arrival Type 4.

EXHIBIT 15-5. PROGRESSION ADJUSTMENT FACTORS FOR UNIFORM DELAY CALCULATION

Green Ratio (g/C)	Arrival Type (AT)					
	AT 1	AT 2	AT 3	AT 4	AT 5	AT 6
0.20	1.167	1.007	1.000	1.000	0.833	0.750
0.30	1.286	1.063	1.000	0.986	0.714	0.571
0.40	1.445	1.136	1.000	0.895	0.555	0.333
0.50	1.667	1.240	1.000	0.767	0.333	0.000
0.60	2.001	1.395	1.000	0.576	0.000	0.000
0.70	2.556	1.653	1.000	0.256	0.000	0.000
f_{PA}	1.00	0.93	1.00	1.15	1.00	1.00
Default, R_p	0.333	0.667	1.000	1.333	1.667	2.000

Notes:

$$PF = (1 - P)f_{PA} / (1 - g/C).$$

Tabulation is based on default values of f_p and R_p .

$$P = R_p * g/C \text{ (may not exceed 1.0).}$$

PF may not exceed 1.0 for AT 3 through AT 6.

The progression adjustment factor, PF, requires knowledge of offsets, travel speeds, and intersection signalization. When delay is estimated for future coordination, particularly when analyzing alternatives, Arrival Type 4 should be assumed as a base condition for coordinated lane groups (except for left turns), and Arrival Type 3 should be assumed for all uncoordinated lane groups.

For movements made from exclusive left-turn lanes on exclusive phases, the progression adjustment factor usually should be 1.0 (i.e., Arrival Type 3). However, if the signal coordination provides for a progression of left-turn movements, the progression adjustment factor should be computed from the estimated arrival type, as for through movements. When the coordinated left turn is part of protected-permitted phasing, only the effective green for the protected phase should be used to determine the progression adjustment factor, since the protected phase normally is associated with platooned coordination. A flow-weighted average of P should be used in determining PF when a time-space diagram is used and lane group movements have different levels of coordination.

Incremental Delay Adjustment for Actuated Controls

In Equation 15-3 the term k incorporates the effect of the controller on delay. For pretimed signals, a k-value of 0.50 is used. This is based on queuing with random arrivals and on uniform service equivalent to the lane group capacity. Actuated controllers, however, can tailor the green time to the current demand, reducing the overall incremental delay. The delay reduction depends in part on the controller's unit extension and the degree of saturation. Research has indicated that lower unit extensions (i.e., snappy intersection operation) result in lower values of k and d_2 . However, when the degree of saturation approaches 1.0, an actuated controller will act like a pretimed controller, producing k-values of 0.50 at degrees of saturation greater than or equal to 1.0. Exhibit 15-6 illustrates the k-values recommended for actuated controllers with different unit extensions and degrees of saturation.

For unit extension values not listed in Exhibit 15-6, the k-values may be interpolated. If the formula in Exhibit 15-6 is used, the k_{min} value (i.e., the k-value for $X = 0.50$) first should be interpolated for the unit extension and then the formula should be used. Exhibit 15-6 may be extrapolated for unit extension values beyond 5.0 s, but the extrapolated k-value never should exceed 0.50.

Guidelines on arrival type for future conditions

For pretimed signals, $k = 0.50$

EXHIBIT 15-6. k-VALUE FOR CONTROLLER TYPE

Unit Extension (s)	Degree of Saturation (X)					
	≤ 0.50	0.60	0.70	0.80	0.90	≥ 1.0
≤ 2.0	0.04	0.13	0.22	0.32	0.41	0.50
2.5	0.08	0.16	0.25	0.33	0.42	0.50
3.0	0.11	0.19	0.27	0.34	0.42	0.50
3.5	0.13	0.20	0.28	0.35	0.43	0.50
4.0	0.15	0.22	0.29	0.36	0.43	0.50
4.5	0.19	0.25	0.31	0.38	0.44	0.50
5.0 ^a	0.23	0.28	0.34	0.39	0.45	0.50
Pretimed or Nonactuated Movement	0.50	0.50	0.50	0.50	0.50	0.50

Notes:

For a unit extension and its k_{min} value at $X = 0.5$: $k = (1 - 2k_{min})(X - 0.5) + k_{min}$, where $k \geq k_{min}$, and $k \leq 0.5$.

a. For a unit extension more than > 5.0 , extrapolate to find k , keeping $k \leq 0.5$.

Upstream Filtering or Metering Adjustment Factor, I

The incremental delay adjustment term I in Equation 15-4 accounts for the effects of filtered arrivals from upstream signals. An I-value of 1.0 is used for an isolated intersection (i.e., one that is 1.6 km or more from the nearest upstream signalized intersection). This value is based on a random number of vehicles arriving per cycle so that the variance in arrivals equals the mean.

An I-value of less than 1.0 is used for nonisolated intersections. This reflects the way that upstream signals decrease the variance in the number of arrivals per cycle at the subject (i.e., downstream) intersection. As a result, the amount of delay due to random arrivals is reduced.

Exhibit 15-7 lists I-values for nonisolated intersections. The values of I in this exhibit are based on X_u , the weighted v/c ratio of all upstream movements contributing to the volume in the subject intersection lane group. This ratio is computed as a weighted average with the v/c ratio of each contributing upstream movement weighted by its volume. For the analysis of urban street performance, it is sufficient to approximate X_u as the v/c ratio of the upstream through movement.

EXHIBIT 15-7. RECOMMENDED I-VALUES FOR LANE GROUPS WITH UPSTREAM SIGNALS

I	Degree of Saturation at Upstream Intersection, X_u						
	0.40	0.50	0.60	0.70	0.80	0.90	≥ 1.0
I	0.922	0.858	0.769	0.650	0.500	0.314	0.090

Note: $I = 1.0 - 0.91 X_u^{2.68}$ and $X_u \leq 1.0$.

DETERMINING TRAVEL SPEED

Equation 15-6 is used on each segment and on the entire section to compute the travel speed.

$$S_A = \frac{3600L}{T_R + d} \quad (15-6)$$

where

- S_A = average travel speed of through vehicles in the segment (km/h);
- L = segment length (km);
- T_R = total of running time on all segments in defined section (s); and
- d = control delay for through movements at the signalized intersection (s).

In special cases, there might be midblock delays caused by vehicle stops at pedestrian crosswalks, or other delays caused by bus stops or driveways. These other delays can be added to the denominator of Equation 15-6.

Other delay can be an additional term in the denominator of Equation 15-6

DETERMINING LOS

There is a distinct set of urban street LOS criteria for each urban street class. These criteria are based on the differing expectations that drivers have for the different kinds of urban streets. Both the FFS of the urban street class and the intersection LOS definitions are taken into account. Exhibit 15-2 gives the LOS criteria for each urban street class. These criteria vary with the class: the lesser the urban street (i.e., the higher its classification number), the lower the driver's expectation for that facility and the lower the speed associated with the LOS. Thus, a Class III urban street provides LOS B at a lower speed than a Class I urban street.

The analyst should be aware of this in explaining before-and-after assessments of urban streets that have been upgraded. If reconstruction upgrades a facility from Class II to Class I, it is possible that the LOS will not change (or may even decline), despite the higher average speed and other improvements, because the expectations would be higher.

The concept of overall urban street LOS is meaningful only when all segments on the urban street are in the same class.

SENSITIVITY OF RESULTS TO INPUT VARIABLES

The following speed-flow curves illustrate the sensitivity of travel speed to

- FFS,
- v/c ratio,
- Signal density, and
- Urban street class.

Exhibits 15-8 through 15-11 use the v/c ratio to plot the through movement in the peak direction at the critical intersection on an urban street. The critical intersection is the intersection with the highest through v/c ratio. The through capacity of an intersection on the urban street is computed using Equation 15-7.

$$c = N * s * \frac{g}{C} \quad (15-7)$$

where

- c = capacity of the through lane (veh/h),
- N = number of through lanes at the intersection,
- s = adjusted saturation flow per through lane (veh/h), and
- g/C = effective green time per cycle for the through movement at the intersection.

The capacity of an urban street is defined for a single direction of travel as the capacity of the through movement at its lowest point (usually at a signalized intersection). The capacity is determined by the number of lanes, the saturation flow rate per lane (influenced by geometric design and demand factors), and the green time per cycle for the through movement at the intersection.

The cycle length also can affect the urban street capacity. Longer cycle lengths generally allow a greater portion of the available green time for the through movement, but still provide for pedestrian clearance times, phase-change intervals, and vehicle clearance times.

Signal coordination (i.e., the quality of progression) generally improves urban street speeds and LOS. Improved coordination, however, does not generally increase urban street capacity by itself—the g/C ratio for the major street also must be improved by the coordination plan.

EXHIBIT 15-8. SPEED-FLOW CURVES FOR CLASS I URBAN STREETS
(SEE FOOTNOTE FOR ASSUMED VALUES)

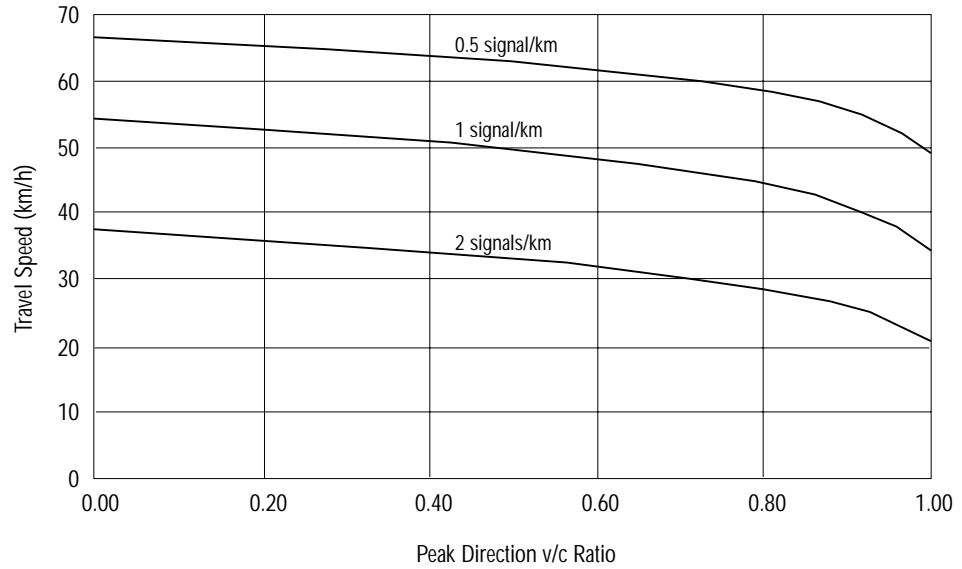

Note:
Assumptions: 80-km/h midblock FFS, 10-km length, 120-s cycle length, 0.45 g/C, Arrival Type 3, isolated intersections, adjusted saturation flow rate of 1,700 veh/h, 2 through lanes, analysis period of 0.25 h, pretimed signal operation.

EXHIBIT 15-9. SPEED-FLOW CURVES FOR CLASS II URBAN STREETS
(SEE FOOTNOTE FOR ASSUMED VALUES)

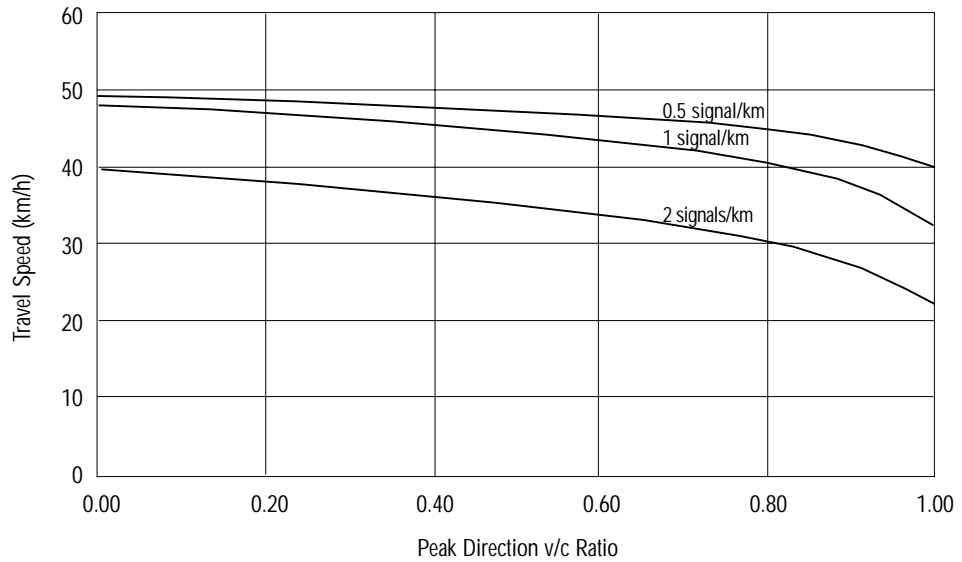

Note:
Assumptions: 65-km/h midblock FFS, 10-km length, 120-s cycle length, 0.45 g/C, Arrival Type 3, isolated intersections, adjusted saturation flow rate of 1,700 veh/h, 2 through lanes, analysis period of 0.25 h, pretimed signal operation.

Increased signal density generally lowers urban street speeds and LOS but does not affect capacity, unless the added signals have lower g/C ratios, or lower saturation flow rates, for the through movements.

EXHIBIT 15-10. SPEED-FLOW CURVES FOR CLASS III URBAN STREETS
(SEE FOOTNOTE FOR ASSUMED VALUES)

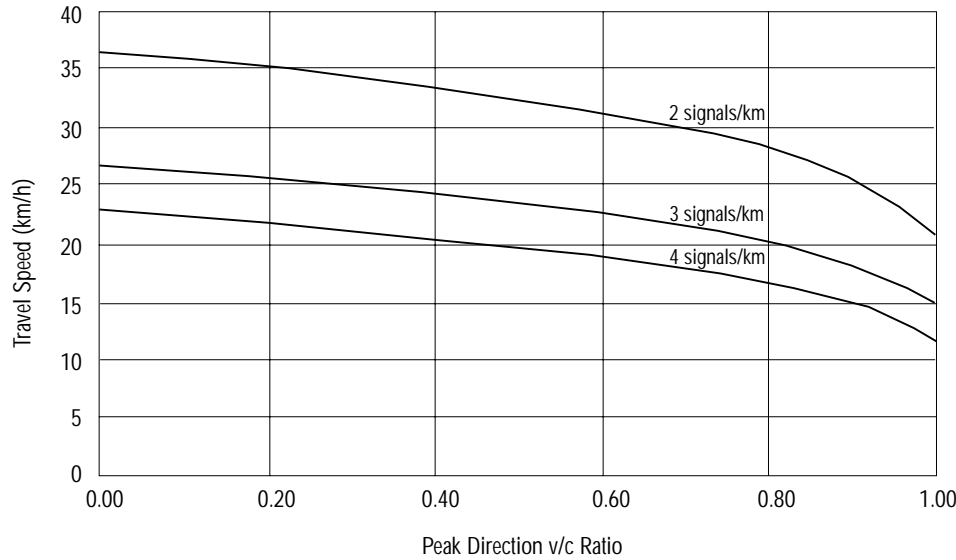

Note:
Assumptions: 55-km/h midblock FFS, 10-km length, 120-s cycle length, 0.45 g/C, Arrival Type 3, isolated intersections, adjusted saturation flow rate of 1,700 veh/h, 2 through lanes, analysis period of 0.25 h, pretimed signal operation.

EXHIBIT 15-11. SPEED-FLOW CURVES FOR CLASS IV URBAN STREETS
(SEE FOOTNOTE FOR ASSUMED VALUES)

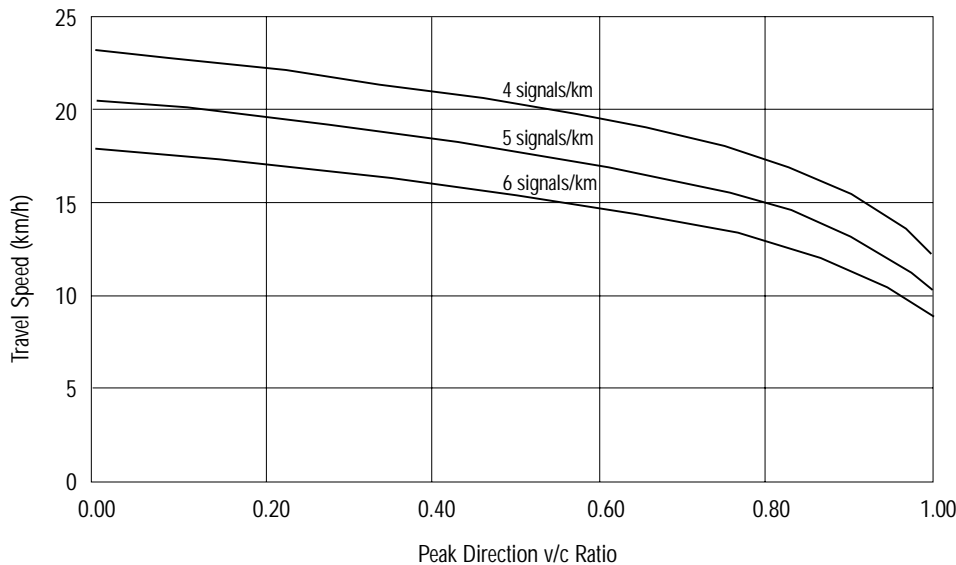

Note:
Assumptions: 50-km/h midblock FFS, 10-km length, 120-s cycle length, 0.45 g/C, Arrival Type 4, isolated intersections, adjusted saturation flow rate of 1,700 veh/h, 2 through lanes, analysis period of 0.25 h, pretimed signal operation.

Exhibits 15-8, 15-9, 15-10, and 15-11 show how signal density and intersection v/c ratios for urban street through movements affect the mean travel speeds for the different street classes. The signal timing and street design assumptions used in computing these specific curves are listed as footnotes. For computational convenience, it was assumed that all signals on each street had identical demand, signal timing, and geometric characteristics. Different assumptions would yield different curves. Exhibit 15-12 illustrates the sensitivity of estimated speed to arrival types.

EXHIBIT 15-12. CHANGE IN MEAN SPEED FOR ARRIVAL TYPES
(SEE FOOTNOTE FOR ASSUMED VALUES)

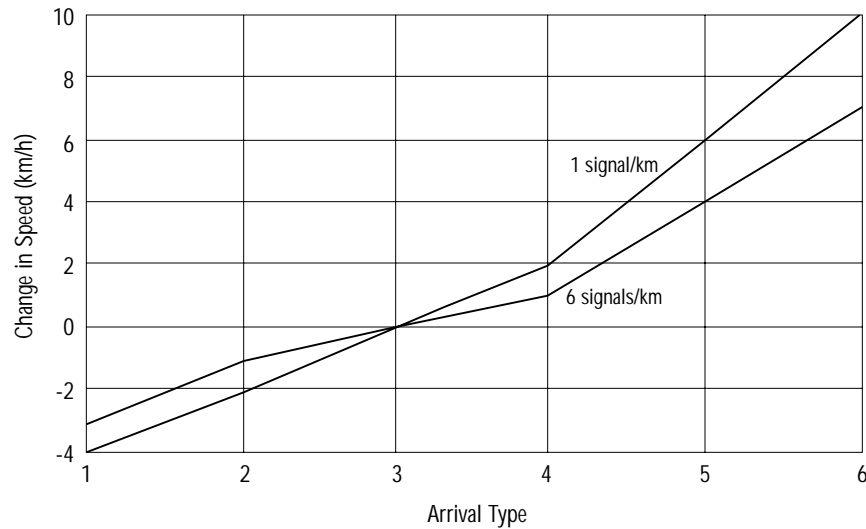

Note:
Assumptions: Urban street Class III, 56-km/h midblock FFS, 10-km length, 120-s cycle, 0.45 g/C, pretimed signals, 0.925 peak-hour factor (PHF), exclusive left-turn lanes, 12 percent left turns.

For guidelines on required inputs and estimated values, see Chapter 10

III. APPLICATIONS

To apply the methodology, two fundamental questions must be addressed.

- First, what is the primary output? Typically, it includes LOS and achievable flow rate (v_p). Performance measures related to control delay and travel speed also are achievable but are considered secondary outputs.

- Second, what are the default values or estimated values to be used in the analysis?

Basically, there are three sources of input data:

1. Default values found in this manual,
2. Estimates and locally derived default values developed by the analyst, and
3. Values derived from field measurements and observation.

For each of the input variables, a value must be supplied to calculate the outputs, both primary and secondary.

A common application of the method is to compute the LOS of a current or changed facility for the near term or distant future. This type of application is often termed operational; its primary output is LOS, with secondary outputs for delay and speed.

Another type of application solves for the service flow rate, v_p , as the primary output, to determine when improvements are required. This analysis must state as inputs a LOS goal and a number of lanes. Typically it is used to estimate the maximum flow rate that can be accommodated while still providing a given LOS.

Another type of application, planning, uses estimates, HCM default values, and local default values as inputs. As outputs, planning applications can determine LOS or flow rate along with delay and speed as secondary outputs. The difference between planning analysis and operational or design analysis is that most or all of the input values for planning come from estimates or default values, but the operational applications tend to use field-measured or known values for most or all of the inputs. For each of the analyses, FFS—either measured or estimated—is required as an input.

SEGMENTING THE URBAN STREET

At the start of the analysis, the location and length of the urban street to be considered must be defined. All relevant physical, signal, and traffic data should be identified. Consideration should be given to the extent of the urban street—generally at least 1.5 km is necessary in downtown areas and 3.0 km in other areas—and to whether additional segments should be included.

The segment is the basic unit of the analysis; it is a one-directional distance from one signalized intersection to the next. Exhibit 15-13 illustrates the segment concept on one- and two-way streets.

EXHIBIT 15-13. TYPES OF URBAN STREET SEGMENTS

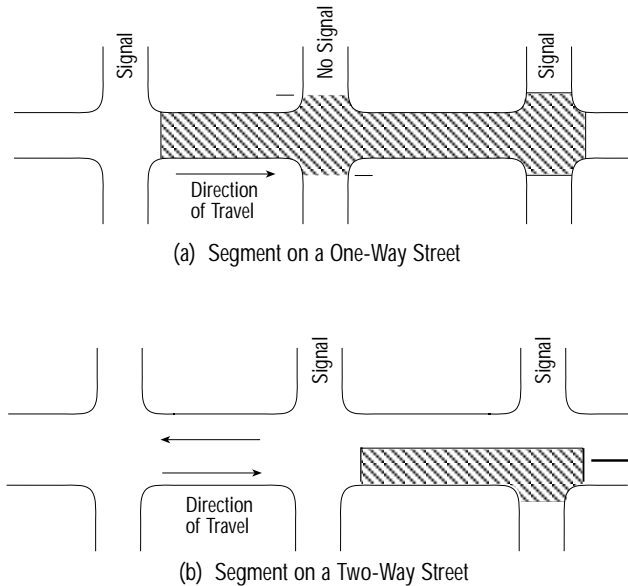

COMPUTATIONAL STEPS

The worksheet for computations is shown in Exhibit 15-14. A completed worksheet documents the analysis for one travel direction along the street. To understand the operation of the entire urban street facility, it is necessary to apply the methodology twice—once in each direction, to assess the LOS of each.

The first step for an operational (LOS) application is to establish the location and length of the urban street. Then the street class is determined, using Exhibit 10-3. FFS also is determined. The next step is to divide the street into segments. Running time is computed for each segment, along with control delay for the through movements at each intersection. Average travel speed is computed by segment and for the entire facility. Using the average travel speed, the LOS is determined by referring to Exhibit 15-2.

The objective of design analysis for flow rate, v_p , is to estimate the flow rate in vehicles per hour using an adjusted saturation flow rate, signal timing data, and geometric data for the urban street. A desired LOS is set at the start of the analysis and used to obtain the lowest acceptable average travel speed shown in Exhibit 15-2. The delay for each intersection is determined with the equation for urban street travel speed. By backsolving the delay equation, the v/c ratio, X , is computed. From X , the maximum service flow rate, v_p , is determined for the desired LOS.

Guidelines on the length of a facility for analysis

Operational (LOS) application

Design (v_p) application

EXHIBIT 15-14. URBAN STREET WORKSHEET

URBAN STREET WORKSHEET								
General Information				Site Information				
Analyst	_____	Urban Street	_____					
Agency or Company	_____	Direction of Travel	_____					
Date Performed	_____	Jurisdiction	_____					
Analysis Time Period	_____	Analysis Year	_____					
<input type="checkbox"/> Operational (LOS)		<input type="checkbox"/> Design (v_p)		<input type="checkbox"/> Planning (LOS)		<input type="checkbox"/> Planning (v_p)		Analysis Period, T = _____ h
Input Parameters								
	Segments							
	1	2	3	4	5	6	7	8
Cycle length, C (s)								
Effective green-to-cycle-length ratio, g/C								
v/c ratio for lane group, X								
Capacity of lane group, c (veh/h)								
Arrival type, AT								
Length of segment, L (km)								
Initial queue, Q_b (veh)								
Urban street class, SC (Exhibit 10-3)								
Free-flow speed, FFS (km/h) (Exhibit 15-2)								
Running time, T_R (s) (Exhibit 15-3)								
Delay Computation								
Uniform delay, d_1 (s) $d_1 = \frac{0.5C[(1 - g/C)^2]}{1 - [(g/C)\min(X, 1.0)]}$								
Signal control adjustment factor, k (Exhibit 15-6)								
Upstream filtering/metering adjustment factor, I (Exhibit 15-7)								
Incremental delay, d_2 (s) $d_2 = 900T \left[(X - 1) + \sqrt{(X - 1)^2 + \frac{8kIX}{cT}} \right]$								
Initial queue delay, d_3 (s) (Ch. 16 Appendix F)								
Progression adjustment factor, PF (Exhibit 15-5)								
Control delay, d (s) $d = (d_1 * PF) + d_2 + d_3$								
Segment LOS Determination								
Segment travel time, ST (s) $ST = T_R + d + \text{Other delay}$								
Segment travel speed, S_A (km/h) $S_A = \frac{3600(L)}{ST}$								
Segment LOS (Exhibit 15-2)								
Urban Street LOS Determination								
Total travel time = $\sum ST$	_____ s							
Total length = $\sum L$	_____ km							
Total travel speed, $S_A = \frac{3600 * \text{Total length}}{\text{Total travel time}}$	_____ km/h							
Total urban street LOS (Exhibit 15-2)	_____							

PLANNING APPLICATIONS

The objective of an urban street LOS analysis at a planning level is to estimate the operating conditions of the facility. An important use for this type of analysis is to address growth management. The accuracy of a planning LOS analysis depends on the input data. It is most appropriate when estimates of LOS are desired, field data are lacking, and planning horizons are longer.

A major difference between the planning analysis of signalized intersections and that of urban streets is the treatment of turning vehicles. Because the analysis of an urban street emphasizes through movement, the simplifying assumption is that left turns are accommodated by left-turn bays at major intersections and by controls with a properly

Simplifying assumptions about left turns for planning applications

timed separate phase. As a result, many of the inputs and complexities of intersection analyses can be simplified by using default values.

The two planning applications, planning (LOS) and planning (v_p) directly correspond to the procedures described for operational (LOS) and design (v_p), respectively, in the previous section.

The first criterion that categorizes planning applications is the use of estimates, HCM default values, or local default values on the input side of the calculation. Another factor that defines an application as planning is the use of annual average daily traffic (AADT) to estimate directional design-hour volume (DDHV). DDHV is calculated using a known or forecasted value of K (the proportion of AADT occurring during the peak hour) and D (the proportion of two-way traffic in the peak direction), as shown in Chapter 8. For further guidelines on selecting K and D values, refer to Chapter 8. The computational steps of planning applications are described in Appendix A.

To perform planning applications, typically few, if any, of the required input values must be measured. Chapter 10 contains more information on the use of default values. Planning applications based on the methodology of this chapter assume that left turns are accommodated by separate lanes and phases and therefore have minimal effect on through vehicles.

For planning purposes, FFS should be based on actual studies of the street or on studies of similar streets and should be consistent with urban street classifications. The actual or probable posted speed limit may be used as a surrogate for FFS if field data are not available.

ANALYSIS TOOLS

The worksheet shown in Exhibit 15-14 and provided in Appendix C can be used for all applications.

Planning (LOS) and planning (v_p) applications

For computational steps in planning applications, see Appendix A

IV. EXAMPLE PROBLEMS

Problem No.	Description	Application
1	Find LOS for a 3.5-km divided multilane urban street	Operational (LOS)
2	Find LOS for a 4.0-km urban street for a range of flow rates	Operational (LOS), Design (v_p)
3	Find LOS of a divided urban street with field-collected data	Operational (LOS)
4	Find LOS for a proposed divided urban street	Planning (LOS)
5	Find maximum service flow rates and AADT for a desired LOS	Planning (v_p)

EXAMPLE PROBLEM 1

The Urban Street The total length of a divided multilane urban street is 3.5 km, with seven signalized intersections at 0.5-km spacing.

The Question What is the LOS by segment and for the entire length for one direction of flow for through lane groups?

The Facts

- √ Field-measured FFS = 63 km/h,
- √ Cycle length = 70 s (all signals),
- √ Lane group capacity = 1,800 veh/h,
- √ v/c ratio as shown on the worksheet,
- √ Analysis period = 1.0 h,
- √ Urban street Class II,
- √ g/C = 0.60 (all through lane groups),
- √ Arrival Type 3 for Segment 1,
- √ Arrival Type 5 for all other segments, and
- √ Pretimed signals.

Outline of Solution All input parameters are known and no default values are required. Compute delay at signalized intersections. Then compute urban street speed and LOS for each segment and for the entire street. Since no signal progression and no traffic filtering or metering takes place upstream of the first signal, assume that its PF = 1.0 and I = 1.0. The following steps describe computations for the first segment and the entire length for one direction of flow.

Steps

1. Find factors PF, k, and I to compute control delay (use Exhibits 15-5, 15-6, and 15-7).	PF = 0.0, k = 0.50, and I as calculated in Exhibit 15-7
2. Find d_1 (use Equation 15-2).	$d_1 = \frac{0.5C \left[\left(1 - \frac{g}{C} \right)^2 \right]}{\left[1 - \left(\frac{g}{C} \right) \min(X, 1.0) \right]}$ $d_1 = \frac{0.5 * 70 [(1 - 0.60)^2]}{[1 - 0.60(0.583)]} = 8.6 \text{ s}$
3. Find d_2 (use Equation 15-3).	$d_2 = 900T \left[(X - 1) + \sqrt{(X - 1)^2 + \frac{8kIX}{cT}} \right]$ $d_2 = 900(1) \left[(0.583 - 1) + \sqrt{(0.583 - 1)^2 + \frac{8 * 0.5 * 1.0 * 0.583}{1,800(1)}} \right]$ $d_2 = 1.4 \text{ s}$
4. Find d (use Equation 15-1).	$d = (d_1 * PF) + d_2 + d_3 = (8.6 * 1.0) + 1.4 + 0.0 = 10.0 \text{ s}$
5. Find running time (use Exhibit 15-3).	For FFS = 63 km/h, running time per km = 65.8 s/km $T_R = 65.8 * 0.5 = 32.9 \text{ s}$ (for all segments)
6. Find travel time	$ST = T_R + d + \text{other } d = 32.9 + 10.0 + 0.0 = 42.9 \text{ s}$
7. Find S_A (use Equation 15-6).	$S_A = \frac{3,600(L)}{ST} = \frac{3,600(0.5)}{42.9} = 42.0 \text{ km/h}$
8. Determine LOS (use Exhibit 15-2).	LOS C
9. Find S_A for the entire urban street (use Equation 15-6).	$\Sigma ST = 42.9 + 3(34.0) + 3(34.1) = 247.2 \text{ s}$ $\Sigma L = 7(0.5) = 3.5 \text{ km}$ Urban street $S_A = \frac{3,600 * \Sigma L}{\Sigma ST} = \frac{3,600(3.5)}{247.2} = 51.0 \text{ km/h}$

10. Determine urban street LOS (use Exhibit 15-2).	LOS B
--	-------

Results Urban street LOS = B.

Example Problem 1

URBAN STREET WORKSHEET								
General Information				Site Information				
Analyst	JMYE			Urban Street	Multilane Urban			
Agency or Company	CEI			Direction of Travel	SB			
Date Performed	5/7/99			Jurisdiction				
Analysis Time Period	AM Peak			Analysis Year	1999			
<input checked="" type="checkbox"/> Operational (LOS)		<input type="checkbox"/> Design (v_p)		<input type="checkbox"/> Planning (LOS)		<input type="checkbox"/> Planning (v_p)		Analysis Period, T = 1.00 h
Input Parameters								
	Segments							
	1	2	3	4	5	6	7	8
Cycle length, C (s)	70	70	70	70	70	70	70	
Effective green-to-cycle-length ratio, g/C	0.60	0.60	0.60	0.60	0.60	0.60	0.60	
v/c ratio for lane group, X	0.583	0.611	0.611	0.611	0.597	0.593	0.593	
Capacity of lane group, c (veh/h)	1,800	1,800	1,800	1,800	1,800	1,800	1,800	
Arrival type, AT	3	5	5	5	5	5	5	
Length of segment, L (km)	0.5	0.5	0.5	0.5	0.5	0.5	0.5	
Initial queue, Q_b (veh)	-	-	-	-	-	-	-	
Urban street class, SC (Exhibit 10-3)	II	II	II	II	II	II	II	
Free-flow speed, FFS (km/h) (Exhibit 15-2)	63	63	63	63	63	63	63	
Running time, T_R (s) (Exhibit 15-3)	32.9	32.9	32.9	32.9	32.9	32.9	32.9	
Delay Computation								
Uniform delay, d_1 (s) $d_1 = \frac{0.5C[(1-g/C)^2]}{1 - [(g/C)\min(X, 1.0)]}$	8.6	8.8	8.8	8.8	8.7	8.7	8.7	
Signal control adjustment factor, k (Exhibit 15-6)	0.50	0.50	0.50	0.50	0.50	0.50	0.50	
Upstream filtering/metering adjustment factor, I (Exhibit 15-7)	1.0	0.786	0.757	0.757	0.757	0.772	0.776	
Incremental delay, d_2 (s) $d_2 = 900T \left[(X-1) + \sqrt{(X-1)^2 + \frac{8kIX}{cT}} \right]$	1.4	1.2	1.2	1.2	1.1	1.1	1.1	
Initial queue delay, d_3 (s) (Ch. 16 Appendix F)	0.0	0.0	0.0	0.0	0.0	0.0	0.0	
Progression adjustment factor, PF (Exhibit 15-5)	1.0	0.0	0.0	0.0	0.0	0.0	0.0	
Control delay, d (s) $d = (d_1 * PF) + d_2 + d_3$	10.0	1.2	1.2	1.2	1.1	1.1	1.1	
Segment LOS Determination								
Segment travel time, ST (s) $ST = T_R + d + \text{Other delay}$	42.9	34.1	34.1	34.1	34.0	34.0	34.0	
Segment travel speed, S_A (km/h) $S_A = \frac{3600(L)}{ST}$	42.0	52.8	52.8	52.8	52.9	52.9	52.9	
Segment LOS (Exhibit 15-2)	C	B	B	B	B	B	B	
Urban Street LOS Determination								
Total travel time = $\sum ST$	247.2 s							
Total length = $\sum L$	3.5 km							
Total travel speed, $S_A = \frac{3600 * \text{Total length}}{\text{Total travel time}}$	51.0 km/h							
Total urban street LOS (Exhibit 15-2)	B							

EXAMPLE PROBLEM 2

The Urban Street A two-lane urban street with five intersections at various spacings as shown in the worksheet. The street experiences high left-turn volume, served by a permitted phase and an exclusive turn lane.

The Question What is the LOS by segment and for the entire facility?

The Facts

- √ Field-measured FFS = 50 km/h,
- √ Cycle length = 90 s,
- √ Lane group capacity = 1,650 veh/h,
- √ Arrival Type 3,
- √ Analysis period = 0.25 h,
- √ Urban street Class IV,
- √ g/C ratio as shown on the worksheet,
- √ Initial queue at Intersection 4 = 22 veh,
- √ Pretimed signals, and
- √ v/c ratio as shown on the worksheet.

Outline of Solution All input parameters are known and no default values are required. The volume at Signal 5 is affected by upstream metering at oversaturated Signal 4. Since the conditions are oversaturated, no volume adjustment at Signal 5 is needed. Delay at signalized intersections is computed, including the effect of the initial queue at Signal 4 at the start of the analysis period. The urban street speed is computed and LOS is determined. The following steps describe computations for Signal 4.

Steps

1. Find PF, k, and I (use Exhibits 15-5, 15-6, and 15-7).	PF = 1.0, k = 0.50, I = 0.145
2. Find d_1 (use Equation 15-2).	$d_1 = \frac{0.5C \left[\left(1 - \frac{g}{C} \right)^2 \right]}{\left[1 - \left(\frac{g}{C} \right) \min(X, 1.0) \right]}$ $d_1 = \frac{0.5 * 90 \left[(1 - 0.566)^2 \right]}{\left[1 - 0.566(1.0) \right]} = 19.5 \text{ s}$
3. Find d_2 (use Equation 15-3).	$d_2 = 900T \left[(X - 1) + \sqrt{(X - 1)^2 + \frac{8kIX}{cT}} \right]$ $d_2 = 900(0.25) \left[(1.105 - 1) + \sqrt{(1.105 - 1)^2 + \frac{8 * 0.5 * 0.145 * 1.105}{1,650(0.25)}} \right]$ $d_2 = 48.9 \text{ s}$
4. Find d_3 (refer to Ch. 16 Appendix F, Case V).	$d_3 = \frac{1,800Q_b(1+u)t}{cT}$ $d_3 = \frac{1,800 * 22 * (1+1) * 0.25}{1,650 * 0.25} = 48.0 \text{ s}$
5. Find d (use Equation 15-1).	$d = (d_1 * PF) + d_2 + d_3$ $d = (19.5 * 1.0) + 48.9 + 48.0 = 116.4 \text{ s}$
6. Find running time for Segment 4 length of 500 m (use Exhibit 15-3).	For FFS = 50 km/h, running time per km = 81.0 s/km $T_R = 81.0 * 0.5 = 40.5 \text{ s}$
7. Find S_A for Segment 4 (use Equation 15-6).	$S_A = \frac{3,600(L)}{T_R + d} = \frac{3,600(0.5)}{40.5 + 116.4} = 11.4 \text{ km/h}$
8. Determine LOS for the segment (use Exhibit 15-2).	LOS F (Segment 4)

9. Determine entire urban street LOS (use Exhibit 15-2).	LOS D
--	-------

- Results**
- For fourth section, LOS F; and
 - For urban street, LOS D.

Example Problem 2

URBAN STREET WORKSHEET								
General Information				Site Information				
Analyst	JMYE			Urban Street	Park Ave.			
Agency or Company	CEI			Direction of Travel	WB			
Date Performed	5/7/99			Jurisdiction				
Analysis Time Period	PM Peak			Analysis Year	1999			
<input checked="" type="checkbox"/> Operational (LOS)	<input type="checkbox"/> Design (v_p)	<input type="checkbox"/> Planning (LOS)	<input type="checkbox"/> Planning (v_p)	Analysis Period, T = <u>0.25</u> h				
Input Parameters								
	Segments							
	1	2	3	4	5	6	7	8
Cycle length, C (s)	90	90	90	90	90			
Effective green-to-cycle-length ratio, g/C	0.289	0.566	0.467	0.566	0.600			
v/c ratio for lane group, X	0.822	0.951	0.977	1.105	0.456			
Capacity of lane group, c (veh/h)	1,650	1,650	1,650	1,650	1,650			
Arrival type, AT	3	3	3	3	3			
Length of segment, L (km)	0.4	0.4	0.4	0.5	0.3			
Initial queue, Q_b (veh)	-	-	-	22	-			
Urban street class, SC (Exhibit 10-3)	IV	IV	IV	IV	IV			
Free-flow speed, FFS (km/h) (Exhibit 15-2)	50	50	50	50	50			
Running time, T_R (s) (Exhibit 15-3)	32.4	32.4	32.4	40.5	27.0			
Delay Computation								
Uniform delay, d_1 (s) $d_1 = \frac{0.5C[(1-g/C)^2]}{1 - [(g/C)\min(X, 1.0)]}$	29.8	18.4	23.5	19.5	9.9			
Signal control adjustment factor, k (Exhibit 15-6)	0.5	0.5	0.5	0.5	0.5			
Upstream filtering/metering adjustment factor, I (Exhibit 15-7)	1.0	0.462	0.205	0.145	0.090			
Incremental delay, d_2 (s) $d_2 = 900T \left[(X-1) + \sqrt{(X-1)^2 + \frac{8kIX}{CT}} \right]$	4.8	7.3	6.0	48.9	0.1			
Initial queue delay, d_3 (s) (Ch. 16 Appendix F)	0.0	0.0	0.0	48.0	0.0			
Progression adjustment factor, PF (Exhibit 15-5)	1.0	1.0	1.0	1.0	1.0			
Control delay, d (s) $d = (d_1 * PF) + d_2 + d_3$	34.6	25.7	29.5	116.4	10.0			
Segment LOS Determination								
Segment travel time, ST (s) $ST = T_R + d + \text{Other delay}$	67.0	58.1	61.9	157.3	37.0			
Segment travel speed, S_A (km/h) $S_A = \frac{3600(L)}{ST}$	21.5	24.8	23.3	11.4	29.2			
Segment LOS (Exhibit 15-2)	D	C	C	F	C			
Urban Street LOS Determination								
Total travel time = $\sum ST$	381.8 s							
Total length = $\sum L$	2.0 km							
Total travel speed, $S_A = \frac{3600 * \text{Total length}}{\text{Total travel time}}$	18.9 km/h							
Total urban street LOS (Exhibit 15-2)	D							

EXAMPLE PROBLEM 3

The Urban Street A multilane two-way divided suburban street with left-turn bays and eight signalized intersections.

The Question What is the LOS by segment and for the entire facility?

The Facts

- √ Field-measured FFS = 70 km/h,
- √ Access control is good,
- √ Analysis period = 1.00 h,
- √ Segment lengths and travel times are collected according to the method described in Appendix A,
- √ Multilane divided facility, and
- √ About 3 signals per kilometer.

Outline of Solution Since segment lengths and travel times are collected in the field, urban street speeds and LOS can be determined directly. The following describes the steps in the computations.

Steps

1. Find urban street class (use Exhibits 10-3 and 10-4, and field-measured FFS).	Suburban street—Urban street Class II
2. Find S_A (use Equation 15-6). ST and L are given on the worksheet.	$S_A = \frac{3,600(L)}{ST}$ <p>Segment 1 $S_A = S_A = \frac{3,600(0.30)}{28.3} = 38.2$ km/h Segment 2 $S_A = 46.9$ km/h Segment 3 $S_A = 41.3$ km/h Segment 4 $S_A = 36.7$ km/h Segment 5 $S_A = 29.0$ km/h Segment 6 $S_A = 35.5$ km/h Segment 7 $S_A = 40.9$ km/h Segment 8 $S_A = 38.4$ km/h</p>
3. Find S_A for the entire urban street (use Equation 15-6).	$\sum ST = 252.3$ s $\sum L = 2.6$ km $S_A = \frac{3,600 \sum L}{\sum ST} = \frac{3,600(2.6)}{252.3} = 37.1$ km/h
4. Determine urban street LOS and segment LOS (use Exhibit 15-2).	

Results

- Segment 1, LOS C;
- Segment 2, LOS B;
- Segment 3, LOS C;
- Segment 4, LOS C;
- Segment 5, LOS D;
- Segment 6, LOS C;
- Segment 7, LOS C;
- Segment 8, LOS C; and
- Urban street, LOS C.

Example Problem 3

URBAN STREET WORKSHEET								
General Information				Site Information				
Analyst	JMYE			Urban Street				
Agency or Company	CEI			Direction of Travel	EB			
Date Performed	5/11/99			Jurisdiction				
Analysis Time Period	PM Peak			Analysis Year	1999			
<input checked="" type="checkbox"/> Operational (LOS)		<input type="checkbox"/> Design (v _p)		<input type="checkbox"/> Planning (LOS)		<input type="checkbox"/> Planning (v _p)		Analysis Period, T = 1.00 h
Input Parameters								
	Segments							
	1	2	3	4	5	6	7	8
Cycle length, C (s)								
Effective green-to-cycle-length ratio, g/C								
v/c ratio for lane group, X								
Capacity of lane group, c (veh/h)								
Arrival type, AT								
Length of segment, L (km)	0.30	0.25	0.25	0.30	0.40	0.40	0.40	0.30
Initial queue, Q _b (veh)	-	-	-	-	-	-	-	-
Urban street class, SC (Exhibit 10-3)	II	II	II	II	II	II	II	II
Free-flow speed, FFS (km/h) (Exhibit 15-2)	70	70	70	70	70	70	70	70
Running time, T _R (s) (Exhibit 15-3)								
Delay Computation								
Uniform delay, d ₁ (s) $d_1 = \frac{0.5C[(1-g/C)^2]}{1 - [(g/C)\min(X, 1.0)]}$								
Signal control adjustment factor, k (Exhibit 15-6)								
Upstream filtering/metering adjustment factor, I (Exhibit 15-7)								
Incremental delay, d ₂ (s) $d_2 = 900T \left[(X-1) + \sqrt{(X-1)^2 + \frac{8kIX}{CT}} \right]$								
Initial queue delay, d ₃ (s) (Ch. 16 Appendix F)								
Progression adjustment factor, PF (Exhibit 15-5)								
Control delay, d (s) d = (d ₁ * PF) + d ₂ + d ₃								
Segment LOS Determination								
Segment travel time, ST (s) ST = T _R + d + Other delay	28.3	19.2	21.8	29.4	49.7	40.6	35.2	28.1
Segment travel speed, S _A (km/h) $S_A = \frac{3600(L)}{ST}$	38.2	46.9	41.3	36.7	29.0	35.5	40.9	38.4
Segment LOS (Exhibit 15-2)	C	B	C	C	D	C	C	C
Urban Street LOS Determination								
Total travel time = ΣST	252.3 s							
Total length = ΣL	2.6 km							
Total travel speed, S _A = $\frac{3600 * \text{Total length}}{\text{Total travel time}}$	37.1 km/h							
Total urban street LOS (Exhibit 15-2)	C							

EXAMPLE PROBLEM 4

The Urban Street A 3.2-km divided four-lane urban street with four signalized intersections at 0.8-km spacing. All intersections have left-turn bays.

The Question What are the LOS, control delay, and peak 15-min flow rate for through volume?

The Facts

- √ FFS = 70 km/h,
- √ AADT = 30,000,
- √ K = 0.091, D = 0.568,
- √ PHF = 0.925,
- √ s = 1,850 pc/h/ln,
- √ P_{LT} = 0.12,
- √ Urban street Class II,
- √ Arrival Type 3,
- √ Actuated signal,
- √ Cycle length = 120 s,
- √ Average g/C = 0.42, and
- √ Analysis period = 0.25 h.

Outline of Solution All input parameters are known for a planning application. The through-volume peak 15-min flow rate, urban street speed, and LOS are computed.

Steps

1. Find V.	$V = \text{AADT} * K * D$ $V = 30,000 * 0.091 * 0.568 = 1,551 \text{ veh/h}$
2. Find 15-min through flow rate.	$v_p = \frac{V(1 - P_{LT})}{\text{PHF}}$ $v_p = \frac{1551(1 - 0.12)}{0.925} = 1,476 \text{ veh/h}$
3. Find c and X.	$c = s * N * (g/C)$ $c = 1850 * 2 * 0.42 = 1,554 \text{ pc/h}$ $X = \frac{v}{c} = \frac{1476}{1554} = 0.950$
4. Find PF, k, and I (use Exhibits 15-5, 15-6, and 15-7).	PF = 1.0, k = 0.5. Assume I = 1.0 (for Intersection 1) and I = 0.207 is calculated for others
5. Find d ₁ (use Equation 15-2).	$d_1 = \frac{0.5(120)(1 - 0.42)^2}{1 - (0.42)(0.950)} = 33.6 \text{ s}$
6. Find d ₂ (use Equation 15-3).	$d_2 = 900(0.25) \left[(0.950 - 1) + \sqrt{(0.950 - 1)^2 + \frac{8 * 0.5 * 1.0 * 0.950}{1554(0.25)}} \right]$ $d_2 = 13.7 \text{ s}$
7. Find d (use Equation 15-1).	$d = (33.6 * 1.0) + 13.7 = 47.3 \text{ s}$
8. Find running time for a segment length of 800 m (use Exhibit 15-3).	Running time per km = 56 s/km $T_R = 56 * 0.8 = 44.8 \text{ s}$
9. Find S _A for a segment (use Equation 15-6).	$S_A = \frac{3,600(0.8)}{(44.8 + 47.3)} = 31.3 \text{ km/h, LOS D}$
10. Find S _A for the entire urban street (use Equation 15-6).	S _A = 34.0 km/h
11. Determine LOS (use Exhibit 15-2).	LOS C

- Results**
- Peak 15-min flow rate = 1,476 veh/h,
 - Intersection control delay = 47.3 + 37.5 * 3 = 159.8 s, and
 - LOS C.

Example Problem 4

URBAN STREET WORKSHEET								
General Information				Site Information				
Analyst	JMYE			Urban Street				
Agency or Company	CEI			Direction of Travel	Peak direction			
Date Performed	5/20/99			Jurisdiction				
Analysis Time Period	Peak			Analysis Year	1999			
<input type="checkbox"/> Operational (LOS)		<input type="checkbox"/> Design (v_p)		<input checked="" type="checkbox"/> Planning (LOS)		<input type="checkbox"/> Planning (v_p)		Analysis Period, T = <u>0.25</u> h
Input Parameters								
	Segments							
	1	2	3	4	5	6	7	8
Cycle length, C (s)	120	120	120	120				
Effective green-to-cycle-length ratio, g/C	0.42	0.42	0.42	0.42				
v/c ratio for lane group, X	0.950	0.950	0.950	0.950				
Capacity of lane group, c (veh/h)	1,554	1,554	1,554	1,554				
Arrival type, AT	3	3	3	3				
Length of segment, L (km)	0.8	0.8	0.8	0.8				
Initial queue, Q_b (veh)	-	-	-	-				
Urban street class, SC (Exhibit 10-3)	II	II	II	II				
Free-flow speed, FFS (km/h) (Exhibit 15-2)	70	70	70	70				
Running time, T_R (s) (Exhibit 15-3)	44.8	44.8	44.8	44.8				
Delay Computation								
Uniform delay, d_1 (s) $d_1 = \frac{0.5C[(1-g/C)^2]}{1 - [(g/C)\min(X, 1.0)]}$	33.6	33.6	33.6	33.6				
Signal control adjustment factor, k (Exhibit 15-6)	0.5	0.5	0.5	0.5				
Upstream filtering/metering adjustment factor, I (Exhibit 15-7)	1.0	0.207	0.207	0.207				
Incremental delay, d_2 (s) $d_2 = 900T \left[(X-1) + \sqrt{(X-1)^2 + \frac{8kIX}{cT}} \right]$	13.7	3.9	3.9	3.9				
Initial queue delay, d_3 (s) (Ch. 16 Appendix F)	0.0	0.0	0.0	0.0				
Progression adjustment factor, PF (Exhibit 15-5)	1.0	1.0	1.0	1.0				
Control delay, d (s) $d = (d_1 * PF) + d_2 + d_3$	47.3	37.5	37.5	37.5				
Segment LOS Determination								
Segment travel time, ST (s) $ST = T_R + d + \text{Other delay}$	92.1	82.3	82.3	82.3				
Segment travel speed, S_A (km/h) $S_A = \frac{3600(L)}{ST}$	31.3	35.0	35.0	35.0				
Segment LOS (Exhibit 15-2)	D	C	C	C				
Urban Street LOS Determination								
Total travel time = $\sum ST$	339.0 s							
Total length = $\sum L$	3.2 km							
Total travel speed, $S_A = \frac{3600 * \text{Total length}}{\text{Total travel time}}$	34.0 km/h							
Total urban street LOS (Exhibit 15-2)	C							

EXAMPLE PROBLEM 5

The Urban Street A new 3.6-km six-lane facility with six signalized intersections at 0.6-km spacing.

The Question What is the lowest acceptable travel speed, hourly directional volume, and annual average daily traffic to achieve LOS D?

The Facts

- √ FFS = 65 km/h,
- √ K = 0.095, D = 0.55,
- √ PHF = 0.95,
- √ s = 1,750 pc/h/ln,
- √ P_{LT} = 0.12,
- √ Analysis period = 0.25 h,
- √ Urban street Class II,
- √ Arrival Type 5,
- √ Semiactuated signals,
- √ Cycle length = 120 s, and
- √ g/C = 0.42.

Outline of Solution All input parameters are known. Find the lowest acceptable travel speed to achieve LOS D, and backsolve for flow rate, volume, and AADT.

Steps

1. Find the lowest acceptable travel speed for urban street Class II and LOS D (use Exhibit 15-2).	$S_A = 26.1$ km/h
2. Find travel time for segment length of 600 m (use Exhibit 15-3).	Running time per km = 61 s/km $T_R = 61 * 0.6 = 36.6$ s Urban street travel time = $6 * 36.6 = 219.6$ s
3. Find d for the total urban street (use Equation 15-6).	$d = \frac{3,600}{S_A} - T_R$ $d = \frac{3,600(3.6)}{26.1} - 219.6 = 277.0$ s/veh
4. Find PF, k, and I (use Exhibits 15-5, 15-6, and 15-7).	PF = 0.511, k = 0.5 Assume I = 1.0 (Intersection 1) I = 0.090 is calculated for Intersections 2 through 6
5. Find c (use Equation 15-7).	$c = N * s * (g/C)$ $c = 3 * 1,750 * 0.42 = 2,205$ veh/h
6. Find X (use Equations 15-1, 15-2, and 15-3).	$d = \sum_1^6 d_i = 277$ s/veh $d = 6d_1 * PF + d_2$ (Int. 1) + $5d_2$ (Int. 2–6) $d = 6 * 0.511 * d_1 + d_2$ (Int. 1) + $5d_2$ (Int. 2–6) $d = 3.066d_1 + d_2$ (Int. 1) + $5d_2$ (Int. 2–6) $d_1 = \frac{0.5(120)(1 - 0.42)^2}{1 - 0.42X}$ $d_1 = \frac{20.184}{1 - 0.42X}$

6. (continued)	$d_2 \text{ for Intersection 1}$ $d_2 = 900(0.25) \left[(X - 1) + \sqrt{(X - 1)^2 + \frac{8 * 0.5 * 1.0 * X}{2,205(0.25)}} \right]$ $d_2 = 225 \left[(X - 1) + \sqrt{(X - 1)^2 + \frac{4X}{551.25}} \right]$ $d_2 \text{ for Intersections 2-6}$ $d_2 = 225 \left[(X - 1) + \sqrt{(X - 1)^2 + \frac{0.36X}{551.25}} \right]$ <p>by trial and error, $X = 1.05$</p>
7. Find V_h and AADT	$V_h = \frac{X * c * PHF}{(1 - P_{LT})} = \frac{1.05 * 2205 * 0.95}{1 - 0.12} = 2,499 \text{ veh/h}$ $AADT = \frac{V_h}{D * K} = \frac{2499}{0.55 * 0.095} = 47,828 \text{ veh/day}$

- Results**
- $V_h = 2,499$ veh/h,
 - AADT = 47,828 veh/day, and
 - $S_A = 26.1$ km/h.

APPENDIX A. PLANNING APPLICATION COMPUTATIONS

The calculation process for determining urban street LOS is shown in Exhibit A15-1 and consists of the following steps.

1. Convert daily volumes to the planning analysis hour by using an appropriate K-factor.
2. Multiply K by the directional distribution factor D to obtain hourly directional volumes.
3. Adjust the hourly directional volumes based on PHF and turns from exclusive lanes to yield estimated through volumes for 15-min service flow rates.
4. Calculate the running time on the basis of urban street classification, intersection spacing, and FFS.
5. Using Equation 15-1, calculate the intersection control delay on the basis of adjusted saturation flow rates, number of lanes N, arrival type, signal type, cycle length C, and g/C for each intersection.
6. Using running time and intersection control delay, calculate the average travel speed.
7. Obtain urban street LOS on the basis of the average travel speed.

Example Problem 4 in this chapter illustrates the computational steps for a planning analysis.

Frequently in a planning analysis, however, the LOS may be given and the desired outcome is a volume—hourly directional, hourly nondirectional, or daily. For these applications, the calculation is reversed, as follows.

1. Select the LOS and the corresponding average travel speed (range or minimum) based on urban street type and FFS, selected from Exhibit 15-2.
2. Compute the total section running time for the urban street type, number of intersections, FFS, and section length.
3. Using Equation 15-6 and steps 1 and 2, calculate the control delay d at all intersections.

EXHIBIT A15-1. URBAN STREET LOS CALCULATIONS

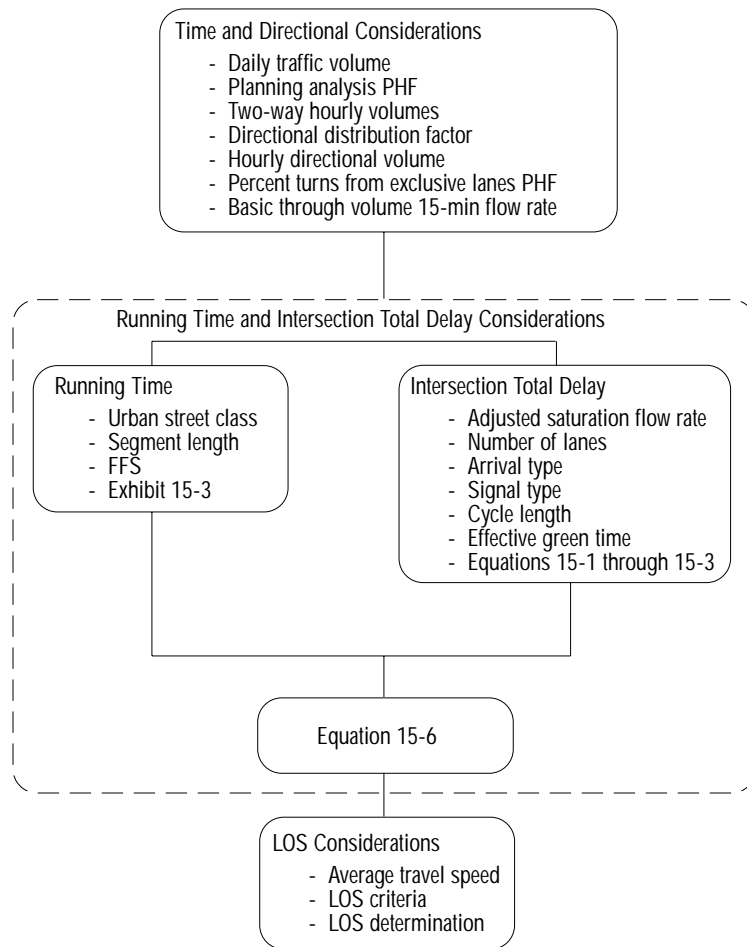

4. Compute v by inserting the values for average control delay, the adjusted saturated flow rate for the number of lanes, the arrival type, C , and weighted g/C into Equations 15-1 through 15-3.

5. Use the percentage of turns from exclusive lanes, basic through 15-min volumes, and the PHF to determine the hourly directional volume for the design hour.

6. Use the hourly directional volume and the directional distribution factor to calculate the two-way hourly directional volume for the design hour.

7. Use the two-way hourly directional volume and the applicable K -factor to determine AADT.

The results of a planning analysis can range from a rough estimate of LOS to a precise operational analysis, depending primarily on the extent to which default values are used as input. For example, using statewide defaults for appropriate traffic, roadway, and signal characteristics will produce rough LOS estimates. Using area- or roadway-specific data but treating all signal characteristics the same (e.g., using a weighted g/C approach) should provide more accurate LOS estimates. However, using specific traffic, roadway, and signal data for each road segment and traffic signal would provide an even more accurate estimate. The next level of precision is a detailed treatment of turning movements and signal timing, which approaches an operational analysis but uses projected instead of actual traffic volumes.

APPENDIX B. TRAVEL TIME STUDIES FOR DETERMINING LOS

The following steps apply the test-car method for determining travel time and LOS for urban streets.

1. Identify and inventory the geometrics and the access control of each street segment, the segment lengths, the signal timing, and the 15-min flow rates for selected times of the day—such as the peak a.m. period, the peak p.m. period, and a representative off-peak period—by direction of flow.
2. Determine the appropriate FFS for the street section. This can be determined by making runs with a test car equipped with a calibrated speedometer during periods of low volume. An observer should read the speedometer at midblock locations when the vehicle is not impeded by other vehicles and record speed readings for each segment. These observations can be supplemented by spot speed studies at typical midblock locations during low-volume conditions. Other data, such as design type, access points, roadside development, and speed limit, also may be considered.
3. Use Exhibits 10-3 and 10-4 along with the physical information and FFS to determine the urban street class.
4. Make test-car travel time runs over the street section during the selected times.
 - a. Use the appropriate equipment to obtain the information identified in Exhibit B15-1. The equipment may be computerized or simply a pair of stopwatches.
 - b. Travel times between the centers of signalized intersections should be recorded, along with the location, cause, and duration of each stop.
 - c. Test-car runs should begin at different time points in the signal cycle to avoid all trips starting first in the platoon.
 - d. Some midblock speedometer readings also should be recorded to check on unimpeded travel speeds and how they relate to FFS.
 - e. Data should be summarized for each segment and each time period, the average travel time, the average stopped time for the signal, and other stops and events (four-way stops, parking disruptions, etc.).
 - f. The number of test-car runs will depend on the variance in the data. Six to 12 runs may be adequate for each traffic-volume condition.
 - g. If available, an instrumented test car should be used to reduce labor requirements and to facilitate recording and analysis. Summaries of test-car runs with all data recorded and analyzed by the computer are now common.
5. The average travel speed, based on travel times and segment lengths, should be determined for each segment for each time period. Average travel speed for the entire urban street section should also be determined.
6. From Exhibit 15-2, obtain a LOS value for each urban street segment and for the overall urban street for each time period and direction of flow. This is done by comparing the average travel speed from step 5 with the speed values for the appropriate street class in Exhibit 15-2.
7. The test-car data can be modified to evaluate different signal timing plans. As shown in Exhibit 15-5, adjustment factors can be applied to delays to evaluate how the changes would affect average travel speeds and LOS.

URBAN STREET WORKSHEET								
General Information				Site Information				
Analyst _____				Urban Street _____				
Agency or Company _____				Direction of Travel _____				
Date Performed _____				Jurisdiction _____				
Analysis Time Period _____				Analysis Year _____				
<input type="checkbox"/> Operational (LOS) <input type="checkbox"/> Design (v _p) <input type="checkbox"/> Planning (LOS) <input type="checkbox"/> Planning (v _p) Analysis Period, T = _____ h								
Input Parameters								
	Segments							
	1	2	3	4	5	6	7	8
Cycle length, C (s)								
Effective green-to-cycle-length ratio, g/C								
v/c ratio for lane group, X								
Capacity of lane group, c (veh/h)								
Arrival type, AT								
Length of segment, L (km)								
Initial queue, Q _b (veh)								
Urban street class, SC (Exhibit 10-3)								
Free-flow speed, FFS (km/h) (Exhibit 15-2)								
Running time, T _R (s) (Exhibit 15-3)								
Delay Computation								
Uniform delay, d ₁ (s) $d_1 = \frac{0.5C[(1 - g/C)^2]}{1 - [(g/C)\min(X, 1.0)]}$								
Signal control adjustment factor, k (Exhibit 15-6)								
Upstream filtering/metering adjustment factor, I (Exhibit 15-7)								
Incremental delay, d ₂ (s) $d_2 = 900T \left[(X - 1) + \sqrt{[(X - 1)^2 + \frac{8kIX}{cT}} \right]$								
Initial queue delay, d ₃ (s) (Ch. 16 Appendix F)								
Progression adjustment factor, PF (Exhibit 15-5)								
Control delay, d (s) d = (d ₁ * PF) + d ₂ + d ₃								
Segment LOS Determination								
Segment travel time, ST (s) ST = T _R + d + Other delay								
Segment travel speed, S _A (km/h) $S_A = \frac{3600(L)}{ST}$								
Segment LOS (Exhibit 15-2)								
Urban Street LOS Determination								
Total travel time = ΣST				_____ s				
Total length = ΣL				_____ km				
Total travel speed, S _A = $\frac{3600 * \text{Total length}}{\text{Total travel time}}$				_____ km/h				
Total urban street LOS (Exhibit 15-2)				_____				

CHAPTER 16

SIGNALIZED INTERSECTIONS

CONTENTS

I.	INTRODUCTION	16-1
	Scope of the Methodology	16-1
	Limitations to the Methodology	16-1
II.	METHODOLOGY	16-1
	LOS	16-2
	Input Parameters	16-3
	Geometric Conditions	16-3
	Traffic Conditions	16-3
	Signalization Conditions	16-5
	Lane Grouping	16-6
	Determining Flow Rate	16-7
	Alternative Study Approaches	16-7
	Adjustment for Right Turn on Red	16-9
	Determining Saturation Flow Rate	16-9
	Base Saturation Flow Rate	16-10
	Adjustment for Lane Width	16-10
	Adjustment for Heavy Vehicles and Grade	16-10
	Adjustment for Parking	16-10
	Adjustment for Bus Blockage	16-10
	Adjustment for Area Type	16-12
	Adjustment for Lane Utilization	16-12
	Adjustment for Right Turns	16-12
	Adjustment for Left Turns	16-13
	Adjustment for Pedestrians and Bicyclists	16-13
	Determining Capacity and v/c Ratio	16-13
	Capacity	16-13
	v/c Ratio	16-14
	Critical Lane Groups	16-14
	Determining Delay	16-19
	Progression Adjustment Factor	16-19
	Uniform Delay	16-20
	Incremental Delay	16-21
	Incremental Delay Calibration Factor	16-21
	Upstream Filtering or Metering Adjustment Factor	16-22
	Initial Queue Delay	16-22
	Aggregated Delay Estimates	16-22
	Special Procedure for Uniform Delay with Protected-Plus-Permitted Left-Turn Operation from Exclusive Lanes	16-23
	Determining Level of Service	16-23
	Determining Back of Queue	16-24
	Sensitivity of Results to Input Variables	16-24
III.	APPLICATIONS	16-26
	Computational Steps	16-27
	Input Parameters	16-27
	Volume Adjustment and Saturation Flow Rate	16-30
	Capacity Analysis	16-30
	Delay and Level of Service	16-33

Interpretation of Results	16-35
Analysis Tools	16-36
IV. EXAMPLE PROBLEMS	16-37
Example Problem 1	16-38
Example Problem 2	16-48
Example Problem 3	16-64
Example Problem 4	16-74
Example Problem 5	16-79
Example Problem 6	16-85
V. REFERENCES	16-86
APPENDIX A. FIELD MEASUREMENT OF INTERSECTION CONTROL DELAY	16-88
General Notes	16-88
Measurement Technique	16-89
APPENDIX B. SIGNAL TIMING DESIGN	16-93
Type of Signal Controller	16-94
Phase Plans	16-95
Two-Phase Control	16-96
Multiphase Control	16-96
Allocation of Green Time	16-98
Timing Plan Design for Pretimed Control	16-98
Design Strategies	16-98
Procedure for Equalizing Degree of Saturation	16-99
Timing Plan Estimation For Traffic-Actuated Control	16-101
Functional Requirements of Model	16-101
Data Requirements	16-101
Approach-Specific Data	16-102
Position Codes	16-102
Sneakers	16-102
Free Queue	16-102
Approach Speed, SA	16-102
Terminating of Rings 1 and 2	16-103
Phasing and Detector Design Parameters	16-104
Phase Type	16-104
Phase Reversal	16-104
Detector Length, DL	16-104
Detector Setback, DS	16-105
Controller Settings	16-105
Maximum Initial Interval, MxI	16-105
Added Initial per Actuation, AI	16-105
Minimum Allowable Gap, MnA	16-105
Gap Reduction Rate, GR	16-105
Pedestrian Walk + Don't Walk, WDW	16-105
Maximum Green, MxG	16-106
Intergreen Time, Y	16-106
Recall Mode	16-106
Minimum Vehicle Phase Time, MnV	16-106
Green-Time Estimation Model	16-106
Queue Service Time	16-107
Green Extension Time	16-108
Computational Structure for Green-Time Estimation	16-108
Simple Two-Phase Example	16-109
Minimum Phase Times	16-111
Multiphase Operation	16-112
Coordinated Semiactuated Operation	16-115

Multiphase Example	16-116
Limitations of Traffic-Actuated Timing Estimation Procedure	16-120
APPENDIX C. LEFT-TURN ADJUSTMENT FACTORS FOR PERMITTED PHASING	16-122
Multilane Approach with Opposing Multilane Approaches	16-124
Single-Lane Approach Opposed by Single-Lane Approach	16-126
Special Cases	16-127
More Complex Phasing with Permitted Left Turns	16-128
Procedures for Application	16-132
APPENDIX D. PEDESTRIAN AND BICYCLE ADJUSTMENT FACTORS	16-135
APPENDIX E. ESTIMATING UNIFORM CONTROL DELAY (d_1) FOR PROTECTED-PLUS-PERMITTED OPERATION.....	16-140
Supplemental Uniform Delay Worksheet	16-141
APPENDIX F. EXTENSION OF SIGNAL DELAY MODELS TO INCORPORATE EFFECT OF AN INITIAL QUEUE.....	16-142
Introduction.....	16-142
Estimation of d_3	16-144
Numerical Example of Delays with Initial Queue	16-145
Extension to Multiple Time Periods	16-146
Numerical Example for Multiple-Period Analysis.....	16-146
Period 1	16-147
Period 2	16-147
Period 3	16-147
Period 4	16-148
Procedures for Making Calculations.....	16-149
APPENDIX G. DETERMINATION OF BACK OF QUEUE	16-151
Average Back of Queue	16-152
Percentile Back of Queue.....	16-155
Queue Storage Ratio	16-156
Application.....	16-156
APPENDIX H. DIRECT MEASUREMENT OF PREVAILING SATURATION FLOW RATES	16-158
General Notes	16-158
Measurement Technique	16-159
APPENDIX I. WORKSHEETS	16-161
Input Worksheet	
Volume Adjustment and Saturation Flow Rate Worksheet	
Capacity and LOS Worksheet	
Supplemental Uniform Delay Worksheet for Left Turns from Exclusive Lanes with Protected and Permitted Phases	
Traffic-Actuated Control Input Data Worksheet	
Supplemental Worksheet for Permitted Left Turns Opposed by Multilane Approach	
Supplemental Worksheet for Permitted Left Turns Opposed by Single-Lane Approach	
Supplemental Worksheet for Pedestrian-Bicycle Effects on Permitted Left Turns and Right Turns	
Initial Queue Delay Worksheet	
Back-of-Queue Worksheet	
Intersection Control Delay Worksheet	
Field Saturation Flow Rate Study Worksheet	

EXHIBITS

Exhibit 16-1.	Signalized Intersection Methodology	16-2
Exhibit 16-2.	LOS Criteria for Signalized Intersections	16-2
Exhibit 16-3.	Input Data Needs for Each Analysis Lane Group	16-3
Exhibit 16-4.	Arrival Types	16-4
Exhibit 16-5.	Typical Lane Groups for Analysis	16-7
Exhibit 16-6.	Three Alternative Study Approaches	16-8
Exhibit 16-7.	Adjustment Factors for Saturation Flow Rate	16-11
Exhibit 16-8.	Critical Lane Group Determination with Protected Left Turns	16-16
Exhibit 16-9.	Critical Lane Group Determination with Protected and Permitted Left Turns	16-17
Exhibit 16-10.	Critical Lane Group Determination for Multiphase Signal	16-18
Exhibit 16-11.	Relationship Between Arrival Type and Platoon Ratio (R_p)	16-20
Exhibit 16-12.	Progression Adjustment Factor for Uniform Delay Calculation	16-20
Exhibit 16-13.	k-Values to Account for Controller Type	16-22
Exhibit 16-14.	Sensitivity of Delay to Demand to Capacity Ratio	16-24
Exhibit 16-15.	Sensitivity of Delay to g/C	16-25
Exhibit 16-16.	Sensitivity of Delay to Cycle Length	16-25
Exhibit 16-17.	Sensitivity of Delay to Analysis Period (T) (for $v/c \approx 1.0$)	16-26
Exhibit 16-18.	Types of Analysis Commonly Performed	16-27
Exhibit 16-19.	Flow of Worksheets and Appendices to Perform Operational Analysis	16-28
Exhibit 16-20.	Input Worksheet	16-29
Exhibit 16-21.	Volume Adjustment and Saturation Flow Rate Worksheet	16-31
Exhibit 16-22.	Capacity and LOS Worksheet	16-32
Exhibit 16-23.	Supplemental Uniform Delay Worksheet for Left Turns from Exclusive Lanes with Protected and Permitted Phases	16-34
Exhibit A16-1.	Intersection Control Delay Worksheet	16-89
Exhibit A16-2.	Acceleration-Deceleration Delay Correction Factor, CF (s).....	16-91
Exhibit A16-3.	Example Application	16-92
Exhibit A16-4.	Example Application with Residual Queue at End	16-93
Exhibit B16-1.	Phase Plans for Pretimed and Traffic-Actuated Control	16-95
Exhibit B16-2.	Dual-Ring Concurrent Phasing Scheme with Assigned Movements	16-96
Exhibit B16-3.	Sample Two-Phase Signal	16-100
Exhibit B16-4.	Traffic-Actuated Control Input Data Worksheet	16-103
Exhibit B16-5.	Queue Accumulation Polygon Illustrating Two Methods of Green-Time Computation	16-107
Exhibit B16-6.	Recommended Parameter Values	16-109
Exhibit B16-7.	Convergence of Green-Time Computation by Elimination of Green-Time Deficiency	16-111
Exhibit B16-8.	Queue Accumulation Polygon for Permitted Left Turns from Exclusive Lane	16-113
Exhibit B16-9.	Queue Accumulation Polygon for Permitted Left Turns from Shared Lane	16-113
Exhibit B16-10.	Queue Accumulation Polygon for Protected-Plus-Permitted Left- Turn Phasing with Exclusive Left-Turn Lane	16-114
Exhibit B16-11.	Queue Accumulation Polygon for Permitted-Plus-Protected Left- Turn Phasing with Exclusive Left-Turn Lane	16-114
Exhibit B16-12.	Traffic-Actuated Timing Computations	16-115
Exhibit B16-13.	Intersection Layout for Multiphase Example	16-117
Exhibit B16-14.	Traffic-Actuated Control Data for Multiphase Example	16-118
Exhibit B16-15.	LOS Results for Multiphase Example	16-119

Exhibit B16-16.	Comparison of Traffic-Actuated Controller Settings for Multiphase Example.....	16-119
Exhibit C16-1.	Adjustment Factors for Left Turns (f_{LT}).....	16-122
Exhibit C16-2.	Permitted Left Turn from Shared Lane	16-123
Exhibit C16-3.	Through-Car Equivalents, E_{L1} , for Permitted Left Turns	16-124
Exhibit C16-4.	Case 1 - Permitted Turns: Standard Case	16-129
Exhibit C16-5.	Case 2 - Green-Time Adjustments for Leading Green	16-129
Exhibit C16-6.	Case 3 - Green-Time Adjustments for Lagging Green	16-130
Exhibit C16-7.	Case 4 - Green-Time Adjustments for Leading and Lagging Green	16-130
Exhibit C16-8.	Case 5 - Green-Time Adjustments for LT Phase with Leading Green	16-131
Exhibit C16-9.	Supplemental Worksheet for Permitted Left Turns Where Approach Is Opposed by Multilane Approach	16-133
Exhibit C16-10.	Supplemental Worksheet for Permitted Left Turns Where Approach Is Opposed by Single-Lane Approach	16-134
Exhibit D16-1.	Conflict Zone Locations	16-136
Exhibit D16-2.	Input Variables	16-137
Exhibit D16-3.	Outline of Computational Procedure for f_{Rpb} and f_{Lpb}	16-138
Exhibit D16-4.	Supplemental Worksheet for Pedestrian-Bicycle Effects	16-139
Exhibit E16-1.	Queue Accumulation Polygons.....	16-140
Exhibit F16-1.	Case III: Initial Queue Delay with Initial Queue Clearing During T	16-143
Exhibit F16-2.	Case IV: Initial Queue Delay with Initial Queue Decreasing During T	16-143
Exhibit F16-3.	Case V: Initial Queue Delay with Initial Queue Increasing During T	16-144
Exhibit F16-4.	Selection of Delay Model Variables by Case	16-145
Exhibit F16-5.	Demand Profile for Multiple-Period Analysis with 15-min Periods ...	16-147
Exhibit F16-6.	Illustration of Delay Model Components for Multiple-Period Analysis	16-149
Exhibit F16-7.	Initial Queue Delay Worksheet	16-150
Exhibit G16-1.	Undersaturated Cycle Back of Queue	16-154
Exhibit G16-2.	Oversaturated Cycle Back of Queue	16-154
Exhibit G16-3.	Contribution of the First and Second Terms of Back of Queue with Poor Progression.....	16-155
Exhibit G16-4.	Contribution of the First and Second Terms of Back of Queue with Good Progression.....	16-155
Exhibit G16-5.	Parameters for 70th-, 85th-, 90th-, 95th-, and 98th-Percentile Back of Queue	16-156
Exhibit G16-6.	Back-of-Queue Worksheet.....	16-157
Exhibit H16-1.	Field Saturation Flow Rate Study Worksheet	16-159

I. INTRODUCTION

SCOPE OF THE METHODOLOGY

This chapter contains a methodology for analyzing the capacity and level of service (LOS) of signalized intersections. The analysis must consider a wide variety of prevailing conditions, including the amount and distribution of traffic movements, traffic composition, geometric characteristics, and details of intersection signalization. The methodology focuses on the determination of LOS for known or projected conditions.

The methodology addresses the capacity, LOS, and other performance measures for lane groups and intersection approaches and the LOS for the intersection as a whole. Capacity is evaluated in terms of the ratio of demand flow rate to capacity (v/c ratio), whereas LOS is evaluated on the basis of control delay per vehicle (in seconds per vehicle). Control delay is the portion of the total delay attributed to traffic signal operation for signalized intersections. Control delay includes initial deceleration delay, queue move-up time, stopped delay, and final acceleration delay. Appendix A presents a method for observing intersection control delay in the field. Exhibit 10-9 provides definitions of the basic terms used in this chapter.

Each lane group is analyzed separately. Equations in this chapter use the subscript i to indicate each lane group. The capacity of the intersection as a whole is not addressed because both the design and the signalization of intersections focus on the accommodation of traffic movement on approaches to the intersection.

The capacity analysis methodology for signalized intersections is based on known or projected signalization plans. Two procedures are available to assist the analyst in establishing signalization plans. The first is the quick estimation method, which produces estimates of the cycle length and green times that can be considered to constitute a reasonable and effective signal timing plan. The quick estimation method requires minimal field data and relies instead on default values for the required traffic and control parameters. It is described and documented in Chapter 10.

A more detailed procedure is provided in Appendix B of this chapter for estimating the timing plan at both pretimed and traffic-actuated signals. The procedure for pretimed signals provides the basis for the design of signal timing plans that equalize the degree of saturation on the critical approaches for each phase of the signal sequence. This procedure does not, however, provide for optimal operation.

The methodology in this chapter is based in part on the results of a National Cooperative Highway Research Program (NCHRP) study (1, 2). Critical movement capacity analysis techniques have been developed in the United States (3–5), Australia (6), Great Britain (7), and Sweden (8). Background for delay estimation procedures was developed in Great Britain (7), Australia (9, 10), and the United States (11). Updates to the original methodology were developed subsequently (12–24).

LIMITATIONS TO THE METHODOLOGY

The methodology does not take into account the potential impact of downstream congestion on intersection operation. Nor does the methodology detect and adjust for the impacts of turn-pocket overflows on through traffic and intersection operation.

II. METHODOLOGY

Exhibit 16-1 shows the input and the basic computation order for the method. The primary output of the method is level of service (LOS). This methodology covers a wide range of operational configurations, including combinations of phase plans, lane

Background and underlying concepts for this chapter are in Chapter 10

A lane group is indicated in formulas by the subscript i

See Chapter 10 for description of quick estimation method

utilization, and left-turn treatment alternatives. It is important to note that some of these configurations may be considered unacceptable by some operating agencies from a traffic safety point of view. The safety aspect of signalized intersections cannot be ignored, and the provision in this chapter of a capacity and LOS analysis methodology for a specific operational configuration does not imply an endorsement of the suitability for application of such a configuration.

EXHIBIT 16-1. SIGNALIZED INTERSECTION METHODOLOGY

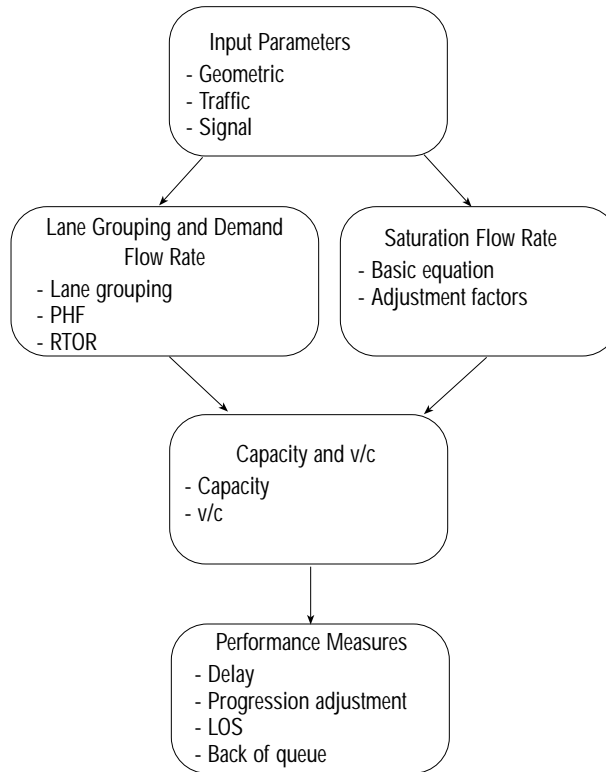

LOS

The average control delay per vehicle is estimated for each lane group and aggregated for each approach and for the intersection as a whole. LOS is directly related to the control delay value. The criteria are listed in Exhibit 16-2.

EXHIBIT 16-2. LOS CRITERIA FOR SIGNALIZED INTERSECTIONS

LOS criteria

LOS	Control Delay per Vehicle (s/veh)
A	≤ 10
B	> 10–20
C	> 20–35
D	> 35–55
E	> 55–80
F	> 80

INPUT PARAMETERS

Exhibit 16-3 provides a summary of the input information required to conduct an operational analysis for signalized intersections. This information forms the basis for selecting computational values and procedures in the modules that follow. The data needed are detailed and varied and fall into three main categories: geometric, traffic, and signalization.

EXHIBIT 16-3. INPUT DATA NEEDS FOR EACH ANALYSIS LANE GROUP

Type of Condition	Parameter
Geometric conditions	Area type Number of lanes, N Average lane width, W (m) Grade, G (%) Existence of exclusive LT or RT lanes Length of storage bay, LT or RT lane, L _s (m) Parking
Traffic conditions	Demand volume by movement, V (veh/h) Base saturation flow rate, s ₀ (pc/h/ln) Peak-hour factor, PHF Percent heavy vehicles, HV (%) Approach pedestrian flow rate, v _{ped} (p/h) Local buses stopping at intersection, N _B (buses/h) Parking activity, N _m (maneuvers/h) Arrival type, AT Proportion of vehicles arriving on green, P Approach speed, S _A (km/h)
Signalization conditions	Cycle length, C (s) Green time, G (s) Yellow-plus-all-red change-and-clearance interval (intergreen), Y (s) Actuated or pretimed operation Pedestrian push-button Minimum pedestrian green, G _p (s) Phase plan Analysis period, T (h)

- Inputs needed
- Geometric,
 - Traffic, and
 - Signalization

Geometric Conditions

Intersection geometry is generally presented in diagrammatic form and must include all of the relevant information, including approach grades, the number and width of lanes, and parking conditions. The existence of exclusive left- or right-turn lanes should be noted, along with the storage lengths of such lanes.

When the specifics of geometry are to be designed, these features must be assumed for the analysis to continue. State or local policies and guidelines should be used in establishing the trial design. When these are not readily available, Chapter 10 contains suggestions for geometric design that may be useful in preparing an assumed preliminary design for analysis.

Traffic Conditions

Traffic volumes (for oversaturated conditions, demand must be used) for the intersection must be specified for each movement on each approach. These volumes are the flow rates in vehicles per hour for the 15-min analysis period, which is the duration of

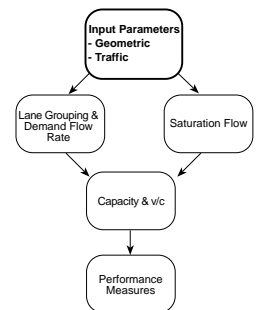

15-min flow rates can be estimated using hourly volumes and PHFs

Study the entire period during which volumes approach and exceed capacity

Heavy vehicles are those having more than four tires on the pavement

the typical analysis period ($T = 0.25$). If the 15-min data are not known, they may be estimated using hourly volumes and peak-hour factors (PHFs). In situations where the v/c is greater than about 0.9, control delay is significantly affected by the length of the analysis period. In these cases, if the 15-min flow rate remains relatively constant for more than 15 min, the length of time the flow is constant should be used as the analysis period, T , in hours.

If v/c exceeds 1.0 during the analysis period, the length of the analysis period should be extended to cover the period of oversaturation in the same fashion, as long as the average flow during that period is relatively constant. If the resulting analysis period is longer than 15 min and different flow rates can be identified during equal-length subperiods within the longer analysis period, a multiple-period analysis using the procedures in Appendix F should be performed using each of these subperiods individually. The length of the subperiods would normally be, but not be limited to, 15 min each.

Vehicle type distribution is quantified as the percent of heavy vehicles (% HV) in each movement, where heavy vehicles are defined as those with more than four tires touching the pavement. The number of local buses on each approach should also be identified, including only those buses making stops to pick up or discharge passengers at the intersection (on either the approach or departure side). Buses not making such stops are considered to be heavy vehicles.

Pedestrian and bicycle flows that interfere with permitted right or left turns are needed. The pedestrian and bicycle flows used to analyze a given approach are the flows in the crosswalk interfering with right turns from the approach. For example, for a westbound approach, the pedestrian and bicycle flows in the north crosswalk would be used for the analysis.

An important traffic characteristic that must be quantified to complete an operational analysis of a signalized intersection is the quality of the progression. The parameter that describes this characteristic is the arrival type, AT, for each lane group. Six arrival types for the dominant arrival flow are defined in Exhibit 16-4.

EXHIBIT 16-4. ARRIVAL TYPES

Arrival Type	Description
1	Dense platoon containing over 80 percent of the lane group volume, arriving at the start of the red phase. This AT is representative of network links that may experience very poor progression quality as a result of conditions such as overall network signal optimization.
2	Moderately dense platoon arriving in the middle of the red phase or dispersed platoon containing 40 to 80 percent of the lane group volume, arriving throughout the red phase. This AT is representative of unfavorable progression on two-way streets.
3	Random arrivals in which the main platoon contains less than 40 percent of the lane group volume. This AT is representative of operations at isolated and noninterconnected signalized intersections characterized by highly dispersed platoons. It may also be used to represent coordinated operation in which the benefits of progression are minimal.
4	Moderately dense platoon arriving in the middle of the green phase or dispersed platoon containing 40 to 80 percent of the lane group volume, arriving throughout the green phase. This AT is representative of favorable progression on a two-way street.
5	Dense to moderately dense platoon containing over 80 percent of the lane group volume, arriving at the start of the green phase. This AT is representative of highly favorable progression quality, which may occur on routes with low to moderate side-street entries and which receive high-priority treatment in the signal timing plan.
6	This arrival type is reserved for exceptional progression quality on routes with near-ideal progression characteristics. It is representative of very dense platoons progressing over a number of closely spaced intersections with minimal or negligible side-street entries.

The arrival type is best observed in the field but can be approximated by examining time-space diagrams for the street in question. The arrival type should be determined as accurately as possible because it will have a significant impact on delay estimates and LOS determination. Although there are no definitive parameters to precisely quantify arrival type, the platoon ratio is computed by Equation 16-1.

$$R_p = \frac{P}{\frac{g_i}{C}} \tag{16-1}$$

where

- R_p = platoon ratio,
- P = proportion of all vehicles in movement arriving during green phase,
- C = cycle length (s), and
- g_i = effective green time for movement or lane group (s).

P may be estimated or observed in the field, whereas g_i and C are computed from the signal timing. The value of P may not exceed 1.0.

Signalization Conditions

Complete information regarding signalization is needed to perform an analysis. This information includes a phase diagram illustrating the phase plan, cycle length, green times, and change-and-clearance intervals. Lane groups operating under actuated control must be identified, including the existence of push-button pedestrian-actuated phases.

If pedestrian timing requirements exist, the minimum green time for the phase is indicated and provided for in the signal timing. The minimum green time for a phase is estimated by Equation 16-2 or local practice.

$$G_p = 3.2 + \frac{L}{S_p} + \left(0.81 \frac{N_{ped}}{W_E} \right) \text{ for } W_E > 3.0 \text{ m} \tag{16-2}$$

$$G_p = 3.2 + \frac{L}{S_p} + (0.27 N_{ped}) \text{ for } W_E \leq 3.0 \text{ m}$$

where

- G_p = minimum green time (s),
- L = crosswalk length (m),
- S_p = average speed of pedestrians (m/s),
- W_E = effective crosswalk width (m),
- 3.2 = pedestrian start-up time (s), and
- N_{ped} = number of pedestrians crossing during an interval (p).

It is assumed that the 15th-percentile walking speed of pedestrians crossing a street is 1.2 m/s in this computation. This value is intended to accommodate crossing pedestrians who walk at speeds slower than the average. Where local policy uses different criteria for estimating minimum pedestrian crossing requirements, these criteria should be used in lieu of Equation 16-2.

When signal phases are actuated, the cycle length and green times will vary from cycle to cycle in response to demand. To establish values for analysis, the operation of the signal should be observed in the field during the same period that volumes are observed. Average field-measured values of cycle length and green time may then be used.

When signal timing is to be established for analysis, state or local policies and procedures should be applied where appropriate. Appendix B contains suggestions for the design of a trial signal timing. These suggestions should not be construed to be standards or criteria for signal design. A trial signal timing cannot be designed until the volume adjustment and saturation flow rate modules have been completed. In some

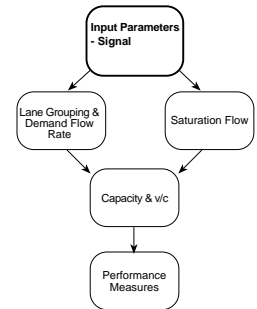

15th-percentile pedestrian speed is assumed as 1.2 m/s. Local values can be substituted.

Appendix B contains procedure for estimating average cycle lengths under actuated control

cases, the computations will be iterative because left-turn adjustments for permitted turns used in the saturation flow rate module depend on signal timing. Appendix B also contains suggestions for estimating the timing of an actuated signal if field observations are unavailable.

An operational analysis requires the specification of a signal timing plan for the intersection under study. The planning level application presented in Chapter 10 offers a procedure for establishing a reasonable and effective signal timing plan. This procedure is recommended only for the estimation of LOS and not for the design of an implementable signal timing plan. The signal timing design process is more complicated and involves, for example, iterative checks for minimum green-time violations. When phases are traffic actuated, the timing plan will differ for each cycle. The traffic-actuated procedure presented in Appendix B can be used to estimate the average cycle length and phase times under these conditions provided that the signal controller settings are available.

The design of an implementable timing plan is a complex and iterative process that can be carried out with the assistance of computer software. Although the methodology presented here is oriented toward the estimation of delay at traffic signals, it was suggested earlier that the computations can be applied iteratively to develop a signal timing plan. Some of the available signal timing software products employ the methodology of this chapter, at least in part.

There are, however, several aspects of signal timing design that are beyond the scope of this manual. One such aspect is the choice of the timing strategy itself. At intersections with traffic-actuated phases, the signal timing plan is determined on each cycle by the instantaneous traffic demand and the controller settings. When all of the phases are pretimed, a timing plan design must be developed. Timing plan design and estimation are covered in detail in Appendix B.

LANE GROUPING

The methodology for signalized intersections is disaggregate; that is, it is designed to consider individual intersection approaches and individual lane groups within approaches. Segmenting the intersection into lane groups is a relatively simple process that considers both the geometry of the intersection and the distribution of traffic movements. In general, the smallest number of lane groups is used that adequately describes the operation of the intersection. The following guidelines may be applied.

- An exclusive left-turn lane or lanes should normally be designated as a separate lane group unless there is also a shared left-through lane present, in which case the proper lane grouping will depend on the distribution of traffic volume between the movements. The same is true of an exclusive right-turn lane.
- On approaches with exclusive left-turn or right-turn lanes, or both, all other lanes on the approach would generally be included in a single lane group.
- When an approach with more than one lane includes a lane that may be used by both left-turning vehicles and through vehicles, it is necessary to determine whether equilibrium conditions exist or whether there are so many left turns that the lane essentially acts as an exclusive left-turn lane, which is referred to as a de facto left-turn lane.









De facto left-turn lanes cannot be identified effectively until the proportion of left turns in the shared lane has been computed. If the computed proportion of left turns in the shared lane equals 1.0 (i.e., 100 percent), the shared lane must be considered a de facto left-turn lane.

When two or more lanes are included in a lane group for analysis purposes, all subsequent computations treat these lanes as a single entity. Exhibit 16-5 shows some common lane groups used for analysis.

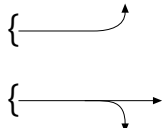

The analyst should determine if there is a de facto left-turn lane

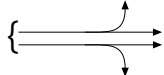
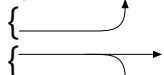
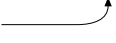
EXHIBIT 16-5. TYPICAL LANE GROUPS FOR ANALYSIS

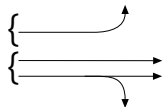
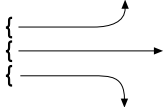
Number of Lanes	Movements by Lanes	Number of Possible Lane Groups
1	LT + TH + RT 	①  (Single-lane approach)
2	EXC LT  TH + RT 	② 
2	LT + TH  TH + RT 	①  OR ② 
3	EXC LT  TH  TH + RT 	②  OR ③ 

DETERMINING FLOW RATE

Demand volumes are best provided as average flow rates (in vehicles per hour) for the analysis period. Although analysis periods are usually 15 min long, the procedures for this chapter allow for any length of time to be used. However, demand volumes may also be stated for a time that encompasses more than one analysis period, such as an hourly volume. In such cases, peaking factors must be provided that convert these to demand flow rates for each particular analysis period.

Alternative Study Approaches

Two major analytic steps are performed in the volume adjustment module. Movement volumes are adjusted to flow rates for each desired period of analysis, if necessary, and lane groups for analysis are established. Exhibit 16-6 demonstrates three alternative ways in which an analyst might proceed for a given study. Other alternatives exist. Approach A is the one that has traditionally been used in the HCM. The length of the period being analyzed is only 15 min, and the analysis period (T), therefore, is 15 min or 0.25 h. In this case, either a peak 15-min volume is available or one is derived from an hourly volume by use of a PHF. A difficulty with considering only one 15-min period is that a queue may be left at the end of the analysis period because of demand in excess of capacity. In such cases it is possible that the queue carried over to the next period will result in delay to vehicles that arrive in that period beyond that which would have resulted had there not been a queue carryover.

If queue carryover occurs, a multiple-period analysis is best

Approach A may involve use of PHF, but Approach C will not

EXHIBIT 16-6. THREE ALTERNATIVE STUDY APPROACHES

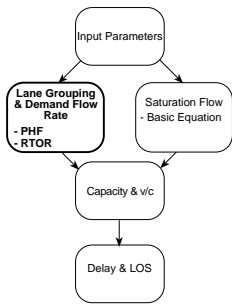
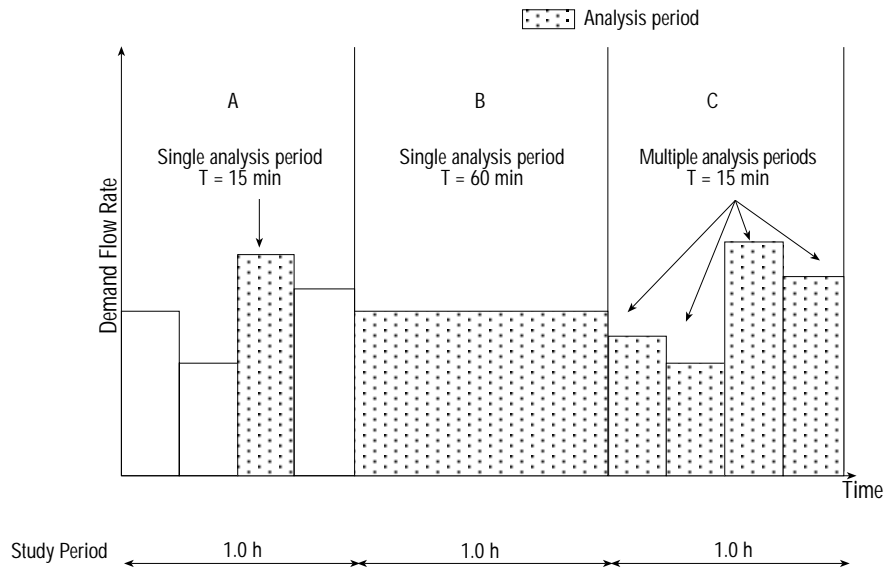

Approach B involves a study of an entire hour of operation at the site using an analysis period (T) of 60 min. In this case, the analyst may have included the more critical period of operation, missed under Approach A, but because the volume being used is an hourly one, it implicitly assumes that the arrival of vehicles on the approach is distributed equally across the period of study. Therefore, the effects of peaking within the hour may not be identified, especially if, by the end of the hour, any excess queuing can be dissipated. The analyst therefore runs the risk of underestimating delays during the hour. If a residual queue remains at the end of 60 min, a second 60-min period of analysis can be used (and so on) until the total period ends with no excess queue.

Approach C involves a study of the entire hour but divides it into four 15-min analysis periods (T). The procedures in this chapter allow the analyst to account for queues that carry over to the next analysis period. Therefore, when demand exceeds capacity during the study period, a more accurate representation of delay experienced during the hour can be achieved using this method.

A peak 15-min flow rate is derived from an hourly volume by dividing the movement volumes by an appropriate PHF, which may be defined for the intersection as a whole, for each approach, or for each movement. The flow rate is computed using Equation 16-3.

$$v_p = \frac{V}{PHF} \tag{16-3}$$

where

- v_p = flow rate during peak 15-min period (veh/h),
- V = hourly volume (veh/h), and
- PHF = peak-hour factor.

Use of a single PHF assumes that all movements peak in the same period

The conversion of hourly volumes to peak flow rates using the PHF assumes that all movements peak during the same 15-min period, and somewhat higher estimates of control delay will result. PHF values of 1.0 should be used if 15-min flow rates are entered directly. Because not all intersection movements may peak at the same time, it is valuable to observe 15-min flows directly and select critical periods for analysis. It is particularly conservative if different PHF values are assumed for each movement. It should be noted also that statistically valid surveys of the PHF for individual movements are difficult to obtain during a single peak hour.

Adjustment for Right Turn on Red

When right turn on red (RTOR) is permitted, the right-turn volume for analysis may be reduced by the volume of right-turning vehicles moving on the red phase. This reduction is generally done on the basis of hourly volumes before the conversion to flow rates.

The number of vehicles able to turn right on a red phase is a function of several factors, including

- Approach lane allocation (shared or exclusive right-turn lane),
- Demand for right-turn movements,
- Sight distance at the intersection approach,
- Degree of saturation of the conflicting through movement,
- Arrival patterns over the signal cycle,
- Left-turn signal phasing on the conflicting street, and
- Conflicts with pedestrians.

For an existing intersection, it is appropriate to consider the RTORs that actually occur. For both the shared lane and the exclusive right-turn lane conditions, the number of RTORs may be subtracted from the right-turn volume before analysis of lane group capacity or LOS. At an existing intersection, the number of RTORs should be determined by field observation.

If the analysis is dealing with future conditions or if the RTOR volume is not known from field data, it is necessary to estimate the number of RTOR vehicles. In the absence of field data, it is preferable for most purposes to utilize the right-turn volumes directly without a reduction for RTOR except when an exclusive right-turn lane movement runs concurrent with a protected left-turn phase from the cross street. In this case the total right-turn volume for analysis can be reduced by the number of shadowed left turners. Free-flowing right turns that are not under signal control should be removed entirely from the analysis.

Subtract RTOR volume from RT volume

If field data are not available, ignore RTOR, except in special cases. Remove free-flowing RTs from RT volume.

DETERMINING SATURATION FLOW RATE

A saturation flow rate for each lane group is computed according to Equation 16-4. The saturation flow rate is the flow in vehicles per hour that can be accommodated by the lane group assuming that the green phase were displayed 100 percent of the time (i.e., $g/C = 1.0$).

$$s = s_o N f_w f_{HV} f_g f_p f_{bb} f_a f_{LU} f_{LT} f_{RT} f_{Lpb} f_{Rpb} \quad (16-4)$$

where

- s = saturation flow rate for subject lane group, expressed as a total for all lanes in lane group (veh/h);
- s_o = base saturation flow rate per lane (pc/h/ln);
- N = number of lanes in lane group;
- f_w = adjustment factor for lane width;
- f_{HV} = adjustment factor for heavy vehicles in traffic stream;
- f_g = adjustment factor for approach grade;
- f_p = adjustment factor for existence of a parking lane and parking activity adjacent to lane group;
- f_{bb} = adjustment factor for blocking effect of local buses that stop within intersection area;
- f_a = adjustment factor for area type;
- f_{LU} = adjustment factor for lane utilization;
- f_{LT} = adjustment factor for left turns in lane group;
- f_{RT} = adjustment factor for right turns in lane group;
- f_{Lpb} = pedestrian adjustment factor for left-turn movements; and
- f_{Rpb} = pedestrian-bicycle adjustment factor for right-turn movements.

See Exhibit 16-7 for formulas. For default values refer to Chapter 10.

Field measurement method for saturation flow is described in Appendix H

Do not use width < 2.4 m for calculations

Parking maneuver assumed to block traffic for 18 s. Use practical limit of 180 maneuvers/h.

Applies to bus stops within 75 m of the stop line and a limit of 250 buses/h

Appendix H presents a field measurement method for determining saturation flow rate. Field-measured values of saturation flow rate will produce more accurate results than the estimation procedure described here and can be used directly without further adjustment.

Base Saturation Flow Rate

Computations begin with the selection of a base saturation flow rate, usually 1,900 passenger cars per hour per lane (pc/h/ln). This value is adjusted for a variety of conditions. The adjustment factors are given in Exhibit 16-7.

Adjustment for Lane Width

The lane width adjustment factor, f_w , accounts for the negative impact of narrow lanes on saturation flow rate and allows for an increased flow rate on wide lanes. Standard lane widths are 3.6 m. The lane width factor may be calculated with caution for lane widths greater than 4.8 m, or an analysis using two narrow lanes may be conducted. Note that use of two narrow lanes will always result in a higher saturation flow rate than a single wide lane, but in either case, the analysis should reflect the way in which the width is actually used or expected to be used. In no case should the lane width factor be calculated for widths less than 2.4 m.

Adjustment for Heavy Vehicles and Grade

The effects of heavy vehicles and approach grades are treated by separate factors, f_{HV} and f_g , respectively. Their separate treatment recognizes that passenger cars are affected by approach grades, as are heavy vehicles. Heavy vehicles are defined as those with more than four tires touching the pavement. The heavy-vehicle factor accounts for the additional space occupied by these vehicles and for the difference in operating capabilities of heavy vehicles compared with passenger cars. The passenger-car equivalent (E_T) used for each heavy vehicle is 2.0 passenger-car units and is reflected in the formula. The grade factor accounts for the effect of grades on the operation of all vehicles.

Adjustment for Parking

The parking adjustment factor, f_p , accounts for the frictional effect of a parking lane on flow in an adjacent lane group as well as for the occasional blocking of an adjacent lane by vehicles moving into and out of parking spaces. Each maneuver (either in or out) is assumed to block traffic in the lane next to the parking maneuver for an average of 18 s. The number of parking maneuvers used is the number of maneuvers per hour in parking areas directly adjacent to the lane group and within 75 m upstream from the stop line. If more than 180 maneuvers per hour exist, a practical limit of 180 should be used. If the parking is adjacent to an exclusive turn lane group, the factor only applies to that lane group. On a one-way street with no exclusive turn lanes, the number of maneuvers used is the total for both sides of the lane group. Note that parking conditions with zero maneuvers have a different impact than a no-parking situation.

Adjustment for Bus Blockage

The bus blockage adjustment factor, f_{bb} , accounts for the impacts of local transit buses that stop to discharge or pick up passengers at a near-side or far-side bus stop within 75 m of the stop line (upstream or downstream). This factor should only be used when stopping buses block traffic flow in the subject lane group. If more than 250 buses per hour exist, a practical limit of 250 should be used. When local transit buses are believed to be a major factor in intersection performance, Chapter 27 may be consulted for more information on this effect. The factor used here assumes an average blockage time of 14.4 s during a green indication.

EXHIBIT 16-7. ADJUSTMENT FACTORS FOR SATURATION FLOW RATE^a

Factor	Formula	Definition of Variables	Notes
Lane width	$f_w = 1 + \frac{(W - 3.6)}{9}$	W = lane width (m)	W ≥ 2.4 If W > 4.8, a two-lane analysis may be considered
Heavy vehicles	$f_{HV} = \frac{100}{100 + \% HV(E_T - 1)}$	% HV = % heavy vehicles for lane group volume	E _T = 2.0 pc/HV
Grade	$f_g = 1 - \frac{\% G}{200}$	% G = % grade on a lane group approach	-6 ≤ % G ≤ +10 Negative is downhill
Parking	$f_p = \frac{N - 0.1 - \frac{18N_m}{3600}}{N}$	N = number of lanes in lane group N _m = number of parking maneuvers/h	0 ≤ N _m ≤ 180 f _p ≥ 0.050 f _p = 1.000 for no parking
Bus blockage	$f_{bb} = \frac{N - \frac{14.4N_B}{3600}}{N}$	N = number of lanes in lane group N _B = number of buses stopping/h	0 ≤ N _B ≤ 250 f _{bb} ≥ 0.050
Type of area	f _a = 0.900 in CBD f _a = 1.000 in all other areas		
Lane utilization	f _{LU} = v _g / (v _{g1} N)	v _g = unadjusted demand flow rate for the lane group, veh/h v _{g1} = unadjusted demand flow rate on the single lane in the lane group with the highest volume N = number of lanes in the lane group	
Left turns	Protected phasing: Exclusive lane: f _{LT} = 0.95 Shared lane: $f_{LT} = \frac{1}{1.0 + 0.05P_{LT}}$	P _{LT} = proportion of LTs in lane group	See Exhibit C16-1, Appendix C, for nonprotected phasing alternatives
Right turns	Exclusive lane: f _{RT} = 0.85 Shared lane: f _{RT} = 1.0 - (0.15)P _{RT} Single lane: f _{RT} = 1.0 - (0.135)P _{RT}	P _{RT} = proportion of RTs in lane group	f _{RT} ≥ 0.050
Pedestrian-bicycle blockage	LT adjustment: f _{Lpb} = 1.0 - P _{LT} (1 - A _{pbT}) (1 - P _{LTA}) RT adjustment: f _{Rpb} = 1.0 - P _{RT} (1 - A _{pbT}) (1 - P _{RTA})	P _{LT} = proportion of LTs in lane group A _{pbT} = permitted phase adjustment P _{LTA} = proportion of LT protected green over total LT green P _{RT} = proportion of RTs in lane group P _{RTA} = proportion of RT protected green over total RT green	Refer to Appendix D for step-by-step procedure

Note:

See Chapter 10, Exhibit 10-12, for default values of base saturation flow rates and variables used to derive adjustment factors.
a. The table contains formulas for all adjustment factors. However, for situations in which permitted phasing is involved, either by itself or in combination with protected phasing, separate tables are provided, as indicated in this exhibit.

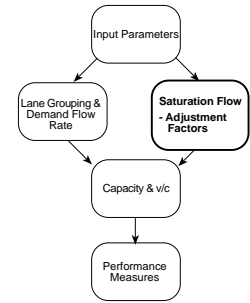

The factor reflects increased headways due to regular and frequent interferences

Adjustment for Area Type

The area type adjustment factor, f_a , accounts for the relative inefficiency of intersections in business districts in comparison with those in other locations.

Application of this adjustment factor is typically appropriate in areas that exhibit central business district (CBD) characteristics. These characteristics include narrow street rights-of-way, frequent parking maneuvers, vehicle blockages, taxi and bus activity, small-radius turns, limited use of exclusive turn lanes, high pedestrian activity, dense population, and mid-block curb cuts. Use of this factor should be determined on a case-by-case basis. This factor is not limited to designated CBD areas, nor will it need to be used for all CBD areas. Instead, this factor should be used in areas where the geometric design and the traffic or pedestrian flows, or both, are such that the vehicle headways are significantly increased to the point where the capacity of the intersection is adversely affected.

Adjustment for Lane Utilization

The lane utilization adjustment factor, f_{LU} , accounts for the unequal distribution of traffic among the lanes in a lane group with more than one lane. The factor provides an adjustment to the base saturation flow rate. The adjustment factor is based on the flow in the lane with the highest volume and is calculated by Equation 16-5:

$$f_{LU} = \frac{v_g}{(v_{g1}N)} \quad (16-5)$$

where

- f_{LU} = lane utilization adjustment factor,
- v_g = unadjusted demand flow rate for lane group (veh/h),
- v_{g1} = unadjusted demand flow rate on single lane with highest volume in lane group (veh/h), and
- N = number of lanes in lane group.

This adjustment is normally applied and can be used to account for the variation of traffic flow on the individual lanes in a lane group due to upstream or downstream roadway characteristics such as changes in the number of lanes available or flow characteristics such as the repositioning of traffic within a lane group for heavy turning movements.

Actual lane volume distributions observed in the field should be used, if known, in the computation of the lane utilization adjustment factor. A lane utilization factor of 1.0 can be used when uniform traffic distribution can be assumed across all lanes in the lane group or when a lane group comprises a single lane. When average conditions exist or traffic distribution in a lane group is not known, the default values summarized in Chapter 10 can be used. Guidance on how to account for impacts of short lane adds or drops is also given in Chapter 10.

Adjustment for Right Turns

The right-turn adjustment factors, f_{RT} , in Exhibit 16-7 are primarily intended to reflect the effect of geometry. A separate pedestrian and bicycle blockage factor is used to reflect the volume of pedestrians and bicycles using the conflicting crosswalk.

The right-turn adjustment factor depends on a number of variables, including

- Whether the right turn is made from an exclusive or shared lane, and
- Proportion of right-turning vehicles in the shared lanes.

The right-turn factor is 1.0 if the lane group does not include any right turns. When RTOR is permitted, the right-turn volume may be reduced as described in the discussion of RTOR.

The right-turn adjustment factor is 1.0 if the lane group does not include any right turns

Adjustment for Left Turns

The left-turn adjustment factor, f_{LT} , is based on variables similar to those for the right-turn adjustment factor, including

- Whether left turns are made from exclusive or shared lanes,
- Type of phasing (protected, permitted, or protected-plus-permitted),
- Proportion of left-turning vehicles using a shared lane group, and
- Opposing flow rate when permitted left turns are made.

An additional factor for pedestrian blockage is provided, based on pedestrian volumes. Left-turn adjustment factors are used for six cases of left-turn phasing, as follows:

- Case 1: Exclusive lane with protected phasing,
- Case 2: Exclusive lane with permitted phasing,
- Case 3: Exclusive lane with protected-plus-permitted phasing,
- Case 4: Shared lane with protected phasing,
- Case 5: Shared lane with permitted phasing, and
- Case 6: Shared lane with protected-plus-permitted phasing.

Adjustment for Pedestrians and Bicyclists

The procedure to determine the left-turn pedestrian-bicycle adjustment factor, f_{Lpb} , and the right-turn pedestrian-bicycle adjustment factor, f_{Rpb} , consists of four steps. The first step is to determine average pedestrian occupancy, which only accounts for the pedestrian effect. Then relevant conflict zone occupancy, which accounts for both pedestrian and bicycle effects, is determined. Relevant conflict zone occupancy takes into account whether other traffic is also in conflict (e.g., adjacent bicycle flow for the case of right turns or opposing vehicle flow for the case of left turns). In either case, adjustments to the initial occupancy are made. The proportion of green time in which the conflict zone is occupied is determined as a function of the relevant occupancy and the number of receiving lanes for the turning vehicles.

The proportion of right turns using the protected portion of a protected-plus-permitted phase is also needed. This proportion should be determined by field observation, but a gross estimate can be made from the signal timing by assuming that the proportion of right-turning vehicles using the protected phase is approximately equal to the proportion of the turning phase that is protected. If $P_{RTA} = 1.0$ (that is, the right turn is completely protected from conflicting pedestrians), a pedestrian volume of zero should be used.

Finally, the saturation flow adjustment factor is calculated from the final occupancy on the basis of the turning movement protection status and the percent of turning traffic in the lane group. A comprehensive step-by-step procedure is provided in Appendix D.

DETERMINING CAPACITY AND v/c RATIO

Capacity

Capacity at signalized intersections is based on the concept of saturation flow and saturation flow rate. The flow ratio for a given lane group is defined as the ratio of the actual or projected demand flow rate for the lane group (v_i) and the saturation flow rate (s_i). The flow ratio is given the symbol $(v/s)_i$ for lane group i . The capacity of a given lane group may be stated as shown in Equation 16-6:

The left-turn adjustment factor is 1.0 if the lane group does not include any left turns

Phasing	Left Turn Adjustment Cases	
	Lane	
	LT Excl	LT Share
Protected	1	4
Permitted	2	5
Prot/Perm	3	6

Capacity and flow ratio defined

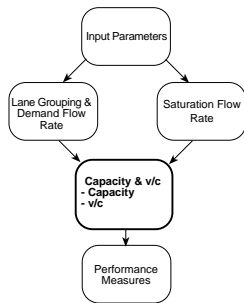

Green ratio defined
Degree of saturation defined

$$c_i = s_i \frac{g_i}{C} \quad (16-6)$$

where

- c_i = capacity of lane group i (veh/h),
- s_i = saturation flow rate for lane group i (veh/h), and
- g_i/C = effective green ratio for lane group i .

v/c Ratio

The ratio of flow rate to capacity (v/c), often called the volume to capacity ratio, is given the symbol X in intersection analysis. It is typically referred to as degree of saturation. For a given lane group i , X_i is computed using Equation 16-7.

$$X_i = \left(\frac{v}{c} \right)_i = \frac{v_i}{s_i \left(\frac{g_i}{C} \right)} = \frac{v_i C}{s_i g_i} \quad (16-7)$$

where

- X_i = $(v/c)_i$ = ratio for lane group i ,
- v_i = actual or projected demand flow rate for lane group i (veh/h),
- s_i = saturation flow rate for lane group i (veh/h),
- g_i = effective green time for lane group i (s), and
- C = cycle length (s).

Sustainable values of X_i range from 1.0 when the flow rate equals capacity to zero when the flow rate is zero. Values above 1.0 indicate an excess of demand over capacity. The capacity of the entire intersection is not a significant concept and is not specifically defined here. Rarely do all movements at an intersection become saturated at the same time of day.

Critical Lane Groups

Another concept used for analyzing signalized intersections is the critical v/c ratio, X_c . This is the v/c ratio for the intersection as a whole, considering only the lane groups that have the highest flow ratio (v/s) for a given signal phase. For example, with a two-phase signal, opposing lane groups move during the same green time. Generally, one of these two lane groups will require more green time than the other (i.e., it will have a higher flow ratio). This would be the critical lane group for that signal phase. Each signal phase will have a critical lane group that determines the green-time requirements for the phase. When signal phases overlap, the identification of these critical lane groups becomes somewhat complex. The critical v/c ratio for the intersection is determined by using Equation 16-8:

$$X_c = \sum \left(\frac{v}{s} \right)_{ci} \left(\frac{C}{C-L} \right) \quad (16-8)$$

where

- X_c = critical v/c ratio for intersection;
- $\sum \left(\frac{v}{s} \right)_{ci}$ = summation of flow ratios for all critical lane groups i ;
- C = cycle length (s); and
- L = total lost time per cycle, computed as lost time, t_L , for critical path of movements (s).

Equation 16-8 is useful in evaluating the overall intersection with respect to the geometrics and total cycle length and also in estimating signal timings when they are

X_c is v/c for critical movements, assuming green time allocated proportionately to v/s values

unknown or not specified by local policies or procedures. It gives the v/c ratio for all critical movements, assuming that green time has been allocated in proportion to the v/s values. Flow ratios are computed by dividing the adjusted demand flow, v , computed in the volume adjustment module by the adjusted saturation flow rate, s .

If the signal timing is not known, a timing plan will have to be estimated or assumed to make these computations. Appendix B contains suggestions for making these estimates, but state or local policies and guidelines should also be consulted. A quick estimation method also offers a procedure for the synthesis of timing plans based on the concepts presented in Chapter 10.

The v/c ratio for each lane group is computed directly by dividing the adjusted flows by the capacities computed above, as in Equation 16-7. It is possible to have a critical v/c ratio of less than 1.0 and still have individual movements oversaturated within the signal cycle. A critical v/c ratio less than 1.0, however, does indicate that all movements in the intersection can be accommodated within the defined cycle length and phase sequence by proportionally allocating green time.

The X_c value can, however, be misleading when used as an indicator of the overall sufficiency of the intersection geometrics, as is often required in planning applications. The problem is that low flow rates dictate the need for short cycle lengths to minimize delay. Equation 16-8 suggests that shorter cycle lengths produce a higher X_c for a specified level of traffic demand. Furthermore, many signal timing methods, including the quick estimation method described in Appendix A of Chapter 10, are based on a fixed target value of X_c . This tends to make X_c independent of the demand volumes.

The computation of the critical v/c ratio, X_c , requires that critical lane groups be identified. During each signal phase, green indications are displayed to one or more lane groups. One lane group will have the most intense demand and will be the one that determines the amount of green time needed. This lane group will be the critical lane group for the phase in question.

The normalized measure of demand intensity in any lane group is given by the v/s ratio. With no overlapping phases in the signal design, such as in a simple two-phase signal, the determination of critical lane groups is straightforward. In each discrete phase, the lane group with the highest v/s ratio is critical.

Overlapping phases are more difficult to analyze because various lane groups may have traffic flow in several phases of the signal, and some left-turn movements may operate on a protected-and-permitted basis in various portions of the cycle. In such cases, it is necessary to find the critical path through the signal cycle. The path having the highest sum of v/s ratios is the critical path.

When phases overlap, the critical path must conform to the following rules:

- Excluding lost times, one critical lane group must be moving at all times during the signal cycle;
 - At no time in the signal cycle may more than one critical lane group be moving;
- and
- The critical path has the highest sum of v/s ratios.

These rules are more easily explained by example. Consider the case of a leading and lagging green phase plan on a street with exclusive left-turn lanes, as shown in Exhibit 16-8. Phase 1 is discrete, with NB and SB lane groups moving simultaneously. The critical lane group for Phase 1 is chosen on the basis of the highest v/s ratio, which is 0.30 for the NB lane group.

Phase 2 involves overlapping leading and lagging green phases. There are two possible paths through Phase 2 that conform to the stated rule that (except for lost times) there must be only one critical lane group moving at any time. The EB through and right-turn (T/R) lane group moves through Phases 2A and 2B with a v/s ratio of 0.30. The WB left-turn lane group moves only in Phase 2C with a v/s ratio of 0.15. The total v/s ratio for this path is therefore $0.30 + 0.15$, or 0.45. The only alternative path involves the EB left-turn lane group, which moves only in Phase 2A ($v/s = 0.25$), and the WB T/R

To compute X_c , the critical lane groups must be identified

Guidelines for identifying critical lane groups

lane group, which moves in Phases 2B and 2C ($v/s = 0.25$). Because the sum of the v/s ratios for this path is $0.25 + 0.25 = 0.50$, this is the critical path through Phase 2. Thus, the sum of critical v/s ratios for the cycle is 0.30 for Phase 1 plus 0.50 for Phase 2, for a total of 0.80.

EXHIBIT 16-8. CRITICAL LANE GROUP DETERMINATION WITH PROTECTED LEFT TURNS

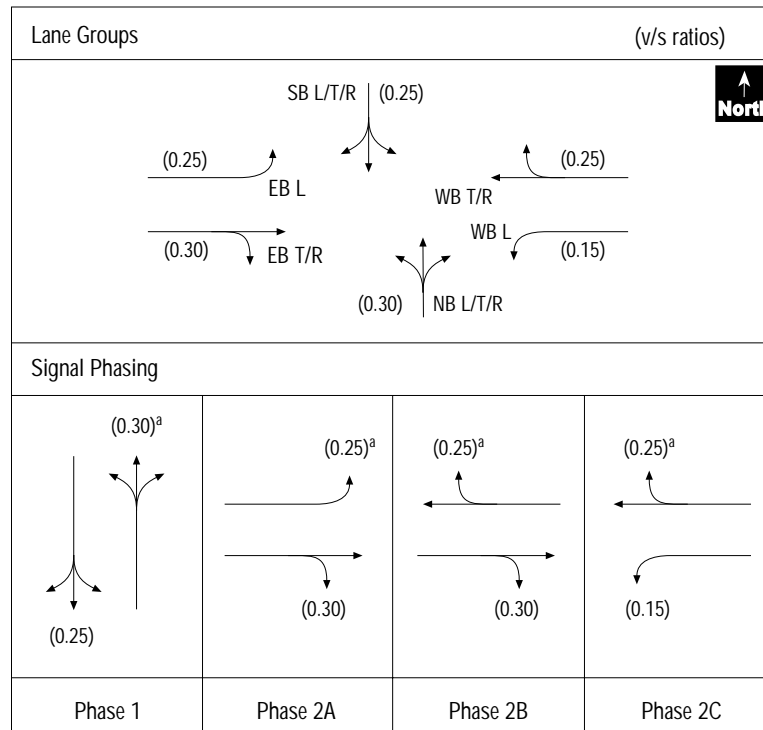

Note:
a. Critical v/s .

The solution for X_c also requires that the lost time for the critical path (L) through the signal be determined. Using the general rule that a movement's lost time of t_L is applied when a movement is initiated, the following conclusions are reached:

- The critical NB movement is initiated in Phase 1, and its lost time is applied;
- The critical EB left-turn movement is initiated in Phase 2A, and its lost time is applied;
- The critical WB T/L movement is initiated in Phase 2B, and its lost time is applied;
- No critical movement is initiated in Phase 2C, so no lost time is applied to the critical path here; although the WB left-turn movement is initiated in this phase, it is not a critical movement, and its lost time is not included in L ; and
- For this case, $L = 3t_L$, assuming that each movement has the same lost time, t_L .

This problem may be altered significantly by adding a permitted left turn in both directions to Phase 2B, as shown in Exhibit 16-9, with the resulting v/s ratios. Note that in this case, a separate v/s ratio is computed for the protected and permitted portions of the EB and WB left-turn movements. In essence, the protected and permitted portions of these movements are treated as separate lane groups.

The analysis of Phase 1 does not change, because it is discrete. The NB lane group is still critical, with a v/s ratio of 0.30. There are now four different potential paths through Phase 2 that conform to the rules for determining critical paths:

- WB T/R + EB left turn (protected) = $0.25 + 0.20 = 0.45$,
- EB T/R + WB left turn (protected) = $0.30 + 0.05 = 0.35$,

- EB left turn (protected) + EB left turn (permitted) + WB left turn (protected) = $0.20 + 0.15 + 0.05 = 0.40$, and
- EB left turn (protected) + WB left turn (permitted) + WB left turn (protected) = $0.20 + 0.22 + 0.05 = 0.47$.

EXHIBIT 16-9. CRITICAL LANE GROUP DETERMINATION WITH PROTECTED AND PERMITTED LEFT TURNS

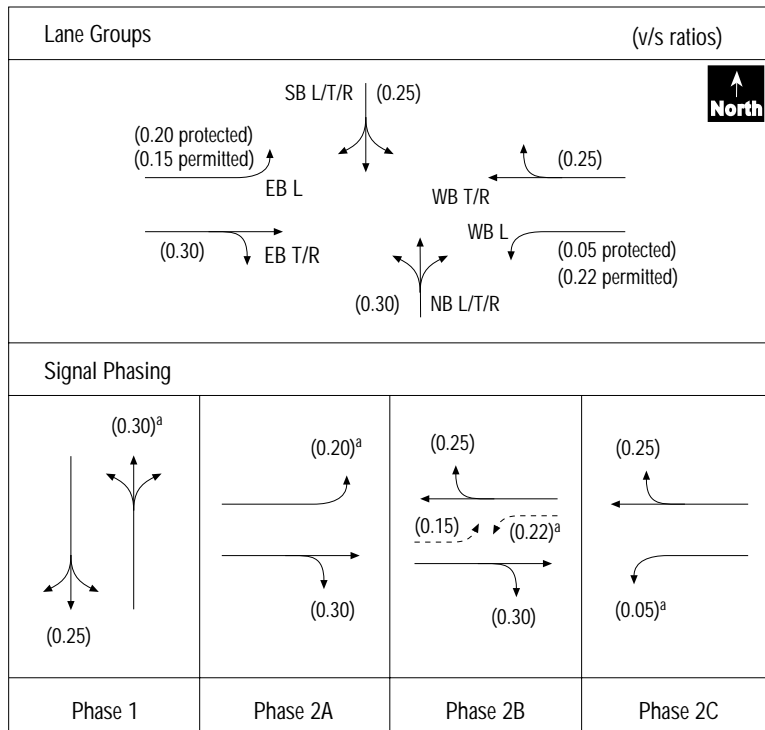

Note:
a. Critical v/s.

The critical path through Phase 2 is the alternative with the highest total v/s ratio, in this case, 0.47. When 0.47 is added to the 0.30 for Phase 1, the sum of critical v/s ratios is 0.77.

The lost time for the critical path is determined as follows:

- The NB critical flow begins in Phase 1, and its lost time is applied;
- The critical EB left turn (protected) is initiated in Phase 2A, and its lost time is applied;
- The critical WB left turn (permitted) is initiated in Phase 2B, and its lost time is applied;
- The critical WB left turn (protected) is a continuation of the WB left turn (permitted); because the left-turn movement is already moving when Phase 2C is initiated, no lost time is applied here; and
- For this case, $L = 3t_L$, assuming that each movement has the same lost time, t_L .

Exhibit 16-10 shows another complex case with actuated control and a typical eight-phase plan. Although eight phases are provided on the controller, the path through the cycle cannot include more than six of these phases, as shown. The leading phases (1B and 2B) will be chosen on the basis of which left-turn movements have higher demands on a cycle-by-cycle basis.

EXHIBIT 16-10. CRITICAL LANE GROUP DETERMINATION FOR MULTIPHASE SIGNAL

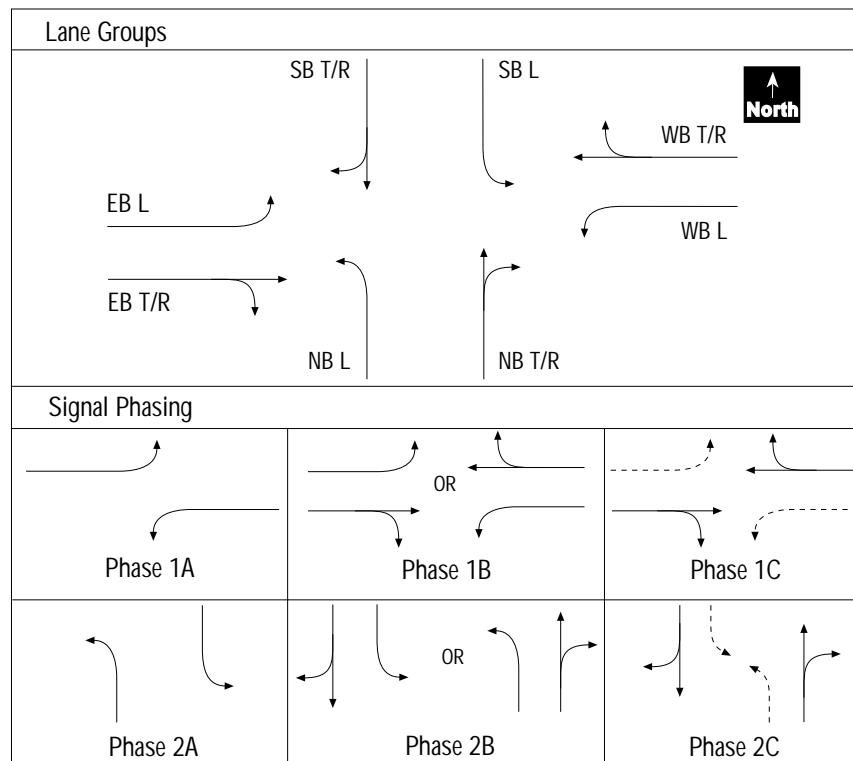

The potential critical paths through Phase 1 are as follows:

- EB left turn (protected) + EB left turn (permitted),
- EB left turn (protected) + WB left turn (permitted),
- EB left turn (protected) + WB T/R,
- WB left turn (protected) + WB left turn (permitted),
- WB left turn (protected) + EB left turn (permitted), and
- WB left turn (protected) + EB T/R.

The combination with the highest v/s ratio would be chosen as the critical path. A similar set of choices exists for Phase 2, with NB replacing EB and SB replacing WB.

The most interesting aspect of this problem is the number of lost times that must be included in L for each of these paths. The paths involving EB left turn (protected) + EB left turn (permitted) and WB left turn (protected) + WB left turn (permitted) each involve only one application of t_L because the turning movement in question moves continuously throughout the three subphases. All other paths involve two applications of t_L because each critical movement is initiated in a distinct portion of the phase. Note that the left turn that does not continue in Phase 1B or 2B is a discontinuous movement; that is, it moves as a protected turn in Phase 1A or 2A, stops in Phase 1B or 2B, and moves again as a permitted turn in Phase 1C or 2C.

For this complex phasing, the lost time through each major phase could have one or two lost times applied, based on the critical path. Therefore, for the total cycle, which comprises two streets, two to four lost times will be applied, again depending on the critical path. In general terms, up to n lost times are to be applied in the calculation of the total lost time per cycle, where n is the number of movements in the critical path through the signal cycle. For the purposes of determining n , a protected-plus-permitted movement is considered to be one movement if the protected and permitted phases are contiguous.

DETERMINING DELAY

The values derived from the delay calculations represent the average control delay experienced by all vehicles that arrive in the analysis period, including delays incurred beyond the analysis period when the lane group is oversaturated. Control delay includes movements at slower speeds and stops on intersection approaches as vehicles move up in queue position or slow down upstream of an intersection.

The average control delay per vehicle for a given lane group is given by Equation 16-9. Appendix A provides a procedure to measure control delay in the field.

$$d = d_1(PF) + d_2 + d_3 \quad (16-9)$$

where

- d = control delay per vehicle (s/veh);
- d_1 = uniform control delay assuming uniform arrivals (s/veh);
- PF = uniform delay progression adjustment factor, which accounts for effects of signal progression;
- d_2 = incremental delay to account for effect of random arrivals and oversaturation queues, adjusted for duration of analysis period and type of signal control; this delay component assumes that there is no initial queue for lane group at start of analysis period (s/veh); and
- d_3 = initial queue delay, which accounts for delay to all vehicles in analysis period due to initial queue at start of analysis period (s/veh) (detailed in Appendix F of this chapter).

Progression Adjustment Factor

Good signal progression will result in a high proportion of vehicles arriving on the green. Poor signal progression will result in a low proportion of vehicles arriving on the green. The progression adjustment factor, PF, applies to all coordinated lane groups, including both pretimed control and nonactuated lane groups in semiactuated control systems. In circumstances where coordinated control is explicitly provided for actuated lane groups, PF may also be applied to these lane groups. Progression primarily affects uniform delay, and for this reason, the adjustment is applied only to d_1 . The value of PF may be determined using Equation 16-10.

$$PF = \frac{(1 - P)f_{PA}}{1 - \left(\frac{g}{C}\right)} \quad (16-10)$$

where

- PF = progression adjustment factor,
- P = proportion of vehicles arriving on green,
- g/C = proportion of green time available, and
- f_{PA} = supplemental adjustment factor for platoon arriving during green.

The value of P may be measured in the field or estimated from the arrival type. If field measurements are carried out, P should be determined as the proportion of vehicles in the cycle that arrive at the stop line or join the queue (stationary or moving) while the green phase is displayed. The approximate ranges of R_p are related to arrival type as shown in Exhibit 16-11, and default values are suggested for use in subsequent computations in Exhibit 16-12.

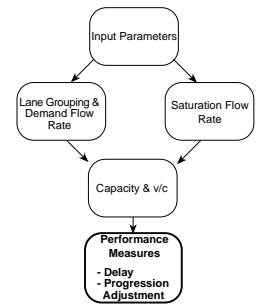

Progression primarily affects uniform delay

If PF for Arrival Type 4 calculates to greater than 1.0, set the value to 1.0

See Exhibit 16-4 for definition of arrival types

EXHIBIT 16-11. RELATIONSHIP BETWEEN ARRIVAL TYPE AND PLATOON RATIO (R_p)

Arrival Type	Range of Platoon Ratio (R_p)	Default Value (R_p)	Progression Quality
1	≤ 0.50	0.333	Very poor
2	$> 0.50-0.85$	0.667	Unfavorable
3	$> 0.85-1.15$	1.000	Random arrivals
4	$> 1.15-1.50$	1.333	Favorable
5	$> 1.50-2.00$	1.667	Highly favorable
6	> 2.00	2.000	Exceptional

EXHIBIT 16-12. PROGRESSION ADJUSTMENT FACTOR FOR UNIFORM DELAY CALCULATION

Green Ratio (g/C)	Arrival Type (AT)					
	AT 1	AT 2	AT 3	AT 4	AT 5	AT 6
0.20	1.167	1.007	1.000	1.000	0.833	0.750
0.30	1.286	1.063	1.000	0.986	0.714	0.571
0.40	1.445	1.136	1.000	0.895	0.555	0.333
0.50	1.667	1.240	1.000	0.767	0.333	0.000
0.60	2.001	1.395	1.000	0.576	0.000	0.000
0.70	2.556	1.653	1.000	0.256	0.000	0.000
f_{PA}	1.00	0.93	1.00	1.15	1.00	1.00
Default, R_p	0.333	0.667	1.000	1.333	1.667	2.000

Notes:
 $PF = (1 - P)f_{PA}/(1 - g/C)$.
 Tabulation is based on default values of f_{PA} and R_p .
 $P = R_p * g/C$ (may not exceed 1.0).
 PF may not exceed 1.0 for AT 3 through AT 6.

PF may be computed from measured values of P using the given values for f_{PA} . Alternatively, Exhibit 16-12 may be used to determine PF as a function of the arrival type based on the default values for P (i.e., $R_p g_i/C$) and f_{PA} associated with each arrival type. If PF is estimated by Equation 16-10, its calculated value may exceed 1.0 for Arrival Type 4 with extremely low values of g/C. As a practical matter, PF should be assigned a maximum value of 1.0 for Arrival Type 4.

When delay is estimated for future situations involving coordination, particularly in the analysis of alternatives, it is advisable to assume Arrival Type 4 as a base condition for coordinated lane groups (except left turns). Arrival Type 3 should be assumed for all uncoordinated lane groups.

Movements made from exclusive left-turn lanes on protected phases are not usually provided with good progression. Thus, Arrival Type 3 is usually assumed for coordinated left turns. When the actual arrival type is known, it should be used. When the coordinated left turn is part of a protected-permitted phasing, the effective green for the protected phase should only be used to determine PF since the protected phase is normally the phase associated with platooned coordination. When a lane group contains movements that have different levels of coordination, a flow-weighted average of P should be used in determining the PF.

Uniform Delay

Equation 16-11 gives an estimate of delay assuming uniform arrivals, stable flow, and no initial queue. It is based on the first term of Webster's delay formulation and is widely accepted as an accurate depiction of delay for the idealized case of uniform arrivals (7). Note that values of X beyond 1.0 are not used in the computation of d_1 .

Use Arrival Type 4 for coordinated lane groups

Use Arrival Type 3 for random arrivals

Appendix E contains discussions of how to compute uniform delay for protected-plus-permitted left-turn operation.

$$d_1 = \frac{0.5C \left(1 - \frac{g}{C}\right)^2}{1 - \left[\min(1, X) \frac{g}{C}\right]} \quad (16-11)$$

where

- d_1 = uniform control delay assuming uniform arrivals (s/veh);
- C = cycle length (s); cycle length used in pretimed signal control, or average cycle length for actuated control (see Appendix B for signal timing estimation of actuated control parameters);
- g = effective green time for lane group (s); green time used in pretimed signal control, or average lane group effective green time for actuated control (see Appendix B for signal timing estimation of actuated control parameters); and
- X = v/c ratio or degree of saturation for lane group.

Incremental Delay

Equation 16-12 is used to estimate the incremental delay due to nonuniform arrivals and temporary cycle failures (random delay) as well as delay caused by sustained periods of oversaturation (oversaturation delay). It is sensitive to the degree of saturation of the lane group (X), the duration of the analysis period (T), the capacity of the lane group (c), and the type of signal control, as reflected by the control parameter (k). The equation assumes that there is no unmet demand that causes initial queues at the start of the analysis period (T). Should that not be the case, the analyst should refer to Appendix F for additional procedures that can account for the effect on control delay of a nonzero initial queue. Finally, the incremental delay term is valid for all values of X , including highly oversaturated lane groups.

$$d_2 = 900T \left[(X - 1) + \sqrt{(X - 1)^2 + \frac{8kIX}{cT}} \right] \quad (16-12)$$

where

- d_2 = incremental delay to account for effect of random and oversaturation queues, adjusted for duration of analysis period and type of signal control (s/veh); this delay component assumes that there is no initial queue for lane group at start of analysis period;
- T = duration of analysis period (h);
- k = incremental delay factor that is dependent on controller settings;
- l = upstream filtering/metering adjustment factor;
- c = lane group capacity (veh/h); and
- X = lane group v/c ratio or degree of saturation.

Incremental Delay Calibration Factor

The calibration term (k) is included in Equation 16-12 to incorporate the effect of controller type on delay. For pretimed signals, a value of $k = 0.50$ is used, which is based on a queuing process with random arrivals and uniform service time equivalent to the lane group capacity. Actuated controllers, on the other hand, have the ability to tailor the green time to traffic demand, thus reducing incremental delay. The delay reduction depends in part on the controller's unit extension and the prevailing v/c ratio. Recent research indicates that lower unit extensions (i.e., snappy intersection operation) result in lower values of k and d_2 . However, when v/c approaches 1.0, an actuated controller will

Incremental delay reflects nonuniform arrivals and some queue carryover between cycles within the analysis period

tend to behave in a manner similar to a pretimed controller. Thus, the k parameter will converge to the pretimed value of 0.50 when demand equals capacity. The recommended k-values for pretimed and actuated lane groups are given in Exhibit 16-13.

EXHIBIT 16-13. k-VALUES TO ACCOUNT FOR CONTROLLER TYPE

Unit Extension (s)	Degree of Saturation (X)					
	≤ 0.50	0.60	0.70	0.80	0.90	≥ 1.0
≤ 2.0	0.04	0.13	0.22	0.32	0.41	0.50
2.5	0.08	0.16	0.25	0.33	0.42	0.50
3.0	0.11	0.19	0.27	0.34	0.42	0.50
3.5	0.13	0.20	0.28	0.35	0.43	0.50
4.0	0.15	0.22	0.29	0.36	0.43	0.50
4.5	0.19	0.25	0.31	0.38	0.44	0.50
5.0 ^a	0.23	0.28	0.34	0.39	0.45	0.50
Pretimed or nonactuated movement	0.50	0.50	0.50	0.50	0.50	0.50

Note:

For a given unit extension and its k_{min} value at $X = 0.5$: $k = (1 - 2k_{min})(X - 0.5) + k_{min}$, $k \geq k_{min}$, and $k \leq 0.5$.

a. For unit extension > 5.0, extrapolate to find k, keeping $k \leq 0.5$.

For unit extension values other than those listed in Exhibit 16-13, k-values may be interpolated. If the formula in Exhibit 16-13 is used, the k_{min} -value (the k-value for $X = 0.5$) should first be interpolated for the given unit extension and then the formula should be used. Exhibit 16-13 may be extrapolated for unit extension values beyond 5.0 s, but in no case should the extrapolated k-value exceed 0.5.

Upstream Filtering or Metering Adjustment Factor

The incremental delay adjustment factor (I) incorporates the effects of metering arrivals from upstream signals, as described in Chapter 15. For a signal analysis of an isolated intersection using the methodology of this chapter, a value of 1.0 for I is used.

Initial Queue Delay

When a residual queue from a previous time period causes an initial queue to occur at the start of the analysis period (T), additional delay is experienced by vehicles arriving in the period since the initial queue must first clear the intersection. A procedure for determining this initial queue delay is described in detail in Appendix F. This procedure is also extended to analyze delay over multiple time periods, each having a duration T, in which an unmet demand may be carried from one time period to the next. If this is not the case, a value of zero is used for d_3 .

Aggregated Delay Estimates

The procedure for delay estimation yields the control delay per vehicle for each lane group. It is often desirable to aggregate these values to provide delay for an intersection approach and for the intersection as a whole. This aggregation is done by computing weighted averages, where the lane group delays are weighted by the adjusted flows in the lane groups.

Thus, the delay for an approach is computed using Equation 16-13:

$$d_A = \frac{\sum d_i v_i}{\sum v_i} \tag{16-13}$$

where

- d_A = delay for Approach A (s/veh),
- d_i = delay for lane group i (on Approach A) (s/veh), and
- v_i = adjusted flow for lane group i (veh/h).

Procedure is described in Appendix F

Control delays on the approaches can be further aggregated using Equation 16-14 to provide the average control delay for the intersection:

$$d_I = \frac{\sum d_A v_A}{\sum v_A} \quad (16-14)$$

where

- d_I = delay per vehicle for intersection (s/veh),
- d_A = delay for Approach A (s/veh), and
- v_A = adjusted flow for Approach A (veh/h).

Special Procedure for Uniform Delay with Protected-Plus-Permitted Left-Turn Operation from Exclusive Lanes

The first term in the delay calculation is easily derived as a function of the area contained within the plot of queue storage as a function of time. With a single green phase per cycle, this plot assumes a triangular shape; that is, the queue size increases linearly on the red phase and decreases linearly on the green. The peak storage occurs at the end of the red phase. The geometry of the triangle depends on the arrival flow rate, the queue discharge rate, and the length of the red and green signal phases.

This simple triangle becomes a more complex polygon when left turns are allowed to proceed on both protected and permitted phases. However, the area of this polygon, which determines the uniform delay, is still relatively easy to compute when the left turns are in an exclusive lane and the proper values for the arrival and discharge rates during the various intervals of the cycle are given along with the interval lengths that determine its shape. The procedure for this analysis is covered in Appendix E.

DETERMINING LEVEL OF SERVICE

Intersection LOS is directly related to the average control delay per vehicle. Once delays have been estimated for each lane group and aggregated for each approach and the intersection as a whole, Exhibit 16-2 is consulted, and the appropriate LOS is determined.

The results of an operational application of this method will yield two key outputs: volume to capacity ratios for each lane group and for all of the critical lane groups within the intersection as a whole, and average control delays for each lane group and approach and for the intersection as a whole along with corresponding LOS.

Any v/c ratio greater than 1.0 is an indication of actual or potential breakdown. In such cases, multiperiod analyses are advised. These analyses encompass all periods in which queue carryover due to oversaturation occurs. When the overall intersection v/c ratio is less than 1.0 but some critical lane groups have v/c ratios greater than 1.0, the green time is generally not appropriately apportioned, and a retiming using the existing phasing should be attempted. Appendix B should be consulted for guidelines.

A critical v/c ratio greater than 1.0 indicates that the overall signal and geometric design provides inadequate capacity for the given flows. Improvements that might be considered include basic changes in intersection geometry (number and use of lanes), increases in the signal cycle length if it is determined to be too short, and changes in the signal phase plan. Chapter 10 and Appendix B contain information on these types of improvements. Existing state and local policies or standards should also be consulted in the development of potential improvements.

LOS is a measure of the delay incurred by motorists at a signalized intersection. In some cases, delay will be high even when v/c ratios are low. In these situations, poor progression or an inappropriately long cycle length, or both, is generally the cause. Thus, an intersection can have unacceptably high delays without there being a capacity problem. When the v/c approaches or exceeds 1.0, it is possible that delay will remain at acceptable levels. This situation can occur, especially if the time over which high v/c levels occur is short. It can also occur if the analysis is for only a single period and there

Queue accumulation polygon (QAP): uniform delay = area of triangles

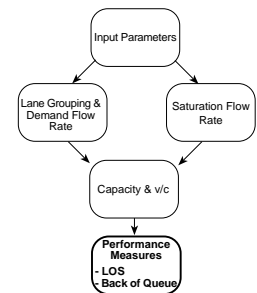
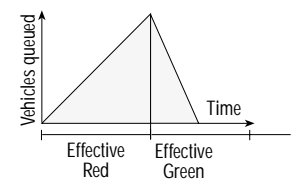

Unacceptable delay can occur even if v/c < 1.0, and acceptable delay can occur even if v/c ≥ 1.0

Procedure is described in Appendix G

is queue carryover. In the latter case, conduct of a multiperiod analysis is necessary to gain a true picture of delay. The analysis must consider the results of both the capacity analysis and the LOS analysis to obtain a complete picture of existing or projected intersection operations.

DETERMINING BACK OF QUEUE

When an estimate of queue length is needed, a procedure to calculate the average back of queue and 70th-, 85th-, 90th-, and 98th-percentile back of queue is presented in Appendix G. The back of queue is the number of vehicles that are queued depending on the arrival patterns of vehicles and on the number of vehicles that do not clear the intersection during a given green phase (overflow). This procedure is also able to analyze back of queue over multiple time periods, each having a duration (T) in which an overflow queue may be carried from one time period to the next.

SENSITIVITY OF RESULTS TO INPUT VARIABLES

The methodology is sensitive to the geometric, demand, and control characteristics of the intersection. The predicted delay is highly sensitive to signal control characteristics and the quality of progression. The predicted delay is sensitive to the estimated saturation flow only when demand approaches or exceeds 90 percent of the capacity for a lane group or an intersection approach.

Exhibits 16-14 through 16-17 illustrate the sensitivity of the predicted control delay per vehicle to demand to capacity ratio, g/C, cycle length, and length of the analysis period (T). Delay is relatively insensitive to demand levels until demand exceeds 90 percent of capacity; then it is highly sensitive not only to changes in demand but also to changes in g/C, cycle length, and length of the analysis period. Initial queue delay, d₃, although not shown in Exhibit 16-14, occurs when there is queue spillback.

EXHIBIT 16-14. SENSITIVITY OF DELAY TO DEMAND TO CAPACITY RATIO (SEE FOOTNOTE FOR ASSUMED VALUES)

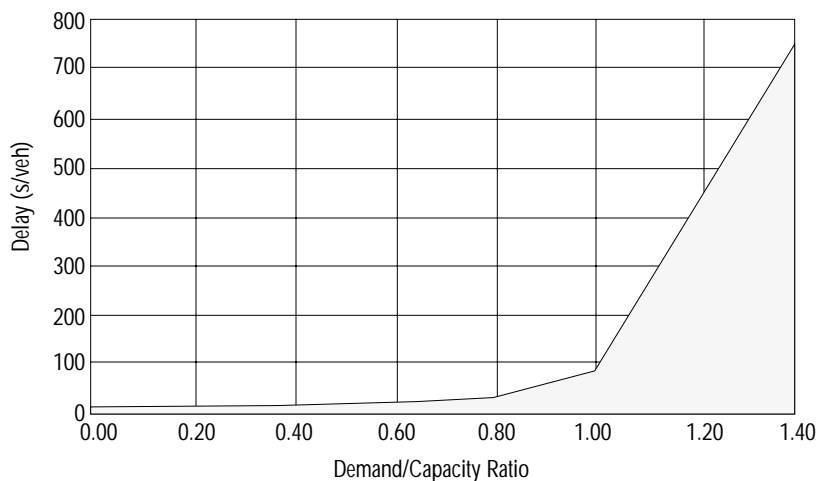

Note:
Assumptions: cycle length = 100 s, g/C = 0.5, T = 1 h, k = 0.5, l = 1, s = 1800 veh/h.

Sensitivity to demand/capacity

Delay becomes sensitive to signal control parameters (cycle length, g/C, and progression) only at demand levels above 80 percent of capacity. Once demand exceeds 80 percent of capacity, modest increases in demand can cause significant increases in delay. The demand to capacity ratio itself is sensitive to the demand level, the PHF, the saturation flow rate, and the g/C ratio.

Small g/C values that do not provide sufficient capacity to serve the demand cause excessive delays for the movement. Once there is sufficient g/C to serve the movement, little is gained by providing more g/C to the movement (see Exhibit 16-15).

If the cycle length does not allow enough g/C time (which affects capacity) to serve a movement, the delay increases rapidly. Long cycle lengths also increase delay, but not as rapidly as short cycle lengths that provide insufficient capacity to serve the movements at the intersection (see Exhibit 16-16).

EXHIBIT 16-15. SENSITIVITY OF DELAY TO g/C
(SEE FOOTNOTE FOR ASSUMED VALUES)

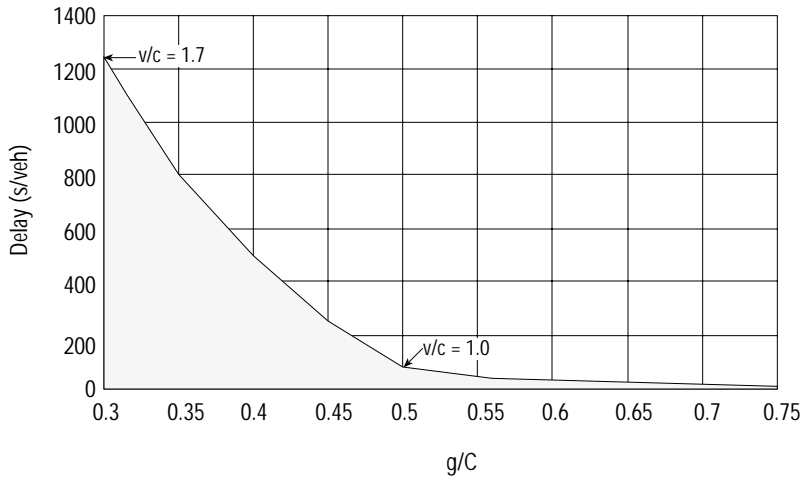

Sensitivity to g/C

Note:
Assumptions: cycle length = 100 s , $v/s = 0.5$, $T = 1$ h , $k = 0.5$, $I = 1$, $s = 1800$ veh/h.

EXHIBIT 16-16. SENSITIVITY OF DELAY TO CYCLE LENGTH

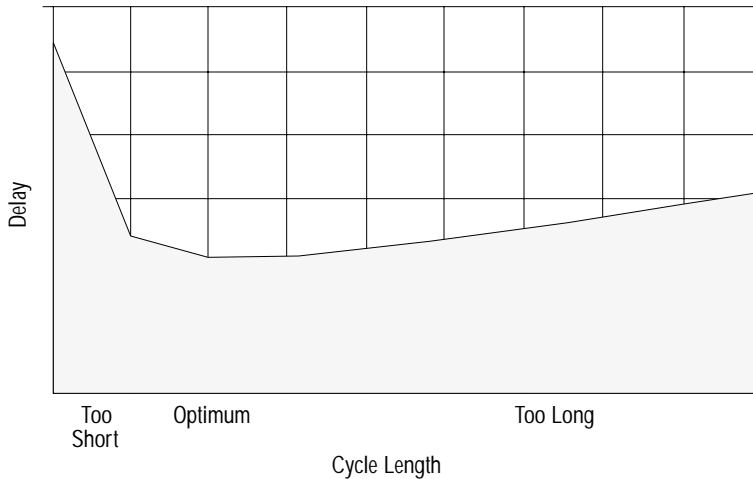

Sensitivity to C

The length of the analysis period (T) determines how long the demand is assumed to be at the specified flow rate. When demand is less than capacity, the length of the analysis period has little influence on the estimated mean delay. However, when demand exceeds capacity, the longer analysis period means that a longer queue is built up and that it takes longer to clear the bottleneck. The result is that mean delay in oversaturated conditions is highly sensitive to the selected length of the analysis period (see Exhibit 16-17).

Sensitivity to T

EXHIBIT 16-17. SENSITIVITY OF DELAY TO ANALYSIS PERIOD (T) (for $v/c \approx 1.0$)
(SEE FOOTNOTE FOR ASSUMED VALUES)

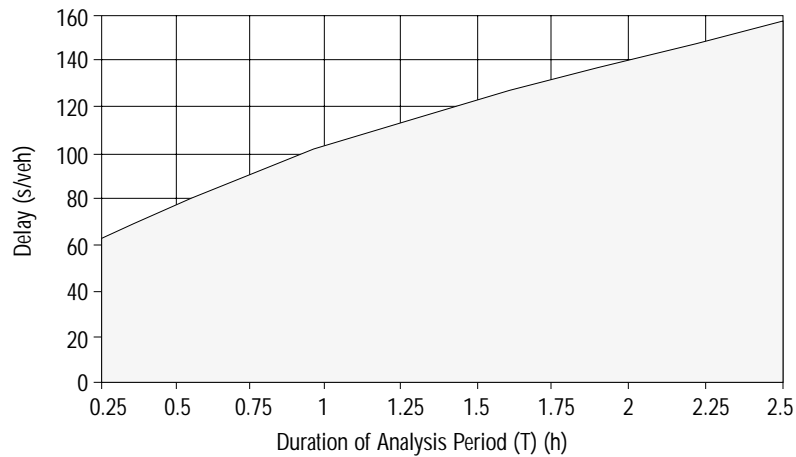

Note:
Assumptions: cycle length = 100 s , $g/C = 0.4$, $v/s = 0.44$, $k = 0.5$, $l = 1$, $s = 1800$ veh/h.

Guidelines on inputs and estimated values are in Chapter 10

III. APPLICATIONS

The methodology for analyzing signalized intersections considers the details of each of four components: flow rates at the intersection (vehicular, pedestrian, and bicycle), signalization of the intersection, geometric design or characteristics of the intersection, and the delay or LOS that results from these. The methodology is capable of treating any of these four components as an unknown to be determined once the details of the other three are known. Thus the method can be used for each of four operational and design analysis types, each having a target output, with the remaining parameters known or assumed for use as inputs:

- Operational (LOS): Determine LOS when details of intersection flows, signalization, and geometrics are known.
- Design (v_p): Determine allowable service flow rates for selected LOS when the details of signalization and geometrics are known.
- Design (Sig): Determine signal timing (for an assumed phase plan) when the desired LOS, details of flows, and geometrics are known.
- Design (Geom): Determine basic geometrics (number and allocation of lanes) when the desired LOS and details of flows and signalization are known.

Planning analysis is intended for use in sizing the overall geometrics of the intersection or in identifying the general sufficiency of the capacity of an intersection. It is based on the sum of critical lane volumes and requires minimum input information. In this chapter, a quick estimation method is denoted as Planning (X_{cm}) and is explained in Appendix A of Chapter 10.

Planning analysis is a link to operational and design analyses through the same basic computational methodology. However, the level of precision inherent in the operational analysis exceeds the accuracy of the data available in a planning context. The requirement for a complete description of the signal timing plan is also a burden, especially when the method is being applied in transportation planning situations. Therefore, the concept of planning analysis is to apply the required approximations to the input data and not to the computational procedures. For planning purposes, the only site-specific data that should be needed are the traffic volumes and number of lanes for each

movement together with a minimal description of the signal design and related operating parameters.

COMPUTATIONAL STEPS

Exhibit 16-18 gives the five types of analysis. Although the methodology is capable of computations for all five, the specific procedures and worksheets are designed for the first of these (i.e., a solution for LOS). In the development of alternative signal and geometric designs, it is often necessary to consider changes simultaneously in both. Rarely can signalization be considered in isolation from geometric design and vice versa. Thus, the most frequent type of analysis would consider such alternatives on a trial-and-error basis and would not attempt to hold one constant and solve for the other.

EXHIBIT 16-18. TYPES OF ANALYSIS COMMONLY PERFORMED

Type	Given	Objective	Comments/Assumptions Required
Operational (LOS)	Volume Signal timing Geometrics	LOS	None
Design (v_p)	Signal timing Geometrics Desired LOS	Maximum service flow rate	Requires iterative procedure, with complex interactions possible
Design (Sig)	Volume Geometrics Desired LOS	Signal timing	Initial estimate of signal timing needed to perform iterative solution
Design (Geom)	Volume Signal timing Desired LOS	Geometrics	Initial assumptions on geometrics needed to perform iterative solution
Planning (X_{cm})	Volume Signal timing	X_{cm}	Most inputs are estimates

Operational analysis is divided into five modules: input, volume adjustment, saturation flow rate, capacity analysis, and LOS. The computations for each of these modules are conducted or summarized on the appropriate worksheet.

In addition to the module-related worksheets, supplementary worksheets are provided to handle computations that are more complex. An overview of the information flow among all worksheets is presented in Exhibit 16-19, which also shows the proper treatment of all combinations of left-turn lanes and phasing. A given lane group may have

- Left turns from an exclusive lane,
- Left turns from a shared lane, or
- No left turns at all.

When left turns are present, the signal phasing may provide

- Permitted left-turn operation,
- Protected left-turn operation, or
- A combination of protected and permitted left turns.

There are six different possibilities, each of which must be handled in a slightly different manner using the worksheets.

Input Parameters

The input parameters are the geometric, volume, and signalization characteristics needed to perform computations. When an existing intersection is under study, most of these data will be obtained from field studies. When future conditions are under consideration, traffic data will be forecast and geometric and signal designs will be based on existing conditions or will be proposed. The Input Worksheet is shown in Exhibit 16-20.

Phasing	Left-Turn Adjustment Cases	
	Lane	
	LT Excl	LT Share
Protected	1	4
Permitted	2	5
Prot/Perm	3	6

One set of worksheets is used for each analysis period

EXHIBIT 16-19. FLOW OF WORKSHEETS AND APPENDICES TO PERFORM OPERATIONAL ANALYSIS

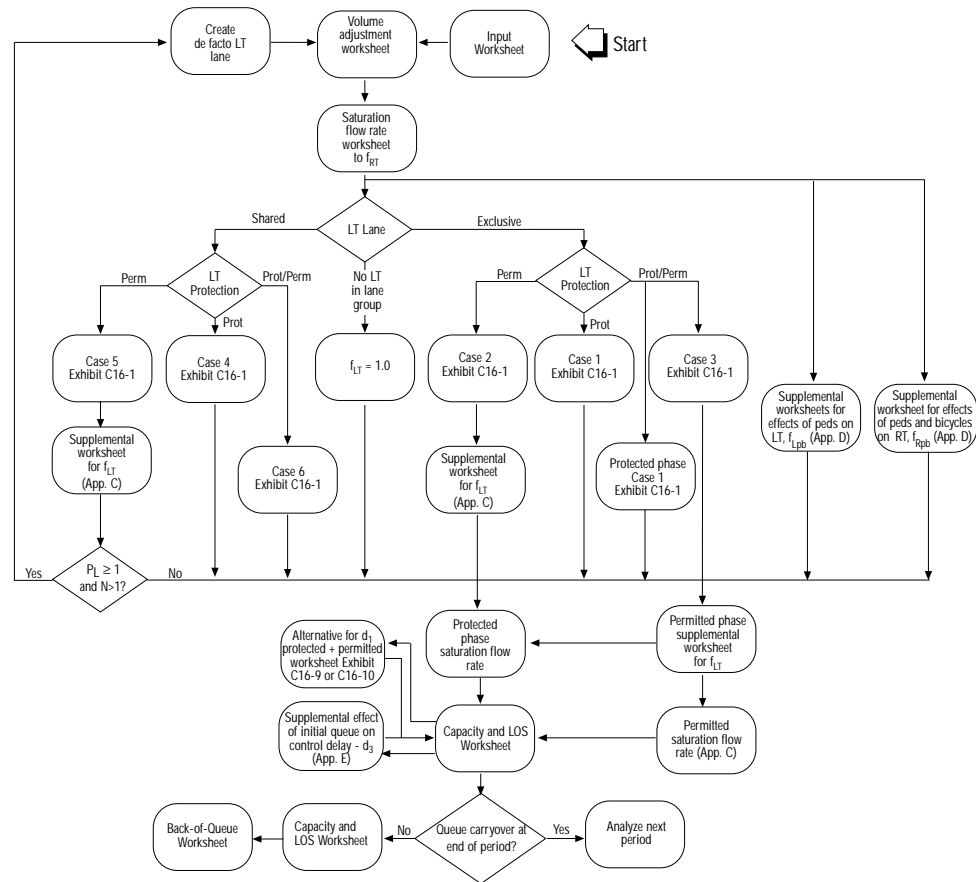

The upper third of the worksheet contains a schematic intersection drawing on which basic volume and geometric data are recorded. The details of lane geometrics should be shown within the intersection diagram. Details should include

- Number of lanes,
- Lane widths,
- Grade (plus sign is upgrade),
- Traffic movements using each lane (shown by arrows),
- Existence and location of curb parking lanes,
- Existence and location of bus stops,
- Existence and length of storage bays, and
- Other features such as channelization.

When geometric conditions are not known, a design should be proposed based on state or local practice. Chapter 10 may be consulted for assistance in establishing a design for analysis. When separate left-turn lanes exist, the procedures assume that the storage length is adequate. This assumption should be checked against the criteria in Chapter 10.

The middle portion of the worksheet consists of a tabulation of volume and timing data for each movement. Hourly volume or 15-min flow rate and volume-related parameters are entered into the tabulation in the middle of the worksheet. Separate entries are required for each approach and for each movement if appropriate. Note that RTOR volume should be removed from the total RT volume before the RT volume is entered on the worksheet.

EXHIBIT 16-20. INPUT WORKSHEET

INPUT WORKSHEET												
General Information						Site Information						
Analyst _____						Intersection _____						
Agency or Company _____						Area Type <input type="checkbox"/> CBD <input type="checkbox"/> Other						
Date Performed _____						Jurisdiction _____						
Analysis Time Period _____						Analysis Year _____						
Intersection Geometry												
<p>The diagram shows a four-way intersection with a grid pattern representing lane markings. Each approach has a 'grade=' label. A north arrow is shown in the center. The legend defines arrow types: Pedestrian Button (circle with dot), Lane Width (line with slash), Through (straight arrow), Right (curved arrow), Left (curved arrow), Through + Right (combined arrow), Left + Through (combined arrow), Left + Right (combined arrow), and Left + Through + Right (combined arrow).</p>												
Volume and Timing Input												
	EB			WB			NB			SB		
	LT	TH	RT ¹	LT	TH	RT ¹	LT	TH	RT ¹	LT	TH	RT ¹
Volume, V (veh/h)												
% heavy vehicles, % HV												
Peak-hour factor, PHF												
Pretimed (P) or actuated (A)												
Start-up lost time, I ₁ (s)												
Extension of effective green time, e (s)												
Arrival type, AT												
Approach pedestrian volume, ² v _{ped} (p/h)												
Approach bicycle volume, ² v _{bic} (bicycles/h)												
Parking (Y or N)												
Parking maneuvers, N _m (maneuvers/h)												
Bus stopping, N _B (buses/h)												
Min. timing for pedestrians, ³ G _p (s)												
Signal Phasing Plan												
D I A G R A M	Ø1	Ø2	Ø3	Ø4	Ø5	Ø6	Ø7	Ø8				
Timing	G = Y =	G = Y =	G = Y =	G = Y =	G = Y =	G = Y =	G = Y =	G = Y =				
	Protected turns		Permitted turns Pedestrian			Cycle length, C = _____ s						
Notes												
1. RT volumes, as shown, exclude RTOR. 2. Approach pedestrian and bicycle volumes are those that conflict with right turns from the subject approach. 3. Refer to Equation 16-2.												

For percent heavy vehicles and peak-hour factor, an average value for an entire approach can be used for all movements. For arrival type, either a value for P or the designation of type (1 to 6) is entered. Each approach movement is identified as pretimed (P) or actuated (A), and start-up lost time (I₁) and extension time (e) for each approach movement are entered. For pedestrians and bicycles, the volumes are those occurring in the crosswalk that conflicts with right turns from the subject approach.

Appendix B provides recommendations for establishing signal design

When data for some of these variables are not available or forecasts cannot be adequately established, default values may be used. Guidelines on the use of defaults are presented in Chapter 10 of this manual.

The sequence of signal phases is diagrammed in the eight boxes at the bottom of the input worksheet. Each box is used to show a single phase or subphase during which the allowable movements remain constant. For each phase, the actual green time (G) and the actual yellow-plus-all-red time (Y) are shown. For most cases, an assumed or existing signal design will be used. For some analyses, however, the signal timing and phasing will not be known. Setting timing and phasing for the purposes of analysis will influence the determination of lane groups. This portion of the signal design may be established on the basis of state or local practice. For additional suggestions on establishing the type of control and phase sequence, Appendix B should be consulted.

The timing of the signal will not be known when signal timing design is to be established. It may or may not be known when actuated signals are in place, depending on whether average phase durations were observed in the field. Estimates, however, cannot be computed until the first half of the capacity analysis module is complete. Other computations may proceed without this information. Appendix B contains recommendations for establishing phase times based on an assumed signal type and phase sequence and for estimating the average phase lengths of actuated signals when observations are not available.

The establishment of signal timing will usually involve iterative computations. It is preferable, therefore, to specify a complete signal timing for analysis using trial-and-error computations to determine an appropriate final timing. As an alternative, the timing plan may be synthesized using the planning application presented in Chapter 10 of this manual. If a fully implementable timing plan is required, a variety of signal timing optimization models are commercially available.

Volume Adjustment and Saturation Flow Rate

The second major analysis module focuses on adjustment of hourly movement volumes to flow rates for a peak 15-min period within the hour and on establishment of lane groups. A worksheet for designating lane groups, making volume adjustments, and computing saturation flow rate is shown in Exhibit 16-21. For this worksheet, the hourly volume (V) for each approach and movement is taken from the Input Worksheet and the flow rate, v_p , is computed. Lane groups are established and associated flow rates and turn proportions are noted. For saturation flow rate, adjustment factors are identified and an adjusted saturation flow is computed for each lane group.

Capacity Analysis

In the Capacity and LOS Worksheet (Exhibit 16-22), information and computational results from the input, volume adjustment, and saturation flow rate modules are combined to compute the capacity and v/c of each lane group and the delay and LOS for each lane group and approach and for the intersection as a whole.

The top portion of the worksheet is used to compute capacities. Phase numbers and types are entered in the first two rows. Phase type is included to accommodate left turns that have both protected and permitted phases. In this case, the protected phase will be the primary phase and the permitted phase will be the secondary phase. The primary and secondary phases must be represented by separate column entries on this worksheet, and certain quantities, such as lane group capacity, must be computed as the sum of the primary and secondary phase values in the lower portion of the worksheet. Primary phase entries should be designated P in this row. Secondary phase entries should be designated S.

The flow rate for each lane group is obtained from the Volume Adjustment and Saturation Flow Rate Worksheet and entered in this worksheet. In the case of lane groups with both protected and permitted phases, for computation of the critical v/c ratio, X_c , it

is necessary to apportion the total flow rate between the primary and secondary phases. It is appropriate to consider whichever phase is displayed first to be fully saturated by left-turn traffic and to apply any residual flow to the phase that is displayed second.

EXHIBIT 16-21. VOLUME ADJUSTMENT AND SATURATION FLOW RATE WORKSHEET

VOLUME ADJUSTMENT AND SATURATION FLOW RATE WORKSHEET												
General Information												
Project Description _____												
Volume Adjustment												
	EB			WB			NB			SB		
	LT	TH	RT	LT	TH	RT	LT	TH	RT	LT	TH	RT
Volume, V (veh/h)												
Peak-hour factor, PHF												
Adjusted flow rate, $v_p = V/PHF$ (veh/h)												
Lane group												
Adjusted flow rate in lane group, v (veh/h)												
Proportion ¹ of LT or RT (P_{LT} or P_{RT})		-			-			-			-	
Saturation Flow Rate (see Exhibit 16-7 to determine adjustment factors)												
Base saturation flow, s_0 (pc/h/ln)												
Number of lanes, N												
Lane width adjustment factor, f_w												
Heavy-vehicle adjustment factor, f_{HV}												
Grade adjustment factor, f_g												
Parking adjustment factor, f_p												
Bus blockage adjustment factor, f_{bb}												
Area type adjustment factor, f_a												
Lane utilization adjustment factor, f_{LU}												
Left-turn adjustment factor, f_{LT}												
Right-turn adjustment factor, f_{RT}												
Left-turn ped/bike adjustment factor, f_{Lpb}												
Right-turn ped/bike adjustment factor, f_{Rpb}												
Adjusted saturation flow, s (veh/h)												
$s = s_0 N f_w f_{HV} f_g f_{bb} f_a f_{LU} f_{LT} f_{RT} f_{Lpb} f_{Rpb}$												
Notes												
1. $P_{LT} = 1.000$ for exclusive left-turn lanes, and $P_{RT} = 1.000$ for exclusive right-turn lanes. Otherwise, they are equal to the proportions of turning volumes in the lane group.												

EXHIBIT 16-22. CAPACITY AND LOS WORKSHEET

CAPACITY AND LOS WORKSHEET												
General information												
Project Description _____												
Capacity Analysis												
Phase number												
Phase type												
Lane group												
Adjusted flow rate, v (veh/h)												
Saturation flow rate, s (veh/h)												
Lost time, t_L (s), $t_L = I_1 + Y - e$												
Effective green time, g (s), $g = G + Y - t_L$												
Green ratio, g/C												
Lane group capacity, ¹ $c = s(g/C)$, (veh/h)												
v/c ratio, X												
Flow ratio, v/s												
Critical lane group/phase (\sqrt{v})												
Sum of flow ratios for critical lane groups, Y_c $Y_c = \sum (\text{critical lane groups, } v/s)$												
Total lost time per cycle, L (s)												
Critical flow rate to capacity ratio, X_c $X_c = (Y_c)(C)/(C - L)$												
Lane Group Capacity, Control Delay, and LOS Determination												
		EB			WB			NB			SB	
Lane group												
Adjusted flow rate, ² v (veh/h)												
Lane group capacity, ² c (veh/h)												
v/c ratio, ² X = v/c												
Total green ratio, ² g/C												
Uniform delay, $d_1 = \frac{0.50 C [1 - (g/C)]^2}{1 - [\min(1, X)g/C]}$ (s/veh)												
Incremental delay calibration, ³ k												
Incremental delay, ⁴ d_2 $d_2 = 900T [(X - 1) + \sqrt{(X - 1)^2 + \frac{8kIX}{CT}}]$ (s/veh)												
Initial queue delay, d_3 (s/veh) (Appendix F)												
Uniform delay, d_1 (s/veh) (Appendix F)												
Progression adjustment factor, PF												
Delay, $d = d_1(PF) + d_2 + d_3$ (s/veh)												
LOS by lane group (Exhibit 16-2)												
Delay by approach, $d_A = \frac{\sum(d)(v)}{\sum v}$ (s/veh)												
LOS by approach (Exhibit 16-2)												
Approach flow rate, v_A (veh/h)												
Intersection delay, $d_I = \frac{\sum(d_A)(v_A)}{\sum v_A}$ (s/veh)												
												Intersection LOS (Exhibit 16-2)
Notes												
1. For permitted left turns, the minimum capacity is $(1 + P_L)(3600/C)$. 2. Primary and secondary phase parameters are summed to obtain lane group parameters. 3. For pretimed or nonactuated signals, $k = 0.5$. Otherwise, refer to Exhibit 16-13. 4. T = analysis duration (h); typically $T = 0.25$, which is for the analysis duration of 15 min. I = upstream filtering metering adjustment factor; $I = 1$ for isolated intersections.												

The adjusted saturation flow rate for each lane group is obtained directly from the Volume Adjustment and Saturation Flow Rate Worksheet. The flow ratio for each lane group is computed as v/s and entered in columns representing primary and secondary phases.

The next step is to calculate movement lost time for all primary and secondary phases using the start-up lost time (I_1), extension time (e), and yellow-plus-all-red time

Effective green time defined

(Y). Effective green times are calculated using actual green time (G) and movement lost time (t_L). Then the g/C ratio for each lane group, the effective green time divided by the cycle length, is computed and used to compute lane group capacity. Effective green times can be taken as equal to the actual green time plus the change-and-clearance interval minus the lost time for the movement.

The capacity of each lane group is computed from Equation 16-6 as the saturation flow rate times the green ratio. A minimum capacity value based on sneakers per cycle must be imposed as a practical matter for all permitted left-turning movements. This value may be computed as indicated on the worksheet.

The v/c ratio (X) for each lane group is computed. At this point in the computations, critical lane groups and lost time per cycle may be identified according to the guidelines discussed. A critical lane group is defined as the lane group with the highest flow ratio in each phase or set of phases. When overlapping phases exist, all possible combinations of critical lane groups must be examined for the combination producing the highest sum of flow ratios. Critical lane groups are identified by a check mark. The flow ratios for critical lane groups are summed. The critical v/c ratio, X_c , which indicates the degree of saturation associated with the geometrics, volumes, and signal phasing, is then computed.

Delay and Level of Service

The LOS module combines the results of the volume adjustment, saturation flow rate, and capacity analysis modules to find the average control delay per vehicle in each lane group. LOS is directly related to delay and is found from Exhibit 16-2. The worksheet for this module is also shown in Exhibit 16-22. Lane group capacities and flow rates are the sum of primary and secondary phases from the capacity analysis section.

Delay is found from Equations 16-9 through 16-14. The worksheet is designed for computation of the uniform and incremental delay terms separately. The uniform delay is multiplied by the progression adjustment factor (PF) to account for the impact of progression. The value of PF is obtained from Exhibit 16-12. If a measured or estimated value of P was used in lieu of the arrival type in the computation of PF, the arrival type may be determined from Exhibit 16-11. In this case, the platoon ratio, R_p , must first be estimated by $R_p = PC/g$.

When no residual queue exists from a previous time period, the initial queue delay term, d_3 , is equal to zero. When an initial queue of vehicles exists at the start of the analysis period (observed at the beginning of the red phase), the procedures in Appendix F are used to modify the calculation of d_1 , to calculate d_3 , and to determine delay and LOS.

For exclusive left-turn lane groups with both protected and permitted phases, the supplemental worksheet presented in Exhibit 16-23 is used for calculation of uniform delay. Discussions of this procedure are also included in Appendix E.

The second term of the delay equation accounts for the incremental delay, that is, the delay over and above uniform delay due to random arrivals rather than uniform arrivals and those due to cycles that fail. It is based on the v/c ratio (X) and the capacity for the lane group (c). The capacity for each lane group is taken from the top part of the Capacity and LOS Worksheet.

The incremental delay calibration factor (k) is obtained from Exhibit 16-13. This value is a function of the controller type and degree of saturation. For isolated intersections, the upstream filtering or metering adjustment factor (I) is set equal to 1.0. Refer to Chapter 15 for further information on this factor. The second-term delay is computed using Equation 16-12.

Minimum capacity for permitted left turns

For an analysis of an initial queue, see Appendix F

See Appendix E for analysis of protected-plus-permitted phasing

EXHIBIT 16-23. SUPPLEMENTAL UNIFORM DELAY WORKSHEET FOR LEFT TURNS FROM EXCLUSIVE LANES WITH PROTECTED AND PERMITTED PHASES

SUPPLEMENTAL UNIFORM DELAY WORKSHEET FOR LEFT TURNS FROM EXCLUSIVE LANES WITH PROTECTED AND PERMITTED PHASES					
General Information					
Project Description _____					
v/c Ratio Computation					
	EB	WB	NB	SB	
Cycle length, C (s)					
Protected phase eff. green interval, g (s)					
Opposing queue effective green interval, g _q (s)					
Unopposed green interval, g _u (s)					
Red time, r (s)					
$r = C - g - g_q - g_u$					
Arrival rate, q _a (veh/s)					
$q_a = \frac{v}{3600 \cdot \max[X, 1.0]}$					
Protected phase departure rate, s _p (veh/s)					
$s_p = \frac{s}{3600}$					
Permitted phase departure rate, s _s (veh/s)					
$s_s = \frac{s(g_q + g_u)}{(g_u \cdot 3600)}$					
If leading left (protected + permitted) v/c ratio, X _{perm} = $\frac{q_a(g_q + g_u)}{s_s g_u}$					
If lagging left (permitted + protected) v/c ratio, X _{perm} = $\frac{q_a(r + g_q + g_u)}{s_s g_u}$					
If leading left (protected + permitted) v/c ratio, X _{prot} = $\frac{q_a(r + g)}{s_p g}$					
If lagging left (permitted + protected) v/c ratio, X _{prot} is N/A					
Uniform Queue Size and Delay Computations					
Queue at beginning of green arrow, Q _a					
Queue at beginning of unsaturated green, Q _u					
Residual queue, Q _r					
Uniform delay, d ₁					
Uniform Queue Size and Delay Equations					
	Case	Q _a	Q _u	Q _r	d ₁
If X _{perm} ≤ 1.0 & X _{prot} ≤ 1.0	1	q _a r	q _a g _q	0	$[0.50/(q_a C)] [rQ_a + Q_a^2/(s_p - q_a) + g_q Q_u + Q_u^2/(s_s - q_a)]$
If X _{perm} ≤ 1.0 & X _{prot} > 1.0	2	q _a r	Q _r + q _a g _q	Q _a - g(s _p - q _a)	$[0.50/(q_a C)] [rQ_a + g(Q_a + Q_r) + g_q(Q_r + Q_u) + Q_u^2/(s_s - q_a)]$
If X _{perm} > 1.0 & X _{prot} ≤ 1.0	3	Q _r + q _a r	q _a g _q	Q _u - g _u (s _s - q _a)	$[0.50/(q_a C)] [g_q Q_u + q_a(Q_u + Q_r) + r(Q_r + Q_a) + Q_a^2/(s_p - q_a)]$
If X _{perm} ≤ 1.0 (lagging lefts)	4	0	q _a (r + g _q)	0	$[0.50/(q_a C)] [(r + g_q)Q_u + Q_u^2/(s_s - q_a)]$
If X _{perm} > 1.0 (lagging lefts)	5	Q _u - g _u (s _s - q _a)	q _a (r + g _q)	0	$[0.50/(q_a C)] [(r + g_q)Q_u + q_a(Q_u + Q_a) + Q_a^2/(s_p - q_a)]$

Delay and LOS are found by multiplying the uniform delay by the progression factor and adding the result to the incremental delay and initial queue delay, in accordance with Equation 16-9. The LOS corresponding to this delay, taken from Exhibit 16-2, is entered on the Capacity and LOS Worksheet.

In the event that the analysis period is oversaturated or when there is a final residual queue at the end of the analysis period, additional analysis periods should be studied until the residual queue no longer occurs.

The average delay per vehicle is found for each approach by adding the product of the lane group flow rate and the delay for each lane group on the approach and dividing by the total approach flow rate. LOS is determined from Exhibit 16-2.

The average control delay per vehicle for the intersection as a whole is found by adding the product of the approach flow rate and the approach delay for all approaches and dividing the sum by the total intersection flow rate. This weighted-average delay is entered at the bottom of the Capacity and LOS Worksheet. The overall intersection LOS is found from Exhibit 16-2.

INTERPRETATION OF RESULTS

The computations discussed in the previous section result in an estimation of the average delay per vehicle in each lane group for each approach and for the intersection as a whole. LOS is directly related to delay values and is assigned on that basis. LOS is a measure of the acceptability of delay levels to motorists at a given intersection. When delays are unacceptable, the causes of delay should be carefully examined. Although the discussion below is clearly not exhaustive, some of the more common situations are as follows.

1. LOS is an indication of the general acceptability of delay to drivers. It should be noted that this is somewhat subjective: what might be acceptable in a large city is not necessarily acceptable in a smaller city or rural area.
2. When delay levels are acceptable for the intersection as a whole but are unacceptable for certain lane groups, the phase plan, allocation of green time, or both might be examined to provide for more efficient handling of the disadvantaged movement or movements.
3. When delay levels are unacceptable but v/c ratios are relatively low, the cycle length may be too long for prevailing conditions, the phase plan may be inefficient, or both. It should be noted, however, that when signals are part of a coordinated system, the cycle length at individual intersections is determined by system considerations, and alterations at isolated locations may not be practical.
4. When both delay levels and v/c ratios are unacceptable, the situation is critical. Delay is already high, and demand is near or over capacity. In such situations, the delay may increase rapidly with small changes in demand. The full range of potential geometric and signal design improvements should be considered in the search for improvements.

The following point must be emphasized: unacceptable delay can exist where capacity is a problem as well as in cases in which it is adequate. Further, acceptable delay levels do not automatically ensure that capacity is sufficient. Delay and LOS, like capacity, are complex variables influenced by a wide range of traffic, roadway, and signalization conditions. The operational analysis techniques presented here are useful in estimating the performance characteristics of the intersection and in providing basic insights into probable causal factors.

The determination of LOS is based on average control delay. It is possible, however, for average delay to decrease with increasing volumes if the volume increases occur in movements with less than the average delay. Even with increases in more than one movement on an approach, the net effect can still be a decrease in average delay if the movements with less than average delay increase sufficiently.

One way to avoid this anomaly is to consider the change in mean delay on a lane-group-by-lane-group basis rather than by averaging delay over the entire intersection. Adding traffic to a particular lane group will always increase the delay for that lane group (as long as all other factors remain unchanged).

These procedures do not, however, account for all possible conditions. The influences of such characteristics as specific curb-corner radii, intersection angle, combinations of grades on various approaches, odd geometric features (offset intersections, narrowing on the departure lanes, etc.), and other unusual site-specific

The analysis requires use of demand volumes, not departure volumes, to make a proper estimate

conditions are not addressed in the methodology. Field studies may be conducted in such cases to determine delay directly (see Appendix A) and or to calibrate the prevailing saturation flow rate (see Appendix H).

At the completion of a capacity calculation, the characteristics of the intersection have been defined. These characteristics must be evaluated in their own right as well as in conjunction with the delays and LOS resulting from the delay and LOS calculation. Some key factors to consider when the results of capacity computations are assessed are identified in the following text. A critical v/c ratio of greater than 1.0 indicates that the signal and geometric design cannot accommodate the combination of critical flows at the intersection. The given demand in these movements exceeds the capacity of the intersection to handle them. The condition may be ameliorated by increased cycle length, changes in the phasing plan, and basic changes in geometrics.

Computations should be conducted using arrival volumes. When the v/c ratios are less than 1.0, arrival and departure volumes are the same. When v/c ratios are greater than 1.0, either for an individual lane group or for the overall intersection, departure volumes are less than arrival volumes. By definition, future volume forecasts are also arrival volumes. When counts of actual departure volumes are used in analysis, the actual v/c ratio cannot be greater than 1.0. If v/c ratios greater than 1.0 persist for actual departure volumes, it is an indication that the intersection operates more efficiently than anticipated by these computational techniques or that the saturation flow rates used in the calculations are lower than those actually experienced in the field.

When the critical v/c ratio is acceptable but the v/c ratios for critical lane groups vary widely, the green-time allocation should be reexamined, because disproportionate distribution of available green is indicated. If permitted left turns result in extreme reductions in saturation flow rate for applicable lane groups, protected phasing might be considered. If the critical v/c ratio exceeds 1.0, it is unlikely that the existing geometric and signal design can accommodate the demand. Changes in either or both should be considered. When v/c ratios are unacceptable and signal phasing already includes protective phasing for significant turning movements, it is probable that geometric changes will be required to ameliorate the condition.

The capacity of an intersection is a complex variable depending on a large number of prevailing traffic, roadway, and signalization conditions. Suggestions on interpretation are not meant to be exhaustive or complete but merely to point out some of the more common problems that can be identified from the Capacity and LOS Worksheet results.

ANALYSIS TOOLS

The worksheets shown in Exhibits 16-20, 16-21, and 16-22 and provided in Appendix I can be used to perform Operational (LOS), Design (v_p), Design (Sig), and Design (Geom) analysis types. The worksheets shown in Chapter 10, Appendix B, can be used to perform Planning (X_{cm}) applications.

IV. EXAMPLE PROBLEMS

Problem No	Description	Application
1	Find LOS of signalized intersection	Operational (LOS)
2	Find LOS of signalized intersection	Operational (LOS)
3	Find LOS of signalized intersection	Operational (LOS)
4	Find LOS of proposed improvements on existing intersection	Planning (X_{cm})
5	Find capacity of intersection with projected volumes	Planning (X_{cm})
6	Find maximum service volume of approach for desired LOS	Design (v_p)

EXAMPLE PROBLEM 1

The Intersection The intersection of Third Avenue (NB/SB) and Main Street (EB/WB) is located in the central business district (CBD) of a small urban area. Intersection geometry and flow characteristics are shown on the Input Worksheet.

The Question What are the delay and peak-hour LOS of this intersection?

The Facts

- √ EB and WB HV = 5 percent,
- √ NB and SB HV = 8 percent,
- √ PHF = 0.90,
- √ Two-phase signal,
- √ NB-SB green = 36 s,
- √ EB-WB green = 26 s,
- √ Yellow = 4 s,
- √ Third Avenue has two lanes, one in each direction,
- √ Main Street has four lanes, two in each direction,
- √ No parking at intersection,
- √ Pedestrian volume = 100 p/h, all approaches,
- √ Bicycle volume = 20 bicycles/h, all approaches,
- √ Movement lost time = 4 s, and
- √ Level terrain.

Comments

- √ Assume crosswalk width = 3.0 m for all approaches,
- √ Assume base saturation flow rate = 1,900 pc/h/ln,
- √ Assume $E_T = 2.0$,
- √ No buses, and
- √ 70.0-s cycle length, with green times given.

Steps

1. Pedestrians/cycle.	$100 \frac{p}{h} * \frac{1h}{3,600 s} * 70 s = 1.944 p$
2. Minimum effective green time required for pedestrians (use Equation 16-2).	$G_p = 3.2 + \frac{L}{1.2} + 0.27N_{ped}$ $G_p (Main) = 3.2 + \frac{9.0}{1.2} + 0.27(1.944) = 11.2 s$ $G_p (Third) = 3.2 + \frac{13.2}{1.2} + 0.27(1.944) = 14.7 s$
3. Compare minimum effective green time required for pedestrians with actual effective green.	$G_p (Main) = 26 s$, which is $>11.2 s$ $G_p (Third) = 36 s$, which is $>14.7 s$
4. Proportions of left and right turns.	Proportions of left- and right-turn traffic are found by dividing the appropriate turning volumes by the total lane group volume. $P_{LT}(EB) = \frac{65}{65 + 620 + 35} = 0.090$
5. Lane width adjustment factor (use Exhibit 16-7).	$f_w = 1 + \frac{(W - 3.6)}{9}$ $f_w(EB) = 1 + \frac{(3.3 - 3.6)}{9} = 0.967$
6. Heavy-vehicle adjustment factor (use Exhibit 16-7).	$f_{HV} = \frac{100}{100 + \% HV(E_T - 1)}$ $f_{HV}(EB) = \frac{100}{100 + 5(2.0 - 1)} = 0.952$
7. Percent grade adjustment factor (use Exhibit 16-7).	0% grade, $f_g = 1.000$

8. Parking adjustment factor (use Exhibit 16-7).	No parking maneuvers, $f_p = 1.000$
9. Bus blockage adjustment factor (use Exhibit 16-7).	No buses stopping, $f_{bb} = 1.000$
10. Area type adjustment factor (use Exhibit 16-7).	For CBD, $f_a = 0.900$
11. Lane utilization adjustment factor (use Exhibit 16-7).	Refer to Exhibit 10-23. This factor is applied to establish the conditions in the worst lane within each lane group. Otherwise, the results would reflect the average of all lanes of the defined lane groups. Use $f_{LU} = 0.950$ for EB and WB approaches, and $f_{LU} = 1.000$ for NB and SB approaches.
12. Left-turn adjustment factor.	The left turn is permitted, hence a special procedure is needed. The EB and WB left turns are opposed by multilane approaches. The supplemental worksheet for multilane approaches is used. The NB and SB left turns are opposed by single-lane approaches. The supplemental worksheet for a single-lane approach is used.
13. Right-turn adjustment factor (use Exhibit 16-7).	For NB and SB single-lane approaches: $f_{RT} = 1.0 - 0.135P_{RT}$ For EB and WB shared-lane approaches: $f_{RT} = 1.0 - 0.150P_{RT}$
14. Left-turn pedestrian/bicycle adjustment factor.	Supplemental worksheet for pedestrian-bicycle effects is used.
15. Right-turn pedestrian/bicycle adjustment factor.	Supplemental worksheet for pedestrian-bicycle effects is used.
16. Saturation flow.	$s = s_o N f_w f_{HV} f_g f_p f_{bb} f_{LU} f_a f_{LT} f_{RT} f_{Lpb} f_{Rpb}$ $s(EB) = 1900 * 2 * 0.967 * 0.952 * 1.000 * 1.000 * 1.000 * 0.900 * 0.950 * 0.716 * 0.993 * 0.997 * 0.992 = 2103 \text{ veh/h}$
17. Lane group capacity.	$c = s(g/C)$ $c(EB) = 2103(0.371) = 780 \text{ veh/h}$
18. v/c ratio.	$v/c(EB) = \frac{800}{780} = 1.026$
19. Determine critical lane group in each timing phase.	The lane group with the highest v/c ratio in a phase is considered the critical lane group. In this case, EB and SB lane groups are critical in Phases 1 and 2, respectively.
20. Flow ratio of critical lane groups.	$v/s(EB) = \frac{800}{2103} = 0.380$ $v/s(SB) = \frac{667}{1625} = 0.410$
21. Sum of critical flow ratios.	$Y_c = 0.380 + 0.410 = 0.790$
22. Critical flow rate to capacity ratio.	$X_c = \frac{Y_c * C}{C - L}$ $X_c = \frac{0.790(70.0)}{70.0 - 8} = 0.892$

23. Uniform delay.	$d_1 = \frac{0.50C \left(1 - \frac{g}{C}\right)^2}{1 - \left[\min(1, X) \frac{g}{C}\right]}$ $d_1(\text{EB}) = \frac{0.50(70.0)(1 - 0.371)^2}{1 - 0.371(1.0)} = 22.015 \text{ s/veh}$
24. Incremental delay.	$d_2 = 900T \left[(X - 1) + \sqrt{\dots} \right]$ $d_2(\text{EB}) = 900(0.25) \left[(1.026 - 1) + \sqrt{\dots} \right] = 39.011 \text{ s/veh}$
25. Progression adjustment factor (use Exhibit 16-12).	PF (EB) = 0.926
26. Lane group delay.	$d = d_1 \text{PF} + d_2 + d_3$ $d(\text{EB}) = 22.015(0.926) + 39.011 + 0 = 59.4 \text{ s/veh}$
27. Intersection delay.	$d_i = \frac{\sum (d_A)(v_A)}{\sum v_A}$ $d_i = \frac{(59.4 * 800) + (31.0 * 833) + (14.4 * 466) + (21.9 * 667)}{(800 + 833 + 466 + 667)}$ $= 34.2 \text{ s/veh}$
28. LOS by lane group, approach, and intersection.	LOS (EB lane group) = E LOS (EB approach) = E LOS Intersection = C

The calculation results are summarized as follows,

Direction/ LnGrp	v/c Ratio	g/C Ratio	Unif Delay d_1	Progr Fact PF	Lane Grp Cap	Cal Term k	Incr Delay d_2	Lane Grp Delay	Lane Grp LOS	Delay by App	LOS by App
EB/LTR	1.026	0.371	22.015	0.926	780	0.5	39.011	59.4	E	59.4	E
WB/LTR	0.842	0.371	20.138	1.111	989	0.5	8.647	31.0	C	31.0	C
NB/LTR	0.561	0.514	11.617	1.000	830	0.5	2.734	14.4	B	14.4	B
SB/LTR	0.799	0.514	14.028	1.000	835	0.5	7.882	21.9	C	21.9	C
Intersection Delay = 34.2 s/veh						Intersection LOS = C					

Alternatives

Two alternatives are considered: a new lane utilization adjustment factor and new signal timing.

The purpose of the lane utilization adjustment factor (f_{LU}) is to account for uneven distribution of traffic in multilane roadways, and it is reflected in saturation flow rates.

Typically, traffic volume is evenly distributed between lanes at high v/c ratios, and the lane utilization adjustment factor is close to 1.000. In this analysis, f_{LU} is only applicable to Main Street because it has multiple lanes. v/c ratios of 1.026 and 0.842 are considered high, and it is assumed that traffic volume is evenly distributed, with $f_{LU} = 1.000$.

The performance is reassessed using $f_{LU} = 1.000$ and the results are summarized as follows.

Direction/ Ln Grp	v/c Ratio	g/C Ratio	Unif Delay d_1	Progr Factor PF	Ln Grp Capacity	Cal Term k	Incr Delay d_2	Ln Grp Delay	Ln Grp LOS	Delay by App	LOS by App
EB/LTR	0.945	0.371	21.323	0.926	847	0.5	20.134	39.9	D	39.9	D
WB/LTR	0.798	0.371	19.671	1.111	1044	0.5	6.365	28.2	C	28.2	C
NB/LTR	0.561	0.514	11.617	1.000	830	0.5	2.734	14.4	B	14.4	B
SB/LTR	0.799	0.514	14.028	1.000	835	0.5	7.882	21.9	C	21.9	C
Intersection Delay = 27.7 s/veh						Intersection LOS = C					

The assumption of $f_{LU} = 1.000$ has reduced the delay from 34.2 s/veh to 27.7 s/veh.

The other alternative is to optimize the operation by reallocating green times without changing f_{LU} .

As shown in the calculation results, currently the v/c ratios between critical lane groups are not balanced. The v/c ratio of the EB lane group is much higher than that of the SB lane group. This imbalance results in much higher delay experienced by one critical lane group than by the other.

A new signal timing is introduced by reallocating 1.0 s to the east-west phase from the north-south phase. The resulting signal timing is 27.0 s for the east-west phase and 35.0 s for the north-south phase.

The intersection operation is reassessed with the new timing, and the results are summarized as follows.

Direction/ Ln Grp	v/c Ratio	g/C Ratio	Unif Delay d_1	Progr Factor PF	Ln Grp Cap	Cal Term k	Incr Delay d_2	Ln Grp Delay	Ln Grp LOS	Delay by App	LOS by App
EB/LTR	0.972	0.386	21.118	0.926	823	0.5	25.265	44.8	D	47.9	47.9
WB/LTR	0.807	0.386	19.165	1.111	1032	0.5	6.766	28.1	C	28.1	28.1
NB/LTR	0.578	0.500	12.307	1.000	806	0.5	3.011	15.3	B	17.3	17.3
SB/LTR	0.821	0.500	14.843	1.000	812	0.5	9.132	24.0	C	34.0	34.0
Intersection Delay = 29.8 s/veh						Intersection LOS = C					

After reallocation of green times, v/c ratios for critical lane groups are more balanced, and the overall intersection performance (in terms of delay) has improved from 34.2 s/veh to 29.8 s/veh.

Example Problem 1

INPUT WORKSHEET												
General Information						Site Information						
Analyst			WLL			Intersection			Third Avenue/Main Street			
Agency or Company			CEI			Area Type			<input checked="" type="checkbox"/> CBD <input type="checkbox"/> Other			
Date Performed			4/12/99			Jurisdiction						
Analysis Time Period			4-6 PM			Analysis Year			1999			
Intersection Geometry												
Volume and Timing Input												
	EB			WB			NB			SB		
	LT	TH	RT ¹	LT	TH	RT ¹	LT	TH	RT ¹	LT	TH	RT ¹
Volume, V (veh/h)	65	620	35	30	700	20	30	370	20	40	510	50
% heavy vehicles, % HV	5	5	5	5	5	5	8	8	8	8	8	8
Peak-hour factor, PHF	0.90			0.90			0.90			0.90		
Pretimed (P) or actuated (A)	P			P			P			P		
Start-up lost time, I ₁ (s)												
Extension of effective green time, e (s)												
Arrival type, AT	4			2			3			3		
Approach pedestrian volume, ² v _{ped} (p/h)	100			100			100			100		
Approach bicycle volume, ² v _{bic} (bicycles/h)	20			20			20			20		
Parking (Y or N)	N			N			N			N		
Parking maneuvers, N _m (maneuvers/h)	0			0			0			0		
Bus stopping, N _B (buses/h)	0			0			0			0		
Min. timing for pedestrians, ³ G _p (s)	11.2			11.2			14.7			14.7		
Signal Phasing Plan												
D I A G R A M	Ø1	Ø2		Ø3	Ø4	Ø5	Ø6	Ø7	Ø8			
Timing	G = 26.0 Y = 4.0	G = 36.0 Y = 4.0		G = Y =	G = Y =	G = Y =	G = Y =	G = Y =	G = Y =			
Protected turns		Permitted turns			Pedestrian			Cycle length, C = 70.0 s				
Notes												
1. RT volumes, as shown, exclude RTOR. 2. Approach pedestrian and bicycle volumes are those that conflict with right turns from the subject approach. 3. Refer to Equation 16-2.												

Example Problem 1

VOLUME ADJUSTMENT AND SATURATION FLOW RATE WORKSHEET												
General Information												
Project Description <i>Example Problem 1</i>												
Volume Adjustment												
	EB			WB			NB			SB		
	LT	TH	RT	LT	TH	RT	LT	TH	RT	LT	TH	RT
Volume, V (veh/h)	65	620	35	30	700	20	30	370	20	40	510	50
Peak-hour factor, PHF	0.90			0.90			0.90			0.90		
Adjusted flow rate, $v_p = V/PHF$ (veh/h)	72	689	39	33	778	22	33	411	22	44	567	56
Lane group												
Adjusted flow rate in lane group, v (veh/h)	800			833			466			667		
Proportion ¹ of LT or RT (P_{LT} or P_{RT})	0.090	-	0.049	0.040	-	0.027	0.071	-	0.048	0.067	-	0.083
Saturation Flow Rate (see Exhibit 16-7 to determine adjustment factors)												
Base saturation flow, s_0 (pc/h/ln)	1900			1900			1900			1900		
Number of lanes, N	2			2			1			1		
Lane width adjustment factor, f_w	0.967			0.967			1.100			1.100		
Heavy-vehicle adjustment factor, f_{HV}	0.952			0.952			0.926			0.926		
Grade adjustment factor, f_g	1.000			1.000			1.000			1.000		
Parking adjustment factor, f_p	1.000			1.000			1.000			1.000		
Bus blockage adjustment factor, f_{bb}	1.000			1.000			1.000			1.000		
Area type adjustment factor, f_a	0.900			0.900			0.900			0.900		
Lane utilization adjustment factor, f_{LU}	0.950			0.950			1.000			1.000		
Left-turn adjustment factor, f_{LT}	0.716			0.901			0.937			0.951		
Right-turn adjustment factor, f_{RT}	0.993			0.996			0.994			0.989		
Left-turn ped/bike adjustment factor, f_{Lpb}	0.997			0.998			0.999			0.998		
Right-turn ped/bike adjustment factor, f_{Rpb}	0.992			0.995			0.996			0.994		
Adjusted saturation flow, s (veh/h)	2103			2665			1614			1625		
$s = s_0 N f_w f_{HV} f_g f_p f_{bb} f_a f_{LU} f_{LT} f_{RT} f_{Lpb} f_{Rpb}$												
Notes												
1. $P_{LT} = 1.000$ for exclusive left-turn lanes, and $P_{RT} = 1.000$ for exclusive right-turn lanes. Otherwise, they are equal to the proportions of turning volumes in the lane group.												









Example Problem 1

SUPPLEMENTAL WORKSHEET FOR PERMITTED LEFT TURNS OPPOSED BY SINGLE-LANE APPROACH				
General Information				
Project Description <u>Example Problem 1</u>				
Input				
	EB	WB	NB	SB
Cycle length, C (s)	70.0			
Total actual green time for LT lane group, ¹ G (s)			36.0	36.0
Effective permitted green time for LT lane group, ¹ g (s)			36.0	36.0
Opposing effective green time, g _o (s)			36.0	36.0
Number of lanes in LT lane group, ² N			1	1
Adjusted LT flow rate, v _{LT} (veh/h)			33	44
Proportion of LT volume in LT lane group, P _{LT}			0.071	0.067
Proportion of LT volume in opposing flow, P _{LTo}			0.067	0.071
Adjusted flow rate for opposing approach, v _o (veh/h)			667	466
Lost time for LT lane group, t _L			4	4
Computation				
LT volume per cycle, LTC = v _{LT} C/3600			0.642	0.856
Opposing flow per lane, per cycle, v _{oLC} = v _o C/3600 (veh/C/ln)			12.969	9.061
Opposing platoon ratio, R _{po} (refer to Exhibit 16-11)			1.00	1.00
$g_r = G[e^{-0.860(LTC^{0.629})}] - t_L$ $g_r \leq g$ (except exclusive left-turn lanes) ³			14.779	12.505
Opposing queue ratio, q _r = max[1 - R _{po} (g _r /C), 0]			0.486	0.486
$g_q = 4.943v_{oLC}^{0.762}q_r^{1.061} - t_L$ $g_q \leq g$			12.201	8.328
$g_u = g - g_q$ if $g_q \geq g_r$, or $g_u = g - g_r$ if $g_q < g_r$			21.221	23.495
$n = \max[(g_q - g_r)/2, 0]$			0	0
$P_{THo} = 1 - P_{LTo}$			0.933	0.929
E _{L1} (refer to Exhibit C16-3)			2.7	2.2
$E_{L2} = \max[(1 - P_{THo}^n)/P_{LTo}, 1.0]$			1.0	1.0
$f_{min} = 2(1 + P_{LT})/g$			0.060	0.059
$g_{diff} = \max[g_q - g_r, 0]$ (except when left-turn volume is 0) ⁴			0	0
$f_{LT} = f_m = [g_r/g] + \left[\frac{g_u/g}{1 + P_{LT}(E_{L1} - 1)} \right] + \left[\frac{g_{diff}/g}{1 + P_{LT}(E_{L2} - 1)} \right]$ ($f_{min} \leq f_m \leq 1.00$)			0.937	0.951
Notes				
1. Refer to Exhibits C16-4, C16-5, C16-6, C16-7, and C16-8 for case-specific parameters and adjustment factors. 2. For exclusive left-turn lanes, N is equal to the number of exclusive left-turn lanes. For shared left-turn lanes, N is equal to the sum of the shared left-turn, through, and shared right-turn (if one exists) lanes in that approach. 3. For exclusive left-turn lanes, g _r = 0, and skip the next step. Lost time, t _L , may not be applicable for protected-permitted case. 4. If the opposing left-turn volume is 0, then g _{diff} = 0.				

Example Problem 1

SUPPLEMENTAL WORKSHEET FOR PERMITTED LEFT TURNS OPPOSED BY MULTILANE APPROACH				
General Information				
Project Description <u>Example Problem 1</u>				
Input				
	EB	WB	NB	SB
Cycle length, C (s)	70.0			
Total actual green time for LT lane group, ¹ G (s)	26.0	26.0		
Effective permitted green time for LT lane group, ¹ g (s)	26.0	26.0		
Opposing effective green time, g _o (s)	26.0	26.0		
Number of lanes in LT lane group, ² N	2	2		
Number of lanes in opposing approach, N _o	2	2		
Adjusted LT flow rate, v _{LT} (veh/h)	72	33		
Proportion of LT volume in LT lane group, ³ P _{LT}	0.090	0.040		
Adjusted flow rate for opposing approach, v _o (veh/h)	833	800		
Lost time for LT lane group, t _L	4	4		
Computation				
LT volume per cycle, LTC = v _{LT} C/3600	1.400	0.642		
Opposing lane utilization factor, f _{LUo} (refer to Volume Adjustment and Saturation Flow Rate Worksheet)	0.950	0.950		
Opposing flow per lane, per cycle $v_{oic} = \frac{v_o C}{3600 N_o f_{LUo}}$ (veh/C/ln)	8.525	8.187		
$g_r = G[e^{-0.882(LTC)^{0.717}}] - t_L$ $g_r \leq g$ (except for exclusive left-turn lanes) ^{1, 4}	4.461	9.684		
Opposing platoon ratio, R _{po} (refer to Exhibit 16-11)	0.67	1.33		
Opposing queue ratio, q _{ro} = max[1 - R _{po} (g _o /C), 0]	0.751	0.506		
$g_q = 0.5 - [v_{oic}(1 - q_{ro})/g_o] - t_L$ $v_{oic}(1 - q_{ro})/g_o \leq 0.49$ (note case-specific parameters) ¹	11.303	8.027		
$g_u = g - g_q$ if $g_q \geq g_r$, or $g_u = g - g_r$ if $g_q < g_r$	14.697	16.316		
E _{L1} (refer to Exhibit C16-3)	3.3	3.2		
$P_L = P_{LT} \left[1 + \frac{(N-1)g}{(g_r + g_u/E_{L1} + 4.24)} \right]$ (except with multilane subject approach) ⁵	0.268	0.095		
f _{min} = 2(1 + P _L)/g	0.098	0.084		
$f_m = [g_r/g] + [g_u/g] \left[\frac{1}{1 + P_L(E_{L1} - 1)} \right]$, (f _{min} ≤ f _m ≤ 1.00)	0.521	0.892		
f _{LT} = [f _m + 0.91(N - 1)]/N (except for permitted left turns) ⁶	0.716	0.901		
Notes				
<ol style="list-style-type: none"> 1. Refer to Exhibits C16-4, C16-5, C16-6, C16-7, and C16-8 for case-specific parameters and adjustment factors. 2. For exclusive left-turn lanes, N is equal to the number of exclusive left-turn lanes. For shared left-turn lanes, N is equal to the sum of the shared left-turn, through, and shared right-turn (if one exists) lanes in that approach. 3. For exclusive left-turn lanes, P_{LT} = 1. 4. For exclusive left-turn lanes, g_r = 0, and skip the next step. Lost time, t_L, may not be applicable for protected-permitted case. 5. For a multilane subject approach, if P_L ≥ 1 for a left-turn shared lane, then assume it to be a de facto exclusive left-turn lane and redo the calculation. 6. For permitted left turns with multiple exclusive left-turn lanes f_{LT} = f_m. 				

Example Problem 1

SUPPLEMENTAL WORKSHEET FOR PEDESTRIAN-BICYCLE EFFECTS ON PERMITTED LEFT TURNS AND RIGHT TURNS				
General Information				
Project Description <i>Example Problem 1</i>				
Permitted Left Turns				
	EB	WB	NB	SB
				
Effective pedestrian green time, ^{1,2} g_p (s)	26.0	26.0	36.0	36.0
Conflicting pedestrian volume, ¹ v_{ped} (p/h)	100	100	100	100
$v_{pedg} = v_{ped} (C/g_p)$	269	269	194	194
$OCC_{pedg} = v_{pedg}/2000$ if ($v_{pedg} \leq 1000$) or $OCC_{pedg} = 0.4 + v_{pedg}/10,000$ if ($1000 < v_{pedg} \leq 5000$)	0.135	0.135	0.097	0.097
Opposing queue clearing green, ^{3,4} g_q (s)	11.303	8.027	12.201	8.328
Effective pedestrian green consumed by opposing vehicle queue, g_q/g_p ; if $g_q \geq g_p$ then $f_{Lpb} = 1.0$	0.435	0.309	0.339	0.231
$OCC_{pedu} = OCC_{pedg} [1 - 0.5(g_q/g_p)]$	0.106	0.114	0.081	0.086
Opposing flow rate, ³ v_o (veh/h)	833	800	667	466
$OCC_r = OCC_{pedu} [e^{-(5/3600)v_o}]$	0.033	0.038	0.032	0.045
Number of cross-street receiving lanes, ¹ N_{rec}	1	1	2	2
Number of turning lanes, ¹ N_{turn}	1	1	1	1
$A_{pbT} = 1 - OCC_r$ if $N_{rec} = N_{turn}$ $A_{pbT} = 1 - 0.6(OCC_r)$ if $N_{rec} > N_{turn}$	0.967	0.962	0.981	0.973
Proportion of left turns, ⁵ P_{LT}	0.090	0.040	0.071	0.067
Proportion of left turns using protected phase, ⁶ P_{LTA}	0	0	0	0
$f_{Lpb} = 1.0 - P_{LT}(1 - A_{pbT})(1 - P_{LTA})$	0.997	0.998	0.999	0.998
Permitted Right Turns				
				
Effective pedestrian green time, ^{1,2} g_p (s)	26.0	26.0	36.0	36.0
Conflicting pedestrian volume, ¹ v_{ped} (p/h)	100	100	100	100
Conflicting bicycle volume, ^{1,7} v_{bic} (bicycles/h)	20	20	20	20
$v_{pedg} = v_{ped} (C/g_p)$	269	269	194	194
$OCC_{pedg} = v_{pedg}/2000$ if ($v_{pedg} \leq 1000$), or $OCC_{pedg} = 0.4 + v_{pedg}/10,000$ if ($1000 < v_{pedg} \leq 5000$)	0.135	0.135	0.097	0.097
Effective green, ¹ g (s)	26.0	26.0	36.0	36.0
$v_{bicg} = v_{bic} (C/g)$	54	54	39	39
$OCC_{bicg} = 0.02 + v_{bicg}/2700$	0.040	0.040	0.034	0.034
$OCC_r = OCC_{pedg} + OCC_{bicg} - (OCC_{pedg})(OCC_{bicg})$	0.170	0.170	0.128	0.128
Number of cross-street receiving lanes, ¹ N_{rec}	1	1	2	2
Number of turning lanes, ¹ N_{turn}	1	1	1	1
$A_{pbT} = 1 - OCC_r$ if $N_{rec} = N_{turn}$ $A_{pbT} = 1 - 0.6(OCC_r)$ if $N_{rec} > N_{turn}$	0.830	0.830	0.923	0.923
Proportion of right turns, ⁵ P_{RT}	0.049	0.027	0.048	0.083
Proportion of right turns using protected phase, ⁸ P_{RTA}	0	0	0	0
$f_{Rpb} = 1.0 - P_{RT}(1 - A_{pbT})(1 - P_{RTA})$	0.992	0.995	0.996	0.994
Notes				
<ol style="list-style-type: none"> 1. Refer to Input Worksheet. 2. If intersection signal timing is given, use Walk + flashing Don't Walk (use G + Y if no pedestrian signals). If signal timing must be estimated, use (Green Time - Lost Time per Phase) from Quick Estimation Control Delay and LOS Worksheet. 3. Refer to supplemental worksheets for left turns. 4. If unopposed left turn, then $g_q = 0$, $v_o = 0$, and $OCC_r = OCC_{pedu} = OCC_{pedg}$. 5. Refer to Volume Adjustment and Saturation Flow Rate Worksheet. 6. Ideally determined from field data; alternatively, assume it equal to $(1 - \text{permitted phase } f_{LT})/0.95$. 7. If $v_{bic} = 0$ then $v_{bicg} = 0$, $OCC_{bicg} = 0$, and $OCC_r = OCC_{pedg}$. 8. P_{RTA} is the proportion of protected green over the total green, $g_{prot}/(g_{prot} + g_{perm})$. If only permitted right-turn phase exists, then $P_{RTA} = 0$. 				

Example Problem 1

CAPACITY AND LOS WORKSHEET									
General information									
Project Description <u>Example Problem 1</u>									
Capacity Analysis									
Phase number	1	1	2	2					
Phase type	P	P	P	P					
Lane group									
Adjusted flow rate, v (veh/h)	800	833	466	667					
Saturation flow rate, s (veh/h)	2103	2665	1614	1625					
Lost time, t _L (s), t _L = I ₁ + Y - e	4	4	4	4					
Effective green time, g (s), g = G + Y - t _L	26.0	26.0	36.0	36.0					
Green ratio, g/C	0.371	0.371	0.514	0.514					
Lane group capacity, ¹ c = s(g/C), (veh/h)	780	989	830	835					
v/c ratio, X	1.026	0.842	0.561	0.799					
Flow ratio, v/s	0.380			0.410					
Critical lane group/phase (√)	√			√					
Sum of flow ratios for critical lane groups, Y _c Y _c = Σ (critical lane groups, v/s)	0.790								
Total lost time per cycle, L (s)	8								
Critical flow rate to capacity ratio, X _c X _c = (Y _c)(C)/(C - L)	0.892								
Lane Group Capacity, Control Delay, and LOS Determination									
	EB		WB		NB		SB		
Lane group									
Adjusted flow rate, ² v (veh/h)	800		833		466		667		
Lane group capacity, ² c (veh/h)	780		989		830		835		
v/c ratio, ² X = v/c	1.026		0.842		0.561		0.799		
Total green ratio, ² g/C	0.371		0.371		0.514		0.514		
Uniform delay, d ₁ = $\frac{0.50 C (1 - (g/C)^2)}{1 - [\min(1, X)g/C]}$ (s/veh)	22.019		20.138		11.617		14.028		
Incremental delay calibration, ³ k	0.5		0.5		0.5		0.5		
Incremental delay, ⁴ d ₂ d ₂ = 900T[(X - 1) + √((X - 1) ² + $\frac{8kIX}{CT}$)] (s/veh)	39.011		8.647		2.734		7.882		
Initial queue delay, d ₃ (s/veh) (Appendix F)	0		0		0		0		
Uniform delay, d ₁ (s/veh) (Appendix F)									
Progression adjustment factor, PF	0.926		1.111		1.000		1.000		
Delay, d = d ₁ (PF) + d ₂ + d ₃ (s/veh)	59.4		31.0		14.4		21.9		
LOS by lane group (Exhibit 16-2)	E		C		B		C		
Delay by approach, d _A = $\frac{\sum(d)(v)}{\sum v}$ (s/veh)	59.4		31.0		14.4		21.9		
LOS by approach (Exhibit 16-2)	E		C		B		C		
Approach flow rate, v _A (veh/h)	800		833		466		667		
Intersection delay, d _I = $\frac{\sum(d_A)(v_A)}{\sum v_A}$ (s/veh)	34.2		Intersection LOS (Exhibit 16-2)			C			
Notes									
1. For permitted left turns, the minimum capacity is (1 + P _L)(3600/C). 2. Primary and secondary phase parameters are summed to obtain lane group parameters. 3. For pretimed or nonactuated signals, k = 0.5. Otherwise, refer to Exhibit 16-13. 4. T = analysis duration (h); typically T = 0.25, which is for the analysis duration of 15 min. I = upstream filtering metering adjustment factor; I = 1 for isolated intersections.									

EXAMPLE PROBLEM 2

The Intersection The intersection of Sixth Street (NB) and Western Boulevard (EB/WB) is located in an outlying area. Intersection geometry and flow characteristics are shown on the Input Worksheet.

The Question What are the delay and peak-hour LOS for this intersection?

The Facts

- √ EB and WB HV = 10 percent,
- √ NB HV = 5 percent,
- √ PHF = 0.95,
- √ No parking EB/WB,
- √ Arrival Type 3,
- √ Movement lost time = 4 s, each phase
- √ Sixth Street NB grade = -2 percent
- √ Three-phase signal,
- √ Western Blvd. bus stopping = 20 b/h,
- √ Pedestrian volume = 50 p/h, all approaches,
- √ All lane widths are 3.6 m,
- √ Western Boulevard has two lanes in each direction plus an added left-turn lane for EB,
- √ Sixth Street is a NB one-way street with two lanes,
- √ Bicycle volume = 20 bicycles/h, all approaches,
- √ NB parking = 20 maneuvers/h, and
- √ Peak-hour volume data, by approach and movement, are shown on the Input Worksheet.

Comments

- √ Assume a range of cycle lengths of 70 s to 100 s. This range relates to default values given in Chapter 10,
- √ Assume crosswalk width = 3.0 m for all approaches,
- √ Assume N/S crosswalks are 18.0 m long and E/W crosswalks are 13.2 m long,
- √ Assume base saturation flow rate = 1,900 pc/h/ln,
- √ Assume $E_T = 2.0$, and
- √ Signal timing and cycle length are not given, therefore the quick estimation method is required to determine these two parameters.

Steps

1. The quick estimation method is used to determine the signal phasing and cycle length. Known or assumed input data are entered on the Input Worksheet.	
2. In the Left-Turn Treatment Worksheet, EBLT is treated as a protected phase and NBLT as an unopposed phase. EBLT is treated as a protected phase because $(v_L)(v_o)$ exceeds 90,000 with two opposing through lanes.	
3. For each intersection approach, a Lane Volume Worksheet is completed and critical lane volumes are determined.	
4. Using the computed critical lane volumes, cycle length is computed as 31.9 s (see Quick Estimation Control Delay and LOS Worksheet). However, we use 70.0 s since this was set by the analyst as the "minimum." Green times are computed for EB/WB and NB phases. The Quick Estimation Control Delay and LOS Worksheet is used. For example, for Phase 1: $g = (70 - 12) \left(\frac{126}{1014} \right) + t_L = 7.2 \text{ s} + 4.0 = 11.2 \text{ s}$ These computed green times are now used as input for the next steps.	
5. The timing for Phases 1, 2, and 3 is 11.2 s, 27.4 s, and 31.4 s, respectively. After yellow time is subtracted, the effective green is 7.2 s, 23.4 s, and 27.4 s, respectively.	
6. Pedestrians/cycle.	$50 \frac{p}{h} * \frac{1h}{3,600s} * 70s = 0.972 \text{ p/cycle}$

7. Minimum effective green time required for pedestrians (use Equation 16-2).	$G_p = 3.2 + \frac{L}{1.2} + 0.27N_{ped}$ $G_p(\text{Western}) = 3.2 + \frac{18.0}{1.2} + 0.27(0.972) = 18.5 \text{ s}$ $G_p(\text{Sixth}) = 3.2 + \frac{13.2}{1.2} + 0.27(0.972) = 14.5 \text{ s}$
8. Compare minimum effective green time required for pedestrians with actual effective green.	$g(\text{Western}) = 23.4 \text{ s, which is } >18.5 \text{ s}$ $g(\text{Sixth}) = 27.4 \text{ s, which is } >14.5 \text{ s}$
9. Proportion of left turns and right turns.	Proportions of left- and right-turn traffic are found by dividing the appropriate turning volumes by the total lane group volume. $P_{LT}(\text{EB}) = 1.000$ for the exclusive left-turn lane
10. Lane width adjustment factor (use Exhibit 16-7).	$f_w = 1 + \frac{(W - 3.6)}{9}$ $f_w(\text{EB}) = 1 + \frac{(3.6 - 3.6)}{9} = 1.000$
11. Heavy-vehicle adjustment factor (use Exhibit 16-7).	$f_{HV} = \frac{100}{100 + \% \text{ HV}(E_T - 1)}$ $f_{HV}(\text{EB}) = \frac{100}{100 + 10(2.0 - 1)} = 0.909$
12. Percent grade adjustment factor (use Exhibit 16-7).	0% grade, $f_g = 1.000$
13. Parking adjustment factor (use Exhibit 16-7).	No parking maneuvers (EB and WB), $f_p = 1.000$ 20 parking maneuvers/hour (NB), $f_p = 0.900$
14. Bus blockage adjustment factor (use Exhibit 16-7).	No bus stopping (NB), $f_{bb} = 1.0$ 20 buses/hour stopping (EB and WB), $f_{bb} = 0.960$
15. Area type adjustment factor (use Exhibit 16-7).	For outlying areas, $f_a = 1.000$
16. Lane utilization adjustment factor (use Exhibit 16-7).	Refer to Exhibit 10-23. This factor is applied to establish the conditions in the worst lane within each lane group. Otherwise, the results would reflect the average of all lanes of the defined lane groups. Use $f_{LU} = 0.950$ for all through movements.
17. Left-turn adjustment factor (use Exhibit 16-7).	f_{LT} applies to the EB left turn. For protected LT, $f_{LT} = 0.950$. For permitted LT, the supplemental worksheet for multilane approaches is used. f_{LT} (permitted) = 0.149. NB left turn is treated as a shared lane protected left turn because it has no opposing flow. f_{LT} (NB) = 0.998 (use equation in Exhibit 16-7).
18. Right-turn adjustment factor (use Exhibit 16-7).	f_{RT} is applied to NB and WB right turns. $f_{RT} = 1.0 - 0.150P_{RT}$
19. Left-turn pedestrian/bicycle adjustment factor (use Exhibit 16-7).	Supplemental worksheet for pedestrian-bicycle effects is used.
20. Right-turn pedestrian/bicycle adjustment factor (use Exhibit 16-7).	Supplemental worksheet for pedestrian-bicycle effects is used.

21. Saturation flow (use Equation 16-4).	$s = s_o N f_w f_{HV} f_g f_p f_{bb} f_{LU} f_a f_{LT} f_{RT} f_{Lpb} f_{Rpb}$ $s(\text{EBLT prot}) = 1900 * 1 * 1.000 * 0.909 * 1.000 * 1.000 * 1.000 * 1.000 * 1.000 * 0.950 * 1.000 * 1.000 * 1.000 = 1641 \text{ veh/h}$
22. Lane group capacity (use Equation 16-6).	$c = s(g/C)$ $c(\text{EBLT prot}) = 1641(0.103) = 169 \text{ veh/h}$
23. v/c ratio.	$v/c(\text{EB}) = \frac{126}{169} = 0.746$
24. Determine critical lane group in each timing phase.	The lane group with the highest v/c ratio in a phase is considered the critical lane group. The critical lane groups are EBLT (protected), WB through, and NB through.
25. Flow ratio of critical lane group.	$v/s(\text{EBLT Prot}) = \frac{126}{1641} = 0.077$
26. Sum of critical lane group v/s ratios.	$Y_c = 0.077 + 0.275 + 0.289 = 0.641$
27. Critical flow rate to capacity ratio.	$X_c = \frac{Y_c * C}{C - L}$ $X_c = \frac{0.641(70.0)}{70.0 - 12} = 0.774$
28. Uniform delay.	Supplemental uniform delay worksheet is needed to compute d_1 for the EBLT because it has both protected and permitted phases. d_1 (EBLT) = 11.811 s/veh.
29. Incremental delay (use Equation 16-13).	$d_2 = 900T[(X - 1) + \sqrt{(\dots)}]$ $d_2(\text{EBLT}) = 900(0.250)[(0.468 - 1) + \sqrt{(\dots)}] = 5.748 \text{ s/veh}$
30. Progression adjustment factor (use Exhibit 16-12).	PF = 1.000 for arrival type 3
31. Lane group delay (use Equation 16-10).	$d = d_1PF + d_2 + d_3$ $d(\text{EBLT}) = 11.811(1.000) + 5.748 + 0 = 17.6 \text{ s/veh}$
32. Approach delay (use Equation 16-14).	$d_A = \frac{\sum(d)(v)}{\sum v}$ $d_A = \frac{(17.6 * 126) + (15.6 * 1,032)}{126 + 1,032} = 15.8 \text{ s/veh}$
33. Intersection delay (use Equation 16-15).	$d_I = \frac{\sum(d_A)(V_A)}{\sum V_A}$ $d_I(\text{EB}) = \frac{(15.8 * 1,158) + (28.8 * 842) + (22.4 * 894)}{(1,158 + 842 + 894)}$ $= 21.6 \text{ s/veh}$
34. LOS by lane group, approach, and intersection (use Exhibit 16-2).	LOS (EBLT) = B LOS (EB) = B LOS intersection = C

The calculation results are summarized as follows.

Dirac/ Ln Grp	v/c Ratio	g/C Ratio	Unif Delay d_1	Progr Factor PF	Ln Grp Cap	Cal Term k	Incr Delay d_2	Ln Grp Delay	Ln Grp LOS	Delay by App	LOS by App
EB/L	0.468	0.494	11.811	1.000	269	0.500	5.748	17.6	B		
EB/T	0.663	0.494	13.326	1.000	1556	0.500	2.243	15.6	B	15.8	B
WB/TR	0.822	0.334	21.400	1.000	1024	0.500	7.429	28.8	C	28.8	C
NB/LTR	0.740	0.391	18.266	1.000	1208	0.5000	4.097	22.4	C	22.4	C
Intersection Delay = 21.6 s/veh						Intersection LOS = C					

Alternatives

Two alternatives are considered for the EB left-turn treatment: protected only and permitted-plus-protected. The first alternative is to assess the impact of eliminating the EB permitted left-turn phase. The left-turn volume is low and is below the capacity of the protected phase. Hence, queue spillovers will not occur.

The supplemental worksheet for permitted left turns is not needed because there are no permitted left turns. The supplemental uniform delay worksheet is also not needed because the left turn is contained in a single phase. The intersection performance is reassessed and the results are as follows.

Direction/ LnGrp	v/c Ratio	g/C Ratio	Unif Delay d_1	Progr Fact PF	Lane Grp Cap	Cal Term k	Incr Delay d_2	Lane Grp Delay	Lane Grp LOS	Delay by App	LOS by App
EB/L	0.746	0.103	30.505	1.000	169	0.500	25.564	56.1	E		
EB/T	0.663	0.494	13.326	1.000	1556	0.500	2.243	15.6	B	20.0	B
WB/TR	0.822	0.334	21.400	1.000	1024	0.500	7.429	28.8	C	28.3	C
NB/LTR	0.740	0.391	18.266	1.000	1208	0.500	4.097	22.4	C	22.5	C
Intersection Delay = 23.3 s/veh						Intersection LOS = C					

The elimination of the permitted phase has caused a drop in the left-turn capacity from 269 veh/h to 169 veh/h. Correspondingly, the delay has increased from 17.6 s/veh to 56.1 s/veh. The overall intersection delay has also increased by 1.7 s/veh to 23.3 s/veh.

From the operational standpoint, the protected-only phase is undesirable because it induces additional delay. However, from the safety standpoint, the phase may be desirable because safety may be enhanced by reducing the number of accidents caused by turning vehicles.

The second alternative is to reverse the EB left-turn treatment from protected-plus-permitted to permitted-plus-protected. The cycle length and phase times are kept the same. The intersection performance is reassessed and the results are as follows.

Dirac/ Ln Grp	v/c Ratio	g/C Ratio	Unif Delay d_1	Progr Factor PF	Ln Grp Cap	Cal Term k	Incr Delay d_2	Lane Grp Delay	Lane Grp LOS	Delay by App	LOS by App
EB/L	0.346	0.494	15.626	1.000	364	0.500	2.593	18.2	B		
EB/T	0.663	0.494	13.326	1.000	1556	0.500	2.243	15.6	B	15.9	B
WB/TR	0.822	0.334	21.400	1.000	1024	0.500	7.429	28.8	C	28.3	C
NB/LTR	0.740	0.391	18.266	1.000	1208	0.500	4.097	22.4	C	22.5	C
Intersection Delay = 21.7 s/veh						Intersection LOS = C					

Reversing the EB left-turn phase results in a slight increase in delay from 17.6 s/veh to 18.2 s/veh. The intersection delay also increases by 0.1 s/veh to 21.7 s/veh.

In conclusion, solely on the basis of operations, the first option (protected-plus-permitted EB left turn) appears to be the most desirable.

Example Problem 2

QUICK ESTIMATION INPUT WORKSHEET												
General Information						Site Information						
Analyst	<u>WLL</u>					Intersection	<u>Sixth St./Western Blvd</u>					
Agency or Company	<u>CEI</u>					Area Type	<input type="checkbox"/> CBD		<input checked="" type="checkbox"/> Other			
Date Performed	<u>4/21/99</u>					Jurisdiction	_____					
Analysis Time Period	_____					Analysis Year	<u>1999</u>					
Intersection Geometry												
Volume and Signal Input												
	EB			WB			NB			SB		
	LT	TH	RT ¹	LT	TH	RT ¹	LT	TH	RT ¹	LT	TH	RT ¹
Volume, V (veh/h)	120	980		700	100		40	785	25			
Proportion of LT or RT (P_{LT} or P_{RT}) ²		-			-			-			-	
Parking (Yes/No)	No			No			Yes					
Left-turn treatment (permitted, protected, not opposed) (if known)							Not Opposed					
Peak-hour factor, PHF	<u>0.95</u>											
Cycle length	Minimum, C_{min} <u>70</u> s			Maximum, C_{max} <u>100</u> s			or Given, C _____ s					
Lost time/phase	<u>4</u> s											
Notes												
<ol style="list-style-type: none"> 1. RT volumes, as shown, exclude RTOR. 2. P_{LT} = 1.000 for exclusive left-turn lanes, and P_{RT} = 1.000 for exclusive right-turn lanes. Otherwise, they are equal to the proportions of turning volumes in the lane group. 												

LEFT-TURN TREATMENT WORKSHEET												
General Information												
Description <u>Example Problem 2</u>												
Check #1. Left-Turn Lane Check												
Approach	EB	WB	NB	SB								
Number of left-turn lanes	1											
Protect left turn (Y or N)?	N											
If the number of left-turn lanes on any approach exceeds 1, then it is recommended that the left turns on that approach be protected. Those approaches with protected left turns need not be evaluated in subsequent checks.												
Check #2. Minimum Volume Check												
Approach	EB	WB	NB	SB								
Left-turn volume	120											
Protect left turn (Y or N)?	N											
If left-turn volume on any approach exceeds 240 veh/h, then it is recommended that the left turns on that approach be protected. Those approaches with protected left turns need not be evaluated in subsequent checks.												
Check #3. Minimum Cross-Product Check												
Approach	EB	WB	NB	SB								
Left-turn volume, V_L (veh/h)	120											
Opposing mainline volume, V_o (veh/h)	800											
Cross-product ($V_L * V_o$)	96,000											
Opposing through lanes	2											
Protected left turn (Y or N)?	Y											
Minimum Cross-Product Values for Recommending Left-Turn Protection <table style="margin-left: auto; margin-right: auto;"> <thead> <tr> <th style="text-align: center;">Number of Through Lanes</th> <th style="text-align: center;">Minimum Cross-Product</th> </tr> </thead> <tbody> <tr> <td style="text-align: center;">1</td> <td style="text-align: center;">50,000</td> </tr> <tr> <td style="text-align: center;">2</td> <td style="text-align: center;">90,000</td> </tr> <tr> <td style="text-align: center;">3</td> <td style="text-align: center;">110,000</td> </tr> </tbody> </table>					Number of Through Lanes	Minimum Cross-Product	1	50,000	2	90,000	3	110,000
Number of Through Lanes	Minimum Cross-Product											
1	50,000											
2	90,000											
3	110,000											
If the cross-product on any approach exceeds the above values, then it is recommended that the left turns on that approach be protected. Those approaches with protected left turns need not be evaluated in subsequent checks.												
Check #4. Sneaker Check												
Approach	EB	WB	NB	SB								
Left-turn volume, V_L (veh/h)												
Sneaker capacity = 7200/C												
Left-turn equivalence, E_{L1} (Exhibit C16-3)												
Protected left turn (Y or N)?												
If the left-turn equivalence factor is 3.5 or higher (computed in Exhibit A10-4, quick estimation lane volume worksheet) and the unadjusted left turn is greater than the sneaker capacity, then it is recommended that the left turns on that approach be protected.												
Notes												
1. If any approach is recommended for left-turn protection but the analyst wishes to analyze it as permitted, the planning application may give overly optimistic results. The analyst should instead use the more robust method described in Chapter 16, Signalized Intersections. 2. All volumes used in this worksheet are unadjusted hourly volumes.												

Example Problem 2

QUICK ESTIMATION LANE VOLUME WORKSHEET			
General Information			
Description/Approach _____ <i>Example Problem 2, EB</i>			
Right-Turn Movement			
	Exclusive RT Lane	Shared RT Lane	
RT volume, V_R (veh/h)			
Number of exclusive RT lanes, N_{RT}		use 1	
RT adjustment factor, ¹ f_{RT}			
RT volume per lane, V_{RT} (veh/h/ln) $V_{RT} = \frac{V_R}{(N_{RT} \times f_{RT})}$			
Left-Turn Movement			
LT volume, V_L (veh/h)		120	
Opposing mainline volume, V_o (veh/h)		800	
Number of exclusive LT lanes, N_{LT}		1	
LT adjustment factor, ² f_{LT}		0.95	
LT volume per lane, ³ V_{LT} (veh/h/ln) $V_{LT} = \frac{V_L}{(N_{LT} \times f_{LT})}$	Permitted LT use 0	Protected LT 126	Not Opposed LT _____
Through Movement			
	Permitted LT	Protected LT	Not Opposed LT
Through volume, V_T (veh/h)		980	
Parking adjustment factor, f_p		1.000	
Number of through lanes, N_{TH}		2	
Total approach volume, ⁴ V_{tot} (veh/h) $V_{tot} = \frac{[V_{RT}(\text{shared}) + V_T + V_{LT}(\text{not opp})]}{f_p}$		980	
Through Movement with Exclusive LT Lane			
Through volume per lane, V_{TH} (veh/h/ln) $V_{TH} = \frac{V_{tot}}{N_{TH}}$		490	
Critical lane volume, ⁵ V_{CL} (veh/h) $\text{Max}[V_{LT}, V_{RT}(\text{exclusive}), V_{TH}]$		490	
Through Movement with Shared LT Lane			
Proportion of left turns, P_{LT}		Does not apply	Does not apply
LT equivalence, E_{LT} (Exhibit C16-3)		Does not apply	Does not apply
LT adjustment, f_{DL} (Exhibit A10-6)			use 1.0
Through volume per lane, V_{TH} (veh/h/ln) $V_{TH} = \frac{V_{tot}}{(N_{TH} \times f_{DL})}$			
Critical lane volume, ⁵ V_{CL} (veh/h) $\text{Max}[V_{RT}(\text{exclusive}), V_{TH}]$			
Notes			
1. For RT shared or single lanes, use 0.85. For RT double lanes, use 0.75. 2. For LT single lanes, use 0.95. For LT double lanes, use 0.92. For a one-way street or T-intersection, use 0.85 for one lane and 0.75 for two lanes. 3. For unopposed LT shared lanes, $N_{LT} = 1$. 4. For exclusive RT lanes, $V_{RT}(\text{shared}) = 0$. If not opposed, add V_{LT} to V_T and set $V_{LT}(\text{not opp}) = 0$. 5. V_{LT} is included only if LT is unopposed. $V_{RT}(\text{exclusive})$ is included only if RT is exclusive.			

Example Problem 2

QUICK ESTIMATION LANE VOLUME WORKSHEET			
General Information			
Description/Approach <u>Example Problem 2, WB</u>			
Right-Turn Movement			
	Exclusive RT Lane	Shared RT Lane	
RT volume, V_R (veh/h)		100	
Number of exclusive RT lanes, N_{RT}		use 1	
RT adjustment factor, ¹ f_{RT}		0.850	
RT volume per lane, V_{RT} (veh/h/ln) $V_{RT} = \frac{V_R}{(N_{RT} \times f_{RT})}$		118	
Left-Turn Movement			
LT volume, V_L (veh/h)			
Opposing mainline volume, V_o (veh/h)			
Number of exclusive LT lanes, N_{LT}			
LT adjustment factor, ² f_{LT}			
LT volume per lane, ³ V_{LT} (veh/h/ln) $V_{LT} = \frac{V_L}{(N_{LT} \times f_{LT})}$	Permitted LT <u>use 0</u>	Protected LT _____	Not Opposed LT _____
Through Movement			
	Permitted LT	Protected LT	Not Opposed LT
Through volume, V_T (veh/h)	700		
Parking adjustment factor, f_p	1.000		
Number of through lanes, N_{TH}	2		
Total approach volume, ⁴ V_{tot} (veh/h) $V_{tot} = \frac{[V_{RT}(\text{shared}) + V_T + V_{LT}(\text{not opp})]}{f_p}$	818		
Through Movement with Exclusive LT Lane			
Through volume per lane, V_{TH} (veh/h/ln) $V_{TH} = \frac{V_{tot}}{N_{TH}}$	409		
Critical lane volume, ⁵ V_{CL} (veh/h) $\text{Max}[V_{LT}, V_{RT}(\text{exclusive}), V_{TH}]$	409		
Through Movement with Shared LT Lane			
Proportion of left turns, P_{LT}		Does not apply	Does not apply
LT equivalence, E_{LT} (Exhibit C16-3)		Does not apply	Does not apply
LT adjustment, f_{DL} (Exhibit A10-6)			use 1.0
Through volume per lane, V_{TH} (veh/h/ln) $V_{TH} = \frac{V_{tot}}{(N_{TH} \times f_{DL})}$			
Critical lane volume, ⁵ V_{CL} (veh/h) $\text{Max}[V_{RT}(\text{exclusive}), V_{TH}]$			
Notes			
1. For RT shared or single lanes, use 0.85. For RT double lanes, use 0.75. 2. For LT single lanes, use 0.95. For LT double lanes, use 0.92. For a one-way street or T-intersection, use 0.85 for one lane and 0.75 for two lanes. 3. For unopposed LT shared lanes, $N_{LT} = 1$. 4. For exclusive RT lanes, $V_{RT}(\text{shared}) = 0$. If not opposed, add V_{LT} to V_T and set $V_{LT}(\text{not opp}) = 0$. 5. V_{LT} is included only if LT is unopposed. $V_{RT}(\text{exclusive})$ is included only if RT is exclusive.			

Example Problem 2

QUICK ESTIMATION LANE VOLUME WORKSHEET			
General Information			
Description/Approach <u>Example Problem 2, NB</u>			
Right-Turn Movement			
	Exclusive RT Lane	Shared RT Lane	
RT volume, V_R (veh/h)		25	
Number of exclusive RT lanes, N_{RT}		use 1	
RT adjustment factor, ¹ f_{RT}		0.85	
RT volume per lane, V_{RT} (veh/h/ln) $V_{RT} = \frac{V_R}{(N_{RT} \times f_{RT})}$		29	
Left-Turn Movement			
LT volume, V_L (veh/h)	40		
Opposing mainline volume, V_o (veh/h)	0		
Number of exclusive LT lanes, N_{LT}	0		
LT adjustment factor, ² f_{LT}	0.85		
LT volume per lane, ³ V_{LT} (veh/h/ln) $V_{LT} = \frac{V_L}{(N_{LT} \times f_{LT})}$	Permitted LT <u>use 0</u>	Protected LT _____	Not Opposed LT <u>47</u>
Through Movement			
	Permitted LT	Protected LT	Not Opposed LT
Through volume, V_T (veh/h)			785
Parking adjustment factor, f_p			0.900
Number of through lanes, N_{TH}			2
Total approach volume, ⁴ V_{tot} (veh/h) $V_{tot} = \frac{[V_{RT}(\text{shared}) + V_T + V_{LT}(\text{not opp})]}{f_p}$			957
Through Movement with Exclusive LT Lane			
Through volume per lane, V_{TH} (veh/h/ln) $V_{TH} = \frac{V_{tot}}{N_{TH}}$			
Critical lane volume, ⁵ V_{CL} (veh/h) $\text{Max}[V_{LT}, V_{RT}(\text{exclusive}), V_{TH}]$			
Through Movement with Shared LT Lane			
Proportion of left turns, P_{LT}		Does not apply	Does not apply
LT equivalence, E_{L1} (Exhibit C16-3)		Does not apply	Does not apply
LT adjustment, f_{DL} (Exhibit A10-6)			use 1.0
Through volume per lane, V_{TH} (veh/h/ln) $V_{TH} = \frac{V_{tot}}{(N_{TH} \times f_{DL})}$			479
Critical lane volume, ⁵ V_{CL} (veh/h) $\text{Max}[V_{RT}(\text{exclusive}), V_{TH}]$			479
Notes			
1. For RT shared or single lanes, use 0.85. For RT double lanes, use 0.75. 2. For LT single lanes, use 0.95. For LT double lanes, use 0.92. For a one-way street or T-intersection, use 0.85 for one lane and 0.75 for two lanes. 3. For unopposed LT shared lanes, $N_{LT} = 1$. 4. For exclusive RT lanes, $V_{RT}(\text{shared}) = 0$. If not opposed, add V_{LT} to V_T and set $V_{LT}(\text{not opp}) = 0$. 5. V_{LT} is included only if LT is unopposed. $V_{RT}(\text{exclusive})$ is included only if RT is exclusive.			

Example Problem 2

QUICK ESTIMATION CONTROL DELAY AND LOS WORKSHEET				
General Information				
Description <u>Example Problem 2</u>				
East-West Phasing Plan				
Selected plan (Exhibit A10-8) <u>2b</u>	Phase No. 1	Phase No. 2	Phase No. 3	
Movement codes	EB TH LT	EB WB TH		
Critical phase volume, CV (veh/h)	126	409		
Lost time/phase, t _L (s)	4	4		
North-South Phasing Plan				
Selected plan (Exhibit A10-8) <u>I</u>	Phase No. 1	Phase No. 2	Phase No. 3	
Movement codes	NB TH LT			
Critical phase volume, CV (veh/h)	479			
Lost time/phase, t _L (s)	4			
Intersection Status Computation				
Critical sum, CS (veh/h) $CS = \sum CV$			1014	
Lost time/cycle, L (s) $L = \sum t_L$			12	
Reference sum flow rate RS (veh/h) ¹			1625	
Cycle length, C (s) $C = \frac{L}{1 - \left[\frac{\min(CS, RS)}{RS} \right]}$ $C_{min} \leq C \leq C_{max}$			31.9 < 70, use 70	
Critical v/c ratio, X _{cm} $X_{cm} = \frac{CS}{RS \left(1 - \frac{L}{C} \right)}$			0.753	
Intersection status (Exhibit A10-9)	under capacity			
Green Time Calculation				
East-West Phasing	Phase No. 1	Phase No. 2	Phase No. 3	
Green time, g (s) $g = \left[(C - L) \left(\frac{CV}{CS} \right) + t_L \right]$	11.2	27.4		
North-South Phasing	Phase No. 1	Phase No. 2	Phase No. 3	
Green time, g (s) $g = \left[(C - L) \left(\frac{CV}{CS} \right) + t_L \right]$	31.4			
Control Delay and LOS				
	EB	WB	NB	SB
Lane group				
Lane group adjusted volume from lane volume worksheet, V (veh/h)				
Green ratio, g/C				
Lane group saturation flow rate, s (veh/h) $s = RS \cdot \text{number of lanes in lane group}$				
v/c ratio, X $X = \frac{V/s}{g/C}$				
Lane group capacity, c (veh/h) $c = \frac{V}{X}$				
Progression adjustment factor, PF (Exhibit 16-12)				
Uniform delay, d ₁ (s/veh) (Equation 16-11)				
Incremental delay, d ₂ (s/veh) (Equation 16-12)				
Initial queue delay, d ₃ (s/veh) (Appendix F, Ch. 16)				
Delay, d = d ₁ (PF) + d ₂ + d ₃ (s/veh)				
Delay by approach, d _A (s/veh) $\frac{\sum(d_i V_i)}{\sum V_i}$				
Approach flow rate, V _A (veh/h)				
Intersection delay, d _I (s/veh) $d_I = \frac{\sum(d_A V_A)}{\sum V_A}$	Intersection LOS (Exhibit 16-2)			
Notes				
1. RS = 1710(PHF)(f _a), where f _a is area adjustment factor (0.90 for CBD and 1.0 for all others).				

Example Problem 2

INPUT WORKSHEET												
General Information						Site Information						
Analyst <u>WLL</u>						Intersection <u>Sixth St./Western Blvd.</u>						
Agency or Company <u>CEI</u>						Area Type <input type="checkbox"/> CBD <input checked="" type="checkbox"/> Other						
Date Performed <u>4/21/99</u>						Jurisdiction _____						
Analysis Time Period _____						Analysis Year <u>1999</u>						
Intersection Geometry												
<p style="text-align: center;">grade= 0% Sixth St. Street grade= 0% grade= -2%</p> <p style="text-align: center;">(bus stop) 3.6 m 3.6 m 3.6 m 3.6 m (bus stop)</p> <p style="text-align: center;">grade= 0% Western Blvd. Street grade= -2%</p> <p style="text-align: center;">3.6 m</p> <div style="display: flex; justify-content: space-around; align-items: center;"> <div style="text-align: center;"> <p>Show North</p> </div> <div style="font-size: small;"> <p> = Pedestrian Button</p> <p> = Lane Width</p> <p> = Through</p> <p> = Right</p> <p> = Left</p> <p> = Through + Right</p> <p> = Left + Through</p> <p> = Left + Right</p> <p> = Left + Through + Right</p> </div> </div>												
Volume and Timing Input												
	EB			WB			NB			SB		
	LT	TH	RT ¹	LT	TH	RT ¹	LT	TH	RT ¹	LT	TH	RT ¹
Volume, V (veh/h)	120	980		700	100		40	785	25			
% heavy vehicles, % HV		10		10			5					
Peak-hour factor, PHF		0.95		0.95			0.95					
Pretimed (P) or actuated (A)												
Start-up lost time, I ₁ (s)												
Extension of effective green time, e (s)												
Arrival type, AT		3		3			3					
Approach pedestrian volume, ² v _{ped} (p/h)		50		50			50					
Approach bicycle volume, ² v _{bic} (bicycles/h)		20		20			20					
Parking (Y or N)		N		N			Y					
Parking maneuvers, N _m (maneuvers/h)							20					
Bus stopping, N _B (buses/h)		20		20								
Min. timing for pedestrians, ³ G _p (s)		18.5		18.5			14.5					
Signal Phasing Plan												
D I A G R A M	Ø1	Ø2	Ø3	Ø4	Ø5	Ø6	Ø7	Ø8				
Timing	G = 7.2 Y = 4	G = 23.4 Y = 4	G = 27.4 Y = 4	G = Y =	G = Y =	G = Y =	G = Y =	G = Y =				
	Protected turns		Permitted turns Pedestrian			Cycle length, C = <u>70</u> s						
Notes												
<ol style="list-style-type: none"> 1. RT volumes, as shown, exclude RTOR. 2. Approach pedestrian and bicycle volumes are those that conflict with right turns from the subject approach. 3. Refer to Equation 16-2. 												

Example Problem 2

VOLUME ADJUSTMENT AND SATURATION FLOW RATE WORKSHEET												
General Information												
Project Description <i>Example Problem 2</i>												
Volume Adjustment												
	EB			WB			NB			SB		
	LT	TH	RT	LT	TH	RT	LT	TH	RT	LT	TH	RT
Volume, V (veh/h)	120	980		700	100		40	785	25			
Peak-hour factor, PHF		0.95		0.95			0.95					
Adjusted flow rate, $v_p = V/PHF$ (veh/h)	126	1032		737	105		42	826	26			
Lane group												
Adjusted flow rate in lane group, v (veh/h)	126		1032	842			894					
Proportion ¹ of LT or RT (P_{LT} or P_{RT})	1.000	-		-	0.125	0.047	-	0.029				-
Saturation Flow Rate (see Exhibit 16-7 to determine adjustment factors)												
Base saturation flow, s_0 (pc/h/ln)	1900	1900	1900	1900			1900					
Number of lanes, N	1	1	2	2			2					
Lane width adjustment factor, f_w	1.000	1.000	1.000	1.000			1.000					
Heavy-vehicle adjustment factor, f_{HV}	0.909	0.909	0.909	0.909			0.952					
Grade adjustment factor, f_g	1.000	1.000	1.000	1.000			1.010					
Parking adjustment factor, f_p	1.000	1.000	1.000	1.000			0.900					
Bus blockage adjustment factor, f_{bb}	1.000	1.000	0.960	0.960			1.000					
Area type adjustment factor, f_a	1.000	1.000	1.000	1.000			1.000					
Lane utilization adjustment factor, f_{LU}	1.000	1.000	0.950	0.950			0.950					
Left-turn adjustment factor, f_{LT}	0.950	0.149	1.000	1.000			0.998					
Right-turn adjustment factor, f_{RT}	1.000	1.000	1.000	0.981			0.996					
Left-turn ped/bike adjustment factor, f_{Lpb}	1.000	0.999	1.000	1.000			0.998					
Right-turn ped/bike adjustment factor, f_{Rpb}	1.000	1.000	1.000	0.992			0.998					
Adjusted saturation flow, s (veh/h)	1641	257	3150	3066			3074					
$s = s_0 N f_w f_{HV} f_g f_p f_{bb} f_a f_{LU} f_{LT} f_{RT} f_{Lpb} f_{Rpb}$												
Notes												
1. $P_{LT} = 1.000$ for exclusive left-turn lanes, and $P_{RT} = 1.000$ for exclusive right-turn lanes. Otherwise, they are equal to the proportions of turning volumes in the lane group.												

Example Problem 2

SUPPLEMENTAL WORKSHEET FOR PERMITTED LEFT TURNS OPPOSED BY MULTILANE APPROACH				
General Information				
Project Description <u>Example Problem 2</u>				
Input				
	EB	WB	NB	SB
Cycle length, C (s)	70			
Total actual green time for LT lane group, ¹ G (s)	34.6			
Effective permitted green time for LT lane group, ¹ g (s)	27.4			
Opposing effective green time, g _o (s)	23.4			
Number of lanes in LT lane group, ² N	1			
Number of lanes in opposing approach, N _o	2			
Adjusted LT flow rate, v _{LT} (veh/h)	126			
Proportion of LT volume in LT lane group, ³ P _{LT}	1.000			
Adjusted flow rate for opposing approach, v _o (veh/h)	842			
Lost time for LT lane group, t _L	0			
Computation				
LT volume per cycle, LTC = v _{LT} C/3600	2.450			
Opposing lane utilization factor, f _{LUo} (refer to Volume Adjustment and Saturation Flow Rate Worksheet)	0.950			
Opposing flow per lane, per cycle $v_{olc} = \frac{v_o C}{3600 N_o f_{LUo}}$ (veh/C/ln)	8.617			
$g_r = G[e^{-0.882(LTC^{0.77})}] - t_L$ $g_r \leq g$ (except for exclusive left-turn lanes) ^{1, 4}	0			
Opposing platoon ratio, R _{po} (refer to Exhibit 16-11)	1			
Opposing queue ratio, q _{ro} = max[1 - R _{po} (g _o /C), 0]	0.666			
$g_q = \frac{v_{olc} q_{ro}}{0.5 - [v_{olc}(1 - q_{ro})/g_o]} - t_L$, $v_{olc}(1 - q_{ro})/g_o \leq 0.49$ (note case-specific parameters) ¹	15.222			
$g_u = g - g_q$ if $g_q \geq g_r$, or $g_u = g - g_r$ if $g_q < g_r$	12.178			
E _{L1} (refer to Exhibit C16-3)	3.0			
$P_L = P_{LT} \left[1 + \frac{(N-1)g}{(g_r + g_u/E_{L1} + 4.24)} \right]$ (except with multilane subject approach) ⁵	1			
f _{min} = 2(1 + P _L)/g	0.146			
$f_m = [g_r/g] + [g_u/g] \left[\frac{1}{1 + P_L(E_{L1} - 1)} \right]$, (f _{min} ≤ f _m ≤ 1.00)	0.149			
f _{LT} = [f _m + 0.91(N - 1)]/N (except for permitted left turns) ⁶	0.149			
Notes				
<ol style="list-style-type: none"> Refer to Exhibits C16-4, C16-5, C16-6, C16-7, and C16-8 for case-specific parameters and adjustment factors. For exclusive left-turn lanes, N is equal to the number of exclusive left-turn lanes. For shared left-turn lanes, N is equal to the sum of the shared left-turn, through, and shared right-turn (if one exists) lanes in that approach. For exclusive left-turn lanes, P_{LT} = 1. For exclusive left-turn lanes, g_r = 0, and skip the next step. Lost time, t_L, may not be applicable for protected-permitted case. For a multilane subject approach, if P_L ≥ 1 for a left-turn shared lane, then assume it to be a de facto exclusive left-turn lane and redo the calculation. For permitted left turns with multiple exclusive left-turn lanes f_{LT} = f_m. 				









Example Problem 2

SUPPLEMENTAL WORKSHEET FOR PEDESTRIAN-BICYCLE EFFECTS ON PERMITTED LEFT TURNS AND RIGHT TURNS				
General Information				
Project Description <u>Example Problem 2</u>				
Permitted Left Turns				
	EB	WB	NB	SB
Effective pedestrian green time, ^{1,2} g_p (s)	27.4		27.4	
Conflicting pedestrian volume, ¹ v_{ped} (p/h)	50		50	
$v_{pedg} = v_{ped}(C/g_p)$	128		128	
$OCC_{pedg} = v_{pedg}/2000$ if ($v_{pedg} \leq 1000$) or $OCC_{pedg} = 0.4 + v_{pedg}/10,000$ if ($1000 < v_{pedg} \leq 5000$)	0.064		0.064	
Opposing queue clearing green, ^{3,4} g_q (s)	15.222		0	
Effective pedestrian green consumed by opposing vehicle queue, g_q/g_p ; if $g_q \geq g_p$ then $f_{Lpb} = 1.0$	0.556		0	
$OCC_{pedu} = OCC_{pedg} [1 - 0.5(g_q/g_p)]$	0.046		0.064	
Opposing flow rate, ³ v_o (veh/h)	842		0	
$OCC_r = OCC_{pedu} [e^{-(5/3600)v_o}]$	0.014		0.064	
Number of cross-street receiving lanes, ¹ N_{rec}	2		2	
Number of turning lanes, ¹ N_{turn}	1		1	
$A_{pbT} = 1 - OCC_r$ if $N_{rec} = N_{turn}$ $A_{pbT} = 1 - 0.6(OCC_r)$ if $N_{rec} > N_{turn}$	0.992		0.962	
Proportion of left turns, ⁵ P_{LT}	1.000		0.047	
Proportion of left turns using protected phase, ⁶ P_{LTA}	0.896		0	
$f_{Lpb} = 1.0 - P_{LT}(1 - A_{pbT})(1 - P_{LTA})$	0.999		0.998	
Permitted Right Turns				
Effective pedestrian green time, ^{1,2} g_p (s)		27.4	27.4	
Conflicting pedestrian volume, ¹ v_{ped} (p/h)		50	50	
Conflicting bicycle volume, ^{1,7} v_{bic} (bicycles/h)		20	20	
$v_{pedg} = v_{ped}(C/g_p)$		150	128	
$OCC_{pedg} = v_{pedg}/2000$ if ($v_{pedg} \leq 1000$), or $OCC_{pedg} = 0.4 + v_{pedg}/10,000$ if ($1000 < v_{pedg} \leq 5000$)		0.075	0.064	
Effective green, ¹ g (s)		23.4	27.4	
$v_{bicg} = v_{bic}(C/g)$		60	51	
$OCC_{bicg} = 0.02 + v_{bicg}/2700$		0.042	0.039	
$OCC_r = OCC_{pedg} + OCC_{bicg} - (OCC_{pedg})(OCC_{bicg})$		0.114	0.101	
Number of cross-street receiving lanes, ¹ N_{rec}		2	2	
Number of turning lanes, ¹ N_{turn}		1	1	
$A_{pbT} = 1 - OCC_r$ if $N_{rec} = N_{turn}$ $A_{pbT} = 1 - 0.6(OCC_r)$ if $N_{rec} > N_{turn}$		0.932	0.939	
Proportion of right turns, ⁵ P_{RT}		0.125	0.029	
Proportion of right turns using protected phase, ⁸ P_{RTA}		0	0	
$f_{Rpb} = 1.0 - P_{RT}(1 - A_{pbT})(1 - P_{RTA})$		0.992	0.998	
Notes				
<ol style="list-style-type: none"> 1. Refer to Input Worksheet. 2. If intersection signal timing is given, use Walk + flashing Don't Walk (use G + Y if no pedestrian signals). If signal timing must be estimated, use (Green Time - Lost Time per Phase) from Quick Estimation Control Delay and LOS Worksheet. 3. Refer to supplemental worksheets for left turns. 4. If unopposed left turn, then $g_q = 0$, $v_o = 0$, and $OCC_r = OCC_{pedu} = OCC_{pedg}$. 5. Refer to Volume Adjustment and Saturation Flow Rate Worksheet. 6. Ideally determined from field data; alternatively, assume it equal to $(1 - \text{permitted phase } f_{LT})/0.95$. 7. If $v_{bic} = 0$ then $v_{bicg} = 0$, $OCC_{bicg} = 0$, and $OCC_r = OCC_{pedg}$. 8. P_{RTA} is the proportion of protected green over the total green, $g_{prot}/(g_{prot} + g_{perm})$. If only permitted right-turn phase exists, then $P_{RTA} = 0$. 				

Example Problem 2

SUPPLEMENTAL UNIFORM DELAY WORKSHEET FOR LEFT TURNS FROM EXCLUSIVE LANES WITH PROTECTED AND PERMITTED PHASES					
General Information					
Project Description <u>Example Problem 2</u>					
v/c Ratio Computation					
	EB	WB	NB	SB	
Cycle length, C (s)	70.0				
Protected phase eff. green interval, g (s)	7.2				
Opposing queue effective green interval, g _q (s)	15.222				
Unopposed green interval, g _u (s)	12.178				
Red time, r (s) r = C - g - g _q - g _u	35.400				
Arrival rate, q _a (veh/s) q _a = $\frac{v}{3600 * \max[X, 1.0]}$	0.035				
Protected phase departure rate, s _p (veh/s) s _p = $\frac{s}{3600}$	0.456				
Permitted phase departure rate, s _s (veh/s) s _s = $\frac{s(g_q + g_u)}{(g_u * 3600)}$	0.161				
If leading left (protected + permitted) v/c ratio, X _{perm} = $\frac{q_a(g_q + g_u)}{s_s g_u}$ If lagging left (permitted + protected) v/c ratio, X _{perm} = $\frac{q_a(r + g_q + g_u)}{s_s g_u}$	0.489				
If leading left (protected + permitted) v/c ratio, X _{prot} = $\frac{q_a(r + g)}{s_p g}$ If lagging left (permitted + protected) v/c ratio, X _{prot} is N/A	0.454				
Uniform Queue Size and Delay Computations					
Queue at beginning of green arrow, Q _a	1.239				
Queue at beginning of unsaturated green, Q _u	0.533				
Residual queue, Q _r	0				
Uniform delay, d ₁	11.811				
Uniform Queue Size and Delay Equations					
	Case	Q _a	Q _u	Q _r	d ₁
If X _{perm} ≤ 1.0 & X _{prot} ≤ 1.0	1	q _a r	q _a g _q	0	$[0.50/(q_a C)][rQ_a + Q_a^2/(s_p - q_a) + q_q Q_u + Q_u^2/(s_s - q_a)]$
If X _{perm} ≤ 1.0 & X _{prot} > 1.0	2	q _a r	Q _r + q _a g _q	Q _a - g(s _p - q _a)	$[0.50/(q_a C)][rQ_a + g(Q_a + Q_r) + q_q(Q_r + Q_u) + Q_u^2/(s_s - q_a)]$
If X _{perm} > 1.0 & X _{prot} ≤ 1.0	3	Q _r + q _a r	q _a g _q	Q _u - g _u (s _s - q _a)	$[0.50/(q_a C)][g Q_u + q_q(Q_u + Q_r) + r(Q_r + Q_a) + Q_a^2/(s_p - q_a)]$
If X _{perm} ≤ 1.0 (lagging lefts)	4	0	q _a (r + g _q)	0	$[0.50/(q_a C)][(r + g_q)Q_u + Q_u^2/(s_s - q_a)]$
If X _{perm} > 1.0 (lagging lefts)	5	Q _u - g _u (s _s - q _a)	q _a (r + g _q)	0	$[0.50/(q_a C)][(r + g_q)Q_u + q_q(Q_u + Q_a) + Q_a^2/(s_p - q_a)]$

Example Problem 2

CAPACITY AND LOS WORKSHEET										
General information										
Project Description <i>Example Problem 2</i>										
Capacity Analysis										
Phase number	1	2	1/2	2	3					
Phase type	P	S	P	P	P					
Lane group										
Adjusted flow rate, v (veh/h)	126	0	1032	842	894					
Saturation flow rate, s (veh/h)	1641	257	3150	3066	3090					
Lost time, t _L (s), t _L = l ₁ + Y - e	4	0	4	4	4					
Effective green time, g (s), g = G + Y - t _L	7.2	27.4	34.6	23.4	27.4					
Green ratio, g/C	0.103	0.391	0.494	0.334	0.391					
Lane group capacity, ¹ c = s(g/C), (veh/h)	169	100	1556	1024	1208					
v/c ratio, X	0.746	0.000	0.663	0.822	0.740					
Flow ratio, v/s	0.077	0.000	0.328	0.275	0.289					
Critical lane group/phase (√)	√			√	√					
Sum of flow ratios for critical lane groups, Y _c Y _c = Σ (critical lane groups, v/s)	0.641									
Total lost time per cycle, L (s)	12									
Critical flow ratio to capacity ratio, X _c X _c = (Y _c)(C)/(C - L)	0.774									
Lane Group Capacity, Control Delay, and LOS Determination										
		EB		WB		NB		SB		
Lane group										
Adjusted flow rate, ² v (veh/h)	126	1032		842		894				
Lane group capacity, ² c (veh/h)	269	1556		1024		1208				
v/c ratio, ² X = v/c	0.468	0.663		0.822		0.740				
Total green ratio, ² g/C	0.494	0.494		0.334		0.391				
Uniform delay, d ₁ = $\frac{0.50 C [1 - (g/C)]^2}{1 - \min(1, X)g/C}$ (s/veh)	11.811	13.326		21.400		18.266				
Incremental delay calibration, ³ k	0.500	0.500		0.500		0.500				
Incremental delay, ⁴ d ₂ d ₂ = 900T[(X - 1) + √((X - 1) ² + $\frac{8kIX}{cT}$)] (s/veh)	5.748	2.243		7.429		4.097				
Initial queue delay, d ₃ (s/veh) (Appendix F)	0	0		0		0				
Uniform delay, d ₁ (s/veh) (Appendix F)										
Progression adjustment factor, PF	1.000	1.000		1.000		1.000				
Delay, d = d ₁ (PF) + d ₂ + d ₃ (s/veh)	17.6	15.6		28.8		22.4				
LOS by lane group (Exhibit 16-2)	B	B		C		C				
Delay by approach, d _A = $\frac{\sum(d)(v)}{\sum v}$ (s/veh)	15.8			28.8		22.4				
LOS by approach (Exhibit 16-2)	B			C		C				
Approach flow rate, v _A (veh/h)	1158			842		894				
Intersection delay, d _I = $\frac{\sum(d_A)(v_A)}{\sum v_A}$ (s/veh)	21.6			Intersection LOS (Exhibit 16-2)						C
Notes										
1. For permitted left turns, the minimum capacity is (1 + P _L)(3600/C).										
2. Primary and secondary phase parameters are summed to obtain lane group parameters.										
3. For pretimed or nonactuated signals, k = 0.5. Otherwise, refer to Exhibit 16-13.										
4. T = analysis duration (h); typically T = 0.25, which is for the analysis duration of 15 min.										
I = upstream filtering metering adjustment factor; I = 1 for isolated intersections.										

EXAMPLE PROBLEM 3

The Intersection The intersection of Fifth Avenue (NB/SB) and Twelfth Street (EB/WB) is a major CBD junction of two urban streets.

The Question What are the delay and LOS during the peak hour for lane groups, approaches, and the intersection as a whole?

The Facts

- √ Twelfth Street HV = 5 percent,
- √ Fifth Avenue HV = 2 percent,
- √ Twelfth Street PHF = 0.85,
- √ Fifth Avenue PHF = 0.90,
- √ Actuated signal,
- √ Yellow = 4.0 s,
- √ Level terrain,
- √ 3.0-m lane widths for EB/WB,
- √ Pedestrian signals exist,
- √ 3.6-m lane widths for NB/SB,
- √ Fifth Avenue is a four-lane street,
- √ Twelfth Street is a four-lane street,
- √ Twelfth Street parking, 5 maneuvers/h,
- √ Twelfth Street pedestrian volume = 120 p/h,
- √ Fifth Avenue pedestrian volume = 40 p/h,
- √ Movement lost time = 4 s,
- √ Arrival Type 3,
- √ No bicycles, and
- √ No buses.

Comments

- √ Assume crosswalk width = 3.0 m for all approaches,
- √ Assume base saturation flow rate = 1,900 pc/h/ln,
- √ Assume $E_T = 2.0$,
- √ No overlaps in signal phasing,
- √ 90.0-s cycle length, with green times given, and
- √ Assume a unit extension of 2.5 s for all phases.

Steps

1. Pedestrians/cycle.	$120 \frac{p}{h} * \frac{1h}{3,600 s} * 90.0 s = 3 p \text{ (12th St.)}$ $40 \frac{p}{h} * \frac{1h}{3,600 s} * 90.0 s = 1 p \text{ (5th Ave.)}$
2. Minimum effective green time required for pedestrians (use Equation 16-2).	$G_p = 3.2 + \frac{L}{S_p} + 0.27N_{ped} \text{ (for } W_E \leq 3.0 \text{ m)}$ $G_p \text{ (12th)} = 3.2 + \frac{18.0}{1.2} + 0.27(3) = 19.0 \text{ s}$ $G_p \text{ (5th)} = 3.2 + \frac{21.0}{1.2} + 0.27(1) = 21.0 \text{ s}$
3. Compare minimum effective green time required for pedestrians with actual effective green.	$g(12th) = 19.2 \text{ s, which is } > 19.0 \text{ s}$ $g(5th) = 50.7 \text{ s, which is } > 21.0 \text{ s}$
4. Proportion of left turns and right turns.	Proportions of left- and right-turn traffic are found by dividing the appropriate turning flow rates by the total lane group flow rate. P_{LT} for exclusive LT lane is 1.000
5. Lane width adjustment factor (use Exhibit 16-7).	$f_w = 1 + \frac{(W - 3.6)}{9}$ $f_w(NB / SB) = 1 + \frac{(3.6 - 3.6)}{9} = 1.000$ $f_w(EB / WB) = 1 + \frac{(3.0 - 3.6)}{9} = 0.933$

6. Heavy-vehicle adjustment factor (use Exhibit 16-7).	$f_{HV} = \frac{100}{100 + \% HV(E_T - 1)}$ $f_{HV}(NB / SB) = \frac{100}{100 + 2(2.0 - 1)} = 0.980$ $f_{HV}(EB / WB) = \frac{100}{100 + 5(2.0 - 1)} = 0.952$
7. Percent grade adjustment factor (use Exhibit 16-7).	0% grade, $f_g = 1.000$
8. Parking adjustment factor (use Exhibit 16-7).	$f_p = \frac{N - 0.1 - \frac{18N_m}{3600}}{N}$ $f_p = 0.938$ for EB and WB through/right lane groups
9. Bus blockage adjustment factor (use Exhibit 16-7).	No bus stopping, $f_{bb} = 1.000$
10. Area type adjustment factor (use Exhibit 16-7).	For CBD, $f_a = 0.900$
11. Lane utilization adjustment factor (use Exhibit 10-23).	No specific data are given. Use default of $f_{LU} = 1.000$ for exclusive LT. Use 0.950 for shared LT.
12. Left-turn adjustment factor.	The left turn is permitted. A special procedure is used. All approaches are opposed by multilane approaches. The supplemental worksheet for multilane approaches is used to determine the factor.
13. Right-turn adjustment factor.	For all shared-lane approaches: $f_{RT} = 1.0 - 0.150P_{RT}$ Where P_{RT} is the proportion of right turns in lane group, $f_{RT}(EB) = 1.0 - 0.150(0.250) = 0.963$
14. Left-turn pedestrian/bicycle adjustment factor.	Supplemental worksheet for pedestrian-bicycle effects is used to determine the factor.
15. Right-turn pedestrian/bicycle adjustment factor.	Supplemental worksheet for pedestrian-bicycle effects is used to determine the factor.
16. Saturation flow.	$s = s_o N f_w f_{HV} f_g f_p f_{bb} f_{LU} f_a f_{LT} f_{RT} f_{Lpb} f_{Rpb}$ $s(EBTHRT) = 1900 * 2 * 0.933 * 0.952 * 1.000 * 0.938 * 1.000 * 0.900 * 0.950 * 1.000 * 0.963 * 1.000 * 0.958 = 2497 \text{ veh/h}$
17. Lane group capacity.	$c = s(g/C)$ $c(EBTHRT) = 2497(0.213) = 532 \text{ veh/h}$
18. v/c ratio.	$v/c(EB) = \frac{424}{532} = 0.797$
19. Determine critical lane group in each timing phase.	Critical lane groups: Phase 1: SB protected left turn Phase 2: NB through + right Phase 3: WB left turn
20. Flow ratio of critical lane groups.	$v/s(SBLT) = \frac{143}{1592} = 0.090$ $v/s(NBTHRT) = \frac{1733}{3155} = 0.549$ $v/s(WBLT) = \frac{118}{480} = 0.246$
21. Sum of critical lane group v/s ratios.	$Y_c = 0.090 + 0.549 + 0.246 = 0.885$

22. Critical flow rate to capacity ratio.	$X_c = \frac{Y_c * C}{C - L}$ $X_c = \frac{0.885(90.0)}{90.0 - 12} = 1.021$
23. Uniform delay.	$d_1 = \frac{0.50C \left(1 - \frac{g}{C}\right)^2}{1 - \left[\min(1, X) \frac{g}{C}\right]}$ $d_1(\text{EBLT}) = \frac{0.50(90.0)(1 - 0.213)^2}{1 - (0.213)(1.0)} = 35.415 \text{ s/veh}$ <p>Since NB and SB left turns are contained in two phases, a supplemental uniform delay worksheet is used.</p>
24. Incremental delay.	$d_2 = 900T \left[(X - 1) + \sqrt{(\dots)} \right]$ $d_2(\text{EBLT}) = 900(0.25) \left[(1.109 - 1) + \sqrt{(\dots)} \right] = 145.509 \text{ s/veh}$
25. Progression adjustment factor (use Exhibit 16-12).	PF = 1.000
26. Lane group delay.	$d = d_1 PF + d_2 + d_3$ (d_3 is assumed to be 0 for the first iteration) $d(\text{EBLT}) = 34.415(1.000) + 145.509 = 180.9 \text{ s/veh}$
27. Approach delay.	$d_A = \frac{\sum(d)(v)}{\sum v}$ $d_A(\text{EB}) = \frac{(180.9 * 71) + (41.6 * 424)}{(71 + 424)} = 61.6 \text{ s/veh}$
28. Intersection delay.	$d_I = \frac{\sum(d_A)(v_A)}{\sum v_A}$ $d_I = \frac{(495 * 61.6) + (742 * 113.0) + (1866 * 33.0) + (1205 * 20.6)}{(495 + 742 + 1866 + 1205)} = 46.6 \text{ s/veh}$
29. LOS by lane group, approach, and intersection.	LOS (EBLT) = F LOS (EB) = E LOS Intersection = D

The calculation results are summarized as follows.

Direction/ LnGrp	v/c Ratio	g/C Ratio	Unif Delay d_1	Progr Factor PF	Lane Grp Cap	Cal Term k	Incr Delay d_2	Lane Grp Delay	Lane Grp LOS	Delay by App	LOS by App
EB/L	1.109	0.213	35.415	1.000	64	0.500	145.509	180.9	F		E
EB/TR	0.797	0.213	33.571	1.000	532	0.329	8.034	41.6	D	61.6	
WB/L	1.157	0.213	33.415	1.000	102	0.500	137.481	172.9	F		
WB/TR	1.095	0.213	35.415	1.000	570	0.500	66.241	101.7	F	113.0	F
NB/L	0.383	0.698	6.582	1.000	347	0.080	0.514	7.1	A		
NB/TR	0.976	0.563	19.075	1.000	1776	0.480	15.966	35.0	C	33.0	C
SB/L	0.894	0.698	25.957	1.000	217	0.411	33.699	59.7	E		
SB/TR	0.572	0.563	12.676	1.000	1768	0.140	0.380	13.1	B	20.6	C
			Intersection Delay = 46.6 s/veh				Intersection LOS = D				

Alternatives

As shown in the results, the v/c ratios for critical groups are not balanced. As a result, certain lane groups experience high delay, whereas others experience little delay. Reallocation of green times is needed.

Volume to capacity ratios for EB and WB lane groups are greater than those for NB and SB lane groups. The result is higher delay for EB and WB. The performance of EB and WB lane groups could be improved by assigning more green time, so 4.0 s is reallocated to the east-west phase from the north-south through phase. The resulting phase times are as follows:

- Phase 1 (NB/SB LT): 8.1 s,
- Phase 4 (NB/SB TH+RT): 46.7 s, and
- Phase 5 (EB/WB TH+RT): 23.2 s.

The intersection performance is reassessed, and the results are as follows.

Direction/ LnGrp	v/c Ratio	g/C Ratio	Unif Delay d ₁	Progr Factor PF	Lane Grp Cap	Cal Term k	Incr Delay d ₂	Lane Grp Delay	Lane Grp LOS	Delay by App	LOS by App
EB/L	0.855	0.258	31.787	1.000	83	0.500	64.372	96.2	F		
EB/TR	0.653	0.258	29.795	1.000	649	0.329	3.362	33.2	C	42.2	D
WB/L	0.843	0.258	31.662	1.000	140	0.500	42.939	74.6	E		
WB/TR	0.903	0.258	32.301	1.000	691	0.500	17.352	49.7	D	53.7	D
NB/L	0.422	0.653	8.447	1.000	315	0.080	0.666	9.1	A		
NB/TR	1.059	0.519	21.645	1.000	1637	0.480	39.338	61.0	E	57.3	E
SB/L	0.894	0.653	25.886	1.000	217	0.411	33.699	59.6	E		
SB/TR	0.620	0.519	15.351	1.000	1630	0.140	0.504	15.9	B	22.9	C
Intersection Delay = 45.3 s/veh						Intersection LOS = D					

The intersection performance has improved, with delay reduced from 46.6 s/veh to 45.3 s/veh.

Volume to capacity ratios for critical lane groups are high. Although the intersection performance could still be improved by reallocating green times, delay reduction will be minimal because the critical elements are close to capacity. Consideration should be given to physical improvements to further optimize intersection operation.

Example Problem 3

INPUT WORKSHEET												
General Information						Site Information						
Analyst <u>RPR</u>						Intersection <u>5th Avenue/12th Street</u>						
Agency or Company <u>PTU</u>						Area Type <input checked="" type="checkbox"/> CBD <input type="checkbox"/> Other						
Date Performed <u>4/12/99</u>						Jurisdiction _____						
Analysis Time Period <u>5-6 PM</u>						Analysis Year <u>1999</u>						
Intersection Geometry												
Volume and Timing Input												
	EB			WB			NB			SB		
	LT	TH	RT ¹	LT	TH	RT ¹	LT	TH	RT ¹	LT	TH	RT ¹
Volume, V (veh/h)	60	270	90	100	510	20	120	1480	80	175	840	70
% heavy vehicles, % HV	5			5			2			2		
Peak-hour factor, PHF	0.85			0.85			0.90			0.90		
Pretimed (P) or actuated (A)	A			A			A			A		
Start-up lost time, I ₁ (s)												
Extension of effective green time, e (s)												
Arrival type, AT	3			3			3			3		
Approach pedestrian volume, ² v _{ped} (p/h)	120			120			40			40		
Approach bicycle volume, ² v _{bic} (bicycles/h)	0			0			0			0		
Parking (Y or N)	Y			Y			N			N		
Parking maneuvers, N _m (maneuvers/h)	5			5			0			0		
Bus stopping, N _B (buses/h)	0			0			0			0		
Min. timing for pedestrians, ³ G _p (s)	19.0			19.0			21.0			21.0		
Signal Phasing Plan												
D I A G R A M	Ø1 	Ø2 	Ø3 	Ø4 	Ø5 	Ø6	Ø7	Ø8				
Timing	G = 8.1 Y = 4.0	G = 0.0 Y = 0.0	G = 0.0 Y = 0.0	G = 50.7 Y = 4.0	G = 19.2 Y = 4.0	G = Y =	G = Y =	G = Y =				
Protected turns			Permitted turns Pedestrian			Cycle length, C = <u>90.0</u> s						
Notes												
1. RT volumes, as shown, exclude RTOR. 2. Approach pedestrian and bicycle volumes are those that conflict with right turns from the subject approach. 3. Refer to Equation 16-2.												









Example Problem 3

VOLUME ADJUSTMENT AND SATURATION FLOW RATE WORKSHEET												
General Information												
Project Description <i>Example Problem 3</i>												
Volume Adjustment												
	EB			WB			NB			SB		
	LT	TH	RT	LT	TH	RT	LT	TH	RT	LT	TH	RT
Volume, V (veh/h)	60	270	90	100	510	20	120	1480	80	175	840	70
Peak-hour factor, PHF	0.85			0.85			0.90			0.90		
Adjusted flow rate, $v_p = V/PHF$ (veh/h)	71	318	106	118	600	24	133	1644	89	194	933	78
Lane group												
Adjusted flow rate in lane group, v (veh/h)	71	424		118	624		133		1733	194		1011
Proportion ¹ of LT or RT (P_{LT} or P_{RT})	1.000	-	0.250	1.000	-	0.038	1.000	-	0.051	1.000	-	0.077
Saturation Flow Rate (see Exhibit 16-7 to determine adjustment factors)												
Base saturation flow, s_0 (pc/h/ln)	1900	1900		1900	1900		1900	1900	1900	1900	1900	1900
Number of lanes, N	1	2		1	2		1	1	2	1	1	2
Lane width adjustment factor, f_w	0.933	0.933		0.933	0.933		1.000	1.000	1.000	1.000	1.000	1.000
Heavy-vehicle adjustment factor, f_{HV}	0.952	0.952		0.952	0.952		0.980	0.980	0.980	0.980	0.980	0.980
Grade adjustment factor, f_g	1.000	1.000		1.000	1.000		1.000	1.000	1.000	1.000	1.000	1.000
Parking adjustment factor, f_p	1.000	0.938		1.000	0.938		1.000	1.000	1.000	1.000	1.000	1.000
Bus blockage adjustment factor, f_{bb}	1.000	1.000		1.000	1.000		1.000	1.000	1.000	1.000	1.000	1.000
Area type adjustment factor, f_a	0.900	0.900		0.900	0.900		0.900	0.900	0.900	0.900	0.900	0.900
Lane utilization adjustment factor, f_{LU}	1.000	0.950		1.000	0.950		1.000	1.000	0.950	1.000	1.000	0.950
Left-turn adjustment factor, f_{LT}	0.208	1.000		0.343	1.000		0.950	0.200	1.000	0.950	0.073	1.000
Right-turn adjustment factor, f_{RT}	1.000	0.963		1.000	0.994		1.000	1.000	0.992	1.000	1.000	0.988
Left-turn ped/bike adjustment factor, f_{Lpb}	0.951	1.000		0.921	1.000		1.000	0.999	1.000	1.000	1.000	1.000
Right-turn ped/bike adjustment factor, f_{Rpb}	1.000	0.958		1.000	0.994		1.000	1.000	0.999	1.000	1.000	0.998
Adjusted saturation flow, s (veh/h)	300	2497		480	2675		1592	335	3155	1592	122	3140
$s = s_0 N f_w f_{HV} f_g f_p f_{bb} f_a f_{LU} f_{LT} f_{RT} f_{Lpb} f_{Rpb}$												
Notes												
1. $P_{LT} = 1.000$ for exclusive left-turn lanes, and $P_{RT} = 1.000$ for exclusive right-turn lanes. Otherwise, they are equal to the proportions of turning volumes in the lane group.												

Example Problem 3

SUPPLEMENTAL WORKSHEET FOR PERMITTED LEFT TURNS OPPOSED BY MULTILANE APPROACH				
General Information				
Project Description <u>Example Problem 3</u>				
Input				
	EB	WB	NB	SB
Cycle length, C (s)	90.0			
Total actual green time for LT lane group, ¹ G (s)	19.2	19.2	62.8	62.8
Effective permitted green time for LT lane group, ¹ g (s)	19.2	19.2	54.7	54.7
Opposing effective green time, g _o (s)	19.2	19.2	50.7	50.7
Number of lanes in LT lane group, ² N	1	1	1	1
Number of lanes in opposing approach, N _o	2	2	2	2
Adjusted LT flow rate, v _{LT} (veh/h)	71	118	133	194
Proportion of LT volume in LT lane group, ³ P _{LT}	1.000	1.000	1.000	1.000
Adjusted flow rate for opposing approach, v _o (veh/h)	624	424	1011	1733
Lost time for LT lane group, t _L	4	4	0	0
Computation				
LT volume per cycle, LTC = v _{LT} C/3600	1.775	2.950	3.325	4.850
Opposing lane utilization factor, f _{LUo} (refer to Volume Adjustment and Saturation Flow Rate Worksheet)	0.950	0.950	0.950	0.950
Opposing flow per lane, per cycle $v_{oic} = \frac{v_o C}{3600 N_o f_{LUo}}$ (veh/C/ln)	8.211	5.579	13.303	22.803
$g_r = G[e^{-0.882(LTC^{0.717})}] - t_L$, $g_r \leq g$ (except for exclusive left-turn lanes) ^{1, 4}	0	0	0	0
Opposing platoon ratio, R _{po} (refer to Exhibit 16-11)	1.00	1.00	1.00	1.00
Opposing queue ratio, q _{ro} = max[1 - R _{po} (g _o /C), 0]	0.787	0.787	0.437	0.437
$g_q = \frac{v_{oic} q_{ro}}{0.5 - [v_{oic}(1 - q_{ro})/g_o]} - t_L$, $v_{oic}(1 - q_{ro})/g_o \leq 0.49$ (note case-specific parameters) ¹	11.803	6.022	16.502	40.379
$g_u = g - g_q$ if $g_q \geq g_r$, or $g_u = g - g_r$ if $g_q < g_r$	7.397	13.178	38.198	14.321
E _{L1} (refer to Exhibit C16-3)	2.4	2.0	3.5	7.314
$P_L = P_{LT} \left[1 + \frac{(N-1)g}{(g_r + g_u/E_{L1} + 4.24)} \right]$ (except with multilane subject approach) ⁵	1.000	1.000	1.000	1.000
f _{min} = 2(1 + P _L)/g	0.208	0.208	0.073	0.073
f _m = [g _r /g] + [g _u /g] $\left[\frac{1}{1 + P_L(E_{L1} - 1)} \right]$, (f _{min} ≤ f _m ≤ 1.00)	0.208	0.343	0.200	0.073
f _{LT} = [f _m + 0.91(N - 1)]/N (except for permitted left turns) ⁶	0.208	0.343	0.200	0.073
Notes				
<ol style="list-style-type: none"> Refer to Exhibits C16-4, C16-5, C16-6, C16-7, and C16-8 for case-specific parameters and adjustment factors. For exclusive left-turn lanes, N is equal to the number of exclusive left-turn lanes. For shared left-turn lanes, N is equal to the sum of the shared left-turn, through, and shared right-turn (if one exists) lanes in that approach. For exclusive left-turn lanes, P_{LT} = 1. For exclusive left-turn lanes, g_r = 0, and skip the next step. Lost time, t_L, may not be applicable for protected-permitted case. For a multilane subject approach, if P_L ≥ 1 for a left-turn shared lane, then assume it to be a de facto exclusive left-turn lane and redo the calculation. For permitted left turns with multiple exclusive left-turn lanes f_{LT} = f_m. 				

Example Problem 3

SUPPLEMENTAL WORKSHEET FOR PEDESTRIAN-BICYCLE EFFECTS ON PERMITTED LEFT TURNS AND RIGHT TURNS				
General Information				
Project Description <i>Example Problem 3</i>				
Permitted Left Turns				
	EB 	WB 	NB 	SB 
Effective pedestrian green time, ^{1,2} g_p (s)	19.2	19.2	50.7	50.7
Conflicting pedestrian volume, ¹ v_{ped} (p/h)	120	120	40	40
$v_{pedg} = v_{ped}(C/g_p)$	563	563	71	71
$OCC_{pedg} = v_{pedg}/2000$ if ($v_{pedg} \leq 1000$) or $OCC_{pedg} = 0.4 + v_{pedg}/10,000$ if ($1000 < v_{pedg} \leq 5000$)	0.282	0.282	0.036	0.036
Opposing queue clearing green, ^{3,4} g_q (s)	11.803	6.022	16.502	40.379
Effective pedestrian green consumed by opposing vehicle queue, g_q/g_p ; if $g_q \geq g_p$ then $f_{Lpb} = 1.0$	0.615	0.314	0.325	0.796
$OCC_{pedu} = OCC_{pedg} [1 - 0.5(g_q/g_p)]$	0.195	0.238	0.030	0.022
Opposing flow rate, ³ v_o (veh/h)	624	424	1011	1733
$OCC_r = OCC_{pedu} [e^{-(5/3600)v_o}]$	0.082	0.132	0.007	0.002
Number of cross-street receiving lanes, ¹ N_{rec}	2	2	2	2
Number of turning lanes, ¹ N_{turn}	1	1	1	1
$A_{pbT} = 1 - OCC_r$ if $N_{rec} = N_{turn}$ $A_{pbT} = 1 - 0.6(OCC_r)$ if $N_{rec} > N_{turn}$	0.951	0.921	0.996	0.999
Proportion of left turns, ⁵ P_{LT}	1.000	1.000	1.000	1.000
Proportion of left turns using protected phase, ⁶ P_{LTA}	0	0	0.842	0.976
$f_{Lpb} = 1.0 - P_{LT}(1 - A_{pbT})(1 - P_{LTA})$	0.951	0.921	0.999	1.000
Permitted Right Turns				
				
Effective pedestrian green time, ^{1,2} g_p (s)	19.2	19.2	50.7	50.7
Conflicting pedestrian volume, ¹ v_{ped} (p/h)	120	120	40	40
Conflicting bicycle volume, ^{1,7} v_{bic} (bicycles/h)	0	0	0	0
$v_{pedg} = v_{ped}(C/g_p)$	563	563	71	71
$OCC_{pedg} = v_{pedg}/2000$ if ($v_{pedg} \leq 1000$), or $OCC_{pedg} = 0.4 + v_{pedg}/10,000$ if ($1000 < v_{pedg} \leq 5000$)	0.282	0.282	0.036	0.036
Effective green, ¹ g (s)	19.2	19.2	50.7	50.7
$v_{bicg} = v_{bic}(C/g)$	0	0	0	0
$OCC_{bicg} = 0.02 + v_{bicg}/2700$	0	0	0	0
$OCC_r = OCC_{pedg} + OCC_{bicg} - (OCC_{pedg})(OCC_{bicg})$	0.282	0.282	0.036	0.036
Number of cross-street receiving lanes, ¹ N_{rec}	2	2	2	2
Number of turning lanes, ¹ N_{turn}	1	1	1	1
$A_{pbT} = 1 - OCC_r$ if $N_{rec} = N_{turn}$ $A_{pbT} = 1 - 0.6(OCC_r)$ if $N_{rec} > N_{turn}$	0.831	0.831	0.978	0.978
Proportion of right turns, ⁵ P_{RT}	0.250	0.038	0.051	0.077
Proportion of right turns using protected phase, ⁸ P_{RTA}	0	0	0	0
$f_{Rpb} = 1.0 - P_{RT}(1 - A_{pbT})(1 - P_{RTA})$	0.958	0.994	0.999	0.998
Notes				
1. Refer to Input Worksheet. 2. If intersection signal timing is given, use Walk + flashing Don't Walk (use G + Y if no pedestrian signals). If signal timing must be estimated, use (Green Time - Lost Time per Phase) from Quick Estimation Control Delay and LOS Worksheet. 3. Refer to supplemental worksheets for left turns. 4. If unopposed left turn, then $g_q = 0$, $v_o = 0$, and $OCC_r = OCC_{pedu} = OCC_{pedg}$. 5. Refer to Volume Adjustment and Saturation Flow Rate Worksheet. 6. Ideally determined from field data; alternatively, assume it equal to $(1 - \text{permitted phase } f_{LT})/0.95$. 7. If $v_{bic} = 0$ then $v_{bicg} = 0$, $OCC_{bicg} = 0$, and $OCC_r = OCC_{pedg}$. 8. P_{RTA} is the proportion of protected green over the total green, $g_{prot}/(g_{prot} + g_{perm})$. If only permitted right-turn phase exists, then $P_{RTA} = 0$.				

Example Problem 3

SUPPLEMENTAL UNIFORM DELAY WORKSHEET FOR LEFT TURNS FROM EXCLUSIVE LANES WITH PROTECTED AND PERMITTED PHASES					
General Information					
Project Description <u>Example Problem 3</u>					
v/c Ratio Computation					
	EB	WB	NB	SB	
Cycle length, C (s)	90.0				
Protected phase eff. green interval, g (s)			8.1	8.1	
Opposing queue effective green interval, g _q (s)			16.502	40.379	
Unopposed green interval, g _u (s)			38.198	14.321	
Red time, r (s) r = C - g - g _q - g _u			27.200	27.200	
Arrival rate, q _a (veh/s) q _a = $\frac{v}{3600 \cdot \max[X, 1.0]}$			0.037	0.054	
Protected phase departure rate, s _p (veh/s) s _p = $\frac{s}{3600}$			0.442	0.442	
Permitted phase departure rate, s _s (veh/s) s _s = $\frac{s(g_q + g_u)}{(g_u \cdot 3600)}$			0.133	0.129	
If leading left (protected + permitted) v/c ratio, X _{perm} = $\frac{q_a(g_q + g_u)}{s_s g_u}$ If lagging left (permitted + protected) v/c ratio, X _{perm} = $\frac{q_a(r + g_q + g_u)}{s_s g_u}$			0.398	1.599	
If leading left (protected + permitted) v/c ratio, X _{prot} = $\frac{q_a(r + g)}{s_p g}$ If lagging left (permitted + protected) v/c ratio, X _{prot} is N/A			0.365	0.532	
Uniform Queue Size and Delay Computations					
Queue at beginning of green arrow, Q _a			1.006	2.575	
Queue at beginning of unsaturated green, Q _u			0.611	2.180	
Residual queue, Q _r			0	1.106	
Uniform delay, d ₁			6.582	25.957	
Uniform Queue Size and Delay Equations					
	Case	Q _a	Q _u	Q _r	d ₁
If X _{perm} ≤ 1.0 & X _{prot} ≤ 1.0	1	q _a r	q _a g _q	0	$[0.50/(q_a C)] [rQ_a + Q_a^2/(s_p - q_a) + g_q Q_u + Q_u^2/(s_s - q_a)]$
If X _{perm} ≤ 1.0 & X _{prot} > 1.0	2	q _a r	Q _r + q _a g _q	Q _a - g(s _p - q _a)	$[0.50/(q_a C)] [rQ_a + g(Q_a + Q_r) + g_q(Q_r + Q_u) + Q_u^2/(s_s - q_a)]$
If X _{perm} > 1.0 & X _{prot} ≤ 1.0	3	Q _r + q _a r	q _a g _q	Q _u - g _u (s _s - q _a)	$[0.50/(q_a C)] [g_q Q_u + q_a(Q_u + Q_r) + r(Q_r + Q_a) + Q_a^2/(s_p - q_a)]$
If X _{perm} ≤ 1.0 (lagging lefts)	4	0	q _a (r + g _q)	0	$[0.50/(q_a C)] [(r + q_a) Q_u + Q_u^2/(s_s - q_a)]$
If X _{perm} > 1.0 (lagging lefts)	5	Q _u - g _u (s _s - q _a)	q _a (r + g _q)	0	$[0.50/(q_a C)] [(r + q_a) Q_u + q_a(Q_u + Q_r) + Q_a^2/(s_p - q_a)]$

Example Problem 3

CAPACITY AND LOS WORKSHEET										
General information										
Project Description <u>Example Problem 3</u>										
Capacity Analysis										
Phase number	1	1	4	4	4	4	5	5	5	5
Phase type										
Lane group										
Adjusted flow rate, v (veh/h)	133	143	0	1733	51	1011	71	424	118	624
Saturation flow rate, s (veh/h)	1592	1592	335	3155	122	3140	300	2497	480	2675
Lost time, t _L (s), t _L = l ₁ + Y - e	4.0	4.0	4.0	4.0	4.0	4.0	4.0	4.0	4.0	4.0
Effective green time, g (s), g = G + Y - t _L	8.1	8.1	54.7	50.7	54.7	50.7	19.2	19.2	19.2	19.2
Green ratio, g/C	0.090	0.090	0.608	0.563	0.608	0.563	0.213	0.213	0.213	0.213
Lane group capacity, ¹ c = s(g/C), (veh/h)	143	143	204	1776	74	1768	64	532	102	570
v/c ratio, X	0.930	1.000	0.000	0.976	0.689	0.572	1.109	0.797	1.157	1.095
Flow ratio, v/s		0.090		0.549					0.246	
Critical lane group/phase (√)		√		√					√	
Sum of flow ratios for critical lane groups, Y _c Y _c = Σ (critical lane groups, v/s)	0.885									
Total lost time per cycle, L (s)	12.0									
Critical flow ratio to capacity ratio, X _c X _c = (Y _c)(C)/(C - L)	1.021									
Lane Group Capacity, Control Delay, and LOS Determination										
	EB		WB		NB		SB			
Lane group										
Adjusted flow rate, ² v (veh/h)	71	424	118	624	133	1733	194	1011		
Lane group capacity, ² c (veh/h)	64	532	102	570	347	1776	217	1768		
v/c ratio, ² X = v/c	1.109	0.797	1.157	1.095	0.383	0.976	0.894	0.572		
Total green ratio, ² g/C	0.213	0.213	0.213	0.213	0.698	0.563	0.698	0.563		
Uniform delay, d ₁ = $\frac{0.50 C [1 - (g/C)]^2}{1 - \min(1, X)g/C}$ (s/veh)	35.415	33.571	33.415	35.415	6.582	19.075	25.957	12.676		
Incremental delay calibration, ³ k	0.500	0.329	0.500	0.500	0.080	0.480	0.411	0.140		
Incremental delay, ⁴ d ₂ d ₂ = $900T[(X - 1) + \sqrt{(X - 1)^2 + \frac{8kIX}{cT}}]$ (s/veh)	145.509	8.034	137.481	66.241	0.514	5.966	33.699	0.380		
Initial queue delay, d ₃ (s/veh) (Appendix F)	0	0	0	0	0	0	0	0		
Uniform delay, d ₁ (s/veh) (Appendix F)										
Progression adjustment factor, PF	1.000	1.000	1.000	1.000	1.000	1.000	1.000	1.000		
Delay, d = d ₁ (PF) + d ₂ + d ₃ (s/veh)	180.9	41.6	172.9	101.7	7.1	35.0	59.7	13.1		
LOS by lane group (Exhibit 16-2)	F	D	F	F	A	C	E	B		
Delay by approach, d _A = $\frac{\sum(d)(v)}{\sum v}$ (s/veh)	61.6		113.0		33.0		20.6			
LOS by approach (Exhibit 16-2)	E		F		C		C			
Approach flow rate, v _A (veh/h)	495		742		1866		1205			
Intersection delay, d _I = $\frac{\sum(d_A)(v_A)}{\sum v_A}$ (s/veh)	46.6		Intersection LOS (Exhibit 16-2)				D			
Notes										
1. For permitted left turns, the minimum capacity is (1 + P _L)(3600/C).										
2. Primary and secondary phase parameters are summed to obtain lane group parameters.										
3. For pretimed or nonactuated signals, k = 0.5. Otherwise, refer to Exhibit 16-13.										
4. T = analysis duration (h); typically T = 0.25, which is for the analysis duration of 15 min.										
I = upstream filtering metering adjustment factor; I = 1 for isolated intersections.										

EXAMPLE PROBLEM 4

The Intersection Tenth Avenue (EB/WB) and First Street (NB/SB) are two-lane streets located in an area with high economic growth. In 20 years, the existing intersection of these two streets is projected to be inadequate as a result of major developments. A proposed geometric improvement and projected volumes are shown on the Input Worksheet.

The Question Is the proposed improvement adequate? If not, what additional improvements are needed?

The Facts

- √ PHF = 0.90,
- √ Cycle length = 90.0 s to 120.0 s, and
- √ Movement lost time = 4 s.

Comments

- √ High left-turn and opposing volumes, therefore protected treatment for left turns is used; and
- √ Protected-plus-permitted treatment is not favorable because of safety concerns and the operation of adjacent intersections.

Steps

1. Lane volume and signal operations worksheets are used.
2. In this analysis, the main interest is to assess the intersection status. The results show the intersection status to be over capacity, with a critical v/c ratio of 1.023. The estimated cycle length is 120.0 s. This result could be interpreted as an uncertain indication that the demand might exceed the capacity, especially since the projections are for 20 years. Long-term projections are often based on coarse assumptions and approximations, and the end results are often not particularly accurate.
3. According to Chapter 10, per-lane volumes are suggested to be kept to 450 veh/h or less in intersection design. Currently, the eastbound approach violates that suggestion.
4. An exclusive right-turn lane is provided for the eastbound approach because of its high volume. The per-lane volumes are brought to below 450 veh/h. The planning method is again used to evaluate the intersection performance.
5. According to the analysis results, the eastbound right turn is now the critical movement, and the intersection v/c ratio has been reduced from 1.023 to 0.999.
6. The signal timing plan synthesized by the planning method for the westbound left turn violates the minimum green time requirement. The violation is overcome by eliminating the eastbound through and left-turn phase and reassigning the green time to the left-turn phase. The new signal timing plan is as follows.

Movement	Phase Time (s)
EB WB LT	12.2
EB WB HT	36.4
NB SB LT	17.7
NB HT LT	4.1
NB SB HT	29.6

7. The operational analysis is performed using default values, and the analysis results are summarized in an exhibit. The intersection operates at LOS D, and the v/c ratios are well balanced.

Results

The intersection performance is adequate assuming that the improvements are implemented.

Example Problem 4

QUICK ESTIMATION INPUT WORKSHEET												
General Information						Site Information						
Analyst	<u>CJM</u>					Intersection	<u>Tenth Ave. and First St.</u>					
Agency or Company	<u>CEI</u>					Area Type	<input type="checkbox"/> CBD	<input checked="" type="checkbox"/> Other				
Date Performed	<u>5/13/99</u>					Jurisdiction	<u>Trenton, NJ</u>					
Analysis Time Period	<u>4:45 - 5:45 pm</u>					Analysis Year	<u>1999</u>					
Intersection Geometry												
Volume and Signal Input												
	EB			WB			NB			SB		
	LT	TH	RT ¹	LT	TH	RT ¹	LT	TH	RT ¹	LT	TH	RT ¹
Volume, V (veh/h)	120	1300	460	80	1200	100	260	700	180	200	550	100
Proportion of LT or RT (P _{LT} or P _{RT}) ²		-			-			-			-	
Parking (Yes/No)	No			No			No			No		
Left-turn treatment (permitted, protected, not opposed) (if known)	Protected			Protected			Protected			Protected		
Peak-hour factor, PHF	<u>0.90</u>											
Cycle length	Minimum, C _{min}	<u>90</u> s		Maximum, C _{max}	<u>120</u> s		or	Given, C	_____ s			
Lost time/phase	<u>4</u> s											
Notes												
<ol style="list-style-type: none"> 1. RT volumes, as shown, exclude RTOR. 2. P_{LT} = 1.000 for exclusive left-turn lanes, and P_{RT} = 1.000 for exclusive right-turn lanes. Otherwise, they are equal to the proportions of turning volumes in the lane group. 												

Example Problem 4

QUICK ESTIMATION LANE VOLUME WORKSHEET (RUN 1)				
	EB	WB	NB	SB
Right-Turn Movement				
Lane type	Shared	Shared	Shared	Shared
RT volume, RV	460	100	180	100
Number of exclusive RT lanes, N	1	1	1	1
RT adjustment factor, f_{RT}	0.85	0.85	0.85	0.85
RT volume per lane, VT	541	118	212	118
Left-Turn Movement				
Lane type	Exclusive	Exclusive	Exclusive	Exclusive
LT treatment	Prot	Prot	Prot	Prot
LT volume, VS	120	80	260	200
Opposing volume, V_o	1300	1760	650	880
Cross-product, $V_L V_o$	156000	140800	169000	176000
Number of exclusive LT lanes, NT	1	1	1	1
LT adjustment factor, f_{LT}	0.95	0.95	0.95	0.95
LT volume per lane, VT	126	84	274	211
Through Movement				
Through volume, V_T	1300	1200	700	550
Parking adjustment factor, f_p	1.000	1.000	1.000	1.000
Number of through lanes, HT	3	3	2	2
Total approach volume, Tot	1841	1318	912	668
Through volume per lane, HT	614	439	456	334
Critical lane volume, V_{CL}	614	439	456	334
Sneaker Left-Turn Check				
Permitted left sneaker capacity, c_{LS}	N/A	N/A	N/A	N/A

QUICK ESTIMATION CONTROL DELAY AND LOS WORKSHEET (RUN 1)			
East-West Phasing Plan			
	Phase 1	Phase 2	Phase 3
Selected plan <u>3a</u>			
Movement codes	EBWBTL	EBTHLT	EBWBTH
Critical phase volume, CV	84	42	572
Lost time/phase, t_l	4	0	4
North-South Phasing Plan			
Selected plan <u>3a</u>			
Movement codes	NBSBLT	NBTHLT	NBSBTH
Critical phase volume, CV	211	63	393
Lost time/phase, t_l	4	0	4
Intersection Status Computation			
Critical sum, CS	1365		
Lost time/cycle, L	16		
Reference sum flow rate, RS	1539		
Cycle length, C	120.0		
Critical v/c ratio, X_{cm}	1.023		
Intersection status	Over capacity		
Green-Time Calculation			
East-west phasing	Phase 1	Phase 2	Phase 3
Green time, g	10.4	3.2	47.6
North-south phasing	Phase 1	Phase 2	Phase 3
Green time, g	20.1	4.8	33.9

Example Problem 4

QUICK ESTIMATION LANE VOLUME WORKSHEET (RUN 2)

	EB	WB	NB	SB
Right-Turn Movement				
Lane type	Exclusive	Shared	Shared	Shared
RT volume, V_{RT}	460	100	180	100
Number of exclusive RT lanes, N_{RT}	1	1	1	1
RT adjustment factor, f_{RT}	0.85	0.85	0.85	0.85
RT volume per lane, V_{RT}	541	118	212	118
Left-Turn Movement				
Lane type	Exclusive	Exclusive	Exclusive	Exclusive
LT treatment	Prot	Prot	Prot	Prot
LT volume, V_L	120	80	260	200
Opposing volume, V_o	1300	1760	650	880
Cross-product, $V_L V_o$	156000	140800	169000	176000
Number of exclusive LT lanes, N_{LT}	1	1	1	1
LT adjustment factor, f_{LT}	0.95	0.95	0.95	0.95
LT volume per lane, V_{LT}	126	84	274	211
Through Movement				
Through volume, V_T	1300	1200	700	550
Parking adjustment factor, f_p	1.000	1.000	1.000	1.000
Number of through lanes, N_{HT}	3	3	2	2
Total approach volume, V_{tot}	1300	1318	912	668
Through volume per lane, V_{HT}	433	439	456	334
Critical lane volume, V_{CL}	541	439	456	334
Sneaker Left-Turn Check				
Permitted left sneaker capacity, c_{LS}	N/A	N/A	N/A	N/A

QUICK ESTIMATION CONTROL DELAY AND LOS WORKSHEET (RUN 2)

East-West Phasing Plan			
	Phase 1	Phase 2	Phase 3
Selected plan ____ 3a			
Movement codes	EBWBLT	EBTHLT	EBWBTH
Critical phase volume, CV	84	42	499
Lost time/phase, t_l	4	0	4
North-South Phasing Plan			
Selected plan ____ 3a			
Movement codes	NBSBLT	NBTHLT	NBSBTH
Critical phase volume, CV	211	63	393
Lost time/phase, t_l	4	0	4
Intersection Status Computation			
Critical sum, CS	1292		
Lost time/cycle, L	16		
Reference sum flow rate, RS	1539		
Cycle length, C	100.0		
Critical v/c ratio, X_{cm}	0.999		
Intersection status	At capacity		
Green-Time Calculation			
East-west phasing	Phase 1	Phase 2	Phase 3
Green time, g	9.5	2.7	36.4
North-south phasing	Phase 1	Phase 2	Phase 3
Green time, g	17.7	4.1	29.6

Example Problem 4

LOS MODULE WORKSHEET (RUN 2)

Direction/ LnGrp	v/c Ratio	g/C Ratio	Unif Delay d ₁	Progr Factor PF	Lane Grp Cap	Cal Term k	Incr Delay d ₂	Lane Grp Delay	Lane Grp LOS	Delay by App	LOS by App
EB/L	0.917	0.082	45.562	1.000	145	0.500	55.293	100.9	F		
EB/T	0.876	0.324	31.904	1.000	1648	0.500	6.870	38.8	D		
EB/R	0.996	0.324	33.735	1.000	513	0.500	38.767	72.5	E	51.0	D
WB/L	0.614	0.082	44.370	1.000	145	0.500	17.901	62.3	E		
WB/TR	0.886	0.324	32.049	1.000	1629	0.500	7.493	39.5	D	40.8	D
NB/L	0.917	0.178	40.374	1.000	315	0.500	33.351	73.7	E		
NB/TR	0.960	0.297	34.566	1.000	1019	0.500	20.053	54.6	D	59.0	E
SB/L	0.917	0.137	42.589	1.000	242	0.500	39.789	82.4	F		
SB/TR	0.816	0.256	34.985	1.000	885	0.500	8.452	43.4	D	52.6	D
Intersection Delay = 50.3 s/veh						Intersection LOS = D					

EXAMPLE PROBLEM 5

The Intersection The intersection of Eighth Avenue (EB/WB) and Main Street (NB/SB) is located in a rapidly growing semirural community. Eighth Avenue is a four-lane roadway, and Main Street is a two-lane roadway. No turning lanes exist. The existing intersection geometry and projected volumes are shown on the Input Worksheet.

The Question Will projected demand exceed the existing intersection capacity? If so, what countermeasures should be implemented?

The Facts

- √ PHF = 0.90,
- √ Cycle length = 80 s to 120 s,
- √ Movement lost time = 4 s, and
- √ Non-CBD.

Steps

1. Run 1—Exclusive left turn for westbound approach: For the westbound approach, one lane is assigned as an exclusive left-turn lane, and the other is assigned as a shared lane. This assignment is appropriate for the volumes. The initial solution for signal phasing is to use protected-only left-turn treatment for the westbound approach and permitted treatment for all other approaches.

The quick estimation method is used to assess traffic operations. The results show that critical lane volumes are high, and the critical v/c ratio is computed as 1.077, indicating operations over capacity.

2. Run 2—Right-turn lane added on eastbound approach: The eastbound through and right-turn movement is identified as the critical lane group largely because of the high right-turn volume. An exclusive right-turn lane is added to the eastbound approach as a countermeasure. The traffic operation is reassessed, and the results show that the critical v/c ratio is reduced to 0.962. The intersection operates at capacity.

3. Run 3—Split phase operation for northbound and southbound approaches: Although the intersection status is satisfied, northbound and southbound left turns merit further consideration. Significant left-turn volumes in a pair of opposing single-lane approaches should be avoided. Split phase signal phasing is introduced to provide a complete directional separation between the northbound and southbound traffic.

The results show that the critical v/c ratio is increased to 1.138, which is over capacity. The split phasing is not appropriate. Although northbound and southbound per-lane volumes have been reduced, the critical sum is increased as the reduced volumes are added into the critical sum because northbound and southbound movements operate in different phases.

4. Run 4—Exclusive left-turn lane added on northbound and southbound approaches: In order to provide a protected phase for the northbound and southbound left turns while satisfying the operational requirement, an exclusive left-turn lane is added. As shown in the results, northbound and southbound per-lane volumes decrease substantially. The critical v/c ratio is computed as 0.933, which is near capacity.

Example Problem 5

QUICK ESTIMATION INPUT WORKSHEET												
General Information						Site Information						
Analyst	CJM					Intersection	Eighth Ave. and Main St.					
Agency or Company	CEI					Area Type	<input type="checkbox"/> CBD		<input checked="" type="checkbox"/> Other			
Date Performed	5/13/99					Jurisdiction	Fairfax, VA					
Analysis Time Period	4:30 - 5:30 pm					Analysis Year	1999					
Intersection Geometry												
Volume and Signal Input												
	EB			WB			NB			SB		
	LT	TH	RT ¹	LT	TH	RT ¹	LT	TH	RT ¹	LT	TH	RT ¹
Volume, V (veh/h)	120	690	280	170	360	110	80	150	60	120	230	170
Proportion of LT or RT (P_{LT} or P_{RT}) ²		-			-			-			-	
Parking (Yes/No)	No			No			No			No		
Left-turn treatment (permitted, protected, not opposed) (if known)												
Peak-hour factor, PHF	0.90											
Cycle length	Minimum, C_{min} 80 s			Maximum, C_{max} 120 s			or Given, C _____ s					
Lost time/phase	4 s											
Notes												
<ol style="list-style-type: none"> 1. RT volumes, as shown, exclude RTOR. 2. P_{LT} = 1.000 for exclusive left-turn lanes, and P_{RT} = 1.000 for exclusive right-turn lanes. Otherwise, they are equal to the proportions of turning volumes in the lane group. 												

Example Problem 5

QUICK ESTIMATION LANE VOLUME WORKSHEET (RUN 1)

	EB	WB	NB	SB
Right-Turn Movement				
Lane type	Shared	Shared	Shared	Shared
RT volume, RV	280	110	60	170
Number of exclusive RT lanes, N_{RT}	1	1	1	1
RT adjustment factor, f_{RT}	0.85	0.85	0.85	0.85
RT volume per lane, VT	329	129	71	200
Left-Turn Movement				
Lane type	Shared	Exclusive	Shared	Shared
LT treatment	Perm	Prot	Perm	Perm
LT volume, VS	120	170	80	120
Opposing volume, V_o	470	1090	400	210
Cross-product, $V_L V_o$	56400	185300	32000	25200
Number of exclusive LT lanes, NT	0	1	0	0
LT adjustment factor, f_{LT}	0.95	0.95	0.95	0.95
LT volume per lane, VT	0	179	0	0
Through Movement				
Through volume, V_T	690	360	150	230
Parking adjustment factor, f_p	1.000	1.000	1.000	1.000
Number of through lanes, N_{HT}	2	1	1	1
Total approach volume, V_{tot}	1019	489	221	430
Through volume per lane, V_{HT}	721	489	287	592
Critical lane volume, V_{CL}	721	489	287	592
Sneaker Left-Turn Check				
Permitted left sneaker capacity, c_{LS}	N/A	N/A	N/A	N/A

QUICK ESTIMATION CONTROL DELAY AND LOS WORKSHEET (RUN 1)

East-West Phasing Plan			
	Phase 1	Phase 2	Phase 3
Selected plan <u>2a</u>			
Movement codes	WBTHLT	EBWBTH	
Critical phase volume, CV	179	721	
Lost time/phase, t_l	4	4	
North-South Phasing Plan			
Selected plan <u>1</u>			
Movement codes	NBSBLT		
Critical phase volume, CV	592		
Lost time/phase, t_l	4		
Intersection Status Computation			
Critical sum, CS	1492		
Lost time/cycle, L	12		
Reference sum flow rate, RS	1539		
Cycle length, C	120.0		
Critical v/c ratio, X_{cm}	1.077		
Intersection status	Over capacity		
Green-Time Calculation			
East-west phasing	Phase 1	Phase 2	Phase 3
Green time, g	17.0	56.2	
North-south phasing	Phase 1	Phase 2	Phase 3
Green time, g	46.9		

Example Problem 5

QUICK ESTIMATION LANE VOLUME WORKSHEET (RUN 2)

	EB	WB	NB	SB
Right-Turn Movement				
Lane type	Exclusive	Shared	Shared	Shared
RT volume, V_R	280	110	60	170
Number of exclusive RT lanes, N_{RT}	1	1	1	1
RT adjustment factor, f_{RT}	0.85	0.85	0.85	0.85
RT volume per lane, V_{RT}	329	129	71	200
Left-Turn Movement				
Lane type	Shared	Exclusive	Shared	Shared
LT treatment	Perm	Prot	Perm	Perm
LT volume, V_L	120	170	80	120
Opposing volume, V_O	470	1090	400	210
Cross-product, $V_L V_O$	56400	185300	32000	25200
Number of exclusive LT lanes, N_{LT}	0	1	0	0
LT adjustment factor, f_{LT}	0.95	0.95	0.95	0.95
LT volume per lane, V_{LT}	0	179	0	0
Through Movement				
Through volume, V_T	690	360	150	230
Parking adjustment factor, f_p	1.000	1.000	1.000	1.000
Number of through lanes, N_{HT}	2	1	1	1
Total approach volume, V_{tot}	690	489	221	430
Through volume per lane, V_{HT}	488	489	287	592
Critical lane volume, V_{CL}	488	489	287	592
Sneaker Left-Turn Check				
Permitted left sneaker capacity, c_{LS}	N/A	N/A	N/A	N/A

QUICK ESTIMATION CONTROL DELAY AND LOS WORKSHEET (RUN 2)

East-West Phasing Plan			
	Phase 1	Phase 2	Phase 3
Selected plan <u>2a</u>			
Movement codes	WBTHLT	EBWBTH	
Critical phase volume, CV	179	488	
Lost time/phase, t_l	4	4	
North-South Phasing Plan			
Selected plan <u>1</u>			
Movement codes	NBSBLT		
Critical phase volume, CV	592		
Lost time/phase, t_l	4		
Intersection Status Computation			
Critical sum, CS	1259		
Lost time/cycle, L	12		
Reference sum flow rate, RS	1539		
Cycle length, C	80.0		
Critical v/c ratio, X_{cm}	0.962		
Intersection status	At capacity		
Green-Time Calculation			
East-west phasing	Phase 1	Phase 2	Phase 3
Green time, g	13.7	30.4	
North-south phasing	Phase 1	Phase 2	Phase 3
Green time, g	36.0		

Example Problem 5

QUICK ESTIMATION LANE VOLUME WORKSHEET (RUN 3)

	EB	WB	NB	SB
Right-Turn Movement				
Lane type	Exclusive	Shared	Shared	Shared
RT volume, V_R	280	110	60	170
Number of exclusive RT lanes, N_{RT}	1	1	1	1
RT adjustment factor, f_{RT}	0.85	0.85	0.85	0.85
RT volume per lane, V_{RT}	329	129	71	200
Left-Turn Movement				
Lane type	Shared	Exclusive	Shared	Shared
LT treatment	Perm	Prot	Nopp	Nopp
LT volume, V_L	120	170	80	120
Opposing volume, V_o	470	1090	0	0
Cross-product, $V_L V_o$	56400	185300	0	0
Number of exclusive LT lanes, N_{LT}	0	1	0	0
LT adjustment factor, f_{LT}	0.95	0.95	0.95	0.95
LT volume per lane, V_{LT}	0	179	80	120
Through Movement				
Through volume, V_T	690	360	150	230
Parking adjustment factor, f_p	1.000	1.000	1.000	1.000
Number of through lanes, N_{HT}	2	1	1	1
Total approach volume, V_{tot}	690	489	301	550
Through volume per lane, V_{HT}	488	489	301	550
Critical lane volume, V_{CL}	488	489	301	550
Sneaker Left-Turn Check				
Permitted left sneaker capacity, c_{LS}	N/A	N/A	N/A	N/A

QUICK ESTIMATION CONTROL DELAY AND LOS WORKSHEET (RUN 3)

East-West Phasing Plan			
	Phase 1	Phase 2	Phase 3
Selected plan <u>2a</u>			
Movement codes	WBTHLT	EBWBTH	
Critical phase volume, CV	179	488	
Lost time/phase, t_l	4	4	
North-South Phasing Plan			
Selected plan <u>4</u>			
Movement codes	NBTHLT	SBTHLT	
Critical phase volume, CV	301	550	
Lost time/phase, t_l	4	4	
Intersection Status Computation			
Critical sum, CS	1518		
Lost time/cycle, L	16		
Reference sum flow rate, RS	1539		
Cycle length, C	120.0		
Critical v/c ratio, X_{cm}	1.138		
Intersection status	Over capacity		
Green-Time Calculation			
East-west phasing	Phase 1	Phase 2	Phase 3
Green time, g	16.3	37.4	
North-south phasing	Phase 1	Phase 2	Phase 3
Green time, g	24.6	41.7	

Example Problem 5

QUICK ESTIMATION LANE VOLUME WORKSHEET (RUN 4)

	EB	WB	NB	SB
Right-Turn Movement				
Lane type	Exclusive	Shared	Shared	Shared
RT volume, V_R	280	110	60	170
Number of exclusive RT lanes, N_{RT}	1	1	1	1
RT adjustment factor, f_{RT}	0.85	0.85	0.85	0.85
RT volume per lane, V_{RT}	329	129	71	200
Left-Turn Movement				
Lane type	Shared	Exclusive	Exclusive	Exclusive
LT treatment	Perm	Prot	Prot	Prot
LT volume, V_L	120	170	80	120
Opposing volume, V_o	470	1090	400	210
Cross-product, $V_L V_o$	56400	185300	32000	25200
Number of exclusive LT lanes, N_{LT}	0	1	1	1
LT adjustment factor, f_{LT}	0.95	0.95	0.95	0.95
LT volume per lane, V_{LT}	0	179	84	126
Through Movement				
Through volume, V_T	690	360	150	230
Parking adjustment factor, f_p	1.000	1.000	1.000	1.000
Number of through lanes, N_{HT}	2	1	1	1
Total approach volume, V_{tot}	690	489	221	430
Through volume per lane, V_{HT}	488	489	221	430
Critical lane volume, V_{CL}	488	489	221	430
Sneaker Left-Turn Check				
Permitted left sneaker capacity, c_{LS}	N/A	N/A	N/A	N/A

QUICK ESTIMATION CONTROL DELAY AND LOS WORKSHEET (RUN 4)

East-West Phasing Plan			
	Phase 1	Phase 2	Phase 3
Selected plan <u>2a</u>			
Movement codes	WBTHLT	EBWBTH	
Critical phase volume, CV	179	488	
Lost time/phase, t_l	4	4	
North-South Phasing Plan			
Selected plan <u>3b</u>			
Movement codes	NBSBLT	SBTHLT	NBSBTH
Critical phase volume, CV	84	42	388
Lost time/phase, t_l	4	0	4
Intersection Status Computation			
Critical sum, CS	1181		
Lost time/cycle, L	16		
Reference sum flow rate, RS	1539		
Cycle length, C	90.0		
Critical v/c ratio, X_{cm}	0.933		
Intersection status	Near capacity		
Green-Time Calculation			
East-west phasing	Phase 1	Phase 2	Phase 3
Green time, g	15.2	34.6	
North-south phasing	Phase 1	Phase 2	Phase 3
Green time, g	9.3	2.6	28.3

EXAMPLE PROBLEM 6

The Intersection A two-lane through movement at one approach to a signalized intersection has a cycle length of 90 s with a g/C ratio of 0.50. The arrival type is currently 3 (random), but this could be improved by altering the progression.

The Question What is the maximum service flow rate that could be accommodated at LOS B (20 s/veh delay) on this approach?

The Facts

- √ Cycle length = 90 s,
- √ g/C = 0.50, and
- √ s = 3,200 veh/h.

Comments This calculation is intended to illustrate the potential for alternative computational sequences using the basic operational analysis format. Only one lane group is addressed. The computations become far more complex when multiple lane groups are addressed simultaneously. Nevertheless, the procedure is capable of determining service flow rates or geometric or signal parameters based on a desired LOS.

Steps

1. Delay is a function of the v/c ratio, X; the green ratio, g/C; the cycle length, C; the lane group capacity, c; and the progression factor, PF. The lane group capacity is the product of a saturation flow rate, s, and a g/C ratio.

$$c = s * g/C = 3200 * 0.50 = 1600 \text{ veh/h}$$

2. At the LOS B threshold of 20.0 s/veh, the delay equation is expressed as follows:

$$20.0 = d_1 PF + d_2 + d_3$$

where

$$d_1 = \frac{0.5(90)(1 - 0.50)^2}{(1 - 0.50X)}$$

$$d_2 = 225 \left[(X - 1) + \sqrt{(X - 1)^2 + \left(\frac{X}{100} \right)} \right]$$

$$d_3 = 0$$

3. Two tables are generated based on the equations above. The first table provides delay as a function of arrival types and v/c ratios, X. The second table provides v/c ratios and service flow rates as a function of delay and arrival types. In this problem, the second table is more appropriate because service flows are the direct output.

4. Service flow rates, SF, are computed as $X * c$, where $c = 1,600$ veh/h. Thus, at LOS B, the approach can carry a maximum service flow rate of 1,126 veh/h at existing Arrival Type 3. The maximum flow rate increases to 1,491 veh/h at Arrival Type 5 and to 1,571 at Arrival Type 6.

Example Problem 6

SERVICE FLOW RATE SOLUTIONS FOR EXAMPLE PROBLEM 6

X	Flow Rate	d ₁	d ₂	Delay					
				AT 1	AT 2	AT 3	AT 4	AT 5	AT 6
0.0	0	11.250	0.000	18.8	14.0	11.3	8.6	3.7	0.0
0.1	160	11.842	0.125	19.9	14.8	12.0	9.2	4.1	0.1
0.2	320	12.500	0.281	21.1	15.8	12.8	9.9	4.4	0.3
0.3	480	13.235	0.481	22.5	16.9	13.7	10.6	4.9	0.5
0.4	640	14.063	0.748	24.2	18.2	14.8	11.5	5.4	0.7
0.5	800	15.000	1.119	26.1	19.7	16.1	12.6	6.1	1.1
0.6	960	16.071	1.672	28.5	21.6	17.7	14.0	7.0	1.7
0.7	1120	17.308	2.576	31.4	24.0	19.9	15.9	8.3	2.6
0.8	1280	18.750	4.295	35.6	27.5	23.0	18.7	10.5	4.3
0.9	1440	20.455	8.514	42.6	33.9	29.0	24.2	15.3	8.5
1.0	1600	22.500	22.500	60.0	50.4	45.0	39.8	30.0	22.5

LOS	Max Delay	AT 1		AT 2		AT 3		AT 4		AT 5		AT 6	
		SF _{max}	X	SF _{max}	X	SF _{max}	X	SF _{max}	X	SF _{max}	X	SF _{max}	X
A	5									513	0.32	1307	0.82
	10							348	0.22	1241	0.78	1457	0.91
	15			191	0.12	663	0.41	1046	0.65	1429	0.89	1514	0.95
B	20	177	0.11	824	0.51	1126	0.70	1318	0.82	1491	0.93	1571	0.98
	25	707	0.44	1164	0.73	1333	0.83	1448	0.91	1546	0.97		
C	30	1043	0.65	1342	0.84	1450	0.91	1500	0.94				
	35	1259	0.79	1451	0.91	1500	0.94	1551	0.97				
D	40	1381	0.86	1499	0.94	1550	0.97						
	45	1462	0.91	1548	0.97	1600	1.00						
	50	1508	0.94	1596	1.00								
	55	1554	0.97										
	60	1600	1.00										
E	65												
	70												
	75												
	80												

V. REFERENCES

1. *Signalized Intersection Capacity Method*. NCHRP Project 3-28(2). JHK & Associates, Tucson, Ariz., Feb. 1983.
2. *Signalized Intersection Capacity Study*. Final Report, NCHRP, Project 3-28(2). JHK & Associates, Tucson, Ariz., Dec. 1982.
3. Messer, C. J., and D. B. Fambro. Critical Lane Analysis for Intersection Design. In *Transportation Research Record 644*, TRB, National Research Council, Washington, D.C., 1977.
4. Berry, D. S. Other Methods for Computing Capacity of Signalized Intersections. Presented at the 56th Annual Meeting of the Transportation Research Board, Washington, D.C., Jan. 1977.
5. Berry, D. S., and P. K. Gandhi. Headway Approach to Intersection Capacity. In *Highway Research Record 453*, HRB, National Research Council, Washington, D.C., 1973.
6. Miller, A. J. *The Capacity of Signalized Intersections in Australia*. Australian Road Research Bulletin 3. Australian Road Research Board, Kew, Victoria, Australia, 1968.

7. Webster, F. V., and B. M. Cobbe. *Traffic Signals*. Her Majesty's Stationery Office, London, England, 1966.
8. Petersen, B. E., and E. Imre. *Swedish Capacity Manual*. Stockholm, Sweden, Feb. 1977.
9. Akcelik, R. (ed.). *Signalized Intersection Capacity and Timing Guide*. Presented at Signalized Intersection Capacity Workshop, Australian Road Research Board, Kew, Victoria, Australia, 1979.
10. Akcelik, R. *Traffic Signals: Capacity and Timing Analysis*. Australian Road Research Report 123. Australian Road Research Board, Kew, Victoria, Australia, 1981.
11. Reilly, W. R., C. C. Gardner, and J. H. Kell. *A Technique for Measurement of Delay at Intersections*. FHWA Report RD-76-135/137. FHWA, U.S. Department of Transportation, Washington, D.C., 1976.
12. Courage, K. G., D. F. Fambro, R. Akcelik, P. S. Lin, and M. Anwar. Final Report, NCHRP Project 3-48. University of Florida; Texas Transportation Institute; ARRB Transport Research, Ltd., 1996.
13. Akcelik, R. *Analysis of Vehicle-Actuated Signal Operations*. Working Paper WD TE 93/007. Australian Road Research Board, Kew, Victoria, Australia, 1993.
14. Akcelik, R. Estimation of Green Times and Cycle Time for Vehicle-Actuated Signals. Presented at the 73rd Annual Meeting of the Transportation Research Board, Washington, D.C., Jan. 1994.
15. Lin, F. B. Estimation of Average Phase Durations for Full-Actuated Signals. In *Transportation Research Record 881*, TRB, National Research Council, Washington, D.C., 1982, pp. 65–72.
16. Lin, F. B. Predictive Models of Traffic-Actuated Cycle Splits. *Transportation Research*, Vol. 16B, No. 5, 1982, pp. 65–72.
17. Cowan, R. J. Useful Headway Models. *Transportation Research*, Vol. 9, No. 6, 1975, pp. 371–375.
18. Akcelik, R., and E. Chung. Calibration of the Bunched Exponential Distribution of Arrival Headways. *Road and Transport Research*, Vol. 3, No. 1, 1994, pp. 42–59.
19. Kell, J. H., and I. J. Fullerton. *Manual of Traffic Signal Design*. Institute of Transportation Engineers; Prentice-Hall, Inc., Englewood Cliffs, N.J., 1982.
20. Lin, F. B. Optimal Timing Setting and Detector Lengths of Presence Mode Full-Actuated Control. In *Transportation Research Record 1010*, TRB, National Research Council, Washington, D.C., 1985, pp. 37–45.
21. Milazzo, J. S., II, N. M. Roupail, J. E. Hummer, and D. P. Allen. Effect of Pedestrians on Capacity of Signalized Intersections. In *Transportation Research Record 1646*, TRB, National Research Council, Washington, D.C., 1998, pp. 37–46.
22. Allen, D. P., J. E. Hummer, N. M. Roupail, and J. S. Milazzo II. Effect of Bicycles on Capacity of Signalized Intersections. In *Transportation Research Record 1646*, TRB, National Research Council, Washington, D.C., 1998, pp. 87–95.
23. Roupail, N. M., J. E. Hummer, J. S. Milazzo II, and D. P. Allen. *Recommended Procedures for Chapter 9, Signalized Intersections, of the Highway Capacity Manual*. Report FHWA-RD-98-106. FHWA, U.S. Department of Transportation, 1999.
24. Akcelik, R. *A Queue Model for the HCM 2000*. Technical Note. ARRB Transport Research Ltd., Vermont South, Australia, Oct. 13, 1998.

APPENDIX A. FIELD MEASUREMENT OF INTERSECTION CONTROL DELAY

GENERAL NOTES

Equipment and personnel requirements

As an alternative to the estimation of control delay per vehicle using Equation 16-9 and the progression adjustment factor, delay at existing locations may be measured directly. There are a number of techniques for making this measurement, including the use of test-car observations, path tracing of individual vehicles, and the recording of arrival and departure volumes on a cycle-by-cycle basis. The method summarized here is based on direct observation of vehicle-in-queue counts at the intersection and normally requires two field personnel per lane group surveyed, unless the volume is light. Also needed is a multifunction digital watch that includes a countdown-repeat timer, with the countdown interval in seconds, plus a volume-count board with at least two tally counters. As an alternative, a laptop computer can be programmed to emit audio count markers at user-selected intervals, take volume counts, and execute real-time delay computations, thus simplifying data reduction.

In general, this method is applicable to all undersaturated signalized intersections. For oversaturated conditions, queue buildup normally makes the method impractical. Under such conditions, more personnel will be required to complete the field study, and other methods may be considered, such as an input-output technique or a zoned-survey technique.

In the input-output technique, different observers count arrivals separately from departures and vehicles in queue are calculated as the accumulated difference, subject to in-process checks for vehicles leaving the queue before they reach the stop line. The zoned-survey technique requires subdividing the approach into manageable segments to which the observers are assigned; they then count queued vehicles in their assigned zone. Both of these techniques require more personnel and are more complicated in setup and execution.

The method described here is applicable to situations in which the average maximum queue per cycle is no more than about 20 to 25 veh/ln. When queues are long or the demand to capacity ratio is near 1.0, care must be taken to continue the vehicle-in-queue count past the end of the arrival count period, as detailed below. This requirement is for consistency with the analytic delay equation used in the chapter text.

Delay during deceleration is not directly measured

The method does not directly measure delay during deceleration and during a portion of acceleration, which are very difficult to measure without sophisticated tracking equipment. However, this method has been shown to yield a reasonable estimate of control delay. The method includes an adjustment for errors that may occur when this type of sampling technique is used, as well as an acceleration-deceleration delay correction factor. The acceleration-deceleration factor is a function of the typical number of vehicles in queue during each cycle and the normal free-flow speed when vehicles are unimpeded by the signal.

Exhibit A16-1 is a worksheet that can be used for recording observations and computation of average time-in-queue delay. Before beginning the detailed survey, the observers need to make an estimate of the average free-flow speed during the study period. Free-flow speed is the speed at which vehicles would pass unimpeded through the intersection if the signal were green for an extended period. This speed may be obtained by driving through the intersection a few times when the signal is green and there is no queue and recording the speed at a location least affected by signal control. Typically, the recording location should be upstream about midblock.

1. Keeps track of the end of standing queues for each cycle in the survey period by observing the last vehicle in each lane that stops because of the signal. This count includes vehicles arriving when the signal is actually green but stopped because vehicles in front have not yet started moving. For purposes of the survey, a vehicle is considered as having joined the queue when it approaches within one car length of a stopped vehicle and is itself about to stop. This definition is used because of the difficulty of keeping precise track of the moment when a vehicle comes to a stop. All vehicles that join a queue are then included in the vehicle-in-queue counts until they cross the stop line.

2. At regular intervals of between 10 and 20 s, records the number of vehicles in queue (e.g., using the countdown-repeat timer on a digital watch to signal the count time). The regular intervals should not be an integral divisor of the cycle length (e.g., if the cycle length is 120 s, 14-s or 16-s count intervals should be used, not 15-s intervals). Vehicles in queue are those that are included in the queue of stopping vehicles as defined in Step 1 and have not yet exited the intersection. For through vehicles, exiting the intersection can be considered to occur when the rear axle of a vehicle crosses the stop line. For turning vehicles, exiting the intersection occurs the instant a vehicle clears opposing through traffic or pedestrians to which it must yield and begins accelerating back to free-flow speed. Note that the vehicle-in-queue count often includes some vehicles that have regained speed but have not yet exited the intersection.

3. Enters the vehicle-in-queue counts in the appropriate box on the worksheet. Cycles of the survey period are listed in the second column of the sheet, after the column to record clock time every five cycles, and interval count identifiers are listed as column headings. For ease in conducting the study, the survey period is most conveniently defined as an integer number of cycles, though a precisely defined time length for the survey period (e.g., 15 min) can be used. The key point is that the end of the survey period must be clearly defined in advance since the last arriving vehicle or vehicles that stop in the period must be identified and counted until they exit the intersection, per the next step.

4. At the end of the survey period, continues taking vehicle-in-queue counts for all vehicles that arrived during the survey period until all of them have exited the intersection. This step requires mentally noting the last stopping vehicle that arrived during the survey period in each lane of the lane group and continuing the vehicle-in-queue counts until the last stopping vehicle or vehicles, plus all vehicles in front of the last stopping vehicles, exit the intersection. Stopping vehicles that arrive after the end of the survey period are not included in the final vehicle-in-queue counts.

Observer 2 performs the following study task.

1. During the entire survey period, maintains separate volume counts of total vehicles arriving during the survey period and total vehicles arriving during the survey period that stop one or more times. A vehicle stopping multiple times is counted only once as a stopping vehicle. Enters these volumes in the appropriate boxes on the worksheet.

Data reduction is accomplished with the following steps.

1. Sum each column of vehicle-in-queue counts, then sum the column totals for the entire survey period.

2. A vehicle recorded as part of a vehicle-in-queue count is in queue, on average, for the time interval between counts. The average time-in-queue per vehicle arriving during the survey period is estimated using Equation A16-1.

$$\text{Time-in-queue per vehicle} = \left(I_s * \frac{\sum V_{iq}}{V_{tot}} \right) * 0.9 \quad (\text{A16-1})$$

where

$$I_s = \text{interval between vehicle-in-queue counts (s),}$$

$$\sum V_{iq} = \text{sum of vehicle-in-queue counts (veh),}$$

- V_{tot} = total number of vehicles arriving during the survey period (veh), and
- 0.9 = empirical adjustment factor.

The 0.9 adjustment factor accounts for the errors that may occur when this type of sampling technique is used to derive actual delay values, normally resulting in an overestimate of delay. Research has shown the correction required to be fairly consistent over a variety of conditions.

3. Compute the fraction of vehicles stopping and the average number of vehicles stopping per lane in each signal cycle, as indicated on the worksheet.
4. Using Exhibit A16-2, look up a correction factor appropriate to the lane group free-flow speed and the average number of vehicles stopping per lane in each cycle. This factor adds an adjustment for deceleration and acceleration delay, which cannot be measured directly with manual techniques.

EXHIBIT A16-2. ACCELERATION-DECELERATION DELAY CORRECTION FACTOR, CF (s)

Free-Flow Speed	≤ 7 Vehicles	8 - 19 Vehicles	20 - 30 Vehicles ^a
≤ 60 km/h	+ 5	+ 2	- 1
> 60–71 km/h	+ 7	+ 4	+ 2
> 71 km/h	+ 9	+ 7	+ 5

Note:

- a. Vehicle-in-queue counts in excess of about 30 vehicles per lane are typically unreliable.

5. Multiply the correction factor by the fraction of vehicles stopping, then add this product to the time-in-queue value of Step 2 to obtain the final estimate of control delay per vehicle.

Exhibit A16-3 presents a sample computation for a study site over a 15-min period, operating with a 115-s cycle over almost eight cycles. The exhibit is annotated to clarify the procedure. The 15-s count interval is not an integral divisor of the cycle length, thus eliminating potential survey bias due to queue buildup in a regular, cyclic pattern.

Exhibit A16-4 shows how the field study would have been finished if a queue still remained at the end of the 15-min study period. Only the vehicles that arrived during the 15-min period would be counted.

If the study site is an actuated signal with varying cycle and phase lengths, the count interval may be chosen as the most convenient value for conducting the field survey on the basis of volume and vantage point considerations.

Three types of controllers defined:

- fully actuated
- semiactuated
- pretimed

along with a general discussion of the range in which they are employed. These discussions are intended only to assist the analyst in establishing an initial signal design for study and do not represent established standards or guidelines.

TYPE OF SIGNAL CONTROLLER

Traffic engineering reference books describe three types of traffic signal controllers: pretimed, fully actuated, and semiactuated. Pretimed controllers have a preset sequence of phases displayed in repetitive order. Each phase has a fixed green time and change interval that are repeated in each cycle to produce a constant cycle length.

Fully actuated controllers operate with timing on all approaches being influenced by vehicle detectors. Each phase is subject to a minimum and maximum green time, and some phases may be skipped if no demand is detected. The cycle length for fully actuated control will vary from cycle to cycle.

Semiactuated controllers operate with some approaches (typically on the minor street) having detectors. The earliest form of semiactuated control was designed to maintain the green on the major street in the absence of a minor-street actuation. Once actuated, the minor-street green is displayed for a period just long enough to accommodate the traffic demand.

Although these equipment-based definitions have persisted in traffic engineering terminology, the evolution of traffic control technology has complicated their function from the analyst's perspective. For purposes of capacity and LOS analysis, it is no longer sufficient to consider the controller type as a global descriptor of the intersection operation. Instead, an expanded set of these definitions must be applied individually to each lane group.

Each lane group may be served by a phase that is either actuated or nonactuated. Nonactuated phases may be coordinated with neighboring signals on the same route, or they may function in an isolated mode without influence from other signals. Nonactuated phases generally operate with fixed minimum green times, which can be extended by reassigning unused green time from actuated phases with low demand.

Actuated phases, on the other hand, may be used at intersections at which other phases are coordinated, but they may not, for purposes of this chapter, be coordinated themselves. Actuated phases are subject to being shortened on cycles with low demand. On cycles with no demand, they may be skipped entirely, or they may be displayed for their minimum duration. With systems in which the nonactuated phases are coordinated, the actuated phases are also subject to early termination (force off) to accommodate the progression design for the system.

If all of the phases at an intersection are nonactuated, the length of each phase, and consequently the cycle length, will be fixed for purposes of analysis. This arrangement denotes the condition of pretimed operation. In current practice, one or more phases under this type of control will usually be coordinated. In general, if the intersection is sufficiently removed from its neighbors to operate in an isolated mode, actuated operation can produce lower delays and a better level of service. The methodology in this chapter will indicate the degree to which vehicle delay may be reduced by actuated control.

If all of the phases at an intersection are actuated, the length of each phase, and consequently the cycle length, will vary with each cycle. This arrangement denotes the condition of fully actuated operation. No coordination with neighboring signals is possible under this control mode. Fully actuated signals are generally used only at intersections where distances are such that coordination would not be expected to be beneficial or where, for administrative or cost reasons, it would not be expected to be implemented. The analysis procedures prescribed previously in this chapter will support an evaluation of the comparative benefits of coordinated operation versus actuated operation.

The semiactuated control mode includes all of the cases that do not fit into either the pretimed or fully actuated categories. The majority of coordinated signal systems must

be treated as systems of semiactuated controllers with coordinated nonactuated phases serving the major-street approaches and isolated actuated phases serving the cross-street approaches. The cycle length is constant at coordinated semiactuated intersections and variable at isolated semiactuated intersections.

The analysis procedures in this chapter are based on the assumption of a fixed sequence of phases, each of which is displayed for a predictable time. In the case of pretimed control (i.e., no actuated phases), the length of each phase is assumed to be fixed and constant from cycle to cycle. Actuated phases must be approximated for analysis purposes by their average green time, recognizing that the actual time may differ from cycle to cycle. For a given timing plan (i.e., constant or average green times), the differences between actuated and nonactuated phases are recognized by the parameters used in the incremental term (d_2) of the delay equation.

Analysis procedures in this chapter are based on fixed lengths of intervals and sequences of phases. Other types of control are approximated.

PHASE PLANS

The most critical aspect of any design of signal timing is the selection of an appropriate phase plan. The phase plan comprises the number of phases to be used and the sequence in which they are implemented. As a general guideline, simple two-phase control should be used unless conditions dictate the need for additional phases. Because the change interval between phases contributes to lost time in the cycle, as the number of phases increases, the percentage of the cycle made up of lost time generally also increases.

Exhibit B16-1 shows a number of common phase plans that may be used with either pretimed or actuated controllers. Exhibit B16-2 illustrates an optional phasing scheme that typically can be implemented only with actuated controllers.

EXHIBIT B16-1. PHASE PLANS FOR PRETIMED AND TRAFFIC-ACTUATED CONTROL

<p>Two phases</p> <p>(a)</p>			
<p>Exclusive left-turn phase</p> <p>Three phases</p> <p>(b)</p>			
<p>Leading/lagging green overlapping phases</p> <p>(c)</p>			
<p>Four phases</p> <p>Two left-turn phases</p> <p>(d)</p>			

Note:
a. Optional movement.

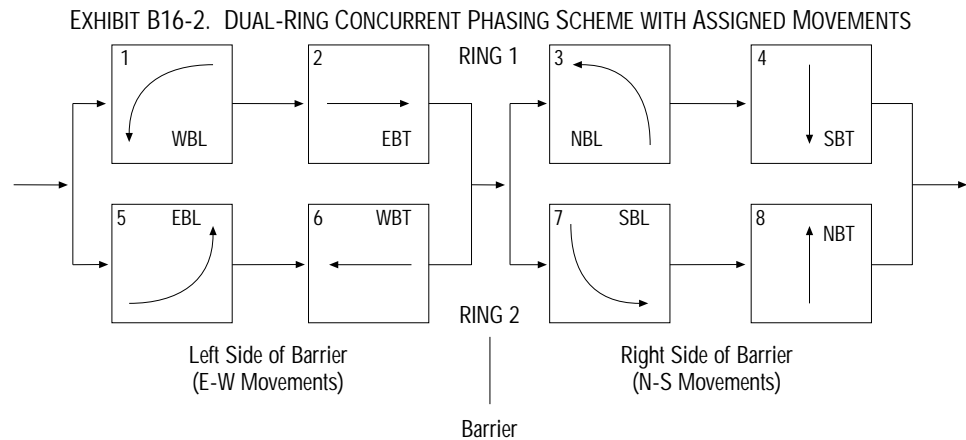

Two-Phase Control

Two-phase control is the simplest of the available phase plans. Each of two intersecting streets is given a green phase during which all movements on the street are allowed to proceed. All left and right turns are made on a permitted basis against an opposing vehicle flow, pedestrian flow, or both. The two-phase plan is shown in Exhibit B16-1(a). This phase plan is generally used unless turn volumes require protected phasing.

Multiphase Control

Multiphase control is adopted at any intersection where one or more left or right turns require protected phasing. It is generally the left-turn movement that requires a partially or fully protected phase. Local policy and practice are critical determinants of this need. Most agencies have guidelines for when left turns require protected phasing. Protected left-turn phasing is also considered when the speed of opposing traffic is greater than 65 km/h.

Multiphase control can be provided in a variety of ways, depending on the number of turns requiring protected phasing and the sequence and overlaps used. Exhibit B16-1 presents three common plans for multiphase control. Exhibit B16-1(b) shows a three-phase plan in which an exclusive left-turn phase is provided for both left-turn movements on the major street. It is followed by a through phase for both directions of the major street, during which left turns in both directions may be permitted on an optional basis.

The use of a permitted left-turn phase following protected left-turn phases is very much a matter of local practice. The phasing illustrated in Exhibit B16-1(b) can be used either for protected or protected-permitted operation in either mode. Note that a few agencies use permitted-plus-protected phasing. Exclusive left-turn phases provide for simultaneous movement of opposing left turns and are most efficient when the opposing left-turn volumes are nearly equal. When volumes are unequal, or in cases in which only one left turn requires protected phasing, other phase plans are more efficient.

The three-phase plan may be expanded to a four-phase sequence if both streets require left-turn phases. Such a sequence is shown in Exhibit B16-1(d). Left turns may be continued on a permitted basis concurrent with the through phases. It is common practice to provide exclusive lanes for left or right turns with protected phases.

Exhibit B16-1(c) shows what is commonly referred to as leading and lagging green phasing. The initial phase is a through plus left-turn phase for one direction of the major street, followed by a through phase for both directions of the major street, during which left turns in both directions may be permitted on an optional basis. Note that many operating agencies do not, as a matter of policy, use the optional permitted left turn with this type of phasing because of safety considerations. The direction of flow started in the

It is common practice to provide exclusive lanes for left or right turns with protected phases

first phase is then stopped, providing the opposing direction with a through-plus-left-turn phase. The final phase accommodates all movements on the minor street.

Such phasing is extremely flexible. When only one left turn requires a protected phase, a leading green can be provided without a lagging green phase. When left-turn volumes are unequal, the lengths of the leading and lagging green can be adjusted to avoid excessive green time for one or both left-turn movements. Leading or lagging green phase, or both, can even be used where no left-turn exists as long as turns are permitted to continue during the through phase. The phasing of Exhibit B16-1(c) may also be expanded to incorporate leading or lagging green phases on both streets.

All of the phase plans discussed to this point can be implemented with pretimed or actuated controllers. The only difference in operation would be the manner in which green time is allocated to the various phases. For pretimed controllers, green times are preset, whereas for actuated controllers, green times vary on the basis of detector actuations.

At this point, it is necessary to recognize the differences in the way that modern traffic-actuated controllers actually implement the phase plan. Exhibit B16-1 depicts a single-ring, sequential representation of the phase plan, in which a signal phase is used to indicate the combination of all movements that are proceeding at a given point in time. Modern traffic-actuated controllers do not use this scheme. Instead, they implement a dual-ring concurrent phasing in which each phase controls only one movement, but two phases are generally being displayed concurrently.

The dual-ring concurrent concept is illustrated in Exhibit B16-2. Note that eight phases are shown, each of which accommodates one of the through or left-turning movements. A barrier separates the north-south phases from the east-west phases. Any phase in the top group (Ring 1) may be displayed with any phase in the bottom group (Ring 2) on the same side of the barrier without introducing traffic conflicts. For simplicity, the right turns are omitted and assumed to proceed with the through movements.

The definition of a phase as presented in Exhibit B16-2 is not consistent with that in Exhibit B16-1 nor with the definition given in Chapter 10. It is, however, a definition that is universally applied in the traffic control industry. It is the responsibility of the analyst to recognize which definition is applicable to any given situation. For purposes of the capacity and delay analysis procedures presented in the body of this chapter, each lane group is considered to be controlled separately by a phase with specified red, green, yellow, and all-red times, so either definition could apply. The examples shown throughout the chapter are based on the single-ring sequential concept. However, the dual-ring definition must be used for estimating the timing plan at traffic-actuated intersections using the procedure presented in this appendix.

The dual-ring phases that accommodate left turns will only be used if the left turns are protected. Left turns with compound protection will proceed with their concurrent through movements. For example, none of the left-turn phases would be used by a dual-ring controller to implement the two-phase plan shown in Exhibit B16-1(a). All of the other phase plan examples shown in Exhibit B16-1 may be created by selectively omitting left-turn phases and by reversing the order in which the through and left-turn phases are displayed in either ring.

The advantage of the dual-ring concept is that it is able to generate the optimal phase plan for each cycle in response to the traffic demand. Pretimed controllers, and earlier versions of traffic-actuated controllers, are more constrained in this regard. The maximum flexibility is provided by allowing the first (usually left-turn) phases in Rings 1 and 2 to terminate independently after their respective demands have been satisfied.

It is also possible to constrain these phases to terminate simultaneously to emulate the older, less efficient equipment. For example, simultaneous termination of the northbound and southbound left-turn phases in Exhibit B16-2 would produce the phasing example shown in Exhibit B16-1(b). Independent termination of the two left turns would

Careful selection of a phase plan is necessary to achieve efficient operation

introduce an overlap phase between the left-turn phase and the through-movement phase in Exhibit B16-1(b). The overlap phase would accommodate the heavier volume of the two left turns together with the concurrent through movement, thereby making more effective use of the cycle length. The degree of benefit obtained from phase overlaps of this nature depends on the degree of difference in the opposing left-turn volumes.

The establishment of a phase plan is the most creative part of signal design and deserves the careful attention of the analyst. A good phase plan can achieve efficiency in the use of available space and time, whereas an inappropriate plan can cause inefficiency. The phase plans presented and discussed in this appendix represent a sampling of the more common forms used. They may be combined in a number of innovative ways on various approaches of an intersection.

Again, local practice is an important determinant in the selection of a phase plan. Phasing throughout an area should be relatively uniform. The introduction of the protected-plus-permitted phasing at one location in an area where left turns are generally handled in exclusive left-turn phases, for example, may confuse drivers. Thus, system considerations should also be evaluated when phase plans are established.

ALLOCATION OF GREEN TIME

The allocation of green time is an important input to the methodology presented earlier in this chapter for the estimation of delay. The average cycle length and effective green time for each lane group must be defined. The most desirable way to obtain these values is by field measurement; however, there are many cases in which field measurement is not possible. For example, the comparison of hypothetical alternatives precludes field measurements. Even for the evaluation of existing conditions, the required data collection is beyond the resources of many agencies.

A procedure for estimating the signal timing characteristics is therefore an important traffic analysis tool. Such a procedure is also useful in designing timing plans that will optimize some aspect of the signal operation. In this respect, pretimed and actuated control must be treated differently because the design and analysis objectives are different. For pretimed control, the objective is to design an implementable timing plan as an end product. In traffic-actuated control, the timing plan is generated by the controller itself on the basis of operating parameters that are established for each phase. This operation creates two separate objectives for traffic-actuated control. The first is to determine how the controller will respond to a specified combination of operating parameters and traffic conditions. The second is to provide some indication of the optimal values for the key operating parameters.

TIMING PLAN DESIGN FOR PRETIMED CONTROL

The design of an implementable timing plan is a complex and iterative process that is generally carried out with the assistance of computer software. Several software products are available for this purpose, some of which employ, at least in part, the methodology of this chapter.

Design Strategies

There are several aspects of signal timing design that are beyond the scope of this manual. One such aspect is the choice of the timing strategy itself. Three basic strategies are commonly used for pretimed signals.

Equalizing the v/c ratios for critical lane groups is the simplest strategy and the only one that may be calculated without excessive iteration. It will be described briefly in this appendix. It is also employed in the timing plan synthesis procedures of the planning procedure presented in Chapter 10. Under this strategy, the green time is allocated among the various signal phases in proportion to the flow ratio of the critical lane group for each phase.

Equalizing the v/c ratios for critical lane groups is the simplest strategy and the only one that may be calculated without excessive iteration

Minimizing the total delay to all vehicles is generally proposed as the optimal solution to the signal timing problem, often in combination with other measures such as stops and fuel consumption. Many signal timing models offer this optimization feature. Some use a delay estimation procedure identical to the methodology in this chapter, whereas others employ minor departures from this method.

Balancing the LOS for all critical lane groups promotes an LOS on all approaches that is consistent with the overall intersection LOS. Both of the other strategies tend to produce a higher delay per vehicle, and therefore a less favorable LOS, for the minor movements at an intersection. This lack of balance in LOS for critical lane groups causes some difficulty in representing the overall intersection LOS.

Procedure for Equalizing Degree of Saturation

Once a phase plan and signal type have been established, signal timing may be estimated using Equations B16-1, B16-2, B16-3, and B16-4.

$$X_i = \frac{v_i C}{s_i g_i} \quad (\text{B16-1})$$

$$X_c = \sum_i \left(\frac{v}{s} \right)_{ci} \left(\frac{C}{C-L} \right) \quad (\text{B16-2})$$

$$C = \frac{L X_c}{\left[X_c - \sum_i \left(\frac{v}{s} \right)_{ci} \right]} \quad (\text{B16-3})$$

$$g_i = \frac{v_i C}{s_i X_i} = \left(\frac{v}{s} \right)_i \left(\frac{C}{X_i} \right) \quad (\text{B16-4})$$

where

- C = cycle length (s);
- L = lost time per cycle (s);
- X_c = critical v/c ratio for the intersection;
- X_i = v/c ratio for lane group i (note that target v/c ratio is a user-specified input with respect to this procedure; default value suggested is 0.90);
- $(v/s)_i$ = flow ratio for lane group i ;
- s_i = saturation flow rate for lane group i (veh/h); and
- g_i = effective green time for lane group i (s).

Cycle lengths and green times may be estimated using these relationships, computed flow ratios, and desired v/c ratios.

For pretimed signals, fixed green times and cycle lengths may be estimated using Equations B16-3 and B16-4. The procedure will be illustrated using a sample calculation. Consider the two-phase signal shown in Exhibit B16-3. Flow ratios are shown, and it is assumed that lost times equal the change-and-clearance intervals, which are 4 s for each phase or 8 s/cycle.

The cycle length is computed from Equation B16-3 for the desired v/c ratio X_c , which must be selected by the analyst. The shortest cycle length that will avoid oversaturation may be computed by Equation B16-5 using $X_c = 1.00$:

$$C (\text{minimum}) = \frac{L X_c}{\left[X_c - \sum_i \left(\frac{v}{s} \right)_{ci} \right]} \quad (\text{B16-5})$$

$$C (\text{minimum}) = \frac{8(1.0)}{[1.0 - (0.45 + 0.35)]} = \frac{8}{0.2} = 40 \text{ s}$$

Minimizing the total delay to all vehicles is generally proposed as the optimal solution to the signal timing problem, often in combination with other measures such as stops and fuel consumption

Balancing the LOS for all critical lane groups promotes an LOS on all approaches that is consistent with the overall intersection LOS

EXHIBIT B16-3. SAMPLE TWO-PHASE SIGNAL

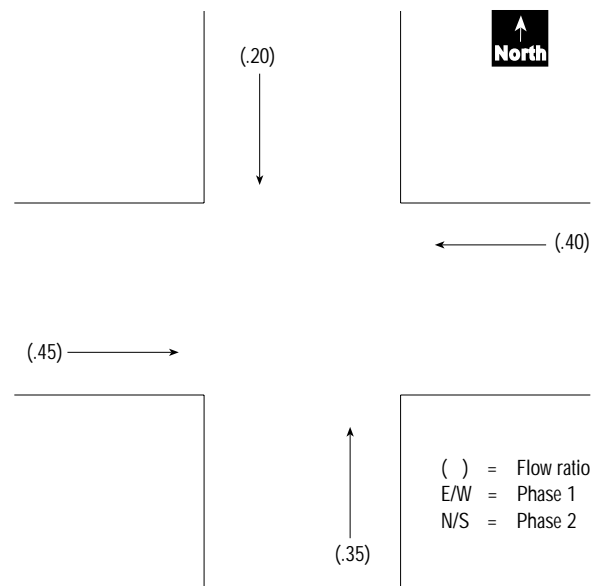

This cycle length has no direct value in the design of implementable timing plans; however, it is commonly used as a departure point for iterative procedures that seek to minimize or equalize delay among lane groups.

If a v/c ratio of no more than 0.8 were desired, the computation would become

$$C = \frac{8(0.80)}{[0.8 - (0.45 + 0.35)]} = \frac{6.4}{0} = \text{infinity}$$

This computation indicates that a critical v/c ratio of 0.8 cannot be provided for a 40-s cycle and the demand levels existing at the intersection. Any cycle length greater than 40 s may be selected. For purposes of illustration, assume a cycle length of 60 s. In all cases, the cycle length assumed would be rounded to the nearest 5 s for values between 30 and 90 s and to the nearest 10 s for higher values.

The actual critical v/c ratio provided by a 60-s cycle is given by Equation B16-6:

$$X_c = \frac{\sum_i \left(\frac{v}{s}\right)_i C}{(C - L)} \tag{B16-6}$$

$$X_c = \frac{(0.45 + 0.35)(60)}{(60 - 8)} = 0.923$$

A number of different policies may be employed in allocating the available green time. A common policy for two-phase signals is to allocate the green such that the v/c ratios for critical movements in each phase are equal. Thus, for the example problem, the v/c ratio for each phase would be 0.923, and green times are computed using Equation B16-7.

$$g_i = \left(\frac{v}{s}\right)_i * \left(\frac{C}{X_i}\right) \tag{B16-7}$$

$$\begin{aligned}
 g_1 &= 0.45(60/0.923) = 29.3 \text{ s} \\
 g_2 &= 0.35(60/0.923) = \underline{22.7 \text{ s}} \\
 &52.0 \text{ s} \\
 \text{Lost time} &= \underline{8.0 \text{ s}} \\
 &60.0 \text{ s}
 \end{aligned}$$

Another common policy would be to allocate the minimum required green time to the minor approach and assign all remaining green to the major approach. In this case, the v/c ratio for Phase 2 would be 1.0, and

$$\begin{aligned}
 g_2 &= 0.35(60/1.0) = 21.0 \text{ s} \\
 g_1 &= 60 - 8 - 21 = \underline{31.0 \text{ s}} \\
 &52.0 \text{ s} \\
 \text{Lost time} &= \underline{8.0 \text{ s}} \\
 &60.0 \text{ s}
 \end{aligned}$$

Note that in both cases the entire 60-s cycle is fully allocated among the green times and lost time.

The procedure for timing may be summarized as follows:

- Estimate the cycle length for full saturation using Equation B16-3 and $X_c = 1.0$.
- Estimate the cycle length for the desired critical v/c ratio, X_c , using Equation B16-3.
 - From the results of the first two calculations, select an appropriate cycle length for the signal. When system constraints determine the cycle length, the first step and this step may be eliminated.
 - Estimate the green times using Equation B16-4 and v/c ratios, X_i , appropriate to the proportioning policy adopted.
 - Check the timing to ensure that the sum of green times and the lost time equals the cycle length. Include overlapping green times only once in this summation.

TIMING PLAN ESTIMATION FOR TRAFFIC-ACTUATED CONTROL

This procedure encompasses both a traffic-actuated control model and an analytical structure for implementation of the model.

Functional Requirements of Model

A practical traffic-actuated control model must be functionally capable of providing reasonable estimates of the operating characteristics of traffic-actuated controllers under the normal range of design configurations at both isolated and coordinated intersections. It must also be sensitive to common variations in design parameters. Examples of design parameters include

- Traffic-actuated controller settings (initial interval, allowable gap, maximum green time),
 - Conventional actuated versus volume-density control strategies,
 - Detector configuration (length and setback),
 - Pedestrian timing (Walk and flashing Don't Walk),
 - Left-turn treatment (permitted, protected, permitted and protected, not opposed),
- and
- Left-turn phase position (leading or lagging).

Data Requirements

The information that is already required by this chapter methodology is used to the extent possible to avoid the need for new data. Most of the additional data items relate to the operation of the controller itself. The model structure is based on the standard

eight-phase dual-ring control scheme that was illustrated in Exhibit B16-2. This scheme is more or less universally applied in the United States.

For purposes of this discussion, the scheme for assignment of movements to phases presented in Exhibit B16-2 will be adopted. This procedure will greatly simplify the illustration of all modeling procedures without affecting the generality of the results.

The process is highly iterative, and the productive application of the manual worksheets is not practical. Only the input data worksheet will be discussed in detail in this appendix. This worksheet, presented in Exhibit B16-4, gathers together all data required by the analytical model.

Approach-Specific Data

The top portion of the worksheet summarizes the approach-specific information. A separate column is used for each of the four approaches. The logic of the model requires that the left-turn treatment be identified explicitly. The codes used here are consistent with the definitions presented in the body of this chapter.

The term simple left-turn protection refers to left turns moving only on the protected phase. The term compound left-turn protection will be used to denote either protected-plus-permitted or permitted-plus-protected treatments.

Position Codes

Position codes are required to distinguish between leading and lagging left-turn protection. The terms leading and lagging apply equally to the cases of simple and compound left-turn protection. These codes do not apply if the left turn is not protected. The worksheet offers a simple choice of leading, lagging, or N/A. The definition is very simple: leading left turns precede the movement of the opposing through traffic and lagging left turns follow it.

Sneakers

The term sneaker describes the number of left turns per cycle that may be discharged at the end of a permitted phase. An implicit default of two per cycle is built into the supplemental permitted left-turn worksheets for purposes of determining the minimum saturation flow rate. Since any vehicles that rest in the detection zone will extend their respective phases (assuming that the phase has not already extended to a preset maximum), a more detailed treatment of sneakers will be required for traffic-actuated control.

Free Queue

The pretimed model assumes that the first permitted left turn at the stop line will block a shared lane. However, through vehicles in the shared lane are often able to squeeze around one or more left-turning vehicles, which define the free queue. The lack of a free-queue parameter is a deficiency of the pretimed model, but it is especially critical with traffic-actuated control because vehicles in the free queue do not occupy the detector and therefore do not extend the green phase. A permitted left turn stopped on the detector must be treated entirely differently in the modeling process than one that has stopped beyond the detector.

Approach Speed, S_A

The speed of vehicles on a signalized intersection approach is required in the analysis of traffic-actuated operation. It determines the passage time between the detector and the stop line as well as the portion of intervehicle headways during which a presence detector is occupied. In modeling the operation of vehicles at a traffic signal, it is typical to assume a single value for speed that applies throughout the cycle.

EXHIBIT B16-4. TRAFFIC-ACTUATED CONTROL INPUT DATA WORKSHEET

TRAFFIC-ACTUATED CONTROL INPUT DATA WORKSHEET								
General Information				Site Information				
Analyst _____				Intersection _____				
Agency or Company _____				Area Type <input type="checkbox"/> CBD		<input type="checkbox"/> Other		
Date Performed _____				Jurisdiction _____				
Analysis Time Period _____				Analysis Year _____				
Approach-Specific Data								
	EB	WB	NB	SB				
Left-turn treatment code ¹								
Left-turn position (leading, lagging, or N/A)								
Left-turn max sneakers, v_{LS} (veh)								
Left-turn free queue, Q_f (veh)								
Approach speed, S_A (km/h)								
Ring 1 and 2 termination (simultaneous, independent, or N/A)								
Phase-Specific Data								
	Ring 1				Ring 2			
	1. WBLT	2. EBTH	3. NBLT	4. SBTH	5. EBLT	6. WBTH	7. SBLT	8. NBTH
Phase type ² (L, T, G, N, X)								
Phase reversal (Yes or No)								
Detector length, DL (m)								
Detector setback, DS (m)								
Max initial interval, MxI (s)								
Added initial per actuation, AI (s)								
Min allowable gap, MnA (s)								
Gap reduction rate, GR								
Ped Walk + Don't Walk, WDW (s)								
Maximum green, MxG (s)								
Intergreen time, Y (s)								
Recall mode (min, max, ped, none)								
Min veh phase time, MnV (s)								
Notes								
1. (0) Does not exist (1) Permitted (2) Protected (3) Protected + Permitted (4) Not opposed 2. (L) Protected left turn on a green arrow (T) Through and right-turning traffic only (G) Permitted left turns and compound left-turn protection (N) In addition to other movements, left turns are not opposed (X) Inactive phases								

Terminating of Rings 1 and 2

The nature of dual-ring control requires that the second phases of Rings 1 and 2 terminate simultaneously because they yield control to approaches with conflicting traffic. However, control may pass from the first phase to the second phase of either ring without causing conflict. Independent termination of the first phases improves efficiency in the allocation of time among competing movements and is generally exploited for this

reason. The type of operation created by independent termination is sometimes referred to as phase overlap.

It is, however, not essential that the phases terminate independently. Older single-ring controller operation may be approximated by requiring that the first phases of each ring (i.e., Phases 1 and 5, or 3 and 7) terminate simultaneously. In some situations involving coordination of controllers on major routes, it is common to force both rings out of their first phase simultaneously. The model considers simultaneous or independent termination as legitimate alternatives.

It is possible that one or more of the first phases will not be used, because their associated left turn is not protected. In this case, the question of simultaneous or independent termination will not apply. This is another multiple-choice entry on the worksheet. The alternatives are simultaneous, independent, and N/A.

Phasing and Detector Design Parameters

The bottom portion of the worksheet includes all of the data items that are specific to each of the eight phases represented in Exhibit B16-2. A separate column is provided on the worksheet for each phase. The first group includes the design parameters relating to phasing and detector placement that will affect the operation. The following data items are included.

Phase Type

Phase type is the first of several phase-specific inputs that are required. A phase that is not active will not be recognized in any of the subsequent computations. Inactive phases are indicated by an X in the appropriate column of the worksheet. A left-turn phase will be considered active only if it accommodates a protected left turn. A through phase will be considered active if it accommodates any traffic at all—through, left, or right. Active phases will be designated as follows:

- L if the phase accommodates a protected left turn on a green arrow.
- T if the phase accommodates through and right-turning traffic only. In this case, all left turns are accommodated entirely on another phase (i.e., simple left-turn protection).
- G if any left turns are accommodated on this phase and opposed by oncoming traffic. This case will occur on phases with permitted left turns and those with compound left-turn protection.
- N if the phase accommodates, in addition to other movements, left turns that are not opposed at any time in the phase sequence. This case will happen at T-intersections, on one-way streets, and in cases in which the phasing completely separates all movements on opposing approaches.

Note that right turns are not referenced specifically in these designations. Right turns are assumed to proceed concurrently with the through traffic.

Phase Reversal

Normally the first phase in each ring on each side of the barrier (odd-numbered phase) handles protected left turns and the second (even-numbered) phase handles the remaining traffic. This operation creates a condition of leading left-turn protection. When lagging left-turn protection is desired, the movements in the first and second phases are interchanged. Most controllers provide an internal function to specify phase reversal. For purposes of this methodology, two phases may only be interchanged if both phases are active.

Detector Length, DL

Detector length is the effective distance, measured parallel to the direction of travel, through which a vehicle will occupy the detector. This design parameter is user-specified

Convention for designating movements accommodated on a phase

and influenced by local practice. The detector length influences the choice of other parameters, such as the allowable gap in traffic that will terminate the phase.

Detector Setback, DS

Detector setback is the distance between the downstream edge of the detector and the stop line.

Controller Settings

The controller itself has several operating parameters that must be specified for each phase. Collectively, these will be referred to as the controller settings because they must be physically set in the controller with switches, keypads, or some other electrical means. The following settings will exert a significant influence on the operation of the intersection and must therefore be recognized by the analysis methodology.

Maximum Initial Interval, MxI

Maximum initial interval is used only when the initial interval is extended under volume-density control. It must be long enough to ensure that a queue of vehicles released at the beginning of the green will be in motion at the detector before the green phase terminates.

Added Initial per Actuation, AI

When the initial interval is extended under volume-density control, the added initial interval per actuation will depend on the number of approach lanes. It should be long enough to ensure that each vehicle crossing the approach detector on the red will add an appropriate increment of time to the initial interval.

Minimum Allowable Gap, MnA

MnA is a user-specified controller parameter, the effect of which will be illustrated later as the analytical model is exercised. It is typically set in the range of 2 to 3 s. It establishes the threshold for the length of the gap in traffic that will cause the phase to terminate.

It is important to distinguish between the time gap and the time headway between vehicles. The time headway indicates the elapsed time between the successive arrival of two consecutive vehicles at a detector. The time gap indicates the elapsed time between the departure of the first vehicle from the detector and the arrival of the second. The time gap is what is left of the headway after the detector occupancy time has been subtracted. A traffic-actuated controller using presence detectors views the passage of traffic in terms of gaps, not headways.

Difference between time headway and time gap

Gap Reduction Rate, GR

The gap reduction rate determines the speed at which the allowable gap is reduced in volume-density controllers as the green display continues. There are subtle differences in the definition of the gap reduction rate among controllers. For purposes of this project, a linear reduction rate (seconds reduction of gap per second of elapsed green time) will be assumed.

Pedestrian Walk + Don't Walk, WDW

WDW is the minimum time given to each phase when pedestrian demand is registered or the pedestrian recall is active. It includes both the pedestrian Walk and flashing Don't Walk intervals. These intervals are actually entered into the controller as two separate parameters but will be combined for purposes of this analysis. If the pedestrian timing function is not implemented in a particular phase, the WDW value should be entered as zero.

Maximum Green, MxG

MxG is a user-specified parameter, the effect of which will be discussed later. Local practice often plays an important part in the determination of maximum green times.

Intergreen Time, Y

The intergreen interval consists of a yellow change interval followed by an all-red clearance interval. These two intervals are entered separately into the controller but will be combined here to simplify the analysis.

Recall Mode

Recall mode determines how a phase will be treated in the absence of demand on the previous red phase. The options are as follows:

- None: the phase will not be displayed.
- Max: the phase will be displayed to its specified maximum length.
- Min: the phase will always be displayed to its specified minimum length but may be extended up to its specified maximum length by vehicle actuations.
- Ped: the phase will be given the full Walk plus flashing Don't Walk intervals and may be extended further, up to its specified maximum by vehicle actuations.
- Coord: a coordinated phase on the major street; this phase will always be displayed for its nominal design time, which may be increased by reassigning unused green time from actuated phases.

The recall function will have a significant effect on the operation of the controller. For example, the maximum recall option will have the effect of creating a nonactuated phase.

Minimum Vehicle Phase Time, MnV

MnV is actually a traffic engineering input that specifies the minimum time for which a phase must be displayed unless it is skipped because of lack of demand. It is implemented in a conventional traffic-actuated controller as the sum of three intervals: the initial interval, the minimum allowable gap (MnA), and the intergreen time (Y). As a matter of design, it is important that the controller settings be compatible with the minimum phase times determined by traffic engineering considerations.

This parameter did not appear earlier in this chapter because the chapter methodology procedure does not offer the ability to compute timing plans. Nevertheless, it is not possible to deal realistically with traffic-actuated control without recognizing the existence of a minimum phase time. For compatibility with other signal timing programs, the phase times include all intervals, including green, yellow, and all-red. For the purposes of the worksheet, the minimum phase time must be replaced by the maximum phase time ($MxG + Y$) if the recall-to-maximum mode is in effect.

Green-Time Estimation Model

The discussion of pretimed operation presented in this appendix indicates that the determination of required green time is a relatively straightforward process when the cycle length is given. However, traffic-actuated controllers do not recognize specified cycle lengths. Instead they determine, by a mechanical analogy, the required green time given the length of the previous red period and the arrival rate. They accomplish this by holding the right-of-way until the accumulated queue has been served.

The basic principle underlying all signal timing analysis is the queue accumulation polygon (QAP), which plots the number of vehicles queued at the stop line over the duration of the cycle. The QAP for a simple protected movement is illustrated in Exhibit B16-5. The queue accumulation takes place on the left side of the triangle (i.e., effective red) and the discharge takes place on the right side of the triangle (i.e., effective green). More complex polygons are generated when permitted movements occur when a

Queue accumulation polygon is a basic tool for analysis of signalized intersections

movement proceeds on more than one phase. The body of this chapter and Appendix E include a discussion on this subject.

EXHIBIT B16-5. QUEUE ACCUMULATION POLYGON ILLUSTRATING TWO METHODS OF GREEN-TIME COMPUTATION

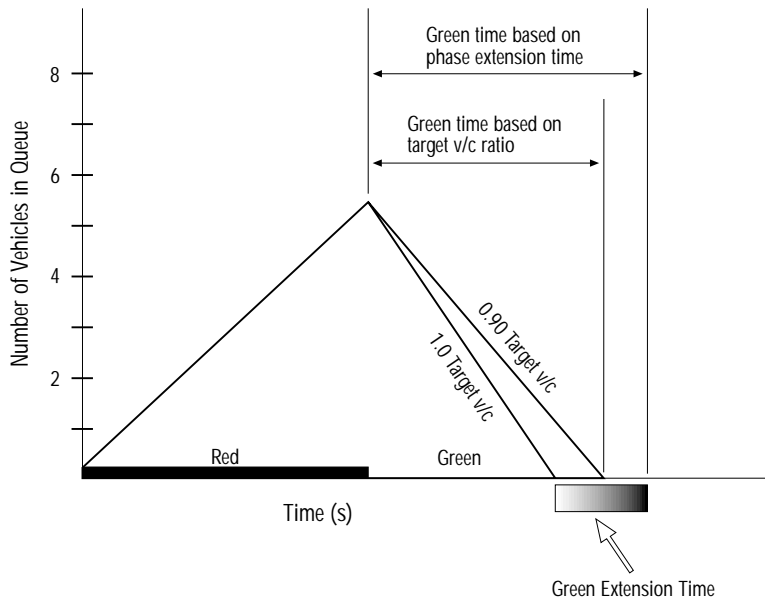

Two methods of determining the required green time given the length of the previous red are depicted in Exhibit B16-5. The first employs a target v/c approach. This method is the basis for the planning procedure described in Chapter 10 and for the discussion on timing plan design for pretimed control presented earlier in this appendix. Under this approach, the green-time requirement is determined by the slope of the line representing the target v/c of 0.9. If the phase ends when the queue has dissipated under these conditions, the target v/c will be achieved.

The second method recognizes the way a traffic-actuated controller really works. It does not deal explicitly with v/c ratios; in fact, it has no way of determining the v/c ratio. Instead it terminates each phase when a gap of a particular length is encountered at the detector. Good practice dictates that the gap threshold must be longer than the gap that would be encountered when the queue is being served. Assuming that gaps large enough to terminate the phase can only occur after the queue service interval (based on v/c = 1.0), the average green time may be estimated as the sum of the queue service time and the phase extension time as shown in Exhibit B16-5.

Queue Service Time

The queue service time, g_s , can be estimated using Equation B16-8.

$$g_s = f_q \frac{q_r r}{(s - q_g)} \tag{B16-8}$$

where

- g_s = queue service time (s);
- q_r, q_g = red arrival rate (veh/s) and green arrival rate (veh/s), respectively;
- r = effective red time (s);
- s = saturation flow rate (veh/s); and
- f_q = $1.08 - 0.1$ (actual green time/maximum green time)².

The queue calibration factor, f_q , accounts for randomness in arrivals (I).

Assumptions regarding headway distribution

Green Extension Time

To estimate the extension time analytically for a particular phase, it is necessary to determine the expected waiting time for a gap of a specific length, given the average intervehicular headways and some assumptions about the headway distribution. An analytical model for this purpose was developed (1, 2) on the basis of earlier work (3, 4). The average green extension time, g_e , is estimated from Equation B16-9, which is based on the use of a bunched exponential distribution of arrival headways. Equations B16-10, B16-11, and B16-12 are used to compute specific factors used in Equation B16-9.

$$g_e = \frac{e^{\lambda(e_0+t_0-\Delta)} - 1}{\phi q \lambda} \quad (B16-9)$$

where

- g_e = green extension time (s),
- q = vehicle arrival rate throughout cycle (veh/s),
- e_0 = unit extension time setting (s), and
- t_0 = time during which detector is occupied by a passing vehicle (s).

$$t_0 = \frac{3.6(L_d + L_v)}{S_A} \quad (B16-10)$$

where

- L_v = vehicle length, assumed to be 5.5 m,
- L_d = detector length, DL (m),
- S_A = vehicle approach speed (km/h),
- Δ = minimum arrival (intra-bunch) headway (s),
- ϕ = proportion of free (unbunched) vehicles, and
- λ = parameter calculated as

$$\lambda = \frac{\phi q}{1 - \Delta q} \quad (B16-11)$$

where λ is in vehicles per second for all lane groups that actuate the phase under consideration.

A detailed discussion of the bunched exponential model and the results of its calibration are given elsewhere (5, 6). The following relationship can be used for estimating the proportion of free (unbunched) vehicles in the traffic stream (ϕ):

$$\phi = e^{-b\Delta q} \quad (B16-12)$$

Note that b is a bunching factor. The recommended parameter values based on the calibration of the bunched exponential model using real-life and simulation data are summarized in Exhibit B16-6.

Computational Structure for Green-Time Estimation

This green-time estimation model is not difficult to implement, but it does not lead directly to the determination of an average cycle length or green time because the green time required for each phase is dependent on the green time required by the other phases. Thus, a circular dependency is established that requires an iterative process to solve. With each iteration, the green time required by each phase, given the green times required by the other phases, can be determined.

The logical starting point for the iterative process involves the minimum times specified for each phase. If these times turn out to be adequate for all phases, the cycle length will simply be the sum of the minimum phase times for the critical phases. If a particular phase demands more than its minimum time, more time should be given to that phase. Thus, a longer red time must be imposed on all of the other phases. This, in turn, will increase the green time required for the subject phase.

An iterative process is required to arrive at average times

EXHIBIT B16-6. RECOMMENDED PARAMETER VALUES

Case	Δ (s)	b
Single-lane	1.5	0.6
Multilane		
2 lanes	0.5	0.5
3 or more lanes	0.5	0.8

Simple Two-Phase Example

The circular dependency mentioned earlier will converge quite reliably through a series of repeated iterations. The convergence may be demonstrated by using a simple example. More complex examples will be introduced later to examine the effects of controller settings and traffic volumes in a practical situation.

Consider an intersection of two streets with a single lane in each direction. Each approach has identical characteristics and carries 675 veh/h with no left or right turns. The average headway is 2.0 s per vehicle and the lost time per phase is 3.0 s. Detectors are 9.1 m long with no setback from the stop line. The actuated controller settings are as follows:

Setting	Time (s)
Initial interval	10
Unit extension	3
Maximum green	46
Intergreen	4

The maximum phase time for each phase will be $(46 + 4) = 50$ s. The minimum phase time will be $10 + 3 + 4 = 17$ s, which will be the starting point for the timing computations. The first iteration will be used with a 34-s cycle with 17 s of green time on each approach. Allowing for lost time, the effective red time will be 20 s, and the effective green time will be 14 s for each phase.

The total lost time is the sum of two components, including the start-up lost time and the clearance lost time. In the methodology of this chapter, all of the lost time is assumed to be concentrated at the beginning of the green. This approximation is valid for delay estimation because the lost time is only used in the computation of effective green time, and its position in the phase is irrelevant.

However, for purposes of traffic-actuated timing estimation, the distribution of lost time throughout the phase will have a definite influence on the results. The lost time at the beginning of the phase will influence the length of the phase. The lost time at the end of the phase will influence the delay, but it will have no effect on the phase duration. It is recommended (7) that, for a specified lost time of n seconds, 1 s be assigned to the end of the phase and $n - 1$ s be assigned to the beginning. Thus, for this example, the start-up lost time (l_1) will be 2.0 s.

The computational process may be described as follows:

1. Compute the arrival rate throughout the cycle, q :

$$q = 675/3600 = 0.188 \text{ veh/s}$$
2. Compute the net departure rate (saturation flow rate – arrival rate):

$$(s - q) = \frac{1800}{3600} - 0.188 = 0.312 \text{ veh/s}$$
3. Compute the queue at the end of 20 s of effective red time:

$$q_r = 20 * (0.188) = 3.760 \text{ veh}$$
4. Compute the queue calibration factor, f_q :

$$f_q = 1.08 - 0.1 (13/46)^2 = 1.072$$
5. Compute the time required to serve the queue, g_s :

$$g_s = 1.072 (3.760/0.312) = 12.919 \text{ s}$$

Guidelines on lost-time assumptions

After 12.919 s of effective green time, the queue will have been served and gaps will start to be observed at the detector. The start-up lost time ($l_1 = 2$) must be added to the queue service time for purposes of determining the total phase time requirements. The question now is how long one would expect to wait for a gap of 3.0 s.

6. Determine the parameters of Equation B16-12 as follows:

$$\begin{aligned}\Delta &= 1.5 \text{ and } b = 0.6, \text{ from Exhibit B16-6} \\ \phi &= e^{-b\Delta q} \\ &= e^{-(0.6 * 1.5 * 0.188)} = 0.844 \\ \lambda &= \frac{\phi q}{1 - \Delta q} = \frac{(0.844)(0.188)}{1 - (1.5)(0.188)} = 0.221\end{aligned}$$

7. Determine the occupancy time of the detector for a vehicle length of 5.5 m, a detector length of 9.1 m, and an approach speed of 50 km/h:

$$t_0 = \frac{3.6(9.1 + 5.5)}{50} = 1.051 \text{ s}$$

This is assuming that the detector sensor is operating in the presence mode.

8. Apply Equation B16-9 to determine the expected green extension time, g_e :

$$\begin{aligned}g_e &= \frac{e^{\lambda(e_0 + t_0 - \Delta)}}{\phi q} - \frac{1}{\lambda} \\ &= \frac{e^{0.221(3.0 + 1.051 - 1.5)}}{(0.844)(0.188)} - \frac{1}{0.221} \\ &= 6.550 \text{ s}\end{aligned}$$

9. Compute the total phase time:

$$\begin{aligned}G &= l_1 + g_s + g_e + Y \\ G &= 2.0 + 12.919 + 6.550 + 4.0 = 25.469 \text{ s}\end{aligned}$$

10. Compute the phase time deficiency as the difference between the trial phase time and the computed phase time, or $25.469 - 17.0 = 8.469$ s.

This computation indicates that the trial phase time was not adequate to satisfy the rules under which the controller operates. It also suggests a new trial green time of 25.469 s and a cycle length of 50.938 s for the next iteration.

The next iteration will still produce a green-time deficiency because the red time has been increased. However, this deficiency will be smaller. Successive iterations will produce successively smaller green time deficiencies until eventually the solution will converge. This process is illustrated in Exhibit B16-7. The solution converged (i.e., the green-time deficiency became negligible) at a phase time of 37.710 s, producing a cycle length of 75.420 s. This convergence was based on a threshold of 0.1 s difference in the computed cycle length between iterations. In other words, the process terminated when the cycle lengths on two successive iterations fell within 0.1 s of each other.

As a matter of interest, consider the effect of reducing the unit extension time, e_0 , from 3.0 s to 2.0 s. This reduction would be expected to reduce the green extension time, g_e , for both phases and to shorten the resulting cycle length. The extent of the reduction may be estimated by repeating all of the steps described above with the new value for g_e . In the first iteration, the queue service time will remain the same, but the green extension time will be reduced from the value of 6.550 s computed above to 4.354 s. Repeated iterations with this lower unit extension time would converge to a cycle length of 65.618 s.

In this example, the green time for both phases was determined by the sum of the queue service time and the extension time. Phase times will also be constrained by their specified maximum and minimum times.

Guideline for termination of iterations

EXHIBIT B16-7. CONVERGENCE OF GREEN-TIME COMPUTATION BY ELIMINATION OF GREEN-TIME DEFICIENCY

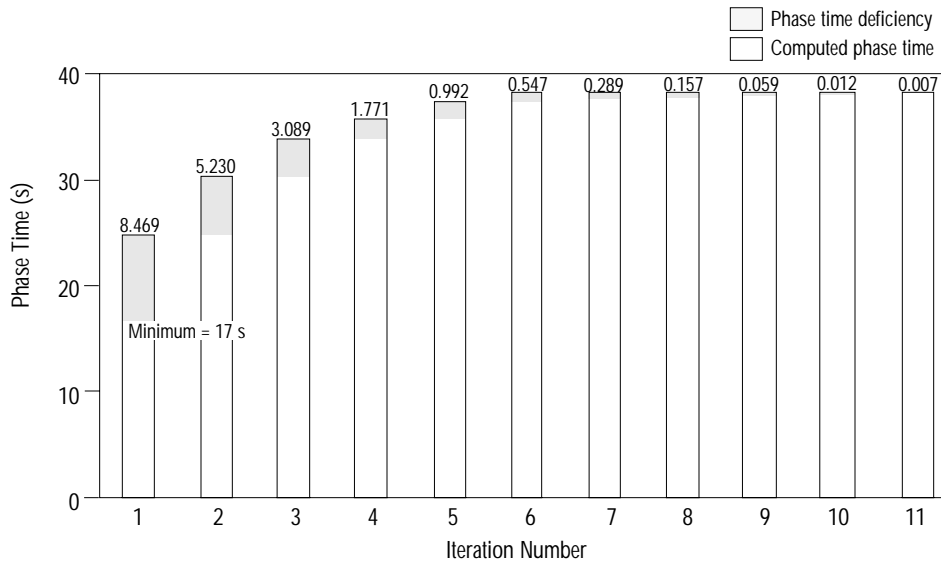

Minimum Phase Times

The specified minimum green-time constraints are valid only for pretimed phases and phases that are set to recall to the minimum time regardless of demand. The significance of the minimum time for an actuated phase is that the phase must be displayed for its specified minimum unless it is skipped because of lack of demand. This situation may be addressed analytically by determining the probability of zero arrivals on the previous cycle. Assuming a Poisson arrival distribution, Equation B16-13 may be used.

$$P_{0v} = e^{-qC} \tag{B16-13}$$

where

- P_{0v} = minimum phase time (s),
- q = vehicle arrival rate (veh/s), and
- C = cycle length for the current iteration (s).

Assuming that the phase will be displayed for the minimum time, except when no vehicles have arrived, the adjusted minimum phase time is computed using Equation B16-14:

$$AVM = MnV (1 - P_{0v}) \tag{B16-14}$$

where

- AVM = adjusted vehicle minimum time (s), and
- MnV = specified minimum green time from worksheet in Exhibit B16-4 (s).

This relationship also has circular dependencies because as the adjusted minimums become shorter, the probability of zero arrivals also becomes higher, which further reduces the adjusted minimums. Fortunately, the solution fits well into the iterative scheme that was just described.

The use of adjusted minimum green times offers a practical method for dealing with phases that are not displayed on each cycle but may have their minimum durations determined by agency policy. The concept applies equally well to pedestrian minimum times.

Multiphase Operation

Three important tools have been introduced for estimating the timing plan at traffic-actuated signals: a model for predicting the green time for any phase given the length of the previous red period, an iterative computational structure that converges to a stable value for the average cycle length and green times, and a procedure to account for minimum green times with low volumes. These concepts were illustrated in a simple example, but fortunately they are robust enough to deal with the practical complexities of traffic-actuated control. These complexities include multiphase operation (both single- and dual-ring), permitted left turns (both exclusive and shared lanes), and compound left-turn protection (both leading and lagging).

Two extensions to the methodology presented to this point are required to deal with more complex situations. The first is the extension of the QAP from its simple triangular shape to a more complex shape that represents different arrival and departure times at different points in the cycle. The second is a procedure to synthesize a complete single-ring equivalent sequence by combining critical phases in the dual-ring operation. The QAP extensions will be considered first.

Exhibit B16-5 presented the triangular QAP for a protected movement from an exclusive lane. There are four other cases to be considered, including permitted left turns from an exclusive lane, permitted left turns from a shared lane, protected-plus-permitted left turns, and permitted-plus-protected left turns. The QAP shapes for these cases are shown in Exhibits B16-8 through B16-11. Each of the exhibits conforms to a common terminology with respect to its labeling. Intervals are illustrated along the horizontal axis as follows:

- r = effective red time,
- g_q = portion of permitted green time blocked by a queue of opposing vehicles,
- g_u = portion of permitted green time not blocked by a queue of opposing vehicles,
- g_s = portion of protected green time required to serve queue of vehicles that accumulated on previous phases,
- g_e = extension to protected green time that occurs while controller waits for a gap in arriving traffic long enough to terminate the phase, and
- g_f = portion of green time in which a through vehicle in a shared lane would not be blocked by a left-turn vehicle waiting for opposed movement to clear. (This condition occurs only at the beginning of the permitted green when one or more through vehicles are at the front of the queue.)

Note that, in each case, the phases are arranged so that the protected phase is the last to occur. The length of this phase will be determined by its detector actuations. The actual length will be the sum of the time required to serve the queue that exists at the beginning of the phase plus the extension time.

Points in the cycle at which the queue size is important to the computations are also identified as follows:

- Q_r = queue size at end of effective red;
- Q_q = queue size at end of interval g_q ;
- Q_p = queue size at end of permitted green period;
- Q'_p = queue size at end of permitted green period, adjusted for sneakers;
- Q_{ga} = queue size at beginning of protected green (green arrow) period; and
- Q_f = queue size at end of interval g_f .

Extension of the methodology to

- Account for different arrival and departure times at points in cycle
- Synthesize dual-ring into equivalent single-ring sequence

EXHIBIT B16-8. QUEUE ACCUMULATION POLYGON FOR PERMITTED LEFT TURNS FROM EXCLUSIVE LANE

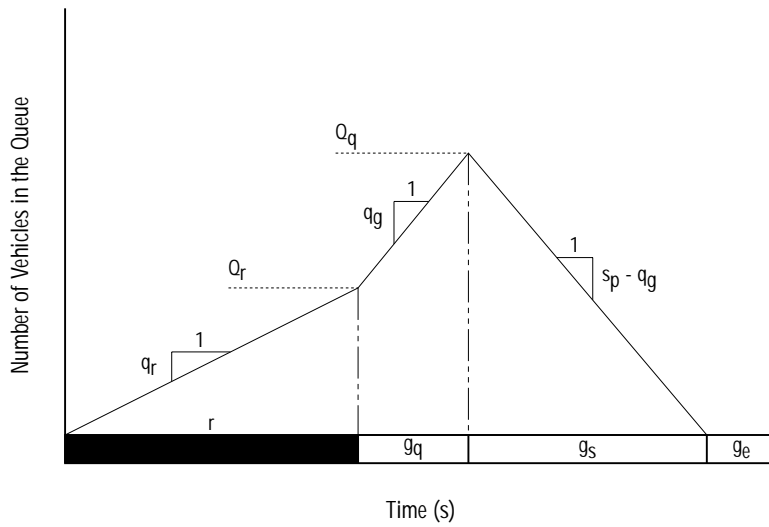

Note:
 s_p is saturation flow under permitted operation.

EXHIBIT B16-9. QUEUE ACCUMULATION POLYGON FOR PERMITTED LEFT TURNS FROM SHARED LANE

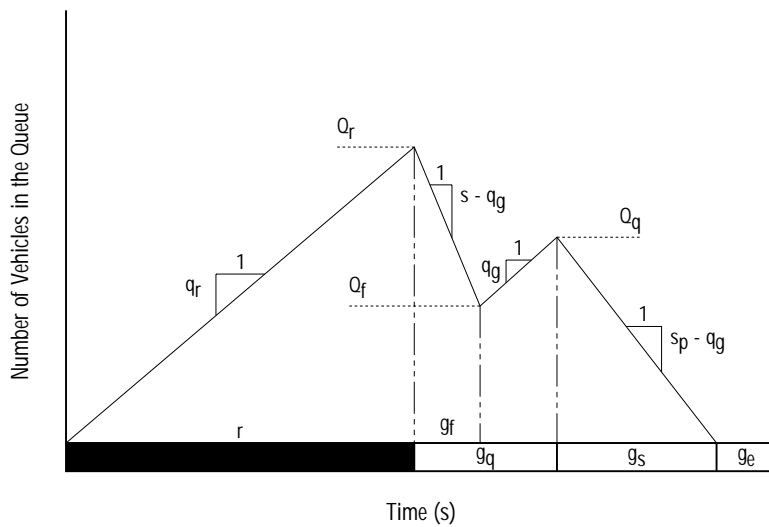

EXHIBIT B16-10. QUEUE ACCUMULATION POLYGON FOR PROTECTED-PLUS-PERMITTED LEFT-TURN PHASING WITH EXCLUSIVE LEFT-TURN LANE

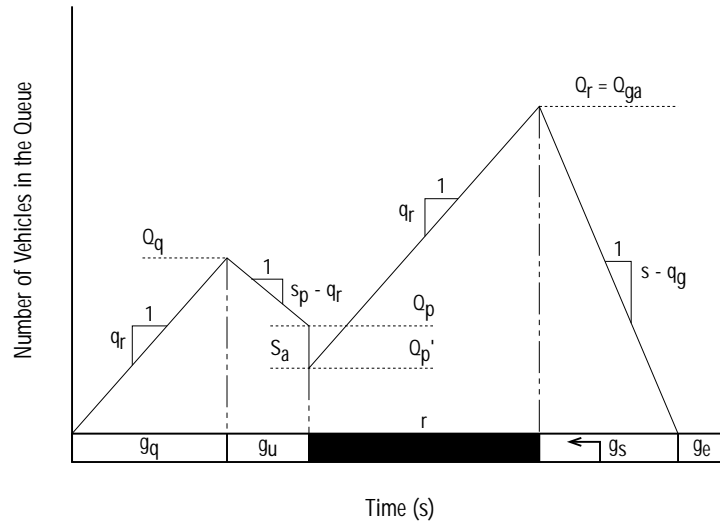
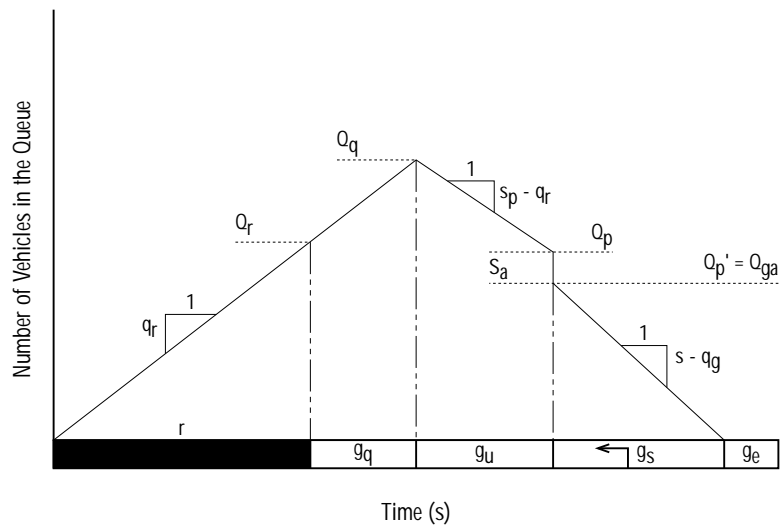

EXHIBIT B16-11. QUEUE ACCUMULATION POLYGON FOR PERMITTED-PLUS-PROTECTED LEFT-TURN PHASING WITH EXCLUSIVE LEFT-TURN LANE



The shape of each QAP is based on termination by a gap that exceeds the unit extension, allowing the full extension time, g_e , to be displayed. When a phase terminates on the maximum green time, the extension time may be reduced or eliminated. If a permitted left-turn phase terminates before the queue has been served, a maximum of two sneakers will be discharged from the queue at that point.

These extensions to the QAP analysis will accommodate all of the practical conditions covered by the methodology presented in the body of this chapter. The remaining issue to be dealt with is the synthesis of the complete cycle by combining critical phases in a dual-ring operation. This procedure may be carried out using the worksheet shown in Exhibit B16-12. The structure of this worksheet is compatible with the dual-ring concurrent phasing depicted in Exhibit B16-2.

EXHIBIT B16-12. TRAFFIC-ACTUATED TIMING COMPUTATIONS

	East-West Movements					North-South Movements				
	A		B		Total	A		B		Total
Ring 1: Phases reversed?	No	Yes	No	Yes		No	Yes	No	Yes	
Movements	WBL	EBT	EBT	WBL		SBL	NBT	NBT	SBL	
Phase times										
Ring 2: Phases reversed?	No	Yes	No	Yes		No	Yes	No	Yes	
Movements	WBL	EBT	EBT	WBL		SBL	NBT	NBT	SBL	
Phase times										
Difference: ABS (Ring 1 - Ring 2)										
Cycle time components: Independent termination										
Simultaneous termination										

The east-west movements (left side of the barrier) are shown in the first three columns. The first column, labeled A, represents the first phase (1 or 5) in each ring. The second column represents the second phase (2 or 6). The third column will contain the total of the phase times. The same format is repeated in the next three columns for the north-south movements (right side of the barrier).

There are three rows for each of the two rings. The first row indicates whether the phase pair is reversed. This information was entered on the input data worksheet presented earlier in this appendix. The next two rows give the movements and phase times for their respective phases. If the phases are not reversed, the assignments will be shown in the dual-ring configuration of Exhibit B16-2. If they are reversed, the through movements will appear in Column A and the left turns in Column B. Note that the movements in a given phase pair cannot be interchanged if the left turn is not protected. The order of the phases in the pair does not affect the total phase time entered in the Total column.

The next row contains the absolute value of the phase time difference between the two rings. Values are entered for each of the six columns.

The components of the cycle time must now be determined and entered in the cycle time components row. The procedure will depend on whether the first phase termination is simultaneous or independent. For simultaneous termination, enter the maximum value of each phase in the A and B columns (Ring 1 or 2, whichever time is greater). For independent termination, enter the maximum value of the total time (A + B) from Ring 1 or 2. So for each side of the barrier, either A and B columns or the Total column will have an entry, but not all three columns. This procedure should be carried out for both sides of the barrier. Remember that the termination treatment may be different on either side. The cycle length may now be determined as the sum of all the entries in the cycle time components row.

If the computed cycle length agrees with the cycle length determined on the previous iteration, no further action is necessary. If not, this timing plan will serve as the starting point for the next iteration.

COORDINATED SEMIACTUATED OPERATION

It is possible that nonactuated phases under semiactuated control may be coordinated with neighboring intersections. In the most common coordination scheme, a background cycle length is imposed. The actuated phases receive their allotment of green time in the usual manner, except that their maximum green times are controlled externally to ensure conformance with the specified cycle length. If the actuated phases require all of their nominal green-time allotment, the intersection operates in a more or less pretimed manner. If they do not, the unused time is reassigned to the coordinated phase.

Iterative procedure

The analysis of coordinated operation requires another iterative loop, which executes the procedure described in this appendix, adding more green time incrementally to the coordinated phases until the design cycle length has been reached. The result is a timing plan that approximates the operation of the controller in the field.

The procedure for timing plan estimation in coordinated systems requires that a design timing plan be established first, with phase splits that add up to the design cycle length. This plan becomes the starting point for the iterative procedure that involves the following steps.

1. Set up the controller timing parameters for the initial timing plan computations. The coordinated major-street phases (usually 2 and 6) should be set for recall to maximum. The maximum green times for all phases should be determined by their respective splits in the pretimed timing plan. No recall modes should be specified for any of the actuated phases.

2. Perform the timing computations to determine the resulting cycle length. If the maximum green times have been specified correctly in Step 1, the computed cycle length will not exceed the specified cycle length.

3. If the computed cycle length is equal to the specified cycle length, there is no green time available for reassignment. In this case the procedure will be complete and the final timing plan will be produced.

4. If the computed cycle length is lower than the specified cycle length, some time should be reassigned to the major-street phases by increasing the maximum green times for the coordinated phases. The recommended procedure is to assign one-half of the difference between the computed cycle and the specified cycle to the coordinated phases. This procedure provides a reasonable speed of convergence without overshooting the specified cycle length.

5. Repeat Steps 2 through 4 iteratively until the computed and specified cycle lengths converge.

MULTIPHASE EXAMPLE

The complete timing estimation procedure described in this appendix will now be applied using a multiphase example. In the discussion of this example presented previously in this appendix, an initial timing plan was developed using the planning procedure. The green times were then modified by trial and error to arrive at a signal timing plan for analyzing capacity, delay, and LOS.

The intersection layout for this example is shown in Exhibit B16-13. Note that all left turns take place from exclusive lanes. The northbound and southbound left turns have protected-plus-permitted phasing. The eastbound and westbound left turns are permitted, with no protected phases.

The timing plan design is as follows:

Phase 1: NB and SB left turns	11 s
Phase 2: NB and SB green	54 s
Phase 3: EB and WB green	<u>30 s</u>
Cycle length	95 s

This timing plan was shown to accommodate all movements with no oversaturation. The average delay per vehicle for all approaches combined was 23 s.

The timing estimation methodology will now be exercised for this example using several different values for some of the actuated controller settings to observe the effect on the results. The detector configuration will use loop detectors 9.1 m long and positioned at the stop line with no setback. A 50-km/h speed will be assumed for all approaches. Both isolated and coordinated operation will be explored. Different values will be used for the unit extension and maximum green settings. Three unit extension settings will be used:

- Short values of 1.5 s and 2.0 s for two-lane and one-lane approaches, respectively, representing a condition sometimes referred to as snappy operation.

- Medium values of 2.5 s and 3.5 s for two-lane approaches and one-lane approaches, respectively, the standard condition for most intersections.
- Long values of 3.5 s and 4.5 s for two-lane approaches and one-lane approaches, respectively, representing a condition sometimes referred to as sluggish operation.

EXHIBIT B16-13. INTERSECTION LAYOUT FOR MULTIPHASE EXAMPLE

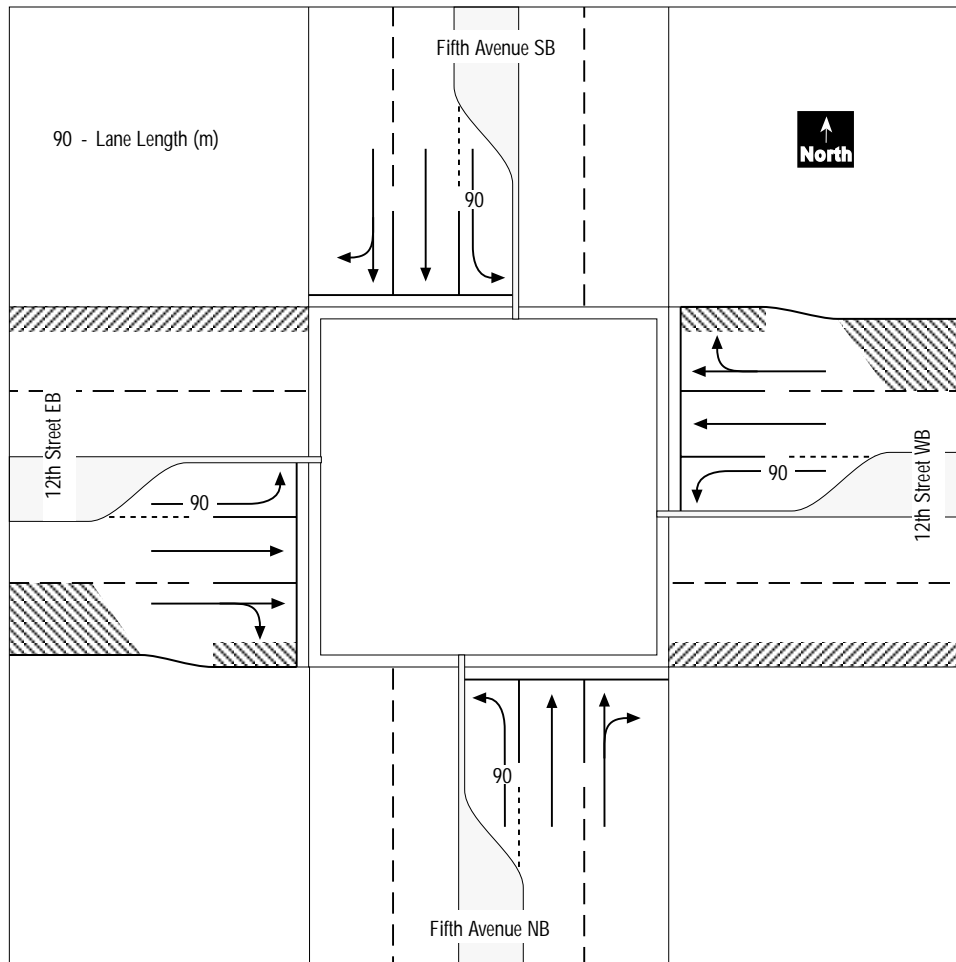

These values represent the actual gap between vehicles that will cause a phase to terminate. With the assumed approach speed and detector configuration, each vehicle (assumed length is 5.5 m) passing over the loop will occupy the detector for an additional 1.08 s.

Three different values for maximum green times will also be investigated. The first will use very long maximum times (120 s for each phase) to determine how the intersection would operate if most phases terminated on the unit extension. The second will use maximum times that are proportional to the design times for each phase. It has been proposed that the maximum extensions be set at 125 and 150 percent of the design green times. A more complex scheme has been proposed that results in maximum times in the range of 150 to 200 percent of the design times. For purposes of this exercise, the maximum times will be set at 150 percent of the design times, representing a value somewhere in the middle of the range suggested in the literature. The third value will use the actual design green times as maximums to constrain the operation to its original design.

Recognizing that much of the benefit of traffic-actuated control is derived from the ability of the controller to respond to fluctuations in traffic volumes throughout the day, the operation will also be examined by using volume levels of 70 percent of the peak-hour levels reflected in the original data. Coordinated operation will also be examined at the reduced volume levels to observe the reassignment of unused green time from the actuated phases to the nonactuated phases to reduce the delay to arterial traffic.

The first conditions to be analyzed involve 100 percent volume levels, 120-s maximum green time on each phase, and short unit extensions. The input data worksheet for this example is shown in Exhibit B16-14. The resulting cycle length is 258.2 s. Because of the dual-ring operation, an overlap phase for the north-south approaches appears in the results. The estimated average phase times are as follows:

NB and SB left	17.2 s
SB through and left	15.0 s
NB and SB green	144.0 s
EB and WB green	<u>82.0 s</u>
Cycle length	258.2 s

EXHIBIT B16-14. TRAFFIC-ACTUATED CONTROL DATA FOR MULTIPHASE EXAMPLE

Traffic-Actuated Control Input Data Worksheet								
Example Problem 3: Fifth Avenue at 12th Street								
Approach Data	Northbound		Southbound		Eastbound		Westbound	
LT treatment	3		3		1		1	
LT position	Lead		Lead		N/A		N/A	
Sneakers	2.0		2.0		2.0		2.0	
Free queue	0.00		0.00		0.00		0.00	
Speed	50		50		50		50	
Termination	--Independent--				--N/A--			
Ring 1				Ring 2				
Phase Data	1 (WBL)	2 (EBT)	3 (NBL)	4 (SBT)	5 (EBL)	6 (WBT)	7 (SBL)	8 (NBT)
Phase type	X	G	L	G	X	G	L	G
PH reversal?		No	No	No		No	No	No
Det length		30	30	30		30	30	30
Setback		0	0	0		0	0	0
Max initial		16	4	16		16	4	16
Min gap		1.5	2.0	1.5		1.5	2.0	1.5
Walk + FDW		22	0	22		22	0	22
Max green		120	120	120		120	120	120
Change + clr		4.0	4.0	4.0		4.0	4.0	4.0
Recall mode		N	N	N		N	N	N
Veh min		22	10	22		22	10	22
Min initial		16.5	4.0	16.5		16.5	4.0	16.5
Max PH time		124	124	124		124	124	124

This timing plan, when analyzed by the procedure described in the body of this chapter, produces results shown on the LOS worksheet in Exhibit B16-15. Note that the average delay per vehicle is 47.4 s, which is considerably higher than the 23-s/veh delay associated with the timing plan developed in Example Problem 3. The logical conclusion here is that the peak-hour volumes cannot be handled in an optimal manner by a fully actuated controller without some influence being exerted on the timing plan through maximum green constraints.

EXHIBIT B16-15. LOS RESULTS FOR MULTIPHASE EXAMPLE

LOS Worksheet											
Direct/ Ln Grp	v/c Ratio	g/C Ratio	Delay d ₁	Del Adj Fact	Lane Group Cap	Calib d ₂	Delay d ₂	Lane Grp Delay	Lane Grp LOS	Delay by App	LOS by App
NB											
L	0.735	0.118	20.6	0.850	181	16	9.6	27.1	D	58.6	E
TR	1.026	0.508	44.5	0.850	1689	16	23.2	61.0	F		
SB											
L	1.866	0.256	66.3	0.850	224	16	19.3	75.6	F	29.4	D
TR	0.535	0.571	23.9	0.850	1890	16	0.2	20.6	C		
EB											
L	0.884	0.332	57.1	0.850	80	16	43.1	91.7	F	48.4	E
TR	0.478	0.332	48.0	0.850	888	16	0.3	41.1	E		
WB											
L	0.773	0.332	54.3	0.850	153	16	14.1	60.3	F	47.7	E
TR	0.666	0.332	51.8	0.850	937	16	1.3	45.3	E		
Intersection Delay = 47.4 s/veh						Intersection LOS = D					

A total of 10 alternatives, similar in concept to the one just described, were analyzed using combinations of these conditions. For each analysis, the average phase times and cycle length were recorded along with the average delay per vehicle and any movements that were oversaturated. The results are summarized in Exhibit B16-16.

Ten alternatives were analyzed (see Exhibit B16-16)

EXHIBIT B16-16. COMPARISON OF TRAFFIC-ACTUATED CONTROLLER SETTINGS FOR MULTIPHASE EXAMPLE

Volume Level	Maximum Green Time (s)	Gap (s)	Estimated Phase Times (s)					Average Delay (s/veh)	Comments
			NSL	SBT + L	NSG	EWG	Cycle		
100%	Set to 120 s for all phases to eliminate maximum green constraints	Short	17.2	15.0	124.0	82.0	238.2	47.4	NB v/c = 1.02
		Med	19.2	16.3	124.0	85.3	244.8	51.6	NB v/c = 1.04
		Long	20.8	17.4	124.0	88.7	250.9	56.6	NB v/c = 1.07
	Set to 150% of the design splits indicated in Example Problem 3	Med	13.4	1.6	79.0	43.0	137.0	28.9	EB v/c = 1.07
70%	Set to 100% of the design splits indicated in Example Problem 3	Med	10.2	0.8	54.0	30.0	95	22.9	Same as in Example Problem 3 results
		Short	6.8	1.8	31.7	22.0	62.3	10.2	
		Med	7.5	2.1	35.4	22.0	67.0	10.2	
	Long	8.4	2.4	41.7	24.1	76.6	10.6		
Set to 150% of the design splits indicated in Example Problem 3 (no overlap phase)	Med	10.3		60.0	25.2	95.5	11.9	North-south phases coordinated; east-west phases coordinated	
	Med	12.4		45.4	36.0	93.8	14.4		

It is clearly essential that some maximum green times must be imposed to control the apportionment of time between the competing phases

The interpretation is that when traffic volumes are close to capacity, as they are in this example, the maximum green times must be used to apportion the time among the competing phases

Appendix B provides a reasonable approximation of traffic-actuated operation

In the first three alternatives, only the unit extensions (short, medium, and long) were changed. Note that the cycle length increased with the unit extensions from 238 s (short) to 251 s (long). In all cases, the northbound green phase reached its maximum of 124 s (i.e., 120 s green plus 4 s intergreen). Because the northbound phase was already at its maximum length, it lost time proportionally as the other phases increased and therefore became more oversaturated. It is clearly essential that some maximum green times must be imposed to control the apportionment of time between the competing phases.

The next two analyses used the medium extension times and evaluated both of the strategies for setting the maximum green intervals in proportion to their design values. The average delay was reduced to 29 s/veh for the 150 percent strategy and to 23 s/veh for the 100 percent strategy. The 150 percent strategy produced slightly oversaturated conditions for the eastbound approach. Note that the results of the 100 percent strategy were identical to the results reported in the discussion of the design timing plan for Example Problem 3 in the body of this chapter. The interpretation is that when traffic volumes are close to capacity, as they are in this example, the maximum green times must be used to apportion the time among the competing phases. The gap termination tactic does not ensure a satisfactory distribution of green times.

One of the major benefits of traffic-actuated control is its ability to respond to short-term and daily fluctuations in traffic volumes. To illustrate this principle, volumes are reduced across the board to 70 percent of their peak values. The analysis using 120-s maximum green times on all phases is repeated with the three levels of unit extension. The results indicate that the cycle length varies from 62.3 to 76.6 s throughout the full range of unit extension settings. The average delays are almost identical for these three cases, varying from 10.2 to 10.6 s/veh. This result indicates that when the traffic volumes drop below their saturation levels, it is no longer necessary to control the distribution of green times using the maximum green settings. An important observation here is that the same controller settings would be able to control both the full and reduced volume settings effectively provided that the maximum greens are optimized for the high-volume conditions.

The final two cases deal with coordinated operation. Each of the intersecting routes is assumed to be coordinated in separate cases. The design timing plan, based on a 95-s cycle, is used to establish nominal splits for the coordinated operation. The medium unit extensions are used in combination with maximum green times that reflect 150 percent of the design timing plan. Because the design timing plan includes no overlap, the input data values were adjusted to require simultaneous termination of the first (i.e., left-turn) phases that accommodate the northbound and southbound traffic as opposed to independent termination.

The results indicate that the cycle length established by the iterative computations falls within 1.0 s of the design cycle length. In the case involving east-west coordination, the east-west phases receive more than their nominal allotment of time at the expense of the north-south movements. The reverse is true when coordination is established for the north-south approaches. The delay is also reduced on the approaches that are coordinated and increased on those that are not.

LIMITATIONS OF TRAFFIC-ACTUATED TIMING ESTIMATION PROCEDURE

The traffic-actuated estimation procedure described in this appendix provides a reasonable approximation of the operation of a traffic-actuated controller for nearly all of the conditions encountered in practice. The results obtained from this procedure have correlated well with extensive simulation data and with limited field studies (7). However, the procedure involves a deterministic analytical representation of an extremely complex stochastic process and therefore has some limitations that must be recognized.

Some of the limitations result from unique situations that cannot be modeled analytically in a satisfactory manner. One example is the case of compound left-turn protection with opposing shared lanes for left turns and through movements. The chapter

methodology deals with this as a separate case and applies an empirical treatment to determine the saturation flow adjustment factor for left turns. Simulation provides the only effective way to estimate the timing plan parameters for this case.

The sample problem presented in this appendix demonstrates the sensitivity of the procedure to the unit extension times set in the controller. As expected, longer unit extension times produce longer average green times except when constrained by the maximum green-time settings. Shorter extension times have the opposite effect. There is, however, a lower limit to the range of unit extension times that can be modeled realistically. It is well known in practice that when the unit extension times are too short, premature terminations of a phase may result because of anomalies in the departure headways created primarily by lapses in driver attention. The traffic-actuated control model described in this appendix assumes a constant departure headway and therefore does not reflect this phenomenon. Simulation models introduce a stochastic element into the departure headways based on a theoretical distribution. They are therefore able to invoke premature phase terminations to some extent, but they do not deal with anomalous driver behavior.

As a practical matter, unit extensions should reflect headways at least 50 percent longer than the expected departure headways. For example, assuming a 2-s average departure headway, unit extensions should accommodate up to a 3-s departure headway without terminating the phase. Assuming a detector occupancy time of 1 s, this implies a 2-s gap. The minimum practical value for the unit extension is 2 s. Smaller values may be appropriate in multiple-lane cases in which the average departure headways are shorter.

The analysis of permitted left turns from shared lanes always poses special problems. The semi-empirical treatment prescribed for shared-lane permitted left turns in the body of the chapter does not lend itself to the iterative timing estimation procedure described in this appendix. An analytical approximation of the shared-lane model was therefore substituted to ensure stable convergence of the solution. This produces timing plans that agree well with simulation results; however, the analysis of delay resulting from the timing plan will not always agree with the results of the chapter method. It appears that an iterative method of achieving equilibrium between the shared lane and the adjacent through lanes in the chapter methodology is a prerequisite to the development of a satisfactory timing estimation procedure.

When traffic volumes are extremely low, the timing plan becomes somewhat of an obstruction unless the recall function is used for each phase. In the absence of demand, the green indication rests on the phase that received the latest demand and may do so for several minutes. This operation implies that very long red times will be displayed on some phases; however, no delay will be associated with these red times because no vehicles will be affected. The procedure described in this appendix will compute very short equivalent red times for these phases in an attempt to provide a signal timing plan that will produce realistic delays.

REFERENCES

1. *Signalized Intersection Capacity Method*. NCHRP Project 3-28(2). JHK & Associates, Tucson, Ariz., Feb. 1983.
2. *Signalized Intersection Capacity Study*. Final Report, NCHRP Project 3-28(2). JHK & Associates, Tucson, Ariz., Dec. 1982.
3. Berry, D. S. Other Methods for Computing Capacity of Signalized Intersections. Presented at the 56th Annual Meeting of the Transportation Research Board, Washington, D.C., Jan. 1977.
4. Berry, D. S., and P. K. Gandhi. Headway Approach to Intersection Capacity. In *Highway Research Record 453*, HRB, National Research Council, Washington, D.C., 1973.

5. Miller, A. J. *The Capacity of Signalized Intersection in Australia*. Australian Road Research Bulletin 3. Australian Road Research Board, Kew, Victoria, Australia, 1968.
6. Webster, F. V., and B. M. Cobbe. *Traffic Signals*. Her Majesty's Stationery Office, London, England, 1966.
7. Messer, C. J., and D. B. Fambro. Critical Lane Analysis for Intersection Design. In *Transportation Research Record 644*, TRB, National Research Council, Washington, D.C., 1977.

APPENDIX C. LEFT-TURN ADJUSTMENT FACTORS FOR PERMITTED PHASING

The left-turn adjustment factors in Exhibit C16-1 reflect different cases under which turns may be made.

EXHIBIT C16-1. ADJUSTMENT FACTORS FOR LEFT TURNS (f_{LT})

Case	Type of Lane Group	Left-Turn Factor, f_{LT}
1	Exclusive LT lane; protected phasing	0.95
2	Exclusive LT lane; permitted phasing	Special procedure; see worksheet in Exhibit C16-9 or C16-10
3	Exclusive LT lane; protected-plus-permitted phasing	Apply Case 1 to protected phase; apply Case 2 to permitted phase
4	Shared LT lane; protected phasing	$f_{LT} = 1.0 / (1.0 + 0.05 P_{LT})$
5	Shared LT lane; permitted phasing	Special procedure; see worksheet in Exhibit C16-9 or C16-10
6	Shared LT lane; protected-plus-permitted phasing	Apply Case 4 to protected phase; apply Case 5 to permitted phase

When permitted left turns exist, either from shared lanes or from exclusive lanes, their impact on intersection operations is complex. The procedure outlined in Appendix C is applied to Cases 2, 3, 5, and 6 discussed earlier in this chapter. The basic case for which this model was developed is one in which there are simple permitted left turns from either exclusive or shared lanes. This case does not consider the complications of protected-plus-permitted phasing nor cases in which an opposing leading left phase may exist.

Consider Exhibit C16-2, which shows a permitted left turn being made from a shared lane group. When the green is initiated, the opposing queue begins to move. While the opposing queue clears, left turns from the subject direction are effectively blocked. The portion of effective green blocked by the clearance of an opposing queue of vehicles is designated g_q . During this time, the shared lane from which subject left turns are made is blocked when the left-turning vehicle arrives. Until the first left-turning vehicle arrives, however, the shared lane is unaffected by left turners. The portion of the effective green until the arrival of the first left-turning vehicle is designated g_f .

Once the opposing queue of vehicles clears, subject left-turning vehicles filter through an unsaturated opposing flow at a rate affected by the magnitude of the opposing flow. The portion of the effective green during which left turns filter through the opposing flow is designated g_u .

The opposing queue must clear before left turns can begin filtering through

EXHIBIT C16-2. PERMITTED LEFT TURN FROM SHARED LANE

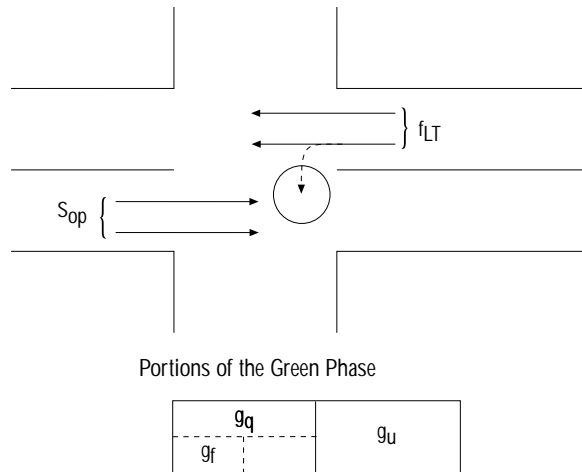

This division of the effective green phase for permitted left turns creates up to three distinct periods for which the impact of left turns on a shared or exclusive left-turn lane must be considered.

- g_f : Until the arrival of the first left-turning vehicle, a shared lane is unaffected by left turns. During this period of time, the effective left-turn adjustment factor is logically 1.0 because no left turns are present. By definition, $g_f = 0.0$ for exclusive permitted left-turn lanes because it is assumed that a queue of left turners is present at the beginning of the phase.

- $g_q - g_f$: If the first left-turning vehicle arrives before the opposing queue clears, it waits until the opposing queue clears, blocking the shared lane, and then seeks a gap in the unsaturated opposing flow that follows. During this period of time, there is effectively no movement in the shared lane, and the left-turn adjustment factor (f_{LT}) applied to the shared lane is logically 0.0.

When the first left-turning vehicle arrives after the opposing queue clears, this period of time does not exist; that is, $g_q - g_f$ has a practical minimum value of zero. The value of g_q has a practical range of 0.0 to g .

- g_u : After the opposing queue clears, left-turning vehicles select gaps through the unsaturated opposing flow. These gaps occur at a reduced rate because of the interference of opposing vehicles and the effect of this interference on other vehicles in the shared lane from which left turns are made. For this period, Exhibit C16-3 is used to assign E_{L1} through-car equivalents for each left-turning vehicle. Then an adjustment factor can be computed for this period by using Equation C16-1:

$$\frac{1}{[1.0 + P_L(E_{L1} - 1)]} \tag{C16-1}$$

where

- P_L = proportion of left-turning vehicles in shared lane, and
- E_{L1} = through-car equivalent for permitted left turns (veh/h/ln).

For exclusive permitted left-turn lanes, $P_L = 1.0$. On the basis of this conception of permitted left-turn operations, the left-turn adjustment factor for the lane from which permitted left turns are made can be computed by Equation C16-2.

$$f_m = \left(\frac{g_f}{g}\right)(1.0) + \left[\frac{g_q - g_f}{g}\right](0.0) + \left(\frac{g_u}{g}\right)\left[\frac{1}{1 + P_L(E_{L1} - 1)}\right] \tag{C16-2}$$

EXHIBIT C16-3. THROUGH-CAR EQUIVALENTS, E_{L1} , FOR PERMITTED LEFT TURNS

Type of Left-Turn Lane	Effective Opposing Flow, $v_{oe} = v_o/f_{LUo}$						
	1	200	400	600	800	1000	1200 ^a
Shared	1.4	1.7	2.1	2.5	3.1	3.7	4.5
Exclusive	1.3	1.6	1.9	2.3	2.8	3.3	4.0

Notes:

a. Use formula for effective opposing flow more than 1200; v_{oe} must be > 0 .

$E_{L1} = S_{HT}/S_{LT} - 1$ (shared)

$E_{L1} = S_{HT}/S_{LT}$ (exclusive)

$$S_{LT} = \frac{v_{oe} e^{\left(\frac{-v_{oe} t_c}{3600}\right)}}{1 - e^{\left(\frac{-v_{oe} t_c}{3600}\right)}}$$

where

E_{L1} = through-car equivalent for permitted left turns

S_{HT} = saturation flow of through traffic (veh/h/ln) = 1900 veh/h/ln

S_{LT} = filter saturation flow of permitted left turns (veh/h/ln)

t_c = critical gap = 4.5 s

t_f = follow-up headway = 4.5 s (shared), 2.5 s (exclusive)

A reduced form is given as Equation C16-3.

$$f_m = \left(\frac{g_f}{g}\right) + \left(\frac{g_u}{g}\right) \left[\frac{1}{1 + P_L(E_{L1} - 1)} \right] \quad (C16-3)$$

Sneakers are considered to be part of the left-turn count for the corresponding green interval, even though they may enter and depart the intersection during the yellow or red intervals

Note that there is no term in this formulation to account for sneakers, that is, for drivers completing left turns during the effective red portion of the clearance-and-change interval. This term is missing because in saturation flow rate measurements, vehicles are counted when they enter the intersection, not when they leave it. However, there is a practical minimum number of left turns that will be made on any phase, defined by sneakers.

To account for this situation, a practical minimum value must be imposed on f_m . One sneaker per cycle may be assumed as a minimum. The probability that a second sneaker will be in position at the end of the green phase will be equal to the proportion of left turns in the shared lane, P_L . The estimated number of sneakers per cycle may therefore be computed as $(1 + P_L)$. Assuming an approximate average headway of 2 s per vehicle in an exclusive lane on a protected phase, the practical minimum value of f_m may be estimated as $2(1 + P_L)/g$.

MULTILANE APPROACH WITH OPPOSING MULTILANE APPROACHES

Multilane approaches are legs of intersections with more than one approach lane

For multilane approaches, the impact of left turns on a shared lane must be extended to include their impact on the entire lane group. One might simply assume that the factor for the shared lane is f_m and that the factor for each other lane in the group is 1.0. In this assumption, however, left turns affect only the lane from which they are made. This is incorrect because vehicles typically maneuver from lane to lane to avoid left-turn congestion. Equation C16-4 provides the relationship for computing realistic f_{LT} values.

$$f_{LT} = \frac{f_m + 0.91(N - 1)}{N} \quad (C16-4)$$

where

f_{LT} = left-turn adjustment factor applied to a total lane group from which left turns are made, and

f_m = left-turn adjustment factor applied only to lane from which left turns are made.

When a single (or double) exclusive-permitted left-turn lane is involved, $f_{LT} = f_m$.

To implement this model, it is necessary to estimate the subportions of the effective green phase, g_f , g_q , and g_u . Regression relationships have been developed to permit this estimation, as follows:

1. Compute g_f :

$$g_f = G e^{-0.882LTC^{0.717}} - t_L \text{ (shared permitted left-turn lanes) } 0 \leq g_f \leq g \quad (C16-5)$$

$$g_f = 0.0 \text{ (exclusive-permitted left-turn lanes)}$$

where

- G = actual green time for permitted phase (s);
- LTC = left turns per cycle, computed as $v_{LT}C/3600$;
- v_{LT} = adjusted left-turn flow rate (veh/h);
- C = cycle length (s); and
- t_L = lost time for subject left-turn lane group (s).

2. Compute g_q :

$$g_q = \frac{v_{olc}qr_o}{0.5 - \frac{v_{olc}(1-qr_o)}{g_o}} - t_L \quad (C16-6)$$

$$\frac{v_{olc}(1-qr_o)}{g_o} \leq 0.49$$

$$0.0 \leq g_q \leq g$$

where

- v_{olc} = adjusted opposing flow rate per lane per cycle, computed as $v_oC/(3600N_o f_{LUo})$;
- v_o = adjusted opposing flow rate (veh/h);
- f_{LUo} = lane utilization factor for opposing flow;
- N_o = number of opposing lanes;
- qr_o = opposing queue ratio, that is, proportion of opposing flow rate originating in opposing queues, computed as $1 - R_{po}(g_o/C)$; $qr_o \geq 0$;
- R_{po} = platoon ratio for opposing flow, obtained from Exhibit 16-12 based on opposing arrival type;
- g_o = effective green for opposing flow (s); and
- t_L = lost time for opposing lane group (s).

3. Compute g_u :

$$g_u = g - g_q \text{ when } g_q \geq g_f$$

$$g_u = g - g_f \text{ when } g_q < g_f$$

where

- g = effective green time for subject permitted left turn (s).

Note that when $g_q < g_f$, that is, when the first left-turning vehicle does not arrive until after the opposing queue clears, an effective adjustment factor of 1.0 is applied throughout g_f and a factor based on E_{L1} thereafter.

4. Select the appropriate value of E_{L1} from Exhibit C16-3 on the basis of the opposing flow rate, v_o , and the lane utilization adjustment factor of the opposing flow, f_{LUo} . For the purposes of determining v_o , opposing right and left turns from exclusive lanes are not included in v_o .

5. Compute P_L (proportion of left turns in shared lane):

Regression equations are used to estimate how effective green for a phase will be divided into its three parts

$$P_L = P_{LT} \left[1 + \frac{(N-1)g}{g_f + \frac{g_u}{E_{L1}} + 4.24} \right] \quad (C16-7)$$

where

- P_{LT} = proportion of left turns in lane group, and
- N = number of lanes in lane group.

Note that when an exclusive-permitted left-turn lane is involved, $P_L = P_{LT} = 1.0$.

6. Compute f_m using Equation C16-3.
7. Compute f_{LT} using Equation C16-4.

SINGLE-LANE APPROACH OPPOSED BY SINGLE-LANE APPROACH

The case of a single-lane approach opposed by another single-lane approach has a number of unique features that must be reflected in the model. The most critical of these is the effect of opposing left turns. An opposing left-turning vehicle in effect creates a gap in the opposing flow through which a subject left turn may be made. This gap can occur during the clearance of the opposing queue as well as during the unsaturated portion of the green phase.

Thus, the assumption in the multilane model that there is no flow during the period $g_q - g_f$ (where $g_q > g_f$) is not applicable to opposing single-lane approaches, on which there is flow during this period at a reduced rate reflecting the blocking effect of left-turning vehicles as they await an opposing left turn. Left-turning vehicles during the period $g_q - g_f$ are assigned a through-car equivalent value E_{L2} based on simple queuing analysis, which can be converted to an adjustment factor for application during this period of the green.

Since vehicles do not have the flexibility to choose lanes on a single-lane approach, regression relationships for predicting g_f and g_q are also different from those for the multilane case. Further, for a single-lane approach, $f_{LT} = f_m$, and $P_L = P_{LT}$. As in the multilane case, the opposing single-lane model has no term to account for sneakers but has a practical minimum value of $f_{LT} = 2(1 + P_{LT})/g$.

The basic model of left-turn lanes with opposing single-lane approaches is defined by Equations C16-8 and C16-9:

$$f_{LT} = f_m = \left(\frac{g_f}{g} \right) (1.0) + \left(\frac{g_{diff}}{g} \right) \left[\frac{1}{1 + P_{LT}(E_{L2} - 1)} \right] + \left(\frac{g_u}{g} \right) \left[\frac{1}{1 + P_{LT}(E_{L1} - 1)} \right] \quad (C16-8)$$

$$f_{LT} = \left(\frac{g_f}{g} \right) + \left(\frac{g_{diff}}{g} \right) \left[\frac{1}{1 + P_{LT}(E_{L2} - 1)} \right] + \left(\frac{g_u}{g} \right) \left[\frac{1}{1 + P_{LT}(E_{L1} - 1)} \right] \quad (C16-9)$$

where

- g_{diff} = $\max(g_q - g_f, 0)$. Note that when no opposing left turns are present, the value of g_{diff} is set to zero.

To implement this model, it is again necessary to estimate the subportions of the effective green phase, g_f , g_q , and g_u , using Equations C16-10 through C16-12.

1. Compute g_f :

$$g_f = Ge^{(-0.860LTC^{0.629})} - t_L \quad \text{when } 0 \leq g_f \leq g \quad (C16-10)$$

where

- G = actual green time for permitted phase (s);
- LTC = left turns per cycle, computed as $v_{LT}C/3600$;
- v_{LT} = adjusted left-turn flow rate (veh/h);
- C = cycle length (s); and

Single-lane approaches are legs of intersections with only one approach lane

t_L = lost time for subject left-turn lane group (s).

2. Compute g_q :

$$g_q = 4.943v_{olc}^{0.762} qr_o^{1.061} - t_L \text{ when } 0 \leq g_q \leq g \quad (C16-11)$$

where

- v_{olc} = adjusted opposing flow rate per lane per cycle, computed as $v_o C / (3600) f_{LUo}$;
- v_o = adjusted opposing flow rate (veh/h);
- qr_o = opposing queue ratio, that is, the proportion of opposing flow rate originating in opposing queues, computed as $1 - R_{po}(g_o/C)$, $qr_o \geq 0$;
- R_{po} = platoon ratio for opposing flow, obtained from Exhibit 16-11 on basis of opposing arrival type;
- g_o = effective green for opposing flow (s); and
- t_L = lost time for opposing lane group (s).

3. Compute g_u :

$$g_u = g - g_q \text{ when } g_q \geq g_f$$

$$g_u = g - g_f \text{ when } g_q < g_f$$

where

g = effective green time for subject permitted left turn (s).

Note that when $g_q < g_f$, that is, when the first left-turning vehicle does not arrive until after the opposing queue clears, an effective adjustment factor of 1.0 is applied throughout g_f and a factor based on E_{L1} thereafter.

4. Select the appropriate value of E_{L1} from Exhibit C16-3 on the basis of the opposing flow rate, v_o , and the lane utilization adjustment factor of the opposing flow, f_{LUo} .

5. Compute E_{L2} :

$$E_{L2} = \frac{(1 - P_{THo}^n)}{P_{LTo}} \text{ when } E_{L2} \geq 1.0 \quad (C16-12)$$

where

- P_{LTo} = proportion of left turns in opposing single-lane approach;
- P_{THo} = proportion of through and right-turning vehicles in opposing single-lane approach, computed as $1 - P_{LTo}$; and
- n = maximum number of opposing vehicles that could arrive during $g_q - g_f$, computed as $(g_q - g_f)/2$. Note that n is subject to a minimum value of zero.

6. Compute f_{LT} using Equation C16-9.

SPECIAL CASES

Two special cases for permitted left turns must be addressed: a single-lane approach opposed by a multilane approach and vice versa. When the subject lane in these cases is the single-lane approach, it is opposed by a multilane opposing flow. Even if the opposing approach is a single through lane and an exclusive left-turn lane, opposing left turns will not open gaps in the opposing flow. Thus, the special structure of the single-lane model does not apply. The multilane model is applied, except that $f_{LT} = f_m$. The value of g_f , however, should be computed using the single-lane equation,

$$g_f = Ge^{(-0.860LTC^{0.629})} - t_L.$$

When the multilane approach is considered, the reverse is true. The opposing flow is in a single lane, and opposing left turns could open gaps for subject left turners. The single-lane model may be applied, with several notable revisions. The term g_f should be

Single-lane approach in combination with multilane approach

computed using Equation C16-5. P_L must be estimated and substituted for P_{LT} in the single-lane model. P_L may be estimated from P_{LT} using Equation C16-7. Also, f_{LT} does not equal f_m . Thus, the conversion must be made using the multilane equations, except when the subject approach is a double left-turn lane as shown in Equation C16-4.

Worksheets that may be used to assist in implementing the special models for permitted left-turn movements are presented later in this appendix. These worksheets do not account for the modifications that must be made to analyze single-lane approaches opposed by multilane approaches and vice versa.

MORE COMPLEX PHASING WITH PERMITTED LEFT TURNS

The models and worksheets presented in previous sections of Appendix C apply directly to situations in which left turns are made only on permitted phases and in which no protected phases or opposing leading green phases exist. The models may, however, be applied to these more complex cases with some modifications.

In general, protected-plus-permitted phases are analyzed by separating the portions of the phase into two lane groups for the sake of analysis. Each portion of the phase is then handled as if the other were not present. The protected portion of the phase is treated as a protected phase, and a left-turn adjustment factor appropriate to a protected phase is selected. The permitted portion of the phase is treated as a permitted phase, and the special procedures outlined here are used to estimate a left-turn adjustment factor (with modifications as defined in this section).

With the foregoing procedure, separate saturation flow rates may be computed for each portion of the phase. This method does not require that the demand volume for the protected-plus-permitted movement be divided between the two portions of the phase. However, the computation of the critical v/c ratio, X_c , does require this apportionment. The following is a reasonable and conservative approach to apportioning the volumes for purposes of computing X_c .

- The first portion of the phase, whether protected or permitted, is assumed to be fully utilized, that is, to have a v/c of 1.0, unless total demand is insufficient to use the capacity of that portion of the phase.
- Any remaining demand not handled by the first portion of the phase is assigned to the second portion of the phase, whether protected or permitted.

This approach assumes that when the movement is initiated, a queue exists that uses available capacity in the initial portion of the phase. In cases of a failed cycle, the unserved queue will exist after the end of the second portion of the phase, with those vehicles queued and ready to use the initial portion of the phase on the next cycle. In this sense, the initial portion of the movement can never operate at a v/c of more than 1.0.

In the analysis of the permitted portion of such phases, as well as those with opposing leading protected left-turn phases, the basic models described previously may be applied. The difficulty is in selecting values of G , g , g_f , g_q , and g_u for use in these models. The equation for g_f is indexed to the beginning of effective green in the subject direction, and g_q is indexed to the beginning of the effective green for the opposing flow. When leading or lagging phasing or protected-plus-permitted phasing exists, these equations must be modified to account for shifts in the initiation and overlap of various green times.

Some common examples are shown in Exhibits C16-4 through C16-8. G , g , g_f , and g_q are computed as shown in the models and worksheets. These values are modified as shown and replaced on the worksheets with G^* , g^* , g_f^* , and g_q^* for the permitted portion of protected-plus-permitted phasing. This extended notation is required to cover the general case of complex left-turn phasing. In most practical cases, it will not be necessary to use all the superscripted terms.

Exhibit C16-4 shows the standard case. Exhibit C16-5 shows Case 2 with a leading green phase. The equations shown are valid for either exclusive-lane or shared-lane operation, except that g_f is zero by definition for the exclusive-lane case. For exclusive-

Modification to account for leading and lagging phases or protected-plus-permitted phasing

lane operation, the leading green, G_1 , is followed by G/Y_1 , a period during which the left-turn change-and-clearance interval is displayed, and the through movement continues with a green indication. G_2 has a green indication for both the through and left-turn movements, followed by a full change-and-clearance interval for all north-south movements, Y_2 .

EXHIBIT C16-4. CASE 1 - PERMITTED TURNS: STANDARD CASE

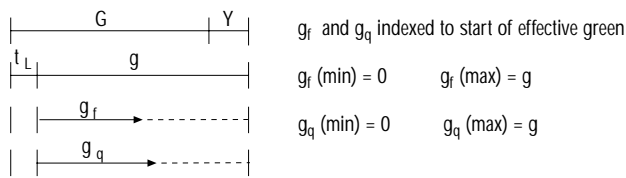
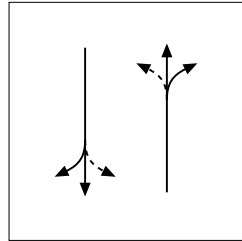

EXHIBIT C16-5. CASE 2 - GREEN-TIME ADJUSTMENTS FOR LEADING GREEN

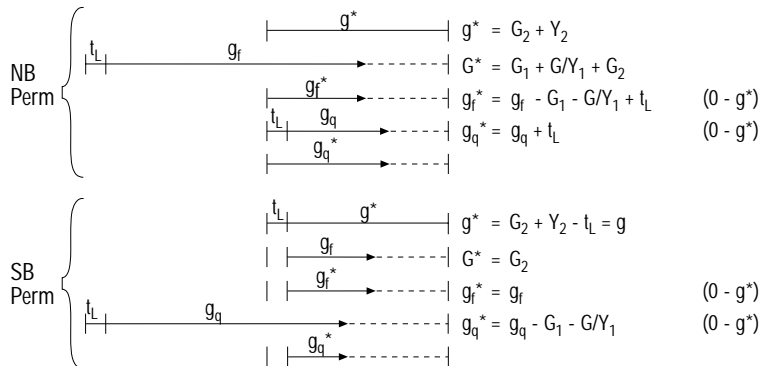
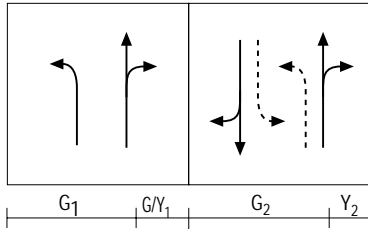

EXHIBIT C16-6. CASE 3 - GREEN-TIME ADJUSTMENTS FOR LAGGING GREEN

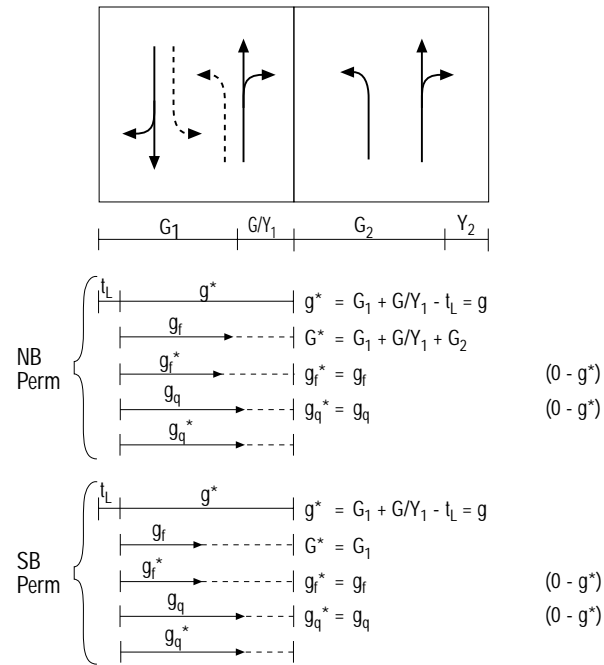

EXHIBIT C16-7. CASE 4 - GREEN-TIME ADJUSTMENTS FOR LEADING AND LAGGING GREEN

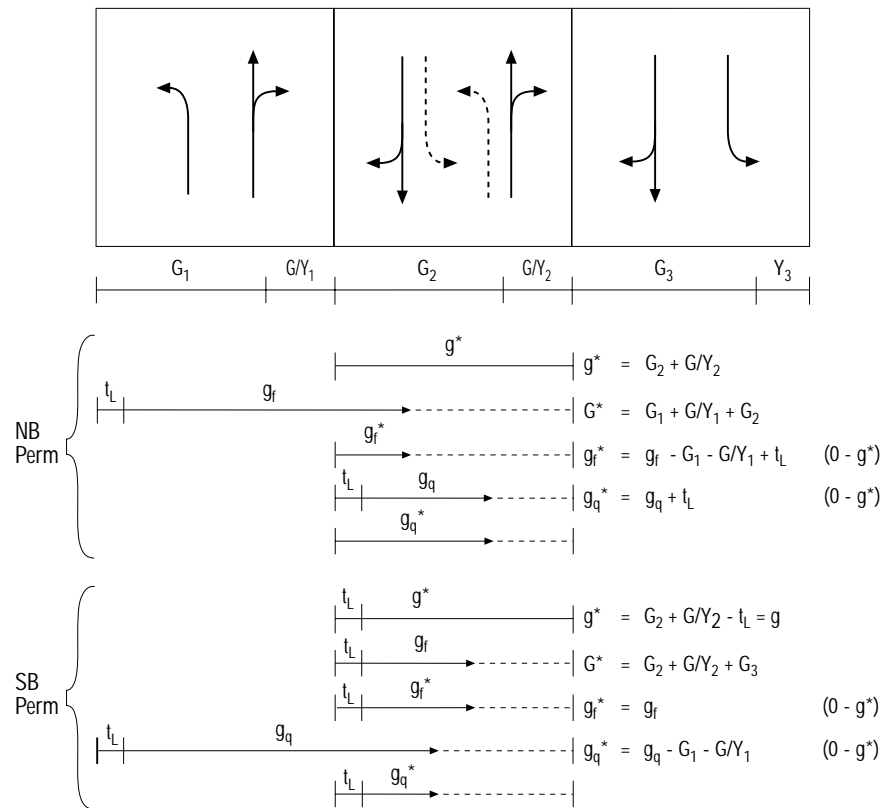
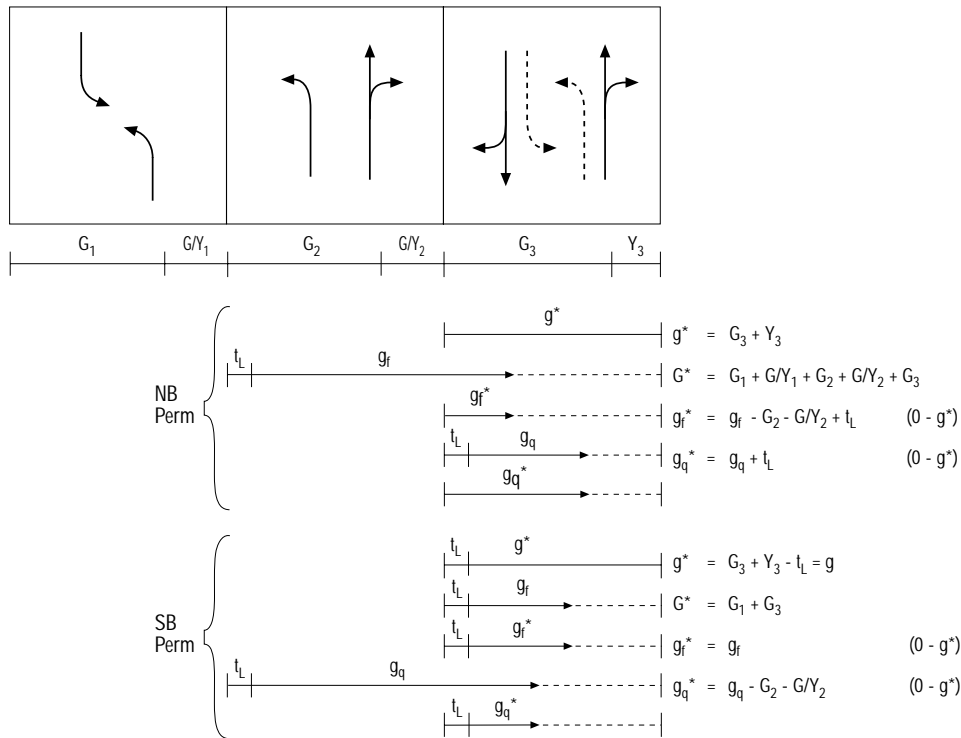

EXHIBIT C16-8. CASE 5 - GREEN-TIME ADJUSTMENTS FOR LT PHASE WITH LEADING GREEN



The effective green time for the permitted phase, g^* , is equal to $G_2 + Y_2$ for the NB direction and $G_2 + Y_2 - t_L$ for the SB direction. Note that there is no lost time for the NB movements, since both were initiated in the leading phase, and the lost time is assessed there. Thus, the NB and SB effective green times that must be used are not equal.

For the NB phase, g_f is computed using the total green time for the NB left-turn movement, $G_1 + G/Y_1 + G_2$. The computed value, however, begins with the leading-phase effective green, as shown. The value that needs to be applied to the permitted phase, however, is that portion of g_f that overlaps g^* , which results in $g_f^* = g_f - G_1 - G/Y_1 + t_L$. This computation would be done for a shared lane, and the result, g_f^* , would have to be a value between 0 and g^* . For an exclusive-lane case, g_f and g_f^* are by definition zero. For the SB phase, g_f as normally computed is the same as g_f^* , and no adjustment is necessary.

For the NB phase, g_q is referenced to the beginning of the opposing (SB) effective green. Again, the value needed is the portion of the NB g^* blocked by the clearance of the opposing queue. Because the NB effective green (g^*) does not account for lost time, $g_q^* = g_q + t_L$. For the SB phase, the usual computation of g_q is indexed to the start of the opposing (NB) flow, which begins in the leading phase. For analysis of the permitted phase, however, only the portion that blocks the SB permitted effective green is of interest. Thus, $g_q^* = g_q - G_1 - G/Y_1$.

The foregoing discussion is illustrative. The relationship between the normal calculations of g , G , g_f , and g_q and their adjusted counterparts, g^* , G^* , g_f^* , and g_q^* , is best described by Exhibits C16-5 through C16-8, which may be used in conjunction with the standard worksheets to arrive at the appropriate left-turn adjustment factor for the permitted portion of a protected-plus-permitted phase plan. Obviously, north and south can be reversed or replaced by east and west without any change in the equations shown.

PROCEDURES FOR APPLICATION

The procedure described in this appendix is used at the point in the analysis where the base saturation flow is being adjusted to site conditions. Exhibits C16-9 and C16-10 show worksheets that are used in the computation of the left-turn adjustment factor when permitted left-turn phasing exists. These worksheets are applied to the permitted portion of left turns, including permitted-only and protected-plus-permitted phasing, whether made from an exclusive or shared lane for Cases 2, 3, 5, and 6.

The basic methodology for each worksheet assumes that the subject approach is a multilane approach if the opposing approach is a multilane approach (Exhibit C16-9) and that the subject approach is a single-lane approach if the opposing approach is a single-lane approach (Exhibit C16-10). For cases in which the two approaches are not of the same type as well as for cases of protected-plus-permitted phasing and a phasing in which the opposing through movement has a lead phase, the worksheets may still be used, but the special instructions cited earlier in this appendix must be followed carefully.

There is a column for each approach on the worksheets, although only those approaches with permitted left-turn conditions would be included. Since the worksheets are quite similar, they are discussed together here, with exceptions and differences noted where appropriate.

The first set of entries consists of input variables that should be entered directly from values appearing on previous worksheets.

1. The cycle length is entered from the Input Worksheet.
2. The actual green time for the permitted phase is entered from the Input Worksheet. If the permitted phase is part of a protected-plus-permitted phasing or the opposing approach has a lead phase, see the special instructions earlier in this appendix.
3. The effective green time for the permitted phase is entered. This entry is generally the actual green time from the Input Worksheet plus the yellow-plus-all-red change-and-clearance interval minus the movement's lost time. If the permitted phase is part of a protected-plus-permitted phasing or the opposing approach has a lead phase, see the special instructions in this appendix.
4. The effective green time for the opposing approach is entered for the permitted phase. This entry is generally the actual green time from the Input Worksheet plus the yellow-plus-all-red change-and-clearance interval minus the movement's lost time. If the permitted phase is part of a protected-plus-permitted phasing or the opposing approach has a lead phase, see the special instructions in this appendix.
5. The number of lanes in the subject lane group is entered from the Input Worksheet. If the left turn is opposed by a multilane approach (Exhibit C16-9), the number of lanes in the opposing lane group is entered from the Input Worksheet as well. If left or right turns are made from exclusive turn lanes on the opposing approach, these lanes are not included in the number of opposing lanes.
6. The adjusted left-turn flow rate is entered from the Volume Adjustment and Saturation Flow Rate Worksheet.
7. The proportion of left turns in the lane group is entered from the Volume Adjustment and Saturation Flow Rate Worksheet. When an exclusive left-turn lane group is involved, $P_{LT} = 1.0$. If the left turn is opposed by a single-lane approach (Exhibit C16-10), the proportion of left turns in the opposing flow is entered from the Volume Adjustment and Saturation Flow Rate Worksheet.
8. The adjusted opposing flow rate is entered from the Volume Adjustment and Saturation Flow Rate Worksheet. If left or right turns are made from exclusive turn lanes on the opposing approach, these adjusted volumes are not included in the opposing flow rate.
9. The lost time for the left-turn lane group is entered as determined from the Input Worksheet.

EXHIBIT C16-9. SUPPLEMENTAL WORKSHEET FOR PERMITTED LEFT TURNS WHERE APPROACH IS
OPPOSED BY MULTILANE APPROACH

SUPPLEMENTAL WORKSHEET FOR PERMITTED LEFT TURNS OPPOSED BY MULTILANE APPROACH				
General Information				
Project Description _____				
Input				
	EB	WB	NB	SB
Cycle length, C (s)				
Total actual green time for LT lane group, ¹ G (s)				
Effective permitted green time for LT lane group, ¹ g (s)				
Opposing effective green time, g _o (s)				
Number of lanes in LT lane group, ² N				
Number of lanes in opposing approach, N _o				
Adjusted LT flow rate, v _{LT} (veh/h)				
Proportion of LT volume in LT lane group, ³ P _{LT}				
Adjusted flow rate for opposing approach, v _o (veh/h)				
Lost time for LT lane group, t _L				
Computation				
LT volume per cycle, LTC = v _{LT} C/3600				
Opposing lane utilization factor, f _{LUo} (refer to Volume Adjustment and Saturation Flow Rate Worksheet)				
Opposing flow per lane, per cycle $v_{olc} = \frac{v_o C}{3600 N_o f_{LUo}}$ (veh/C/ln)				
$g_r = G[e^{-0.882(LTC^{0.717})}] - t_L$ $g_r \leq g$ (except for exclusive left-turn lanes) ^{1, 4}				
Opposing platoon ratio, R _{po} (refer to Exhibit 16-11)				
Opposing queue ratio, q _{ro} = max[1 - R _{po} (g _o /C), 0]				
$g_q = 0.5 - [v_{olc}(1 - q_{ro})/g_o] - t_L$, $v_{olc}(1 - q_{ro})/g_o \leq 0.49$ (note case-specific parameters) ¹				
$g_u = g - g_q$ if $g_q \geq g_r$, or $g_u = g - g_r$ if $g_q < g_r$				
E _{L1} (refer to Exhibit C16-3)				
$P_L = P_{LT} \left[1 + \frac{(N-1)g}{(g_r + g_u/E_{L1} + 4.24)} \right]$ (except with multilane subject approach) ⁵				
f _{min} = 2(1 + P _L)/g				
$f_m = [g_r/g] + [g_u/g] \left[\frac{1}{1 + P_L(E_{L1} - 1)} \right]$, (f _{min} ≤ f _m ≤ 1.00)				
f _{LT} = [f _m + 0.91(N - 1)]/N (except for permitted left turns) ⁶				
Notes				
<ol style="list-style-type: none"> 1. Refer to Exhibits C16-4, C16-5, C16-6, C16-7, and C16-8 for case-specific parameters and adjustment factors. 2. For exclusive left-turn lanes, N is equal to the number of exclusive left-turn lanes. For shared left-turn lanes, N is equal to the sum of the shared left-turn, through, and shared right-turn (if one exists) lanes in that approach. 3. For exclusive left-turn lanes, P_{LT} = 1. 4. For exclusive left-turn lanes, g_r = 0, and skip the next step. Lost time, t_L, may not be applicable for protected-permitted case. 5. For a multilane subject approach, if P_L ≥ 1 for a left-turn shared lane, then assume it to be a de facto exclusive left-turn lane and redo the calculation. 6. For permitted left turns with multiple exclusive left-turn lanes f_{LT} = f_m. 				

EXHIBIT C16-10. SUPPLEMENTAL WORKSHEET FOR PERMITTED LEFT TURNS WHERE APPROACH IS OPPOSED BY SINGLE-LANE APPROACH

SUPPLEMENTAL WORKSHEET FOR PERMITTED LEFT TURNS OPPOSED BY SINGLE-LANE APPROACH				
General Information				
Project Description _____				
Input				
	EB	WB	NB	SB
Cycle length, C (s)				
Total actual green time for LT lane group, ¹ G (s)				
Effective permitted green time for LT lane group, ¹ g (s)				
Opposing effective green time, g _o (s)				
Number of lanes in LT lane group, ² N				
Adjusted LT flow rate, v _{LT} (veh/h)				
Proportion of LT volume in LT lane group, P _{LT}				
Proportion of LT volume in opposing flow, P _{LT_O}				
Adjusted flow rate for opposing approach, v _o (veh/h)				
Lost time for LT lane group, t _L				
Computation				
LT volume per cycle, LTC = v _{LT} C/3600				
Opposing flow per lane, per cycle, v _{oLC} = v _o C/3600 (veh/C/ln)				
Opposing platoon ratio, R _{po} (refer to Exhibit 16-11)				
$g_f = G[e^{-0.860(LTC)^{0.627}}] - t_L$ $g_f \leq g$ (except exclusive left-turn lanes) ³				
Opposing queue ratio, q _{r_o} = max[1 - R _{po} (g _o /C), 0]				
$g_q = 4.943v_{oLC}^{0.762}q_{r_o}^{1.061} - t_L$ $g_q \leq g$				
$g_u = g - g_q$ if $g_q \geq g_f$, or $g_u = g - g_f$ if $g_q < g_f$				
$n = \max[(g_q - g_f)/2, 0]$				
P _{THo} = 1 - P _{LT_O}				
E _{L1} (refer to Exhibit C16-3)				
$E_{L2} = \max[(1 - P_{THo}^n)/P_{LTO$				
$f_{min} = 2(1 + P_{LT})/g$				
$g_{diff} = \max[g_q - g_f, 0]$ (except when left-turn volume is 0) ⁴				
$f_{LT} = f_m = [g/g] + \left[\frac{g_u/g}{1 + P_{LT}(E_{L1} - 1)} \right] + \left[\frac{g_{diff}/g}{1 + P_{LT}(E_{L2} - 1)} \right]$ ($f_{min} \leq f_m \leq 1.00$)				
Notes				
1. Refer to Exhibits C16-4, C16-5, C16-6, C16-7, and C16-8 for case-specific parameters and adjustment factors.				
2. For exclusive left-turn lanes, N is equal to the number of exclusive left-turn lanes. For shared left-turn lanes, N is equal to the sum of the shared left-turn, through, and shared right-turn (if one exists) lanes in that approach.				
3. For exclusive left-turn lanes, g _f = 0, and skip the next step. Lost time, t _L , may not be applicable for protected-permitted case.				
4. If the opposing left-turn volume is 0, then g _{diff} = 0.				

The equations used in subsequent computations are shown in the remaining rows of the worksheet. These equations are based on the input variables that have been entered. Some of these computations deserve further discussion, as follows.

- The opposing platoon ratio, R_{po}, may be determined in two ways. If the arrival type of the opposing traffic appears on the Input Worksheet, the default platoon ratio from Exhibit 16-11 is used. If the proportion of arrivals on green appears on the Input Worksheet, Equation 16-1 based on the g/C ratio is used.
- The equation shown for g_f in Exhibit C16-9 assumes that the subject approach is a multilane approach like the opposing approach. If the subject approach is a single-lane approach, the equation for g_f from Exhibit C16-10 should be used. Conversely, the

equation shown for g_f in Exhibit C16-10 assumes that the subject approach is a single-lane approach like the opposing approach. If the subject approach is a multilane approach, the equation for g_f from Exhibit C16-9 should be used. In either case, if the subject lane group is an exclusive left-turn lane, then $g_f = 0$.

- For multilane lane groups (Exhibit C16-9), P_L is computed as the proportion of left turns in the left-hand lane of the lane group. If this value is determined to be 1.0 or higher, the lane groups for the approach should be reassigned showing this left-hand lane as an exclusive left-turn lane (a de facto left-turn lane), since it is occupied entirely by left-turning vehicles. This change requires redoing all of the computations for this approach. If a multilane lane group is opposed by a single-lane approach, Exhibit C16-10 should be used, but a value of P_L should be estimated and substituted for P_{LT} , as described in this appendix. In this case, the same de facto left-turn check should be applied.

- Exhibit C16-3 is used to determine the value of E_{L1} based on the opposing flow rate and the lane utilization factor of the opposing flow. For the single-lane approach (Exhibit C16-4), E_{L2} is computed by formula, not by Exhibit C16-3.

- The value of f_m is computed. The maximum value is 1.0 and the minimum value is $2(1 + P_L)/g$. These limits are used if the computed value falls outside this range.

- The left-turn adjustment factor, f_{LT} , is computed. For a single-lane group, $f_{LT} = f_m$. If a multilane lane group is opposed by a single-lane approach, Exhibit C16-10 is used, but f_{LT} is calculated on the basis of f_m and the number of lanes as shown in Exhibit C16-9 except when the subject lane group contains multiple exclusive left-turn lanes.

APPENDIX D. PEDESTRIAN AND BICYCLE ADJUSTMENT FACTORS

Appendix D provides the procedure used to calculate pedestrian and bicycle adjustment factors for calculating saturation flow of turning vehicles. Exhibit D16-1 shows sample conflict zones where intersection users compete for space. The variables required for input are shown in Exhibit D16-2. These variables are divided into two groups, qualitative and quantitative, and they are displayed in computational order. A flowchart in Exhibit D16-3 illustrates a step-by-step procedure for computation, and a supplemental worksheet is also provided to facilitate the computation.

There are four steps for computing pedestrian-bicycle saturation flow rate adjustment factors.

Step 1: Determine average pedestrian occupancy, OCC_{pedg}

Average pedestrian occupancy is derived from pedestrian volume, v_{ped} . If pedestrian flow rate, v_{pedg} , rather than pedestrian volume, v_{ped} , is collected in the field, average pedestrian occupancy can be calculated directly from pedestrian flow rate. Otherwise, pedestrian flow rate first has to be converted from pedestrian volume using Equation D16-1.

$$v_{pedg} = v_{ped} * (C/g_p) \quad (v_{pedg} \leq 5000) \quad (D16-1)$$

Then average pedestrian occupancy can be calculated using Equation D16-2.

$$OCC_{pedg} = v_{pedg}/2000 \quad (v_{pedg} \leq 1000 \text{ and } OCC_{pedg} \leq 0.5) \quad (D16-2)$$

or

$$OCC_{pedg} = 0.4 + v_{pedg}/10,000 \quad (1000 < v_{pedg} \leq 5,000 \text{ and } 0.5 < OCC_{pedg} \leq 0.9)$$

Step 2: Determine relevant conflict zone occupancy, OCC_T

If bicycle traffic weaves with right-turning vehicles in advance of the stop line, the bicycle volume should be ignored in the analysis because this interaction does not take place within the intersection. Only pedestrian interference should be considered.

EXHIBIT D16-1. CONFLICT ZONE LOCATIONS

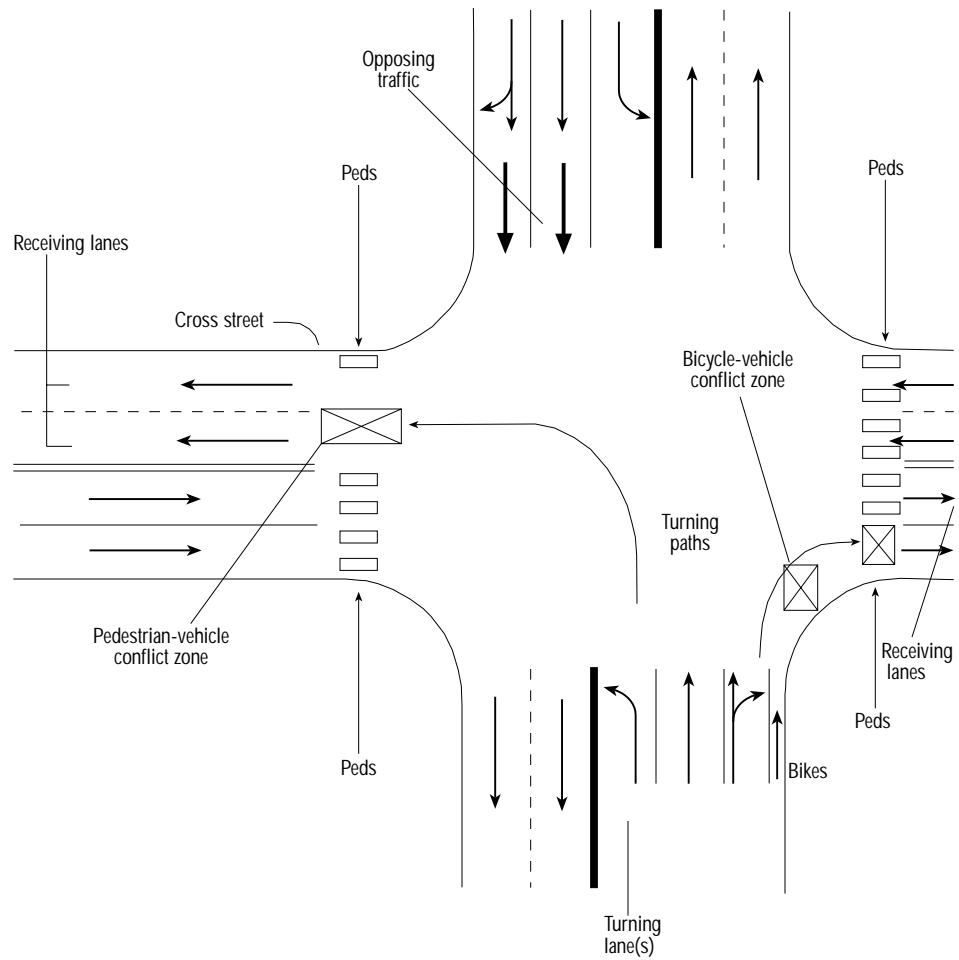

- For right-turn movements with no bicycle interference or for left-turn movements from a one-way street, Equation D16-3 is used.

$$OCC_r = OCC_{pedg} \tag{D16-3}$$

- For right-turn movements with bicycle interference, bicycle flow rate, v_{bicg} , first has to be converted from bicycle volume, v_{bic} . If bicycle flow rate data are collected in the field, no conversion is needed. The relationship between bicycle flow rate and bicycle volume is given by Equation D16-4.

$$v_{bicg} = v_{bic}(C/g) \quad (v_{bicg} \leq 1900) \tag{D16-4}$$

The bicycle conflict zone occupancy, OCC_{bicg} , is determined by Equation D16-5.

$$OCC_{bicg} = 0.02 + v_{bicg}/2700 \quad (v_{bicg} \leq 1900 \text{ and } OCC_{bicg} \leq 0.72) \tag{D16-5}$$

Then the relevant occupancy is determined from combined pedestrian occupancy and bicycle conflict zone occupancy using Equation D16-6.

$$OCC_r = OCC_{pedg} + OCC_{bicg} - (OCC_{pedg})(OCC_{bicg}) \tag{D16-6}$$

- For left-turn movements from a two-way street, opposing queue clearing time, g_q , is first compared with pedestrian green, g_p . If $g_q \geq g_p$, then $f_{Lpb} = 1.0$, and the procedure ends here because the opposing queue consumes the entire pedestrian green time. Hence, the adjustment factor is 1.

EXHIBIT D16-2. INPUT VARIABLES

Qualitative Variables	
Turning movements (left-turn or right-turn)	
Street types (one-way or two-way)	
Turn lane types (exclusive or shared)	
Signal phasing types (protected, permitted, or protected-permitted)	
Quantitative Parameters	Symbols
Cycle length, s	C
Opposing queue clearing time, ^a s	g_q
Opposing flow rate after queue clears, ^a veh/h	V_o
Number of effective turning lanes	N_{turn}
Number of effective receiving lanes	N_{rec}
Proportion of left-turn volumes ^b	P_{LT}
Proportion of right-turn volumes ^b	P_{RT}
Proportion of left turns using protected phase ^c	P_{LTA}
Proportion of right turns using protected phase ^c	P_{RTA}
Pedestrian volume, ^d p/h	V_{ped}
Pedestrian flow rate, ^d p/h	V_{pedg}
Bicycle volume, ^e bicycles/h	V_{bic}
Bicycle flow rate, ^e bicycles/h	V_{bicg}
Effective green, ^e s	g
Pedestrian Green WALK + flashing DON'T WALK, ^f s	g_p

Notes:

- a. Only for left-turn movements from a two-way street.
- b. Only for right-turn movements from a single-lane approach or for shared turning lanes.
- c. Only for cases with both protected and permitted green phases.
- d. Without consideration of noncompliant pedestrians.
- e. Only for right-turn movements impeded by bicycles.
- f. If pedestrian signal timing is unknown, g_p may be assumed to be equal to g .

Otherwise, pedestrian occupancy after the opposing queue clears, OCC_{pedu} , is determined by Equation D16-7.

$$OCC_{pedu} = OCC_{pedg} [1 - 0.5(g_q/g_p)] \quad (D16-7)$$

After the opposing queue clears, left-turning vehicles complete their maneuvers on the basis of accepted gap availability in opposing traffic, V_o . Relevant occupancy is a function of the probability of accepted gap availability and pedestrian occupancy and is computed by Equation D16-8.

$$OCC_r = OCC_{pedu} \left[e^{-(5/3600)V_o} \right] \quad (D16-8)$$

Step 3: Determine permitted phase pedestrian-bicycle adjustment factors for turning movements, A_{pbT} .

The number of turning lanes, N_{turn} , and receiving lanes, N_{rec} , should be determined from field observation rather than on the basis of intersection striping because some vehicles may consistently and deliberately make illegal turns from an outer lane, or sometimes proper turning cannot be executed because the receiving lane is blocked by double-parked vehicles. Two conditions are being considered in this step.

- If the number of cross-street receiving lanes is equal to the number of turning lanes, turning vehicles will not be able to maneuver around pedestrians or bicycles; the adjustment factor is the proportion of time the conflict zone is unoccupied as shown in Equation D16-9.

$$A_{pbT} = 1 - OCC_r \quad (N_{rec} = N_{turn}) \quad (D16-9)$$

EXHIBIT D16-3. OUTLINE OF COMPUTATIONAL PROCEDURE FOR f_{Rpb} AND f_{Lpb}

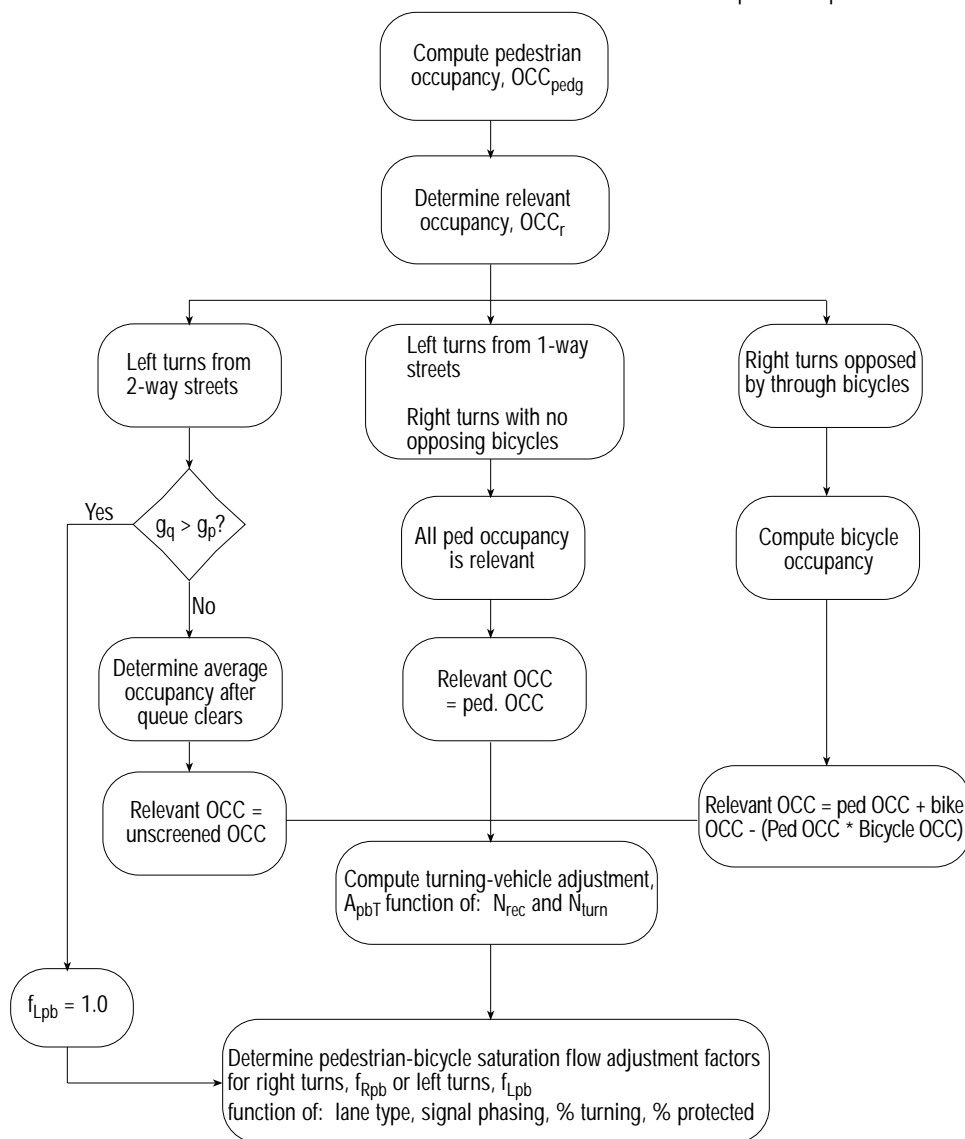

• If the number of cross-street receiving lanes exceeds the number of turning lanes, turning vehicles will more likely maneuver around pedestrians or bicycles and pedestrian-bicycle effects on saturation flow are reduced. The adjustment factor can be calculated using Equation D16-10.

$$A_{pbT} = 1 - 0.6(OCC_r) \quad (N_{rec} > N_{turn}) \quad (D16-10)$$

Step 4: Determine saturation flow adjustment factors for turning movements, f_{Lpb} , for left-turn movements and f_{Rpb} for right-turn movements.

Saturation flow adjustment factors account for pedestrian-bicycle effects on saturation flow for turning vehicles, and the factors are dependent on the proportion of turning traffic using protected phases. The proportion of right-turn movements is roughly equal to the proportion of the protected green phase. The proportion of left-turn movements is approximately equal to $[1 - (\text{permitted phase } f_{LT})]/0.95$.

• For right-turn movements, the pedestrian-bicycle adjustment factor, f_{Rpb} , can be calculated using Equation D16-11.









$$f_{Rpb} = 1.0 - P_{RT}(1 - A_{pbT})(1 - P_{RTA}) \tag{D16-11}$$

• For left-turn movements, the pedestrian adjustment factor, f_{Lpb} , can be calculated using Equation D16-12.

$$f_{Lpb} = 1.0 - P_{LT}(1 - A_{pbT})(1 - P_{LTA}) \tag{D16-12}$$

The supplemental worksheet for pedestrian-bicycle effects on permitted left turns and right turns is shown in Exhibit D16-4.

EXHIBIT D16-4. SUPPLEMENTAL WORKSHEET FOR PEDESTRIAN-BICYCLE EFFECTS

SUPPLEMENTAL WORKSHEET FOR PEDESTRIAN-BICYCLE EFFECTS ON PERMITTED LEFT TURNS AND RIGHT TURNS				
General Information				
Project Description _____				
Permitted Left Turns				
	EB 	WB 	NB 	SB 
Effective pedestrian green time, ^{1,2} g_p (s)				
Conflicting pedestrian volume, ¹ v_{ped} (p/h)				
$v_{pedg} = v_{ped}(C/g_p)$				
$OCC_{pedg} = v_{pedg}/2000$ if ($v_{pedg} \leq 1000$) or $OCC_{pedg} = 0.4 + v_{pedg}/10,000$ if ($1000 < v_{pedg} \leq 5000$)				
Opposing queue clearing green, ^{3,4} g_q (s)				
Effective pedestrian green consumed by opposing vehicle queue, g_q/g_p ; if $g_q \geq g_p$ then $f_{Lpb} = 1.0$				
$OCC_{pedu} = OCC_{pedg} [1 - 0.5(g_q/g_p)]$				
Opposing flow rate, ³ v_o (veh/h)				
$OCC_r = OCC_{pedu} [e^{-(5/3600)v_o}]$				
Number of cross-street receiving lanes, ¹ N_{rec}				
Number of turning lanes, ¹ N_{turn}				
$A_{pbT} = 1 - OCC_r$ if $N_{rec} = N_{turn}$				
$A_{pbT} = 1 - 0.6(OCC_r)$ if $N_{rec} > N_{turn}$				
Proportion of left turns, ⁵ P_{LT}				
Proportion of left turns using protected phase, ⁶ P_{LTA}				
$f_{Lpb} = 1.0 - P_{LT}(1 - A_{pbT})(1 - P_{LTA})$				
Permitted Right Turns				
				
Effective pedestrian green time, ^{1,2} g_p (s)				
Conflicting pedestrian volume, ¹ v_{ped} (p/h)				
Conflicting bicycle volume, ^{1,7} v_{bic} (bicycles/h)				
$v_{pedg} = v_{ped}(C/g_p)$				
$OCC_{pedg} = v_{pedg}/2000$ if ($v_{pedg} \leq 1000$), or $OCC_{pedg} = 0.4 + v_{pedg}/10,000$ if ($1000 < v_{pedg} \leq 5000$)				
Effective green, ¹ g (s)				
$v_{bicg} = v_{bic}(C/g)$				
$OCC_{bicg} = 0.02 + v_{bicg}/2700$				
$OCC_r = OCC_{pedg} + OCC_{bicg} - (OCC_{pedg})(OCC_{bicg})$				
Number of cross-street receiving lanes, ¹ N_{rec}				
Number of turning lanes, ¹ N_{turn}				
$A_{pbT} = 1 - OCC_r$ if $N_{rec} = N_{turn}$				
$A_{pbT} = 1 - 0.6(OCC_r)$ if $N_{rec} > N_{turn}$				
Proportion of right turns, ⁵ P_{RT}				
Proportion of right turns using protected phase, ⁸ P_{RTA}				
$f_{Rpb} = 1.0 - P_{RT}(1 - A_{pbT})(1 - P_{RTA})$				
Notes				
1. Refer to Input Worksheet.		5. Refer to Volume Adjustment and Saturation Flow Rate Worksheet.		
2. If intersection signal timing is given, use Walk + flashing Don't Walk (use G + Y if no pedestrian signals). If signal timing must be estimated, use (Green Time - Lost Time per Phase) from Quick Estimation Control Delay and LOS Worksheet.		6. Ideally determined from field data; alternatively, assume it equal to $(1 - \text{permitted phase } f_{LT})/0.95$.		
3. Refer to supplemental worksheets for left turns.		7. If $v_{bic} = 0$ then $v_{bicg} = 0$, $OCC_{bicg} = 0$, and $OCC_r = OCC_{pedg}$.		
4. If unopposed left turn, then $g_q = 0$, $v_o = 0$, and $OCC_r = OCC_{pedu} = OCC_{pedg}$.		8. P_{RTA} is the proportion of protected green over the total green, $g_{prot}/(g_{prot} + g_{perm})$. If only permitted right-turn phase exists, then $P_{RTA} = 0$.		

APPENDIX E. ESTIMATING UNIFORM CONTROL DELAY (d_1) FOR PROTECTED-PLUS-PERMITTED OPERATION

Left turns from exclusive lanes that are allowed to proceed on both protected and permitted phases in the signal sequence must be treated as a special case for purposes of computing the uniform delay. Such movements are analyzed for both phases on the Capacity and LOS Worksheet, on which the protected phase and the permitted phase are identified.

Inputs needed

Specifically, the following parameters must be known for evaluating the uniform delay:

- Arrival rate, q_a (veh/s), presumed to be uniform over entire cycle;
- Saturation flow rate for protected phase, s_p (veh/s);
- Saturation flow rate for unsaturated portion of permitted phase, s_s (veh/s) (unsaturated portion begins when queue of opposing vehicles has been served);
- Effective green time for protected phase in which a green arrow is displayed to left turns, g (s);
- Green time during permitted phase when opposing through movement blocks permitted left turns, g_q (s) (this interval begins at start of permitted green and continues until queue of opposing through vehicles has been fully discharged);
- Green time available for left-turning vehicles to filter through gaps in oncoming traffic, g_u (s) (this interval begins when queue of opposing through vehicles has been satisfied, i.e., at end of g_q , and continues until end of permitted green phase); and
- Red time during which signal is effectively red for left turn, r (s).

This terminology will be used in the following description of the supplemental uniform delay procedures and on the worksheet.

The input-output relationships that determine the shape and area of the polygon are shown in Exhibit E16-1. Note that the queuing polygon may assume any one of five shapes depending on the relationship of arrivals and departures. Slightly mathematical formulas must be applied to determine the area for each of the shapes. In all cases, the arrival rate must be adjusted to ensure that, for purposes of uniform delay computation, the v/c ratio is not greater than 1.0. This adjustment is also necessary for the analysis of simple protected operation as described previously. If the v/c ratio is greater than 1.0, the area contained by the polygon will not be defined. The effect of v/c ratios greater than 1.0 is expressed by the second term of the delay equation.

EXHIBIT E16-1. QUEUE ACCUMULATION POLYGONS

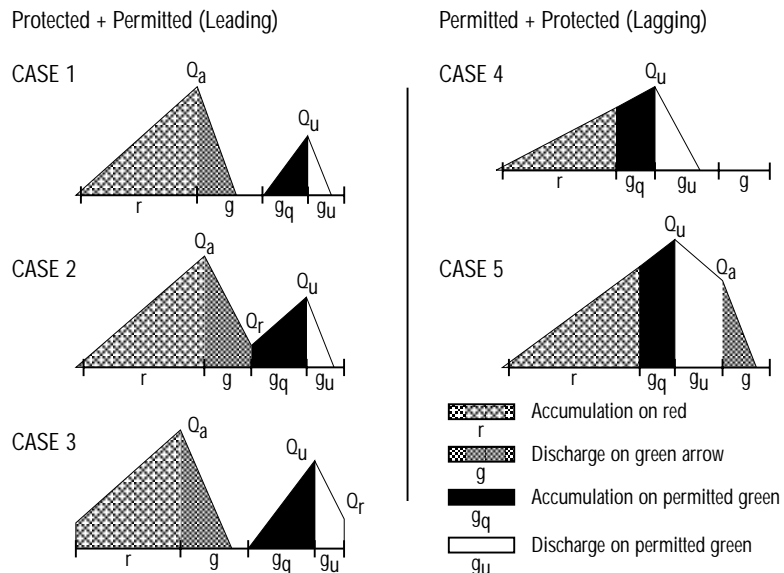

It is first necessary to distinguish between protected-plus-permitted (leading left-turn) phasing and permitted-plus-protected (lagging left-turn) phasing. Three of the five cases shown in Exhibit E16-1 are associated with leading left-turn phases and the other two with lagging left-turn phases. The five cases are identified as follows:

- Case 1—Leading left-turn phase: no queue remains at the end of the protected or permitted phase.
- Case 2—Leading left-turn phase: a queue remains at the end of the protected phase but not at the end of the permitted phase.
- Case 3—Leading left-turn phase: a queue remains at the end of the permitted phase but not at the end of the protected phase. Note that it is not possible to have a queue at the end of both the protected and permitted phases if the v/c ratio is not allowed to exceed 1.0 when the uniform delay term is calculated.
- Case 4—Lagging left-turn phase: no queue remains at the end of the permitted phase. In this case there will be no queue at the end of the protected phase either, because the protected phase follows immediately after the permitted phase and will therefore accommodate all of its arrivals without further delay.
- Case 5—Lagging left-turn phase: a queue remains at the end of the permitted phase. If the v/c ratio is kept below 1.0 as just discussed, this queue will be fully served during the protected phase.

Some intermediate computations are required to provide a consistent framework for dealing with all of these cases. Three queue lengths may be determined at various transition points within the cycle. These values are defined as follows:

- Queue size at the beginning of the green arrow, Q_a (veh);
- Queue size at the beginning of the unsaturated interval of the permitted green phase, Q_u (veh); and
- Residual queue size at the end of either the permitted or protected phase, Q_r (veh).

These queue sizes dictate the shape of the polygon whose area determines the value of uniform delay. Separate equations are given for computing each of the queue sizes for the five cases. Equations are provided on the supplemental worksheet (Exhibit 16-23) for computing the uniform delay as a function of queue sizes.

SUPPLEMENTAL UNIFORM DELAY WORKSHEET

The worksheet is presented in Exhibit 16-23. Input data must first be obtained from other worksheets and entered here, namely, the adjusted left-turn volume from the Volume Adjustment and Saturation Flow Rate Worksheet (Exhibit 16-21) and the v/c ratio, X , for the lane group, obtained from the Capacity and LOS Worksheet (Exhibit 16-22).

The following signal timing intervals are obtained from previous computations:

- Protected-phase effective green, g , determined from the Capacity and LOS Worksheet (Exhibit 16-22);
- Permitted-phase effective green intervals, g_q and g_u , from the supplemental worksheets for permitted left turns (see Appendix C); and
- Red time, r , computed as $C - (g + g_q + g_u)$, where C is the cycle length.

These values are entered in the appropriate rows on the worksheet. Note that extremely heavy opposing traffic may reduce g_u to zero, which means that all of the left turns on the permitted phase will be accommodated as sneakers. The effect of sneakers was approximated on the Volume Adjustment and Saturation Flow Rate Worksheet (Exhibit 16-22) by imposing a lower limit on f_{LT} . Because of the lower limit on f_{LT} , a lower limit must also be imposed on the value of g_u to be entered on the supplemental uniform delay worksheet. The necessary time should be transferred from g_q to g_u to ensure that the value of g_u does not fall below 4 s.

The delay computations begin with determination of the arrival and departure rates in units of vehicles per second for compatibility with the remaining worksheet computations. The arrival rate is determined by dividing the left-turn flow rate, v , by

3600. This value is adjusted to ensure that for purposes of uniform delay computation, the arrivals do not exceed the capacity of the intersection. If the v/c ratio, X, exceeds 1.0, the arrival rate is divided by X, as indicated on the worksheet.

Two departure rates are determined:

- Protected-phase departure rate, $s_p = s/3600$, where s is obtained from the Capacity and LOS Worksheet (Exhibit 16-22); and
- Permitted-phase departure rate, s_s , is computed using Equation E16-1.

$$s_s = \frac{s(g_q + g_u)}{g_u * 3600} \quad (E16-1)$$

where s is the adjusted saturation flow rate for the permitted phase from the Capacity and LOS Worksheet (Exhibit 16-22) and the other values have already been determined as described.

Constraint on permitted-phase departure rate, s_s

When g_u is very short, the permitted-phase departures will be mostly sneakers. Since sneakers move with very low headway, it is possible to have extremely high values of s_s . As a practical matter, the per-lane value of s_s should not exceed the base saturation flow rate for the lane group divided by 3600.

Next, the v/c ratios for the protected and permitted phases, X_{prot} and X_{perm} , are determined from the equations on the worksheet. Note that different equations are used for leading and lagging left-turn phases. Because of the adjustment of the arrival rate performed in the previous step, it will not be possible for both X_{prot} and X_{perm} to exceed 1.0. It will, however, be possible for one or the other to exceed 1.0. It is possible to define five separate cases for delay computation, depending on which of the X values exceed 1.0 and on the left-turn phasing (leading or lagging). The case number is now determined and entered at the bottom of the worksheet.

When the case number is known, the size of the queue at three transition points (Q_a , Q_u , and Q_r) may be determined from the formulas at the bottom of the worksheet. When these values have been computed and entered on the worksheet, uniform delay, d_1 , has been determined.

APPENDIX F. EXTENSION OF SIGNAL DELAY MODELS TO INCORPORATE EFFECT OF AN INITIAL QUEUE

INTRODUCTION

d_3 = initial queue delay

The delay model represented by Equations 16-9 to 16-12 is based on the assumption that there is no initial queue at the start of the analysis period of duration T. In cases where $X > 1.0$ for a 15-min period, the following period begins with an initial queue. This initial queue is referred to as Q_b , in vehicles. Q_b is observed at the start of the red period and excludes any vehicles in queue due to random, cycle-by-cycle fluctuations in demand (overflow queue due to cycle failures). When $Q_b \neq 0$, vehicles arriving during the analysis period will experience an additional delay because of the presence of an initial queue. The magnitude of this additional delay depends on several factors, including the size of the initial queue, the length of the analysis period, and the volume to capacity ratio during the analysis period. The initial queue delay term is designated d_3 .

Five scenarios emerge in the estimation of control delay, labeled Cases I to V. Cases I and II occur when there is no initial queue and the period is either undersaturated (Case I) or oversaturated (Case II). In both Cases $d_3 = 0$, and the delay model in Equation 16-11 applies. Cases III, IV, and V are shown in Exhibits F16-1, F16-2, and F16-3, respectively. Case III occurs when the initial queue Q_b can be fully served in time period T. For this to happen, the sum of Q_b and the total demand in T, qT , must be less than the

available capacity, cT . Case IV in Exhibit F16-2 occurs when there is still unmet demand at the end of T but the size of the unmet demand is decreasing. For this to happen, the demand in T (i.e., qT), should be less than the capacity, cT . Finally, Case V in Exhibit F16-3 occurs when demand in T exceeds the capacity. Here the unmet demand will increase at the end of the period T .

EXHIBIT F16-1. CASE III: INITIAL QUEUE DELAY WITH INITIAL QUEUE CLEARING DURING T

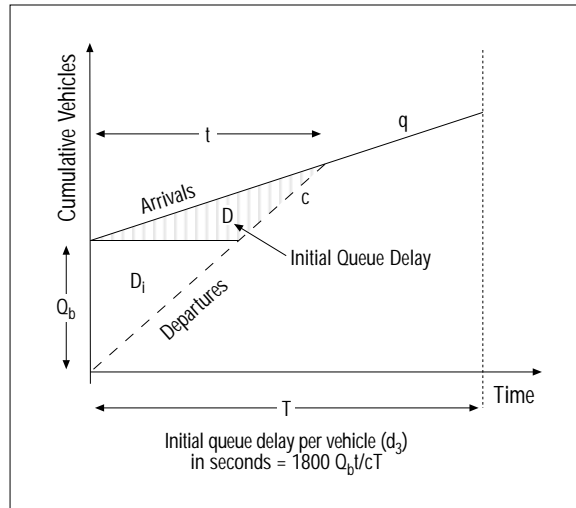
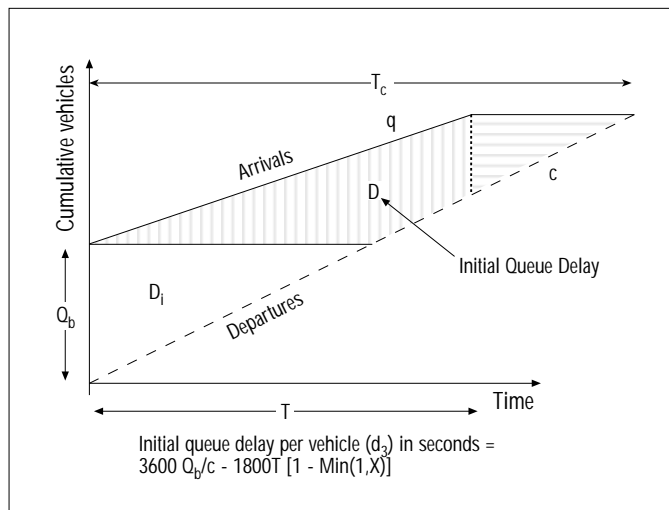

EXHIBIT F16-2. CASE IV: INITIAL QUEUE DELAY WITH INITIAL QUEUE DECREASING DURING T



The total initial queue delay due to an initial queue that is incurred in the average cycle is depicted as the shaded area in Exhibits F16-1 to F16-3, labeled D . It represents the delay experienced by all vehicles arriving during the analysis period, including delay that is experienced in subsequent time periods (Exhibits F16-2 and F16-3). Excluded from this delay are two components: the delay incurred by vehicles in the initial queue (labeled D_i in the exhibits) and the oversaturation delay corresponding to a zero initial queue (labeled D_{so} in Exhibit F16-3). This last term is already accounted for in the d_2 term component of the delay model in Equation 16-12.

Case	Initial Queue	Queue at End of Analysis Period
I	No	No
II	No	Yes
III	Yes	No
IV	Yes	Yes, but smaller
V	Yes	Yes, but larger

Delay estimates for the analysis period include delay experienced by vehicles arriving during the period but leaving after it

EXHIBIT F16-3. CASE V: INITIAL QUEUE DELAY WITH INITIAL QUEUE INCREASING DURING T

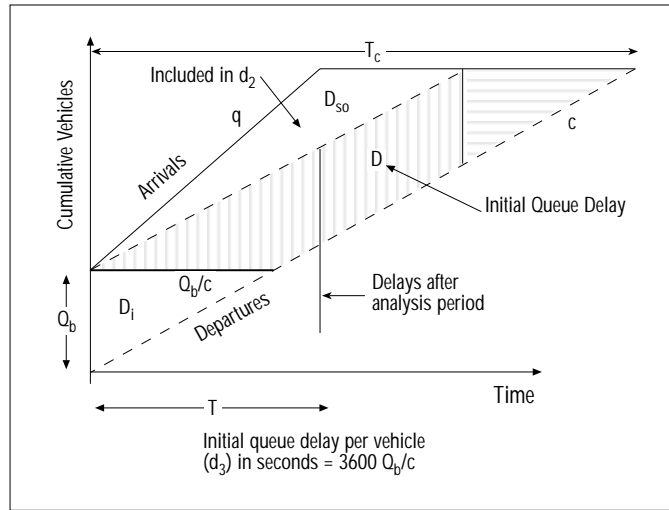

ESTIMATION OF d_3

A generalized form of d_3 appears as Equation F16-1, which provides estimation of the initial queue delay per vehicle (in seconds) when an initial queue of size Q_b is present at the start of the analysis period T . d_3 is a term in the delay model given in Equation 16-9.

$$d_3 = \frac{1800Q_b(1+u)t}{cT} \quad (F16-1)$$

where

- Q_b = initial queue at the start of period T (veh),
- c = adjusted lane group capacity (veh/h),
- T = duration of analysis period (h),
- t = duration of unmet demand in T (h), and
- u = delay parameter.

The parameters t and u are determined according to the prevailing case. Equations F16-2 and F16-3 may be used to estimate the values for Cases III, IV, and V:

$$t = 0 \text{ if } Q_b = 0, \text{ else } t = \min \left\{ T, \frac{Q_b}{c[1 - \min(1, X)]} \right\} \quad (F16-2)$$

where

- X = lane group degree of saturation, v/c

$$u = 0 \text{ if } t < T, \text{ else } u = 1 - \frac{cT}{Q_b[1 - \min(1, X)]} \quad (F16-3)$$

Initial queue clearing time defined

In addition to computation of the initial queue delay term, the analyst may be interested in computing the time at which the last vehicle that arrives during the analysis period clears the intersection (measured from the start of the time period T) because of the presence of an initial queue of length Q_b . This time is referred to as the initial queue clearing time, T_c . In Cases I, II, and III, all vehicles will clear at the end of the period T (in addition to the normal delays $d_1 + d_2$). For Cases IV and V, the last vehicle arriving in T will clear the intersection at time $T_c > T$ (again, in addition to $d_1 + d_2$). Therefore, a general formula for the initial queue clearing time in the case of an initial queue, measured from the start of the analysis period, T , is given as Equation F16-4:

$$T_c = \max\left(T, \frac{Q_b}{c} + TX\right) \tag{F16-4}$$

To summarize the procedure for estimating control delay, Exhibit F16-4 gives a comparison of the model parameters for Cases I through V. Note that in order to decide whether Case III ($t < T$) or IV ($t = T$) applies, the value of t must first be computed from Equation F16-2.

EXHIBIT F16-4. SELECTION OF DELAY MODEL VARIABLES BY CASE

Case No.	X	Q _b	d ₁	d ₂	t	u	d ₃	T _c
I	≤ 1.0	0	Eq. 16-14	Eq. 16-15	0	0	0	T
II	> 1.0	0	Eq. 16-14	Eq. 16-15	0	0	0	TX
III	≤ 1.0	> 0	Eq. F16-5	Eq. 16-15	Eq. F16-2	0	Eq. F16-1	T
IV	≤ 1.0	> 0	Eq. F16-5	Eq. 16-15	T	Eq. F16-3	Eq. F16-1	Eq. F16-4
V	> 1.0	> 0	Eq. F16-5	Eq. 16-15	T	1	Eq. F16-1	Eq. F16-4

For Cases III, IV, and V, the uniform control delay component (d_1) must be evaluated using $X = 1.0$ for the period when an oversaturation queue exists (t) and using the actual X value for the remainder of the analysis period ($T - t$). Therefore, in these cases, a time-weighted value of d_1 is to be used as shown in Equation F16-5.

$$d_1 = d_s * \frac{t}{T} + d_u * PF * \frac{(T - t)}{T} \tag{F16-5}$$

where

- d_s = saturated delay (d_1 evaluated for $X = 1.0$), and
- d_u = undersaturated delay (d_1 evaluated for actual X value).

In Equation F16-5 for Cases IV and V, the d_u term drops out because $t = T$. Equation 16-11 is used to evaluate the d_s and d_u components in all cases except for left turns made from exclusive lanes with compound left-turn protection (protected-permitted and permitted-protected), using $X = 1.0$ in the equation to compute d_s and using the actual X value to compute d_u . For compound left-turn protection, the supplemental uniform delay worksheet in Exhibit 16-23 is used as a means to approximate the d_s and d_u components, again using $X = 1.0$ for d_s and the actual X value for d_u . When $X = 1.0$ is used for the d_s component in Exhibit 16-23, the left-turn volume (v) must also be adjusted by the actual X value (use $v' = v/X$) to meet the basic assumptions of the supplemental uniform delay worksheet.

Note that the only place where PF is used in the initial queue analysis of this appendix is for the undersaturated d_u portion of a Case III condition because the existence of the initial queue defeats the value of the progression under all other conditions. Analysts are advised to be aware of a similar concern in the use of PF in a Case II analysis (oversaturated) using Equation 16-9 because all but the first cycle will be blocked by initial queues due to the oversaturated condition.

NUMERICAL EXAMPLE OF DELAYS WITH INITIAL QUEUE

To demonstrate the application of the delay model extension, an analysis of the EB lane group in Example Problem 1 is carried out with and without an initial queue. The following input values are considered:

- Lane group capacity (c) = 780 veh/h,
- Lane group degree of saturation (X) = 1.026,
- Analysis period length (T) = 0.25 h,
- Initial queue = 20 vehicles (across the two-lane lane group).

d_1 must also be evaluated differently if initial queue is present

Scenario I: No initial queue

In this case, $d_3 = 0$ as per Exhibit F16-4, Case II. The average control delay per vehicle is $d_1PF + d_2 + d_3 = 22.0 * 0.923 + 39.0 + 0.0 = 59.3$ s. The corresponding LOS for a control delay of 59.3 s is E. Finally, the supplemental clearing time $T_c = 15.4$ min for Case II.

Scenario II: Initial queue of 20 vehicles

Since $X > 1.0$ and $Q_b = 20$, Case V in Exhibit F16-4 applies. Here, $t = 0.25$ and $u = 1$. Substituting in Equation F16-1 gives

$$d_3 = \frac{(1800)(20)(1+1)(0.25)}{(780)(0.25)} = 92.3 \text{ s/veh}$$

Therefore, the average control delay per cycle is

$$d = 22.0 + 39.0 + 92.3 = 153.3 \text{ s/veh (LOS F)}$$

which is more than twice the delay calculated when no initial queue is assumed. Note that PF is not applied for Case V. Thus, the impact of an initial queue can be substantial and must be accounted for in delay and LOS estimation.

Finally, the initial queue clearing time, T_c , is estimated from Equation F16-4:

$$T_c = \max\left(0.25, \frac{20}{780} + 0.25 * 1.026\right) = 0.282 \text{ h}$$

or 16.9 min from the start of the peak period. The last vehicle entering in the peak 15-min period will experience an additional 1.9 min of delay because of the presence of the initial queue of 20 vehicles.

EXTENSION TO MULTIPLE TIME PERIODS

The procedure described above can be extended to analyze multiple time periods, each of duration T and each having a fixed demand during T . The analysis is performed sequentially, carrying over the final initial queue Q_b (if any) from one time period to the beginning of the next. In general, for time period i the final initial queue $Q_{b,i+1}$ at the start of the next time period T can be estimated from Equation F16-6:

$$Q_{b,i+1} = \max [0, Q_{b,i} + cT(X_i - 1)], \text{ for } i = 1, 2, \dots, n \tag{F16-6}$$

where

$Q_{b,i}$, X_i = initial queue and degree of saturation for period i .

Typically, a multiple-time-period analysis would start with an undersaturated time period, particularly for $Q_{b,1} = 0$. Once the initial queue is calculated, delays are estimated according to the method described in the previous section. An important feature of multiple-period analysis is that the actual counts taken during each time period should be used in the procedure, that is, the PHF is unity. Counts are then converted into hourly flow rates by dividing each count by T (in hours). The procedure is best described using a numerical example.

NUMERICAL EXAMPLE FOR MULTIPLE-PERIOD ANALYSIS

In this example, consider a signalized lane group with no initial queue that has a fixed capacity of 1,000 veh/h. The demand profile based on 15-min counts (factored to hourly rates) is depicted in Exhibit F16-5. The lane group receives 40 s of effective green time in a 100-s cycle. Arrivals are considered to be random (Arrival Type 3). Calculate the delay and LOS for vehicles arriving in each 15-min time period and for the overall analysis period of 1 h.

EXHIBIT F16-5. DEMAND PROFILE FOR MULTIPLE-PERIOD ANALYSIS WITH 15-MIN PERIODS

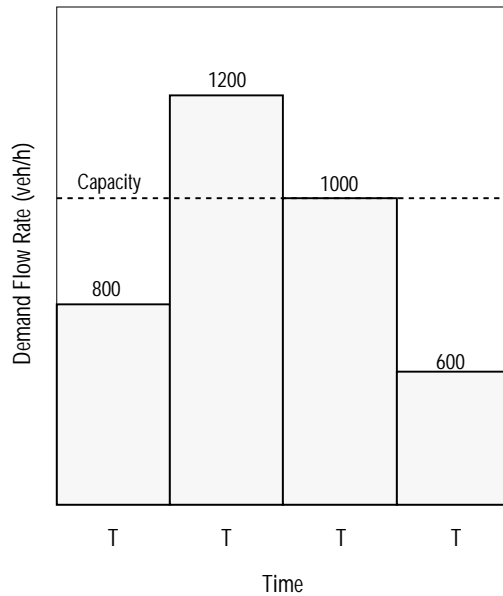

Period 1

Period 1 is undersaturated, with a degree of saturation $X = 800/1000 = 0.80$. Therefore, from Equation F16-6, there is no initial queue ($Q_{b,2}$) at the start of Period 2, assuming no initial queue at the start of Period 1 ($Q_{b,1} = 0$). The average control delay to vehicles arriving in Period 1 will be labeled $d_{c,1}$ and is estimated as follows:

$$d_{c,1} = \frac{0.50 * 100 * \left(1 - \frac{40}{100}\right)^2}{1 - \frac{40}{100} \min(1, 0.80)} * 1.0 + 900 * 0.25 \left[(0.80 - 1) + \sqrt{(0.80 - 1)^2 + \frac{8 * 0.50 * 0.80}{1000 * 0.25}} \right] = 33.2 \text{ s}$$

Period 2

Period 2 is oversaturated, with a degree of saturation $X = 1200/1000 = 1.20$. There is no initial queue at the start of the period, so again the two-component delay formula can be used:

$$d_{c,2} = \frac{0.50 * 100 * \left(1 - \frac{40}{100}\right)^2}{1 - \frac{40}{100} \min(1, 1.20)} * 1.0 + 900 * 0.25 \left[(1.20 - 1) + \sqrt{(1.20 - 1)^2 + \frac{8 * 0.50 * 1.20}{1000 * 0.25}} \right] = 129.7 \text{ s}$$

Period 3

Period 3 is fully saturated, with a degree of saturation $X = 1000/1000 = 1.00$. The residual queue from the previous period, which is equivalent to the initial queue of Period 3, is calculated from Equation F16-6 as follows:

$$Q_{b,3} = \max[0, 0 + 1000 * 0.25 * (1.2 - 1)] = 50 \text{ veh}$$

Here, the initial queue delay term (d_3) must be added. First, the values of t and u are determined from Equations F16-2 and F16-3, respectively:

$$t = \min \left[0.25, \frac{50}{1000(1 - 1)} \right] = 0.25$$

$$u = 1 - \frac{1000 * 0.25 [1 - \min(1.0, 1.0)]}{50} = 1.0$$

Substituting in Equation F16-1 gives

$$d_3 = \frac{1800 * 50 * (1 + 1) * 0.25}{1000 * 0.25} = 180 \text{ s}$$

So the average control delay in Period 3 is

$$d_{c,3} = \frac{0.50 * 100 * \left(1 - \frac{40}{100}\right)^2}{1 - \frac{40}{100} \min(1, 1.0)} * \frac{0.25}{0.25} + 900 * 0.25 \left[(1.0 - 1) + \sqrt{(1.0 - 1)^2 + \frac{8 * 0.50 * 1.0}{1000 * 0.25}} \right] + 180 = 238.5 \text{ s}$$

Period 4

Period 4 is undersaturated, with a degree of saturation $X = 600/1000 = 0.60$. The residual queue from the previous period, which is equivalent to the initial queue of Period 4, is calculated from Equation F16-6 as follows:

$$Q_{b,4} = \max[0, 50 + 1000 * 0.25 * (1.0 - 1)] = 50 \text{ veh}$$

In essence, since the previous period was at capacity, the residual queue at the end of the period is equivalent to that at the start of the period. Again, the computation of d_3 requires the values of t and u , which are calculated as follows:

$$t = \min\left[0.25, \frac{50}{1000(1 - 0.60)}\right] = 0.125$$

Since $t < 0.25$, then $u = 0$ from Equation F16-3. Substituting in Equation F16-1 gives

$$d_3 = \frac{1800 * 50 * (1 + 0.0) * 0.125}{1000 * 0.25} = 45.0 \text{ s}$$

Since $t < T$, the uniform delay component is calculated as per Equation F16-5:

$$d_1 = \frac{0.50 * 100 \left(1 - \frac{40}{100}\right)^2}{\left(1 - \frac{40}{100} * 1.0\right)} * \frac{0.125}{0.25} + \frac{0.50 * 100 \left(1 - \frac{40}{100}\right)^2}{1 - \frac{40}{100} * \min(1, 0.60)} * 1.0 * \frac{0.25 - 0.125}{0.25} = 26.8 \text{ s/veh}$$

Thus, the average control delay in Period 4 is

$$d_{c,4} = 26.8 + 900 * 0.25 * \left[(0.60 - 1.0) + \sqrt{(0.60 - 1.0)^2 + \frac{8 * 0.50 * 0.60}{1000 * 0.25}} \right] + 45 = 74.5 \text{ s/veh}$$

The contribution of each delay term in each period is shown in Exhibit F16-6. The impact of the initial queue delay term is evident, particularly for Periods 3 and 4.

Finally, the average overall control delay to all vehicles arriving in the hour is calculated as a volume-weighted delay of the individual period delays:

$$d_{c,t} = \frac{[800 * 33.2 + 1200 * 129.7 + 1000 * 238.5 + 600 * 74.5]}{[800 + 1200 + 1000 + 600]} = 129.3 \text{ s/veh}$$

The average control delay in the entire period is virtually identical to the delay to vehicles arriving in the peak Period 2, but it is much smaller than the worst delay (and LOS) that is experienced in Period 3, which immediately follows the peak. Thus, a single-period analysis may not be sufficient to determine the worst LOS in an oversaturated time period. When residual queues occur at the end of a peak period, it is recommended that a delay analysis be carried out over subsequent time intervals to ensure that the most severe LOS period is identified.

The example demonstrates how misleading information can result from analyzing only one portion of an oversaturated time period

EXHIBIT F16-6. ILLUSTRATION OF DELAY MODEL COMPONENTS FOR MULTIPLE-PERIOD ANALYSIS

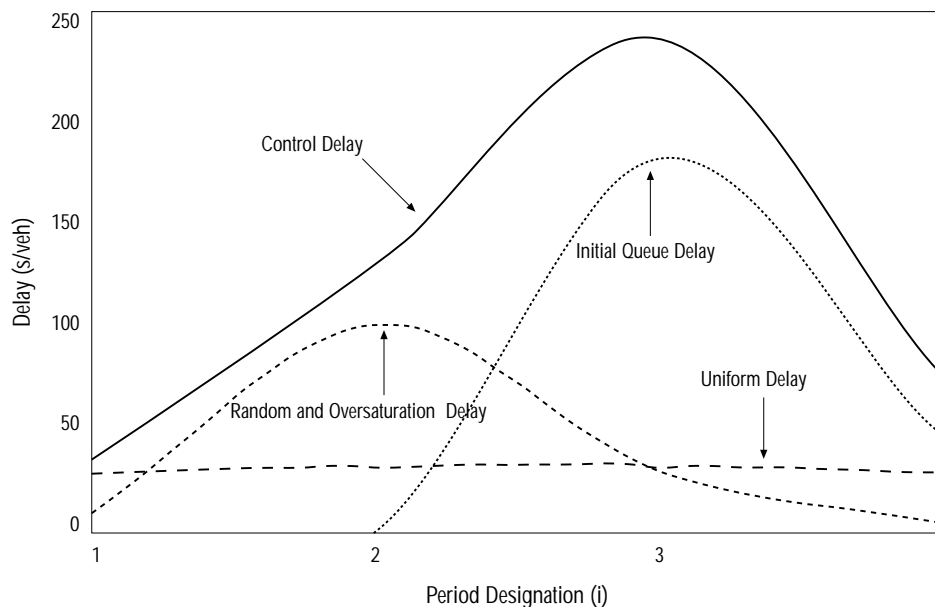

PROCEDURES FOR MAKING CALCULATIONS

Exhibit F16-7 provides a worksheet that can be used in the calculation of delay with initial queue. The following steps should be followed for this worksheet. Each time period will utilize a separate worksheet to calculate the delay when any of the movements at the intersection start with an initial queue during that time period. Each time period should be numbered and the period number and time entered. The duration of the time period, in hours, should also be entered. Note that in a multiperiod analysis the length of each time period should be the same.

Lane groups to be analyzed are those used in the Capacity and LOS Worksheet. Lane groups that do not have an initial queue may appear on this worksheet so that their delay values can be averaged with oversaturated lane groups. In this case, their d_1 and d_2 values will be unchanged and d_3 will be 0. The v/c , lane group capacity, unadjusted uniform delay, and incremental delay values are taken from the Capacity and LOS Worksheet. Unadjusted uniform delay is the product of uniform delay and the progression adjustment factor.

The initial queue for each lane group may either be physically observed in the field (excluding any vehicles in queue due to random cycle-by-cycle fluctuation in demand) or be carried over as the residual queue from the previous analysis time period.

The duration of unmet demand, t , is calculated using Equation F16-2. If there is no initial queue ($Q_b = 0$), then $t = 0$, and the value of t is limited to be no larger than the length of the time period, T .

The adjusted uniform delay term, d_1 , is calculated using Equation F16-5. When $t = 0$, the result is the same as for the unadjusted value of d_1 . Progression effects are included, as appropriate, in this adjusted uniform delay result. The values of g and C for the lane group from the Capacity and LOS Worksheet must be used to make this calculation. Note that the unadjusted value of d_2 is used (from the Capacity and LOS Worksheet) in the final delay calculations and that this delay value includes the oversaturation delay when $v/c > 1$.

Time periods should be of equal lengths in multiperiod analyses

Undersaturated lane groups should be entered for purposes of averaging

EXHIBIT F16-7. INITIAL QUEUE DELAY WORKSHEET

INITIAL QUEUE DELAY WORKSHEET				
General Information				
Project Description _____				
Input Parameters				
Period (i) _____				
Duration, T _____ h				
Cycle length, C _____ s				
	EB	WB	NB	SB
Lane group				
Initial queue, Q_b (veh)				
Green ratio, g/C				
v/c ratio, X $X = v/c$				
Adjusted lane group capacity, c (veh/h)				
Duration of unmet demand in T (h) $t = \min\left\{T, \frac{Q_b}{c[1 - \min(1, X)]}\right\}$				
Case				
Cases I and II ($Q_b = 0$)				
Initial queue delay, $d_3 = 0$, and uniform delay, d_1 , is as shown on Capacity and LOS Worksheet				
Case III ($Q_b > 0$) ($X \leq 1.0$) ($t < T$)				
Initial queue delay, d_3 (s) $d_3 = \frac{1800 Q_b t}{cT}$				
Uniform delay, d_1 (s) $d_1 = 0.50C(1 - g/C) \frac{1}{T} + \frac{0.50C(1 - g/C)^2}{T} \left[\frac{T - t}{1 - g/C \min(1, X)} \right] \cdot PF$				
Case IV ($Q_b > 0$) ($X \leq 1.0$) ($t = T$)				
Delay parameter, u $u = 1 - \frac{cT}{Q_b} [1 - \min(1, X)]$				
Initial queue delay, d_3 (s) $d_3 = \frac{1800 Q_b (1 + u)}{c}$				
Uniform delay, d_1 (s) $d_1 = 0.50C(1 - g/C)$				
Case V ($Q_b > 0$) ($X > 1.0$) ($t = T$)				
Initial queue delay, d_3 (s) $d_3 = \frac{3600 Q_b}{c}$				
Uniform delay, d_1 (s) $d_1 = 0.50C(1 - g/C)$				

The initial queue parameter, u , is calculated using Equation F16-3. When $t < T$, $u = 0$ (Cases I, II, and III); otherwise the equation is used (Case IV), or $u = 1$ (Case V).

The final residual queue is calculated using Equation F16-6. This is the estimate of the number of vehicles in queue at the end of the analysis period. If its value is nonzero, this value indicates that the subsequent analysis period should be analyzed to determine the average delay per vehicle that results because of this initial queue for that time period.

The initial queue delay, d_3 , is calculated using Equation F16-1. This value is the additional delay that results from the existence of the initial queue. Note that this value does not include any of the oversaturation delay, which is accounted for in d_2 . The d_3 value is obtained from the Initial Queue Delay Worksheet (Exhibit F16-7) and is entered in the Capacity and LOS Worksheet (Exhibit 16-22).

Delay and LOS are found by adding the three delay terms d_1 , d_2 , and d_3 for each lane group. Note that the d_1 value includes any appropriate effects of PF on the d_1 term. The LOS corresponding to this delay, taken from Exhibit 16-2, is the result.

The control delay per vehicle is found for each approach by adding the product of the lane group flow rate and the delay for each lane group on the approach and dividing the sum by the total approach flow rate on the Capacity and LOS Worksheet. The LOS is determined from Exhibit 16-2.

The control delay per vehicle for the intersection as a whole is found by adding the product of the approach flow rate and the approach delay for all approaches and dividing by the total intersection flow rate. The intersection LOS is then found from Exhibit 16-2.

APPENDIX G. DETERMINATION OF BACK OF QUEUE

Appendix G provides the procedure to calculate the queue at signalized intersections. The queue length definition used in this model is the back of queue. A relationship for the back of queue is developed as described in the next sections.

The back of queue is the number of vehicles that are queued depending on arrival patterns of vehicles and vehicles that do not clear the intersection during a given green phase (overflow). The model predicts the average back of queue, and 70th-, 85th-, 90th-, 95th-, and 98th-percentile backs of queue.

The model described in this appendix is for use on an individual lane. To apply the method to a lane group, the flow rate, saturation flow rate, capacity, and initial queue demand values for the lane group are converted to individual lane values. If initial queue (Q_b) is present in a lane group, the lane group flow rate is adjusted to include the initial queue present according to Equation G16-1.

$$v_l = v + \frac{Q_b}{T} \quad (G16-1)$$

where

- v_l = lane group flow rate including initial queue present (veh/h),
- v = arrival flow rate (veh/h),
- Q_b = lane group initial queue at start of analysis period (veh), and
- T = length of analysis period (h).

Other parameters for individual lanes are calculated for each lane group by dividing the total lane group values by the number of lanes in the lane group as shown in Equations G16-2 through G16-5. The queue calculated by this method is assumed to be the queue found in any lane of the lane group (all lane queues are assumed to be nominally equal) and reflects the impact of unequal lane usage only to the degree that unequal lane utilization affects saturation flow for the entire lane group. Specifically, it does not reflect the queue in the lane with the longest queue due to unequal lane utilization. If the lane with the longest queue due to unequal lane utilization is desired, this can be calculated by applying the entire HCM methodology on a lane-by-lane basis. As an alternative, the lane with the longest queue can be approximated by determining that lane's unequal lane volume (v_L in Equation G16-2) on the basis of the lane utilization factors instead of dividing by N_{LG} .

$$v_L = \frac{v_l}{N_{LG}} \quad (G16-2)$$

$$s_L = \frac{s}{N_{LG}} \quad (G16-3)$$

$$c_L = \frac{c}{N_{LG}} \quad (G16-4)$$

Back of queue defined

The methodology is applicable to single-lane situations

Parameters are averaged across the number of lanes

$$Q_{bL} = \frac{Q_b}{N_{LG}} \quad (G16-5)$$

where

- v_L = lane group flow rate per lane (veh/h),
- s = lane group saturation flow rate (veh/h),
- s_L = lane group saturation flow rate per lane (veh/h),
- c = lane group capacity (veh/h),
- c_L = lane group capacity per lane (veh/h),
- Q_{bL} = lane group initial queue at start of analysis period per lane (veh), and
- N_{LG} = number of lanes in lane group.

AVERAGE BACK OF QUEUE

The average back-of-queue measure is the basis to calculate percentile back of queue. Equation G16-6 shows average back-of-queue characteristics at signalized intersections.

$$Q = Q_1 + Q_2 \quad (G16-6)$$

where

- Q = maximum distance in vehicles over which queue extends from stop line on average signal cycle (veh),
- Q_1 = first-term queued vehicles (veh), and
- Q_2 = second-term queued vehicles (veh).

The first term, Q_1 , is the average back of queue, determined first by assuming a uniform arrival pattern and then adjusting for the effects of progression for a given lane group. The first term is calculated using Equation G16-7.

$$Q_1 = PF_2 \frac{\frac{v_L C}{3600} \left(1 - \frac{g}{C}\right)}{1 - \left[\min(1.0, X_L) \frac{g}{C}\right]} \quad (G16-7)$$

where

- Q_1 = first-term queued vehicles (veh),
- PF_2 = adjustment factor for effects of progression,
- v_L = lane group flow rate per lane (veh/h),
- C = cycle length (s),
- g = effective green time (s), and
- X_L = ratio of flow rate to capacity (v_L/c_L ratio).

Q_1 represents the number of vehicles that arrive during the red phases and during the green phase until the queue has dissipated.

The adjustment factor for the effects of progression is calculated by Equation G16-8.

$$PF_2 = \frac{\left(1 - R_p \frac{g}{C}\right) \left(1 - \frac{v_L}{s_L}\right)}{\left(1 - \frac{g}{C}\right) \left[1 - R_p \left(\frac{v_L}{s_L}\right)\right]} \quad (G16-8)$$

where

- PF_2 = adjustment factor for effects of progression,
- v_L = lane group flow rate per lane (veh/h),
- s_L = lane group saturation flow rate per lane (veh/h),
- g = effective green time (s),
- C = cycle length (s), and
- R_p = platoon ratio $[P(C/g)]$.

Q_1 is the number of vehicles arriving assuming uniform pattern, adjusted for progression

The second term, Q_2 , is an incremental term associated with randomness of flow and overflow queues that may result because of temporary failures, which can occur even when demand is below capacity. This value can be an approximate cycle overflow queue when there is no initial queue at the start of the analysis period. Initial queue at the start of the analysis period is also accounted for in the second term, Q_2 . Equation G16-9 is used to compute the second term of the average back of queue.

$$Q_2 = 0.25 c_L T \left[(X_L - 1) + \sqrt{(X_L - 1)^2 + \frac{8k_B X_L}{c_L T} + \frac{16k_B Q_{bL}}{(c_L T)^2}} \right] \quad (\text{G16-9})$$

where

- Q_2 = second term of queued vehicles, estimate for average overflow queue (veh);
- c_L = lane group capacity per lane (veh/h);
- T = length of analysis period (h);
- X_L = v_L/c_L ratio;
- k_B = second-term adjustment factor related to early arrivals;
- Q_{bL} = initial queue at start of analysis period (veh); and
- C = cycle length (s).

The second-term adjustment factor related to early arrivals is calculated using Equation G16-10.

$$k_B = 0.12 I \left(\frac{s_L g}{3600} \right)^{0.7} \quad (\text{pretimed signals})$$

$$k_B = 0.10 I \left(\frac{s_L g}{3600} \right)^{0.6} \quad (\text{actuated signals}) \quad (\text{G16-10})$$

where

- k_B = second-term adjustment factor related to early arrivals,
- s_L = lane group saturation flow rate per lane (veh/h),
- g = effective green time (s), and
- I = upstream filtering factor for platoon arrivals (Chapter 15).

Exhibit G16-1 depicts the development of the back of queue over a typical undersaturated cycle in an analysis period. The exhibit shows the queue developing over the red interval and into the green interval until the front of the queue reaches the back of queue, thus dissipating the entire queue. The diagram shows the randomness of arrival rate. The variation in demand may cause individual cycle failures even though the demand over the analysis period is less than the capacity available. During some cycles queue overflow may be experienced as shown in Exhibit G16-2. Thus, the model for average back of queue accounts both for the queuing that occurs with a basic regular flow rate and for that which occurs because of randomness. Thus, there are two basic terms in the equation for determining average back of queue.

Exhibits G16-3 and G16-4 depict the relative contribution of each of the terms for Q across a range of v/c ratios. Exhibit G16-3 is calculated for poor progression, and Exhibit G16-4 shows results for good progression. Unlike the associated delay term, the portion of the queue arising from uniform flow will grow as v/c increases. However, the contribution of the second term (Q_2), the portion of the queue that results from random arrivals and overflow queues, grows proportionally as v/c increases.

Q_2 is the overflow queue

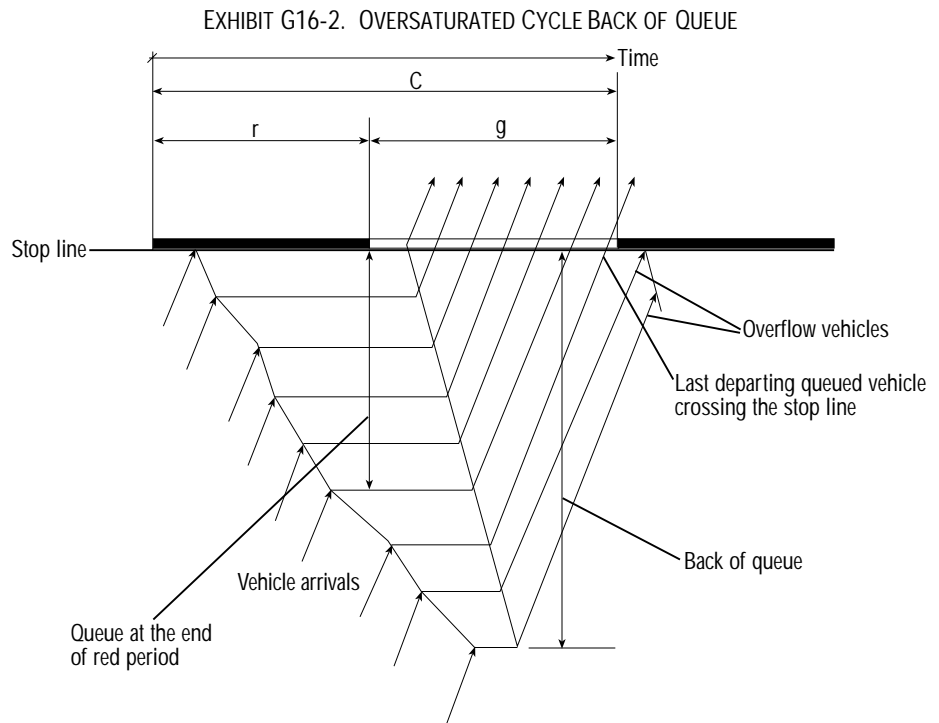
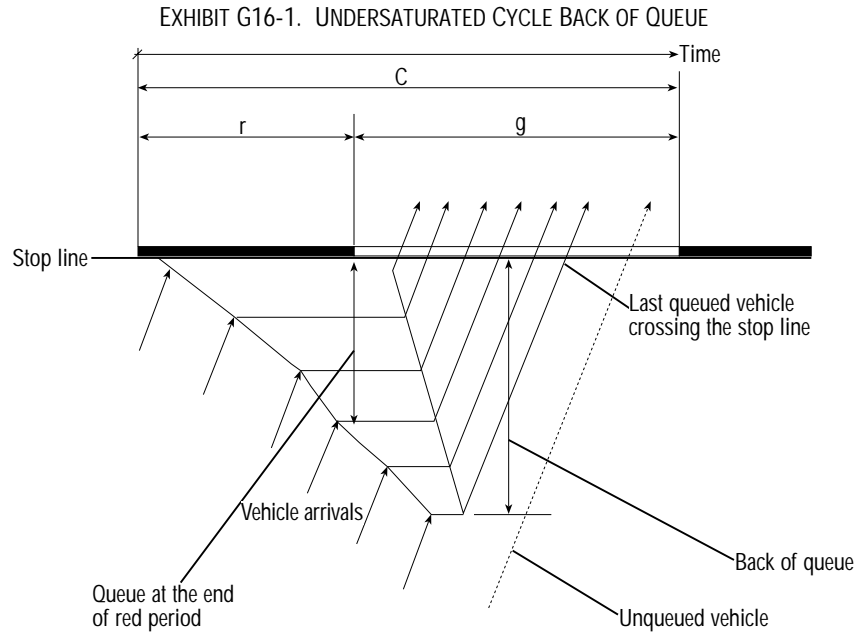
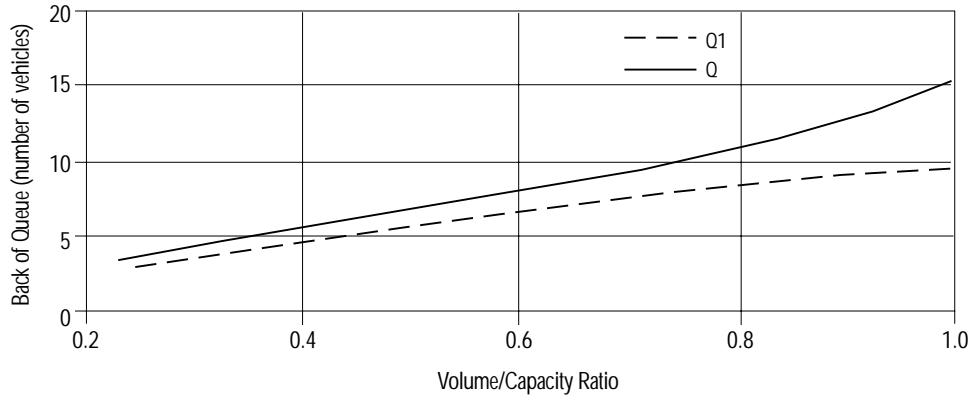
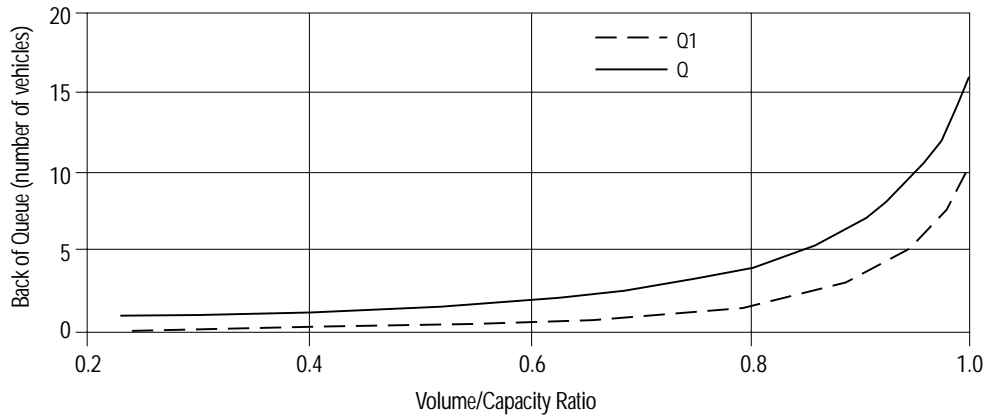

EXHIBIT G16-3. CONTRIBUTION OF THE FIRST AND SECOND TERMS OF BACK OF QUEUE WITH POOR PROGRESSION
(SEE FOOTNOTE FOR ASSUMED VALUES)



Note:
Assumes Arrival Type 1, $g/C = 0.44$, $T = 0.25$ h, $Q_{bl} = 0$, and $s_L = 1,000$ veh/h.

EXHIBIT G16-4. CONTRIBUTION OF THE FIRST AND SECOND TERMS OF BACK OF QUEUE WITH GOOD PROGRESSION
(SEE FOOTNOTE FOR ASSUMED VALUES)



Note:
Assumes Arrival Type 6, $g/C = 0.44$, $T = 0.25$ h, $Q_{bl} = 0$, $s_L = 1,000$ veh/h.

PERCENTILE BACK OF QUEUE

The percentile back of queue is computed by applying the percentile back-of-queue factor to the average back of queue. Equation G16-11 shows this relationship.

$$Q_{\%} = Q f_{B\%} \tag{G16-11}$$

where

- $Q_{\%}$ = percentile back of queue (veh),
- Q = average number of vehicles in queue (veh), and
- $f_{B\%}$ = percentile back-of-queue factor.

The percentile back-of-queue factor is calculated using Equation G16-12.

$$f_{B\%} = p_1 + p_2 e^{\frac{-Q}{p_3}} \tag{G16-12}$$

where

- $f_{B\%}$ = percentile back-of-queue factor,

- p_1 = first parameter for percentile back-of-queue factor (Exhibit G16-5),
- p_2 = second parameter for percentile back-of-queue factor (Exhibit G16-5),
- p_3 = third parameter for percentile back-of-queue factor (Exhibit G16-5),
and
- Q = average number of vehicles in queue (veh).

Exhibit G16-5 gives the first, second, and third parameters of the percentile back-of-queue factor for pretimed and actuated signals.

EXHIBIT G16-5. PARAMETERS FOR 70TH-, 85TH-, 90TH-, 95TH-, AND 98TH-PERCENTILE BACK OF QUEUE

	Pretimed Signals			Actuated Signals		
	p_1	p_2	p_3	p_1	p_2	p_3
$f_{B70\%}$	1.2	0.1	5	1.1	0.1	40
$f_{B85\%}$	1.4	0.3	5	1.3	0.3	30
$f_{B90\%}$	1.5	0.5	5	1.4	0.4	20
$f_{B95\%}$	1.6	1.0	5	1.5	0.6	18
$f_{B98\%}$	1.7	1.5	5	1.7	1.0	13

QUEUE STORAGE RATIO

The back-of-queue measure is useful for dealing with the blockage of available queue storage distance, determined by the queue storage ratio. If the queue storage ratio is less than 1, blockage will not occur. If the queue storage ratio is equal to or greater than 1, blockage will occur. Equations G16-13 and G16-14 are used to calculate average queue storage ratio and percentile queue storage ratio, respectively.

$$R_Q = \frac{L_h Q}{L_a} \tag{G16-13}$$

where

- R_Q = average queue storage ratio,
- L_h = average queue spacing in a stationary queue (m),
- L_a = available queue storage distance (m), and
- Q = average number of vehicles in queue (veh).

$$R_{Q\%} = \frac{L_h Q_{\%}}{L_a} \tag{G16-14}$$

where

- $R_{Q\%}$ = percentile queue storage ratio, and
- $Q_{\%}$ = percentile back of queue (veh).

Average queue spacing is the average length between the front bumpers of two successive vehicles in a stationary queue.

APPLICATION

Exhibit G16-6 provides a worksheet to perform back-of-queue computations. Queue lengths are calculated for each lane in the lane group. Lane group information, flow rates, capacities, and saturation flow rates for each lane group are taken from the Input Worksheet, Volume Adjustment and Saturation Flow Rate Worksheet, and Capacity and LOS Worksheet after they are adjusted for initial queue present and computed on a per-lane basis. The proportion of vehicles arriving on the green should be observed in the field. If field information is available, average arrival rate on green can be calculated. Initial queue at the start of the analysis period also should be observed in the field.

Queue storage ratio is a test for possible blockage

One must assume an average distance between front bumpers of successive vehicles standing in queue

However, if field information is not available, successive period analyses, beginning with a period in which there is no initial queue, can be performed.

EXHIBIT G16-6. BACK-OF-QUEUE WORKSHEET

BACK-OF-QUEUE WORKSHEET												
General Information												
Project Description _____												
Average Back of Queue												
	EB			WB			NB			SB		
	LT	TH	RT	LT	TH	RT	LT	TH	RT	LT	TH	RT
Lane group												
Initial queue per lane at the start of analysis period, Q_{bl}												
Flow rate per lane, v_L (veh/h)												
Saturation flow rate per lane, s_L (veh/h)												
Capacity per lane, c_L (veh/h)												
Flow ratio, v_L/s_L												
v/c ratio, $X_L = v_L/c_L$												
Effective green time, g (s)												
Green ratio, g/C												
Upstream filtering factor, I												
Proportion of vehicles arriving on green, P												
Platoon ratio, R_p $R_p = \left(\frac{P}{g/C}\right)$												
Effects of progression adjustment factor, PF_2 $PF_2 = \frac{\left(1 - R_p \frac{g}{C}\right) \left(1 - \frac{v_L}{s_L}\right)}{\left(1 - \frac{g}{C}\right) \left[1 - R_p \left(\frac{v_L}{s_L}\right)\right]}$												
First-term queued vehicles, Q_1 (veh) $Q_1 = PF_2 \frac{v_L C}{3600} \left(1 - \frac{g}{C}\right) \left[1 - \min\left(1.0, X_L \left(\frac{g}{C}\right)\right)\right]$												
Second-term adjustment factor, k_B $k_B = 0.12 I \left(\frac{S_L g}{3600}\right)^{0.7}$ (pretimed signals) $k_B = 0.10 I \left(\frac{S_L g}{3600}\right)^{0.6}$ (actuated signals)												
Second-term queued vehicles, Q_2 $Q_2 = 0.25 c_L I \left[X_L - 1 + \sqrt{(X_L - 1)^2 + \frac{8 k_B X_L}{c_L I} + \frac{16 k_B Q_{bl}}{(c_L I)^2}} \right]$												
Average number of queued vehicles, Q $Q = Q_1 + Q_2$												
Percentile Back of Queue	<input type="checkbox"/> 70%	<input type="checkbox"/> 85%	<input type="checkbox"/> 90%	<input type="checkbox"/> 95%	<input type="checkbox"/> 98%							
Percentile back-of-queue factor, $f_{B\%}$												
Percentile back-of-queue, $Q_{B\%}$ (veh), $Q_{B\%} = Q f_{B\%}$												
Queue Storage Ratio												
Average queue spacing, L_h (m)												
Available queue storage, L_a (m)												
Average queue storage ratio, $R_Q = \frac{L_h Q}{L_a}$												
Percentile queue storage ratio, $R_{Q\%} = \frac{L_h Q_{B\%}}{L_a}$												
Notes												
1. $f_{B\%} = p_1 + p_2 e^{\left(\frac{-Q}{p_3}\right)}$, where p_1 , p_2 , and p_3 are obtained from Exhibit G16-5.												

After these parameters have been gathered, the average back of queue, Q , is calculated. Then percentile back of queue is calculated for any desired percentile.

Queue storage ratios for average back of queue and desired percentile back of queue are calculated. The available queue storage distance should be determined by field observation. If the facility has not yet been built (planning application), right-of-way limitations or agency requirements should be used to determine available queue storage distance. The average queue spacing in a stationary queue is the average length between

the front bumper of the queued vehicle to the front bumper of the queued vehicle in front. Average queue spacing can be determined according to the traffic composition.

The queue values produced by the estimation procedure in this appendix may be higher than those from other procedures found in the literature, especially at high degrees of saturation or high percentiles, for two reasons. First, many procedures report only average values, applying no queue expansion factor to estimate a higher-percentile approximation. Second, overflow queues that occur occasionally at the end of a cycle are forgiven in many procedures that compute the average back of queue. It must be recognized that the common wisdom that has evolved from popular estimation techniques may be unduly optimistic and that low probabilities of queue overflow may be difficult to achieve when demand is near capacity.

APPENDIX H. DIRECT MEASUREMENT OF PREVAILING SATURATION FLOW RATES

GENERAL NOTES

The default base saturation flow rate used in the methodology of this chapter is 1,900 pc/h/ln. This value must be adjusted for prevailing traffic conditions such as lane width, left turns, right turns, heavy vehicles, grade, parking, parking blockage, area type, bus blockage, and left-turn blockage. These computations are made in the Volume Adjustment and Saturation Flow Rate Worksheet. As an alternative to these computations, the actual saturation flow rate can be measured directly in the field.

Saturation flow rate is the maximum discharge rate during the green time. It is usually achieved after about 10 to 14 s of green, which corresponds to the front axle of the fourth to sixth passenger car crossing the stop line after the beginning of green.

The base saturation flow rate is defined as the discharge rate from a standing queue in a 3.6-m-wide lane that carries only through passenger cars and is otherwise unaffected by conditions such as grade, parking, and turning vehicles. Vehicles are recorded when their front axles cross the stop line. The measurement starts at the beginning of the green time or when the front axle of the first vehicle in the queue passes the stop line. Saturation flow, however, is calculated only from the headways after the fourth vehicle in queue passes the stop line. Other reference points on the vehicle, on the road, or in time may yield different saturation flow rates. In order to maintain consistency with the method described in this chapter and to allow for information exchange, maintaining the roadway and vehicle reference points identified here is essential.

The base saturation flow rate is usually stable over a period of time for similar traffic conditions in a given community. Values measured in the same lane during repetitive weekday traffic conditions (e.g., a.m. or p.m. peaks) normally exhibit relatively narrow distributions. On the other hand, saturation flow rates for different communities or different traffic conditions and compositions, even at the same location, may vary significantly.

For practical purposes, prevailing saturation flow rates are usually expressed in vehicles per hour per lane. As a result, their values also depend on traffic flow composition. The default value is expressed in passenger cars per hour per lane (i.e., passenger cars only). Preferably, local prevailing saturation flow rates should be observed directly. Alternatively, the computation module can be used, with the measured regional base saturation flow rates as the starting values. The default value should be used only as an approximate substitute. Severe weather conditions, unusual traffic mixes, or other special local conditions can yield saturation flow rates that differ markedly from those estimated using the computation procedures. The procedure for measuring

Stability of saturation flow rates

prevailing saturation flow rates is summarized below. A sample field worksheet for recording observations is included as Exhibit H16-1.

EXHIBIT H16-1. FIELD SATURATION FLOW RATE STUDY WORKSHEET

FIELD SATURATION FLOW RATE STUDY WORKSHEET																		
General Information									Site Information									
Analyst _____									Intersection _____									
Agency or Company _____									Area Type <input type="checkbox"/> CBD <input type="checkbox"/> Other									
Date Performed _____									Jurisdiction _____									
Analysis Time Period _____									Analysis Year _____									
Lane Movement Input																		
										Movements Allowed <input type="checkbox"/> Through <input type="checkbox"/> Right turn <input type="checkbox"/> Left turn								
Identify all lane movements and the lane studied																		
Input Field Measurement																		
Veh. in queue	Cycle 1			Cycle 2			Cycle 3			Cycle 4			Cycle 5			Cycle 6		
	Time	HV	T	Time	HV	T	Time	HV	T	Time	HV	T	Time	HV	T	Time	HV	T
1																		
2																		
3																		
4																		
5																		
6																		
7																		
8																		
9																		
10																		
11																		
12																		
13																		
14																		
15																		
16																		
17																		
18																		
19																		
20																		
End of saturation	=====			=====			=====			=====			=====			=====		
End of green	=====			=====			=====			=====			=====			=====		
No. veh. > 20																		
No. veh. on yellow																		
Glossary and Notes																		
HV = Heavy vehicles (vehicles with more than 4 tires on pavement) T = Turning vehicles (L = Left, R = Right) Pedestrians and buses that block vehicles should be noted with the time that they block traffic, for example, P12 = Pedestrians blocked traffic for 12 s B15 = Bus blocked traffic for 15 s																		

MEASUREMENT TECHNIQUE

The following example describes a single-lane saturation flow survey. A two-person field crew is recommended. However, one person with a tape recorder, push-button event recorder, or a notebook computer with appropriate software will suffice. The field notes

and tasks identified in the following section must be adjusted according to the type of equipment used.

1. General tasks: Measure and record the area type and width and grade of the lane being studied. Fill out the survey identification data shown in Exhibit H16-1. Select an observation point where the stop line for the surveyed lane and the corresponding signal heads are clearly visible. The reference point is normally the stop line. Vehicles should consistently stop behind this line. When a vehicle crosses it unimpeded, it has entered the intersection conflict space for the purpose of saturation flow measurement. Left- or right-turning vehicles yielding to opposing through traffic or yielding to pedestrians are not recorded until they proceed through the opposing traffic.

2. Recorder tasks: Note the last vehicle in the stopped queue when the signal turns green. Describe the last vehicle to the timer. Note on the worksheet which vehicles are heavy vehicles and which vehicles turn left or right. Record the time called out by the timer.

3. Timer tasks: Start stopwatch at beginning of green and notify the recorder. Count aloud each vehicle in the queue as its front axle crosses the stop line and note the time of crossing. Call out the time of the fourth, tenth, and last vehicle in the stopped queue as its front axle is crossing the stop line.

If queued vehicles are still entering the intersection at the end of the green, call out (saturation through the end of green - last vehicle was number XX). Note any unusual events that may have influenced the saturation flow rate, such as buses, stalled vehicles, and unloading trucks.

The period of saturation flow begins when the front axle of the fourth vehicle in the queue crosses the stop line or reference point and ends when the front axle of the last queued vehicle crosses the stop line. The last queued vehicle may be a vehicle that joined the queue during the green time.

Measurements are taken cycle by cycle. To reduce the data for each cycle, the time recorded for the fourth vehicle is subtracted from the time recorded for the last vehicle in the queue. This value is the sum of all headways for $(n - 4)$ vehicles, where n is the number of the last vehicle surveyed (this may not be the last vehicle in the queue). This sum is divided by the number of headways after the fourth vehicle [i.e., divided by $(n - 4)$] to obtain the average headway per vehicle under saturation flow. The saturation flow rate is 3,600 divided by this value.

For example, if the time for the fourth vehicle was observed as 10.2 s and the time for the 14th and last vehicle surveyed is 36.5 s, the average saturation headway per vehicle is

$$\frac{(36.5 - 10.2)}{(14 - 4)} = \frac{26.3}{10} = 2.63 \text{ s/veh}$$

and the prevailing saturation flow rate in that cycle is

$$\frac{3600}{2.63} = 1369 \text{ veh/h/ln}$$

In order to obtain a statistically significant value, a minimum of 15 signal cycles with more than eight vehicles in the initial queue is typically required. An average of the saturation flow rate values in individual cycles represents the prevailing local saturation flow rate for the surveyed lane. The percentage of heavy vehicles and turning vehicles in the sample used in the computations should be determined and noted for reference.

Guidelines for attaining statistically satisfying results

APPENDIX I. WORKSHEETS

INPUT WORKSHEET

VOLUME ADJUSTMENT AND SATURATION FLOW RATE WORKSHEET

CAPACITY AND LOS WORKSHEET

SUPPLEMENTAL UNIFORM DELAY WORKSHEET FOR LEFT TURNS FROM EXCLUSIVE LANES WITH
PROTECTED AND PERMITTED PHASES

TRAFFIC-ACTUATED CONTROL INPUT DATA WORKSHEET

SUPPLEMENTAL WORKSHEET FOR PERMITTED LEFT TURNS OPPOSED BY MULTILANE APPROACH

SUPPLEMENTAL WORKSHEET FOR PERMITTED LEFT TURNS OPPOSED BY SINGLE-LANE APPROACH

SUPPLEMENTAL WORKSHEET FOR PEDESTRIAN-BICYCLE EFFECTS ON PERMITTED LEFT TURNS AND
RIGHT TURNS

INITIAL QUEUE DELAY WORKSHEET

BACK-OF-QUEUE WORKSHEET

INTERSECTION CONTROL DELAY WORKSHEET

FIELD SATURATION FLOW RATE STUDY WORKSHEET

INPUT WORKSHEET												
General Information						Site Information						
Analyst						Intersection						
Agency or Company						Area Type	<input type="checkbox"/> CBD					<input type="checkbox"/> Other
Date Performed						Jurisdiction						
Analysis Time Period						Analysis Year						
Intersection Geometry												
Volume and Timing Input												
	EB			WB			NB			SB		
	LT	TH	RT ¹	LT	TH	RT ¹	LT	TH	RT ¹	LT	TH	RT ¹
Volume, V (veh/h)												
% heavy vehicles, % HV												
Peak-hour factor, PHF												
Pretimed (P) or actuated (A)												
Start-up lost time, I ₁ (s)												
Extension of effective green time, e (s)												
Arrival type, AT												
Approach pedestrian volume, ² v _{ped} (p/h)												
Approach bicycle volume, ² v _{bic} (bicycles/h)												
Parking (Y or N)												
Parking maneuvers, N _m (maneuvers/h)												
Bus stopping, N _B (buses/h)												
Min. timing for pedestrians, ³ G _p (s)												
Signal Phasing Plan												
D I A G R A M	Ø1	Ø2	Ø3	Ø4	Ø5	Ø6	Ø7	Ø8				
Timing	G = Y =	G = Y =	G = Y =	G = Y =	G = Y =	G = Y =	G = Y =	G = Y =	G = Y =			
Protected turns			Permitted turns Pedestrian			Cycle length, C = _____ s						
Notes												
1. RT volumes, as shown, exclude RTOR. 2. Approach pedestrian and bicycle volumes are those that conflict with right turns from the subject approach. 3. Refer to Equation 16-2.												

VOLUME ADJUSTMENT AND SATURATION FLOW RATE WORKSHEET												
General Information												
Project Description _____												
Volume Adjustment												
	EB			WB			NB			SB		
	LT	TH	RT	LT	TH	RT	LT	TH	RT	LT	TH	RT
Volume, V (veh/h)												
Peak-hour factor, PHF												
Adjusted flow rate, $v_p = V/PHF$ (veh/h)												
Lane group												
Adjusted flow rate in lane group, v (veh/h)												
Proportion ¹ of LT or RT (P_{LT} or P_{RT})		-			-			-			-	
Saturation Flow Rate (see Exhibit 16-7 to determine adjustment factors)												
Base saturation flow, s_0 (pc/h/ln)												
Number of lanes, N												
Lane width adjustment factor, f_w												
Heavy-vehicle adjustment factor, f_{HV}												
Grade adjustment factor, f_g												
Parking adjustment factor, f_p												
Bus blockage adjustment factor, f_{bb}												
Area type adjustment factor, f_a												
Lane utilization adjustment factor, f_{LU}												
Left-turn adjustment factor, f_{LT}												
Right-turn adjustment factor, f_{RT}												
Left-turn ped/bike adjustment factor, f_{Lpb}												
Right-turn ped/bike adjustment factor, f_{Rpb}												
Adjusted saturation flow, s (veh/h) $s = s_0 N f_w f_{HV} f_g f_p f_{bb} f_a f_{LU} f_{LT} f_{RT} f_{Lpb} f_{Rpb}$												
Notes												
1. $P_{LT} = 1.000$ for exclusive left-turn lanes, and $P_{RT} = 1.000$ for exclusive right-turn lanes. Otherwise, they are equal to the proportions of turning volumes in the lane group.												

CAPACITY AND LOS WORKSHEET												
General information												
Project Description _____												
Capacity Analysis												
Phase number												
Phase type												
Lane group												
Adjusted flow rate, v (veh/h)												
Saturation flow rate, s (veh/h)												
Lost time, t _L (s), t _L = I ₁ + Y - e												
Effective green time, g (s), g = G + Y - t _L												
Green ratio, g/C												
Lane group capacity, ¹ c = s(g/C), (veh/h)												
v/c ratio, X												
Flow ratio, v/s												
Critical lane group/phase (v)												
Sum of flow ratios for critical lane groups, Y _c Y _c = Σ (critical lane groups, v/s)												
Total lost time per cycle, L (s)												
Critical flow rate to capacity ratio, X _c X _c = (Y _c)(C)/(C - L)												
Lane Group Capacity, Control Delay, and LOS Determination												
		EB			WB			NB			SB	
Lane group												
Adjusted flow rate, ² v (veh/h)												
Lane group capacity, ² c (veh/h)												
v/c ratio, ² X = v/c												
Total green ratio, ² g/C												
Uniform delay, d ₁ = $\frac{0.50 C [1 - (g/C)]^2}{1 - [\min(1, X)g/C]}$ (s/veh)												
Incremental delay calibration, ³ k												
Incremental delay, ⁴ d ₂ d ₂ = 900T[(X - 1) + √(X - 1) ² + $\frac{8kIX}{cT}$] (s/veh)												
Initial queue delay, d ₃ (s/veh) (Appendix F)												
Uniform delay, d ₁ (s/veh) (Appendix F)												
Progression adjustment factor, PF												
Delay, d = d ₁ (PF) + d ₂ + d ₃ (s/veh)												
LOS by lane group (Exhibit 16-2)												
Delay by approach, d _A = $\frac{\sum(d)(v)}{\sum v}$ (s/veh)												
LOS by approach (Exhibit 16-2)												
Approach flow rate, v _A (veh/h)												
Intersection delay, d _I = $\frac{\sum(d_A)(v_A)}{\sum v_A}$ (s/veh)												
												Intersection LOS (Exhibit 16-2)
Notes												
1. For permitted left turns, the minimum capacity is (1 + P _L)(3600/C). 2. Primary and secondary phase parameters are summed to obtain lane group parameters. 3. For pretimed or nonactuated signals, k = 0.5. Otherwise, refer to Exhibit 16-13. 4. T = analysis duration (h); typically T = 0.25, which is for the analysis duration of 15 min. I = upstream filtering metering adjustment factor; I = 1 for isolated intersections.												

SUPPLEMENTAL UNIFORM DELAY WORKSHEET FOR LEFT TURNS FROM EXCLUSIVE LANES WITH PROTECTED AND PERMITTED PHASES					
General Information					
Project Description _____					
v/c Ratio Computation					
	EB	WB	NB	SB	
Cycle length, C (s)					
Protected phase eff. green interval, g (s)					
Opposing queue effective green interval, g _q (s)					
Unopposed green interval, g _u (s)					
Red time, r (s) r = C - g - g _q - g _u					
Arrival rate, q _a (veh/s) q _a = $\frac{v}{3600 * \max[X, 1.0]}$					
Protected phase departure rate, s _p (veh/s) s _p = $\frac{s}{3600}$					
Permitted phase departure rate, s _s (veh/s) s _s = $\frac{s(g_q + g_u)}{(g_u * 3600)}$					
If leading left (protected + permitted) v/c ratio, X _{perm} = $\frac{q_a(g_q + g_u)}{s_s g_u}$ If lagging left (permitted + protected) v/c ratio, X _{perm} = $\frac{q_a(r + g_q + g_u)}{s_s g_u}$					
If leading left (protected + permitted) v/c ratio, X _{prot} = $\frac{q_a(r + g)}{s_p g}$ If lagging left (permitted + protected) v/c ratio, X _{prot} is N/A					
Uniform Queue Size and Delay Computations					
Queue at beginning of green arrow, Q _a					
Queue at beginning of unsaturated green, Q _u					
Residual queue, Q _r					
Uniform delay, d ₁					
Uniform Queue Size and Delay Equations					
	Case	Q _a	Q _u	Q _r	d ₁
If X _{perm} ≤ 1.0 & X _{prot} ≤ 1.0	1	q _a r	q _a g _q	0	$[0.50/(q_a C)][rQ_a + Q_a^2/(s_p - q_a) + g_q Q_u + Q_u^2/(s_s - q_a)]$
If X _{perm} ≤ 1.0 & X _{prot} > 1.0	2	q _a r	Q _r + q _a g _q	Q _a - g(s _p - q _a)	$[0.50/(q_a C)][rQ_a + g(Q_a + Q_r) + g_q(Q_r + Q_u) + Q_u^2/(s_s - q_a)]$
If X _{perm} > 1.0 & X _{prot} ≤ 1.0	3	Q _r + q _a r	q _a g _q	Q _u - g _u (s _s - q _a)	$[0.50/(q_a C)][g_q Q_u + g_u(Q_u + Q_r) + r(Q_r + Q_a) + Q_a^2/(s_p - q_a)]$
If X _{perm} ≤ 1.0 (lagging lefts)	4	0	q _a (r + g _q)	0	$[0.50/(q_a C)][(r + g_q)Q_u + Q_u^2/(s_s - q_a)]$
If X _{perm} > 1.0 (lagging lefts)	5	Q _u - g _u (s _s - q _a)	q _a (r + g _q)	0	$[0.50/(q_a C)][(r + g_q)Q_u + g_u(Q_u + Q_a) + Q_a^2/(s_p - q_a)]$

TRAFFIC-ACTUATED CONTROL INPUT DATA WORKSHEET								
General Information				Site Information				
Analyst _____				Intersection _____				
Agency or Company _____				Area Type <input type="checkbox"/> CBD <input type="checkbox"/> Other				
Date Performed _____				Jurisdiction _____				
Analysis Time Period _____				Analysis Year _____				
Approach-Specific Data								
	EB	WB	NB	SB				
Left-turn treatment code ¹								
Left-turn position (leading, lagging, or N/A)								
Left-turn max sneakers, v_{LS} (veh)								
Left-turn free queue, Q_f (veh)								
Approach speed, S_A (km/h)								
Ring 1 and 2 termination (simultaneous, independent, or N/A)								
Phase-Specific Data								
	Ring 1				Ring 2			
	1. WBLT	2. EBTH	3. NBLT	4. SBTH	5. EBLT	6. WBTH	7. SBLT	8. NBTH
Phase type ² (L, T, G, N, X)								
Phase reversal (Yes or No)								
Detector length, DL (m)								
Detector setback, DS (m)								
Max initial interval, MxI (s)								
Added initial per actuation, AI (s)								
Min allowable gap, MnA (s)								
Gap reduction rate, GR								
Ped Walk + Don't Walk, WDW (s)								
Maximum green, MxG (s)								
Intergreen time, Y (s)								
Recall mode (min, max, ped, none)								
Min veh phase time, MnV (s)								
Notes								
1. (0) Does not exist (1) Permitted (2) Protected (3) Protected + Permitted (4) Not opposed 2. (L) Protected left turn on a green arrow (T) Through and right-turning traffic only (G) Permitted left turns and compound left-turn protection (N) In addition to other movements, left turns are not opposed (X) Inactive phases								

**SUPPLEMENTAL WORKSHEET FOR PERMITTED LEFT TURNS
OPPOSED BY MULTILANE APPROACH**

General Information

Project Description _____

Input

	EB	WB	NB	SB
Cycle length, C (s)				
Total actual green time for LT lane group, ¹ G (s)				
Effective permitted green time for LT lane group, ¹ g (s)				
Opposing effective green time, g _o (s)				
Number of lanes in LT lane group, ² N				
Number of lanes in opposing approach, N _o				
Adjusted LT flow rate, v _{LT} (veh/h)				
Proportion of LT volume in LT lane group, ³ P _{LT}				
Adjusted flow rate for opposing approach, v _o (veh/h)				
Lost time for LT lane group, t _L				

Computation

LT volume per cycle, LTC = v _{LT} C/3600				
Opposing lane utilization factor, f _{LUo} (refer to Volume Adjustment and Saturation Flow Rate Worksheet)				
Opposing flow per lane, per cycle $v_{olc} = \frac{v_o C}{3600 N_o f_{LUo}}$ (veh/C/ln)				
$g_f = G[e^{-0.882(LTC^{0.717})}] - t_L$ g _f ≤ g (except for exclusive left-turn lanes) ^{1, 4}				
Opposing platoon ratio, R _{po} (refer to Exhibit 16-11)				
Opposing queue ratio, q _{ro} = max[1 - R _{po} (g _o /C), 0]				
$g_q = \frac{v_{olc} q_{ro}}{0.5 - [v_{olc}(1 - q_{ro})/g_o]} - t_L$, v _{olc} (1 - q _{ro})/g _o ≤ 0.49 (note case-specific parameters) ¹				
g _u = g - g _q if g _q ≥ g _f , or g _u = g - g _f if g _q < g _f				
E _{L1} (refer to Exhibit C16-3)				
$P_L = P_{LT} \left[1 + \frac{(N-1)g}{(g_f + g_u/E_{L1} + 4.24)} \right]$ (except with multilane subject approach) ⁵				
f _{min} = 2(1 + P _L)/g				
$f_m = [g_f/g] + [g_u/g] \left[\frac{1}{1 + P_L(E_{L1} - 1)} \right]$, (f _{min} ≤ f _m ≤ 1.00)				
f _{LT} = [f _m + 0.91(N - 1)]/N (except for permitted left turns) ⁶				

Notes

1. Refer to Exhibits C16-4, C16-5, C16-6, C16-7, and C16-8 for case-specific parameters and adjustment factors.
2. For exclusive left-turn lanes, N is equal to the number of exclusive left-turn lanes. For shared left-turn lanes, N is equal to the sum of the shared left-turn, through, and shared right-turn (if one exists) lanes in that approach.
3. For exclusive left-turn lanes, P_{LT} = 1.
4. For exclusive left-turn lanes, g_f = 0, and skip the next step. Lost time, t_L, may not be applicable for protected-permitted case.
5. For a multilane subject approach, if P_L ≥ 1 for a left-turn shared lane, then assume it to be a de facto exclusive left-turn lane and redo the calculation.
6. For permitted left turns with multiple exclusive left-turn lanes f_{LT} = f_m.

SUPPLEMENTAL WORKSHEET FOR PERMITTED LEFT TURNS OPPOSED BY SINGLE-LANE APPROACH				
General Information				
Project Description _____				
Input				
	EB	WB	NB	SB
Cycle length, C (s)				
Total actual green time for LT lane group, ¹ G (s)				
Effective permitted green time for LT lane group, ¹ g (s)				
Opposing effective green time, g _o (s)				
Number of lanes in LT lane group, ² N				
Adjusted LT flow rate, v _{LT} (veh/h)				
Proportion of LT volume in LT lane group, P _{LT}				
Proportion of LT volume in opposing flow, P _{LT_o}				
Adjusted flow rate for opposing approach, v _o (veh/h)				
Lost time for LT lane group, t _L				
Computation				
LT volume per cycle, LTC = v _{LT} C/3600				
Opposing flow per lane, per cycle, v _{olc} = v _o C/3600 (veh/C/ln)				
Opposing platoon ratio, R _{po} (refer to Exhibit 16-11)				
$g_f = G[e^{-0.860(LTC^{0.629})}] - t_L$ $g_f \leq g$ (except exclusive left-turn lanes) ³				
Opposing queue ratio, q _{r_o} = max[1 - R _{po} (g _o /C), 0]				
$g_q = 4.943v_{olc}^{0.762}q_{r_o}^{1.061} - t_L$ $g_q \leq g$				
$g_u = g - g_q$ if $g_q \geq g_f$, or $g_u = g - g_f$ if $g_q < g_f$				
$n = \max[(g_q - g_f)/2, 0]$				
P _{THo} = 1 - P _{LT_o}				
E _{L1} (refer to Exhibit C16-3)				
$E_{L2} = \max[(1 - P_{THo}^n)/P_{LT_o}, 1.0]$				
f _{min} = 2(1 + P _{LT})/g				
g _{diff} = max[g _q - g _f , 0] (except when left-turn volume is 0) ⁴				
$f_{LT} = f_m = [g_f/g] + \left[\frac{g_u/g}{1 + P_{LT}(E_{L1} - 1)} \right] + \left[\frac{g_{diff}/g}{1 + P_{LT}(E_{L2} - 1)} \right]$ (f _{min} ≤ f _m ≤ 1.00)				
Notes				
<ol style="list-style-type: none"> 1. Refer to Exhibits C16-4, C16-5, C16-6, C16-7, and C16-8 for case-specific parameters and adjustment factors. 2. For exclusive left-turn lanes, N is equal to the number of exclusive left-turn lanes. For shared left-turn lanes, N is equal to the sum of the shared left-turn, through, and shared right-turn (if one exists) lanes in that approach. 3. For exclusive left-turn lanes, g_f = 0, and skip the next step. Lost time, t_L, may not be applicable for protected-permitted case. 4. If the opposing left-turn volume is 0, then g_{diff} = 0. 				

**SUPPLEMENTAL WORKSHEET FOR PEDESTRIAN-BICYCLE EFFECTS
ON PERMITTED LEFT TURNS AND RIGHT TURNS**

General Information				
Project Description _____				
Permitted Left Turns				
	EB	WB	NB	SB
Effective pedestrian green time, ^{1,2} g_p (s)				
Conflicting pedestrian volume, ¹ v_{ped} (p/h)				
$v_{pedg} = v_{ped}(C/g_p)$				
$OCC_{pedg} = v_{pedg}/2000$ if ($v_{pedg} \leq 1000$) or $OCC_{pedg} = 0.4 + v_{pedg}/10,000$ if ($1000 < v_{pedg} \leq 5000$)				
Opposing queue clearing green, ^{3,4} g_q (s)				
Effective pedestrian green consumed by opposing vehicle queue, g_q/g_p ; if $g_q \geq g_p$ then $f_{Lpb} = 1.0$				
$OCC_{pedu} = OCC_{pedg} [1 - 0.5(g_q/g_p)]$				
Opposing flow rate, ³ v_o (veh/h)				
$OCC_r = OCC_{pedu} [e^{-(5/3600)v_o}]$				
Number of cross-street receiving lanes, ¹ N_{rec}				
Number of turning lanes, ¹ N_{turn}				
$A_{pbT} = 1 - OCC_r$ if $N_{rec} = N_{turn}$ $A_{pbT} = 1 - 0.6(OCC_r)$ if $N_{rec} > N_{turn}$				
Proportion of left turns, ⁵ P_{LT}				
Proportion of left turns using protected phase, ⁶ P_{LTA}				
$f_{Lpb} = 1.0 - P_{LT}(1 - A_{pbT})(1 - P_{LTA})$				
Permitted Right Turns				
Effective pedestrian green time, ^{1,2} g_p (s)				
Conflicting pedestrian volume, ¹ v_{ped} (p/h)				
Conflicting bicycle volume, ^{1,7} v_{bic} (bicycles/h)				
$v_{pedg} = v_{ped}(C/g_p)$				
$OCC_{pedg} = v_{pedg}/2000$ if ($v_{pedg} \leq 1000$), or $OCC_{pedg} = 0.4 + v_{pedg}/10,000$ if ($1000 < v_{pedg} \leq 5000$)				
Effective green, ¹ g (s)				
$v_{bicg} = v_{bic}(C/g)$				
$OCC_{bicg} = 0.02 + v_{bicg}/2700$				
$OCC_r = OCC_{pedg} + OCC_{bicg} - (OCC_{pedg})(OCC_{bicg})$				
Number of cross-street receiving lanes, ¹ N_{rec}				
Number of turning lanes, ¹ N_{turn}				
$A_{pbT} = 1 - OCC_r$ if $N_{rec} = N_{turn}$ $A_{pbT} = 1 - 0.6(OCC_r)$ if $N_{rec} > N_{turn}$				
Proportion of right turns, ⁵ P_{RT}				
Proportion of right turns using protected phase, ⁸ P_{RTA}				
$f_{Rpb} = 1.0 - P_{RT}(1 - A_{pbT})(1 - P_{RTA})$				
Notes				
<ol style="list-style-type: none"> 1. Refer to Input Worksheet. 2. If intersection signal timing is given, use Walk + flashing Don't Walk (use G + Y if no pedestrian signals). If signal timing must be estimated, use (Green Time - Lost Time per Phase) from Quick Estimation Control Delay and LOS Worksheet. 3. Refer to supplemental worksheets for left turns. 4. If unopposed left turn, then $g_q = 0$, $v_o = 0$, and $OCC_r = OCC_{pedu} = OCC_{pedg}$. 5. Refer to Volume Adjustment and Saturation Flow Rate Worksheet. 6. Ideally determined from field data; alternatively, assume it equal to $(1 - \text{permitted phase } f_{LT})/0.95$. 7. If $v_{bic} = 0$ then $v_{bicg} = 0$, $OCC_{bicg} = 0$, and $OCC_r = OCC_{pedg}$. 8. P_{RTA} is the proportion of protected green over the total green, $g_{prot}/(g_{prot} + g_{perm})$. If only permitted right-turn phase exists, then $P_{RTA} = 0$. 				

INITIAL QUEUE DELAY WORKSHEET												
General Information												
Project Description _____												
Input Parameters												
Period (i) _____												
Duration, T _____ h												
Cycle length, C _____ s												
	EB			WB			NB			SB		
Lane group												
Initial queue, Q_b (veh)												
Green ratio, g/C												
v/c ratio, X $X = v/c$												
Adjusted lane group capacity, c (veh/h)												
Duration of unmet demand in T (h) $t = \min\left\{T, \frac{Q_b}{c[1 - \min(1, X)]}\right\}$												
Case												
Cases I and II ($Q_b = 0$)												
Initial queue delay, $d_3 = 0$, and uniform delay, d_1 , is as shown on Capacity and LOS Worksheet												
Case III ($Q_b > 0$) ($X \leq 1.0$) ($t < T$)												
Initial queue delay, d_3 (s) $d_3 = \frac{1800 Q_b t}{cT}$												
Uniform delay, d_1 (s) $d_1 = 0.50C(1 - g/C) \frac{t}{T} + \frac{0.50C(1 - g/C)^2}{1 - g/C \min(1, X)} \left[\frac{(T - t)}{T} \right] * PF$												
Case IV ($Q_b > 0$) ($X \leq 1.0$) ($t = T$)												
Delay parameter, u $u = 1 - \frac{cT}{Q_b} [1 - \min(1, X)]$												
Initial queue delay, d_3 (s) $d_3 = \frac{1800 Q_b (1 + u)}{c}$												
Uniform delay, d_1 (s) $d_1 = 0.50C(1 - g/C)$												
Case V ($Q_b > 0$) ($X > 1.0$) ($t = T$)												
Initial queue delay, d_3 (s) $d_3 = \frac{3600 Q_b}{c}$												
Uniform delay, d_1 (s) $d_1 = 0.50C(1 - g/C)$												

BACK-OF-QUEUE WORKSHEET															
General Information															
Project Description _____															
Average Back of Queue															
	EB			WB			NB			SB					
	LT	TH	RT	LT	TH	RT	LT	TH	RT	LT	TH	RT			
Lane group															
Initial queue per lane at the start of analysis period, Q_{bL}															
Flow rate per lane, v_L (veh/h)															
Saturation flow rate per lane, s_L (veh/h)															
Capacity per lane, c_L (veh/h)															
Flow ratio, v_L/s_L															
v/c ratio, $X_L = v_L/c_L$															
Effective green time, g (s)															
Green ratio, g/C															
Upstream filtering factor, I															
Proportion of vehicles arriving on green, P															
Platoon ratio, R_p $R_p = \left(\frac{P}{g/C}\right)$															
Effects of progression adjustment factor, PF_2 $PF_2 = \frac{\left(1 - R_p \frac{g}{C}\right) \left(1 - \frac{v_L}{s_L}\right)}{\left(1 - \frac{g}{C}\right) \left[1 - R_p \left(\frac{v_L}{s_L}\right)\right]}$															
First-term queued vehicles, Q_1 (veh) $Q_1 = PF_2 \frac{\frac{v_L C}{3600} \left(1 - \frac{g}{C}\right)}{\left[1 - \min(1.0, X_L) \left(\frac{g}{C}\right)\right]}$															
Second-term adjustment factor, k_B $k_B = 0.12 I \left(\frac{s_L g}{3600}\right)^{0.7}$ (pretimed signals) $k_B = 0.10 I \left(\frac{s_L g}{3600}\right)^{0.6}$ (actuated signals)															
Second-term queued vehicles, Q_2 $Q_2 = 0.25 c_L I \left[(X_L - 1) + \sqrt{(X_L - 1)^2 + \frac{8 k_B X_L}{c_L I} + \frac{16 k_B Q_{bL}}{(c_L I)^2}} \right]$															
Average number of queued vehicles, Q $Q = Q_1 + Q_2$															
Percentile Back of Queue	<input type="checkbox"/> 70%			<input type="checkbox"/> 85%			<input type="checkbox"/> 90%			<input type="checkbox"/> 95%			<input type="checkbox"/> 98%		
Percentile back-of-queue factor, ¹ $f_{B\%}$															
Percentile back-of-queue, $Q_{\%}$ (veh), $Q_{\%} = Q f_{B\%}$															
Queue Storage Ratio															
Average queue spacing, L_h (m)															
Available queue storage, L_a (m)															
Average queue storage ratio, $R_Q = \frac{L_h Q}{L_a}$															
Percentile queue storage ratio, $R_{Q\%} = \frac{L_h Q_{\%}}{L_a}$															
Notes															
1. $f_{B\%} = p_1 + p_2 e^{\frac{(-Q)}{p_3}}$, where p_1 , p_2 , and p_3 are obtained from Exhibit G16-5.															

FIELD SATURATION FLOW RATE STUDY WORKSHEET

General Information

Analyst _____
 Agency or Company _____
 Date Performed _____
 Analysis Time Period _____

Site Information

Intersection _____
 Area Type CBD Other
 Jurisdiction _____
 Analysis Year _____

Lane Movement Input

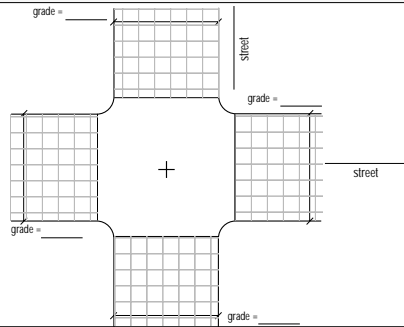

- Movements Allowed
- Through
 - Right turn
 - Left turn

Identify all lane movements and the lane studied

Input Field Measurement

Veh. in queue	Cycle 1			Cycle 2			Cycle 3			Cycle 4			Cycle 5			Cycle 6			
	Time	HV	T	Time	HV	T	Time	HV	T	Time	HV	T	Time	HV	T	Time	HV	T	
1																			
2																			
3																			
4																			
5																			
6																			
7																			
8																			
9																			
10																			
11																			
12																			
13																			
14																			
15																			
16																			
17																			
18																			
19																			
20																			
End of saturation		▬▬▬			▬▬▬			▬▬▬			▬▬▬			▬▬▬			▬▬▬		
End of green		▬▬▬			▬▬▬			▬▬▬			▬▬▬			▬▬▬			▬▬▬		
No. veh. > 20																			
No. veh. on yellow																			

Glossary and Notes

HV = Heavy vehicles (vehicles with more than 4 tires on pavement)
 T = Turning vehicles (L = Left, R = Right)
 Pedestrians and buses that block vehicles should be noted with the time that they block traffic, for example,
 P12 = Pedestrians blocked traffic for 12 s
 B15 = Bus blocked traffic for 15 s

CHAPTER 17

UNSIGNALIZED INTERSECTIONS

CONTENTS

PREFACE 17-1
 Overview..... 17-1
 Limitations of the Methodology..... 17-1
PART A. TWO-WAY STOP-CONTROLLED INTERSECTIONS 17-1
I. INTRODUCTION - PART A 17-1
II. METHODOLOGY - PART A 17-1
 Level-of-Service Criteria 17-1
 Input Data Requirements 17-3
 Priority of Streams..... 17-3
 Conflicting Traffic..... 17-4
 Critical Gap and Follow-Up Time 17-5
 Potential Capacity 17-7
 Movement Capacity 17-8
 Impedance Effects 17-9
 Vehicle Impedance 17-9
 Pedestrian Impedance 17-11
 Shared-Lane Capacity 17-12
 Minor-Street Approaches 17-12
 Major-Street Approaches 17-13
 Upstream Signals..... 17-13
 Time to Clear Standing Queue - Computation 1 17-14
 Proportion of Time TWSC Intersection Is Blocked -
 Computation 2 17-15
 Platoon Event Periods - Computation 3 17-17
 Conflicting Flows During Unblocked Period - Computation 4 17-19
 Capacity During Unblocked Period - Computation 5 17-19
 Two-Stage Gap Acceptance 17-19
 Flared Minor-Street Approaches 17-21
 Estimating Queue Lengths 17-22
 Control Delay 17-23
 Other Relevant Delay Estimates 17-25
 Delay to Rank 1 Vehicles 17-25
 Intersection and Approach Delay 17-25
 Interpreting Results 17-26
 Shared Lanes..... 17-26
 Performance Measures 17-26
 Determining Intersection Control Type 17-27
III. APPLICATIONS - PART A 17-28
 Sequence of Capacity Computations 17-28
 Computational Steps..... 17-28
 Geometrics and Movements (Worksheet 1) 17-28
 Volume Adjustments (Worksheet 2) 17-28
 Site Characteristics (Worksheet 3)..... 17-28
 Critical Gap and Follow-Up Time (Worksheet 4)..... 17-30
 Effect of Upstream Signals (Worksheet 5) 17-30
 Impedance and Capacity Calculation (Worksheet 6) 17-30
 Two-Stage Gap Acceptance (Worksheet 7) 17-31

Shared-Lane Capacity (Worksheet 8)	17-31
Effect of Flared Minor-Street Approaches (Worksheet 9)	17-31
Control Delay, Queue Length, Level of Service (Worksheet 10)	17-31
Delay to Rank 1 Vehicles (Worksheet 11)	17-31
Planning and Design Applications	17-31
PART B. ALL-WAY STOP-CONTROLLED INTERSECTIONS	17-32
I. INTRODUCTION - PART B	17-32
II. METHODOLOGY - PART B	17-32
Level-of-Service Criteria	17-32
Overview of Methodology	17-32
Capacity Model	17-34
Intersection of Two One-Way Streets	17-34
Intersection of Two Two-Way Streets	17-35
Generalized Model for Single-Lane Sites	17-35
Generalized Model for Multilane Sites	17-36
Control Delay	17-40
III. APPLICATIONS - PART B	17-40
Computational Steps	17-41
Geometrics and Movements (Worksheet 1)	17-41
Volume Adjustments and Lane Assignments (Worksheet 2)	17-41
Saturation Headways (Worksheet 3)	17-42
Departure Headway and Service Time (Worksheet 4)	17-42
Worksheet 4a	17-42
Worksheet 4b	17-42
Capacity and Level of Service (Worksheet 5)	17-44
Planning and Design Applications	17-44
PART C. ROUNDABOUTS	17-45
I. INTRODUCTION - PART C	17-45
II. METHODOLOGY - PART C	17-45
Overview of Methodology	17-45
Capacity	17-46
III. APPLICATIONS - PART C	17-48
PART D. EXAMPLE PROBLEMS	17-49
Example Problem 1	17-50
Example Problem 2	17-57
Example Problem 3	17-67
Example Problem 4	17-77
Example Problem 5	17-86
Example Problem 6	17-99
REFERENCES	17-101
Part A - TWSC Unsignalized Intersections	17-101
Part B - AWSC Unsignalized Intersections	17-102
Part C - Roundabouts	17-102
APPENDIX A. WORKSHEETS	17-103
Part A - TWSC Unsignalized Intersections	
Worksheet 1 - Geometrics and Movements	
Worksheet 2 - Volume Adjustments	
Worksheet 3 - Site Characteristics	
Worksheet 4 - Critical Gap and Follow-Up Time	
Worksheet 5 - Effect of Upstream Signals	
Worksheet 6 - Impedance and Capacity Calculation	
Worksheet 7 - Effect of Two-Stage Gap Acceptance	
Worksheet 8 - Shared-Lane Capacity	
Worksheet 9 - Effect of Flared Minor-Street Approaches	

Worksheet 10 - Control Delay, Queue Length, Level of Service
 Worksheet 11 - Delay to Rank 1 Vehicles
 Part B - AWSC Unsignalized Intersections
 Worksheet 1 - Geometrics and Movements
 Worksheet 2 - Volume Adjustments and Lane Assignments
 Worksheet 3 - Saturation Headways
 Worksheet 4 - Departure Headway and Service Time
 Worksheet 5 - Capacity and Level of Service
 Part C - Roundabouts
 Roundabout Worksheet

EXHIBITS

Exhibit 17-1. TWSC Unsignalized Intersection Methodology 17-2
 Exhibit 17-2. Level-of-Service Criteria for TWSC Intersections 17-2
 Exhibit 17-3. Traffic Streams at a TWSC Intersection 17-4
 Exhibit 17-4. Definition and Computation of Conflicting Flows 17-6
 Exhibit 17-5. Base Critical Gaps and Follow-Up Times for TWSC Intersections 17-7
 Exhibit 17-6. Potential Capacity for Two-Lane Streets 17-8
 Exhibit 17-7. Potential Capacity for Four-Lane Streets 17-9
 Exhibit 17-8. Adjustment to Impedance Factors for Major Left Turn,
 Minor Through 17-11
 Exhibit 17-9. Relative Pedestrian/Vehicle Hierarchy 17-12
 Exhibit 17-10. Platoon Dispersion from Upstream Signalized Intersections 17-14
 Exhibit 17-11. Upstream Signalized Intersection 17-15
 Exhibit 17-12. Platoon Dispersion Model 17-16
 Exhibit 17-13. Platoon Dispersion Factor 17-16
 Exhibit 17-14. Platoon Overlap Cases 17-18
 Exhibit 17-15. Proportion of Analysis Period for Each Flow Regime
 (Average Case) 17-18
 Exhibit 17-16. Proportion of Analysis Period Unblocked for Each Minor
 Movement (Average Case) 17-18
 Exhibit 17-17. Two-Stage Gap Acceptance Intersection 17-20
 Exhibit 17-18. Capacity of Flared Approaches 17-21
 Exhibit 17-19. 95th-Percentile Queue Length 17-23
 Exhibit 17-20. Control Delay and Flow Rate 17-24
 Exhibit 17-21. TWSC Intersection Methodology 17-29
 Exhibit 17-22. Level-of-Service Criteria for AWSC Intersections 17-32
 Exhibit 17-23. Operation Patterns at AWSC Intersections 17-33
 Exhibit 17-24. AWSC Configuration - Formulation 1 17-34
 Exhibit 17-25. AWSC Configuration - Formulation 2 17-35
 Exhibit 17-26. Probability of Degree-of-Conflict Case 17-36
 Exhibit 17-27. Degree-of-Conflict Cases for Two-Lane Approach Intersections 17-37
 Exhibit 17-28. Degree-of-Conflict Cases for Three-Lane Approach Intersections 17-37
 Exhibit 17-29. Probability of Degree-of-Conflict Case—Multilane AWSC
 Intersections (Two-Lane Approach) 17-38
 Exhibit 17-30. Probability of Degree-of-Conflict Case—Multilane AWSC
 Intersections (Two-Lane Approaches, by Lane) 17-39
 Exhibit 17-31. AWSC Intersection Methodology 17-41
 Exhibit 17-32. Geometry Groups 17-42
 Exhibit 17-33. Saturation Headway Adjustments by Geometry Group 17-42
 Exhibit 17-34. Probability of a_j 17-43
 Exhibit 17-35. Saturation Headway Values by Case and Geometry Group 17-44

Exhibit 17-36. Analysis on One Roundabout Leg	17-46
Exhibit 17-37. Critical Gap and Follow-Up Times for Roundabouts	17-46
Exhibit 17-38. Roundabout Approach Capacity	17-47
Exhibit 17-39. Flow Stream Definitions	17-47

PREFACE

OVERVIEW

The procedures in this chapter can be used to analyze the capacity and level of service, lane requirements, and effects of traffic and design features of two-way stop-controlled (TWSC) and all-way stop-controlled (AWSC) intersections. In addition, a procedure for estimating capacity of roundabouts is presented.

Each type of unsignalized intersection (TWSC, AWSC, and roundabout) is addressed in a separate part of this chapter. TWSC intersections are covered in Part A, AWSC intersections are covered in Part B, and information on roundabouts is provided in Part C. References for all parts are found in Part D. Example problems that demonstrate the calculations and results achieved by applying the procedures are also found in Part D.

LIMITATIONS OF THE METHODOLOGY

This chapter does not include a detailed method for estimating delay for yield sign-controlled intersections. However, with appropriate changes in the values of key parameters, the analyst could apply the TWSC method to yield-controlled intersections.

All of the methods are for steady-state conditions (i.e., the demand and capacity conditions are constant during the analysis period); the methods are not designed to evaluate how fast or how often the facility transitions from one demand/capacity state to another. Analysts interested in that kind of information should consider applying simulation models.

PART A. TWO-WAY STOP-CONTROLLED INTERSECTIONS

I. INTRODUCTION - PART A

In this section a methodology for analyzing capacity and level of service of two-way stop-controlled (TWSC) intersections is presented.

II. METHODOLOGY - PART A

Capacity analysis at TWSC intersections depends on a clear description and understanding of the interaction of drivers on the minor or stop-controlled approach with drivers on the major street. Both gap acceptance and empirical models have been developed to describe this interaction. Procedures described in this chapter rely on a gap acceptance model developed and refined in Germany (*1*). The concepts from this model are described in Chapter 10. Exhibit 17-1 illustrates input to and the basic computation order of the method described in this chapter.

LEVEL-OF-SERVICE CRITERIA

Level of service (LOS) for a TWSC intersection is determined by the computed or measured control delay and is defined for each minor movement. LOS is not defined for the intersection as a whole. LOS criteria are given in Exhibit 17-2.

Background and concepts for TWSC intersections are in Chapter 10

Both theoretical and empirical approaches have been used to arrive at a methodology

LOS is not defined for the overall intersection

EXHIBIT 17-1. TWSC UNSIGNALIZED INTERSECTION METHODOLOGY

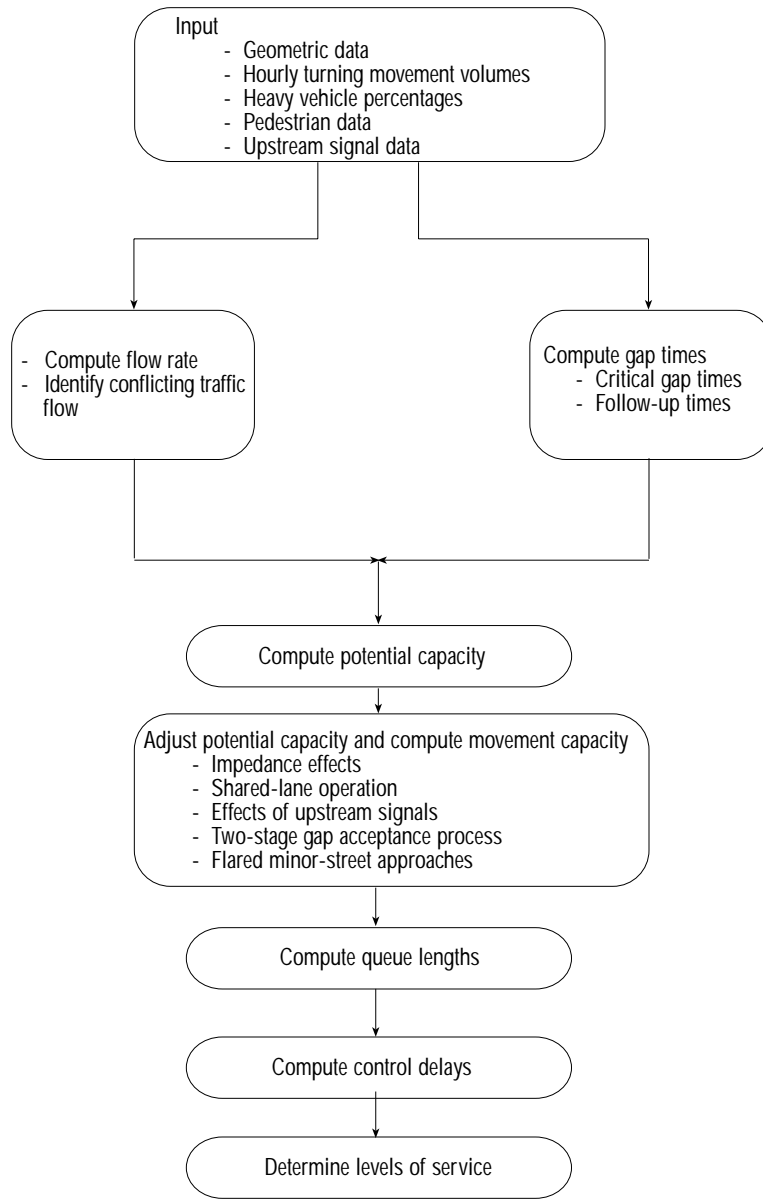

EXHIBIT 17-2. LEVEL-OF-SERVICE CRITERIA FOR TWSC INTERSECTIONS

Level of Service	Average Control Delay (s/veh)
A	0–10
B	> 10–15
C	> 15–25
D	> 25–35
E	> 35–50
F	> 50

The LOS criteria for TWSC intersections are somewhat different from the criteria used in Chapter 16 for signalized intersections primarily because different transportation facilities create different driver perceptions. The expectation is that a signalized intersection is designed to carry higher traffic volumes and experience greater delay than an unsignalized intersection.

LOS thresholds differ from those for signalized intersections to reflect different driver expectations

INPUT DATA REQUIREMENTS

Data requirements for the TWSC intersection methodology are similar to those for other capacity analysis techniques. Detailed descriptions of the geometrics, control, and volumes at the intersection are needed.

Key geometric factors include number and use of lanes, channelization, two-way left-turn lane (TWLTL) or raised or striped median storage (or both), approach grade, and existence of flared approaches on the minor street.

The number and use of lanes are critical factors. Vehicles in adjacent lanes can use the same gap in the traffic stream simultaneously (unless impeded by a conflicting user of the gap). When movements share lanes, only one vehicle from those movements can use each gap. A TWLTL or a raised or striped median (or both) allows a minor-stream vehicle to cross one major traffic stream at a time. The grade of the approach has a direct and measurable effect on the capacity of each minor movement. Compared with a level approach, downgrades increase capacity and upgrades decrease capacity. A flared approach on the minor street increases the capacity by allowing more vehicles to be served simultaneously.

Volumes must be specified by movement. For the analysis to reflect conditions during the peak 15 min, the analyst must divide the full hour volumes by the peak-hour factor (PHF) before beginning computations. If the analyst has peak 15-min flow rates, they can be entered directly with the PHF set to 1.0. The adjusted flow rate for movement x is designated as v_x in this chapter.

By convention, subscripts 1 to 6 define vehicle movements on the major street, and subscripts 7 to 12 define movements on the minor street. Pedestrian flows impede all minor-street movements. Pedestrian volumes must be specified by movement. Subscripts 13 to 16 define the pedestrian movements.

The presence of traffic signals upstream from the intersection on the major street will produce nonrandom flows and affect the capacity of the minor-street approaches if the signal is within 0.4 km of the intersection. The basic capacity model assumes that the headways on the major street are exponentially distributed. To assess the effect on capacity, a separate analysis is provided that requires the signalized intersection data (cycle length, green time), the saturation flow rate, and information on platooned flow.

PRIORITY OF STREAMS

In using the methodology, the priority of right-of-way given to each traffic stream must be identified. Some streams have absolute priority, whereas others have to give way or yield to higher-order streams. Exhibit 17-3 shows the relative priority of streams at both T- and four-leg intersections.

Movements of Rank 1 (denoted by the subscript i) include through traffic on the major street and right-turning traffic from the major street. Movements of Rank 2 (subordinate to 1 and denoted by the subscript j) include left-turning traffic from the major street and right-turning traffic onto the major street.

Movements of Rank 3 (subordinate to 1 and 2 and denoted by the subscript k) include through traffic on the minor street (in the case of a four-leg intersection) and left-turning traffic from the minor street (in the case of a T-intersection). Movements of Rank 4 (subordinate to all others and denoted by the subscript l) include left-turning traffic from the minor street. Rank 4 movements only occur at four-leg intersections.

Rank	Subscript
1	i
2	j
3	k
4	l

EXHIBIT 17-3. TRAFFIC STREAMS AT A TWSC INTERSECTION

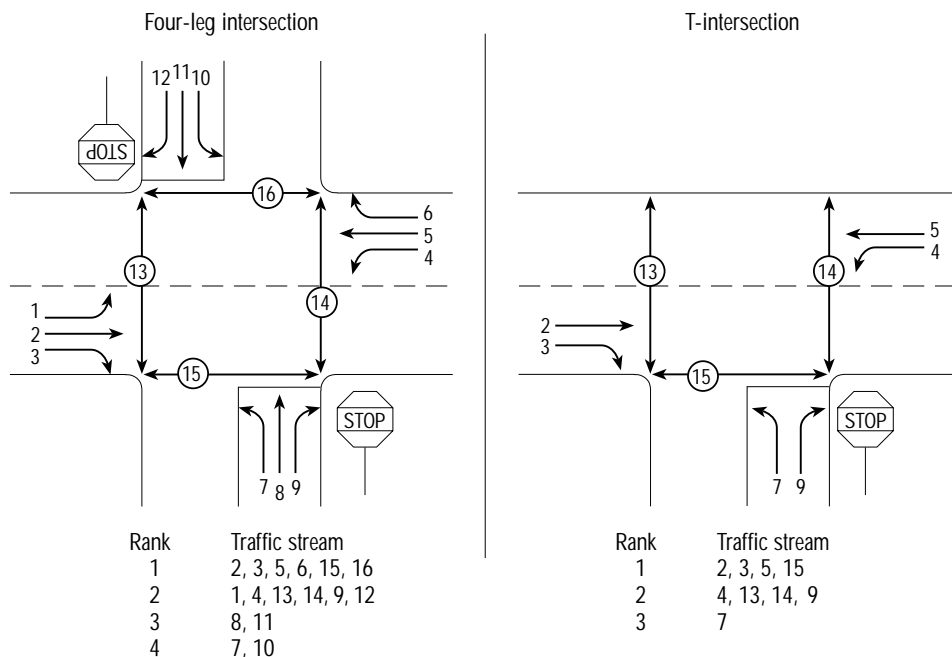

Pedestrians are treated as movements

For example, if a left-turning vehicle on the major street and a through vehicle from the minor street are waiting to cross the major traffic stream, the first available gap of acceptable size would be taken by the left-turning vehicle. The minor-street through vehicle must wait for the second available gap. In aggregate terms, a large number of such left-turning vehicles could use up so many of the available gaps that minor-street through vehicles would be severely impeded or unable to make safe crossing movements.

Because right-turning vehicles from the minor street merely merge into gaps in the right-hand lane of the stream into which they turn, they require only a gap in that lane, not in the entire major-street traffic flow (this may not be true for some trucks and vans with long wheelbases that encroach on more than one lane in making their turn). Furthermore, a gap in the overall major-street traffic could be used simultaneously by another vehicle. For this reason, the method assumes that right turns from the minor street do not impede any of the other flows using major-street gaps.

Pedestrian movements also have priorities with respect to vehicular movements. While this may be a policy issue varying by jurisdiction, both the American Association of State Highway and Transportation Officials (AASHTO) (2) and the *Manual on Uniform Traffic Control Devices* (MUTCD) (3) infer that pedestrians must use acceptable gaps in major-street (Rank 1) traffic streams and that pedestrians have priority over all minor-street traffic at a TWSC intersection. Specific rankings are shown in Exhibit 17-3.

CONFLICTING TRAFFIC

Each movement at a TWSC intersection faces a different set of conflicts that are directly related to the nature of the movement. These conflicts are shown in Exhibit 17-4, which illustrates the computation of the parameter $v_{c,x}$, the conflicting flow rate for movement x, that is, the total flow rate that conflicts with movement x (veh/h).

The right-turn movement from the minor street, for example, is in conflict with only the major-street through movement in the right-hand lane into which right-turners will merge. Exhibit 17-4 includes one-half of the right-turn movement from the major street, because only some of these turns tend to inhibit the subject movement.

Left turns from the major street are in conflict with the total opposing through and right-turn flows, because they must cross the through flow and merge with the right-turn flow. The method does not differentiate between crossing and merging conflicts. Left turns from the major street and the opposing right turns from the major street are considered to merge, regardless of the number of lanes provided in the exit roadway.

Minor-street through movements have a direct crossing or merging conflict with all movements on the major street, as indicated in Exhibit 17-4, except the right turn into the subject approach. Only one-half of this movement is included in the computation, for the reasons discussed above. In addition, field research (4) has shown that the effect of left-turn vehicles is twice their actual number. This effect is reflected in Exhibit 17-4.

The left turn from the minor street is the most difficult maneuver to execute at a TWSC intersection, and it faces the most complex set of conflicting flows, which include all major-street flows, in addition to the opposing right-turn and through movements on the minor street. Only one-half of the opposing right-turn and through movement flow rate is included as conflicting flow rate because both movements are stop-controlled and their effect on left turns is diminished. The additional capacity impedance effects of the opposing right-turn and through movement flow rates are taken into account elsewhere in the procedure.

Pedestrians may also conflict with vehicular traffic streams. Pedestrian flow rates, also defined as v_x , with x noting the leg of the intersection being crossed, should be included as part of the conflicting flow rates, since they, like vehicular flows, define the beginning or ending of a gap that may be used by a minor-stream vehicle. Although it recognizes some peculiarities associated with pedestrian flows, this method takes a uniform approach to vehicular and pedestrian movements.

While regulations or practices may vary between jurisdictions, this methodology assumes that pedestrians crossing the subject or opposing approaches have Rank 1 status and that pedestrians crossing the two conflicting approaches to the left or right of the subject minor-street approach have Rank 2 status. The conflicting pedestrian flow rates are identified in Exhibit 17-4.

Exhibit 17-4 also identifies the conflicting flow rates for each stage of a two-stage gap acceptance process that takes place at some intersections where vehicles store in the median area. If a two-stage gap acceptance process is not present, the conflicting flow rates shown in the rows labeled Stage I and Stage II should be added together and considered as one conflicting flow rate for the movement in question.

CRITICAL GAP AND FOLLOW-UP TIME

The critical gap, t_c , is defined as the minimum time interval in the major-street traffic stream that allows intersection entry for one minor-street vehicle (5). Thus, the driver's critical gap is the minimum gap that would be acceptable. A particular driver would reject any gaps less than the critical gap and would accept gaps greater than or equal to the critical gap. Estimates of critical gap can be made on the basis of observations of the largest rejected and smallest accepted gap for a given intersection.

The time between the departure of one vehicle from the minor street and the departure of the next vehicle using the same major-street gap, under a condition of continuous queuing on the minor street, is called the follow-up time, t_f . Thus, t_f is the headway that defines the saturation flow rate for the approach if there were no conflicting vehicles on movements of higher rank.

In using Exhibit 17-4 to compute conflicting flow rates, the analyst should carefully consult the footnotes, which allow modifications to the equations in special cases.

Critical gap defined

Follow-up time defined

EXHIBIT 17-4. DEFINITION AND COMPUTATION OF CONFLICTING FLOWS

The following footnotes apply to Exhibit 17-4:

[a] If right-turning traffic from the major street is separated by a triangular island and has to comply with a yield or stop sign, v_6 and v_3 need not be considered.

[b] If there is more than one lane on the major street, the flow rates in the right lane are assumed to be v_2/N or v_5/N , where N is the number of through lanes. The user can specify a different lane distribution if field data are available.

[c] If there is a right-turn lane on the major street, v_3 or v_6 should not be considered.

[d] Omit the farthest right-turn v_3 for Subject Movement 10 or v_6 for Subject Movement 7 if the major street is multilane.

[e] If right-turning traffic from the minor street is separated by a triangular island and has to comply with a yield or stop sign, v_9 and v_{12} need not be considered.

[f] Omit v_9 and v_{12} for multilane sites, or use one-half their values if the minor approach is flared.

Subject Movement	Subject and Conflicting Movements Conflicting Traffic Flows, $v_{c,x}$	
Major LT (1, 4)	$v_{c,1} = v_5 + v_6^{[a]} + v_{16}$	$v_{c,4} = v_2 + v_3^{[a]} + v_{15}$
Minor RT (9, 12)	$v_{c,9} = \frac{v_2^{[b]}}{N} + 0.5v_3^{[c]} + v_{14} + v_{15}$	$v_{c,12} = \frac{v_5^{[b]}}{N} + 0.5v_6^{[c]} + v_{13} + v_{16}$
Minor TH (8, 11)	<p>Stage I</p> $v_{c,I,8} = 2v_1 + v_2 + 0.5v_3^{[c]} + v_{15}$	$v_{c,I,11} = 2v_4 + v_5 + 0.5v_6^{[c]} + v_{16}$
	<p>Stage II</p> $v_{c,II,8} = 2v_4 + v_5 + v_6^{[a]} + v_{16}$	$v_{c,II,11} = 2v_1 + v_2 + v_3^{[a]} + v_{15}$
Minor LT (7, 10)	<p>Stage I</p> $v_{c,I,7} = 2v_1 + v_2 + 0.5v_3^{[c]} + v_{15}$	$v_{c,I,10} = 2v_4 + v_5 + 0.5v_6^{[c]} + v_{16}$
	<p>Stage II</p> $v_{c,II,7} = 2v_4 + \frac{v_5}{N} + 0.5v_6^{[d]} + 0.5v_{12}^{[e,f]} + 0.5v_{11} + v_{13}$	$v_{c,II,10} = 2v_1 + \frac{v_2}{N} + 0.5v_3^{[d]} + 0.5v_9^{[e,f]} + 0.5v_8 + v_{14}$

Base values of t_c and t_f for passenger cars are given in Exhibit 17-5. The values are based on studies throughout the United States and are representative of a broad range of conditions. Base values of t_c and t_f for a six-lane major street are assumed to be the same as those for a four-lane major street. Adjustments are made to account for the presence of heavy vehicles, approach grade, T-intersections, and two-stage gap acceptance. The critical gap is computed separately for each minor movement by Equation 17-1.

$$t_{c,x} = t_{c,base} + t_{c,HV} P_{HV} + t_{c,G} G - t_{c,T} - t_{3,LT} \quad (17-1)$$

where

- $t_{c,x}$ = critical gap for movement x (s),
- $t_{c,base}$ = base critical gap from Exhibit 17-5 (s),
- $t_{c,HV}$ = adjustment factor for heavy vehicles (1.0 for two-lane major streets and 2.0 for four-lane major streets) (s),
- P_{HV} = proportion of heavy vehicles for minor movement,
- $t_{c,G}$ = adjustment factor for grade (0.1 for Movements 9 and 12 and 0.2 for Movements 7, 8, 10, and 11) (s),
- G = percent grade divided by 100,
- $t_{c,T}$ = adjustment factor for each part of a two-stage gap acceptance process (1.0 for first or second stage; 0.0 if only one stage) (s), and
- $t_{3,LT}$ = adjustment factor for intersection geometry (0.7 for minor-street left-turn movement at three-leg intersection; 0.0 otherwise) (s).

$t_{c,T}$ is applicable to Movements 7, 8, 10, and 11

EXHIBIT 17-5. BASE CRITICAL GAPS AND FOLLOW-UP TIMES FOR TWSC INTERSECTIONS

Vehicle Movement	Base Critical Gap, $t_{c,base}$ (s)		Base Follow-up Time, $t_{f,base}$ (s)
	Two-Lane Major Street	Four-Lane Major Street	
Left turn from major	4.1	4.1	2.2
Right turn from minor	6.2	6.9	3.3
Through traffic on minor	6.5	6.5	4.0
Left turn from minor	7.1	7.5	3.5

Base factors for a six-lane major street are assumed to be the same as those for a four-lane major street

The follow-up time is computed for each minor movement using Equation 17-2. Adjustments are made for the presence of heavy vehicles.

$$t_{f,x} = t_{f,base} + t_{f,HV} P_{HV} \quad (17-2)$$

where

- $t_{f,x}$ = follow-up time for minor movement x (s),
- $t_{f,base}$ = base follow-up time from Exhibit 17-5 (s),
- $t_{f,HV}$ = adjustment factor for heavy vehicles (0.9 for two-lane major streets and 1.0 for four-lane major streets), and
- P_{HV} = proportion of heavy vehicles for minor movement.

Values from Exhibit 17-5 are considered typical. If smaller values for t_c and t_f are observed, capacity will be increased. If larger values for t_c and t_f are used, capacity will be decreased. More accurate capacity estimates will be produced if field measurements of the critical gap and follow-up time can be made.

It should be noted that the critical gap data for multilane sites account for the actual lane distribution of traffic flows measured at each site. This accounts for the higher value of critical gap for the minor-street right turn (6.9 s) compared with the value for the minor through movement (6.5 s).

POTENTIAL CAPACITY

The gap acceptance model used in this method computes the potential capacity of each minor traffic stream in accordance with Equation 17-3 (6, 7).

Equation 17-3 is also used for major-street left-turn movements

$$c_{p,x} = v_{c,x} \frac{e^{-v_{c,x}t_{c,x}/3600}}{1 - e^{-v_{c,x}t_{f,x}/3600}} \tag{17-3}$$

where

- $c_{p,x}$ = potential capacity of minor movement x (veh/h),
- $v_{c,x}$ = conflicting flow rate for movement x (veh/h),
- $t_{c,x}$ = critical gap (i.e., the minimum time that allows intersection entry for one minor-stream vehicle) for minor movement x (s), and
- $t_{f,x}$ = follow-up time (i.e., the time between the departure of one vehicle from the minor street and the departure of the next under a continuous queue condition) for minor movement x (s).

The potential capacity of a movement is denoted as $c_{p,x}$ (for movement x) and is defined as the capacity for a specific movement, assuming the following base conditions:

- Traffic from nearby intersections does not back up into the subject intersection.
- A separate lane is provided for the exclusive use of each minor-street movement.
- An upstream signal does not affect the arrival pattern of the major-street traffic.
- No other movements of Rank 2, 3, or 4 impede the subject movement.

MOVEMENT CAPACITY

Potential capacity defined

The potential capacity, $c_{p,x}$, of minor-street movements is given in Exhibit 17-6 for a two-lane major street and in Exhibit 17-7 for a four-lane major street. These figures show the application of Equation 17-3 with the values presented in Exhibit 17-5. The potential capacity is expressed as vehicles per hour (veh/h). The exhibits indicate that the potential capacity is a function of the conflicting flow rate $v_{c,x}$ expressed as an hourly rate, as well as the minor-street movement.

EXHIBIT 17-6. POTENTIAL CAPACITY FOR TWO-LANE STREETS

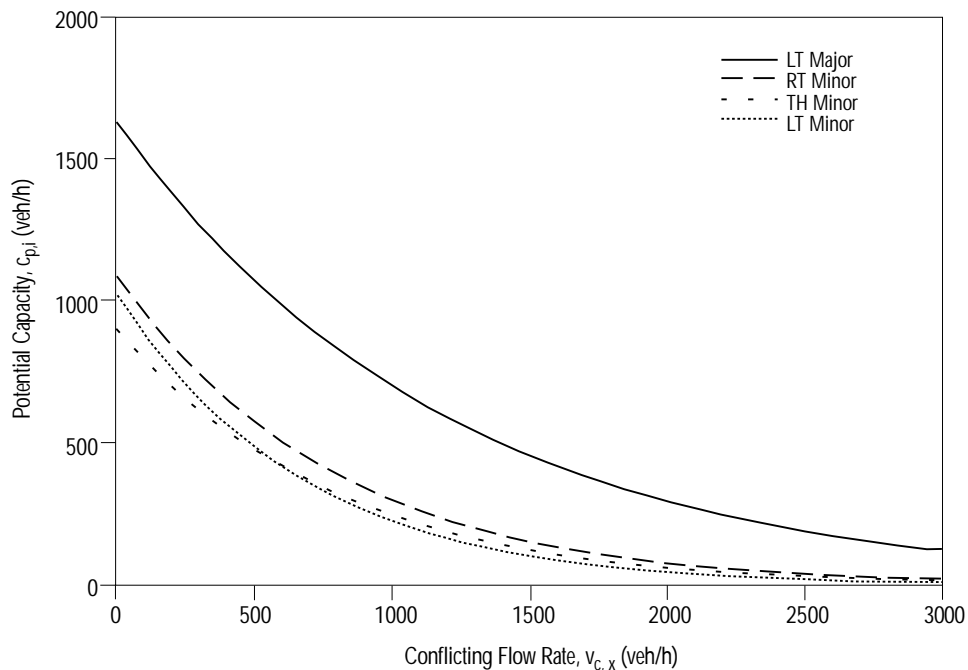
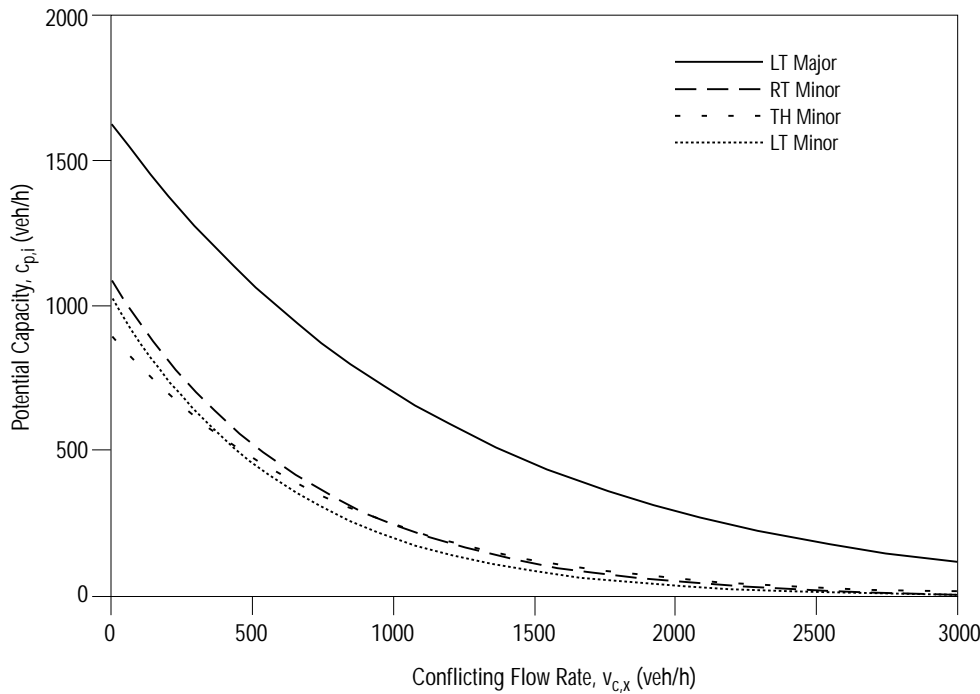

EXHIBIT 17-7. POTENTIAL CAPACITY FOR FOUR-LANE STREETS



Impedance Effects

Vehicle Impedance

Vehicles use gaps at a TWSC intersection in a prioritized manner. When traffic becomes congested in a high-priority movement, it can impede lower-priority movements (i.e., streams of Ranks 3 and 4) from using gaps in the traffic stream, reducing the potential capacity of these movements.

Major traffic streams of Rank 1 are assumed to be unimpeded by any of the minor traffic stream movements. This rank also implies that major traffic streams are not expected to incur delay or slowing as they travel through the TWSC intersection. Empirical observations have shown that such delays do occasionally occur, and they are accounted for by using adjustments provided in the procedures.

Minor traffic streams of Rank 2 (including left turns from the major street and right turns from the minor street) must yield only to the major-street through and right-turning traffic streams of Rank 1. There are no additional impedances from other minor traffic streams, and so the movement capacity of each Rank 2 traffic stream is equal to its potential capacity as indicated by Equation 17-4.

$$C_{m,j} = C_{p,j} \tag{17-4}$$

where j denotes movements of Rank 2 priority.

Minor traffic streams of Rank 3 must yield not only to the major traffic streams, but also to the conflicting major-street left-turn movement, which is of Rank 2. Thus, not all gaps of acceptable length that pass through the intersection will normally be available for use by Rank 3 traffic streams, because some of these gaps are likely to be used by the major-street left-turning traffic. The magnitude of this impedance depends on the probability that major-street left-turning vehicles will be waiting for an acceptable gap at the same time as vehicles of Rank 3. A higher probability that this situation will occur means greater capacity-reducing effects of the major-street left-turning traffic on all Rank 3 movements.

Compute $C_{p,j}$ using Equation 17-3

If major-street through and left-turn movements are shared, use Equation 17-16. Also use Equation 17-5 to compute the probability of queue-free state for Rank 3 movements.

Also account for pedestrian impedance, if significant

What is of interest to the analyst, therefore, is the probability that the major-street left-turning traffic will operate in a queue-free state. This probability is expressed by Equation 17-5:

$$p_{0,j} = 1 - \frac{v_j}{c_{m,j}} \quad (17-5)$$

where $j = 1, 4$ (major-street left-turn movements of Rank 2).

The movement capacity, $c_{m,k}$, for all Rank 3 movements is found by calculating a capacity adjustment factor that accounts for the impeding effects of higher-ranked movements. The capacity adjustment factor is denoted by f_k for all movements k and for all Rank 3 movements and is given by Equation 17-6.

$$f_k = \prod_j p_{0,j} \quad (17-6)$$

where

- $p_{0,j}$ = probability that conflicting Rank 2 movement j will operate in a queue-free state, and
- k = Rank 3 movements.

The movement capacity for the Rank 3 movements is computed using Equation 17-7.

$$c_{m,k} = (c_{p,k})f_k \quad (17-7)$$

Rank 4 movements (i.e., only the minor-street left turns at a four-leg intersection) can be impeded by the queues of three higher-ranked traffic streams:

- Major-street left-turning movements (Rank 2),
- Minor-street crossing movements (Rank 3), and
- Minor-street right-turning movements (Rank 2).

If the intersection has three legs, then the minor-street left turn is a Rank 3 movement and should be evaluated using Equations 17-5 through 17-7.

The probability that each of these higher-ranked traffic streams will operate in a queue-free state is central to determining their overall impeding effects on the minor-street left-turn movement. At the same time, it must be recognized that not all of these probabilities are independent of each other. Specifically, queuing in the major-street left-turning movement affects the probability of a queue-free state in the minor-street crossing movement. Applying the simple product of these two probabilities will likely overestimate the impeding effects on the minor-street left-turning traffic.

Exhibit 17-8 can be used to adjust for the overestimate caused by the statistical dependence between queues in streams of Ranks 2 and 3. The mathematical representation of this curve is given by Equation 17-8.

$$p' = 0.65 p'' - \frac{p''}{p'' + 3} + 0.6 \sqrt{p''} \quad (17-8)$$

where

- p' = adjustment to the major-street left, minor-street through impedance factor;
- p'' = $(p_{0,j})(p_{0,k})$;
- $p_{0,j}$ = probability of a queue-free state for the conflicting major-street left-turning traffic; and
- $p_{0,k}$ = probability of a queue-free state for the conflicting minor-street crossing traffic.

EXHIBIT 17-8. ADJUSTMENT TO IMPEDANCE FACTORS FOR MAJOR LEFT TURN, MINOR THROUGH

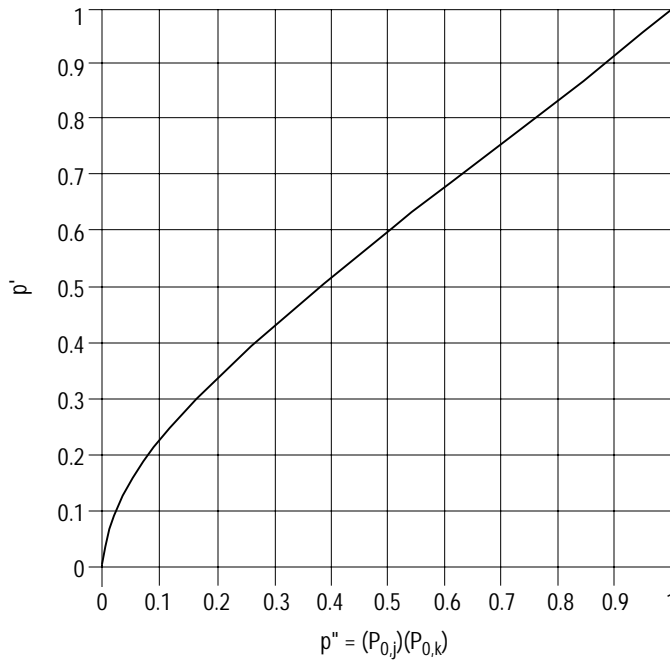

The capacity adjustment factor for the Rank 4 minor-street left-turn movements can be computed by Equation 17-9:

$$f_l = (p')(p_{0,j}) \tag{17-9}$$

where

- l = minor-street left-turn movement of Rank 4 (Movements 7 and 10 in Exhibit 17-3), and
- j = conflicting Rank 2 minor-street right-turn movement (Movements 9 and 12 in Exhibit 17-3).

The variable $p_{0,j}$ should be included in Equation 17-9 only if movement j is identified as a conflicting movement. Refer to Exhibit 17-4 and the associated notes.

Finally, the movement capacity for the minor-street left-turn movements of Rank 4 can be determined from Equation 17-10:

$$c_{m,l} = (f_l)(c_{p,l}) \tag{17-10}$$

where l indicates movements of Rank 4 priority.

Rank 4 movements occur only at four-leg intersections. Equations 17-8 to 17-10 are only required when evaluating four-leg intersections.

Pedestrian Impedance

Minor-street vehicle streams must yield to pedestrian streams. Exhibit 17-9 shows the relative hierarchy between pedestrian and vehicular streams used in this methodology. A factor accounting for pedestrian blockage is computed by Equation 17-11 on the basis of pedestrian volume, the pedestrian walking speed, and the lane width.

$$f_{pb} = \frac{(v_x) \left(\frac{w}{S_p} \right)}{3600} \tag{17-11}$$

Compute $c_{p,l}$ using Equation 17-3

where

- f_{pb} = pedestrian blockage factor, or the proportion of time that one lane on an approach is blocked during 1 h;
- v_x = number of groups of pedestrians, where x is Movement 13, 14, 15, or 16, as described in Equation 18-18;
- w = lane width (m); and
- S_p = pedestrian walking speed, assumed to be 1.2 m/s.

EXHIBIT 17-9. RELATIVE PEDESTRIAN/VEHICLE HIERARCHY

Vehicle Stream	Must Yield to Pedestrian Stream	Impedance Factor for Pedestrians, $p_{p,x}$
v_1	v_{16}	$p_{p,16}$
v_4	v_{15}	$p_{p,15}$
v_7	v_{15}, v_{13}	$(p_{p,15}) (p_{p,13})$
v_8	v_{15}, v_{16}	$(p_{p,15}) (p_{p,16})$
v_9	v_{15}, v_{14}	$(p_{p,15}) (p_{p,14})$
v_{10}	v_{16}, v_{14}	$(p_{p,16}) (p_{p,14})$
v_{11}	v_{15}, v_{16}	$(p_{p,15}) (p_{p,16})$
v_{12}	v_{16}, v_{13}	$(p_{p,16}) (p_{p,13})$

The pedestrian impedance factor for pedestrian movement x, $p_{p,x}$, is computed by Equation 17-12.

$$p_{p,x} = 1 - f_{pb} \tag{17-12}$$

If pedestrians are present to a significant degree, $p_{p,x}$ is included as a factor in Equations 17-6 and 17-9. Equation 17-6 becomes

$$f_k = \prod_j (p_{0,j}) p_{p,x} \tag{17-13}$$

where $p_{p,x}$ takes on the values shown in Exhibit 17-9.

Equation 17-9 becomes

$$f_l = p' p_{0,j} p_{p,x} \tag{17-14}$$

where $p_{p,x}$ takes on the value $p_{p,13} p_{p,15}$ for Stream 7 and $p_{p,14} p_{p,16}$ for Stream 10. Refer to Chapter 18 for a methodology to determine performance measures from a pedestrian perspective at unsignalized intersections.

Shared-Lane Capacity

Minor-Street Approaches

Where several movements share the same lane and cannot stop side-by-side at the stop line, Equation 17-15 is used to compute shared-lane capacity.

$$c_{SH} = \frac{\sum_y v_y}{\sum_y \left(\frac{v_y}{c_{m,y}} \right)} \tag{17-15}$$

where

- c_{SH} = capacity of the shared lane (veh/h),
- v_y = flow rate of the y movement in the subject shared lane (veh/h), and
- $c_{m,y}$ = movement capacity of the y movement in the subject shared lane (veh/h).

Major-Street Approaches

The methodology implicitly assumes that an exclusive lane is provided to all left-turning traffic from the major street. In situations where a left-turn lane is not provided, major-street through (and possibly right-turning) traffic could be delayed by left-turning vehicles waiting for an acceptable gap. To account for this possibility, the factors $p_{0,1}^*$ and $p_{0,4}^*$ may be computed as an indication of the probability that there will be no queue in the respective major-street shared lanes.

$$p_{0,j}^* = 1 - \frac{1 - p_{0,j}}{1 - \left(\frac{v_{i1}}{s_{i1}} + \frac{v_{i2}}{s_{i2}} \right)} \quad (17-16)$$

where

- $p_{0,j}$ = probability of queue-free state for movement j assuming an exclusive left-turn lane on the major street,
- j = 1, 4 (major-street left-turning traffic streams),
- $i1$ = 2, 5 (major-street through traffic streams),
- $i2$ = 3, 6 (major-street right-turning traffic streams),
- s_{i1} = saturation flow rate for the major-street through traffic streams (veh/h) (this parameter can be measured in the field),
- s_{i2} = saturation flow rate for the major-street right-turning traffic (veh/h) (this parameter can be measured in the field),
- v_{i1} = major-street through flow rate (veh/h), and
- v_{i2} = major-street right-turning flow rate (or 0 if an exclusive right-turn lane is provided) (veh/h).

When $j = 1$, $i1 = 21$ and $i2 = 32$; when $j = 4$, $i1 = 51$ and $i2 = 62$

By using $p_{0,1}^*$ and $p_{0,4}^*$ in lieu of $p_{0,1}$ and $p_{0,4}$ (as computed by Equation 17-5), the potential for queues on a major street with shared left-turn lanes may be taken into account.

Upstream Signals

The effects of upstream intersections can only be completely assessed with an appropriate simulation model or field data. An appropriate model would include the ability to represent traffic interactions in the gap acceptance process, platoon dispersion qualities, and signalized intersection control systems.

The method considers the flow patterns resulting from traffic signals located on the major street upstream of the subject TWSC intersection and the headway distribution resulting from the platooned flow. The method is based on a platoon dispersion algorithm (8-10). Exhibit 17-10 shows a generalized case of a TWSC intersection located on a major street between two signalized intersections. The queues that form at each signalized intersection during red phases will disperse as they travel downstream away from the signalized intersection.

Four flow regimes, and thus headway distributions, result as the platoons arrive at the unsignalized intersection:

- Regime 1: no platoons,
- Regime 2: platoon from the left only,
- Regime 3: platoon from the right only, and
- Regime 4: platoons from both directions.

EXHIBIT 17-10. PLATOON DISPERSION FROM UPSTREAM SIGNALIZED INTERSECTIONS

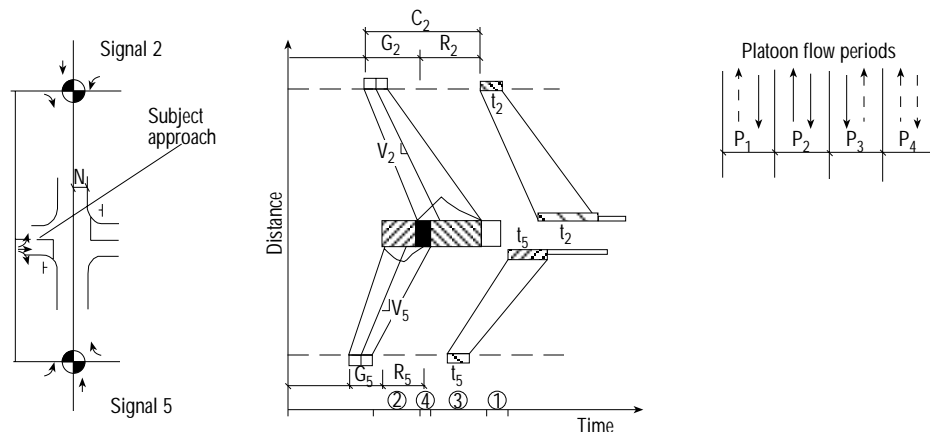

During Regime 1, minor-stream vehicles enter the subject TWSC intersection as described by the traditional gap acceptance process. Whereas platoons are present from both directions during Regime 4, no minor-stream vehicles are able to enter the subject intersection since the mean headways of the platoon are assumed to be less than the critical gap. Some of the minor-stream movements are blocked by the platoon during Regimes 2 and 3 and are unable to enter the subject intersection. A minor stream is considered to be blocked if a conflicting platoon is traveling through the TWSC intersection; the stream is considered to be unblocked if no conflicting platoons are traveling through the TWSC intersection.

If the traffic signals at the two upstream intersections are coordinated, these patterns are predictable and occur at regular intervals. On the basis of the flow pattern that exists during each regime, the capacity can be estimated. If one or both of the signals are actuated, the patterns are less predictable.

Inputs for analysis of platoons

The analyst needs the following data for each upstream signal:

- Cycle length, C (s);
- Major-street effective green time, g_{eff} (s);
- Saturation flow rate, s (veh/h);
- Distance from the signalized intersection to the TWSC intersection, D (m);
- Speed of the platoon as it progresses from the signalized intersection to the TWSC intersection, S_{prog} (m/s);
- Upstream flow rate, including the through flow rate from the major-street approach and, if applicable and significant, the left-turn flow rate from the minor street during an exclusive left-turn phase; and
- Arrival type of vehicles at the signalized intersection.

The method includes five sets of computations as identified in the following sections.

Time to Clear Standing Queue - Computation 1

In a typical four-leg upstream intersection, three movements combine to constitute the exit-leg flow in the direction of the subject TWSC intersection. This is shown in Exhibit 17-11.

The flow v_{out} consists of two components. One is a stable platoon discharging at the saturation flow rate when the signal changes from red to green. The second is more or less random arrivals and departures, or a platoon from another upstream signal passing through on the green phase.

In the context of this chapter, the first component includes both the portion of v_T that arrives during red and the portion that arrives during green when the standing queue is clearing. It also includes v_L for the same periods if v_L has an exclusive left-turn lane and

a protected green phase. The second component includes the portion of v_T (and v_L , if applicable) that arrives after the queue has cleared.

EXHIBIT 17-11. UPSTREAM SIGNALIZED INTERSECTION

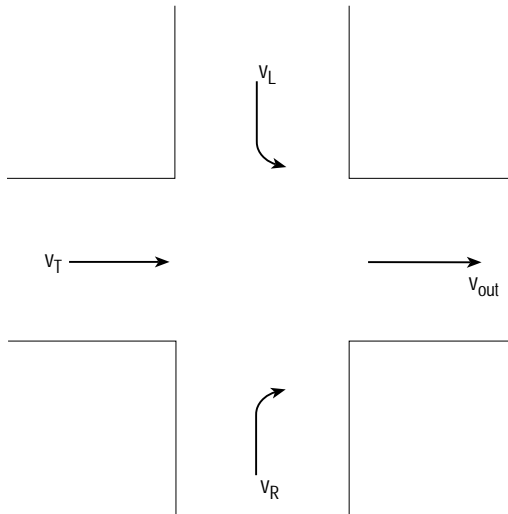

The platooning effect of v_R is not considered in this methodology

The time required for a standing queue to clear depends on the pattern of vehicles arriving at the upstream signalized intersection. The arrival pattern (designated arrival type in Chapter 16) is determined by the proportion of vehicles arriving during the green phase.

The proportion of vehicles arriving on green is computed by Equation 17-17.

$$P = R_p(g_{eff}/C), \quad P \leq 1.0 \quad (17-17)$$

where R_p is a function of the arrival type (see Chapter 16).

The time to discharge the vehicles that arrive during red is given by Equation 17-18.

$$g_{q1} = \frac{v_{prog} C(1 - P)}{s} \quad (17-18)$$

where v_{prog} is either $v_{T,prog}$ or $v_{L,prot}$ and s is the total saturation flow rate of the through or left movement of the upstream signalized intersection.

The time to discharge the vehicles that arrive on green and join the back of the queue is given by Equation 17-19.

$$g_{q2} = \frac{v_{prog} CPg_{q1}}{sg_{eff} - v_{prog} CP} \quad (17-19)$$

where v_{prog} is either $v_{T,prog}$ or $v_{L,prot}$.

The total time to discharge the queue is given by Equation 17-20.

$$g_q = g_{q1} + g_{q2} \quad (17-20)$$

where g_q is less than or equal to g_{eff} .

Proportion of Time TWSC Intersection Is Blocked - Computation 2

The discharging queue from the upstream signal will disperse as it travels downstream toward the subject TWSC intersection. A platoon dispersion model is used to determine the length of time that the TWSC intersection is blocked by the densest part of the platoon. The platoon headways are smaller than the critical gap, and thus no minor movement at the TWSC intersection can enter the intersection during the passage of the platoon. See Exhibit 17-12.

If an exclusive LT lane exists, determine

- g_{q1} for TH movement
- g_{q1} for LT movement
- g_{q2} for TH movement
- g_{q2} for LT movement

The minimum platooned flow rate, $v_{c,min}$, is at least $3,600N/t_c$, where N is the number of through lanes per direction on the major street. It is assumed to be equal to $1,000N$ veh/h on the basis of simulation data (10).

The duration of the blocked period for either the through movement or the protected left-turn movement is computed by using Equation 17-22.

$$\begin{aligned} & \text{If } v_{c,min} < sf \text{ and } v_{c,max} \geq v_{c,min} \text{ and } v_{c,max} \geq v_{prog}R_{pf}, \text{ then} \\ & t_{p,i} = g_q - \frac{\ln \left[\left(1 - \frac{v_{c,min}}{sf} \right) \left(\frac{v_{c,max} - v_{prog}R_{pf}}{v_{c,min} - v_{prog}R_{pf}} \right) \right]}{\ln(1 - F)} \\ & \text{If } v_{c,min} \geq sf \text{ or } v_{c,max} \leq v_{c,min}, \text{ then} \\ & t_{p,i} = 0 \end{aligned} \tag{17-22}$$

If $v_{c,min} < sf$ and $v_{c,max} \geq v_{c,min}$ and $v_{prog}R_{pf} \geq v_{c,min}$, then

$$t_{p,i} = C \left(\frac{v_{prog}}{v_{c,min}} \right)$$

The subscript i is set equal to T when the blocked period caused by the through movement platoon is computed. The subscript is set to L when the blocked period caused by the protected left movement platoon is computed.

The proportion of time blocked is computed by using Equation 17-23, considering both the through movement and the protected left-turn movement platoons:

$$p_i = \frac{t_{p,T} + t_{p,L}}{C} \tag{17-23}$$

where i denotes either Movement 2 or Movement 5. Note that p_i cannot exceed one.

Platoon Event Periods - Computation 3

This computation is used to determine the proportion of the analysis period during which each of the four flow regimes exist. In particular, the proportion of the analysis period that is unblocked for each minor movement is determined.

The existence of a traffic signal on both upstream approaches will result in an overlapping platoon structure at the TWSC intersection. Depending on the signal timing parameters, a range of cases may present themselves, from a best case of simultaneous platoons from both directions to a worst case of alternating platoons from each direction. An average case results in a partial overlap of the platoons. Exhibit 17-14 illustrates these cases and can be used to represent the expected pattern averaged over the analysis period.

If p_2 and p_5 represent the proportion of the analysis period during which Movements 2 and 5 (and their corresponding turning movements) are blocking the TWSC intersection, respectively, the proportion of the analysis period during which blockages exist can be computed. The dominant and subordinate platoons are determined by Equations 17-24 and 17-25.

$$p_{dom} = \text{Max}(p_2, p_5) \tag{17-24}$$

$$p_{subo} = \text{Min}(p_2, p_5) \tag{17-25}$$

Unconstrained conditions exist if there is some period of time during which neither platoon is present. This condition is defined by Equation 17-26:

$$p_{dom} + (p_{subo}/2) \leq 1 \tag{17-26}$$

The constrained condition exists if one or both platoons are always present. This condition is defined by Equation 17-27.

If two-stage gap acceptance is applicable, repeat Computations 3, 4, and 5 for the two-stage process for Movements 7, 8, 10, and 11

$$\rho_{dom} + (\rho_{sub}/2) > 1$$

(17-27)

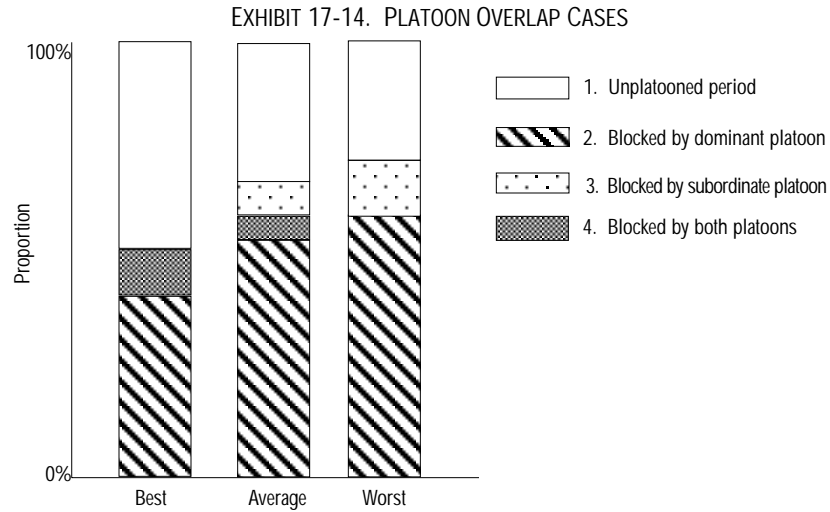

Best case: platoons completely overlap so unplatooned period is maximum.

Worst case: platoons alternate so unplatooned period is minimum.

Average case: one-half of subordinate platoon is subsumed by dominant platoon.

Exhibit 17-15 indicates the proportion of the analysis period for each of the four flow regimes for the average case. Exhibit 17-15 is used to determine the proportion of the analysis period that is blocked and unblocked for each minor movement. The results for each minor movement for the average case are given in Exhibit 17-16.

EXHIBIT 17-15. PROPORTION OF ANALYSIS PERIOD FOR EACH FLOW REGIME (AVERAGE CASE)

Flow Regime	Unconstrained Condition	Constrained Condition
1 - no platoons	$1 - (\rho_{dom} + \rho_{sub}/2)$	0
2 - dominant platoon only	$\rho_{dom} - \rho_{sub}/2$	$1 - \rho_{sub}$
3 - subordinate platoon only	$\rho_{sub}/2$	$1 - \rho_{dom}$
4 - both platoons	$\rho_{sub}/2$	$\rho_{dom} + \rho_{sub} - 1$

EXHIBIT 17-16. PROPORTION OF ANALYSIS PERIOD UNBLOCKED FOR EACH MINOR MOVEMENT (AVERAGE CASE)

Proportion Unblocked for Movement, p_x	Unconstrained Condition	Constrained Condition
p_1	$1 - p_5$	$1 - p_5$
p_4	$1 - p_2$	$1 - p_2$
p_7	$1 - (\rho_{dom} + \rho_{sub}/2)$	0
p_8	$1 - (\rho_{dom} + \rho_{sub}/2)$	0
p_9	$1 - p_2$	$1 - p_2$
p_{10}	$1 - (\rho_{dom} + \rho_{sub}/2)$	0
p_{11}	$1 - (\rho_{dom} + \rho_{sub}/2)$	0
p_{12}	$1 - p_5$	$1 - p_5$

Conflicting Flows During Unblocked Period - Computation 4

The flow for the unblocked period (no platoons) is determined in this step. This flow becomes the conflicting flow for the subject movement and is used to compute the capacity for this movement.

The conflicting flow for movement x during the unblocked period is given by Equation 17-28.

$$v_{c,u,x} = \begin{cases} \frac{v_{c,x} - s(1-p)}{p_x} & \text{if } v_{c,x} > s(1-p_x) \\ 0 & \text{otherwise} \end{cases} \quad (17-28)$$

where

- $v_{c,x}$ = total conflicting flow for movement x as determined from Exhibit 17-4;
- s = saturation flow rate of the major movement, which is the conflicting flow for movement x during the blocked period; and
- p_x = proportion of time that the subject movement x is unblocked by the major-street platoon, which is determined from Exhibit 17-16.

s is average saturation flow rate of Major Movements 2 and 5 while performing single-stage analysis

Capacity During Unblocked Period - Computation 5

The capacity of the subject movement x , accounting for the effect of platooning, is given by Equation 17-29:

$$c_{plat,x} = p_x c_{r,x} \quad (17-29)$$

where

- p_x = proportion of time that movement x is unblocked by a platoon; and
- $c_{r,x}$ = capacity of movement x assuming random flow during the unblocked period, using the conflicting flow, $v_{c,u,x}$, computed for this unblocked period, and Equation 17-3.

Adjust c_{plat} to account for impedance, shared lane and flared approach

Two-Stage Gap Acceptance

In this procedure, the intersection is assumed to consist of two parts, with the minor-street traffic crossing the major street in two phases. Between the partial intersections I and II there is a storage space for m vehicles (see Exhibit 17-17). This area has to be passed by the left-turner from the major street (movement v_1 or v_4) and the minor through or left-turn traffic. It is assumed that the usual rules for TWSC intersections are applied by drivers at the intersections. Thus, the major through traffic has priority over all other movements.

The conflicting flow rates are defined for each minor-stream movement that uses the two-stage gap acceptance process on the basis of Exhibit 17-4 for both the first-stage and the second-stage movements. For the first stage, the conflicting flows consist of the major-street flows from the left. For the second stage, the conflicting flows consist of the major-street flows from the right. The streams included in each conflicting flow are shown in Exhibit 17-4.

The capacity for the subject movement is computed assuming a single-stage gap acceptance process through the entire intersection. Next, the capacities for Stage I, c_I , and Stage II, c_{II} , are computed using the appropriate values of critical gap and follow-up time for the two-stage gap acceptance process from Exhibit 17-5. Note that c_I is the capacity considering conflicting flows v_1 and that c_{II} is the capacity considering conflicting flows v_{II} (see Exhibit 17-4), and that they are determined by using Equation 17-3.

The capacity for the subject movement considering the two-stage gap acceptance process is computed as follows. An adjustment factor a and an intermediate variable y are computed using Equations 17-30 and 17-31.

Adjustment for the two-stage gap acceptance is applicable to Movements 7, 8, 10, and 11

c_I , c_{II} , and $c_{m,x}$ are capacities after being adjusted for upstream signals and impedance
 Use v_1 when considering Movements 7 and 8 and v_4 when considering Movements 10 and 11

$$a = 1 - 0.32e^{-1.3\sqrt{m}} \quad \text{for } m > 0 \quad (17-30)$$

$$y = \frac{c_I - c_{m,x}}{c_{II} - v_L - c_{m,x}} \quad (17-31)$$

where

- m = number of storage spaces in the median;
- c_I = movement capacity for the Stage I process (veh/h);
- c_{II} = movement capacity for the Stage II process (veh/h);
- v_L = major left-turn flow rate, either V_1 or V_4 (veh/h); and
- $c_{m,x}$ = capacity of subject movement considering the total conflicting flow rate for both stages of a two-stage gap acceptance process.

EXHIBIT 17-17. TWO-STAGE GAP ACCEPTANCE INTERSECTION

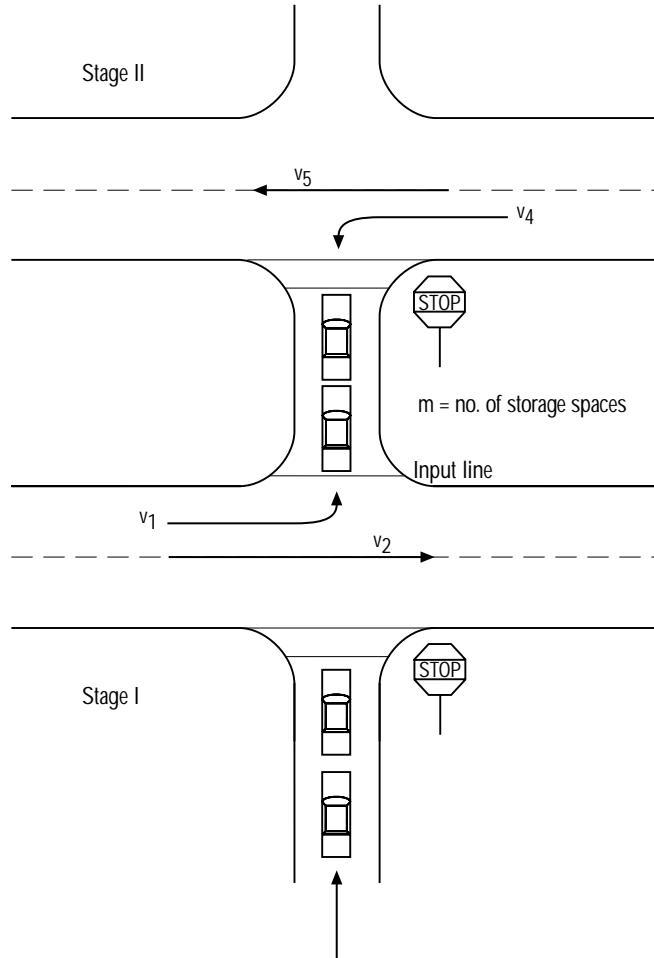

The total capacity, c_T , of the intersection for the subject movement considering the two-stage gap acceptance process is computed using Equations 17-32 and 17-33.

For $y \neq 1$,

$$c_T = \frac{a}{y^{m+1} - 1} \left[y(y^m - 1)(c_{II} - v_L) + (y - 1)c_{m,x} \right] \quad (17-32)$$

For $y = 1$,

$$c_T = \frac{a}{m + 1} \left[m(c_{II} - v_L) + c_{m,x} \right] \quad (17-33)$$

Flared Minor-Street Approaches

If n is defined as the number of spaces for passenger cars belonging to one movement that can queue at the stop line without obstructing other movements, it is clear that with $n > 0$, the capacity of the minor-street approach is increased compared with the shared-lane condition. With an increase in n , the total capacity approaches the ideal case in which each movement has its own infinitely long lane. In the situation shown in Exhibit 17-18, the flared pavement provides space for two vehicles to proceed, one alongside the other. In this case, the storage can be defined as $n = 1$, since one additional vehicle is able to reach the stop line.

EXHIBIT 17-18. CAPACITY OF FLARED APPROACHES

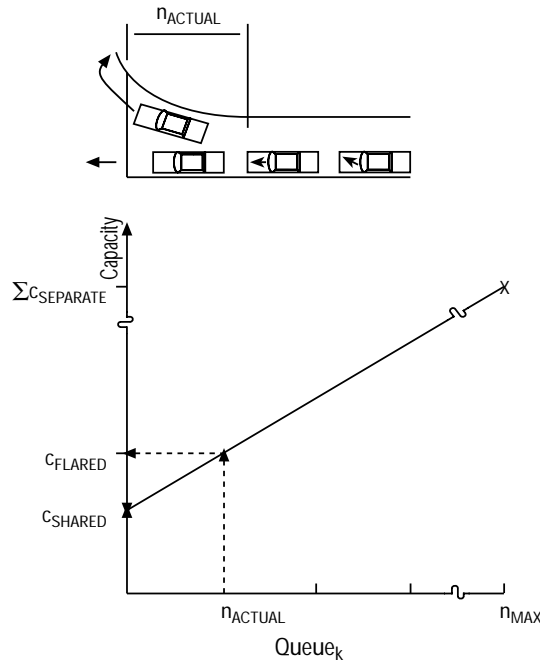

The actual capacity resulting from this configuration will be greater than in the case where the right-turn vehicles must share the lane and less than in the case where the vehicles have separate lanes. The analyst must compute the average queue length for each movement, considering the separate lane case, and consider the actual storage available in the flared-lane area. Exhibit 17-18 shows how the actual capacity can be interpolated using this information.

First, the average queue length for each movement sharing the right lane of the approach is computed by using Equation 17-34, assuming that the right-turn movement operates in one lane and that the other traffic in the right lane (upstream of the flare) operates in another, separate lane.

$$Q_{sep} = \frac{d_{sep} v_{sep}}{3600} \tag{17-34}$$

where

- Q_{sep} = average queue length for the movement considered as a separate lane (veh),
- d_{sep} = control delay for the movement considered as a separate lane (s), and
- v_{sep} = flow rate for the movement (veh/h).

Next, the required length of the storage area such that the approach would operate effectively as separate lanes is computed using Equation 17-35. This is the maximum value of the queue lengths computed for each separate movement plus one vehicle.

$$n_{Max} = \text{Max}_i \text{ round} (Q_{sep,i} + 1) \quad (17-35)$$

where

- $Q_{sep,i}$ = average queue length for movement i considered as a separate lane;
- round = round-off operator, rounding the quantity in parentheses to the nearest integer;
- Max = operator determining the maximum value of the various values of $Q_{sep,i}$; and
- n_{Max} = length of the storage area such that the approach would operate as separate lanes.

Finally, the capacity of the approach is computed, taking into account the flare. The capacity is interpolated as shown in Exhibit 17-18. A straight line is established using values of two points: $(\sum c_{sep}, n_{Max})$ and $(c_{SH}, 0)$. The interpolated value of c_{act} is computed using Equation 17-36.

$$c_{act} = \begin{cases} (\sum_i c_{sep} - c_{SH}) \frac{n}{n_{Max}} + c_{SH} & \text{if } n \leq n_{Max} \\ \sum_i c_{sep} & \text{if } n > n_{Max} \end{cases} \quad (17-36)$$

where

- c_{act} = actual capacity of flared approach (veh/h);
- c_{sep} = capacity of the approach if both lanes were long (veh/h) [this is the capacity of right-turning traffic operating as a separate lane and the capacity of the other traffic in the right lane (upstream of the flare) operating as a separate lane];
- c_{SH} = capacity of the lane when all traffic is in one lane, in which all traffic in the right lane is considered to share one lane (veh/h); and
- n = actual storage area as defined in Exhibit 17-18.

The actual capacity (c_{act}) must be greater than c_{SH} but less than or equal to c_{sep} .

ESTIMATING QUEUE LENGTHS

Estimation of queue length is an important consideration at unsignalized intersections. Theoretical studies and empirical observations have demonstrated that the probability distribution of queue lengths for any minor movement at an unsignalized intersection is a function of the capacity of the movement and the volume of traffic being served during the analysis period. Exhibit 17-19 can be used to estimate the 95th-percentile queue length for any minor movement at an unsignalized intersection during the peak 15-min period on the basis of these two parameters (11).

The mean queue length is computed as the product of the average delay per vehicle and the flow rate for the movement of interest. The expected total delay (vehicle-hours per hour) equals the expected number of vehicles in the average queue; that is, the total hourly delay and the average queue are numerically identical. For example, 4 vehicle-hours/hour of delay can be used interchangeably with an average queue length of four (vehicles) during the hour.

$\sum c_{sep}$ is the sum of the capacities of the right-turning traffic operating as a separate lane and the capacity of the other traffic in the right lane (upstream of the flare) operating in a separate lane

EXHIBIT 17-19. 95TH-PERCENTILE QUEUE LENGTH

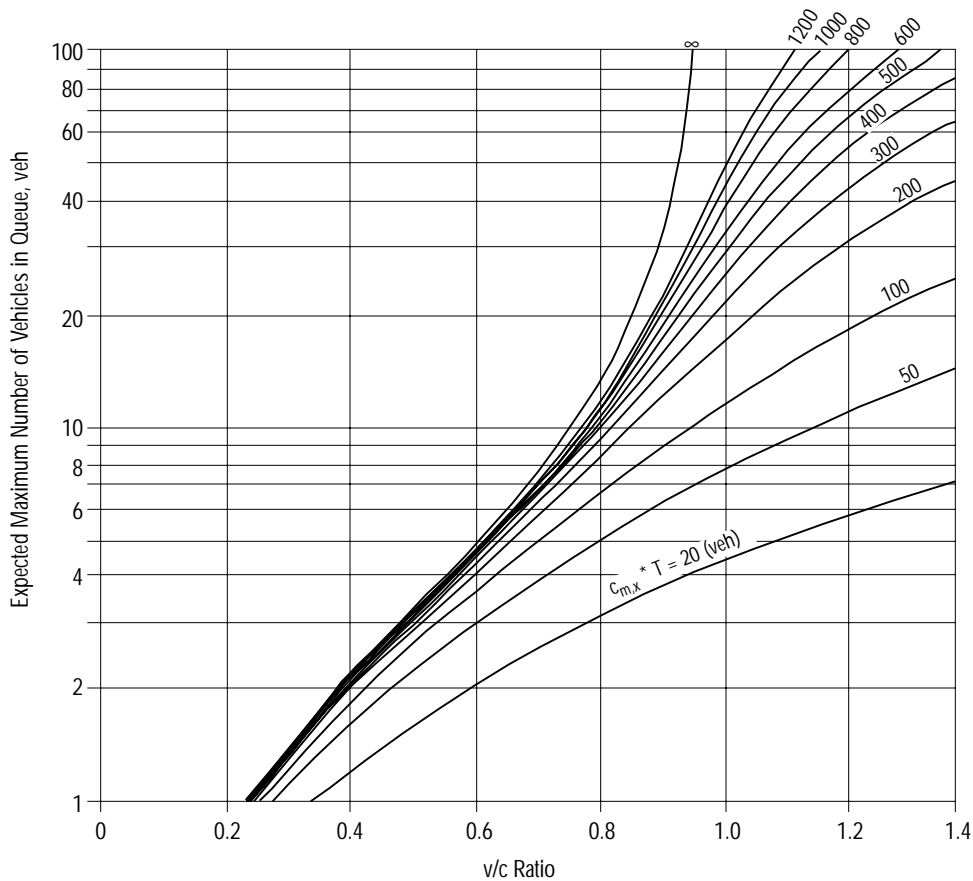

Relationships between expected queue length and the total daily volume exist only when unsaturated systems are analyzed

Equation 17-37 is used to calculate the 95th-percentile queue.

$$Q_{95} \approx 900T \left[\frac{v_x}{c_{m,x}} - 1 + \sqrt{\left(\frac{v_x}{c_{m,x}} - 1\right)^2 + \frac{\left(\frac{3600}{c_{m,x}}\right)\left(\frac{v_x}{c_{m,x}}\right)}{150T}} \right] \left(\frac{c_{m,x}}{3600}\right) \quad (17-37)$$

where

- Q_{95} = 95th-percentile queue (veh),
- v_x = flow rate for movement x (veh/h),
- $c_{m,x}$ = capacity of movement x (veh/h), and
- T = analysis time period (h) ($T = 0.25$ for a 15-min period).

CONTROL DELAY

The delay experienced by a motorist is made up of a number of factors that relate to control, geometrics, traffic, and incidents. Total delay is the difference between the travel time actually experienced and the reference travel time that would result during base conditions, in the absence of incident, control, traffic, or geometric delay. In Chapters 16 and 17 of this manual, only that portion of total delay attributed to control measures, either traffic signals or stop signs, is quantified. This delay is called control delay, and its use is consistent between Chapters 16 and 17. Control delay includes initial deceleration delay, queue move-up time, stopped delay, and final acceleration delay. With respect to

field measurements, control delay is defined as the total elapsed time from the time a vehicle stops at the end of the queue to the time the vehicle departs from the stop line. This total elapsed time includes the time required for the vehicle to travel from the last-in-queue position to the first-in-queue position, including deceleration of vehicles from free-flow speed to the speed of vehicles in queue.

Average control delay for any particular minor movement is a function of the capacity of the approach and the degree of saturation. The analytical model used to estimate control delay (Equation 17-38) assumes that the demand is less than capacity for the period of analysis. If the degree of saturation is greater than about 0.9, average control delay is significantly affected by the length of the analysis period. In most cases, the recommended analysis period is 15 min. If demand exceeds capacity during a 15-min period, the delay results calculated by the procedure may not be accurate. In this case, the period of analysis should be lengthened to include the period of oversaturation.

$$d = \frac{3600}{c_{m,x}} + 900T \left[\frac{v_x}{c_{m,x}} - 1 + \sqrt{\left(\frac{v_x}{c_{m,x}} - 1 \right)^2 + \frac{\left(\frac{3600}{c_{m,x}} \right) \left(\frac{v_x}{c_{m,x}} \right)}{450T}} \right] + 5 \quad (17-38)$$

where

- d = control delay (s/veh),
- v_x = flow rate for movement x (veh/h),
- $c_{m,x}$ = capacity of movement x (veh/h), and
- T = analysis time period (h) ($T = 0.25$ for a 15-min period).

A constant value of 5.0 s is used to reflect delay during deceleration

The constant value of 5 s/veh is included in Equation 17-38 to account for the deceleration of vehicles from free-flow speed to the speed of vehicles in queue and the acceleration of vehicles from the stop line to free-flow speed. This equation is depicted graphically in Exhibit 17-20 for a discrete range of capacities and a 15-min analysis period.

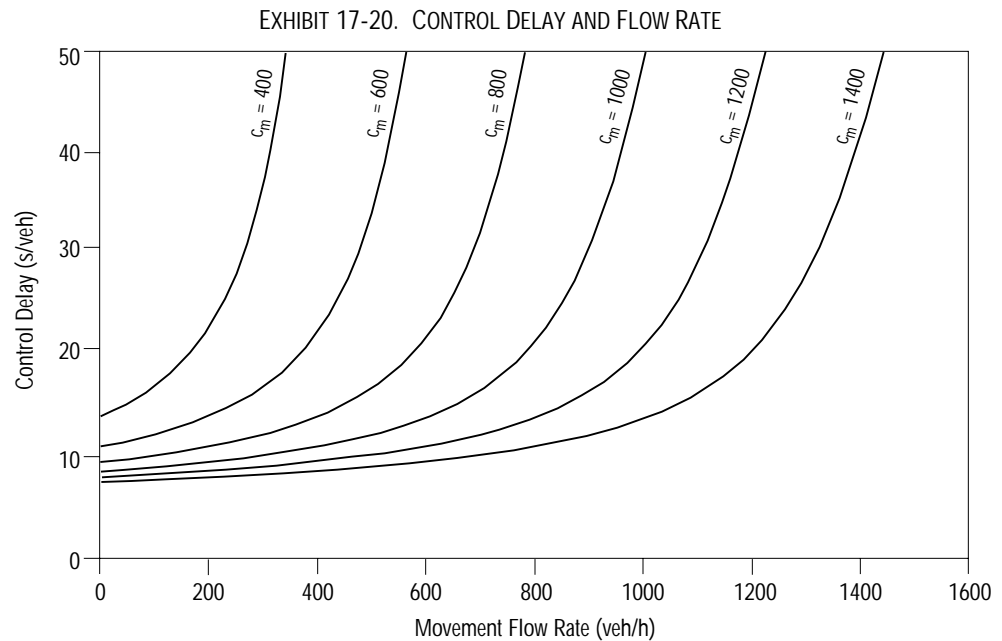

OTHER RELEVANT DELAY ESTIMATES

Delay to Rank 1 Vehicles

The effect of a shared lane on the major-street approach where left-turn vehicles may block Rank 1 through or right-turning vehicles can be significant. If no exclusive left-turn pocket is provided on the major street, a delayed left-turn vehicle may block the Rank 1 vehicles behind it. This will delay not only Rank 1 vehicles but also lower-ranked streams. While the delayed Rank 1 vehicles are discharging from the queue formed behind a left-turning vehicle, they impede lower-ranked movements with which they conflict.

Field observations have shown that such a blockage effect is usually very small, because the major street usually provides enough space for the blocked Rank 1 vehicle to sneak by or bypass the left-turning vehicle. At a minimum, incorporating this effect requires the proportion of Rank 1 vehicles being blocked and the average delay to the major-street left-turning vehicles that are blocking through vehicles.

In the simplest procedure, the proportion of major Rank 1 vehicles not being blocked (i.e., in a queue-free state) is given by $p_{0,j}^*$ in Equation 17-16 ($p_{0,j}^*$ should be substituted for the major left-turn factor $p_{0,j}$ in Equation 17-6 in calculating the capacity of lower-ranked movements that conflict). Therefore, the proportion of Rank 1 vehicles being blocked is $1 - p_{0,j}^*$.

The average delay to Rank 1 vehicles on this approach is computed by Equation 17-39.

$$d_{Rank1} = \begin{cases} \frac{(1 - p_{0,j}^*)d_{M,LT} \left(\frac{v_{i,1}}{N} \right)}{v_{i,1} + v_{i,2}} & N > 1 \\ (1 - p_{0,j}^*)d_{M,LT} & N = 1 \end{cases} \quad (17-39)$$

$\frac{v_{i,1}}{N}$ becomes $\frac{v_{i,2}}{N}$
if $v_{i,1} = 0$

where

- d_{Rank1} = delay to Rank 1 vehicles (s/veh),
- N = number of through lanes per direction on the major street,
- $p_{0,j}^*$ = proportion of Rank 1 vehicles not blocked (Equation 17-16),
- $d_{M,LT}$ = delay to major left-turning vehicles (s/veh),
- $v_{i,1}$ = major-street through vehicles in shared lane (veh/h), and
- $v_{i,2}$ = major-street right-turning vehicles in shared lane (veh/h).

$d_{M,LT}$ is estimated using Equation 17-38

Note that on a multilane road, only the major-street volumes in the lane that may be blocked should be used in the calculation as $v_{i,1}$ and $v_{i,2}$. On multilane roads if it is assumed that blocked Rank 1 vehicles do not bypass the blockage by moving across into other through lanes (a reasonable assumption under conditions of high major-street flows), then $v_{i,1} = v_1/N$. Because of the unique characteristics associated with each site, the decision on whether to account for this effect is left to the analyst.

Intersection and Approach Delay

The control delay for all vehicles on a particular approach can be computed as the weighted average of the control delay estimates for each movement on the approach. Equation 17-40 is used for the computation.

$$d_A = \frac{d_r v_r + d_t v_t + d_l v_l}{v_r + v_t + v_l} \quad (17-40)$$

where

- d_A = control delay on the approach (s/veh);
- d_r, d_t, d_l = computed control delay for the right-turn, through, and left-turn movements, respectively (s/veh); and
- v_r, v_t, v_l = volume or flow rate of right-turn, through, and left-turn traffic on the approach, respectively (veh/h).

Similarly, the intersection control delay can be computed using Equation 17-41:

$$d_I = \frac{d_{A,1}v_{A,1} + d_{A,2}v_{A,2} + d_{A,3}v_{A,3} + d_{A,4}v_{A,4}}{v_{A,1} + v_{A,2} + v_{A,3} + v_{A,4}} \quad (17-41)$$

where

- $d_{A,x}$ = control delay on approach x (s/veh), and
- $v_{A,x}$ = volume or flow rate on approach x (veh/h).

In applying Equations 17-40 and 17-41, the delay for all major-street movements of Rank 1 is assumed to be 0 s/veh.

INTERPRETING RESULTS

Shared Lanes

A movement, most often a left-turn movement, can sometimes have a poorer level of service if it is given a separate lane than if it shares a lane with another movement (usually a through movement). This is not inconsistent in terms of the stated criteria. Left-turn movements will generally experience longer control delays than other movements because of the nature and priority of the movement. If left turns are placed in a shared lane, the control delay for vehicles in that lane may indeed be less than the control delay for left turns in a separate lane. However, if delay for all vehicles is considered, providing separate lanes will result in lower total delay.

Performance Measures

LOS F occurs when there are not enough gaps of suitable size to allow a minor-street demand to safely cross through traffic on the major street. This is typically evident from extremely long control delays experienced by minor-street traffic and by queuing on the minor approaches. The method, however, is based on a constant critical gap size.

LOS F may also appear in the form of drivers on the minor street selecting smaller than usual gaps. In such cases, safety may be a problem, and some disruption to the major traffic stream may result. Note that LOS F may not always result in long queues but in adjustments to normal gap acceptance behavior.

At TWSC intersections the critical movement, often the minor-street left turn, may control the overall performance of the intersection. The lower threshold for LOS F is set at 50 s of delay per vehicle. In some cases, the delay equations will predict delays greater than 50 s for minor-street movements under very low-volume conditions on the minor street (less than 25 veh/h). Note that the LOS F threshold is reached with a movement capacity of approximately 85 veh/h or less.

This analysis procedure assumes random arrivals on the major street. For a typical four-lane major street with average daily traffic volumes in the range of 15,000 to 20,000 vehicles per day (peak hour with 1,500 to 2,000 veh/h), the delay equation will predict greater than 50 s of delay (LOS F) for many urban TWSC intersections that allow minor-street left-turn movements. LOS F will be predicted regardless of the volume of minor-street left-turning traffic. Even with an LOS F estimate, most low-volume minor-street approaches would not meet any of the MUTCD volume or delay warrants for signalization. As a result, analysts who use the HCM LOS thresholds to determine the design adequacy of TWSC intersections should do so with caution.

Some unsignalized intersections estimated to operate at LOS F will not meet MUTCD warrants for signalization

In evaluating the overall performance of TWSC intersections it is important to consider measures of effectiveness in addition to delay, such as v/c ratios for individual movements, average queue lengths, and 95th-percentile queue lengths. By focusing on a single measure of effectiveness for the worst movement only, such as delay for the minor-street left turn, users may make less effective traffic control decisions.

DETERMINING INTERSECTION CONTROL TYPE

Determination of an appropriate control for an intersection, either signal control or a form of stop control, can be accomplished by integrating information from several sources. Traffic signal warrants, LOS analyses, accident data, and public complaints form the basis for a decision to signalize an intersection or to use stop control. Three documents, among others, are available to assist the traffic engineer in this assessment: the MUTCD, the ITE *Traffic Engineering Handbook* (TEH) (12), and the HCM.

The MUTCD provides a set of warrants for determining the appropriate conditions for signalization, two-way stop control, and all-way stop control. The following 11 signal warrants are provided in the MUTCD: minimum vehicular volume, interruption of continuous traffic, minimum pedestrian volume, school crossings, progressive movement, accident experience, systems, combination of warrants, 4-h volumes, peak-hour delay, and peak-hour volume. Although only one of these warrants must be met before a signal is recommended, traffic engineers should ideally consider all these aspects in making a decision concerning an intersection control type. This set of warrants represents guidance based on collective professional consensus accumulated over many decades. Practicing traffic engineers can refer to these warrants whenever issues concerning decisions on intersection control types arise.

The TEH points out that traffic signals do not always increase safety and reduce delay. Therefore, it may also be appropriate to consider all-way stop control. The TEH cites the following warrants for all-way stop control (from the MUTCD):

1. As an interim measure that can be installed quickly while arrangements are being made for a warranted traffic signal;
2. When an accident problem, as indicated by five or more reported accidents in a 12-month period, is of a type that can be corrected using a multiway stop and less restrictive controls have not been successful; and
3. For the following minimum traffic volumes: (a) the total vehicle volume entering the intersection from all approaches averages at least 500 veh/h for any 8 h of an average day, and (b) the combined vehicular and pedestrian volume from minor streets averages at least 200 units/h for the same 8 h with an average delay to minor-street traffic of at least 30 s/veh during the maximum hour [but when the 85th-percentile approach speed of the major-street traffic exceeds 65 km/h, minimum volume warrants are 70 percent of the requirement in (a)].

Concerning traffic signal warrants, the TEH states:

Traffic signals that are appropriately justified, properly designed, and effectively operated can be expected to achieve one or more of the following:

1. To effect orderly traffic movement through an appropriate assignment of right-of-way,
2. To provide for the progressive flow of a platoon of traffic along a given route,
3. To interrupt heavy traffic at intervals to allow pedestrians and cross-street traffic to cross or to enter the main-street flow,
4. To increase the traffic handling ability of an intersection, or
5. To reduce the frequency of occurrence of certain types of accidents.

The analyses available in the HCM may be valuable inputs to the determination of control types. Several sources should be synthesized in arriving at a decision.

Guidelines on required inputs and estimated values are in Chapter 10

Computational sequence is by order of priority of movements

III. APPLICATIONS - PART A

The analysis of TWSC intersections is generally applied to existing locations either to evaluate operational conditions under current traffic demands or to estimate the effects of anticipated demands. The methodology is specifically structured to yield an LOS and an estimate of average control delay for an existing or planned TWSC intersection. Design applications are treated as trial-and-error computations based on anticipated improvements to an existing intersection or on the projected design of a new intersection.

Exhibit 17-21 shows the steps involved in the procedure. The procedure is divided into three modules. In the first module, Initial Calculations, the analyst uses Worksheets 1 through 5 to record input conditions, compute the critical gap and follow-up time, and determine the flow patterns that result from any upstream signalized intersections that may affect the capacity of the subject intersection. The analyst uses Worksheets 6 through 9 from the second module, Capacity Calculations, to compute the capacity of each movement and make adjustments for the effects of two-stage gap acceptance, shared lanes, or flared minor-street approaches. The third module, Delay and LOS Calculations, includes worksheets to compute the delay, queue length, and LOS for each approach.

SEQUENCE OF CAPACITY COMPUTATIONS

Since the methodology is based on prioritized use of gaps by vehicles at a TWSC intersection, it is important that computations be made in a precise order. The computational sequence is the same as the priority of gap use, and movements are considered in the following order:

1. Right turns from the minor street,
2. Left turns from the major street,
3. Through movements from the minor street, and
4. Left turns from the minor street.

COMPUTATIONAL STEPS

Eleven worksheets are included in an appendix. The following steps describe how computations are made and summarized using the worksheets. The procedure is the same for three-leg and four-leg intersections.

Geometrics and Movements (Worksheet 1)

The sketch shows designated movement numbers, v_1 through v_6 denoting major-street movements and v_7 through v_{12} denoting minor-street movements. Lane arrangement, street name, grade, and other pertinent geometric data are entered in the right-hand sketch. General information and site information are entered in appropriate fields.

Volume Adjustments (Worksheet 2)

Measured or forecast volumes (veh/h) for each movement are used to compute hourly flow rates by dividing volume by PHF. Proportion of heavy vehicles (HV) is the percentage of HVs divided by 100 and is used to compute the critical gap and the follow-up time. If pedestrians are present, the percentage of time that they block a lane on an approach (denoted as percent blockage, f_p) is determined using Equation 17-11.

Site Characteristics (Worksheet 3)

Information on lanes and traffic movements is entered. For example, if Movements 1, 2, and 3 all share a single lane and there are no other lanes on the approach, the string 1, 2, 3 would be entered in the Lane 1 column. The grade for each approach and presence of channelized right-turn lanes are noted.

EXHIBIT 17-21. TWSC INTERSECTION METHODOLOGY

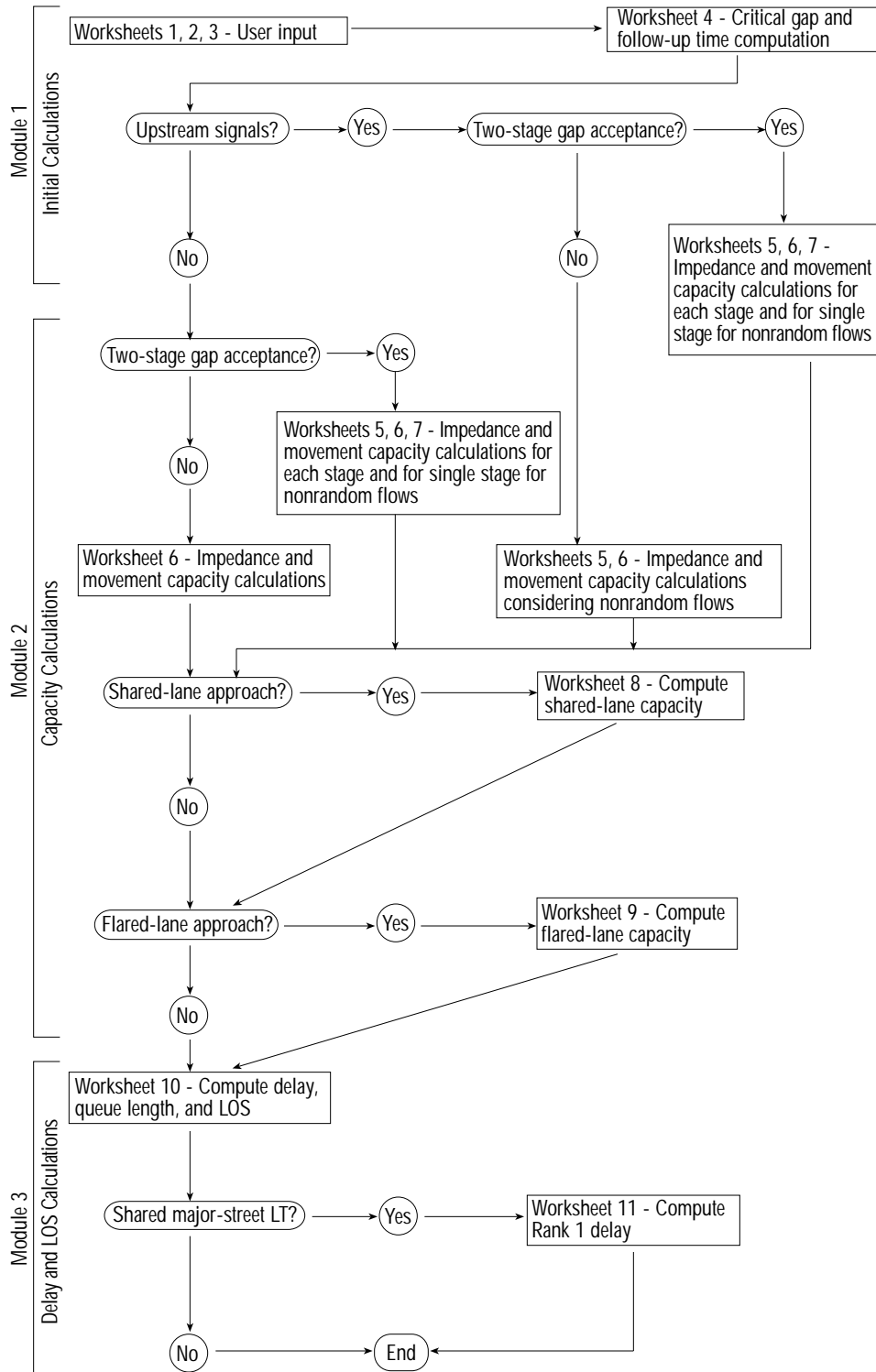

Definitions of m and n are given in corresponding sections in the methodology (see Exhibits 17-17 and 17-18). Median type (raised or TWLTL) will be used to determine the platoon dispersion factor in accounting for the effect of upstream signals. If there is an upstream signalized intersection within 0.4 km of the intersection on the major street,

required data to account for platooning are shown. Note that S_2 denotes a signal upstream of Movement 2 and that S_5 denotes a signal upstream of Movement 5. Saturation flow rate of the travel lanes between the upstream signals and the subject TWSC intersection is noted.

If the analyst needs to compute delay to major-street vehicles resulting from sharing a lane with major-street left-turning vehicles, relevant data are entered in the bottom section of Worksheet 3.

Critical Gap and Follow-Up Time (Worksheet 4)

Exhibit 17-5 and Equations 17-1 and 17-2 are used to compute the critical gap and follow-up time, which is used in Equation 17-1 to determine potential capacities. If two-stage gap acceptance exists, two sets of critical gap are calculated using $t_{c,T}$ values of 0.0 and 1.0, respectively.

Effect of Upstream Signals (Worksheet 5)

Worksheet 5 is used to compute the potential capacities affected by platooning from upstream signalized intersections that are within 0.4 km of the TWSC intersection. The worksheet has five parts, a through e.

Worksheet 5a is used to determine the time required for the queue to clear from the upstream signalized intersection for both the through movement and the protected left-turn movement. For determining the proportion of vehicles arriving on green (Equation 17-17), R_p as a function of the arrival type can be obtained from Chapter 16.

Worksheet 5b is used to determine the proportion of time that the TWSC intersection is blocked by the passing platoon from the upstream signalized intersection. The following points should be noted. Median type from Worksheet 3 and Exhibit 17-13 are used to determine the platoon dispersion factor, α . Unit conversion factors are needed for D and S_{prog} to obtain the travel time, t_a . In computing f ($f = v_{prog}/v_c$), v_c is typically the major-street approach flow rate.

Worksheet 5c is used to determine the platoon event periods and the proportion of time that is unblocked for each minor-stream movement. The dominant and subordinate platoons are computed using Equations 17-24 and 17-25. Equations 17-26 and 17-27 are used to determine whether the condition is unconstrained (there is some time during which no platoons are present) or constrained (one or more platoons are always present). The proportion of time that is unblocked is determined for each minor movement, p_x , using Exhibit 17-16 or equations given for the two-stage gap acceptance process.

Worksheet 5d is used to compute the conflicting flows during the unblocked period for each minor movement. The conflicting flow, $v_{c,x}$, is determined from Exhibit 17-4; s is the saturation flow rate of the major-street through lanes; and values of p_x are from Worksheet 5c. The conflicting flow for movement x during the unblocked period, $v_{c,u,x}$, is computed using Equation 17-28. Similar computations are repeated for the two-stage gap acceptance process if applicable.

Worksheet 5e is used to determine the capacity for the subject movement during the unblocked period. The proportion of time that is unblocked for each minor movement, p_x , is from Worksheet 5c. The capacity for movement x during the unplatooned period (assuming random flow), $c_{r,x}$, is computed using Equation 17-3.

Impedance and Capacity Calculation (Worksheet 6)

The capacity for each movement is computed using Worksheet 6. Some equations are shown on the worksheet. Flow rates are keyed to Worksheets 1 and 2.

Computations proceed in the prescribed order, considering first the right turns from the minor street, followed by left turns from the major street, through movements from the minor street, and left turns from the minor street. The user should solve for all movements before proceeding to the next step. For example, both right turns in Step 1

should be computed before proceeding to Step 2. For a four-leg intersection, use Steps 1, 2, 3, and 4, and for T-intersections, use Steps 1, 2, and 5.

Two-Stage Gap Acceptance (Worksheet 7)

Worksheets 7a and 7b are used in place of Steps 3 and 4 in Worksheet 6 to compute the potential capacity when a two-stage gap acceptance process exists. The sequence of calculations is similar to that described for Worksheet 6, except that there are now three parts, two for the two-stage process and one for the single-stage process. The conflicting flow for the single stage is the sum of those for Stages I and II of the two-stage process. Parameters a and y are computed using Equations 17-30 and 17-31; Equation 17-32 or 17-33 is used to compute the two-stage movement capacity.

Shared-Lane Capacity (Worksheet 8)

Equation 17-15 is used to compute shared-lane capacity on Worksheet 8.

Effect of Flared Minor-Street Approaches (Worksheet 9)

Worksheet 9 is used to compute the effect of minor-street flared approaches. Whereas three columns are provided on the worksheet (for all minor movements), only movements that share the right lane on the subject approach are included in the computation.

Control Delay, Queue Length, Level of Service (Worksheet 10)

Worksheet 10 is used to compute control delay, average queue length, and level of service. Control delay for each movement can be estimated from Exhibit 17-20 or Equation 17-38. The 95th-percentile queue length is determined from Exhibit 17-19 or Equation 17-37. LOS is then determined from Exhibit 17-2.

Delay to Rank 1 Vehicles (Worksheet 11)

Worksheet 11 is used to compute the delay to Rank 1 vehicles using Equation 17-39.

PLANNING AND DESIGN APPLICATIONS

This chapter provides a detailed means of evaluating the performance of a TWSC intersection. An analyst may desire to estimate the LOS for a future time horizon. Typically, only a limited amount of input data are available.

A planning analysis requires geometric and traffic flow data. The base values of critical gap and follow-up time from Exhibit 17-5 are used. The effect of upstream signals, two-stage gap acceptance, and flared right-turn approaches are normally not accounted for in a planning analysis. However, if these data are available, they can be included.

The planning analysis uses the same worksheets as a detailed analysis, with some exceptions as noted below.

- Worksheet 1 is used to describe basic conditions.
- Worksheet 2 is used to summarize the vehicle volumes. Pedestrian volumes are generally not used.
- Worksheet 3 is used to note the lane designation for each movement. Generally, the corrections for flared minor-street approach, median storage, and upstream signals are not included.
- Worksheet 4 is generally not used, since the base values from Exhibit 17-4 are used without adjustment.
- Worksheet 5 is not used, since the effect of upstream signals is generally not included in a planning analysis.
- Worksheet 6 is used to compute the movement capacities.
- Worksheet 7 is used to include the effects of two-stage gap acceptance when there is a divided roadway or TWLTL on the major street.

- Worksheet 8 is used to compute shared-lane capacities, if more than one movement shares the same minor-street approach.
- Worksheet 9 is not used, since the effect of flared minor-street approaches is generally not included.
- Worksheet 10 is not used, since the impedance and delay for the major through movements are not accounted for in a planning analysis.
- Worksheet 11 is used to compute capacity, delay, and LOS.

The detailed analysis procedure described earlier in this chapter is normally not used for design purposes. However, through iteration, the analyst can use a given set of traffic flow data to determine the number of lanes that would be required to produce a given level of service.

PART B. ALL-WAY STOP-CONTROLLED INTERSECTIONS

I. INTRODUCTION - PART B

This section of Chapter 17 presents procedures for analyzing all-way stop-controlled (AWSC) intersections (*I*). A glossary of symbols, including those used for AWSC intersections, is found in Chapter 6.

II. METHODOLOGY - PART B

LEVEL-OF-SERVICE CRITERIA

The level-of-service criteria are given in Exhibit 17-22. The criteria for AWSC intersections have different threshold values than do those for signalized intersections primarily because drivers expect different levels of performance from distinct types of transportation facilities. The expectation is that a signalized intersection is designed to carry higher traffic volumes than an AWSC intersection. Thus a higher level of control delay is acceptable at a signalized intersection for the same LOS.

EXHIBIT 17-22. LEVEL-OF-SERVICE CRITERIA FOR AWSC INTERSECTIONS

Level of Service	Control Delay (s/veh)
A	0–10
B	> 10–15
C	> 15–25
D	> 25–35
E	> 35–50
F	> 50

OVERVIEW OF METHODOLOGY

The methodology analyzes each intersection approach independently. The approach under study is called the subject approach. The opposing approach and the conflicting approaches create conflicts with vehicles on the subject approach.

AWSC intersections require drivers on all approaches to stop before proceeding into the intersection. While giving priority to the driver on the right is a recognized rule in

Background and concepts for AWSC intersections are given in Chapter 10

LOS thresholds for AWSC intersections differ from those for signalized intersections to reflect different driver expectations

some areas, it is not a good descriptor of actual intersection operations. What in fact happens is the development of a consensus of right-of-way that alternates between the drivers on the intersection approaches, a consensus that depends primarily on the intersection geometry and the arrival patterns at the stop line.

A two-phase pattern (Exhibit 17-23) is observed at a standard four-leg AWSC intersection (one approach lane on each leg) where drivers from opposing approaches enter the intersection at roughly the same time. Some interruption of this pattern occurs when there are conflicts between certain turning maneuvers (such as a northbound left-turning vehicle and a southbound through vehicle), but in general the north-south streams alternate right-of-way with the east-west streams. A four-phase pattern (Exhibit 17-23) emerges at multilane four-leg intersections, where the development of the right-of-way consensus is more difficult. Here drivers from each approach enter the intersection together as right-of-way passes from one approach to the next and each is served in turn.

EXHIBIT 17-23. OPERATION PATTERNS AT AWSC INTERSECTIONS

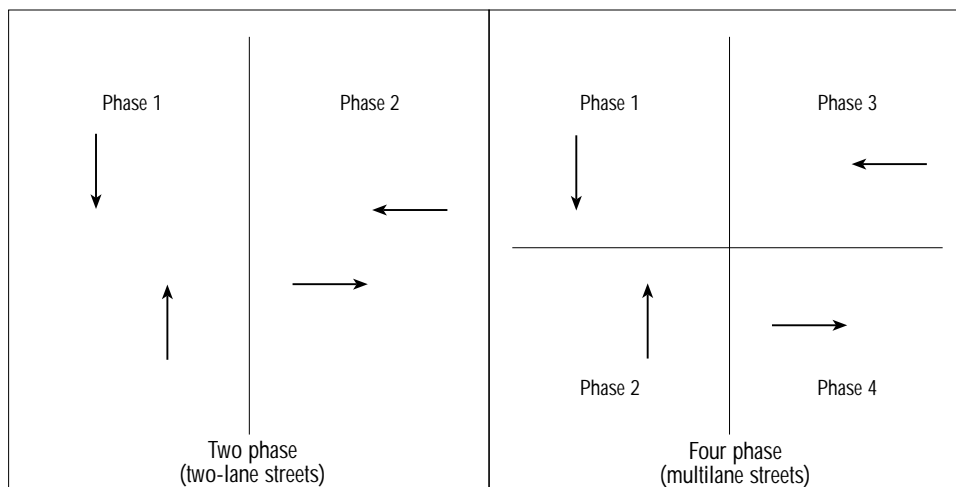

The headways of vehicles departing from the subject approach fall into one of two cases. If there are no vehicles on any of the other approaches, subject approach vehicles can enter the intersection immediately after stopping. However, if there are vehicles waiting on a conflicting approach, a vehicle from the subject approach must wait for consensus with the next conflicting vehicle. The headways between consecutively departing subject approach vehicles will be shorter for the first case than for the second. Thus, the headway for a departing subject approach vehicle depends on the degree of conflict experienced with vehicles on the other intersection approaches. The degree of conflict increases with two factors: the number of vehicles on the other approaches and the complexity of the intersection geometry.

Two other factors affect the departure headway of a subject approach vehicle: vehicle type and turning movement. The headway for a heavy vehicle will be longer than for a passenger car. Furthermore, the headway for a left-turning vehicle will be longer than for a through vehicle, which in turn will be longer than for a right-turning vehicle.

In summary:

1. AWSC intersections operate in either two-phase or four-phase patterns, based primarily on the complexity of the intersection geometry. Flows are determined by a consensus of right-of-way that alternates between the north-south and east-west streams (for a single-lane approach) or proceeds in turn to each intersection approach (for a multilane approach).
2. The headways between consecutively departing subject approach vehicles depend on the degree of conflict between these vehicles and the vehicles on the other

Two cases for departure headways

Capacity defined

intersection approaches. The degree of conflict is a function of the number of vehicles faced by the subject approach vehicle and of the number of lanes on the intersection approaches.

3. The headway of a subject approach vehicle also depends on its vehicle type and its turning maneuver.

CAPACITY MODEL

Capacity is defined as the maximum throughput on an approach given the flow rates on the other intersection approaches. The capacity model described here is an expansion of earlier work (2). The model is described for four increasingly complex cases: the intersection of two one-way streets, the intersection of two two-way streets, a generalized model for single-lane sites, and a generalized model for multilane sites.

Intersection of Two One-Way Streets

The first formulation of the model is based on the intersection of two one-way streets, each stop-controlled. Vehicles on either approach travel only straight through the intersection. See Exhibit 17-24.

EXHIBIT 17-24. AWSC CONFIGURATION - FORMULATION 1

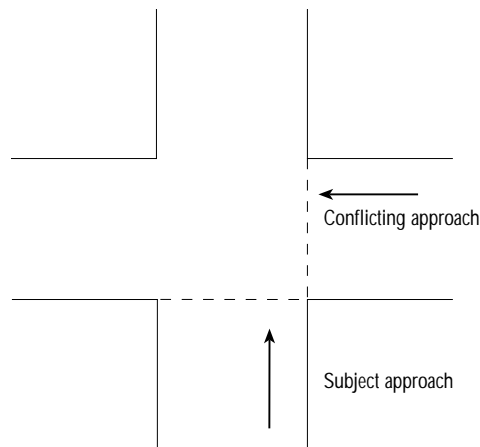

The service time for a vehicle assumes one of two values: s_1 is the service time if no vehicle is waiting on the conflicting approach and s_2 is the service time if a vehicle is waiting on the conflicting approach. The mean service time for vehicles on an approach is the expected value of this bivalued distribution. For the northbound approach, the mean service time is computed by Equation 17-42:

$$s_N = s_1 (1 - x_W) + s_2 x_W \tag{17-42}$$

where x_w is the degree of utilization of the westbound approach and is equal to the probability of finding at least one vehicle on that approach. Thus $1 - x_w$ is the probability of finding no vehicle on the westbound approach.

By symmetry, the mean service time for the westbound approach is given by Equation 17-43.

$$s_W = s_1 (1 - x_N) + s_2 x_N \tag{17-43}$$

Since the degree of utilization x is the product of the arrival rate λ and the mean service time s , the service times for each approach can be expressed in terms of the bivalued service times and the arrival rates on each approach, as in Equations 17-44 and 17-45.

$$s_N = \frac{s_1 [1 + \lambda_W (s_2 - s_1)]}{1 - \lambda_N * \lambda_W * (s_2 - s_1)^2} \tag{17-44}$$

$$s_W = \frac{s_1 [1 + \lambda_N (s_2 - s_1)]}{1 - \lambda_N * \lambda_W * (s_2 - s_1)^2} \tag{17-45}$$

Intersection of Two Two-Way Streets

The service time for a vehicle assumes one of two values, s_1 or s_2 . The mean service time for vehicles on an approach is the expected value of this bivalued distribution. A northbound vehicle will have a service time of s_1 if the eastbound and westbound approaches are empty simultaneously. The probability of this event is the product of the probability of an empty westbound approach and the probability of an empty eastbound approach. The mean service time for the northbound vehicle is computed using Equation 17-46. See Exhibit 17-25.

$$s_N = s_1(1 - x_E)(1 - x_W) + s_2[1 - (1 - x_E)(1 - x_W)] \tag{17-46}$$

Unlike Formulation 1, it is not possible to solve directly for the mean service time in terms of a combination of arrival rates and the bivalued service times. The service time on any approach is dependent on or directly coupled with the traffic intensity on the two conflicting approaches. This coupling prevents a direct solution. However, it is possible to solve for the service time on each approach in an iterative manner on the basis of a system of equations of the form shown in Equation 17-46.

EXHIBIT 17-25. AWSC CONFIGURATION - FORMULATION 2

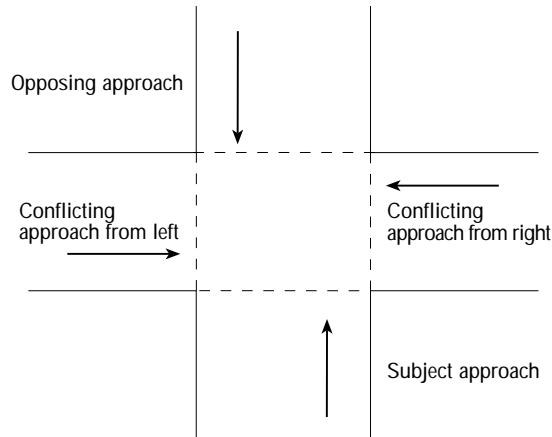

Generalized Model for Single-Lane Sites

The generalized model is based on five saturation headway values, each reflecting a different level or degree of conflict faced by the subject approach driver. Exhibit 17-26 specifies the conditions for each case and the probability of occurrence of each. The probability of occurrence is based on the degree of utilization on the opposing and conflicting approaches. The essence of the model, and its complexity, is evident when one realizes that the traffic intensity on one approach is computed from its capacity, which in turn depends on the traffic intensity on the other approaches. The interdependence of the traffic flow on all intersection approaches creates the need for iterative calculations to obtain stable estimates of departure headway and service time, and thus capacity.

Capacity is determined by an iterative procedure

EXHIBIT 17-26. PROBABILITY OF DEGREE-OF-CONFLICT CASE

Degree-of-Conflict Case	Approach				Probability of Occurrence
	Sub	Opp	Con-L	Con-R	
1	Y	N	N	N	$(1-x_o)(1-x_{CL})(1-x_{CR})$
2	Y	Y	N	N	$(x_o)(1-x_{CL})(1-x_{CR})$
3	Y	N	Y	N	$(1-x_o)(x_{CL})(1-x_{CR})$
3	Y	N	N	Y	$(1-x_o)(1-x_{CL})(x_{CR})$
4	Y	Y	N	Y	$(x_o)(1-x_{CL})(x_{CR})$
4	Y	Y	Y	N	$(x_o)(x_{CL})(1-x_{CR})$
4	Y	N	Y	Y	$(1-x_o)(x_{CL})(x_{CR})$
5	Y	Y	Y	Y	$(x_o)(x_{CL})(x_{CR})$

Note: Sub is the subject approach. Opp is the opposing approach. Con-L is the conflicting approach from the left. Con-R is the conflicting approach from the right.

From Exhibit 17-26, the probability, $P(C_i)$, for each degree-of-conflict case can be computed using Equations 17-47 through 17-51. The degrees of utilization on the opposing approach, the conflicting approach from the left, and the conflicting approach from the right are given by x_o , x_{CL} , and x_{CR} , respectively.

$$P(C_1) = (1 - x_o)(1 - x_{CL})(1 - x_{CR}) \tag{17-47}$$

$$P(C_2) = (x_o)(1 - x_{CL})(1 - x_{CR}) \tag{17-48}$$

$$P(C_3) = (1 - x_o)(x_{CL})(1 - x_{CR}) + (1 - x_o)(1 - x_{CL})(x_{CR}) \tag{17-49}$$

$$P(C_4) = (x_o)(1 - x_{CL})(x_{CR}) + (x_o)(x_{CL})(1 - x_{CR}) + (1 - x_o)(x_{CL})(x_{CR}) \tag{17-50}$$

$$P(C_5) = (x_o)(x_{CL})(x_{CR}) \tag{17-51}$$

The departure headway for an approach is the expected value of the saturation headway distribution, computed by Equation 17-52.

$$h_d = \sum_{i=1}^5 P(C_i) h_{si} \tag{17-52}$$

where $P(C_i)$ is the probability of the degree-of-conflict case C_i and h_{si} is the saturation headway for that case, given the traffic stream and geometric conditions of the intersection approach.

The service time required for the calculation of delay is computed (using Equation 17-53) on the basis of the departure headway and the move-up time.

$$t_s = h_d - m \tag{17-53}$$

where t_s is the service time, h_d is the departure headway, and m is the move-up time.

The capacity is computed as follows. The volume on the subject approach is increased incrementally until the degree of utilization on any one approach exceeds 1.0. This flow rate is the maximum possible flow or throughput on the subject approach under the conditions used as input to the analysis.

Generalized Model for Multilane Sites

Saturation headways at multilane sites will probably be longer than at single-lane sites, all other conditions being equal. This is the result of two factors. A larger intersection geometry (i.e., greater number of lanes) requires more travel time through the intersection, thus increasing the saturation headway. Additional lanes also mean an increasing degree of conflict with opposing and conflicting vehicles, again increasing driver decision time and the saturation headway.

Volume is increased until $X > 1.0$

By contrast, some movements may not as readily conflict with each other at multilane sites as at single-lane sites. For example, a northbound vehicle turning right may be able to depart simultaneously with an eastbound through movement if the two vehicles are able to occupy separate receiving lanes when departing to the east. This means that in some cases the saturation headway may be lower at multilane sites.

In the theory described earlier, it was proposed that the saturation headway is a function of the directional movement of the vehicle, the vehicle type, and the degree of conflict faced by the subject vehicle. This theory is extended here for multilane sites with respect to the concept of degree of conflict: saturation headway is affected to a large extent by the number of opposing and conflicting vehicles faced by the subject driver. For example, in Degree-of-Conflict Case 2, a subject vehicle is faced only by a vehicle on the opposing approach. At a two-lane approach intersection, there can be either one or two vehicles on the opposing approach. Each degree-of-conflict case is expanded to consider the number of vehicles present on each of the opposing and conflicting approaches. The cases are defined in Exhibits 17-27 and 17-28 for two-lane and three-lane approaches, respectively.

EXHIBIT 17-27. DEGREE-OF-CONFLICT CASES FOR TWO-LANE APPROACH INTERSECTIONS

Degree-of-Conflict Case	Approaches with Vehicles			Number of Opposing and Conflicting Vehicles
	Opposing	Conflicting Left	Conflicting Right	
1				0
2	x			1, 2
3		x		1, 2
4	x	x		2, 3, 4
	x		x	
		x	x	
5	x	x	x	3, 4, 5, 6

EXHIBIT 17-28. DEGREE-OF-CONFLICT CASES FOR THREE-LANE APPROACH INTERSECTIONS

Degree-of-Conflict Case	Approaches with Vehicles			Number of Opposing and Conflicting Vehicles
	Opposing	Conflicting Left	Conflicting Right	
1				0
2	x			1, 2, 3
3		x		1, 2, 3
			x	
4	x	x		2, 3, 4, 5, 6
	x		x	
		x	x	
5	x	x	x	3, 4, 5, 6, 7, 8, 9

For multilane sites, separate saturation headway values have been computed for the number of vehicles faced by the subject vehicle for each degree-of-conflict case. This requires a further extension of the service time model to account for the increased number of subcases.

Exhibit 17-29 gives the 27 possible combinations of the number of vehicles on each approach for each degree-of-conflict case for intersections with two lanes on each approach.

EXHIBIT 17-29. PROBABILITY OF DEGREE-OF-CONFLICT CASE—MULTILANE AWSC INTERSECTIONS (TWO-LANE APPROACH)

DOC Case/Vehicles	Number of Vehicles on Approach			
	Subject Approach	Opposing Approach	Conflicting Left Approach	Conflicting Right Approach
1/0	1	0	0	0
2/1	1	1	0	0
2/2	1	2	0	0
3/1	1	0	1	0
	1	0	0	1
3/2	1	0	2	0
	1	0	0	2
4/2	1	1	0	1
	1	1	1	0
	1	0	1	1
4/3	1	2	1	0
	1	1	2	0
	1	0	1	2
	1	0	2	1
	1	2	0	1
4/4	1	2	2	0
	1	2	0	2
	1	0	2	2
5/3	1	1	1	1
5/4	1	1	2	1
	1	2	1	1
	1	1	1	2
5/5	1	2	2	1
	1	2	1	2
	1	1	2	2
5/6	1	2	2	2

Note: DOC Case/Vehicles is the degree-of-conflict case and the number of vehicles on the opposing and conflicting approaches.

These combinations can be further subdivided if a vehicle can be on either one of the lanes on a given approach. Exhibit 17-30 gives the 64 possible combinations when alternative lane occupancies are considered; a 1 indicates that a vehicle is in the lane, and a 0 indicates that a vehicle is not in the lane. Similarly, possible combinations can be developed for intersections with three lanes on each approach.

The probability of a vehicle being at the stop line in a given lane is x , the degree of utilization. The product of the six degrees of saturation (encompassing each of the six lanes on the opposing or conflicting approaches) gives the probability of any particular combination occurring.

The departure headway of the approach is the expected value of the saturation headway distribution, given by Equation 17-54.

$$h_d = \sum_{i=1}^{64} P'(i)h_{si} \tag{17-54}$$

where i represents each combination of the five degree-of-conflict cases and h_{si} is the saturation headway for that combination.

The iterative procedure to compute the departure headways and capacities for each approach as a function of the departure headways on the other approaches is the same as described earlier. The additional subcases clearly increase the complexity of this computation, however.

EXHIBIT 17-30. PROBABILITY OF DEGREE-OF-CONFLICT CASE–MULTILANE AWSC INTERSECTIONS
(TWO-LANE APPROACHES, BY LANE)

i	DOC Case/Vehicles	Opposing Approach		Conflicting Left Approach		Conflicting Right Approach	
		L1	L2	L1	L2	L1	L2
1	1/0	0	0	0	0	0	0
2	2/1	1	0	0	0	0	0
3		0	1	0	0	0	0
4	2/2	1	1	0	0	0	0
5	3/1	0	0	0	1	0	0
6		0	0	1	0	0	0
7		0	0	0	0	1	0
8		0	0	0	0	0	1
9	3/2	0	0	1	1	0	0
10		0	0	0	0	1	1
11	4/2	0	0	0	1	0	1
12		0	0	1	0	0	1
13		0	0	1	0	1	0
14		0	0	0	1	1	0
15		0	1	0	1	0	0
16		1	0	1	0	0	0
17		0	1	0	0	1	0
18		1	0	0	1	0	0
19		0	1	1	0	0	0
20		0	1	0	0	0	1
21		1	0	0	0	1	0
22		1	0	0	0	0	1
23	4/3	0	0	0	1	1	1
24		0	0	1	1	0	1
25		0	0	1	1	1	0
26		1	0	1	1	0	0
27		1	1	1	0	0	0
28		1	1	0	0	1	0
29		1	1	0	0	0	1
30		0	1	1	1	0	0
31		1	0	0	0	1	1
32		0	0	1	0	1	1
33		1	1	0	1	0	0
34		0	1	0	0	1	1
35	4/4	1	1	0	0	1	1
36		0	0	1	1	1	1
37		1	1	1	1	0	0
38	5/3	0	1	0	1	0	1
39		1	0	0	1	1	0
40		0	1	1	0	1	0
41		0	1	0	1	1	0
42		0	1	1	0	0	1
43		1	0	1	0	0	1
44		1	0	0	1	0	1
45		1	0	1	0	1	0

Exhibit 17-30 continues on next page

EXHIBIT 17-30 (CONTINUED). PROBABILITY OF DEGREE-OF-CONFLICT CASE—MULTILANE AWSC INTERSECTIONS (TWO-LANE APPROACHES, BY LANE)

i	DOC Case/Vehicles	Opposing Approach		Conflicting Left Approach		Conflicting Right Approach		
		L1	L2	L1	L2	L1	L2	
46	5/4	1	0	0	1	1	1	
47		0	1	1	1	1	0	
48		0	1	1	1	0	1	
49		1	0	1	0	1	1	
50		1	0	1	1	1	0	
51		0	1	0	1	1	1	
52		1	1	1	0	0	1	
53		1	0	1	1	0	1	
54		0	1	1	0	1	1	
55		1	1	0	1	1	0	
56		1	1	0	1	0	1	
57		1	1	1	1	0	1	0
58		5/5	1	0	1	1	1	1
59			1	1	0	1	1	1
60	1		1	1	0	1	1	
61	0		1	1	1	1	1	
62	1		1	1	1	1	0	
63	1		1	1	1	1	0	1
64	5/6	1	1	1	1	1	1	

Notes:
 DOC Case/Vehicles is the degree-of-conflict case and the number of vehicles on the opposing and conflicting approaches.
 L1 is Lane 1, and L2 is Lane 2.

CONTROL DELAY

The delay experienced by a motorist is made up of a number of factors that relate to control, geometrics, traffic, and incidents. Total delay is the difference between the travel time actually experienced and the reference travel time that would result during base conditions, in the absence of incident, control, traffic, or geometric delay. Equation 17-55 can be used to compute delay.

$$d = t_s + 900T \left[(x - 1) + \sqrt{(x - 1)^2 + \frac{h_d x}{450T}} \right] + 5 \tag{17-55}$$

where

- d = average control delay (s/veh),
- x = degree of utilization ($v h_d / 3600$),
- t_s = service time (s),
- h_d = departure headway (s), and
- T = length of analysis period (h).

III. APPLICATIONS - PART B

The methodology is applied through a set of five worksheets. They relate to input data, saturation headways, departure headways and service time, and capacity and level of service.

Exhibit 17-31 shows the analysis steps and identifies the worksheets used. The worksheets themselves are found at the end of this chapter.

Guidelines on required inputs and estimated values are given in Chapter 10

EXHIBIT 17-31. AWSC INTERSECTION METHODOLOGY

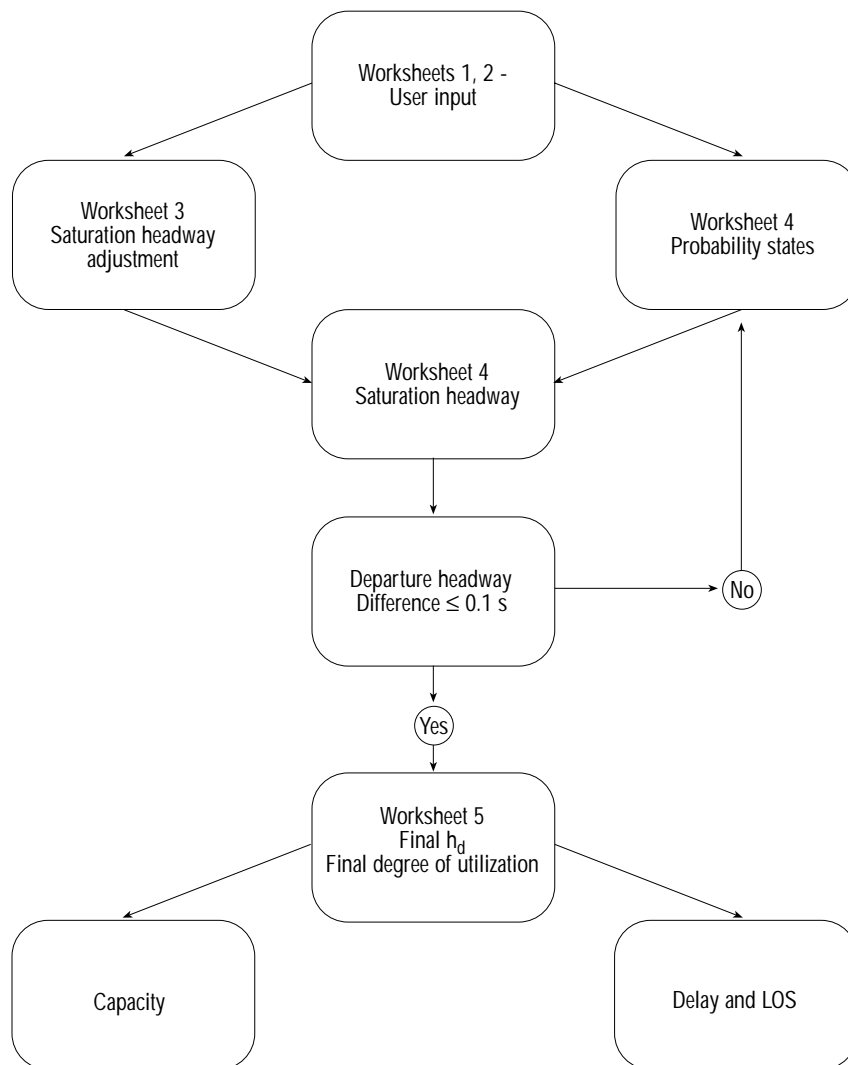

COMPUTATIONAL STEPS

Geometrics and Movements (Worksheet 1)

Worksheet 1 shows the basic features of the intersection and the movements of interest. The intersection name, the analyst's name, the count date, and the time period are entered on this form. The north orientation arrow is also entered.

Volume Adjustments and Lane Assignments (Worksheet 2)

Movement volumes are entered into the upper tier of Worksheet 2 and adjusted for peaking by dividing volume by PHF to obtain hourly flow rates. The percentage of heavy vehicles is used to compute the headway adjustment factor in Worksheet 3. Flow rates for each lane by movement are entered into the lower tier of Worksheet 2. If more than one lane is available to a certain movement and its traffic volume distribution per lane is unknown, an equal distribution of volume among the lanes can be assumed. Exhibit 17-32 is consulted to determine the geometry group for each approach.

The geometry group is needed to look up base saturation headways and headway adjustment factors.

EXHIBIT 17-32. GEOMETRY GROUPS

Geometry Group	Intersection Configuration	Number of Lanes		
		Subject Approach	Opposing Approach	Conflicting Approaches
1	4 leg or T	1	1	1
2	4 leg or T	1	1	2
3a/4a	4 leg or T	1	2	1
3b	T	1	2	2
4b	4 leg	1	2	2
5	4 leg or T	2	1 or 2	1 or 2
5	4 leg or T	3	1 ^a	1 ^a
6	4 leg or T	3	3	3

Note:

a. If the number of lanes on the subject approach is 3 and the number of lanes on either the opposing or conflicting approaches is 1, the geometry group is 5. Otherwise, if the number of lanes on the subject approach is 3, the geometry group is 6.

Saturation Headways (Worksheet 3)

Saturation headway adjustments for left turns, right turns, and heavy vehicles are given in Exhibit 17-33. The headway adjustment for each lane is computed by Equation 17-56.

$$h_{adj} = h_{LT-adj} P_{LT} + h_{RT-adj} P_{RT} + h_{HV-adj} P_{HV} \tag{17-56}$$

where

- h_{adj} = headway adjustment,
- h_{LT-adj} = headway adjustment for left turns,
- h_{RT-adj} = headway adjustment for right turns (either -0.6 or -0.7),
- h_{HV-adj} = headway adjustment for heavy vehicles,
- P_{LT} = proportion of left-turning vehicles on the approach,
- P_{RT} = proportion of right-turning vehicles on the approach, and
- P_{HV} = proportion of heavy vehicles on the approach.

EXHIBIT 17-33. SATURATION HEADWAY ADJUSTMENTS BY GEOMETRY GROUP

Factors	Saturation Headway Adjustment (s)							
	Group 1	Group 2	Group 3a	Group 3b	Group 4a	Group 4b	Group 5	Group 6
LT	0.2	0.2	0.2	0.2	0.2	0.2	0.5	0.5
RT	-0.6	-0.6	-0.6	-0.6	-0.6	-0.6	-0.7	-0.7
HV	1.7	1.7	1.7	1.7	1.7	1.7	1.7	1.7

Departure Headway and Service Time (Worksheet 4)

Worksheet 4a

With the lane flow rates from Worksheet 2 and the initial departure headway of 3.2 s, the initial degree of utilization, x , is computed using Equation 17-57.

$$x = \frac{v h_d}{3600} \tag{17-57}$$

Calculations of h_d , with the assistance of Worksheet 4b, are repeated until the values of departure headway for each lane change by less than 0.1 s from the previous iteration. Computation of h_d for each lane and each iteration utilizes Worksheet 4b and follows the four steps described below.

Worksheet 4b

Step 1. Computation of probability states. The probability state of each combination i is determined using Equation 17-58.

Note that if it is not the final iteration and the degree of utilization exceeds 1, then the degree of utilization is reset to 1.

$$P(i) = \prod_j P(a_j) \tag{17-58}$$

where

- j = O1 (opposing approach, Lane 1), O2 (opposing approach, Lane 2), CL1 (conflicting left approach, Lane 1), CL2 (conflicting left, Lane 2), CR1 (conflicting right, Lane 1), and CR2 (conflicting right, Lane 2) for a two-lane two-way AWSC intersection;
- a_j = 1 (indicating a vehicle present) or 0 (indicating no vehicle present in the lane) (values of a_j for each lane in each combination i are listed in Exhibit 17-30); and
- $P(a_j)$ = probability of a_j , computed on the basis of Exhibit 17-34, in which V_j is the lane flow rate.

EXHIBIT 17-34. PROBABILITY OF a_j

a_j	V_j	$P(a_j)$
1	0	0
0	0	1
1	> 0	x_j^a
0	> 0	$1 - x_j^a$

Note:

a. x is the degree of utilization defined in Equation 17-57.

Step 2. Probability adjustment factor. The probability adjustment is computed, using Equations 17-59 through 17-63, to account for the serial correlation in the previous probability computation. First, the probability of each degree-of-conflict case must be determined.

$$P(C_1) = P(1) \tag{17-59}$$

$$P(C_2) = \sum_{i=2}^4 P(i) \tag{17-60}$$

$$P(C_3) = \sum_{i=5}^{10} P(i) \tag{17-61}$$

$$P(C_4) = \sum_{i=11}^{37} P(i) \tag{17-62}$$

$$P(C_5) = \sum_{i=38}^{64} P(i) \tag{17-63}$$

The probability adjustment factors are then computed using Equations 17-64 through 17-68.

$$AdjP(1) = \alpha[P(C_2) + 2P(C_3) + 3P(C_4) + 4P(C_5)]/1 \tag{17-64}$$

$$AdjP(2) \text{ through } AdjP(4) = \alpha[P(C_3) + 2P(C_4) + 3P(C_5) - P(C_2)]/3 \tag{17-65}$$

$$AdjP(5) \text{ through } AdjP(10) = \alpha[P(C_4) + 2P(C_5) - 3P(C_3)]/6 \tag{17-66}$$

$$AdjP(11) \text{ through } AdjP(37) = \alpha[P(C_5) - 6P(C_4)]/27 \tag{17-67}$$

$$AdjP(38) \text{ through } AdjP(64) = -\alpha[10P(C_5)]/27 \tag{17-68}$$

where α equals 0.01 (or 0.00 if correlation among saturation headways is not taken into account).

The adjusted probability $P'(i)$ for each combination is simply the sum of $P(i)$ and $AdjP(i)$, as given by Equation 17-69.

$$P'(i) = P(i) + \text{Adj}P(i) \quad (17-69)$$

Step 3. Saturation headway. The saturation headway h_{si} is the sum of the base saturation headway as given in Exhibit 17-35 and the saturation headway adjustment factor from Worksheet 3. Note that all values in the h_{adj} column should be the same because one Worksheet 4b is used for each lane.

Step 4. Departure headway. Departure headway is computed using Equation 17-54.

EXHIBIT 17-35. SATURATION HEADWAY VALUES BY CASE AND GEOMETRY GROUP

Case	No. of Veh	Base Saturation Headway (s)							
		Group 1	Group 2	Group 3a	Group 3b	Group 4a	Group 4b	Group 5	Group 6
1	0	3.9	3.9	4.0	4.3	4.0	4.5	4.5	4.5
2	1	4.7	4.7	4.8	5.1	4.8	5.3	5.0	6.0
	2							6.2	6.8
	≥ 3							7.4	7.4
3	1	5.8	5.8	5.9	6.2	5.9	6.4	6.4	6.6
	2							7.2	7.3
	≥ 3							7.8	7.8
4	2	7.0	7.0	7.1	7.4	7.1	7.6	7.6	8.1
	3							7.8	8.7
	4							9.0	9.6
	≥ 5							12.3	12.3
5	3	9.6	9.6	9.7	10.0	9.7	10.2	9.7	10.0
	4							9.7	11.1
	5							10.0	11.4
	≥ 6							11.5	13.3

Capacity and Level of Service (Worksheet 5)

Worksheet 5 is used to determine delay and LOS. Control delay per vehicle is computed for each lane and each approach using Equation 17-55. The approach delay is the weighted average of the delay on each lane, and the intersection delay is the weighted average of the delay on each of the approaches. The LOS for each approach and for the intersection is determined using Exhibit 17-22 and the computed values of control delay.

The capacity of each approach is computed under the assumption that the flows on the opposing and conflicting approaches are constant. The given flow rate on the subject lane is increased and the departure headways are computed for each approach using Worksheets 4a and 4b until the degree of utilization for the subject lane reaches 1. When this occurs, the final value of the subject approach flow rate is the maximum possible throughput or capacity of this lane. Note that the move-up time for the lane is either 2.0 s (for Geometry Groups 1 through 4) or 2.3 s (for Geometry Groups 5 and 6).

PLANNING AND DESIGN APPLICATIONS

The operational analysis method described earlier in this chapter provides a detailed procedure for evaluating the performance of an AWSC intersection. To estimate LOS for a future time horizon, a planning analysis based on the operational method is used. The planning method uses all the geometric and traffic flow data required for an operational analysis, and the computations are identical. However, many input variables are estimated (or defaults used) when planning applications are performed.

The operational analysis described earlier in this chapter is not normally used for design purposes. However, through iteration the analyst can use a given set of traffic flow data and determine the number of lanes that would be required to produce a given level of service.

Capacity is estimated for a stated set of opposing and conflicting volumes

PART C. ROUNDABOUTS

I. INTRODUCTION - PART C

In this section of Chapter 17, procedures for the analysis of roundabouts are presented. Terminology applying to the unique characteristics of roundabout capacity is introduced. For ease of reference, the following terms are defined:

- c_a = approach capacity,
- v_a = approach flow rate, and
- v_c = circulating flow rate.

Roundabouts have been used successfully in cities throughout the world and are being used increasingly in the United States. Although extensive literature on roundabout modeling has evolved worldwide, there is limited experience with their application in North America. Accordingly, a comprehensive methodology for all situations cannot be offered. The procedure described in this section makes the best use of the limited field data collected at roundabouts in the United States to modify the operating parameters of established performance analysis techniques. Whereas it should be used with care until additional research is conducted, the procedure does provide the U.S. practitioner with basic guidelines concerning the capacity of a roundabout.

Intersection analysis models generally fall into two categories. Empirical models rely on field data to develop relationships between geometric design features and performance measures such as capacity and delay. Analytical models are based on the concept of gap acceptance theory. The choice of an analysis approach depends on the calibration data available. Empirical models are generally better but require a number of congested roundabouts for calibration. Gap acceptance models, however, can be developed from uncongested roundabouts (1). A gap acceptance approach for analyzing roundabouts is presented here.

II. METHODOLOGY - PART C

OVERVIEW OF METHODOLOGY

The capacity at a roundabout can be estimated using gap acceptance techniques with the basic parameters of critical gap and follow-up time.

It has generally been assumed that the performance of each leg of a roundabout can be analyzed independently of the other legs, and consequently most techniques tend to use information on only one leg (2, 3). Exhibit 17-36 shows the traffic flows being considered.

It has also been shown (4) that the origin-destination paths at roundabouts affect the capacity. This is reasonable, as the increased number of drivers who use a smaller radius when making a left turn will travel farther around the roundabout, will travel slower, and may have a longer intraplatoon headway (or lower saturation flow). The longer intraplatoon headway will reduce the opportunities for drivers to enter the roundabout, and the capacity will be reduced.

In other circumstances, drivers at roundabouts in other countries have been found to accept small gaps. This behavior has now been found to cause the following circulating drivers to slow and the following headways to be reduced. This affects the predicted capacity if only the circulating headways are used. Good estimates of capacity have been found for single-lane roundabouts if the circulating flows are assumed to be random. This is the same assumption that has been used in the analysis of TWSC intersections.

The roundabout methodology is based on gap acceptance

Headways are assumed to be randomly distributed

EXHIBIT 17-36. ANALYSIS ON ONE ROUNDABOUT LEG

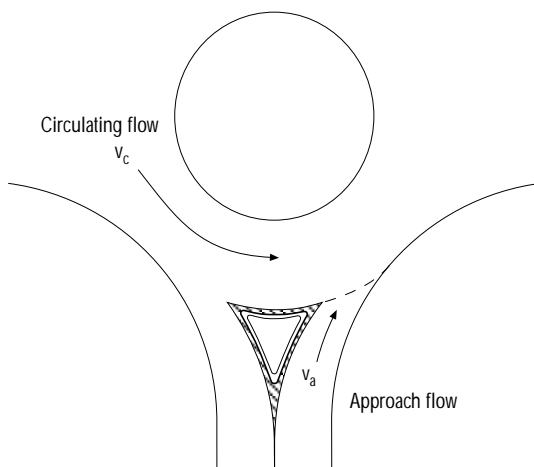

Because roundabouts involve drivers making a right turn onto the roundabout, the gap acceptance characteristics of drivers are expected to be the same as or similar to those of drivers making right turns at TWSC intersections. The concepts described in the section dealing with TWSC intersections are generally applicable to single-lane roundabouts. There are more traffic interactions at multilane roundabouts that influence driver behavior and make the TWSC technique inapplicable. More details on roundabout experience in the United States will be needed before a complete analysis procedure can be presented in the *Highway Capacity Manual*.

CAPACITY

The estimate of the capacity of a roundabout approach is given by Equation 17-70.

$$c_a = \frac{v_c e^{-v_c t_c / 3600}}{1 - e^{-v_c t_f / 3600}} \tag{17-70}$$

where

- c_a = approach capacity (veh/h),
- v_c = conflicting circulating traffic (veh/h),
- t_c = critical gap (s), and
- t_f = follow-up time (s).

Limited studies of roundabouts in the United States (5), as well as comparisons with operations in countries with experience in the design and operation of roundabouts (6), indicate that a range of values of critical gap and follow-up time should provide the analyst with a reasonable estimate of the approximate capacity of a planned roundabout. The recommended ranges are given in Exhibit 17-37. The relationship between approach capacity and circulating flow for these upper- and lower-bound values of critical gap and follow-up time is shown in Exhibit 17-38.

EXHIBIT 17-37. CRITICAL GAP AND FOLLOW-UP TIMES FOR ROUNDABOUTS

	Critical Gap (s)	Follow-Up Time (s)
Upper bound	4.1	2.6
Lower bound	4.6	3.1

The capacity model is for single-lane operation

EXHIBIT 17-38. ROUNDABOUT APPROACH CAPACITY

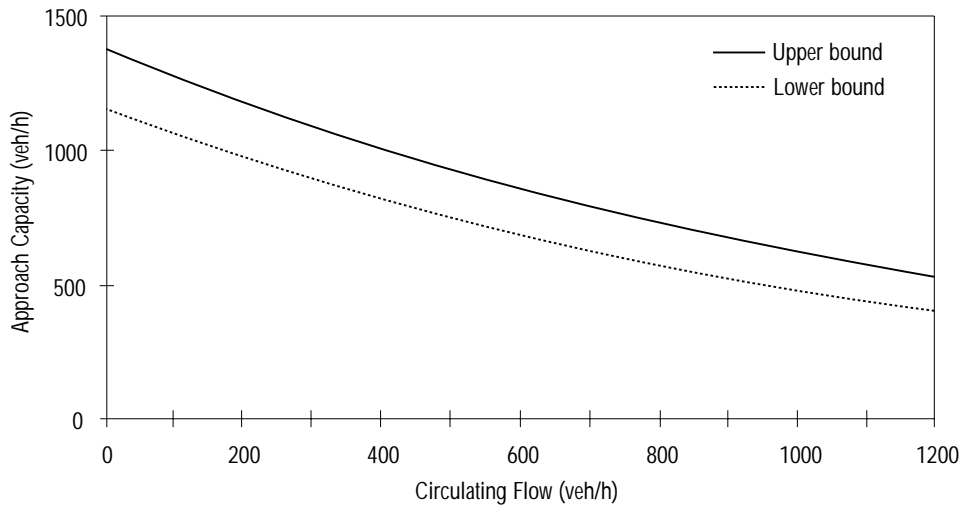

The conflicting flows are calculated by evaluating the 15-min volumes of vehicles passing in front of the entering vehicles. In other countries, the effect of vehicles exiting into the road where drivers are entering has been found to be of the second order. At most well-designed roundabouts the exiting traffic can be ignored.

In practice, it is necessary to convert the intersection turning movements into the circulating flows—the volumes v_1 to v_{12} as shown in Exhibit 17-39. For example, the circulating traffic for the entry by Streams 7, 8, and 9 is Streams 1, 2, and 10. Consequently, v_c would be equal to $v_1 + v_2 + v_{10}$. Roundabouts can often be used to facilitate U-turns, and the flow of U-turns should be included in the volumes.

This methodology is not applicable if a circulating volume is greater than 1,200 veh/h

EXHIBIT 17-39. FLOW STREAM DEFINITIONS

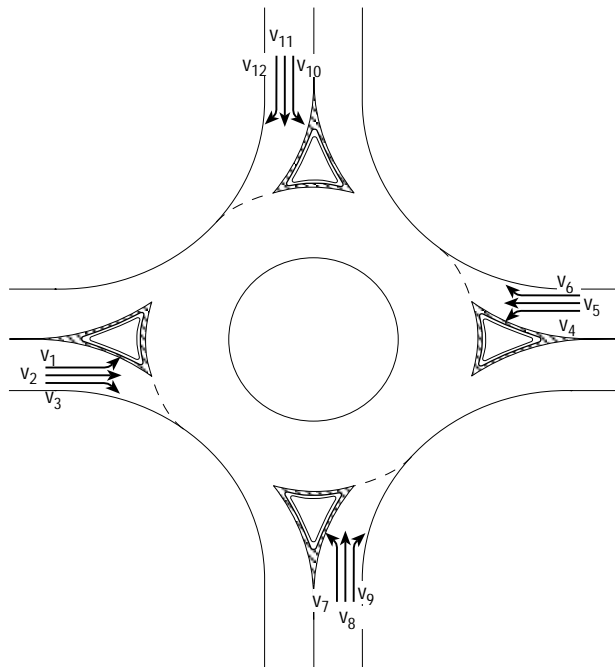

The above methodology applies to single-lane roundabouts. Experience with multiple-lane roundabouts in the United States is insufficient to support an analysis procedure. Experience in other countries indicates that capacity may be increased by increasing the number of lanes on the approaches and on the circulating roadway, but the effect is less than that of a full additional lane. In other words, doubling the number of lanes does not double the capacity. In addition, the performance of multiple-lane roundabouts is affected to a greater extent by site geometrics and driver characteristics. It is widely recognized that each of the approach lanes is likely to have substantially different gap acceptance characteristics.

If capacity values are required for multiple-lane roundabouts, a comprehensive roundabout analysis model should be used in lieu of the procedures presented here. Caution is necessary in the interpretation of the results produced by these models because their internal assumptions and parameters have not been well validated in the United States.

III. APPLICATIONS - PART C

The steps required to perform a roundabout analysis are identified below. A worksheet is provided to assist the analyst in completing the computations. The worksheet is applicable only to single-lane roundabouts with circulating flows less than 1,200 veh/h. The steps are as follows:

1. Define the existing geometry and traffic conditions for the roundabout under study. For each leg, volume data are entered for each approach. The approach flow is computed and entered in the next section of the worksheet.
2. Determine the conflicting (circulating) traffic at each leg of the roundabout. For each leg, the approach and the circulating traffic are computed and entered in the next table. If the circulating flow exceeds 1,200 veh/h, this procedure should not be used, unless field data have been collected for the critical gap and follow-up time.
3. Determine the capacity of the entry lanes using Equation 17-70.
4. Assess the general performance of the roundabout on the basis of the v/c ratio.

Guidelines for input and estimated values are given in Chapter 10

PART D. EXAMPLE PROBLEMS

Problem No.	Description	Application
1	TWSC Unsignalized Intersection	Operational LOS
2	TWSC Unsignalized Intersection	Operational LOS
3	TWSC Unsignalized Intersection	Operational LOS
4	AWSC Unsignalized Intersection	Operational LOS
5	AWSC Unsignalized Intersection	Operational LOS
6	Roundabout	Capacity and v/c ratio

EXAMPLE PROBLEM 1

The Intersection A TWSC T-intersection with an exclusive westbound left-turn lane.

The Question What are the delay and level of service?

The Facts

- √ Two-lane major street,
- √ Two-lane minor street,
- √ Level grade,
- √ Stop-controlled on minor street approach,
- √ 10 percent HV,
- √ No special intersection geometry, and
- √ No pedestrians.

Outline to Solution The steps below show the northbound approach calculations only. Calculations for other approaches are shown on the worksheets.

Steps

1. Data input.	Worksheets 1 and 2
2. Site characteristics.	Worksheet 3 - lane designation, grade, right-turn channelization, and arrival type
3. t_c and t_f (use Equations 17-1 and 17-2 and Exhibit 17-5).	$t_{c,x} = t_{c,base} + t_{c,HV} P_{HV} + t_{c,G} G - t_{c,T} - t_{3,LT}$ $t_{f,x} = t_{f,base} + t_{f,HV} P_{HV}$ $t_{c,4} = 4.1 + 1.0(0.10) + 0 - 0 - 0 = 4.200 \text{ s}$ $t_{f,x} = 2.2 + 0.9(0.10) = 2.290 \text{ s}$
4. Skip Worksheets 5a through 5e.	No upstream signals within 0.4 km
5. Movement capacity $c_{m,x}$ accounting for impedance (use Equation 17-4).	$v_{c,9} = \frac{v_2}{N} + 0.5v_3 + v_{14} + v_{15}$ $v_{c,9} = 250 + 20 + 0 + 0 = 270 \text{ veh/h}$ $c_{p,x} = v_{c,x} \frac{e^{-v_{c,x}t_{c,x}/3,600}}{1 - e^{-v_{c,x}t_{f,x}/3,600}}$ $c_{p,9} = 270 * \frac{e^{-270*6.300/3,600}}{1 - e^{-270*3.390/3,600}} = 750 \text{ veh/h}$ $c_{m,9} = c_{p,9} * P_{p,9} = 750 (1) = 750 \text{ veh/h}$ $P_{0,i} = 1 - \frac{v_i}{c_{m,i}}$ $P_{0,9} = 1 - \frac{120}{750} = 0.840$
6. Skip Worksheets 7a and 7b.	No two-stage gap acceptance
7. Shared-lane capacity (use Equation 17-15).	Worksheet 8 - Movements 7 and 9 share the same lane $C_{SH} = \frac{\sum v_y}{\sum \frac{v_y}{c_{m,y}}}$ $C_{SH(NB)} = \frac{40 + 120}{\frac{40}{274} + \frac{120}{750}} = 523 \text{ veh/h}$
8. Skip Worksheet 9.	No flared minor-street approach

9. Control delay and LOS (use Equation 17-38 and Exhibit 17-2).	<p>Worksheet 10</p> $d = \frac{3,600}{C_{m,x}} + 900T[...]+ 5$ $d_{NB} = \frac{3,600}{523} + 900(0.25)[...]+ 5 = 14.9 \text{ s,}$ <p>LOS B</p>
10. Skip Worksheet 11.	No Rank 1 vehicle delay

Example Problem 1

TWSC - UNSIGNALIZED INTERSECTIONS WORKSHEET

Worksheet 1

General Information		Site Information	
Analyst	KMN	Intersection	Jones/Market
Agency or Company	CEI	Jurisdiction	Latah County
Date Performed	5/17/99	Analysis Year	1999
Analysis Time Period	AM Peak		

Geometrics and Movements

Length of study period = 0.25 h

Worksheet 2

Vehicle Volumes and Adjustments

Movement	Vehicle Volumes and Adjustments											
	1	2	3	4	5	6	7	8	9	10	11	12
Volume (veh/h)		250	40	150	300		40		120			
Peak-hour factor, PHF		1.00	1.00	1.00	1.00		1.00		1.00			
Hourly flow rate (veh/h)		250	40	150	300		40		120			
Proportion of heavy vehicles, P _{HV}		0.10	0.10	0.10	0.10		0.10		0.10			

Pedestrian Volumes and Adjustments

Movement	13	14	15	16
Flow, V _x (ped/h)	0	0	0	0
Lane width, w (m)				
Walking speed, ¹ S _p (m/s)				
Percent blockage, f _p (Equation 17-11)				

1. Default walking speed = 1.2 m/s

Example Problem 1

TWSC - UNSIGNALIZED INTERSECTIONS WORKSHEET								
Worksheet 3								
General Information								
Project Description <u>Example Problem 1</u>								
Lane Designation								
Movements	Lane 1	Lane 2	Lane 3	Grade, G	Right Turn Channelized?			
1, 2, 3	2, 3			O	N			
4, 5, 6	4	5		O	N			
7, 8, 9	7, 9			O	N			
10, 11, 12								
Flared Minor-Street Approach								
Movement 9	<input type="checkbox"/> Yes	<input checked="" type="checkbox"/> No	Storage space, n	_____				
	(number of vehicles)							
Movement 12	<input type="checkbox"/> Yes	<input checked="" type="checkbox"/> No	Storage space, n	_____				
	(number of vehicles)							
Median Storage*								
* Includes raised or striped median (RM), or two-way left-turn lane (TWLTL)								
Type								
Movements 7 and 8	<input type="checkbox"/> Yes	_____	<input checked="" type="checkbox"/> No	Storage space, m	_____			
	(number of vehicles)							
Movements 10 and 11	<input type="checkbox"/> Yes	_____	<input checked="" type="checkbox"/> No	Storage space, m	_____			
	(number of vehicles)							
Upstream Signals								
	Movements	Distance to Signal, D (m)	Prog Speed, S _{prog} (km/h)	Cycle Length, C (s)	Green Time, g _{eff} (s)	Arrival Type	Saturation Flow Rate, s (veh/h)	Progressed Flow, V _{prog} (veh/h)
S ₂	protected LT					3		
	TH							
S ₅	protected LT					3		
	TH							
Computing Delay to Major-Street Vehicles								
Data for Computing Effect of Delay to Major-Street Vehicles				S ₂ Approach		S ₅ Approach		
Shared-lane volume, major-street through vehicles, v ₁₁ , blocked by LT								
Shared-lane volume, major-street right-turn vehicles, v ₁₂ , blocked by LT								
Saturation flow rate, major-street through vehicles, s ₁₁								
Saturation flow rate, major-street right-turn vehicles, s ₁₂								
Number of major-street through lanes								
Length of study period, T (h)								

TWSC - UNSIGNALIZED INTERSECTIONS WORKSHEET								
Worksheet 4								
General Information								
Project Description <u>Example Problem 1</u>								
Critical Gap and Follow-Up Time								
$t_c = t_{c,base} + t_{c,HV} P_{HV} + t_{c,G} G - t_{c,T} - t_{3,LT}$								
	Major LT		Minor RT		Minor TH		Minor LT	
Movement	1	4	9	12	8	11	7	10
$t_{c,base}$ (Exhibit 17-5)		4.1	6.2				7.1	
$t_{c,HV}$		1.0	1.0				1.0	
P_{HV} (from Worksheet 2)		0.10	0.10				0.10	
$t_{c,G}$		-	0.1	0.1	0.2	0.2	0.2	0.2
G (from Worksheet 3)		0	0				0	
$t_{3,LT}$		0.0	0.0				0.7	
$t_{c,T}$	single stage	0.0	0.0				0.0	
	two stage							
t_c (Equation 17-1)	single stage	4.200	6.300				6.500	
	two stage							
$t_f = t_{f,base} + t_{f,HV} P_{HV}$								
	Major LT		Minor RT		Minor TH		Minor LT	
Movement	1	4	9	12	8	11	7	10
$t_{f,base}$ (Exhibit 17-5)		2.2	3.3				3.5	
$t_{f,HV}$		0.9	0.9				0.9	
P_{HV} (from Worksheet 2)		0.10	0.10				0.10	
t_f (Equation 17-2)		2.290	3.390				3.590	
Worksheet 5a								
Time to Clear Standing Queue (Computation 1)								
	Movement 2				Movement 5			
	$v_{T,prog}$		$v_{L,prot}$		$v_{T,prog}$		$v_{L,prot}$	
Effective green, g_{eff} (s)								
Cycle length, C (s)								
Saturation flow rate, s (veh/h)								
Arrival type			3				3	
v_{prog} (veh/h)								
R_p (from Chapter 16)			1.00				1.00	
Proportion of vehicles arriving on green, P (Equation 17-17)								
g_{q1} (Equation 17-18)								
g_{q2} (Equation 17-19)								
g_q (Equation 17-20)								

Example Problem 1

TWSC - UNSIGNALIZED INTERSECTIONS WORKSHEET		
Worksheet 6		
General Information		
Project Description <u>Example Problem 1</u>		
Impedance and Capacity Calculation		
Step 1: RT from Minor Street	v_9	v_{12}
Conflicting flows (Exhibit 17-4)	$v_{c,9} = 270$	$v_{c,12} =$
Potential capacity (Equation 17-3 or 17-29)	$c_{p,9} = 750$	$c_{p,12} =$
Ped impedance factor (Equation 17-12)	$p_{p,9} = 1.000$	$p_{p,12} =$
Movement capacity (Equation 17-4)	$c_{m,9} = c_{p,9} p_{p,9} = 750$	$c_{m,12} = c_{p,12} p_{p,12} =$
Prob of queue-free state (Equation 17-5)	$p_{0,9} = 0.840$	$p_{0,12} = 1.000$
Step 2: LT from Major Street	v_4	v_1
Conflicting flows (Exhibit 17-4)	$v_{c,4} = 290$	$v_{c,1} =$
Potential capacity (Equation 17-3 or 17-29)	$c_{p,4} = 1227$	$c_{p,1} =$
Ped impedance factor (Equation 17-12)	$p_{p,4} = 1.000$	$p_{p,1} =$
Movement capacity (Equation 17-4)	$c_{m,4} = c_{p,4} p_{p,4} = 1227$	$c_{m,1} = c_{p,1} p_{p,1} =$
Prob of queue-free state (Equation 17-5)	$p_{0,4} = 0.878$	$p_{0,1} = 1.000$
Major left shared lane prob of queue-free state (Equation 17-16)	$p_{0,4}^* =$	$p_{0,1}^* =$
Step 3: TH from Minor Street (4-leg intersections only)	v_8	v_{11}
Conflicting flows (Exhibit 17-4)	$v_{c,8} =$	$v_{c,11} =$
Potential capacity (Equation 17-3 or 17-29)	$c_{p,8} =$	$c_{p,11} =$
Ped impedance factor (Equation 17-12)	$p_{p,8} =$	$p_{p,11} =$
Capacity adjustment factor due to impeding movement (shared lane use p^*) (Equation 17-13)	$f_8 = p_{0,4} p_{0,1} p_{p,8} =$	$f_{11} = p_{0,4} p_{0,1} p_{p,11} =$
Movement capacity (Equation 17-7)	$c_{m,8} = c_{p,8} f_8 =$	$c_{m,11} = c_{p,11} f_{11} =$
Prob of queue-free state	$p_{0,8} =$	$p_{0,11} =$
Step 4: LT from Minor Street (4-leg intersections only)	v_7	v_{10}
Conflicting flows (Exhibit 17-4)	$v_{c,7} =$	$v_{c,10} =$
Potential capacity (Equation 17-3 or 17-29)	$c_{p,7} =$	$c_{p,10} =$
Ped impedance factor (Equation 17-12)	$p_{p,7} =$	$p_{p,10} =$
Major left, minor through impedance factor	$p_7^* = p_{0,11} f_{11} =$	$p_{10}^* = p_{0,8} f_8 =$
Major left, minor through adjusted impedance factor (Equation 17-8)	$p_7 =$	$p_{10} =$
Capacity adjustment factor due to impeding movements (Equation 17-14)	$f_7 = p_7^* p_{0,12} p_{p,7} =$	$f_{10} = p_{10}^* p_{0,9} p_{p,10} =$
Movement capacity (Equation 17-10)	$c_{m,7} = f_7 c_{p,7} =$	$c_{m,10} = f_{10} c_{p,10} =$
Step 5: LT from Minor Street (T-intersections only)	v_7	v_{10}
Conflicting flows (Exhibit 17-4)	$v_{c,7} = 870$	$v_{c,10} =$
Potential capacity (Equation 17-3 or 17-29)	$c_{p,7} = 312$	$c_{p,10} =$
Ped impedance factor (Equation 17-12)	$p_{p,7} = 1.000$	$p_{p,10} =$
Capacity adjustment factor due to impeding movement (shared lane use p^*) (Equation 17-13)	$f_7 = p_{0,4} p_{0,1} p_{p,7} = 0.878$	$f_{10} = p_{0,4} p_{0,1} p_{p,10} =$
Movement capacity (Equation 17-7)	$c_{m,7} = c_{p,7} f_7 = 274$	$c_{m,10} = c_{p,10} f_{10} =$
Notes		
1. For 4-leg intersections use Steps 1, 2, 3, and 4.		
2. For T-intersections use Steps 1, 2, and 5.		

TWSC - UNSIGNALIZED INTERSECTIONS WORKSHEET						
Worksheet 8						
General Information						
Project Description <u>Example Problem 1</u>						
Shared-Lane Capacity						
$C_{SH} = \frac{\sum y}{\sum \left(\frac{v_y}{C_{m,y}} \right)}$ (Equation 17-15)						
Movement	v (veh/h)	c _m (veh/h)	C _{SH} (veh/h)			
7	40	274	523			
8						
9	120	750				
10						
11						
12						
Worksheet 9						
Effect of Flared Minor-Street Approaches						
	Movement 7	Movement 8	Movement 9	Movement 10	Movement 11	Movement 12
C _{sep} (from Worksheet 6 or 7)						
Volume (from Worksheet 2)						
Delay (Equation 17-38)						
Q _{sep} (Equation 17-34)						
Q _{sep} + 1						
Round (Q _{sep} + 1)						
η _{max} (Equation 17-35)						
C _{SH}						
C _{sep}						
n						
C _{act} (Equation 17-36)						

Example Problem 1

TWSC - UNSIGNALIZED INTERSECTIONS WORKSHEET							
Worksheet 10							
General Information							
Project Description <u>Example Problem 1</u>							
Control Delay, Queue Length, Level of Service							
Lane	v (veh/h)	c _m (veh/h)	v/c	Queue Length (Equation 17-37)	Control Delay (Equation 17-38)	LOS (Exhibit 17-2)	Delay and LOS
1 (X)(X)(X)	160	523	0.306	< 2	14.9	B	14.9 B
2 (7)(8)(9)							
3 (7)(8)(9)							
1 (10)(11)(12)							
2 (10)(11)(12)							
3 (10)(11)(12)							
Movement	v (veh/h)	c _m (veh/h)	v/c	Queue Length (Equation 17-37)	Control Delay (Equation 17-38)	LOS (Exhibit 17-2)	
1							
4	150	1227	0.12	< 1	8.3	A	
Worksheet 11							
Delay to Rank 1 Vehicles							
	S ₂ Approach			S ₅ Approach			
p _{0,j} (Equation 17-5)	p _{0,1} =			p _{0,4} =			
v ₁₁ , volume for Stream 2 or 5							
v ₁₂ , volume for Stream 3 or 6							
s ₁₁ , saturation flow rate for Stream 2 or 5							
s ₁₂ , saturation flow rate for Stream 3 or 6							
p _{0,j} [*] (Equation 17-16)	p _{0,1} [*] =			p _{0,4} [*] =			
d _{major left} , delay for Stream 1 or 4							
N, number of major-street through lanes							
d _{Rank 1} , delay for Stream 2 or 5 (Equation 17-39)							

EXAMPLE PROBLEM 2

The Intersection A TWSC intersection with upstream signals. The major street is Walnut St. (EB/WB) and the minor street is Elm St. (NB/SB).

The Question What are the delay and level of service of the minor-street approaches?

The Facts

- √ Four-lane major street, √ 10 percent HV,
- √ Two-lane minor street, √ Upstream signals in both major-street directions, and
- √ Level grade, √ No pedestrians.

Outline to Solution The steps below show the northbound approach calculations only. Calculations for other approaches are shown on the worksheets.

Steps

1. Data input.	Worksheets 1 and 2
2. Site characteristics.	Worksheet 3 - lane designation, grades, right-turn channelization, and upstream signals
3. t_c and t_f (s) (use Equations 17-1 and 17-2 and Exhibit 17-5).	$t_{c,x} = t_{c,base} + t_{c,HV} P_{HV} + t_{c,G} G - t_{c,T} - t_{3,LT}$ $t_{c,1} = 4.1 + 2.0(0.10) + 0 - 0 - 0 = 4.300 \text{ s}$ $t_{f,x} = t_{f,base} + t_{f,HV} P_{HV}$ $t_{f,1} = 2.2 + 1.0(0.10) = 2.300 \text{ s}$
4. Effect of upstream signals Proportion of vehicles arriving during green, P (use Equation 17-17). Discharge time (use Equations 17-18, 17-19, and 17-20). Maximum platoon flow rate, $v_{c,max}$ (use Equation 17-21). Minimum platoon flow rate, $v_{c,min}$. Duration of blocked period, $t_{p,i}$ (use Equation 17-22). Proportion of time blocked (use Equation 17-23).	<p>Worksheets 5a through 5e</p> $P = R_p \frac{g_{eff}}{C}$ $P = 0.33 \frac{30}{80} = 0.124$ <p>For Movement 2</p> $g_q = g_{q1} + g_{q2}$ $g_{q1} = \frac{v_{prog} C (1-P)}{s} = \frac{250(80)(1-0.124)}{3,600} = 4.867$ $g_{q2} = \frac{v_{prog} C P g_{q1}}{s g_{eff} - v_{prog} C P} = \frac{250(80)(0.124)(4.867)}{3,600(30) - 250(80)(0.124)} = 0.114$ $g_q = 4.867 + 0.114 = 4.981$ $v_{c,max} = s f [1 - (1 - F)^{g_q}]$ $v_{c,max} = 3,600(0.751)[1 - (1 - 0.253)^{4.981}] = 2,071 \text{ veh/h}$ $v_{c,min} = 1,000(2) = 2,000$ $t_{p,i} = g_q - \frac{\ln \left[\left(1 - \frac{v_{c,min}}{s f} \right) \left(\frac{v_{c,max} - v_{prog} R_p f}{v_{c,min} - v_{prog} R_p f} \right) \right]}{\ln(1-F)}$ $t_{p,2} = 4.981 - \frac{\ln \left[\left(1 - \frac{2,000}{3,600(0.751)} \right) \left(\frac{2,071 - 250(0.33)(0.751)}{2,000 - 250(0.33)(0.751)} \right) \right]}{\ln(1-0.253)} = 0.489$ $p_i = \frac{t_{p,T} + t_{p,L}}{C}$ $p_2 = \frac{0.489}{80} = 0.006$

<p>4. (continued) Dominant and subordinate platoons (use Equations 17-24 and 17-25).</p> <p>Conflicting flow during unblocked period (use Equation 17-28).</p> <p>Capacity during unblocked period, $c_{r,x}$ (use Equation 17-3).</p> <p>Potential capacity, $c_{plat,x}$, accounting for platooning (use Equation 17-29).</p>	$P_{dom} = \max(p_2, p_5)$ $P_{subo} = \min(p_2, p_5)$ $P_{dom} = P_2 = 0.006$ $P_{subo} = P_5 = 0.000$ $V_{c,u,x} = \frac{v_{c,x} - s(1-p_x)}{p_x}$ $V_{c,u,1} = \frac{400 - 3,600(1 - 1.000)}{1.000} = 400 \text{ veh/h}$ $C_{r,x} = V_{c,u,x} \frac{e^{-v_{c,u,x}t_{c,x}/3,600}}{1 - e^{-v_{c,u,x}t_{c,x}/3,600}}$ $C_{r,1} = 400 \frac{e^{-400(4.300)/3,600}}{1 - e^{-400(2.300)/3,600}} = 1,100 \text{ veh/h}$ $C_{plat,x} = P_x C_{r,x}$ $C_{plat,1} = 1.000(1,100) = 1,100 \text{ veh/h}$
<p>5. Movement capacity, $c_{m,x}$, accounting for impedance (use Equation 17-4, 17-7, or 17-10).</p>	$C_{m,x} = C_{plat,x} f_x$ $C_{m,1} = 1,100(1.000) = 1,100 \text{ veh/h}$
<p>6. Skip Worksheets 7a and 7b.</p>	<p>No two-stage gap acceptance</p>
<p>7. Shared-lane capacity Worksheet 8 (use Equation 17-15).</p>	$C_{SH} = \frac{\sum_y v_y}{\sum_y \frac{v_y}{C_{m,y}}}$ $C_{SH(NB)} = \frac{44 + 132 + 55}{\frac{44}{202} + \frac{132}{254} + \frac{55}{867}} = 288 \text{ veh/h}$
<p>8. Skip Worksheet 9.</p>	<p>No flared minor-street approaches</p>
<p>9. Control delay and LOS (use Equation 17-38 and Exhibit 17-2).</p>	$d = \frac{3,600}{C_{m,x}} + 900T[\dots] + 5$ $d_{NB} = \frac{3,600}{288} + 900(0.25)[\dots] + 5 = 53.5 \text{ s, LOS F}$
<p>10. Skip Worksheet 11.</p>	<p>No Rank 1 vehicle delay</p>

TWSC - UNSIGNALIZED INTERSECTIONS WORKSHEET

Worksheet 1

General Information	Site Information
Analyst <u>JME</u>	Intersection <u>Walnut/Elm</u>
Agency or Company <u>CEI</u>	Jurisdiction <u>Latah County</u>
Date Performed <u>5/7/99</u>	Analysis Year <u>1999</u>
Analysis Time Period <u>AM Peak</u>	

Geometrics and Movements

Length of study period = 0.25 h

Worksheet 2

Vehicle Volumes and Adjustments

Movement	Vehicle Volumes and Adjustments											
	1	2	3	4	5	6	7	8	9	10	11	12
Volume (veh/h)	33	250	50	66	300	100	44	132	55	11	110	28
Peak-hour factor, PHF	1.000	1.000	1.000	1.000	1.000	1.000	1.000	1.000	1.000	1.000	1.000	1.000
Hourly flow rate (veh/h)	33	250	50	66	300	100	44	132	55	11	110	28
Proportion of heavy vehicles, P_{HV}	0.10	0.10	0.10	0.10	0.10	0.10	0.10	0.10	0.10	0.10	0.10	0.10

Pedestrian Volumes and Adjustments

Movement	13	14	15	16
Flow, V_x (ped/h)	0	0	0	0
Lane width, w (m)				
Walking speed, ¹ S_p (m/s)				
Percent blockage, f_p (Equation 17-11)				

1. Default walking speed = 1.2 m/s

Example Problem 2

TWSC - UNSIGNALIZED INTERSECTIONS WORKSHEET								
Worksheet 3								
General Information								
Project Description <u>Example Problem 2</u>								
Lane Designation								
Movements	Lane 1	Lane 2	Lane 3	Grade, G	Right Turn Channelized?			
1, 2, 3	1	2	2, 3	0	N			
4, 5, 6	4	5	5, 6	0	N			
7, 8, 9	7, 8, 9			0	N			
10, 11, 12	10, 11, 12			0	N			
Flared Minor-Street Approach								
Movement 9	<input type="checkbox"/> Yes	<input checked="" type="checkbox"/> No	Storage space, n	_____				
	(number of vehicles)							
Movement 12	<input type="checkbox"/> Yes	<input checked="" type="checkbox"/> No	Storage space, n	_____				
	(number of vehicles)							
Median Storage*								
* Includes raised or striped median (RM), or two-way left-turn lane (TWLTL)								
Type								
Movements 7 and 8	<input type="checkbox"/> Yes	_____	<input checked="" type="checkbox"/> No	Storage space, m	_____			
	(number of vehicles)							
Movements 10 and 11	<input type="checkbox"/> Yes	_____	<input checked="" type="checkbox"/> No	Storage space, m	_____			
	(number of vehicles)							
Upstream Signals								
	Movements	Distance to Signal, D (m)	Prog Speed, S _{prog} (km/h)	Cycle Length, C (s)	Green Time, g _{eff} (s)	Arrival Type	Saturation Flow Rate, s (veh/h)	Progressed Flow, V _{prog} (veh/h)
S ₂	protected LT					3		
	TH	135	55	80.0	30.0	1	3600	250
S ₅	protected LT					3		
	TH	200	50	70.0	20.0	1	3600	250
Computing Delay to Major-Street Vehicles								
Data for Computing Effect of Delay to Major-Street Vehicles					S ₂ Approach	S ₅ Approach		
Shared-lane volume, major-street through vehicles, v ₁₁ , blocked by LT								
Shared-lane volume, major-street right-turn vehicles, v ₁₂ , blocked by LT								
Saturation flow rate, major-street through vehicles, s ₁₁								
Saturation flow rate, major-street right-turn vehicles, s ₁₂								
Number of major-street through lanes								
Length of study period, T (h)								

TWSC - UNSIGNALIZED INTERSECTIONS WORKSHEET								
Worksheet 4								
General Information								
Project Description		Example Problem 2						
Critical Gap and Follow-Up Time								
$t_c = t_{c,base} + t_{c,HV} P_{HV} + t_{c,G} G - t_{c,T} - t_{3,LT}$								
	Major LT		Minor RT		Minor TH		Minor LT	
Movement	1	4	9	12	8	11	7	10
$t_{c,base}$ (Exhibit 17-5)	4.1	4.1	6.9	6.9	6.5	6.5	7.5	7.5
$t_{c,HV}$	2.0	2.0	2.0	2.0	2.0	2.0	2.0	2.0
P_{HV} (from Worksheet 2)	0.10	0.10	0.10	0.10	0.10	0.10	0.10	0.10
$t_{c,G}$	-	-	0.1	0.1	0.2	0.2	0.2	0.2
G (from Worksheet 3)	0	0	0	0	0	0	0	0
$t_{3,LT}$	0.0	0.0	0.0	0.0	0.0	0.0	0.0	0.0
$t_{c,T}$	single stage	0.0	0.0	0.0	0.0	0.0	0.0	0.0
	two stage	-	-	-	-	-	-	-
t_c (Equation 17-1)	single stage	4.300	4.300	7.100	7.100	6.700	6.700	7.700
	two stage	-	-	-	-	-	-	-
$t_f = t_{f,base} + t_{f,HV} P_{HV}$								
	Major LT		Minor RT		Minor TH		Minor LT	
Movement	1	4	9	12	8	11	7	10
$t_{f,base}$ (Exhibit 17-5)	2.2	2.2	3.3	3.3	4.0	4.0	3.5	3.5
$t_{f,HV}$	1.0	1.0	1.0	1.0	1.0	1.0	1.0	1.0
P_{HV} (from Worksheet 2)	0.10	0.10	0.10	0.10	0.10	0.10	0.10	0.10
t_f (Equation 17-2)	2.300	2.300	3.400	3.400	4.100	4.100	3.600	3.600
Worksheet 5a								
Time to Clear Standing Queue (Computation 1)								
	Movement 2			Movement 5				
	$V_{T,prog}$		$V_{L,prot}$	$V_{T,prog}$		$V_{L,prot}$		
Effective green, g_{eff} (s)	30.0			20.0				
Cycle length, C (s)	80.0			70.0				
Saturation flow rate, s (veh/h)	3600			3600				
Arrival type	1		3	1		3		
V_{prog} (veh/h)	250			250				
R_p (from Chapter 16)	0.33		1.00	0.33		1.00		
Proportion of vehicles arriving on green, P (Equation 17-17)	0.124			0.094				
g_{q1} (Equation 17-18)	4.867			4.404				
g_{q2} (Equation 17-19)	0.114			0.103				
g_q (Equation 17-20)	4.981			4.507				

Example Problem 2

TWSC - UNSIGNALIZED INTERSECTIONS WORKSHEET				
Worksheet 5b				
General Information				
Project Description <u>Example Problem 2</u>				
Proportion of Time TWSC Intersection Is Blocked (Computation 2)				
	Movement 2		Movement 5	
	$V_{T,prog}$	$V_{L,prot}$	$V_{T,prog}$	$V_{L,prot}$
α (Exhibit 17-13)	0.50		0.50	
$\beta = (1 + \alpha)^{-1}$	0.667		0.667	
$t_a = D/S_{prog}$ (s)	8.836		14.400	
$F = (1 + \alpha\beta t_a)^{-1}$	0.253		0.172	
$f = v_{prog}/V_c \geq 0$	0.751		0.536	
$v_{c,Max}$ (Equation 17-21)	2071		1105	
$v_{c,Min} = 1000N$	2000		2000	
t_p (Equation 17-22)	0.489		0.000	
p (Equation 17-23)	0.006		0.000	
Worksheet 5c				
Platoon Event Periods (Computation 3)				
p_2 (from Worksheet 5b)				0.006
p_5 (from Worksheet 5b)				0.000
p_{dom} (Equation 17-24)				0.006
p_{subo} (Equation 17-25)				0.000
Constrained or unconstrained (Equation 17-26, 17-27)				<i>Unconstrained</i>
Proportion for Minor Movements, p_x				
	Single-Stage (Exhibit 17-16)	Two-Stage		
		Stage I	Stage II	
p_1	1.000			
p_4	0.994			
p_7	0.994	1 - p_2	1 - p_5	
p_8	0.994	1 - p_2	1 - p_5	
p_9	0.994			
p_{10}	0.994	1 - p_5	1 - p_2	
p_{11}	0.994	1 - p_5	1 - p_2	
p_{12}	1.000			

TWSC - UNSIGNALIZED INTERSECTIONS WORKSHEET								
Worksheet 5d								
General Information								
Project Description	Example Problem 2							
Conflicting Flows During Unblocked Period (Computation 4)								
Single-Stage								
Movements	1	4	7	8	9	10	11	12
$v_{c,x}$ (Exhibit 17-4)	400	300	678	873	150	739	848	200
s (veh/h)	3600	3600	3600	3600	3600	3600	3600	3600
p_x (from Worksheet 5c)	1.000	0.994	0.994	0.994	0.994	0.994	0.994	1.000
$v_{c,u,x}$ (Equation 17-28)	400	280	660	857	129	722	831	200
Two-Stage								
Movements	7		8		10		11	
	Stage I	Stage II	Stage I	Stage II	Stage I	Stage II	Stage I	Stage II
$v_{c,x}$ (Exhibit 17-4)								
s (veh/h)								
p_x (from Worksheet 5c)								
$v_{c,u,x}$ (Equation 17-28)								
Worksheet 5e								
Capacity During Unblocked Period (Computation 5)								
Single-Stage								
Movements	1	4	7	8	9	10	11	12
p_x (from Worksheet 5c)	1.000	0.994	0.994	0.994	0.994	0.994	0.994	1.000
$c_{r,x}$ (Equation 17-3)	1100	1223	333	279	872	300	289	783
$c_{plat,x}$ (Equation 17-29)	1100	1216	331	277	867	298	287	783
Two-Stage								
Movements	7		8		10		11	
	Stage I	Stage II	Stage I	Stage II	Stage I	Stage II	Stage I	Stage II
p_x (from Worksheet 5c)								
$c_{r,x}$ (Equation 17-3)								
$c_{plat,x}$ (Equation 17-29)								

Example Problem 2

TWSC - UNSIGNALIZED INTERSECTIONS WORKSHEET		
Worksheet 6		
General Information		
Project Description <u>Example Problem 2</u>		
Impedance and Capacity Calculation		
Step 1: RT from Minor Street	v_9	v_{12}
Conflicting flows (Exhibit 17-4)	$v_{c,9} = 150$	$v_{c,12} = 200$
Potential capacity (Equation 17-3 or 17-29)	$c_{p,9} = 867$	$c_{p,12} = 783$
Ped impedance factor (Equation 17-12)	$p_{p,9} = 1.000$	$p_{p,12} = 1.000$
Movement capacity (Equation 17-4)	$c_{m,9} = c_{p,9} p_{p,9} = 867$	$c_{m,12} = c_{p,12} p_{p,12} = 783$
Prob of queue-free state (Equation 17-5)	$p_{0,9} = 0.937$	$p_{0,12} = 0.964$
Step 2: LT from Major Street	v_4	v_1
Conflicting flows (Exhibit 17-4)	$v_{c,4} = 300$	$v_{c,1} = 400$
Potential capacity (Equation 17-3 or 17-29)	$c_{p,4} = 1216$	$c_{p,1} = 1100$
Ped impedance factor (Equation 17-12)	$p_{p,4} = 1.000$	$p_{p,1} = 1.000$
Movement capacity (Equation 17-4)	$c_{m,4} = c_{p,4} p_{p,4} = 1216$	$c_{m,1} = c_{p,1} p_{p,1} = 1100$
Prob of queue-free state (Equation 17-5)	$p_{0,4} = 0.946$	$p_{0,1} = 0.970$
Major left shared lane prob of queue-free state (Equation 17-16)	$p_{0,4}^* =$	$p_{0,1}^* =$
Step 3: TH from Minor Street (4-leg intersections only)	v_8	v_{11}
Conflicting flows (Exhibit 17-4)	$v_{c,8} = 873$	$v_{c,11} = 848$
Potential capacity (Equation 17-3 or 17-29)	$c_{p,8} = 277$	$c_{p,11} = 287$
Ped impedance factor (Equation 17-12)	$p_{p,8} = 1.000$	$p_{p,11} = 1.000$
Capacity adjustment factor due to impeding movement (shared lane use p^*) (Equation 17-13)	$f_8 = p_{0,4} p_{0,1} p_{p,8} = 0.917$	$f_{11} = p_{0,4} p_{0,1} p_{p,11} = 0.917$
Movement capacity (Equation 17-7)	$c_{m,8} = c_{p,8} f_8 = 254$	$c_{m,11} = c_{p,11} f_{11} = 263$
Prob of queue-free state	$p_{0,8} = 0.480$	$p_{0,11} = 0.582$
Step 4: LT from Minor Street (4-leg intersections only)	v_7	v_{10}
Conflicting flows (Exhibit 17-4)	$v_{c,7} = 678$	$v_{c,10} = 739$
Potential capacity (Equation 17-3 or 17-29)	$c_{p,7} = 331$	$c_{p,10} = 298$
Ped impedance factor (Equation 17-12)	$p_{p,7} = 1.000$	$p_{p,10} = 1.000$
Major left, minor through impedance factor	$p_7^* = p_{0,11} f_{11} = 0.534$	$p_{10}^* = p_{0,8} f_8 = 0.440$
Major left, minor through adjusted impedance factor (Equation 17-8)	$p_7^* = 0.634$	$p_{10}^* = 0.556$
Capacity adjustment factor due to impeding movements (Equation 17-14)	$f_7 = p_7^* p_{0,12} p_{p,7} = 0.611$	$f_{10} = p_{10}^* p_{0,9} p_{p,10} = 0.521$
Movement capacity (Equation 17-10)	$c_{m,7} = f_7 c_{p,7} = 202$	$c_{m,10} = f_{10} c_{p,10} = 155$
Step 5: LT from Minor Street (T-intersections only)	v_7	v_{10}
Conflicting flows (Exhibit 17-4)	$v_{c,7} =$	$v_{c,10} =$
Potential capacity (Equation 17-3 or 17-29)	$c_{p,7} =$	$c_{p,10} =$
Ped impedance factor (Equation 17-12)	$p_{p,7} =$	$p_{p,10} =$
Capacity adjustment factor due to impeding movement (shared lane use p^*) (Equation 17-13)	$f_7 = p_{0,4} p_{0,1} p_{p,7} =$	$f_{10} = p_{0,4} p_{0,1} p_{p,10} =$
Movement capacity (Equation 17-7)	$c_{m,7} = c_{p,7} f_7 =$	$c_{m,10} = c_{p,10} f_{10} =$
Notes		
1. For 4-leg intersections use Steps 1, 2, 3, and 4.		
2. For T-intersections use Steps 1, 2, and 5.		

TWSC - UNSIGNALIZED INTERSECTIONS WORKSHEET						
Worksheet 8						
General Information						
Project Description <u>Example Problem 2</u>						
Shared-Lane Capacity						
$c_{SH} = \frac{\sum y}{\sum \left(\frac{v_y}{c_{m,y}} \right)}$ (Equation 17-15)						
Movement	v (veh/h)	c_m (veh/h)	c_{SH} (veh/h)			
7	44	202	288			
8	132	254				
9	55	867				
10	11	155	284			
11	110	263				
12	28	783				
Worksheet 9						
Effect of Flared Minor-Street Approaches						
	Movement 7	Movement 8	Movement 9	Movement 10	Movement 11	Movement 12
c_{sep} (from Worksheet 6 or 7)						
Volume (from Worksheet 2)						
Delay (Equation 17-38)						
Q_{sep} (Equation 17-34)						
$Q_{sep} + 1$						
Round ($Q_{sep} + 1$)						
n_{max} (Equation 17-35)						
c_{SH}						
c_{sep}						
n						
c_{act} (Equation 17-36)						

Example Problem 2

TWSC - UNSIGNALIZED INTERSECTIONS WORKSHEET							
Worksheet 10							
General Information							
Project Description <u>Example Problem 2</u>							
Control Delay, Queue Length, Level of Service							
Lane	v (veh/h)	c _m (veh/h)	v/c	Queue Length (Equation 17-37)	Control Delay (Equation 17-38)	LOS (Exhibit 17-2)	Delay and LOS
1 (X)(X)(X)	231	288	0.802	6	53.5	F	53.5 F
2 (7)(8)(9)							
3 (7)(8)(9)							
1 (10)(11)(12)	149	284	0.525	3	30.9	D	30.9 D
2 (10)(11)(12)							
3 (10)(11)(12)							
Movement	v (veh/h)	c _m (veh/h)	v/c	Queue Length (Equation 17-37)	Control Delay (Equation 17-38)	LOS (Exhibit 17-2)	
1	33	1100	0.030	-	8.4	A	
4	66	1216	0.054	-	8.1	A	
Worksheet 11							
Delay to Rank 1 Vehicles							
	S ₂ Approach			S ₅ Approach			
p _{0,j} (Equation 17-5)	p _{0,1} =			p _{0,4} =			
v ₁₁ , volume for Stream 2 or 5							
v ₁₂ , volume for Stream 3 or 6							
s ₁₁ , saturation flow rate for Stream 2 or 5							
s ₁₂ , saturation flow rate for Stream 3 or 6							
p _{0,j} [*] (Equation 17-16)	p _{0,1} [*] =			p _{0,4} [*] =			
d _{major left} , delay for Stream 1 or 4							
N, number of major-street through lanes							
d _{Rank 1} , delay for Stream 2 or 5 (Equation 17-39)							

EXAMPLE PROBLEM 3

The Intersection A TWSC intersection with flared approaches and a median storage. The major street is Walnut St. (EB/WB), and the minor street is Elm St. (NB/SB).

The Question What are the delay and level of service of the minor-street approaches?

The Facts

- √ Four-lane major street, √ 10 percent HV,
- √ Two-lane minor street, √ Flared approach, storage for one vehicle, and
- √ Level grade, √ Median storage, storage for two vehicles.
- √ No pedestrians,

Outline to Solution The steps below show the northbound approach calculations only. Calculations for other approaches are shown on the worksheets.

Steps

1. Data input.	Worksheets 1 and 2
2. Site characteristics.	Worksheet 3 - lane distribution, grades, right-turn channelization, flared minor-street approach, and median storage
3. t_c and t_f (use Equations 17-1 and 17-2).	Worksheet 4 - Movement 1 $t_c = t_{c,base} + t_{c,HV} P_{HV} + \dots$ $t_c = 4.1 + 2.0(0.10) + 0.0 - 0.0 - 0.0 = 4.300 \text{ s}$ $t_f = t_{f,base} + t_{f,HV} P_{HV}$ $t_f = 2.2 + 1.0(0.10) = 2.300 \text{ s}$
4. Skip Worksheets 5a through 5e.	No upstream signals within 0.4 km
5. Movement capacity, $c_{m,x}$, for minor RT and major LT movements accounting for impedance (use Equations 17-3, 17-4, 17-5, and 17-12).	Worksheet 6 - Movement 9 $v_{c,9} = \frac{v_2}{N} + 0.5v_3 + v_{14} + v_{15}$ $v_{c,9} = \frac{250}{2} + 0.5(50) + 0 + 0 = 150 \text{ veh/h}$ $C_{p,9} = v_{c,9} \frac{e^{-v_{c,9}t_{c,9}/3,600}}{1 - e^{-v_{c,9}t_{f,9}/3,600}}$ $C_{p,9} = 150 \frac{e^{-150(7.1)/3,600}}{1 - e^{-150(3.4)/3,600}} = 845 \text{ veh/h}$ $p_{p,9} = 1.0 - f_p = 1.0 - 0.000 = 1.000$ $c_{m,9} = C_{p,9} p_{p,9} = (845)(1.000) = 845 \text{ veh/h}$ $p_{0,9} = 1 - \frac{v_9}{c_{m,9}} = 1 - \frac{55}{845} = 0.935$
6. Movement capacities, $c_{m,x}$, for minor TH and minor LT movements, accounting for impedance and two-stage gap process (use Equations 17-32, 17-33, or 17-7 and Exhibit 17-4).	Worksheets 7a and 7b $v_{c,I,8} = 341 \text{ veh/h}$ $v_{c,II,8} = 532 \text{ veh/h}$ $v_{c,8} = 873 \text{ veh/h}$ Single Stage $c_{m,8} = c_{p,8} f_8 = 273(0.917) = 250 \text{ veh/h}$ Two-Stage $c_T = \frac{\alpha}{y^{m+1} - 1} [y(y^m - 1) \dots]$ $c_T = \frac{0.949}{1.808^{2+1} - 1} [1.808(1.808^2 - 1) \dots] = 390 \text{ veh/h}$

<p>7. Shared-lane capacity (use Equation 17-15).</p>	<p>Worksheet 8</p> $c_{SH} = \frac{\sum_y v_y}{\sum_y c_m}$ $c_{SH} (NB) = \frac{44 + 132 + 55}{\frac{44}{370} + \frac{132}{390} + \frac{55}{845}} = 442 \text{ veh/h}$
<p>8. Flared approach capacity (use Equations 17-36 and 17-38).</p>	<p>Worksheet 9 - Movement 7</p> $d = \frac{3,600}{c_{m,x}} + 900T[\dots] + 5$ $d = \frac{3,600}{369} + 900(0.25)[\dots] + 5 = 16.070 \text{ s}$ $Q_{sep} = \frac{d_7 v_7}{3,600} = \frac{(16.0)(44)}{3,600} = 0.196$ $c_{act} (NB) = \left(\sum_i c_{sep} - c_{SH} \right) \frac{n}{n_{Max}} + c_{SH}$ $c_{act} = (1,605 - 442) \frac{1}{2} + 442 = 1,024 \text{ veh/h}$
<p>9. Control delay and LOS (use Equation 17-38 and Exhibit 17-2).</p>	<p>Worksheet 10</p> $d_{NB} = \frac{3,600}{c_{m,x}} + 900T[\dots] + 5$ $d_{NB} = \frac{3,600}{1,024} + 900(0.05)[\dots] + 5 = 9.5 \text{ s}$ <p>LOS A</p>
<p>10. Skip Worksheet 11.</p>	<p>No Rank 1 vehicle delay</p>

TWSC - UNSIGNALIZED INTERSECTIONS WORKSHEET

Worksheet 1

General Information

Analyst JME
 Agency or Company CEI
 Date Performed 5/7/99
 Analysis Time Period AM Peak

Site Information

Intersection Walnut/Elm
 Jurisdiction Latah County
 Analysis Year 1999

Geometrics and Movements

Length of study period = 0.25 h

Worksheet 2

Vehicle Volumes and Adjustments

Movement	Vehicle Volumes and Adjustments											
	1	2	3	4	5	6	7	8	9	10	11	12
Volume (veh/h)	33	250	50	66	300	100	44	132	55	11	110	28
Peak-hour factor, PHF	1.00	1.00	1.00	1.00	1.00	1.00	1.00	1.00	1.00	1.00	1.00	1.00
Hourly flow rate (veh/h)	33	250	50	66	300	100	44	132	55	11	110	28
Proportion of heavy vehicles, P _{HV}	0.10	0.10	0.10	0.10	0.10	0.10	0.10	0.10	0.10	0.10	0.10	0.10

Pedestrian Volumes and Adjustments

Movement	13	14	15	16
Flow, V _x (ped/h)	0	0	0	0
Lane width, w (m)				
Walking speed, ¹ S _p (m/s)				
Percent blockage, f _p (Equation 17-11)				

1. Default walking speed = 1.2 m/s

Example Problem 3

TWSC - UNSIGNALIZED INTERSECTIONS WORKSHEET								
Worksheet 3								
General Information								
Project Description <u>Example Problem 3</u>								
Lane Designation								
Movements	Lane 1	Lane 2	Lane 3	Grade, G	Right Turn Channelized?			
1, 2, 3	1	2	2, 3	0	N			
4, 5, 6	4	5	5, 6	0	N			
7, 8, 9	7, 8, 9			0	N			
10, 11, 12	10, 11, 12			0	N			
Flared Minor-Street Approach								
Movement 9	<input checked="" type="checkbox"/> Yes	<input type="checkbox"/> No	Storage space, n	$\frac{1}{\text{(number of vehicles)}}$				
Movement 12	<input checked="" type="checkbox"/> Yes	<input type="checkbox"/> No	Storage space, n	$\frac{1}{\text{(number of vehicles)}}$				
Median Storage*								
* Includes raised or striped median (RM), or two-way left-turn lane (TWLTL)								
Type								
Movements 7 and 8	<input checked="" type="checkbox"/> Yes	<u>RM</u>	<input type="checkbox"/> No	Storage space, m	$\frac{2}{\text{(number of vehicles)}}$			
Movements 10 and 11	<input checked="" type="checkbox"/> Yes	<u>RM</u>	<input type="checkbox"/> No	Storage space, m	$\frac{2}{\text{(number of vehicles)}}$			
Upstream Signals								
	Movements	Distance to Signal, D (m)	Prog Speed, S _{prog} (km/h)	Cycle Length, C (s)	Green Time, g _{eff} (s)	Arrival Type	Saturation Flow Rate, s (veh/h)	Progressed Flow, V _{prog} (veh/h)
S ₂	protected LT					3		
	TH							
S ₅	protected LT					3		
	TH							
Computing Delay to Major-Street Vehicles								
Data for Computing Effect of Delay to Major-Street Vehicles				S ₂ Approach		S ₅ Approach		
Shared-lane volume, major-street through vehicles, v ₁₁ , blocked by LT								
Shared-lane volume, major-street right-turn vehicles, v ₁₂ , blocked by LT								
Saturation flow rate, major-street through vehicles, s ₁₁								
Saturation flow rate, major-street right-turn vehicles, s ₁₂								
Number of major-street through lanes								
Length of study period, T (h)								

TWSC - UNSIGNALIZED INTERSECTIONS WORKSHEET								
Worksheet 4								
General Information								
Project Description <u>Example Problem 3</u>								
Critical Gap and Follow-Up Time								
$t_c = t_{c,base} + t_{c,HV} P_{HV} + t_{c,G} G - t_{c,T} - t_{3,LT}$								
	Major LT		Minor RT		Minor TH		Minor LT	
Movement	1	4	9	12	8	11	7	10
$t_{c,base}$ (Exhibit 17-5)	4.1	4.1	6.9	6.9	6.5	6.5	7.5	7.5
$t_{c,HV}$	2.0	2.0	2.0	2.0	2.0	2.0	2.0	2.0
P_{HV} (from Worksheet 2)	0.10	0.10	0.10	0.10	0.10	0.10	0.10	0.10
$t_{c,G}$	-	-	0.1	0.1	0.2	0.2	0.2	0.2
G (from Worksheet 3)	0	0	0	0	0	0	0	0
$t_{3,LT}$	0.0	0.0	0.0	0.0	0.0	0.0	0.0	0.0
$t_{c,T}$	single stage	0.0	0.0	0.0	0.0	0.0	0.0	0.0
	two stage	-	-	-	-	1.0	1.0	1.0
t_c (Equation 17-1)	single stage	4.300	4.300	7.100	7.100	6.700	6.700	7.700
	two stage	-	-	-	-	5.700	5.700	6.700
$t_f = t_{f,base} + t_{f,HV} P_{HV}$								
	Major LT		Minor RT		Minor TH		Minor LT	
Movement	1	4	9	12	8	11	7	10
$t_{f,base}$ (Exhibit 17-5)	2.2	2.2	3.3	3.3	4.0	4.0	3.5	3.5
$t_{f,HV}$	1.0	1.0	1.0	1.0	1.0	1.0	1.0	1.0
P_{HV} (from Worksheet 2)	0.10	0.10	0.10	0.10	0.10	0.10	0.10	0.10
t_f (Equation 17-2)	2.300	2.300	3.400	3.400	4.100	4.100	3.600	3.600
Worksheet 5a								
Time to Clear Standing Queue (Computation 1)								
	Movement 2				Movement 5			
	$v_{T,prog}$	$v_{L,prot}$	$v_{T,prog}$	$v_{L,prot}$	$v_{T,prog}$	$v_{L,prot}$	$v_{T,prog}$	$v_{L,prot}$
Effective green, g_{eff} (s)								
Cycle length, C (s)								
Saturation flow rate, s (veh/h)								
Arrival type			3				3	
v_{prog} (veh/h)								
R_p (from Chapter 16)			1.00				1.00	
Proportion of vehicles arriving on green, P (Equation 17-17)								
g_{q1} (Equation 17-18)								
g_{q2} (Equation 17-19)								
g_q (Equation 17-20)								

Example Problem 3

TWSC - UNSIGNALIZED INTERSECTIONS WORKSHEET		
Worksheet 6		
General Information		
Project Description <u>Example Problem 3</u>		
Impedance and Capacity Calculation		
Step 1: RT from Minor Street	v_9	v_{12}
Conflicting flows (Exhibit 17-4)	$v_{c,9} = 150$	$v_{c,12} = 200$
Potential capacity (Equation 17-3 or 17-29)	$c_{p,9} = 845$	$c_{p,12} = 783$
Ped impedance factor (Equation 17-12)	$p_{p,9} = 1.000$	$p_{p,12} = 1.000$
Movement capacity (Equation 17-4)	$c_{m,9} = c_{p,9} p_{p,9} = 845$	$c_{m,12} = c_{p,12} p_{p,12} = 783$
Prob of queue-free state (Equation 17-5)	$p_{0,9} = 0.935$	$p_{0,12} = 0.964$
Step 2: LT from Major Street	v_4	v_1
Conflicting flows (Exhibit 17-4)	$v_{c,4} = 300$	$v_{c,1} = 400$
Potential capacity (Equation 17-3 or 17-29)	$c_{p,4} = 1202$	$c_{p,1} = 1100$
Ped impedance factor (Equation 17-12)	$p_{p,4} = 1.000$	$p_{p,1} = 1.000$
Movement capacity (Equation 17-4)	$c_{m,4} = c_{p,4} p_{p,4} = 1202$	$c_{m,1} = c_{p,1} p_{p,1} = 1100$
Prob of queue-free state (Equation 17-5)	$p_{0,4} = 0.945$	$p_{0,1} = 0.970$
Major left shared lane prob of queue-free state (Equation 17-16)	$p_{0,4}^* =$	$p_{0,1}^* =$
Step 3: TH from Minor Street (4-leg intersections only)	v_8	v_{11}
Conflicting flows (Exhibit 17-4)	$v_{c,8} =$	$v_{c,11} =$
Potential capacity (Equation 17-3 or 17-29)	$c_{p,8} =$	$c_{p,11} =$
Ped impedance factor (Equation 17-12)	$p_{p,8} =$	$p_{p,11} =$
Capacity adjustment factor due to impeding movement (shared lane use p^*) (Equation 17-13)	$f_8 = p_{0,4} p_{0,1} p_{p,8} =$	$f_{11} = p_{0,4} p_{0,1} p_{p,11} =$
Movement capacity (Equation 17-7)	$c_{m,8} = c_{p,8} f_8 =$	$c_{m,11} = c_{p,11} f_{11} =$
Prob of queue-free state	$p_{0,8} =$	$p_{0,11} =$
Step 4: LT from Minor Street (4-leg intersections only)	v_7	v_{10}
Conflicting flows (Exhibit 17-4)	$v_{c,7} =$	$v_{c,10} =$
Potential capacity (Equation 17-3 or 17-29)	$c_{p,7} =$	$c_{p,10} =$
Ped impedance factor (Equation 17-12)	$p_{p,7} =$	$p_{p,10} =$
Major left, minor through impedance factor	$p_{p,7}^* = p_{0,11} f_{11} =$	$p_{p,10}^* = p_{0,8} f_8 =$
Major left, minor through adjusted impedance factor (Equation 17-8)	$p_{p,7}^* =$	$p_{p,10}^* =$
Capacity adjustment factor due to impeding movements (Equation 17-14)	$f_7 = p_{p,7}^* p_{0,12} p_{p,7} =$	$f_{10} = p_{p,10}^* p_{0,9} p_{p,10} =$
Movement capacity (Equation 17-10)	$c_{m,7} = f_7 c_{p,7} =$	$c_{m,10} = f_{10} c_{p,10} =$
Step 5: LT from Minor Street (T-intersections only)	v_7	v_{10}
Conflicting flows (Exhibit 17-4)	$v_{c,7} =$	$v_{c,10} =$
Potential capacity (Equation 17-3 or 17-29)	$c_{p,7} =$	$c_{p,10} =$
Ped impedance factor (Equation 17-12)	$p_{p,7} =$	$p_{p,10} =$
Capacity adjustment factor due to impeding movement (shared lane use p^*) (Equation 17-13)	$f_7 = p_{0,4} p_{0,1} p_{p,7} =$	$f_{10} = p_{0,4} p_{0,1} p_{p,10} =$
Movement capacity (Equation 17-7)	$c_{m,7} = c_{p,7} f_7 =$	$c_{m,10} = c_{p,10} f_{10} =$
Notes		
1. For 4-leg intersections use Steps 1, 2, 3, and 4.		
2. For T-intersections use Steps 1, 2, and 5.		

TWSC - UNSIGNALIZED INTERSECTIONS WORKSHEET		
Worksheet 7a		
General Information		
Project Description <u>Example Problem 3</u>		
Effect of Two-Stage Gap Acceptance		
Step 3: TH from Minor Street	V_8	V_{11}
Part I - First Stage		
Conflicting flows (Exhibit 17-4)	$V_{c,I,8} = 341$	$V_{c,I,11} = 482$
Potential capacity (Equation 17-3 or 17-29)	$C_{p,I,8} = 618$	$C_{p,I,11} = 532$
Ped impedance factor (Equation 17-12)	$P_{p,I,8} = 1.000$	$P_{p,I,11} = 1.000$
Capacity adjustment factor due to impeding movement (shared lane use p*) (Equation 17-6 or 17-13)	$f_{I,8} = P_{0,1} P_{p,I,8} = 0.970$	$f_{I,11} = P_{0,4} P_{p,I,11} = 0.945$
Movement capacity (Equation 17-7)	$C_{m,I,8} = C_{p,I,8} f_{I,8} = 599$	$C_{m,I,11} = C_{p,I,11} f_{I,11} = 503$
Prob of queue-free state (Equation 17-5)	$P_{0,I,8} = 0.780$	$P_{0,I,11} = 0.781$
Part II - Second Stage		
Conflicting flows (Exhibit 17-4)	$V_{c,II,8} = 532$	$V_{c,II,11} = 366$
Potential capacity (Equation 17-3 or 17-29)	$C_{p,II,8} = 504$	$C_{p,II,11} = 601$
Ped impedance factor (Equation 17-12)	$P_{p,II,8} = 1.000$	$P_{p,II,11} = 1.000$
Capacity adjustment factor due to impeding movement (shared lane use p*) (Equation 17-6 or 17-13)	$f_{II,8} = P_{0,4} P_{p,II,8} = 0.945$	$f_{II,11} = P_{0,1} P_{p,II,11} = 0.970$
Movement capacity (Equation 17-7)	$C_{m,II,8} = C_{p,II,8} f_{II,8} = 476$	$C_{m,II,11} = C_{p,II,11} f_{II,11} = 583$
Prob of queue-free state (Equation 17-5)	$P_{0,II,8} = 0.723$	$P_{0,II,11} = 0.811$
Part III - Single Stage		
Conflicting flows (Exhibit 17-4)	$V_{c,8} = 873$	$V_{c,11} = 848$
Potential capacity (Equation 17-3 or 17-29)	$C_{p,8} = 273$	$C_{p,11} = 283$
Ped impedance factor (Equation 17-12)	$P_{p,8} = 1.000$	$P_{p,11} = 1.000$
Capacity adjustment factor due to impeding movement (shared lane use p*) (Equation 17-13 or 17-16)	$f_8 = P_{0,4} P_{0,1} P_{p,8} = 0.917$	$f_{11} = P_{0,4} P_{0,1} P_{p,11} = 0.917$
Movement capacity (Equation 17-7)	$C_{m,8} = C_{p,8} f_8 = 250$	$C_{m,11} = C_{p,11} f_{11} = 260$
Result for Two-Stage Process		
a (Equation 17-30)	a = 0.949	a = 0.949
y (Equation 17-31)	y = 1.808	y = 0.946
C_T (Equation 17-32 or 17-33)	$C_T = 390$	$C_T = 405$
Prob of queue-free state (Equation 17-5)	$P_{0,8} = 0.662$	$P_{0,11} = 0.728$

Example Problem 3

TWSC - UNSIGNALIZED INTERSECTIONS WORKSHEET		
Worksheet 7b		
General Information		
Project Description <u>Example Problem 3</u>		
Effect of Two-Stage Gap Acceptance		
Step 4: LT from Minor Street	v_7	v_{10}
Part I - First Stage		
Conflicting flows (Exhibit 17-4)	$v_{c,1,7} = 341$	$v_{c,1,10} = 482$
Potential capacity (Equation 17-3 or 17-29)	$C_{p,1,7} = 626$	$C_{p,1,10} = 514$
Ped impedance factor (Equation 17-12)	$P_{p,1,7} = 1.000$	$P_{p,1,10} = 1.000$
Capacity adjustment factor due to impeding movements	$f_{1,7} = P_{0,1} P_{p,1,7} = 0.970$	$f_{1,10} = P_{0,4} P_{p,1,10} = 0.945$
Movement capacity (Equation 17-7)	$C_{m,1,7} = f_{1,7} C_{p,1,7} = 607$	$C_{m,1,10} = f_{1,10} C_{p,1,10} = 486$
Part II - Second Stage		
Conflicting flows (Exhibit 17-4)	$v_{c,II,7} = 337$	$v_{c,II,10} = 257$
Potential capacity (Equation 17-3 or 17-29)	$C_{p,II,7} = 629$	$C_{p,II,10} = 703$
Ped impedance factor (Equation 17-12)	$P_{p,II,7} = 1.000$	$P_{p,II,10} = 1.000$
Capacity adjustment factor due to impeding movements	$f_{II,7} = P_{0,4} P_{0,1,11} P_{0,12} P_{p,II,7} = 0.711$	$f_{II,10} = P_{0,1} P_{0,1,8} P_{0,9} P_{p,II,10} = 0.707$
Movement capacity (Equation 17-7)	$C_{m,II,7} = f_{II,7} C_{p,II,7} = 447$	$C_{m,II,10} = f_{II,10} C_{p,II,10} = 497$
Part III - Single-Stage		
Conflicting flows (Exhibit 17-4)	$v_{c,7} = 678$	$v_{c,10} = 739$
Potential capacity (Equation 17-3 or 17-29)	$C_{p,7} = 323$	$C_{p,10} = 291$
Ped impedance factor (Equation 17-12)	$P_{p,7} = 1.000$	$P_{p,10} = 1.000$
Major left, minor through impedance factor	$P_7^* = P_{0,11} f_{11} = 0.668$	$P_{10}^* = P_{0,8} f_8 = 0.607$
Major left, minor through adjusted impedance factor (Equation 17-8)	$P_7^{\dagger} = 0.742$	$P_{10}^{\dagger} = 0.694$
Capacity adjustment factor due to impeding movements (Equation 17-9 or 17-14)	$f_7 = P_7^{\dagger} P_{0,12} P_{p,7} = 0.715$	$f_{10} = P_{10}^{\dagger} P_{0,9} P_{p,10} = 0.649$
Movement capacity (Equation 17-7)	$C_{m,7} = f_7 C_{p,7} = 231$	$C_{m,10} = f_{10} C_{p,10} = 189$
Result for Two-Stage Process		
a (Equation 17-30)	a = 0.949	a = 0.949
y (Equation 17-31)	y = 2.055	y = 1.227
c_T (Equation 17-32 or 17-33)	$c_T = 369$	$c_T = 347$

TWSC - UNSIGNALIZED INTERSECTIONS WORKSHEET						
Worksheet 8						
General Information						
Project Description <u>Example Problem 3</u>						
Shared-Lane Capacity						
$C_{SH} = \frac{\sum y V_y}{\sum y \left(\frac{V_y}{C_{m,y}} \right)}$ (Equation 17-15)						
Movement	v (veh/h)	C_m (veh/h)	C_{SH} (veh/h)			
7	44	369	442			
8	132	390				
9	55	845				
10	11	347	439			
11	110	405				
12	28	783				
Worksheet 9						
Effect of Flared Minor-Street Approaches						
	Movement 7	Movement 8	Movement 9	Movement 10	Movement 11	Movement 12
C_{sep} (from Worksheet 6 or 7)	369	390	845	347	405	783
Volume (from Worksheet 2)	44	132	55	11	110	28
Delay (Equation 17-38)	16.070	18.881	9.557	15.714	17.171	9.768
Q_{sep} (Equation 17-34)	0.196	0.692	0.146	0.048	0.525	0.076
$Q_{sep} + 1$	1.196	1.692	1.146	1.048	1.525	1.076
Round ($Q_{sep} + 1$)	1	2	1	1	2	1
n_{max} (Equation 17-35)	2			2		
C_{SH}	442			439		
C_{sep}	1604			1535		
n	1			1		
C_{act} (Equation 17-36)	1023			987		

Example Problem 3

TWSC - UNSIGNALIZED INTERSECTIONS WORKSHEET							
Worksheet 10							
General Information							
Project Description <u>Example Problem 3</u>							
Control Delay, Queue Length, Level of Service							
Lane	v (veh/h)	c _m (veh/h)	v/c	Queue Length (Equation 17-37)	Control Delay (Equation 17-38)	LOS (Exhibit 17-2)	Delay and LOS
1 (X)(X)(X)	231	1024	0.226	< 1	9.5	A	9.5 A
2 (7)(8)(9)							
3 (7)(8)(9)							
1 (10)(11)(12)	149	987	0.151	< 1	9.3	A	9.3 A
2 (10)(11)(12)							
3 (10)(11)(12)							
Movement	v (veh/h)	c _m (veh/h)	v/c	Queue Length (Equation 17-37)	Control Delay (Equation 17-38)	LOS (Exhibit 17-2)	
1	33	1100	0.030	< 1	8.4	A	
4	66	1216	0.055	< 1	8.2	A	
Worksheet 11							
Delay to Rank 1 Vehicles							
	S ₂ Approach			S ₅ Approach			
p _{0,j} (Equation 17-5)	p _{0,1} =			p _{0,4} =			
v ₁₁ , volume for Stream 2 or 5							
v ₁₂ , volume for Stream 3 or 6							
s ₁₁ , saturation flow rate for Stream 2 or 5							
s ₁₂ , saturation flow rate for Stream 3 or 6							
p _{0,j} [*] (Equation 17-16)	p _{0,1} [*] =			p _{0,4} [*] =			
d _{major left} , delay for Stream 1 or 4							
N, number of major-street through lanes							
d _{Rank 1} , delay for Stream 2 or 5 (Equation 17-39)							

EXAMPLE PROBLEM 4

The Intersection An AWSC T-intersection with one lane on each approach.

The Question What are the delay and level of service?

The Facts

- √ Two two-lane streets, and
- √ No heavy vehicles.

Comments The use of spreadsheet software is recommended because of the repetitive computations required. The degree of utilization, x , computed in each iteration is used to determine the departure headway of the next iteration. Slight differences in estimated headways may result from rounding differences in manual (handheld calculator) computations or from rounding differences between manual and software computations.

Outline to Solution The steps below show the southbound approach calculations only. Calculations for other approaches are shown on the worksheets.

Steps

<p>1. Data input and volume adjustments.</p>	<p>Worksheets 1 and 2</p> $v_x = \frac{\text{Volume}}{\text{PHF}}$ $v_{SB} = \frac{100}{1.00} = 100 \text{ veh/h}$
<p>2. Saturation headway adjustment factor (use Equation 17-56).</p>	<p>Worksheet 3</p> $h_{adj} = h_{LT-adj} P_{LT} + h_{RT-adj} P_{RT} + h_{HV-adj} P_{HV}$ $SB \ h_{adj} = (0.2)0.67 + (-0.6)0.333 + (1.7)0 = -0.066$
<p>3. Departure headway, service time, probability status, and saturation headway.</p> <p>Probability state for case-conflict combinations (use Equation 17-58 and Exhibit 17-26).</p> <p>Probability of degree-of-conflict cases (use Equations 17-47 through 17-51).</p> <p>Probability adjustment factors (use Equations 17-64 through 17-68).</p> <p>Adjusted probability (use Equation 17-69).</p> <p>Saturation headway.</p> <p>Departure headway (use Equation 17-54).</p>	<p>Worksheets 4a and 4b</p> <p>Since a NB approach does not exist, its volume is 0. Hence, its probability of a vehicle present, $P(a = 1)$, is also 0. Worksheet 4b is used to determine the departure headway. For each iteration, a separate worksheet is required for each lane. In total, three worksheets are required for this intersection with one-lane approaches.</p> $P(i) = \prod_j P(a_j)$ $P(1) = P(a_{01}) P(a_{CL1}) P(a_{CR1})$ $P(1) = (1.000) (0.644)(0.689) = 0.444$ $P(C_1) = P(1) = 0.444$ $\text{Adj}P(1) = \alpha [P(C_2) + 2P(C_3) + 3P(C_4) + 4P(C_5)]/n$ $\text{Adj}P(1) = 0.012$ <p>n varies from case to case and from approach to approach. It is the number of conflict combinations in each case.</p> $P'(i) = P(i) + \text{Adj}P(i)$ $P'(1) = 0.444 + 0.012 = 0.456$ $h_{si} = h_{adj} + h_{base}$ $h_{si} = -0.066 + 3.9 = 3.834$ $SB \ h_d = \sum_{i=1}^{64} P'(i) h_{si} = 4.954$

<p>3. (continued) Repeat the process until the change in headways between two successive iterations is less than 0.100 s.</p>	
<p>4. Service time and capacity (use Equation 17-53). Capacity is determined by increasing the subject lane volume while holding other volumes constant. The capacity is reached when $x = 1.000$. Control delay and LOS (use Equation 17-55 and Exhibit 17-19). The intersection delay is the weighted average of individual delays.</p>	<p>Worksheet 5 $s = h_d - m$ SB $s = 5.39 - 2.00 = 3.39$ s $d = s + 900T[...] + 5$ SB $d = 3.47 + 900(0.25)[...] + 5 = 10.1$ s, LOS B</p>

AWSC - UNSIGNALIZED INTERSECTIONS WORKSHEET

Worksheet 1

General Information		Site Information	
Analyst	<u>ETA</u>	Intersection	<u>Sixth/Line</u>
Agency or Company	<u>CEI</u>	Jurisdiction	<u>Latah County</u>
Date Performed	<u>5/21/99</u>	Analysis Year	<u>1999</u>
Analysis Time Period	<u>AM Peak</u>		

Geometrics and Movements

Data Required:
Vehicle volumes by movement
Proportion of heavy vehicles

Length of study period = 0.25 h

Worksheet 2

Volume Adjustments and Lane Assignments

Approach		Lane 1			Lane 2			Geometry Group (Exhibit 17-29)
		LT	TH	RT	LT	TH	RT	
EB	Volume (veh/h)	50	300					1
	PHF	1.00						
	% Heavy vehicle	0	0					
	Flow rate (veh/h)	50	300					
WB	Volume (veh/h)		300	100				1
	PHF	1.00						
	% Heavy vehicle		0	0				
	Flow rate (veh/h)		300	100				
NB	Volume (veh/h)							
	PHF							
	% Heavy vehicle							
	Flow rate (veh/h)							
SB	Volume (veh/h)	100		50				1
	PHF	1.00						
	% Heavy vehicle	0		0				
	Flow rate (veh/h)	100		50				

Example Problem 4

AWSC - UNSIGNALIZED INTERSECTIONS WORKSHEET								
Worksheet 3								
General Information								
Project Description	Example Problem 4							
Saturation Headways								
	EB		WB		NB		SB	
	L1	L2	L1	L2	L1	L2	L1	L2
Total lane flow rate	350		400				150	
Left-turn flow rate in lane	50		0				100	
Right-turn flow rate in lane	0		100				50	
Proportion LT in lane	0.143		0.000				0.667	
Proportion RT in lane	0.000		0.250				0.333	
Proportion HV in lane	0		0				0	
h_{LT-adj} (Exhibit 17-33)	0.2		0.2				0.2	
h_{RT-adj} (Exhibit 17-33)	-0.6		-0.6				-0.6	
h_{HV-adj} (Exhibit 17-33)	1.7		1.7				1.7	
h_{adj} (Equation 17-56)	0.029		-0.150				-0.066	
Worksheet 4a								
Departure Headway								
	EB		WB		NB		SB	
	L1	L2	L1	L2	L1	L2	L1	L2
Total lane flow rate	350		400				150	
h_d , initial value (s)	3.2	3.2	3.2	3.2	3.2	3.2	3.2	3.2
x , initial value (Equation 17-57)	0.311		0.356				0.133	
h_d , Iteration 1	4.472		4.261				4.954	
h_d , difference	1.272		1.061				1.754	
h_d , Iteration 2	4.715		4.499				5.318	
h_d , difference	0.243		0.238				0.364	
h_d , Iteration 3	4.773		4.555				5.390	
h_d , difference	0.058		0.056				0.072	
h_d , Iteration 4								
h_d , difference								
h_d , Iteration 5								
h_d , difference								
Convergence?	Y		Y				Y	
h_d , final	4.773		4.555				5.390	
x , final	0.464		0.506				0.225	

Example Problem 4

AWSC - UNSIGNALIZED INTERSECTIONS WORKSHEET												
Worksheet 4b												
Project Description <u>Example Problem 4, SB Iteration 1</u>												
Service Time												
i	P(a _{n1})	P(a _{n2})	P(a _{c11})	P(a _{c12})	P(a _{cR1})	P(a _{cR2})	P(i)	Adj P(i)	P'(i)	h _{base}	h _{adj}	h _{sl}
1	1.000		0.644		0.689		0.444	0.012	0.456	3.9	-0.066	3.834
2	0.000		0.644		0.689		0.000					
3												
4												
5												
6	1.000		0.356		0.689		0.245	-0.006	0.239	5.8	-0.066	5.734
7	1.000		0.644		0.311		0.200	-0.006	0.194	5.8	-0.066	5.734
8												
9												
10												
11												
12												
13	1.000		0.356		0.311		0.111	-0.007	0.104	7.0	-0.066	6.934
14												
15												
16	0.000		0.356		0.689		0.000					
17												
18												
19												
20												
21	0.000		0.644		0.311		0.000					
22												
23												
24												
25												
26												
27												
28												
29												
30												
31												
32												
33												
34												
35												
36												
37												
38												
39												
40												
41												
42												
43												
44												
45												
46												
47												
48												
49												
50												
51												
52												
53												
54												
55												
56												
57												
58												
59												
60												
61												
62												
63												
64	0.000		0.356		0.311		0.000					

Example Problem 4

Iteration 1										
SBL1										
i	P(a _{opp1})	P(a _{CL1})	P(a _{CR1})	P(i)	Adj P(i)	P'(i)	h _{base}	h _{adj}	h _{si}	P'(i)*h _{si}
1	1.000	0.644	0.689	0.444	0.012	0.456	3.900	-0.066	3.834	1.748
2	0.000	0.644	0.689	0.000						
6	1.000	0.356	0.689	0.245	-0.006	0.239	5.800	-0.066	5.734	1.371
7	1.000	0.644	0.311	0.200	-0.006	0.194	5.800	-0.066	5.734	1.113
13	1.000	0.356	0.311	0.111	-0.007	0.104	7.000	-0.066	6.934	0.722
16	0.000	0.356	0.689	0.000						
21	0.000	0.644	0.311	0.000						
64	0.000	0.356	0.311	0.000						
									h _d	4.954

EBL1										
i	P(a _{opp1})	P(a _{CL1})	P(a _{CR1})	P(i)	Adj P(i)	P'(i)	h _{base}	h _{adj}	h _{si}	P'(i)*h _{si}
1	0.644	0.867	1.000	0.558	0.006	0.565	3.900	0.029	3.929	2.218
2	0.356	0.867	1.000	0.309	-0.001	0.307	4.700	0.029	4.729	1.454
6	0.644	0.133	1.000	0.086	-0.002	0.084	5.800	0.029	5.829	0.487
7	0.644	0.867	0.000	0.000						
13	0.644	0.133	0.000	0.000						
16	0.356	0.133	1.000	0.047	-0.003	0.045	7.000	0.029	7.029	0.313
21	0.356	0.867	0.000	0.000						
64	0.356	0.133	0.000	0.000						
									h _d	4.472

WBL1										
i	P(a _{opp1})	P(a _{CL1})	P(a _{CR1})	P(i)	Adj P(i)	P'(i)	h _{base}	h _{adj}	h _{si}	P'(i)*h _{si}
1	0.689	1.000	0.867	0.597	0.006	0.603	3.900	-0.150	3.750	2.263
2	0.311	1.000	0.867	0.270	-0.001	0.269	4.700	-0.150	4.550	1.222
6	0.689	0.000	0.867	0.000						
7	0.689	1.000	0.133	0.092	-0.002	0.090	5.800	-0.150	5.650	0.506
13	0.689	0.000	0.133	0.000						
16	0.311	0.000	0.867	0.000						
21	0.311	1.000	0.133	0.041	-0.002	0.039	7.000	-0.150	6.850	0.270
64	0.311	0.000	0.133	0.000						
									h _d	4.261

Example Problem 4

Iteration 2										
SBL1										
i	P(a _{opp1})	P(a _{CL1})	P(a _{CR1})	P(i)	Adj P(i)	P'(i)	h _{base}	h _{adj}	h _{si}	P'(i)*h _{si}
1	1.000	0.527	0.565	0.298	0.016	0.314	3.900	-0.066	3.834	1.203
2	0.000	0.527	0.565	0.000						
6	1.000	0.473	0.565	0.267	-0.006	0.261	5.800	-0.066	5.734	1.496
7	1.000	0.527	0.435	0.229	-0.006	0.223	5.800	-0.066	5.734	1.278
13	1.000	0.473	0.435	0.206	-0.012	0.193	7.000	-0.066	6.934	1.341
16	0.000	0.473	0.565	0.000						
21	0.000	0.527	0.435	0.000						
64	0.000	0.473	0.435	0.000						
									h _d	5.318

EBL1										
i	P(a _{opp1})	P(a _{CL1})	P(a _{CR1})	P(i)	Adj P(i)	P'(i)	h _{base}	h _{adj}	h _{si}	P'(i)*h _{si}
1	0.527	0.794	1.000	0.418	0.009	0.427	3.900	0.029	3.929	1.679
2	0.473	0.794	1.000	0.376	-0.001	0.375	4.700	0.029	4.729	1.773
6	0.527	0.206	1.000	0.109	-0.002	0.106	5.800	0.029	5.829	0.620
7	0.527	0.794	0.000	0.000						
13	0.527	0.206	0.000	0.000						
16	0.473	0.206	1.000	0.097	-0.006	0.092	7.000	0.029	7.029	0.644
21	0.473	0.794	0.000	0.000						
64	0.473	0.206	0.000	0.000						
									h _d	4.715

WBL1										
i	P(a _{opp1})	P(a _{CL1})	P(a _{CR1})	P(i)	Adj P(i)	P'(i)	h _{base}	h _{adj}	h _{si}	P'(i)*h _{si}
1	0.565	1.000	0.794	0.449	0.008	0.457	3.900	-0.150	3.750	1.712
2	0.435	1.000	0.794	0.345	-0.001	0.344	4.700	-0.150	4.550	1.567
6	0.565	0.000	0.794	0.000						
7	0.565	1.000	0.206	0.116	-0.003	0.113	5.800	-0.150	5.650	0.641
13	0.565	0.000	0.206	0.000						
16	0.435	0.000	0.794	0.000						
21	0.435	1.000	0.206	0.090	-0.005	0.085	7.000	-0.150	6.850	0.580
64	0.435	0.000	0.206	0.000						
									h _d	4.499

Example Problem 4

Iteration 3										
SBL1										
i	P(a _{opp1})	P(a _{CL1})	P(a _{CR1})	P(i)	Adj P(i)	P'(i)	h _{base}	h _{adj}	h _{si}	P'(i)*h _{si}
1	1.000	0.5	0.542	0.271	0.017	0.288	3.900	-0.066	3.834	1.104
2	0.000	0.5	0.542	0.000						
6	1.000	0.5	0.542	0.271	-0.006	0.265	5.800	-0.066	5.734	1.517
7	1.000	0.5	0.458	0.229	-0.006	0.223	5.800	-0.066	5.734	1.277
13	1.000	0.5	0.458	0.229	-0.014	0.215	7.000	-0.066	6.934	1.493
16	0.000	0.5	0.542	0.000						
21	0.000	0.5	0.458	0.000						
64	0.000	0.5	0.458	0.000						
									h _d	5.390

EBL1										
i	P(a _{opp1})	P(a _{CL1})	P(a _{CR1})	P(i)	Adj P(i)	P'(i)	h _{base}	h _{adj}	h _{si}	P'(i)*h _{si}
1	0.500	0.778	1.000	0.389	0.006	0.395	3.900	0.029	3.929	1.550
2	0.500	0.778	1.000	0.389	0.003	0.392	4.700	0.029	4.729	1.855
6	0.500	0.222	1.000	0.111	-0.002	0.109	5.800	0.029	5.829	0.634
7	0.500	0.778	0.000	0.000						
13	0.500	0.222	0.000	0.000						
16	0.500	0.222	1.000	0.111	-0.007	0.104	7.000	0.029	7.029	0.733
21	0.500	0.778	0.000	0.000						
64	0.500	0.222	0.000	0.000						
									h _d	4.773

WBL1										
i	P(a _{opp1})	P(a _{CL1})	P(a _{CR1})	P(i)	Adj P(i)	P'(i)	h _{base}	h _{adj}	h _{si}	P'(i)*h _{si}
1	0.542	1.000	0.778	0.422	0.009	0.431	3.900	-0.150	3.750	1.615
2	0.458	1.000	0.778	0.356	0.000	0.356	4.700	-0.150	4.550	1.621
6	0.542	0.000	0.778	0.000						
7	0.542	1.000	0.222	0.120	-0.003	0.117	5.800	-0.150	5.650	0.663
13	0.542	0.000	0.222	0.000						
16	0.458	0.000	0.778	0.000						
21	0.458	1.000	0.222	0.102	-0.006	0.096	7.000	-0.150	6.850	0.655
64	0.458	0.000	0.222	0.000						
									h _d	4.555

AWSC - UNSIGNALIZED INTERSECTIONS WORKSHEET								
Worksheet 5								
General Information								
Project Description <u>Example Problem 4</u>								
Capacity and Level of Service								
	EB		WB		NB		SB	
	L1	L2	L1	L2	L1	L2	L1	L2
Total lane flow rate (veh/h)	350		400				150	
Departure headway, h_d (s)	4.772		4.555				5.393	
Degree of utilization, x	0.464		0.506				0.225	
Move-up time, m (s)	2.00		2.00				2.00	
Service time, t_s (s)	2.772		2.555				3.393	
Capacity (veh/h)	745		765				610	
Delay (s) (Equation 17-55)	11.8		12.1				9.9	
Level of service (Exhibit 17-22)	B		B				A	
Delay, approach (s/veh)	11.8		12.1				9.9	
Level of service, approach	B		B				A	
Delay, intersection (s/veh)	11.7							
Level of service, intersection	B							

EXAMPLE PROBLEM 5

The Intersection An AWSC intersection at four-lane streets. Both right-turn and left-turn lanes are shared.

The Question What are the delay and level of service?

The Facts

- √ Two four-lane urban streets, and
- √ No heavy vehicles.

Comments The use of spreadsheet software is recommended because of the repetitive computations required. The degree of utilization, x , computed in each iteration is used to determine the departure headway of the next iteration. Slight differences in estimated headways may result from rounding differences in manual (handheld calculator) computations or from rounding differences between manual and software computations.

Outline to Solution The steps below show the northbound approach calculations only. Calculations for other approaches are shown on the worksheets.

Steps

<p>1. Data input and volume adjustments.</p>	<p>Worksheets 1 and 2</p> <p>Hourly flow rate = $\frac{\text{Volume}}{\text{PHF}}$</p> <p>NB lane = $\frac{100}{1.00} = 100$ veh/h</p>
<p>2. Saturation headway adjustment factor (use Equation 17-56).</p>	<p>Worksheet 3</p> <p>$h_{adj} = h_{LT-adj} P_{LT} + h_{RT-adj} P_{RT} + h_{HV-adj} P_{HV}$</p> <p>NB Lane 1 $h_{adj} = 0.400(0.5) + 0 + 0 = 0.200$</p>
<p>3. Departure headway, service time, probability states, and saturation headway.</p> <p>Probability of each case-conflict combination (use Equation 17-58 and Exhibit 17-34).</p> <p>Probability of degree-of-conflict cases (use Equations 17-59 through 17-63).</p> <p>Probability adjustment factors (use Equations 17-64 through 17-68).</p> <p>Adjusted probability (use Equation 17-69).</p> <p>Saturation headway.</p> <p>Departure headway (use Equation 17-54).</p>	<p>Worksheets 4a and 4b</p> <p>This intersection has four approaches, and each approach has two lanes. In total, eight worksheets are needed for each iteration.</p> <p>$P(i) = \prod_j P(a_j)$</p> <p>$P(1) = P(a_{O1}) P(a_{O2}) P(a_{CL1}) P(a_{CL2}) P(a_{CR1}) P(a_{CR2})$</p> <p>$P(1) = (0.778)(0.778)(0.800)(0.800) (0.778)(0.778) = 0.234$</p> <p>$P(C_1) = P(1) = 0.234$</p> <p>$\text{Adj}P(1) = \alpha [P(C_2) + 2P(C_3) + 3P(C_4) + 4P(C_5)]/1$</p> <p>$\text{Adj}P(1) = 0.01[0.153 + 2(0.286) + 3(0.272) + 4(0.052)]/1 = 0.018$</p> <p>$P'(i) = P(i) + \text{Adj}P(i)$</p> <p>$P'(1) = 0.234 + 0.018 = 0.252$</p> <p>NB Lane 1 $h_{si} = h_{adj} + h_{base}$</p> <p>$h_{si} = 0.200 + 4.5 = 4.700$</p> <p>NB Lane 1 $h_d = \sum_{i=1}^{64} P^{\circ}(i) h_{si} = 6.435$</p>

<p>3. (continued) Repeat the process until the change in headways between two successive iterations is less than 0.100 s.</p>	
<p>4. Service time and capacity (use Equation 17-53). Capacity is determined by increasing the subject lane volume while holding other volumes constant. Capacity is reached when $x = 1.000$. Control delay and LOS (use Equation 17-55 and Exhibit 17-19). The approach delay is the weighted average of lane delays, while the intersection delay is the weighted average of approach delays.</p>	<p>$t_s = h_d - m$ NB Lane 1 $s = 8.686 - 2.30 = 6.386$ s</p> <p>$d = t_s + 900T[...] + 5$ NB Lane 1 $d = 6.41 + 900(0.25)[...] + 5 = 23.9$ s, LOS C</p>

Example Problem 5

AWSC - UNSIGNALIZED INTERSECTIONS WORKSHEET

Worksheet 1

General Information		Site Information	
Analyst	<u>JMS</u>	Intersection	<u>Eighth/Sixteenth</u>
Agency or Company	<u>CEI</u>	Jurisdiction	<u>Latah County</u>
Date Performed	<u>5/21/99</u>	Analysis Year	<u>1999</u>
Analysis Time Period	<u>AM Peak</u>		

Geometrics and Movements

Data Required:
 Vehicle volumes by movement
 Proportion of heavy vehicles

Length of study period = 0.25 h

Worksheet 2

Volume Adjustments and Lane Assignments

Approach		Lane 1			Lane 2			Geometry Group (Exhibit 17-29)
		LT	TH	RT	LT	TH	RT	
EB	Volume (veh/h)	100	125			175	50	5
	PHF	1.00			1.00			
	% Heavy vehicle	0	0			0	0	
	Flow rate (veh/h)	100	125			175	50	
WB	Volume (veh/h)	100	150			150	100	5
	PHF	1.00			1.00			
	% Heavy vehicle	0	0			0	0	
	Flow rate (veh/h)	100	150			150	100	
NB	Volume (veh/h)	100	150			200	50	5
	PHF	1.00			1.00			
	% Heavy vehicle	0	0			0	0	
	Flow rate (veh/h)	100	150			200	50	
SB	Volume (veh/h)	50	200			100	150	5
	PHF	1.00			1.00			
	% Heavy vehicle	0	0			0	0	
	Flow rate (veh/h)	50	200			100	150	

AWSC - UNSIGNALIZED INTERSECTIONS WORKSHEET								
Worksheet 3								
General Information								
Project Description <u>Example Problem 5</u>								
Saturation Headways								
	EB		WB		NB		SB	
	L1	L2	L1	L2	L1	L2	L1	L2
Total lane flow rate	225	225	250	250	250	250	250	250
Left-turn flow rate in lane	100	0	100	0	100	0	50	0
Right-turn flow rate in lane	0	50	0	100	0	50	0	150
Proportion LT in lane	0.444	0.000	0.400	0.000	0.400	0.000	0.200	0.000
Proportion RT in lane	0.000	0.222	0.000	0.400	0.000	0.200	0.000	0.600
Proportion HV in lane	0	0	0	0	0	0	0	0
h_{LT-adj} (Exhibit 17-33)	0.5	0.5	0.5	0.5	0.5	0.5	0.5	0.5
h_{RT-adj} (Exhibit 17-33)	-0.7	-0.7	-0.7	-0.7	-0.7	-0.7	-0.7	-0.7
h_{HV-adj} (Exhibit 17-33)	1.7	1.7	1.7	1.7	1.7	1.7	1.7	1.7
h_{adj} (Equation 17-56)	0.222	-0.155	0.200	-0.280	0.2000	-0.140	0.100	-0.420
Worksheet 4a								
Departure Headway								
	EB		WB		NB		SB	
	L1	L2	L1	L2	L1	L2	L1	L2
Total lane flow rate	225	225	250	250	250	250	250	250
h_g , initial value (s)	3.2	3.2	3.2	3.2	3.2	3.2	3.2	3.2
x , initial value (Equation 17-57)	0.200	0.200	0.222	0.222	0.222	0.222	0.222	0.222
h_g , Iteration 1	6.521	6.144	6.461	5.954	6.435	6.094	6.334	5.814
h_g , difference	3.321	2.944	3.261	2.754	3.235	2.894	3.134	2.614
h_g , Iteration 2	7.868	7.491	7.846	7.366	7.846	7.506	7.746	7.226
h_g , difference	1.347	1.347	1.385	1.412	1.411	1.412	1.412	1.412
h_g , Iteration 3	8.424	8.047	8.402	7.922	8.402	8.062	8.302	7.782
h_g , difference	0.556	0.556	0.556	0.556	0.556	0.556	0.556	0.556
h_g , Iteration 4	8.632	8.255	8.61	8.13	8.610	8.270	8.510	7.990
h_g , difference	0.208	0.208	0.208	0.208	0.208	0.208	0.208	0.208
h_g , Iteration 5	8.708	8.331	8.686	8.206	8.686	8.346	8.586	8.066
h_g , difference	0.076	0.076	0.076	0.076	0.076	0.076	0.076	0.076
Convergence?	Y	Y	Y	Y	Y	Y	Y	Y
h_g , final	8.708	8.331	8.686	8.206	8.686	8.346	8.586	8.066
x , final	0.544	0.521	0.603	0.570	0.603	0.580	0.596	0.560

Example Problem 5

EBL1 - ITERATION 1

	$P(a_{ol1})$	$P(a_{ol2})$	$P(a_{cl1})$	$P(a_{cl2})$	$P(a_{cr1})$	$P(a_{cr2})$	$P(i)$	Adj $P(i)$	$P'(i)$	h_{base}	h_{adj}	h_{sl}	$P'(i)*h_{sl}$
1	0.778	0.778	0.778	0.778	0.778	0.778	0.221757	0.018178	0.239935	4.5	0.222	4.722	1.132973
2	0.222	0.778	0.778	0.778	0.778	0.778	0.063278	0.002983	0.066261	5.0	0.222	5.222	0.346014
3	0.778	0.222	0.778	0.778	0.778	0.778	0.063278	0.002983	0.066261	5.0	0.222	5.222	0.346014
4	0.222	0.222	0.778	0.778	0.778	0.778	0.018056	0.002983	0.021039	6.2	0.222	6.422	0.135114
5	0.778	0.778	0.778	0.222	0.778	0.778	0.063278	-0.000770	0.062508	6.4	0.222	6.622	0.413929
6	0.778	0.778	0.222	0.778	0.778	0.778	0.063278	-0.000770	0.062508	6.4	0.222	6.622	0.413929
7	0.778	0.778	0.778	0.778	0.222	0.778	0.063278	-0.000770	0.062508	6.4	0.222	6.622	0.413929
8	0.778	0.778	0.778	0.778	0.778	0.222	0.063278	-0.000770	0.062508	6.4	0.222	6.622	0.413929
9	0.778	0.778	0.222	0.222	0.778	0.778	0.018056	-0.000770	0.017287	7.2	0.222	7.422	0.128300
10	0.778	0.778	0.778	0.778	0.222	0.222	0.018056	-0.000770	0.017287	7.2	0.222	7.422	0.128300
11	0.778	0.778	0.778	0.222	0.778	0.222	0.018056	-0.000606	0.017450	7.6	0.222	7.822	0.136495
12	0.778	0.778	0.222	0.778	0.778	0.222	0.018056	-0.000606	0.017450	7.6	0.222	7.822	0.136495
13	0.778	0.778	0.222	0.778	0.222	0.778	0.018056	-0.000606	0.017450	7.6	0.222	7.822	0.136495
14	0.778	0.778	0.778	0.222	0.222	0.778	0.018056	-0.000606	0.017450	7.6	0.222	7.822	0.136495
15	0.778	0.222	0.778	0.222	0.778	0.778	0.018056	-0.000606	0.017450	7.6	0.222	7.822	0.136495
16	0.222	0.778	0.222	0.778	0.778	0.778	0.018056	-0.000606	0.017450	7.6	0.222	7.822	0.136495
17	0.778	0.222	0.778	0.778	0.222	0.778	0.018056	-0.000606	0.017450	7.6	0.222	7.822	0.136495
18	0.222	0.778	0.778	0.222	0.778	0.778	0.018056	-0.000606	0.017450	7.6	0.222	7.822	0.136495
19	0.778	0.222	0.222	0.778	0.778	0.778	0.018056	-0.000606	0.017450	7.6	0.222	7.822	0.136495
20	0.778	0.222	0.778	0.778	0.778	0.222	0.018056	-0.000606	0.017450	7.6	0.222	7.822	0.136495
21	0.222	0.778	0.778	0.778	0.222	0.778	0.018056	-0.000606	0.017450	7.6	0.222	7.822	0.136495
22	0.222	0.778	0.778	0.778	0.778	0.222	0.018056	-0.000606	0.017450	7.6	0.222	7.822	0.136495
23	0.778	0.778	0.778	0.222	0.222	0.222	0.005152	-0.000606	0.004546	7.8	0.222	8.022	0.036471
24	0.778	0.778	0.222	0.222	0.778	0.222	0.005152	-0.000606	0.004546	7.8	0.222	8.022	0.036471
25	0.778	0.778	0.222	0.222	0.222	0.778	0.005152	-0.000606	0.004546	7.8	0.222	8.022	0.036471
26	0.222	0.778	0.222	0.222	0.778	0.778	0.005152	-0.000606	0.004546	7.8	0.222	8.022	0.036471
27	0.222	0.222	0.222	0.778	0.778	0.778	0.005152	-0.000606	0.004546	7.8	0.222	8.022	0.036471
28	0.222	0.222	0.778	0.778	0.222	0.778	0.005152	-0.000606	0.004546	7.8	0.222	8.022	0.036471
29	0.222	0.222	0.778	0.778	0.778	0.222	0.005152	-0.000606	0.004546	7.8	0.222	8.022	0.036471
30	0.778	0.222	0.222	0.222	0.778	0.778	0.005152	-0.000606	0.004546	7.8	0.222	8.022	0.036471
31	0.222	0.778	0.778	0.778	0.222	0.222	0.005152	-0.000606	0.004546	7.8	0.222	8.022	0.036471
32	0.778	0.778	0.222	0.778	0.222	0.222	0.005152	-0.000606	0.004546	7.8	0.222	8.022	0.036471
33	0.222	0.222	0.778	0.222	0.778	0.778	0.005152	-0.000606	0.004546	7.8	0.222	8.022	0.036471
34	0.778	0.222	0.778	0.778	0.222	0.222	0.005152	-0.000606	0.004546	7.8	0.222	8.022	0.036471
35	0.222	0.222	0.778	0.778	0.778	0.222	0.001470	-0.000606	0.000864	9.0	0.222	9.222	0.007970
36	0.778	0.778	0.222	0.222	0.222	0.222	0.001470	-0.000606	0.000864	9.0	0.222	9.222	0.007970
37	0.222	0.222	0.222	0.222	0.778	0.778	0.001470	-0.000606	0.000864	9.0	0.222	9.222	0.007970
38	0.778	0.222	0.778	0.222	0.778	0.222	0.005152	-0.000228	0.004924	9.7	0.222	9.922	0.048861
39	0.222	0.778	0.778	0.222	0.222	0.778	0.005152	-0.000228	0.004924	9.7	0.222	9.922	0.048861
40	0.778	0.222	0.222	0.778	0.222	0.778	0.005152	-0.000228	0.004924	9.7	0.222	9.922	0.048861
41	0.778	0.222	0.778	0.222	0.222	0.778	0.005152	-0.000228	0.004924	9.7	0.222	9.922	0.048861
42	0.778	0.222	0.222	0.778	0.778	0.222	0.005152	-0.000228	0.004924	9.7	0.222	9.922	0.048861
43	0.222	0.778	0.222	0.778	0.778	0.222	0.005152	-0.000228	0.004924	9.7	0.222	9.922	0.048861
44	0.222	0.778	0.778	0.222	0.778	0.222	0.005152	-0.000228	0.004924	9.7	0.222	9.922	0.048861
45	0.222	0.778	0.222	0.778	0.222	0.778	0.005152	-0.000228	0.004924	9.7	0.222	9.922	0.048861
46	0.222	0.778	0.778	0.222	0.222	0.222	0.001470	-0.000228	0.001242	9.7	0.222	9.922	0.012327
47	0.778	0.222	0.222	0.222	0.222	0.778	0.001470	-0.000228	0.001242	9.7	0.222	9.922	0.012327
48	0.778	0.222	0.222	0.222	0.778	0.222	0.001470	-0.000228	0.001242	9.7	0.222	9.922	0.012327
49	0.222	0.778	0.222	0.778	0.222	0.222	0.001470	-0.000228	0.001242	9.7	0.222	9.922	0.012327
50	0.222	0.778	0.222	0.222	0.222	0.778	0.001470	-0.000228	0.001242	9.7	0.222	9.922	0.012327
51	0.778	0.222	0.778	0.222	0.222	0.222	0.001470	-0.000228	0.001242	9.7	0.222	9.922	0.012327
52	0.222	0.222	0.222	0.778	0.778	0.222	0.001470	-0.000228	0.001242	9.7	0.222	9.922	0.012327
53	0.222	0.778	0.222	0.222	0.778	0.222	0.001470	-0.000228	0.001242	9.7	0.222	9.922	0.012327
54	0.778	0.222	0.222	0.778	0.222	0.222	0.001470	-0.000228	0.001242	9.7	0.222	9.922	0.012327
55	0.222	0.222	0.778	0.222	0.222	0.778	0.001470	-0.000228	0.001242	9.7	0.222	9.922	0.012327
56	0.222	0.222	0.778	0.222	0.778	0.222	0.001470	-0.000228	0.001242	9.7	0.222	9.922	0.012327
57	0.222	0.222	0.222	0.778	0.222	0.778	0.001470	-0.000228	0.001242	9.7	0.222	9.922	0.012327
58	0.222	0.778	0.222	0.222	0.222	0.222	0.000420	-0.000228	0.000192	10.0	0.222	10.222	0.001960
59	0.222	0.222	0.778	0.222	0.222	0.222	0.000420	-0.000228	0.000192	10.0	0.222	10.222	0.001960
60	0.222	0.222	0.222	0.778	0.222	0.222	0.000420	-0.000228	0.000192	10.0	0.222	10.222	0.001960
61	0.778	0.222	0.222	0.222	0.222	0.222	0.000420	-0.000228	0.000192	10.0	0.222	10.222	0.001960
62	0.222	0.222	0.222	0.222	0.222	0.778	0.000420	-0.000228	0.000192	10.0	0.222	10.222	0.001960
63	0.222	0.222	0.222	0.222	0.778	0.222	0.000420	-0.000228	0.000192	10.0	0.222	10.222	0.001960
64	0.222	0.222	0.222	0.222	0.222	0.222	0.000120	-0.000228	-0.000108	11.5	0.222	11.722	-0.001267 6.521244

EBL2 - ITERATION 1

	P(a _{ol1})	P(a _{ol2})	P(a _{cl1})	P(a _{cl2})	P(a _{cr1})	P(a _{cr2})	P(i)	Adj P(i)	P'(i)	h _{base}	h _{adj}	h _{sl}	P'(i)*h _{sl}
1	0.778	0.778	0.778	0.778	0.778	0.778	0.221757	0.018178	0.239935	4.5	-0.155	4.345	1.042517
2	0.222	0.778	0.778	0.778	0.778	0.778	0.063278	0.002983	0.066261	5.0	-0.155	4.845	0.321034
3	0.778	0.222	0.778	0.778	0.778	0.778	0.063278	0.002983	0.066261	5.0	-0.155	4.845	0.321034
4	0.222	0.222	0.778	0.778	0.778	0.778	0.018056	0.002983	0.021039	6.2	-0.155	6.045	0.127182
5	0.778	0.778	0.778	0.222	0.778	0.778	0.063278	-0.000770	0.062508	6.4	-0.155	6.245	0.390363
6	0.778	0.778	0.222	0.778	0.778	0.778	0.063278	-0.000770	0.062508	6.4	-0.155	6.245	0.390363
7	0.778	0.778	0.778	0.778	0.222	0.778	0.063278	-0.000770	0.062508	6.4	-0.155	6.245	0.390363
8	0.778	0.778	0.778	0.778	0.778	0.222	0.063278	-0.000770	0.062508	6.4	-0.155	6.245	0.390363
9	0.778	0.778	0.222	0.222	0.778	0.778	0.018056	-0.000770	0.017287	7.2	-0.155	7.045	0.121783
10	0.778	0.778	0.778	0.778	0.222	0.222	0.018056	-0.000770	0.017287	7.2	-0.155	7.045	0.121783
11	0.778	0.778	0.778	0.222	0.778	0.222	0.018056	-0.000606	0.017450	7.6	-0.155	7.445	0.129917
12	0.778	0.778	0.222	0.778	0.778	0.222	0.018056	-0.000606	0.017450	7.6	-0.155	7.445	0.129917
13	0.778	0.778	0.222	0.778	0.222	0.778	0.018056	-0.000606	0.017450	7.6	-0.155	7.445	0.129917
14	0.778	0.778	0.778	0.222	0.222	0.778	0.018056	-0.000606	0.017450	7.6	-0.155	7.445	0.129917
15	0.778	0.222	0.778	0.222	0.778	0.778	0.018056	-0.000606	0.017450	7.6	-0.155	7.445	0.129917
16	0.222	0.778	0.222	0.778	0.778	0.778	0.018056	-0.000606	0.017450	7.6	-0.155	7.445	0.129917
17	0.778	0.222	0.778	0.778	0.222	0.778	0.018056	-0.000606	0.017450	7.6	-0.155	7.445	0.129917
18	0.222	0.778	0.778	0.222	0.778	0.778	0.018056	-0.000606	0.017450	7.6	-0.155	7.445	0.129917
19	0.778	0.222	0.222	0.778	0.778	0.778	0.018056	-0.000606	0.017450	7.6	-0.155	7.445	0.129917
20	0.778	0.222	0.778	0.778	0.778	0.222	0.018056	-0.000606	0.017450	7.6	-0.155	7.445	0.129917
21	0.222	0.778	0.778	0.778	0.222	0.778	0.018056	-0.000606	0.017450	7.6	-0.155	7.445	0.129917
22	0.222	0.778	0.778	0.778	0.778	0.222	0.018056	-0.000606	0.017450	7.6	-0.155	7.445	0.129917
23	0.778	0.778	0.778	0.222	0.222	0.222	0.005152	-0.000606	0.004546	7.8	-0.155	7.645	0.034757
24	0.778	0.778	0.222	0.222	0.778	0.222	0.005152	-0.000606	0.004546	7.8	-0.155	7.645	0.034757
25	0.778	0.778	0.222	0.222	0.222	0.778	0.005152	-0.000606	0.004546	7.8	-0.155	7.645	0.034757
26	0.222	0.778	0.222	0.222	0.778	0.778	0.005152	-0.000606	0.004546	7.8	-0.155	7.645	0.034757
27	0.222	0.222	0.222	0.778	0.778	0.778	0.005152	-0.000606	0.004546	7.8	-0.155	7.645	0.034757
28	0.222	0.222	0.778	0.778	0.222	0.778	0.005152	-0.000606	0.004546	7.8	-0.155	7.645	0.034757
29	0.222	0.222	0.778	0.778	0.778	0.222	0.005152	-0.000606	0.004546	7.8	-0.155	7.645	0.034757
30	0.778	0.222	0.222	0.222	0.778	0.778	0.005152	-0.000606	0.004546	7.8	-0.155	7.645	0.034757
31	0.222	0.778	0.778	0.778	0.222	0.222	0.005152	-0.000606	0.004546	7.8	-0.155	7.645	0.034757
32	0.778	0.778	0.222	0.778	0.222	0.222	0.005152	-0.000606	0.004546	7.8	-0.155	7.645	0.034757
33	0.222	0.222	0.778	0.222	0.778	0.778	0.005152	-0.000606	0.004546	7.8	-0.155	7.645	0.034757
34	0.778	0.222	0.778	0.778	0.222	0.222	0.005152	-0.000606	0.004546	7.8	-0.155	7.645	0.034757
35	0.222	0.222	0.778	0.778	0.222	0.222	0.001470	-0.000606	0.000864	9.0	-0.155	8.845	0.007644
36	0.778	0.778	0.222	0.222	0.222	0.222	0.001470	-0.000606	0.000864	9.0	-0.155	8.845	0.007644
37	0.222	0.222	0.222	0.222	0.778	0.778	0.001470	-0.000606	0.000864	9.0	-0.155	8.845	0.007644
38	0.778	0.222	0.778	0.222	0.778	0.222	0.005152	-0.000228	0.004924	9.7	-0.155	9.545	0.047004
39	0.222	0.778	0.778	0.222	0.222	0.778	0.005152	-0.000228	0.004924	9.7	-0.155	9.545	0.047004
40	0.778	0.222	0.222	0.778	0.222	0.778	0.005152	-0.000228	0.004924	9.7	-0.155	9.545	0.047004
41	0.778	0.222	0.778	0.222	0.222	0.778	0.005152	-0.000228	0.004924	9.7	-0.155	9.545	0.047004
42	0.778	0.222	0.222	0.778	0.778	0.222	0.005152	-0.000228	0.004924	9.7	-0.155	9.545	0.047004
43	0.222	0.778	0.222	0.778	0.778	0.222	0.005152	-0.000228	0.004924	9.7	-0.155	9.545	0.047004
44	0.222	0.778	0.778	0.222	0.778	0.222	0.005152	-0.000228	0.004924	9.7	-0.155	9.545	0.047004
45	0.222	0.778	0.222	0.778	0.222	0.778	0.005152	-0.000228	0.004924	9.7	-0.155	9.545	0.047004
46	0.222	0.778	0.778	0.222	0.222	0.222	0.001470	-0.000228	0.001242	9.7	-0.155	9.545	0.011859
47	0.778	0.222	0.222	0.222	0.222	0.778	0.001470	-0.000228	0.001242	9.7	-0.155	9.545	0.011859
48	0.778	0.222	0.222	0.222	0.778	0.222	0.001470	-0.000228	0.001242	9.7	-0.155	9.545	0.011859
49	0.222	0.778	0.222	0.778	0.222	0.222	0.001470	-0.000228	0.001242	9.7	-0.155	9.545	0.011859
50	0.222	0.778	0.222	0.222	0.222	0.778	0.001470	-0.000228	0.001242	9.7	-0.155	9.545	0.011859
51	0.778	0.222	0.778	0.222	0.222	0.222	0.001470	-0.000228	0.001242	9.7	-0.155	9.545	0.011859
52	0.222	0.222	0.222	0.778	0.778	0.222	0.001470	-0.000228	0.001242	9.7	-0.155	9.545	0.011859
53	0.222	0.778	0.222	0.222	0.778	0.222	0.001470	-0.000228	0.001242	9.7	-0.155	9.545	0.011859
54	0.778	0.222	0.222	0.778	0.222	0.222	0.001470	-0.000228	0.001242	9.7	-0.155	9.545	0.011859
55	0.222	0.222	0.778	0.222	0.222	0.778	0.001470	-0.000228	0.001242	9.7	-0.155	9.545	0.011859
56	0.222	0.222	0.778	0.222	0.778	0.222	0.001470	-0.000228	0.001242	9.7	-0.155	9.545	0.011859
57	0.222	0.222	0.222	0.778	0.222	0.778	0.001470	-0.000228	0.001242	9.7	-0.155	9.545	0.011859
58	0.222	0.778	0.222	0.222	0.222	0.222	0.000420	-0.000228	0.000192	10.0	-0.155	9.845	0.001888
59	0.222	0.222	0.778	0.222	0.222	0.222	0.000420	-0.000228	0.000192	10.0	-0.155	9.845	0.001888
60	0.222	0.222	0.222	0.778	0.222	0.222	0.000420	-0.000228	0.000192	10.0	-0.155	9.845	0.001888
61	0.778	0.222	0.222	0.222	0.222	0.222	0.000420	-0.000228	0.000192	10.0	-0.155	9.845	0.001888
62	0.222	0.222	0.222	0.222	0.222	0.778	0.000420	-0.000228	0.000192	10.0	-0.155	9.845	0.001888
63	0.222	0.222	0.222	0.222	0.778	0.222	0.000420	-0.000228	0.000192	10.0	-0.155	9.845	0.001888
64	0.222	0.222	0.222	0.222	0.222	0.222	0.000120	-0.000228	-0.000108	11.5	-0.155	11.345	-0.001226 6.144244

Example Problem 5

WBL1 - ITERATION 1

Example Problem 5

	P(a _{ol1})	P(a _{ol2})	P(a _{cl1})	P(a _{cl2})	P(a _{CR1})	P(a _{CR2})	P(i)	Adj P(i)	P'(i)	h _{base}	h _{adj}	h _{sl}	P'(i)*h _{sl}
1	0.8	0.8	0.778	0.778	0.778	0.778	0.234476	0.017831	0.252307	4.5	0.200	4.700	1.185841
2	0.2	0.8	0.778	0.778	0.778	0.778	0.058619	0.002952	0.061571	5.0	0.200	5.200	0.320170
3	0.8	0.2	0.778	0.778	0.778	0.778	0.058619	0.002952	0.061571	5.0	0.200	5.200	0.320170
4	0.2	0.2	0.778	0.778	0.778	0.778	0.014655	0.002952	0.017607	6.2	0.200	6.400	0.112684
5	0.8	0.8	0.778	0.222	0.778	0.778	0.066907	-0.000889	0.066018	6.4	0.200	6.600	0.435718
6	0.8	0.8	0.222	0.778	0.778	0.778	0.066907	-0.000889	0.066018	6.4	0.200	6.600	0.435718
7	0.8	0.8	0.778	0.778	0.222	0.778	0.066907	-0.000889	0.066018	6.4	0.200	6.600	0.435718
8	0.8	0.8	0.778	0.778	0.778	0.222	0.066907	-0.000889	0.066018	6.4	0.200	6.600	0.435718
9	0.8	0.8	0.222	0.222	0.778	0.778	0.019092	-0.000889	0.018203	7.2	0.200	7.400	0.134699
10	0.8	0.8	0.778	0.778	0.222	0.222	0.019092	-0.000889	0.018203	7.2	0.200	7.400	0.134699
11	0.8	0.8	0.778	0.222	0.778	0.222	0.019092	-0.000583	0.018509	7.6	0.200	7.800	0.144367
12	0.8	0.8	0.222	0.778	0.778	0.222	0.019092	-0.000583	0.018509	7.6	0.200	7.800	0.144367
13	0.8	0.8	0.222	0.778	0.222	0.778	0.019092	-0.000583	0.018509	7.6	0.200	7.800	0.144367
14	0.8	0.8	0.778	0.222	0.222	0.778	0.019092	-0.000583	0.018509	7.6	0.200	7.800	0.144367
15	0.8	0.2	0.778	0.222	0.778	0.778	0.016727	-0.000583	0.016144	7.6	0.200	7.800	0.125921
16	0.2	0.8	0.222	0.778	0.778	0.778	0.016727	-0.000583	0.016144	7.6	0.200	7.800	0.125921
17	0.8	0.2	0.778	0.778	0.222	0.778	0.016727	-0.000583	0.016144	7.6	0.200	7.800	0.125921
18	0.2	0.8	0.778	0.222	0.778	0.778	0.016727	-0.000583	0.016144	7.6	0.200	7.800	0.125921
19	0.8	0.2	0.222	0.778	0.778	0.778	0.016727	-0.000583	0.016144	7.6	0.200	7.800	0.125921
20	0.8	0.2	0.778	0.778	0.778	0.222	0.016727	-0.000583	0.016144	7.6	0.200	7.800	0.125921
21	0.2	0.8	0.778	0.778	0.222	0.778	0.016727	-0.000583	0.016144	7.6	0.200	7.800	0.125921
22	0.2	0.8	0.778	0.778	0.778	0.222	0.016727	-0.000583	0.016144	7.6	0.200	7.800	0.125921
23	0.8	0.8	0.778	0.222	0.222	0.222	0.005448	-0.000583	0.004865	7.8	0.200	8.000	0.038918
24	0.8	0.8	0.222	0.222	0.778	0.222	0.005448	-0.000583	0.004865	7.8	0.200	8.000	0.038918
25	0.8	0.8	0.222	0.222	0.222	0.778	0.005448	-0.000583	0.004865	7.8	0.200	8.000	0.038918
26	0.2	0.8	0.222	0.222	0.778	0.778	0.004773	-0.000583	0.004190	7.8	0.200	8.000	0.033519
27	0.2	0.2	0.222	0.778	0.778	0.778	0.004182	-0.000583	0.003599	7.8	0.200	8.000	0.028789
28	0.2	0.2	0.778	0.778	0.222	0.778	0.004182	-0.000583	0.003599	7.8	0.200	8.000	0.028789
29	0.2	0.2	0.778	0.778	0.778	0.222	0.004182	-0.000583	0.003599	7.8	0.200	8.000	0.028789
30	0.8	0.2	0.222	0.222	0.778	0.778	0.004773	-0.000583	0.004190	7.8	0.200	8.000	0.033519
31	0.2	0.8	0.778	0.778	0.222	0.222	0.004773	-0.000583	0.004190	7.8	0.200	8.000	0.033519
32	0.8	0.8	0.222	0.778	0.222	0.222	0.005448	-0.000583	0.004865	7.8	0.200	8.000	0.038918
33	0.2	0.2	0.778	0.222	0.778	0.778	0.004182	-0.000583	0.003599	7.8	0.200	8.000	0.028789
34	0.8	0.2	0.778	0.778	0.222	0.222	0.004773	-0.000583	0.004190	7.8	0.200	8.000	0.033519
35	0.2	0.2	0.778	0.778	0.222	0.222	0.001193	-0.000583	0.000610	9.0	0.200	9.200	0.005613
36	0.8	0.8	0.222	0.222	0.222	0.222	0.001555	-0.000583	0.000971	9.0	0.200	9.200	0.008937
37	0.2	0.2	0.222	0.222	0.778	0.778	0.001193	-0.000583	0.000610	9.0	0.200	9.200	0.005613
38	0.8	0.2	0.778	0.222	0.778	0.222	0.004773	-0.000208	0.004565	9.7	0.200	9.900	0.045195
39	0.2	0.8	0.778	0.222	0.222	0.778	0.004773	-0.000208	0.004565	9.7	0.200	9.900	0.045195
40	0.8	0.2	0.222	0.778	0.222	0.778	0.004773	-0.000208	0.004565	9.7	0.200	9.900	0.045195
41	0.8	0.2	0.778	0.222	0.222	0.778	0.004773	-0.000208	0.004565	9.7	0.200	9.900	0.045195
42	0.8	0.2	0.222	0.778	0.778	0.222	0.004773	-0.000208	0.004565	9.7	0.200	9.900	0.045195
43	0.2	0.8	0.222	0.778	0.778	0.222	0.004773	-0.000208	0.004565	9.7	0.200	9.900	0.045195
44	0.2	0.8	0.778	0.222	0.778	0.222	0.004773	-0.000208	0.004565	9.7	0.200	9.900	0.045195
45	0.2	0.8	0.222	0.778	0.222	0.778	0.004773	-0.000208	0.004565	9.7	0.200	9.900	0.045195
46	0.2	0.8	0.778	0.222	0.222	0.222	0.001362	-0.000208	0.001154	9.7	0.200	9.900	0.011427
47	0.8	0.2	0.222	0.222	0.222	0.778	0.001362	-0.000208	0.001154	9.7	0.200	9.900	0.011427
48	0.8	0.2	0.222	0.222	0.778	0.222	0.001362	-0.000208	0.001154	9.7	0.200	9.900	0.011427
49	0.2	0.8	0.222	0.778	0.222	0.222	0.001362	-0.000208	0.001154	9.7	0.200	9.900	0.011427
50	0.2	0.8	0.222	0.222	0.222	0.778	0.001362	-0.000208	0.001154	9.7	0.200	9.900	0.011427
51	0.8	0.2	0.778	0.222	0.222	0.222	0.001362	-0.000208	0.001154	9.7	0.200	9.900	0.011427
52	0.2	0.2	0.222	0.778	0.778	0.222	0.001193	-0.000208	0.000985	9.7	0.200	9.900	0.009756
53	0.2	0.8	0.222	0.222	0.778	0.222	0.001362	-0.000208	0.001154	9.7	0.200	9.900	0.011427
54	0.8	0.2	0.222	0.778	0.222	0.222	0.001362	-0.000208	0.001154	9.7	0.200	9.900	0.011427
55	0.2	0.2	0.778	0.222	0.222	0.778	0.001193	-0.000208	0.000985	9.7	0.200	9.900	0.009756
56	0.2	0.2	0.778	0.222	0.778	0.222	0.001193	-0.000208	0.000985	9.7	0.200	9.900	0.009756
57	0.2	0.2	0.222	0.778	0.222	0.778	0.001193	-0.000208	0.000985	9.7	0.200	9.900	0.009756
58	0.2	0.8	0.222	0.222	0.222	0.222	0.000389	-0.000208	0.000181	10.0	0.200	10.200	0.001845
59	0.2	0.2	0.778	0.222	0.222	0.222	0.000340	-0.000208	0.000133	10.0	0.200	10.200	0.001354
60	0.2	0.2	0.222	0.778	0.222	0.222	0.000340	-0.000208	0.000133	10.0	0.200	10.200	0.001354
61	0.8	0.2	0.222	0.222	0.222	0.222	0.000389	-0.000208	0.000181	10.0	0.200	10.200	0.001845
62	0.2	0.2	0.222	0.222	0.222	0.778	0.000340	-0.000208	0.000133	10.0	0.200	10.200	0.001354
63	0.2	0.2	0.222	0.222	0.778	0.222	0.000340	-0.000208	0.000133	10.0	0.200	10.200	0.001354
64	0.2	0.2	0.222	0.222	0.222	0.222	0.000097	-0.000208	-0.000111	11.5	0.200	11.700	-0.001294

WBL2 - ITERATION 1

	$P(a_{ol1})$	$P(a_{ol2})$	$P(a_{cl1})$	$P(a_{cl2})$	$P(a_{CR1})$	$P(a_{CR2})$	$P(i)$	Adj P(i)	$P'(i)$	h_{base}	h_{adj}	h_{sl}	$P'(i)*h_{sl}$
1	0.778	0.778	0.8	0.8	0.778	0.778	0.234476	0.017621	0.252096	4.5	-0.280	4.220	1.063847
2	0.222	0.778	0.8	0.8	0.778	0.778	0.066907	0.002812	0.069719	5.0	-0.280	4.720	0.329074
3	0.778	0.222	0.8	0.8	0.778	0.778	0.066907	0.002812	0.069719	5.0	-0.280	4.720	0.329074
4	0.222	0.222	0.8	0.8	0.778	0.778	0.019092	0.002812	0.021904	6.2	-0.280	5.920	0.129670
5	0.778	0.778	0.8	0.2	0.778	0.778	0.058619	-0.000784	0.057835	6.4	-0.280	6.120	0.353949
6	0.778	0.778	0.2	0.8	0.778	0.778	0.058619	-0.000784	0.057835	6.4	-0.280	6.120	0.353949
7	0.778	0.778	0.8	0.8	0.222	0.778	0.066907	-0.000784	0.066123	6.4	-0.280	6.120	0.404672
8	0.778	0.778	0.8	0.8	0.778	0.222	0.066907	-0.000784	0.066123	6.4	-0.280	6.120	0.404672
9	0.778	0.778	0.2	0.2	0.778	0.778	0.014655	-0.000784	0.013871	7.2	-0.280	6.920	0.095985
10	0.778	0.778	0.8	0.8	0.222	0.222	0.019092	-0.000784	0.018308	7.2	-0.280	6.920	0.126688
11	0.778	0.778	0.8	0.2	0.778	0.222	0.016727	-0.000583	0.016144	7.6	-0.280	7.320	0.118172
12	0.778	0.778	0.2	0.8	0.778	0.222	0.016727	-0.000583	0.016144	7.6	-0.280	7.320	0.118172
13	0.778	0.778	0.2	0.8	0.222	0.778	0.016727	-0.000583	0.016144	7.6	-0.280	7.320	0.118172
14	0.778	0.778	0.8	0.2	0.222	0.778	0.016727	-0.000583	0.016144	7.6	-0.280	7.320	0.118172
15	0.778	0.222	0.8	0.2	0.778	0.778	0.016727	-0.000583	0.016144	7.6	-0.280	7.320	0.118172
16	0.222	0.778	0.2	0.8	0.778	0.778	0.016727	-0.000583	0.016144	7.6	-0.280	7.320	0.118172
17	0.778	0.222	0.8	0.8	0.222	0.778	0.019092	-0.000583	0.018509	7.6	-0.280	7.320	0.135483
18	0.222	0.778	0.8	0.2	0.778	0.778	0.016727	-0.000583	0.016144	7.6	-0.280	7.320	0.118172
19	0.778	0.222	0.2	0.8	0.778	0.778	0.016727	-0.000583	0.016144	7.6	-0.280	7.320	0.118172
20	0.778	0.222	0.8	0.8	0.778	0.222	0.019092	-0.000583	0.018509	7.6	-0.280	7.320	0.135483
21	0.222	0.778	0.8	0.8	0.222	0.778	0.019092	-0.000583	0.018509	7.6	-0.280	7.320	0.135483
22	0.222	0.778	0.8	0.8	0.778	0.222	0.019092	-0.000583	0.018509	7.6	-0.280	7.320	0.135483
23	0.778	0.778	0.8	0.2	0.222	0.222	0.004773	-0.000583	0.004190	7.8	-0.280	7.520	0.031508
24	0.778	0.778	0.2	0.2	0.778	0.222	0.004182	-0.000583	0.003599	7.8	-0.280	7.520	0.027062
25	0.778	0.778	0.2	0.2	0.222	0.778	0.004182	-0.000583	0.003599	7.8	-0.280	7.520	0.027062
26	0.222	0.778	0.2	0.2	0.778	0.778	0.004182	-0.000583	0.003599	7.8	-0.280	7.520	0.027062
27	0.222	0.222	0.2	0.8	0.778	0.778	0.004773	-0.000583	0.004190	7.8	-0.280	7.520	0.031508
28	0.222	0.222	0.8	0.8	0.222	0.778	0.005448	-0.000583	0.004865	7.8	-0.280	7.520	0.036582
29	0.222	0.222	0.8	0.8	0.778	0.222	0.005448	-0.000583	0.004865	7.8	-0.280	7.520	0.036582
30	0.778	0.222	0.2	0.2	0.778	0.778	0.004182	-0.000583	0.003599	7.8	-0.280	7.520	0.027062
31	0.222	0.778	0.8	0.8	0.222	0.222	0.005448	-0.000583	0.004865	7.8	-0.280	7.520	0.036582
32	0.778	0.778	0.2	0.8	0.222	0.222	0.004773	-0.000583	0.004190	7.8	-0.280	7.520	0.031508
33	0.222	0.222	0.8	0.2	0.778	0.778	0.004773	-0.000583	0.004190	7.8	-0.280	7.520	0.031508
34	0.778	0.222	0.8	0.8	0.222	0.222	0.005448	-0.000583	0.004865	7.8	-0.280	7.520	0.036582
35	0.222	0.222	0.8	0.8	0.222	0.222	0.001555	-0.000583	0.000971	9.0	-0.280	8.720	0.008471
36	0.778	0.778	0.2	0.2	0.222	0.222	0.001193	-0.000583	0.000610	9.0	-0.280	8.720	0.005321
37	0.222	0.222	0.2	0.2	0.778	0.778	0.001193	-0.000583	0.000610	9.0	-0.280	8.720	0.005321
38	0.778	0.222	0.8	0.2	0.778	0.222	0.004773	-0.000208	0.004565	9.7	-0.280	9.420	0.043004
39	0.222	0.778	0.8	0.2	0.222	0.778	0.004773	-0.000208	0.004565	9.7	-0.280	9.420	0.043004
40	0.778	0.222	0.2	0.8	0.222	0.778	0.004773	-0.000208	0.004565	9.7	-0.280	9.420	0.043004
41	0.778	0.222	0.8	0.2	0.222	0.778	0.004773	-0.000208	0.004565	9.7	-0.280	9.420	0.043004
42	0.778	0.222	0.2	0.8	0.778	0.222	0.004773	-0.000208	0.004565	9.7	-0.280	9.420	0.043004
43	0.222	0.778	0.2	0.8	0.778	0.222	0.004773	-0.000208	0.004565	9.7	-0.280	9.420	0.043004
44	0.222	0.778	0.8	0.2	0.778	0.222	0.004773	-0.000208	0.004565	9.7	-0.280	9.420	0.043004
45	0.222	0.778	0.2	0.8	0.222	0.778	0.004773	-0.000208	0.004565	9.7	-0.280	9.420	0.043004
46	0.222	0.778	0.8	0.2	0.222	0.222	0.001362	-0.000208	0.001154	9.7	-0.280	9.420	0.010873
47	0.778	0.222	0.2	0.2	0.222	0.778	0.001193	-0.000208	0.000985	9.7	-0.280	9.420	0.009283
48	0.778	0.222	0.2	0.2	0.778	0.222	0.001193	-0.000208	0.000985	9.7	-0.280	9.420	0.009283
49	0.222	0.778	0.2	0.8	0.222	0.222	0.001362	-0.000208	0.001154	9.7	-0.280	9.420	0.010873
50	0.222	0.778	0.2	0.2	0.222	0.778	0.001193	-0.000208	0.000985	9.7	-0.280	9.420	0.009283
51	0.778	0.222	0.8	0.2	0.222	0.222	0.001362	-0.000208	0.001154	9.7	-0.280	9.420	0.010873
52	0.222	0.222	0.2	0.8	0.778	0.222	0.001362	-0.000208	0.001154	9.7	-0.280	9.420	0.010873
53	0.222	0.778	0.2	0.2	0.778	0.222	0.001193	-0.000208	0.000985	9.7	-0.280	9.420	0.009283
54	0.778	0.222	0.2	0.8	0.222	0.222	0.001362	-0.000208	0.001154	9.7	-0.280	9.420	0.010873
55	0.222	0.222	0.8	0.2	0.222	0.778	0.001362	-0.000208	0.001154	9.7	-0.280	9.420	0.010873
56	0.222	0.222	0.8	0.2	0.778	0.222	0.001362	-0.000208	0.001154	9.7	-0.280	9.420	0.010873
57	0.222	0.222	0.2	0.8	0.222	0.778	0.001362	-0.000208	0.001154	9.7	-0.280	9.420	0.010873
58	0.222	0.778	0.2	0.2	0.222	0.222	0.000340	-0.000208	0.000133	10.0	-0.280	9.720	0.001290
59	0.222	0.222	0.8	0.2	0.222	0.222	0.000389	-0.000208	0.000181	10.0	-0.280	9.720	0.001758
60	0.222	0.222	0.2	0.8	0.222	0.222	0.000389	-0.000208	0.000181	10.0	-0.280	9.720	0.001758
61	0.778	0.222	0.2	0.2	0.222	0.222	0.000340	-0.000208	0.000133	10.0	-0.280	9.720	0.001290
62	0.222	0.222	0.2	0.2	0.222	0.778	0.000340	-0.000208	0.000133	10.0	-0.280	9.720	0.001290
63	0.222	0.222	0.2	0.2	0.778	0.222	0.000340	-0.000208	0.000133	10.0	-0.280	9.720	0.001290
64	0.222	0.222	0.2	0.2	0.222	0.222	0.000097	-0.000208	-0.000111	11.5	-0.280	11.220	-0.001241 5.954193

Example Problem 5

Example Problem 5

NBL1 - ITERATION 1

	P(a _{ol1})	P(a _{ol2})	P(a _{cl1})	P(a _{cl2})	P(a _{cr1})	P(a _{cr2})	P(i)	Adj P(i)	P'(i)	h _{base}	h _{adj}	h _{sl}	P'(i)*h _{sl}
1	0.7778	0.7778	0.8	0.8	0.7778	0.7778	0.234208	0.017630	0.251838	4.5	0.200	4.700	1.183638
2	0.2222	0.7778	0.8	0.8	0.7778	0.7778	0.066917	0.002814	0.069731	5.0	0.200	5.200	0.362600
3	0.7778	0.2222	0.8	0.8	0.7778	0.7778	0.066917	0.002814	0.069731	5.0	0.200	5.200	0.362600
4	0.2222	0.2222	0.8	0.8	0.7778	0.7778	0.019119	0.002814	0.021933	6.2	0.200	6.400	0.140372
5	0.7778	0.7778	0.8	0.2	0.7778	0.7778	0.058552	-0.000783	0.057769	6.4	0.200	6.600	0.381276
6	0.7778	0.7778	0.2	0.8	0.7778	0.7778	0.058552	-0.000783	0.057769	6.4	0.200	6.600	0.381276
7	0.7778	0.7778	0.8	0.8	0.2222	0.7778	0.066917	-0.000783	0.066134	6.4	0.200	6.600	0.436482
8	0.7778	0.7778	0.8	0.8	0.7778	0.2222	0.066917	-0.000783	0.066134	6.4	0.200	6.600	0.436482
9	0.7778	0.7778	0.2	0.2	0.7778	0.7778	0.014638	-0.000783	0.013855	7.2	0.200	7.400	0.102528
10	0.7778	0.7778	0.8	0.8	0.2222	0.2222	0.019119	-0.000783	0.018336	7.2	0.200	7.400	0.135687
11	0.7778	0.7778	0.8	0.2	0.7778	0.2222	0.016729	-0.000584	0.016146	7.6	0.200	7.800	0.125936
12	0.7778	0.7778	0.2	0.8	0.7778	0.2222	0.016729	-0.000584	0.016146	7.6	0.200	7.800	0.125936
13	0.7778	0.7778	0.2	0.8	0.2222	0.7778	0.016729	-0.000584	0.016146	7.6	0.200	7.800	0.125936
14	0.7778	0.7778	0.8	0.2	0.2222	0.7778	0.016729	-0.000584	0.016146	7.6	0.200	7.800	0.125936
15	0.7778	0.2222	0.8	0.2	0.7778	0.7778	0.016729	-0.000584	0.016146	7.6	0.200	7.800	0.125936
16	0.2222	0.7778	0.2	0.8	0.7778	0.7778	0.016729	-0.000584	0.016146	7.6	0.200	7.800	0.125936
17	0.7778	0.2222	0.8	0.8	0.2222	0.7778	0.019119	-0.000584	0.018535	7.6	0.200	7.800	0.144577
18	0.2222	0.7778	0.8	0.2	0.7778	0.7778	0.016729	-0.000584	0.016146	7.6	0.200	7.800	0.125936
19	0.7778	0.2222	0.2	0.8	0.7778	0.7778	0.016729	-0.000584	0.016146	7.6	0.200	7.800	0.125936
20	0.7778	0.2222	0.8	0.8	0.7778	0.2222	0.019119	-0.000584	0.018535	7.6	0.200	7.800	0.144577
21	0.2222	0.7778	0.8	0.8	0.2222	0.7778	0.019119	-0.000584	0.018535	7.6	0.200	7.800	0.144577
22	0.2222	0.7778	0.8	0.8	0.7778	0.2222	0.019119	-0.000584	0.018535	7.6	0.200	7.800	0.144577
23	0.7778	0.7778	0.8	0.2	0.2222	0.2222	0.004780	-0.000584	0.004196	7.8	0.200	8.000	0.033570
24	0.7778	0.7778	0.2	0.2	0.7778	0.2222	0.004182	-0.000584	0.003599	7.8	0.200	8.000	0.028790
25	0.7778	0.7778	0.2	0.2	0.2222	0.7778	0.004182	-0.000584	0.003599	7.8	0.200	8.000	0.028790
26	0.2222	0.7778	0.2	0.2	0.7778	0.7778	0.004182	-0.000584	0.003599	7.8	0.200	8.000	0.028790
27	0.2222	0.2222	0.2	0.8	0.7778	0.7778	0.004780	-0.000584	0.004196	7.8	0.200	8.000	0.033570
28	0.2222	0.2222	0.8	0.8	0.2222	0.7778	0.005463	-0.000584	0.004879	7.8	0.200	8.000	0.039032
29	0.2222	0.2222	0.8	0.8	0.7778	0.2222	0.005463	-0.000584	0.004879	7.8	0.200	8.000	0.039032
30	0.7778	0.2222	0.2	0.2	0.7778	0.7778	0.004182	-0.000584	0.003599	7.8	0.200	8.000	0.028790
31	0.2222	0.7778	0.8	0.8	0.2222	0.2222	0.005463	-0.000584	0.004879	7.8	0.200	8.000	0.039032
32	0.7778	0.7778	0.2	0.8	0.2222	0.2222	0.004780	-0.000584	0.004196	7.8	0.200	8.000	0.033570
33	0.2222	0.2222	0.8	0.2	0.7778	0.7778	0.004780	-0.000584	0.004196	7.8	0.200	8.000	0.033570
34	0.7778	0.2222	0.8	0.8	0.2222	0.2222	0.005463	-0.000584	0.004879	7.8	0.200	8.000	0.039032
35	0.2222	0.2222	0.8	0.8	0.2222	0.2222	0.001561	-0.000584	0.000977	9.0	0.200	9.200	0.008990
36	0.7778	0.7778	0.2	0.2	0.2222	0.2222	0.001195	-0.000584	0.000611	9.0	0.200	9.200	0.005625
37	0.2222	0.2222	0.2	0.2	0.7778	0.7778	0.001195	-0.000584	0.000611	9.0	0.200	9.200	0.005625
38	0.7778	0.2222	0.8	0.2	0.7778	0.2222	0.004780	-0.000208	0.004572	9.7	0.200	9.900	0.045259
39	0.2222	0.7778	0.8	0.2	0.2222	0.7778	0.004780	-0.000208	0.004572	9.7	0.200	9.900	0.045259
40	0.7778	0.2222	0.2	0.8	0.2222	0.7778	0.004780	-0.000208	0.004572	9.7	0.200	9.900	0.045259
41	0.7778	0.2222	0.8	0.2	0.2222	0.7778	0.004780	-0.000208	0.004572	9.7	0.200	9.900	0.045259
42	0.7778	0.2222	0.2	0.8	0.7778	0.2222	0.004780	-0.000208	0.004572	9.7	0.200	9.900	0.045259
43	0.2222	0.7778	0.2	0.8	0.7778	0.2222	0.004780	-0.000208	0.004572	9.7	0.200	9.900	0.045259
44	0.2222	0.7778	0.8	0.2	0.7778	0.2222	0.004780	-0.000208	0.004572	9.7	0.200	9.900	0.045259
45	0.2222	0.7778	0.2	0.8	0.2222	0.7778	0.004780	-0.000208	0.004572	9.7	0.200	9.900	0.045259
46	0.2222	0.7778	0.8	0.2	0.2222	0.2222	0.001366	-0.000208	0.001158	9.7	0.200	9.900	0.011460
47	0.7778	0.2222	0.2	0.2	0.2222	0.7778	0.001195	-0.000208	0.000987	9.7	0.200	9.900	0.009770
48	0.7778	0.2222	0.2	0.2	0.7778	0.2222	0.001195	-0.000208	0.000987	9.7	0.200	9.900	0.009770
49	0.2222	0.7778	0.2	0.8	0.2222	0.2222	0.001366	-0.000208	0.001158	9.7	0.200	9.900	0.011460
50	0.2222	0.7778	0.2	0.2	0.2222	0.7778	0.001195	-0.000208	0.000987	9.7	0.200	9.900	0.009770
51	0.7778	0.2222	0.8	0.2	0.2222	0.2222	0.001366	-0.000208	0.001158	9.7	0.200	9.900	0.011460
52	0.2222	0.2222	0.2	0.8	0.7778	0.2222	0.001366	-0.000208	0.001158	9.7	0.200	9.900	0.011460
53	0.2222	0.7778	0.2	0.2	0.7778	0.2222	0.001195	-0.000208	0.000987	9.7	0.200	9.900	0.009770
54	0.7778	0.2222	0.2	0.8	0.2222	0.2222	0.001366	-0.000208	0.001158	9.7	0.200	9.900	0.011460
55	0.2222	0.2222	0.8	0.2	0.2222	0.7778	0.001366	-0.000208	0.001158	9.7	0.200	9.900	0.011460
56	0.2222	0.2222	0.8	0.2	0.7778	0.2222	0.001366	-0.000208	0.001158	9.7	0.200	9.900	0.011460
57	0.2222	0.2222	0.2	0.8	0.2222	0.7778	0.001366	-0.000208	0.001158	9.7	0.200	9.900	0.011460
58	0.2222	0.7778	0.2	0.2	0.2222	0.2222	0.000341	-0.000208	0.000133	10.0	0.200	10.200	0.001360
59	0.2222	0.2222	0.8	0.2	0.2222	0.2222	0.000390	-0.000208	0.000182	10.0	0.200	10.200	0.001857
60	0.2222	0.2222	0.2	0.8	0.2222	0.2222	0.000390	-0.000208	0.000182	10.0	0.200	10.200	0.001857
61	0.7778	0.2222	0.2	0.2	0.2222	0.2222	0.000341	-0.000208	0.000133	10.0	0.200	10.200	0.001360
62	0.2222	0.2222	0.2	0.2	0.2222	0.7778	0.000341	-0.000208	0.000133	10.0	0.200	10.200	0.001360
63	0.2222	0.2222	0.2	0.2	0.7778	0.2222	0.000341	-0.000208	0.000133	10.0	0.200	10.200	0.001360
64	0.2222	0.2222	0.2	0.2	0.2222	0.2222	0.000098	-0.000208	-0.000111	11.5	0.200	11.700	-0.001293 6.435236

NBL2 - ITERATION 1

Example Problem 5

	P(a _{ol1})	P(a _{ol2})	P(a _{cl1})	P(a _{cl2})	P(a _{cr1})	P(a _{cr2})	P(i)	Adj P(i)	P'(i)	h _{base}	h _{adj}	h _{sl}	P'(i)*h _{sl}
1	0.778	0.778	0.8	0.8	0.778	0.778	0.234476	0.017621	0.252096	4.5	-0.140	4.360	1.099141
2	0.222	0.778	0.8	0.8	0.778	0.778	0.066907	0.002812	0.069719	5.0	-0.140	4.860	0.338835
3	0.778	0.222	0.8	0.8	0.778	0.778	0.066907	0.002812	0.069719	5.0	-0.140	4.860	0.338835
4	0.222	0.222	0.8	0.8	0.778	0.778	0.019092	0.002812	0.021904	6.2	-0.140	6.060	0.132737
5	0.778	0.778	0.8	0.2	0.778	0.778	0.058619	-0.000784	0.057835	6.4	-0.140	6.260	0.362046
6	0.778	0.778	0.2	0.8	0.778	0.778	0.058619	-0.000784	0.057835	6.4	-0.140	6.260	0.362046
7	0.778	0.778	0.8	0.8	0.222	0.778	0.066907	-0.000784	0.066123	6.4	-0.140	6.260	0.413929
8	0.778	0.778	0.8	0.8	0.778	0.222	0.066907	-0.000784	0.066123	6.4	-0.140	6.260	0.413929
9	0.778	0.778	0.2	0.2	0.778	0.778	0.014655	-0.000784	0.013871	7.2	-0.140	7.060	0.097926
10	0.778	0.778	0.8	0.8	0.222	0.222	0.019092	-0.000784	0.018308	7.2	-0.140	7.060	0.129251
11	0.778	0.778	0.8	0.2	0.778	0.222	0.016727	-0.000583	0.016144	7.6	-0.140	7.460	0.120432
12	0.778	0.778	0.2	0.8	0.778	0.222	0.016727	-0.000583	0.016144	7.6	-0.140	7.460	0.120432
13	0.778	0.778	0.2	0.8	0.222	0.778	0.016727	-0.000583	0.016144	7.6	-0.140	7.460	0.120432
14	0.778	0.778	0.8	0.2	0.222	0.778	0.016727	-0.000583	0.016144	7.6	-0.140	7.460	0.120432
15	0.778	0.222	0.8	0.2	0.778	0.778	0.016727	-0.000583	0.016144	7.6	-0.140	7.460	0.120432
16	0.222	0.778	0.2	0.8	0.778	0.778	0.016727	-0.000583	0.016144	7.6	-0.140	7.460	0.120432
17	0.778	0.222	0.8	0.8	0.222	0.778	0.019092	-0.000583	0.018509	7.6	-0.140	7.460	0.138075
18	0.222	0.778	0.8	0.2	0.778	0.778	0.016727	-0.000583	0.016144	7.6	-0.140	7.460	0.120432
19	0.778	0.222	0.2	0.8	0.778	0.778	0.016727	-0.000583	0.016144	7.6	-0.140	7.460	0.120432
20	0.778	0.222	0.8	0.8	0.778	0.222	0.019092	-0.000583	0.018509	7.6	-0.140	7.460	0.138075
21	0.222	0.778	0.8	0.8	0.222	0.778	0.019092	-0.000583	0.018509	7.6	-0.140	7.460	0.138075
22	0.222	0.778	0.8	0.8	0.778	0.222	0.019092	-0.000583	0.018509	7.6	-0.140	7.460	0.138075
23	0.778	0.778	0.8	0.2	0.222	0.222	0.004773	-0.000583	0.004190	7.8	-0.140	7.660	0.032094
24	0.778	0.778	0.2	0.2	0.778	0.222	0.004182	-0.000583	0.003599	7.8	-0.140	7.660	0.027565
25	0.778	0.778	0.2	0.2	0.222	0.778	0.004182	-0.000583	0.003599	7.8	-0.140	7.660	0.027565
26	0.222	0.778	0.2	0.2	0.778	0.778	0.004182	-0.000583	0.003599	7.8	-0.140	7.660	0.027565
27	0.222	0.222	0.2	0.8	0.778	0.778	0.004773	-0.000583	0.004190	7.8	-0.140	7.660	0.032094
28	0.222	0.222	0.8	0.8	0.222	0.778	0.005448	-0.000583	0.004865	7.8	-0.140	7.660	0.037264
29	0.222	0.222	0.8	0.8	0.778	0.222	0.005448	-0.000583	0.004865	7.8	-0.140	7.660	0.037264
30	0.778	0.222	0.2	0.2	0.778	0.778	0.004182	-0.000583	0.003599	7.8	-0.140	7.660	0.027565
31	0.222	0.778	0.8	0.8	0.222	0.222	0.005448	-0.000583	0.004865	7.8	-0.140	7.660	0.037264
32	0.778	0.778	0.2	0.8	0.222	0.222	0.004773	-0.000583	0.004190	7.8	-0.140	7.660	0.032094
33	0.222	0.222	0.8	0.2	0.778	0.778	0.004773	-0.000583	0.004190	7.8	-0.140	7.660	0.032094
34	0.778	0.222	0.8	0.8	0.222	0.222	0.005448	-0.000583	0.004865	7.8	-0.140	7.660	0.037264
35	0.222	0.222	0.8	0.8	0.222	0.222	0.001555	-0.000583	0.000971	9.0	-0.140	8.860	0.008607
36	0.778	0.778	0.2	0.2	0.222	0.222	0.001193	-0.000583	0.000610	9.0	-0.140	8.860	0.005406
37	0.222	0.222	0.2	0.2	0.778	0.778	0.001193	-0.000583	0.000610	9.0	-0.140	8.860	0.005406
38	0.778	0.222	0.8	0.2	0.778	0.222	0.004773	-0.000208	0.004565	9.7	-0.140	9.560	0.043643
39	0.222	0.778	0.8	0.2	0.222	0.778	0.004773	-0.000208	0.004565	9.7	-0.140	9.560	0.043643
40	0.778	0.222	0.2	0.8	0.222	0.778	0.004773	-0.000208	0.004565	9.7	-0.140	9.560	0.043643
41	0.778	0.222	0.8	0.2	0.222	0.778	0.004773	-0.000208	0.004565	9.7	-0.140	9.560	0.043643
42	0.778	0.222	0.2	0.8	0.778	0.222	0.004773	-0.000208	0.004565	9.7	-0.140	9.560	0.043643
43	0.222	0.778	0.2	0.8	0.778	0.222	0.004773	-0.000208	0.004565	9.7	-0.140	9.560	0.043643
44	0.222	0.778	0.8	0.2	0.778	0.222	0.004773	-0.000208	0.004565	9.7	-0.140	9.560	0.043643
45	0.222	0.778	0.2	0.8	0.222	0.778	0.004773	-0.000208	0.004565	9.7	-0.140	9.560	0.043643
46	0.222	0.778	0.8	0.2	0.222	0.222	0.001362	-0.000208	0.001154	9.7	-0.140	9.560	0.011034
47	0.778	0.222	0.2	0.2	0.222	0.778	0.001193	-0.000208	0.000985	9.7	-0.140	9.560	0.009421
48	0.778	0.222	0.2	0.2	0.778	0.222	0.001193	-0.000208	0.000985	9.7	-0.140	9.560	0.009421
49	0.222	0.778	0.2	0.8	0.222	0.222	0.001362	-0.000208	0.001154	9.7	-0.140	9.560	0.011034
50	0.222	0.778	0.2	0.2	0.222	0.778	0.001193	-0.000208	0.000985	9.7	-0.140	9.560	0.009421
51	0.778	0.222	0.8	0.2	0.222	0.222	0.001362	-0.000208	0.001154	9.7	-0.140	9.560	0.011034
52	0.222	0.222	0.2	0.8	0.778	0.222	0.001362	-0.000208	0.001154	9.7	-0.140	9.560	0.011034
53	0.222	0.778	0.2	0.2	0.778	0.222	0.001193	-0.000208	0.000985	9.7	-0.140	9.560	0.009421
54	0.778	0.222	0.2	0.8	0.222	0.222	0.001362	-0.000208	0.001154	9.7	-0.140	9.560	0.011034
55	0.222	0.222	0.8	0.2	0.222	0.778	0.001362	-0.000208	0.001154	9.7	-0.140	9.560	0.011034
56	0.222	0.222	0.8	0.2	0.778	0.222	0.001362	-0.000208	0.001154	9.7	-0.140	9.560	0.011034
57	0.222	0.222	0.2	0.8	0.222	0.778	0.001362	-0.000208	0.001154	9.7	-0.140	9.560	0.011034
58	0.222	0.778	0.2	0.2	0.222	0.222	0.000340	-0.000208	0.000133	10.0	-0.140	9.860	0.001309
59	0.222	0.222	0.8	0.2	0.222	0.222	0.000389	-0.000208	0.000181	10.0	-0.140	9.860	0.001784
60	0.222	0.222	0.2	0.8	0.222	0.222	0.000389	-0.000208	0.000181	10.0	-0.140	9.860	0.001784
61	0.778	0.222	0.2	0.2	0.222	0.222	0.000340	-0.000208	0.000133	10.0	-0.140	9.860	0.001309
62	0.222	0.222	0.2	0.2	0.222	0.778	0.000340	-0.000208	0.000133	10.0	-0.140	9.860	0.001309
63	0.222	0.222	0.2	0.2	0.778	0.222	0.000340	-0.000208	0.000133	10.0	-0.140	9.860	0.001309
64	0.222	0.222	0.2	0.2	0.222	0.222	0.000097	-0.000208	-0.000111	11.5	-0.140	11.360	-0.001256 6.094193

Example Problem 5

SBL1 - ITERATION 1

	P(a _{ol1})	P(a _{ol2})	P(a _{cl1})	P(a _{cl2})	P(a _{CR1})	P(a _{CR2})	P(i)	Adj P(i)	P'(i)	h _{base}	h _{adj}	h _{sl}	P'(i)*h _{sl}
1	0.778	0.778	0.778	0.778	0.8	0.8	0.234476	0.017621	0.252096	4.5	0.100	4.600	1.159644
2	0.222	0.778	0.778	0.778	0.8	0.8	0.066907	0.002812	0.069719	5.0	0.100	5.100	0.355567
3	0.778	0.222	0.778	0.778	0.8	0.8	0.066907	0.002812	0.069719	5.0	0.100	5.100	0.355567
4	0.222	0.222	0.778	0.778	0.8	0.8	0.019092	0.002812	0.021904	6.2	0.100	6.300	0.137994
5	0.778	0.778	0.778	0.222	0.8	0.8	0.066907	-0.000784	0.066123	6.4	0.100	6.500	0.429799
6	0.778	0.778	0.222	0.778	0.8	0.8	0.066907	-0.000784	0.066123	6.4	0.100	6.500	0.429799
7	0.778	0.778	0.778	0.778	0.2	0.8	0.058619	-0.000784	0.057835	6.4	0.100	6.500	0.375927
8	0.778	0.778	0.778	0.778	0.8	0.2	0.058619	-0.000784	0.057835	6.4	0.100	6.500	0.375927
9	0.778	0.778	0.222	0.222	0.8	0.8	0.019092	-0.000784	0.018308	7.2	0.100	7.300	0.133645
10	0.778	0.778	0.778	0.778	0.2	0.2	0.014655	-0.000784	0.013871	7.2	0.100	7.300	0.101255
11	0.778	0.778	0.778	0.222	0.8	0.2	0.016727	-0.000583	0.016144	7.6	0.100	7.700	0.124306
12	0.778	0.778	0.222	0.778	0.8	0.2	0.016727	-0.000583	0.016144	7.6	0.100	7.700	0.124306
13	0.778	0.778	0.222	0.778	0.2	0.8	0.016727	-0.000583	0.016144	7.6	0.100	7.700	0.124306
14	0.778	0.778	0.778	0.222	0.2	0.8	0.016727	-0.000583	0.016144	7.6	0.100	7.700	0.124306
15	0.778	0.222	0.778	0.222	0.8	0.8	0.019092	-0.000583	0.018509	7.6	0.100	7.700	0.142517
16	0.222	0.778	0.222	0.778	0.8	0.8	0.019092	-0.000583	0.018509	7.6	0.100	7.700	0.142517
17	0.778	0.222	0.778	0.778	0.2	0.8	0.016727	-0.000583	0.016144	7.6	0.100	7.700	0.124306
18	0.222	0.778	0.778	0.222	0.8	0.8	0.019092	-0.000583	0.018509	7.6	0.100	7.700	0.142517
19	0.778	0.222	0.222	0.778	0.8	0.8	0.019092	-0.000583	0.018509	7.6	0.100	7.700	0.142517
20	0.778	0.222	0.778	0.778	0.8	0.2	0.016727	-0.000583	0.016144	7.6	0.100	7.700	0.124306
21	0.222	0.778	0.778	0.778	0.2	0.8	0.016727	-0.000583	0.016144	7.6	0.100	7.700	0.124306
22	0.222	0.778	0.778	0.778	0.8	0.2	0.016727	-0.000583	0.016144	7.6	0.100	7.700	0.124306
23	0.778	0.778	0.778	0.222	0.2	0.2	0.004182	-0.000583	0.003599	7.8	0.100	7.900	0.028429
24	0.778	0.778	0.222	0.222	0.8	0.2	0.004773	-0.000583	0.004190	7.8	0.100	7.900	0.033100
25	0.778	0.778	0.222	0.222	0.2	0.8	0.004773	-0.000583	0.004190	7.8	0.100	7.900	0.033100
26	0.222	0.778	0.222	0.222	0.8	0.8	0.005448	-0.000583	0.004865	7.8	0.100	7.900	0.038431
27	0.222	0.222	0.222	0.778	0.8	0.8	0.005448	-0.000583	0.004865	7.8	0.100	7.900	0.038431
28	0.222	0.222	0.778	0.778	0.2	0.8	0.004773	-0.000583	0.004190	7.8	0.100	7.900	0.033100
29	0.222	0.222	0.778	0.778	0.8	0.2	0.004773	-0.000583	0.004190	7.8	0.100	7.900	0.033100
30	0.778	0.222	0.222	0.222	0.8	0.8	0.005448	-0.000583	0.004865	7.8	0.100	7.900	0.038431
31	0.222	0.778	0.778	0.778	0.2	0.2	0.004182	-0.000583	0.003599	7.8	0.100	7.900	0.028429
32	0.778	0.778	0.222	0.778	0.2	0.2	0.004182	-0.000583	0.003599	7.8	0.100	7.900	0.028429
33	0.222	0.222	0.778	0.222	0.8	0.8	0.005448	-0.000583	0.004865	7.8	0.100	7.900	0.038431
34	0.778	0.222	0.778	0.778	0.2	0.2	0.004182	-0.000583	0.003599	7.8	0.100	7.900	0.028429
35	0.222	0.222	0.778	0.778	0.2	0.2	0.001193	-0.000583	0.000610	9.0	0.100	9.100	0.005552
36	0.778	0.778	0.222	0.222	0.2	0.2	0.001193	-0.000583	0.000610	9.0	0.100	9.100	0.005552
37	0.222	0.222	0.222	0.222	0.8	0.8	0.001555	-0.000583	0.000971	9.0	0.100	9.100	0.008840
38	0.778	0.222	0.778	0.222	0.8	0.2	0.004773	-0.000208	0.004565	9.7	0.100	9.800	0.044739
39	0.222	0.778	0.778	0.222	0.2	0.8	0.004773	-0.000208	0.004565	9.7	0.100	9.800	0.044739
40	0.778	0.222	0.222	0.778	0.2	0.8	0.004773	-0.000208	0.004565	9.7	0.100	9.800	0.044739
41	0.778	0.222	0.778	0.222	0.2	0.8	0.004773	-0.000208	0.004565	9.7	0.100	9.800	0.044739
42	0.778	0.222	0.222	0.778	0.8	0.2	0.004773	-0.000208	0.004565	9.7	0.100	9.800	0.044739
43	0.222	0.778	0.222	0.778	0.8	0.2	0.004773	-0.000208	0.004565	9.7	0.100	9.800	0.044739
44	0.222	0.778	0.778	0.222	0.8	0.2	0.004773	-0.000208	0.004565	9.7	0.100	9.800	0.044739
45	0.222	0.778	0.222	0.778	0.2	0.8	0.004773	-0.000208	0.004565	9.7	0.100	9.800	0.044739
46	0.222	0.778	0.778	0.222	0.2	0.2	0.001193	-0.000208	0.000985	9.7	0.100	9.800	0.009658
47	0.778	0.222	0.222	0.222	0.2	0.8	0.001362	-0.000208	0.001154	9.7	0.100	9.800	0.011311
48	0.778	0.222	0.222	0.222	0.8	0.2	0.001362	-0.000208	0.001154	9.7	0.100	9.800	0.011311
49	0.222	0.778	0.222	0.778	0.2	0.2	0.001193	-0.000208	0.000985	9.7	0.100	9.800	0.009658
50	0.222	0.778	0.222	0.222	0.2	0.8	0.001362	-0.000208	0.001154	9.7	0.100	9.800	0.011311
51	0.778	0.222	0.778	0.222	0.2	0.2	0.001193	-0.000208	0.000985	9.7	0.100	9.800	0.009658
52	0.222	0.222	0.222	0.778	0.8	0.2	0.001362	-0.000208	0.001154	9.7	0.100	9.800	0.011311
53	0.222	0.778	0.222	0.222	0.8	0.2	0.001362	-0.000208	0.001154	9.7	0.100	9.800	0.011311
54	0.778	0.222	0.222	0.778	0.2	0.2	0.001193	-0.000208	0.000985	9.7	0.100	9.800	0.009658
55	0.222	0.222	0.778	0.222	0.2	0.8	0.001362	-0.000208	0.001154	9.7	0.100	9.800	0.011311
56	0.222	0.222	0.778	0.222	0.8	0.2	0.001362	-0.000208	0.001154	9.7	0.100	9.800	0.011311
57	0.222	0.222	0.222	0.778	0.2	0.8	0.001362	-0.000208	0.001154	9.7	0.100	9.800	0.011311
58	0.222	0.778	0.222	0.222	0.2	0.2	0.000340	-0.000208	0.000133	10.0	0.100	10.100	0.001341
59	0.222	0.222	0.778	0.222	0.2	0.2	0.000340	-0.000208	0.000133	10.0	0.100	10.100	0.001341
60	0.222	0.222	0.222	0.778	0.2	0.2	0.000340	-0.000208	0.000133	10.0	0.100	10.100	0.001341
61	0.778	0.222	0.222	0.222	0.2	0.2	0.000340	-0.000208	0.000133	10.0	0.100	10.100	0.001341
62	0.222	0.222	0.222	0.222	0.2	0.8	0.000389	-0.000208	0.000181	10.0	0.100	10.100	0.001827
63	0.222	0.222	0.222	0.222	0.8	0.2	0.000389	-0.000208	0.000181	10.0	0.100	10.100	0.001827
64	0.222	0.222	0.222	0.222	0.2	0.2	0.000097	-0.000208	-0.000111	11.5	0.100	11.600	-0.001283 6.334193

SBL2 - ITERATION 1

Example Problem 5

	P(a _{OL1})	P(a _{OL2})	P(a _{CL1})	P(a _{CL2})	P(a _{CR1})	P(a _{CR2})	P(i)	Adj P(i)	P'(i)	h _{base}	h _{adj}	h _{sl}	P'(i)*h _{sl}
1	0.778	0.778	0.778	0.778	0.8	0.8	0.234476	0.017621	0.252096	4.5	-0.420	4.080	1.028554
2	0.222	0.778	0.778	0.778	0.8	0.8	0.066907	0.002812	0.069719	5.0	-0.420	4.580	0.319313
3	0.778	0.222	0.778	0.778	0.8	0.8	0.066907	0.002812	0.069719	5.0	-0.420	4.580	0.319313
4	0.222	0.222	0.778	0.778	0.8	0.8	0.019092	0.002812	0.021904	6.2	-0.420	5.780	0.126604
5	0.778	0.778	0.778	0.222	0.8	0.8	0.066907	-0.000784	0.066123	6.4	-0.420	5.980	0.395415
6	0.778	0.778	0.222	0.778	0.8	0.8	0.066907	-0.000784	0.066123	6.4	-0.420	5.980	0.395415
7	0.778	0.778	0.778	0.778	0.2	0.8	0.058619	-0.000784	0.057835	6.4	-0.420	5.980	0.345852
8	0.778	0.778	0.778	0.778	0.8	0.2	0.058619	-0.000784	0.057835	6.4	-0.420	5.980	0.345852
9	0.778	0.778	0.222	0.222	0.8	0.8	0.019092	-0.000784	0.018308	7.2	-0.420	6.780	0.124125
10	0.778	0.778	0.778	0.778	0.2	0.2	0.014655	-0.000784	0.013871	7.2	-0.420	6.780	0.094043
11	0.778	0.778	0.778	0.222	0.8	0.2	0.016727	-0.000583	0.016144	7.6	-0.420	7.180	0.115912
12	0.778	0.778	0.222	0.778	0.8	0.2	0.016727	-0.000583	0.016144	7.6	-0.420	7.180	0.115912
13	0.778	0.778	0.222	0.778	0.2	0.8	0.016727	-0.000583	0.016144	7.6	-0.420	7.180	0.115912
14	0.778	0.778	0.778	0.222	0.2	0.8	0.016727	-0.000583	0.016144	7.6	-0.420	7.180	0.115912
15	0.778	0.222	0.778	0.222	0.8	0.8	0.019092	-0.000583	0.018509	7.6	-0.420	7.180	0.132892
16	0.222	0.778	0.222	0.778	0.8	0.8	0.019092	-0.000583	0.018509	7.6	-0.420	7.180	0.132892
17	0.778	0.222	0.778	0.778	0.2	0.8	0.016727	-0.000583	0.016144	7.6	-0.420	7.180	0.115912
18	0.222	0.778	0.778	0.222	0.8	0.8	0.019092	-0.000583	0.018509	7.6	-0.420	7.180	0.132892
19	0.778	0.222	0.222	0.778	0.8	0.8	0.019092	-0.000583	0.018509	7.6	-0.420	7.180	0.132892
20	0.778	0.222	0.778	0.778	0.8	0.2	0.016727	-0.000583	0.016144	7.6	-0.420	7.180	0.115912
21	0.222	0.778	0.778	0.778	0.2	0.8	0.016727	-0.000583	0.016144	7.6	-0.420	7.180	0.115912
22	0.222	0.778	0.778	0.778	0.8	0.2	0.016727	-0.000583	0.016144	7.6	-0.420	7.180	0.115912
23	0.778	0.778	0.778	0.222	0.2	0.2	0.004182	-0.000583	0.003599	7.8	-0.420	7.380	0.026558
24	0.778	0.778	0.222	0.222	0.8	0.2	0.004773	-0.000583	0.004190	7.8	-0.420	7.380	0.030921
25	0.778	0.778	0.222	0.222	0.2	0.8	0.004773	-0.000583	0.004190	7.8	-0.420	7.380	0.030921
26	0.222	0.778	0.222	0.222	0.8	0.8	0.005448	-0.000583	0.004865	7.8	-0.420	7.380	0.035901
27	0.222	0.222	0.222	0.778	0.8	0.8	0.005448	-0.000583	0.004865	7.8	-0.420	7.380	0.035901
28	0.222	0.222	0.778	0.778	0.2	0.8	0.004773	-0.000583	0.004190	7.8	-0.420	7.380	0.030921
29	0.222	0.222	0.778	0.778	0.8	0.2	0.004773	-0.000583	0.004190	7.8	-0.420	7.380	0.030921
30	0.778	0.222	0.222	0.222	0.8	0.8	0.005448	-0.000583	0.004865	7.8	-0.420	7.380	0.035901
31	0.222	0.778	0.778	0.778	0.2	0.2	0.004182	-0.000583	0.003599	7.8	-0.420	7.380	0.026558
32	0.778	0.778	0.222	0.778	0.2	0.2	0.004182	-0.000583	0.003599	7.8	-0.420	7.380	0.026558
33	0.222	0.222	0.778	0.222	0.8	0.8	0.005448	-0.000583	0.004865	7.8	-0.420	7.380	0.035901
34	0.778	0.222	0.778	0.778	0.2	0.2	0.004182	-0.000583	0.003599	7.8	-0.420	7.380	0.026558
35	0.222	0.222	0.778	0.778	0.2	0.2	0.001193	-0.000583	0.000610	9.0	-0.420	8.580	0.005235
36	0.778	0.778	0.222	0.222	0.2	0.2	0.001193	-0.000583	0.000610	9.0	-0.420	8.580	0.005235
37	0.222	0.222	0.222	0.222	0.8	0.8	0.001555	-0.000583	0.000971	9.0	-0.420	8.580	0.008335
38	0.778	0.222	0.778	0.222	0.8	0.2	0.004773	-0.000208	0.004565	9.7	-0.420	9.280	0.042365
39	0.222	0.778	0.778	0.222	0.2	0.8	0.004773	-0.000208	0.004565	9.7	-0.420	9.280	0.042365
40	0.778	0.222	0.222	0.778	0.2	0.8	0.004773	-0.000208	0.004565	9.7	-0.420	9.280	0.042365
41	0.778	0.222	0.778	0.222	0.2	0.8	0.004773	-0.000208	0.004565	9.7	-0.420	9.280	0.042365
42	0.778	0.222	0.222	0.778	0.8	0.2	0.004773	-0.000208	0.004565	9.7	-0.420	9.280	0.042365
43	0.222	0.778	0.222	0.778	0.8	0.2	0.004773	-0.000208	0.004565	9.7	-0.420	9.280	0.042365
44	0.222	0.778	0.778	0.222	0.8	0.2	0.004773	-0.000208	0.004565	9.7	-0.420	9.280	0.042365
45	0.222	0.778	0.222	0.778	0.2	0.8	0.004773	-0.000208	0.004565	9.7	-0.420	9.280	0.042365
46	0.222	0.778	0.778	0.222	0.2	0.2	0.001193	-0.000208	0.000985	9.7	-0.420	9.280	0.009145
47	0.778	0.222	0.222	0.222	0.2	0.8	0.001362	-0.000208	0.001154	9.7	-0.420	9.280	0.010711
48	0.778	0.222	0.222	0.222	0.8	0.2	0.001362	-0.000208	0.001154	9.7	-0.420	9.280	0.010711
49	0.222	0.778	0.222	0.778	0.2	0.2	0.001193	-0.000208	0.000985	9.7	-0.420	9.280	0.009145
50	0.222	0.778	0.222	0.222	0.2	0.8	0.001362	-0.000208	0.001154	9.7	-0.420	9.280	0.010711
51	0.778	0.222	0.778	0.222	0.2	0.2	0.001193	-0.000208	0.000985	9.7	-0.420	9.280	0.009145
52	0.222	0.222	0.222	0.778	0.8	0.2	0.001362	-0.000208	0.001154	9.7	-0.420	9.280	0.010711
53	0.222	0.778	0.222	0.222	0.8	0.2	0.001362	-0.000208	0.001154	9.7	-0.420	9.280	0.010711
54	0.778	0.222	0.222	0.778	0.2	0.2	0.001193	-0.000208	0.000985	9.7	-0.420	9.280	0.009145
55	0.222	0.222	0.778	0.222	0.2	0.8	0.001362	-0.000208	0.001154	9.7	-0.420	9.280	0.010711
56	0.222	0.222	0.778	0.222	0.8	0.2	0.001362	-0.000208	0.001154	9.7	-0.420	9.280	0.010711
57	0.222	0.222	0.222	0.778	0.2	0.8	0.001362	-0.000208	0.001154	9.7	-0.420	9.280	0.010711
58	0.222	0.778	0.222	0.222	0.2	0.2	0.000340	-0.000208	0.000133	10.0	-0.420	9.580	0.001272
59	0.222	0.222	0.778	0.222	0.2	0.2	0.000340	-0.000208	0.000133	10.0	-0.420	9.580	0.001272
60	0.222	0.222	0.222	0.778	0.2	0.2	0.000340	-0.000208	0.000133	10.0	-0.420	9.580	0.001272
61	0.778	0.222	0.222	0.222	0.2	0.2	0.000340	-0.000208	0.000133	10.0	-0.420	9.580	0.001272
62	0.222	0.222	0.222	0.222	0.2	0.8	0.000389	-0.000208	0.000181	10.0	-0.420	9.580	0.001733
63	0.222	0.222	0.222	0.222	0.8	0.2	0.000389	-0.000208	0.000181	10.0	-0.420	9.580	0.001733
64	0.222	0.222	0.222	0.222	0.2	0.2	0.000097	-0.000208	-0.000111	11.5	-0.420	11.080	-0.001225 5.814193

Example Problem 5

AWSC - UNSIGNALIZED INTERSECTIONS WORKSHEET								
Worksheet 5								
General Information								
Project Description <u>Example Problem 5</u>								
Capacity and Level of Service								
	EB		WB		NB		SB	
	L1	L2	L1	L2	L1	L2	L1	L2
Total lane flow rate (veh/h)	225	225	250	250	250	250	250	250
Departure headway, h_d (s)	8.708	8.331	8.686	8.206	8.686	8.346	8.586	8.066
Degree of utilization, x	0.554	0.521	0.603	0.570	0.603	0.580	0.596	0.560
Move-up time, m (s)	2.30	2.30	2.30	2.30	2.30	2.30	2.30	2.30
Service time, t_s (s)	6.408	6.031	6.386	5.906	6.386	6.046	6.286	5.766
Capacity (veh/h)	385	400	390	410	410	430	395	420
Delay (s) (Equation 17-55)	21.3	19.7	23.7	21.2	23.7	21.9	23.2	20.6
Level of service (Exhibit 17-22)	C	C	C	C	C	C	C	C
Delay, approach (s/veh)	20.5		22.5		22.8		21.9	
Level of service, approach	C		C		C		C	
Delay, intersection (s/veh)	22.0							
Level of service, intersection	C							

EXAMPLE PROBLEM 6

Roundabout A four-leg roundabout.

The Question What are the capacity and v/c ratio?

The Facts

- √ Two two-way, two-lane streets, √ PHF = 1.00, and
- √ One-lane roundabout, √ Duration T = 0.25 h.
- √ Circulating flow less than 1,200 veh/h,

Outline to Solution The steps below show the eastbound approach calculations only. Calculations for other approaches are shown on the worksheets.

Steps

1. Input project information and movement volumes	
2. Adjust traffic volumes for peaking approach flows	$V_x = \frac{\text{Volume}}{\text{PHF}}$ $V_{\text{EBLT}} = \frac{247}{1.00} = 247 \text{ veh/h}$
3. Circulating flow (use equations provided in the Worksheet). Note that Exhibit 17-39 shows movement designations	$V_{c,E} = V_4 + V_{10} + V_{11}$ $V_{c,E} = 103 + 254 + 94 = 451 \text{ veh/h}$
4. Compute upper-bound and lower-bound capacities (use Equation 17-70 and Exhibit 17-37)	$C_a = \frac{V_c e^{-V_c t_c / 3,600}}{1 - e^{-V_c t_r / 3,600}}$ <p>EB upper-bound capacity</p> $C_a = \frac{451 e^{-451(4.1) / 3,600}}{1 - e^{-451(2.6) / 3,600}} = 971 \text{ veh/h}$ <p>EB lower-bound capacity</p> $C_a = \frac{451 e^{-451(4.6) / 3,600}}{1 - e^{-451(3.1) / 3,600}} = 788 \text{ veh/h}$
5. v/c ratio	<p>EB upper-bound v/c = $\frac{V_{a,E}}{C_{EB}}$</p> $v/c = \frac{660}{971} = 0.680$

Comments

As a concluding comment, it is useful to show how variations in the critical gap and follow-up time values can affect the analysis results. The results obtained above can be used as a point of reference. To see what happens when alternative values are used, the results obtained from these values are compared with those obtained by using the upper-bound and lower-bound combinations. The table below shows that shifting to the upper-bound solution produces about an 11 percent increase in the v/c ratio, whereas shifting to the lower-bound values produces about a 10 percent decrease. From the westbound approach, the capacity increases to 864 veh/h with the upper-bound values and decreases to 693 veh/h with the lower-bound values. The implication is that variations of about ±10 percent can be obtained by deviating from the midpoints of the value ranges.

Example Problem 6

EFFECTS OF CHANGES IN CRITICAL GAP AND MOVE-UP TIME			
	Scenario		
	A	B	C
t_f	3.10	2.85	2.60
t_c	4.60	4.35	4.10
Capacity (Equation 17-70)			
EB	788	871	971
WB	693	770	864
NB	573	644	728
SB	667	744	835
v/c Ratio			
EB	0.84	0.76	0.68
WB	0.83	0.80	0.72
NB	0.74	0.66	0.59
SB	0.75	0.67	0.60

ROUNDBABOUTS - UNSIGNALIZED INTERSECTIONS WORKSHEET					
General Information			Site Information		
Analyst	AJR		Intersection	Buena Vista/El Moro	
Agency or Company	CEI		Jurisdiction	Maricopa County	
Date Performed	5/10/99		Analysis Year	1999	
Analysis Time Period	AM Peak				
Volume Adjustments					
		EB	WB	NB	SB
LT Traffic	Movement	v_1	v_4	v_7	v_{10}
	Volume, veh/h	247	103	143	254
	PHF	1.00	1.00	1.00	1.00
	Flow rate, veh/h	247	103	143	254
TH Traffic	Movement	v_2	v_5	v_8	v_{11}
	Volume, veh/h	308	393	207	94
	PHF	1.00	1.00	1.00	1.00
	Flow rate, veh/h	308	393	207	94
RT Traffic	Movement	v_3	v_6	v_9	v_{12}
	Volume, veh/h	105	123	77	152
	PHF	1.00	1.00	1.00	1.00
	Flow rate, veh/h	105	123	77	152
Approach Flow Computation					
Approach Flow (veh/h)		v_a (veh/h)			
$v_{a,E} = v_1 + v_2 + v_3$		660			
$v_{a,W} = v_4 + v_5 + v_6$		619			
$v_{a,N} = v_7 + v_8 + v_9$		427			
$v_{a,S} = v_{10} + v_{11} + v_{12}$		500			
Circulating Flow Computation					
Approach Flow (veh/h)		v_c (veh/h)			
$v_{c,E} = v_4 + v_{10} + v_{11}$		451			
$v_{c,W} = v_1 + v_7 + v_8$		597			
$v_{c,N} = v_1 + v_2 + v_{10}$		809			
$v_{c,S} = v_4 + v_5 + v_7$		639			
Capacity Computation					
		EB	WB	NB	SB
Capacity (Equation 17-70)	Upper bound	971	864	728	835
	Lower bound	788	693	573	667
v/c Ratio	Upper bound	0.680	0.716	0.587	0.599
	Lower bound	0.838	0.893	0.745	0.750

REFERENCES

PART A - TWSC UNSIGNALIZED INTERSECTIONS

1. Brilon, W., and M. Großmann. Aktualisiertes Berechnungsverfahren für Knotenpunkte ohne Lichtsignalanlagen. *Forschung Strassenbau und Strassenverkehrstechnik*, Heft 596, 1991.

2. *A Policy on Geometric Design of Highways and Streets*. American Association of State Highway and Transportation Officials, Washington, D.C., 1994.
3. *Manual on Uniform Traffic Control Devices*. U.S. Department of Transportation, 1988.
4. Kyte, M., Z. Tian, Z. Mir, Z. Hameedmansoor, W. Kittelson, M. Vandehey, B. Robinson, W. Brilon, L. Bondzio, N. Wu, and R. Troutbeck. *NCHRP Web Document 5: Capacity and Level of Service at Unsignalized Intersections: Final Report, Vol. 1—Two-Way Stop-Controlled Intersections*. 1997. <http://www.nap.edu/books/nch005/html>.
5. Troutbeck, R. *Estimating the Critical Acceptance Gap from Traffic Movements*. Research Report 92-5. Queensland University of Technology, Australia, March 1992.
6. Siegloch, W. Die Leistungsermittlung an Knotenpunkten ohne Lichtsignalsteuerung. *Forschung Strassenbau und Strassenverkehrstechnik*, Heft 154, 1973.
7. Harders, J. Die Leistungsfähigkeit nicht Signal geregelter Städtischer Verkehrsknoten. *Forschung Strassenbau und Strassenverkehrstechnik*, Heft 76, 1968.
8. Robertson, D. I. Coordinating Traffic Signals to Reduce Fuel Consumption. *Proceedings of the Royal Society Series A*, Vol. 387, No. 1792, 1983, pp. 1–19.
9. Yu, L., and M. Van Aerde. Implementing TRANSYT's Macroscopic Platoon Dispersion in Microscopic Traffic Simulation Models. Presented at 74th Annual Meeting of the Transportation Research Board, Washington, D.C., 1995.
10. Bonneson, J. A., and J. W. Fitts. Effect of Upstream Signal on Nonpriority Movement Capacity and Delay. In *Transportation Research Record 1572*, TRB, National Research Council, Washington, D.C., 1997, pp. 174–182.
11. Wu, N. An Approximation for the Distribution of Queue Lengths at Unsignalized Intersections. *Proc., Second International Symposium on Highway Capacity*, Vol. 2, Australian Road Research Board, Ltd., Aug. 1994.
12. Pline, J. (ed.). *Traffic Engineering Handbook*. Institute of Transportation Engineers, Prentice-Hall, Englewood Cliffs, N.J., 1992.

PART B - AWSC UNSIGNALIZED INTERSECTIONS

1. Kyte, M., Z. Tian, Z. Mir, Z. Hameedmansoor, W. Kittelson, M. Vandehey, B. Robinson, W. Brilon, L. Bondzio, N. Wu, and R. Troutbeck. *NCHRP Web Document 6: Capacity and Level of Service at Unsignalized Intersections: Final Report, Vol. 2—All-Way Stop-Controlled Intersections*. 1997. <http://www.nap.edu/books/nch006/html>.
2. Richardson, A. J. A Delay Model for Multiway Stop-Sign Intersections. In *Transportation Research Record 1112*, TRB, National Research Council, Washington, D.C., 1987, pp. 107–114.

PART C - ROUNDABOUTS

1. Kyte, M., Z. Tian, Z. Mir, Z. Hameedmansoor, W. Kittelson, M. Vandehey, B. Robinson, W. Brilon, L. Bondzio, N. Wu, and R. Troutbeck. *NCHRP Web Document 5: Capacity and Level of Service at Unsignalized Intersections: Final Report, Vol. 1—Two-Way Stop-Controlled Intersections*. 1997. <http://www.nap.edu/books/nch005/html>.
2. Brilon, W., and B. Stuwe. Capacity and Design of Traffic Circles in Germany. In *Transportation Research Record 1398*, TRB, National Research Council, Washington, D.C., 1993, pp. 61–67.
3. Troutbeck, R. J. Capacity and Design of Traffic Circles in Australia. In *Transportation Research Record 1398*, TRB, National Research Council, Washington, D.C., 1993, pp. 68–74.

4. Akcelik, R., and M. Besley. *SIDRA 5 User Guide*. ARRB Transport Research, Ltd., June 1996.
5. Flannery, A., and T. Datta. Operational Performance Measures of American Roundabouts. In *Transportation Research Record 1572*, TRB, National Research Council, Washington, D.C., 1997, pp. 68–75.
6. Troutbeck, R. Background for HCM Section on Analysis of Performance of Roundabouts. In *Transportation Research Record 1646*, TRB, National Research Council, Washington, D.C., 1998, pp. 54–62.

APPENDIX A. WORKSHEETS

PART A - TWSC UNSIGNALIZED INTERSECTIONS

WORKSHEET 1 - GEOMETRICS AND MOVEMENTS

WORKSHEET 2 - VOLUME ADJUSTMENTS

WORKSHEET 3 - SITE CHARACTERISTICS

WORKSHEET 4 - CRITICAL GAP AND FOLLOW-UP TIME

WORKSHEET 5 - EFFECT OF UPSTREAM SIGNALS

WORKSHEET 6 - IMPEDANCE AND CAPACITY CALCULATION

WORKSHEET 7 - EFFECT OF TWO-STAGE GAP ACCEPTANCE

WORKSHEET 8 - SHARED-LANE CAPACITY

WORKSHEET 9 - EFFECT OF FLARED MINOR-STREET APPROACHES

WORKSHEET 10 - CONTROL DELAY, QUEUE LENGTH, LEVEL OF SERVICE

WORKSHEET 11 - DELAY TO RANK 1 VEHICLES

PART B - AWSC UNSIGNALIZED INTERSECTIONS

WORKSHEET 1 - GEOMETRICS AND MOVEMENTS

WORKSHEET 2 - VOLUME ADJUSTMENTS AND LANE ASSIGNMENTS

WORKSHEET 3 - SATURATION HEADWAYS

WORKSHEET 4 - DEPARTURE HEADWAY AND SERVICE TIME

WORKSHEET 5 - CAPACITY AND LEVEL OF SERVICE

PART C - ROUNDABOUTS

ROUNDABOUT WORKSHEET

TWSC - UNSIGNALIZED INTERSECTIONS WORKSHEET

Worksheet 1

General Information	Site Information
Analyst _____	Intersection _____
Agency or Company _____	Jurisdiction _____
Date Performed _____	Analysis Year _____
Analysis Time Period _____	

Geometrics and Movements

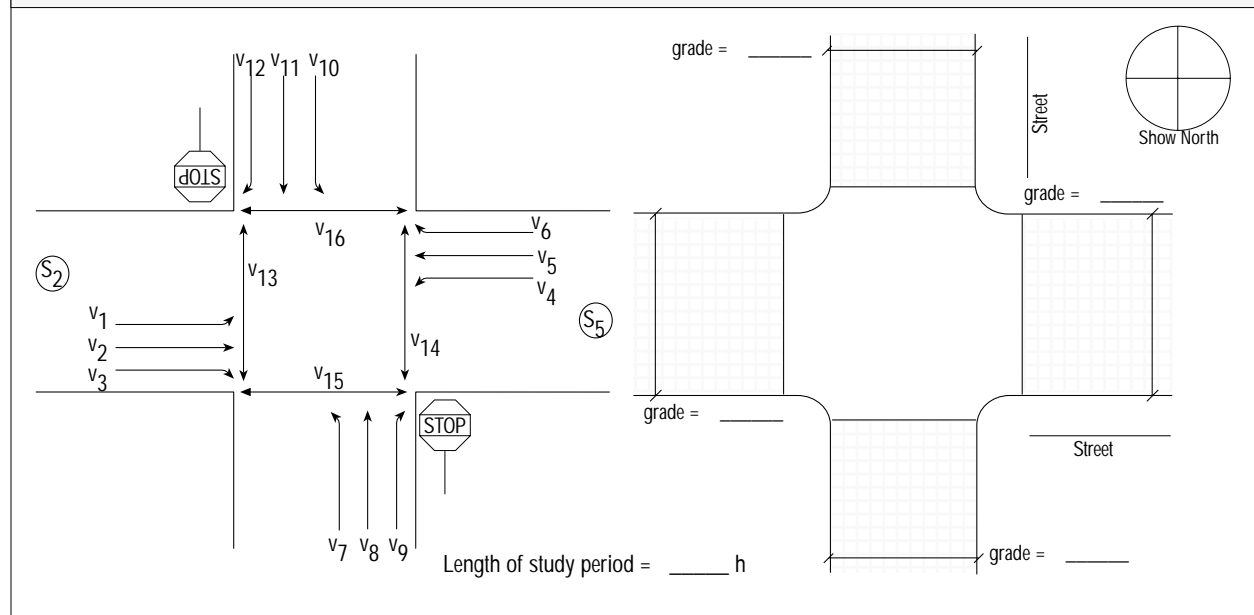

Worksheet 2

Vehicle Volumes and Adjustments												
Movement	Vehicle Volumes and Adjustments											
	1	2	3	4	5	6	7	8	9	10	11	12
Volume (veh/h)												
Peak-hour factor, PHF												
Hourly flow rate (veh/h)												
Proportion of heavy vehicles, P_{HV}												

Pedestrian Volumes and Adjustments				
Movement	13	14	15	16
Flow, V_x (ped/h)				
Lane width, w (m)				
Walking speed, ¹ S_p (m/s)				
Percent blockage, f_p (Equation 17-11)				

1. Default walking speed = 1.2 m/s

TWSC - UNSIGNALIZED INTERSECTIONS WORKSHEET								
Worksheet 3								
General Information								
Project Description _____								
Lane Designation								
Movements	Lane 1	Lane 2	Lane 3	Grade, G	Right Turn Channelized?			
1, 2, 3								
4, 5, 6								
7, 8, 9								
10, 11, 12								
Flared Minor-Street Approach								
Movement 9	<input type="checkbox"/> Yes	<input type="checkbox"/> No	Storage space, n	_____				
				(number of vehicles)				
Movement 12	<input type="checkbox"/> Yes	<input type="checkbox"/> No	Storage space, n	_____				
				(number of vehicles)				
Median Storage*								
* Includes raised or striped median (RM), or two-way left-turn lane (TWLTL)								
Type								
Movements 7 and 8	<input type="checkbox"/> Yes	_____	<input type="checkbox"/> No	Storage space, m	_____			
					(number of vehicles)			
Movements 10 and 11	<input type="checkbox"/> Yes	_____	<input type="checkbox"/> No	Storage space, m	_____			
					(number of vehicles)			
Upstream Signals								
	Movements	Distance to Signal, D (m)	Prog Speed, S_{prog} (km/h)	Cycle Length, C (s)	Green Time, g_{eff} (s)	Arrival Type	Saturation Flow Rate, s (veh/h)	Progressed Flow, V_{prog} (veh/h)
S_2	protected LT					3		
	TH							
S_5	protected LT					3		
	TH							
Computing Delay to Major-Street Vehicles								
Data for Computing Effect of Delay to Major-Street Vehicles				S_2 Approach		S_5 Approach		
Shared-lane volume, major-street through vehicles, v_{11} , blocked by LT								
Shared-lane volume, major-street right-turn vehicles, v_{12} , blocked by LT								
Saturation flow rate, major-street through vehicles, s_{11}								
Saturation flow rate, major-street right-turn vehicles, s_{12}								
Number of major-street through lanes								
Length of study period, T (h)								

TWSC - UNSIGNALIZED INTERSECTIONS WORKSHEET

Worksheet 4

General Information

Project Description _____

Critical Gap and Follow-Up Time

$$t_c = t_{c,base} + t_{c,HV} P_{HV} + t_{c,G} G - t_{c,T} - t_{3,LT}$$

	Major LT		Minor RT		Minor TH		Minor LT	
Movement	1	4	9	12	8	11	7	10
$t_{c,base}$ (Exhibit 17-5)								
$t_{c,HV}$								
P_{HV} (from Worksheet 2)								
$t_{c,G}$	-	-	0.1	0.1	0.2	0.2	0.2	0.2
G (from Worksheet 3)								
$t_{3,LT}$								
$t_{c,T}$	single stage							
	two stage							
t_c (Equation 17-1)	single stage							
	two stage							

$$t_f = t_{f,base} + t_{f,HV} P_{HV}$$

	Major LT		Minor RT		Minor TH		Minor LT	
Movement	1	4	9	12	8	11	7	10
$t_{f,base}$ (Exhibit 17-5)								
$t_{f,HV}$								
P_{HV} (from Worksheet 2)								
t_f (Equation 17-2)								

Worksheet 5a

Time to Clear Standing Queue (Computation 1)

	Movement 2		Movement 5	
	$V_{T,prog}$	$V_{L,prot}$	$V_{T,prog}$	$V_{L,prot}$
Effective green, g_{eff} (s)				
Cycle length, C (s)				
Saturation flow rate, s (veh/h)				
Arrival type		3		3
v_{prog} (veh/h)				
R_p (from Chapter 16)		1.00		1.00
Proportion of vehicles arriving on green, P (Equation 17-17)				
g_{q1} (Equation 17-18)				
g_{q2} (Equation 17-19)				
g_q (Equation 17-20)				

TWSC - UNSIGNALIZED INTERSECTIONS WORKSHEET

Worksheet 5b

General Information

Project Description _____

Proportion of Time TWSC Intersection Is Blocked (Computation 2)

	Movement 2		Movement 5	
	$V_{T,prog}$	$V_{L,prot}$	$V_{T,prog}$	$V_{L,prot}$
α (Exhibit 17-13)				
$\beta = (1 + \alpha)^{-1}$				
$t_a = D/S_{prog}$ (s)				
$F = (1 + \alpha\beta t_a)^{-1}$				
$f = V_{prog}/V_c \geq 0$				
$V_{c,Max}$ (Equation 17-21)				
$V_{c,Min} = 1000N$				
t_p (Equation 17-22)				
p (Equation 17-23)				

Worksheet 5c

Platoon Event Periods (Computation 3)

p_2 (from Worksheet 5b)			
p_5 (from Worksheet 5b)			
p_{dom} (Equation 17-24)			
p_{subo} (Equation 17-25)			
Constrained or unconstrained (Equation 17-26, 17-27)			
Proportion for Minor Movements, p_x			
	Single-Stage (Exhibit 17-16)	Two-Stage	
		Stage I	Stage II
p_1			
p_4			
p_7		$1 - p_2$	$1 - p_5$
p_8		$1 - p_2$	$1 - p_5$
p_9			
p_{10}		$1 - p_5$	$1 - p_2$
p_{11}		$1 - p_5$	$1 - p_2$
p_{12}			

TWSC - UNSIGNALIZED INTERSECTIONS WORKSHEET

Worksheet 5d

General Information

Project Description _____

Conflicting Flows During Unblocked Period (Computation 4)

Single-Stage

Movements	1	4	7	8	9	10	11	12
$v_{c,x}$ (Exhibit 17-4)								
s (veh/h)								
p_x (from Worksheet 5c)								
$v_{c,u,x}$ (Equation 17-28)								

Two-Stage

Movements	7		8		10		11	
	Stage I	Stage II	Stage I	Stage II	Stage I	Stage II	Stage I	Stage II
$v_{c,x}$ (Exhibit 17-2)								
s (veh/h)								
p_x (from Worksheet 5c)								
$V_{c,u,x}$ (Equation 17-28)								

Worksheet 5e

Capacity During Unblocked Period (Computation 5)

Single-Stage

Movements	1	4	7	8	9	10	11	12
p_x (from Worksheet 5c)								
$c_{r,x}$ (Equation 17-3)								
$c_{plat,x}$ (Exhibit 17-29)								

Two-Stage

Movements	7		8		10		11	
	Stage I	Stage II	Stage I	Stage II	Stage I	Stage II	Stage I	Stage II
p_x (from Worksheet 5c)								
$c_{r,x}$ (Equation 17-3)								
$c_{plat,x}$ (Exhibit 17-29)								

TWSC - UNSIGNALIZED INTERSECTIONS WORKSHEET		
Worksheet 6		
General Information		
Project Description _____		
Impedance and Capacity Calculation		
Step 1: RT from Minor Street	v_9	v_{12}
Conflicting flows (Exhibit 17-4)	$v_{c,9} =$	$v_{c,12} =$
Potential capacity (Equation 17-3 or 17-29)	$c_{p,9} =$	$c_{p,12} =$
Ped impedance factor (Equation 17-12)	$p_{p,9} =$	$p_{p,12} =$
Movement capacity (Equation 17-4)	$c_{m,9} = c_{p,9} p_{p,9} =$	$c_{m,12} = c_{p,12} p_{p,12} =$
Prob of queue-free state (Equation 17-5)	$p_{0,9} =$	$p_{0,12} =$
Step 2: LT from Major Street	v_4	v_1
Conflicting flows (Exhibit 17-4)	$v_{c,4} =$	$v_{c,1} =$
Potential capacity (Equation 17-3 or 17-29)	$c_{p,4} =$	$c_{p,1} =$
Ped impedance factor (Equation 17-12)	$p_{p,4} =$	$p_{p,1} =$
Movement capacity (Equation 17-4)	$c_{m,4} = c_{p,4} p_{p,4} =$	$c_{m,1} = c_{p,1} p_{p,1} =$
Prob of queue-free state (Equation 17-5)	$p_{0,4} =$	$p_{0,1} =$
Major left shared lane prob of queue-free state (Equation 17-16)	$p_{0,4}^* =$	$p_{0,1}^* =$
Step 3: TH from Minor Street (4-leg intersections only)	v_8	v_{11}
Conflicting flows (Exhibit 17-4)	$v_{c,8} =$	$v_{c,11} =$
Potential capacity (Equation 17-3 or 17-29)	$c_{p,8} =$	$c_{p,11} =$
Ped impedance factor (Equation 17-12)	$p_{p,8} =$	$p_{p,11} =$
Capacity adjustment factor due to impeding movement (shared lane use p^*) (Equation 17-13)	$f_8 = p_{0,4} p_{0,1} p_{p,8} =$	$f_{11} = p_{0,4} p_{0,1} p_{p,11} =$
Movement capacity (Equation 17-7)	$c_{m,8} = c_{p,8} f_8 =$	$c_{m,11} = c_{p,11} f_{11} =$
Prob of queue-free state	$p_{0,8} =$	$p_{0,11} =$
Step 4: LT from Minor Street (4-leg intersections only)	v_7	v_{10}
Conflicting flows (Exhibit 17-4)	$v_{c,7} =$	$v_{c,10} =$
Potential capacity (Equation 17-3 or 17-29)	$c_{p,7} =$	$c_{p,10} =$
Ped impedance factor (Equation 17-12)	$p_{p,7} =$	$p_{p,10} =$
Major left, minor through impedance factor	$p_7^* = p_{0,11} f_{11} =$	$p_{10}^* = p_{0,8} f_8 =$
Major left, minor through adjusted impedance factor (Equation 17-8)	$p_7^{\dagger} =$	$p_{10}^{\dagger} =$
Capacity adjustment factor due to impeding movements (Equation 17-14)	$f_7 = p_7^{\dagger} p_{0,12} p_{p,7} =$	$f_{10} = p_{10}^{\dagger} p_{0,9} p_{p,10} =$
Movement capacity (Equation 17-10)	$c_{m,7} = f_7 c_{p,7} =$	$c_{m,10} = f_{10} c_{p,10} =$
Step 5: LT from Minor Street (T-intersections only)	v_7	v_{10}
Conflicting flows (Exhibit 17-4)	$v_{c,7} =$	$v_{c,10} =$
Potential capacity (Equation 17-3 or 17-29)	$c_{p,7} =$	$c_{p,10} =$
Ped impedance factor (Equation 17-12)	$p_{p,7} =$	$p_{p,10} =$
Capacity adjustment factor due to impeding movement (shared lane use p^*) (Equation 17-13)	$f_7 = p_{0,4} p_{0,1} p_{p,7} =$	$f_{10} = p_{0,4} p_{0,1} p_{p,10} =$
Movement capacity (Equation 17-7)	$c_{m,7} = c_{p,7} f_7 =$	$c_{m,10} = c_{p,10} f_{10} =$
Notes		
1. For 4-leg intersections use Steps 1, 2, 3, and 4.		
2. For T-intersections use Steps 1, 2, and 5.		

TWSC - UNSIGNALIZED INTERSECTIONS WORKSHEET

Worksheet 7a

General Information

Project Description _____

Effect of Two-Stage Gap Acceptance

Step 3: TH from Minor Street	V_8	V_{11}
Part I - First Stage		
Conflicting flows (Exhibit 17-4)	$V_{c,I,8} =$	$V_{c,I,11} =$
Potential capacity (Equation 17-3 or 17-29)	$C_{p,I,8} =$	$C_{p,I,11} =$
Ped impedance factor (Equation 17-12)	$P_{p,I,8} =$	$P_{p,I,11} =$
Capacity adjustment factor due to impeding movement (shared lane use p^*) (Equation 17-6 or 17-13)	$f_{I,8} = P_{0,1} P_{p,I,8} =$	$f_{I,11} = P_{0,4} P_{p,I,11} =$
Movement capacity (Equation 17-7)	$C_{m,I,8} = C_{p,I,8} f_{I,8} =$	$C_{m,I,11} = C_{p,I,11} f_{I,11} =$
Prob of queue-free state (Equation 17-5)	$P_{0,I,8} =$	$P_{0,I,11} =$
Part II - Second Stage		
Conflicting flows (Exhibit 17-4)	$V_{c,II,8} =$	$V_{c,II,11} =$
Potential capacity (Equation 17-3 or 17-29)	$C_{p,II,8} =$	$C_{p,II,11} =$
Ped impedance factor (Equation 17-12)	$P_{p,II,8} =$	$P_{p,II,11} =$
Capacity adjustment factor due to impeding movement (shared lane use p^*) (Equation 17-6 or 17-13)	$f_{II,8} = P_{0,1} P_{p,II,8} =$	$f_{II,11} = P_{0,4} P_{p,II,11} =$
Movement capacity (Equation 17-7)	$C_{m,II,8} = C_{p,II,8} f_{II,8} =$	$C_{m,II,11} = C_{p,II,11} f_{II,11} =$
Prob of queue-free state (Equation 17-5)	$P_{0,II,8} =$	$P_{0,II,11} =$
Part III - Single Stage		
Conflicting flows (Exhibit 17-4)	$V_{c,8} =$	$V_{c,11} =$
Potential capacity (Equation 17-3 or 17-29)	$C_{p,8} =$	$C_{p,11} =$
Ped impedance factor (Equation 17-12)	$P_{p,8} =$	$P_{p,11} =$
Capacity adjustment factor due to impeding movement (shared lane use p^*) (Equation 17-13 or 17-16)	$f_8 = P_{0,4} P_{0,1} P_{p,8} =$	$f_{11} = P_{0,4} P_{0,1} P_{p,11} =$
Movement capacity (Equation 17-7)	$C_{m,8} = C_{p,8} f_8 =$	$C_{m,11} = C_{p,11} f_{11} =$
Result for Two-Stage Process		
a (Equation 17-30)	a =	a =
y (Equation 17-31)	y =	y =
c_T (Equation 17-32 or 17-33)	$C_T =$	$C_T =$
Prob of queue-free state (Equation 17-5)	$P_{0,8} =$	$P_{0,11} =$

TWSC - UNSIGNALIZED INTERSECTIONS WORKSHEET		
Worksheet 7b		
General Information		
Project Description _____		
Effect of Two-Stage Gap Acceptance		
Step 4: LT from Minor Street	v_7	v_{10}
Part I - First Stage		
Conflicting flows (Exhibit 17-4)	$V_{c,I,7} =$	$V_{c,I,10} =$
Potential capacity (Equation 17-3 or 17-29)	$C_{p,I,7} =$	$C_{p,I,10} =$
Ped impedance factor (Equation 17-12)	$P_{p,I,7} =$	$P_{p,I,10} =$
Capacity adjustment factor due to impeding movements	$f_{I,7} = P_{0,1} P_{p,I,7} =$	$f_{I,10} = P_{0,4} P_{p,I,10} =$
Movement capacity (Equation 17-7)	$C_{m,I,7} = f_{I,7} C_{p,I,7} =$	$C_{m,I,10} = f_{I,10} C_{p,I,10} =$
Part II - Second Stage		
Conflicting flows (Exhibit 17-4)	$V_{c,II,7} =$	$V_{c,II,10} =$
Potential capacity (Equation 17-3 or 17-29)	$C_{p,II,7} =$	$C_{p,II,10} =$
Ped impedance factor (Equation 17-12)	$P_{p,II,7} =$	$P_{p,II,10} =$
Capacity adjustment factor due to impeding movements	$f_{II,7} = P_{0,4} P_{0,11} P_{0,12} P_{p,II,7} =$	$f_{II,10} = P_{0,1} P_{0,1,8} P_{0,9} P_{p,II,10} =$
Movement capacity (Equation 17-7)	$C_{m,II,7} = f_{II,7} C_{p,II,7} =$	$C_{m,II,10} = f_{II,10} C_{p,II,10} =$
Part III - Single-Stage		
Conflicting flows (Exhibit 17-4)	$V_{c,7} =$	$V_{c,10} =$
Potential capacity (Equation 17-3 or 17-29)	$C_{p,7} =$	$C_{p,10} =$
Ped impedance factor (Equation 17-12)	$P_{p,7} =$	$P_{p,10} =$
Major left, minor through impedance factor	$P_7^* = P_{0,11} f_{11} =$	$P_{10}^* = P_{0,8} f_8 =$
Major left, minor through adjusted impedance factor (Equation 17-8)	$P_7^{\cdot} =$	$P_{10}^{\cdot} =$
Capacity adjustment factor due to impeding movements (Equation 17-9 or 17-14)	$f_7 = P_7^{\cdot} P_{0,12} P_{p,7} =$	$f_{10} = P_{10}^{\cdot} P_{0,9} P_{p,10} =$
Movement capacity (Equation 17-7)	$C_{m,7} = f_7 C_{p,7} =$	$C_{m,10} = f_{10} C_{p,10} =$
Result for Two-Stage Process		
a (Equation 17-30)	a =	a =
y (Equation 17-31)	y =	y =
c_T (Equation 17-32 or 17-33)	$C_T =$	$C_T =$

TWSC - UNSIGNALIZED INTERSECTIONS WORKSHEET

Worksheet 8

General Information

Project Description _____

Shared-Lane Capacity

$$C_{SH} = \frac{\sum v_y}{\sum \left(\frac{v_y}{C_{m,y}} \right)} \quad \text{(Equation 17-15)}$$

Lane	v (veh/h)			c _m (veh/h)			c _{SH} (veh/h)
	Movement 7	Movement 8	Movement 9	Movement 10	Movement 11	Movement 12	
1							
2							
3							
	Movement 10	Movement 11	Movement 12	Movement 10	Movement 11	Movement 12	
1							
2							
3							

Worksheet 9

Effect of Flared Minor-Street Approaches

	Lane _____			Lane _____		
	Movement 7	Movement 8	Movement 9	Movement 10	Movement 11	Movement 12
c _{sep} (from Worksheet 6 or 7)						
volume (from Worksheet 2)						
delay (Equation 17-38)						
Q _{sep} (Equation 17-34)						
Q _{sep} + 1						
round (Q _{sep} + 1)						
n _{max} (Equation 17-35)						
C _{SH}						
C _{sep}						
n						
C _{act} (Equation 17-36)						

TWSC - UNSIGNALIZED INTERSECTIONS WORKSHEET

Worksheet 10

General Information

Project Description _____

Control Delay, Queue Length, Level of Service

Lane	v (veh/h)	c_m (veh/h)	v/c	Queue Length (Equation 17-37)	Control Delay (Equation 17-38)	LOS (Exhibit 17-2)	Delay and LOS
1 (7) (8) (9)							
2 (7) (8) (9)							
3 (7) (8) (9)							
1 (10) (11) (12)							
2 (10) (11) (12)							
3 (10) (11) (12)							

Movement	v (veh/h)	c_m (veh/h)	v/c	Queue Length (Equation 17-37)	Control Delay (Equation 17-38)	LOS (Exhibit 17-2)
1						
4						

Worksheet 11

Delay to Rank 1 Vehicles

	S_2 Approach	S_5 Approach
$p_{0,j}$ (Equation 17-5)	$p_{0,1} =$	$p_{0,4} =$
v_{i1} , volume for Stream 2 or 5		
v_{i2} , volume for Stream 3 or 6		
s_{i1} , saturation flow rate for Stream 2 or 5		
s_{i2} , saturation flow rate for Stream 3 or 6		
$p_{0,j}^*$ (Equation 17-16)	$p_{0,1}^* =$	$p_{0,4}^* =$
$d_{\text{major left}}$, delay for Stream 1 or 4		
N, number of major-street through lanes		
$d_{\text{Rank 1}}$, delay for Stream 2 or 5 (Equation 17-39)		

AWSC - UNSIGNALIZED INTERSECTIONS WORKSHEET

Worksheet 1

General Information	Site Information
Analyst _____	Intersection _____
Agency or Company _____	Jurisdiction _____
Date Performed _____	Analysis Year _____
Analysis Time Period _____	

Geometrics and Movements

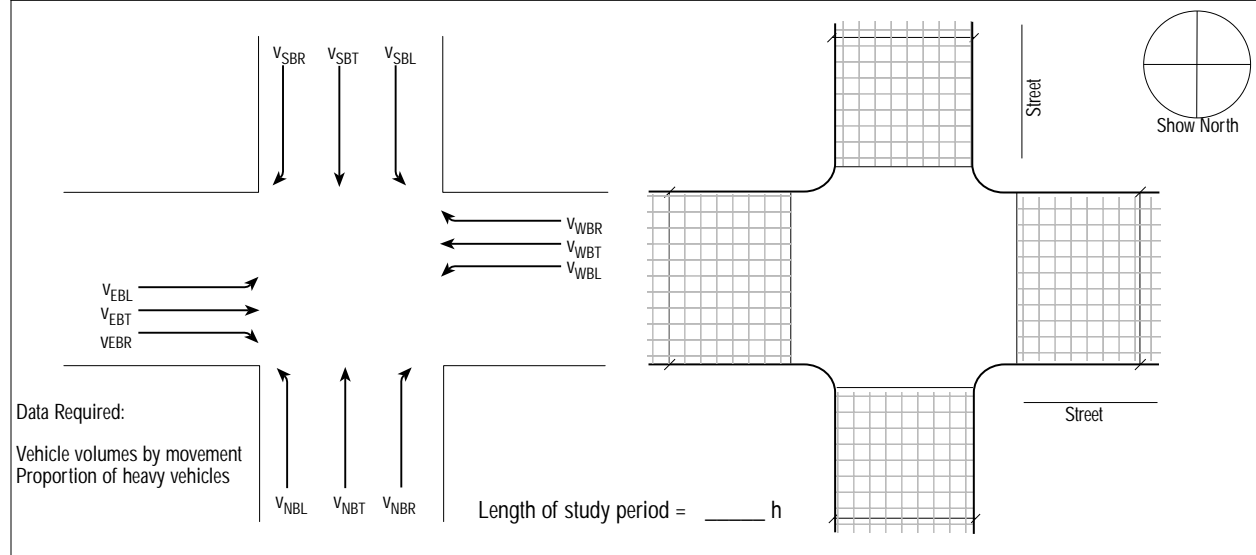

Worksheet 2

Volume Adjustments and Lane Assignments

Approach		Lane 1			Lane 2			Geometry Group (Exhibit 17-29)
		LT	TH	RT	LT	TH	RT	
EB	Volume (veh/h)							
	PHF							
	% Heavy vehicle							
	Flow rate (veh/h)							
WB	Volume (veh/h)							
	PHF							
	% Heavy vehicle							
	Flow rate (veh/h)							
NB	Volume (veh/h)							
	PHF							
	% Heavy vehicle							
	Flow rate (veh/h)							
SB	Volume (veh/h)							
	PHF							
	% Heavy vehicle							
	Flow rate (veh/h)							

AWSC - UNSIGNALIZED INTERSECTIONS WORKSHEET

Worksheet 3

General Information

Project Description _____

Saturation Headways

	EB		WB		NB		SB	
	L1	L2	L1	L2	L1	L2	L1	L2
Total lane flow rate								
Left-turn flow rate in lane								
Right-turn flow rate in lane								
Proportion LT in lane								
Proportion RT in lane								
Proportion HV in lane								
h_{LT-adj} (Exhibit 17-33)								
h_{RT-adj} (Exhibit 17-33)								
h_{HV-adj} (Exhibit 17-33)								
h_{adj} (Equation 17-56)								

Worksheet 4a

Departure Headway

	EB		WB		NB		SB	
	L1	L2	L1	L2	L1	L2	L1	L2
Total lane flow rate								
h_d , initial value (s)	3.2	3.2	3.2	3.2	3.2	3.2	3.2	3.2
x , initial value (Equation 17-57)								
h_d , Iteration 1								
h_d , difference								
h_d , Iteration 2								
h_d , difference								
h_d , Iteration 3								
h_d , difference								
h_d , Iteration 4								
h_d , difference								
h_d , Iteration 5								
h_d , difference								
Convergence?								
h_d , final								
x , final								

AWSC - UNSIGNALIZED INTERSECTIONS WORKSHEET

Worksheet 4b

Project Description _____

Service Time												
i	$P(a_{01})$	$P(a_{02})$	$P(a_{CL1})$	$P(a_{CL2})$	$P(a_{CR1})$	$P(a_{CR2})$	$P(i)$	Adj $P(i)$	$P'(i)$	h_{base}	h_{adj}	h_{sl}
1												
2												
3												
4												
5												
6												
7												
8												
9												
10												
11												
12												
13												
14												
15												
16												
17												
18												
19												
20												
21												
22												
23												
24												
25												
26												
27												
28												
29												
30												
31												
32												
33												
34												
35												
36												
37												
38												
39												
40												
41												
42												
43												
44												
45												
46												
47												
48												
49												
50												
51												
52												
53												
54												
55												
56												
57												
58												
59												
60												
61												
62												
63												
64												

AWSC - UNSIGNALIZED INTERSECTIONS WORKSHEET

Worksheet 5

General Information

Project Description _____

Capacity and Level of Service

	EB		WB		NB		SB	
	L1	L2	L1	L2	L1	L2	L1	L2
Total lane flow rate (veh/h)								
Departure headway, h_d (s)								
Degree of utilization, x								
Move-up time, m (s)								
Service time, t_s (s)								
Capacity (veh/h)								
Delay (s) (Equation 17-55)								
Level of service (Exhibit 17-22)								
Delay, approach (s/veh)								
Level of service, approach								
Delay, intersection (s/veh)								
Level of service, intersection								

ROUNDBABOUTS - UNSIGNALIZED INTERSECTIONS WORKSHEET

General Information		Site Information			
Analyst _____ Agency or Company _____ Date Performed _____ Analysis Time Period _____	Intersection _____ Jurisdiction _____ Analysis Year _____				
Volume Adjustments					
		EB	WB	NB	SB
LT Traffic	Volume, veh/h				
	PHF				
	Flow rate, veh/h				
TH Traffic	Volume, veh/h				
	PHF				
	Flow rate, veh/h				
RT Traffic	Volume, veh/h				
	PHF				
	Flow rate, veh/h				
Approach Flow Computation					
Approach Flow (veh/h)			v_a (veh/h)		
$V_{a,E} = V_1 + V_2 + V_3$					
$V_{a,W} = V_4 + V_5 + V_6$					
$V_{a,N} = V_7 + V_8 + V_9$					
$V_{a,S} = V_{10} + V_{11} + V_{12}$					
Circulating Flow Computation					
Approach Flow (veh/h)			v_c (veh/h)		
$V_{c,E} = V_4 + V_{10} + V_{11}$					
$V_{c,W} = V_1 + V_7 + V_8$					
$V_{c,N} = V_1 + V_2 + V_{10}$					
$V_{c,S} = V_4 + V_5 + V_7$					
Capacity Computation					
		EB	WB	NB	SB
Capacity (Equation 17-70)	Upper bound				
	Lower bound				
v/c Ratio	Upper bound				
	Lower bound				

CHAPTER 18

PEDESTRIANS

CONTENTS

I.	INTRODUCTION	18-1
	Types of Facilities	18-1
	Limitations of the Methodology	18-1
II.	METHODOLOGY	18-1
	LOS	18-1
	Determining Pedestrian Walking Speed	18-1
	Determining Effective Walkway Width	18-2
	Uninterrupted-Flow Pedestrian Facilities	18-3
	Walkways and Sidewalks	18-3
	Effect of Platoons on Walkways and Sidewalks	18-4
	Effect of Platoons on Transportation Terminals	18-4
	Stairs	18-5
	Cross Flows	18-5
	Queuing Areas	18-5
	Shared Pedestrian-Bicycle Facilities	18-6
	Interrupted-Flow Pedestrian Facilities	18-7
	Signalized Intersections	18-7
	Pedestrian Area Requirements at Street Corners	18-8
	Determining Street Corner Time-Space	18-10
	Available Time-Space	18-10
	Holding-Area Waiting Times	18-10
	Determining Circulation Time-Space	18-11
	Pedestrian Space	18-11
	Determining Crosswalk Time-Space	18-12
	Determining Pedestrian Effective Green Time	18-13
	Unsignalized Intersections	18-13
	Pedestrian Sidewalks on Urban Streets	18-15
III.	APPLICATIONS	18-16
	Computational Steps	18-16
	Planning Applications	18-16
	Analysis Tools	18-17
IV.	EXAMPLE PROBLEMS	18-19
	Example Problem 1	18-20
	Example Problem 2	18-22
	Example Problem 3	18-24
	Example Problem 4	18-28
	Example Problem 5	18-30
V.	REFERENCES	18-31
	APPENDIX A. WORKSHEETS	18-32
	Pedestrians Worksheet	
	Pedestrians at Signalized Intersections Worksheet	

EXHIBITS

Exhibit 18-1. Width Adjustments for Fixed Obstacles 18-2
Exhibit 18-2. Preemption of Walkway Width 18-3
Exhibit 18-3. Average Flow LOS Criteria for Walkways and Sidewalks 18-4
Exhibit 18-4. Platoon-Adjusted LOS Criteria for Walkways and Sidewalks 18-5
Exhibit 18-5. LOS Criteria for Stairways 18-5
Exhibit 18-6. LOS Criteria for Pedestrian Cross Flows 18-5
Exhibit 18-7. LOS Criteria for Pedestrian Queuing Areas 18-6
Exhibit 18-8. Pedestrian LOS Criteria for Shared Two-Way Paths 18-7
Exhibit 18-9. LOS Criteria for Pedestrians at Signalized Intersections 18-8
Exhibit 18-10. Intersection Corner Geometry and Pedestrian Movements 18-9
Exhibit 18-11. Condition 1: Minor-Street Crossing 18-9
Exhibit 18-12. Condition 2: Major-Street Crossing 18-10
Exhibit 18-13. LOS Criteria for Pedestrians at Unsignalized Intersections 18-15
Exhibit 18-14. LOS Criteria for Pedestrian Sidewalks on Urban Streets 18-16
Exhibit 18-15. Pedestrians Worksheet 18-17
Exhibit 18-16. Pedestrians at Signalized Intersections Worksheet 18-18

I. INTRODUCTION

TYPES OF FACILITIES

This chapter addresses the capacity and level-of-service (LOS) analysis of facilities serving pedestrians. Specifically, procedures are provided for the following types of pedestrian facilities.

- Walkways and sidewalks—facilities such as terminals, sidewalks, stairs, and paths designated exclusively for pedestrians.
- Pedestrian queuing areas—areas where pedestrians stand temporarily, while waiting to be served. Queuing areas are found at elevators, transit platforms, and street crossings.
- Shared off-street paths—paths physically separated from highway traffic for the use of pedestrians, bicycles, skateboards, and other nonmotorized traffic.
- Pedestrian crosswalks—pedestrian crossings at signalized and unsignalized intersections.
- Pedestrian facilities along urban streets—designated pedestrian sidewalks on urban streets, incurring the impacts of both uninterrupted flow and fixed interruptions.

LIMITATIONS OF THE METHODOLOGY

This chapter treats each of these facilities from the point of view of the pedestrian. Procedures for assessing the impact of pedestrians on vehicular capacity and LOS are incorporated into other chapters. The material in this chapter is the result of research sponsored by the Federal Highway Administration (*I*).

The pedestrian methodology for midblock sidewalk analysis cannot determine the effects of high volumes of pedestrians entering from doorways of office buildings or subway stations. It also cannot determine the effects of high volumes of motor vehicles entering or leaving a parking garage and crossing the sidewalk area. Moreover, the methodology gives no consideration to grades; it is adequate for grades between -3 and $+3$ percent; however, the effects of more extreme grades have not been well documented.

II. METHODOLOGY

The methodology provides the framework for pedestrian facility evaluation. The analyst will be able to investigate the effects that bicycles and traffic signals have on the pedestrian facility as well as the effect of pedestrian volume on flow and LOS.

LOS

LOS thresholds are given for the analysis of each pedestrian facility type, because performance measures vary. Chapter 11 describes the thresholds and service and performance measures in detail.

DETERMINING PEDESTRIAN WALKING SPEED

Pedestrian walking speed depends on the proportion of elderly pedestrians (65 years of age and older) in the walking population (*I*). If 0 to 20 percent of pedestrians are elderly, a walking speed of 1.2 m/s is recommended for computations for walkways. If elderly pedestrians constitute more than 20 percent of all pedestrians, a 1.0 m/s walking speed is recommended. In addition, an upgrade of 10 percent or greater reduces walking speed by 0.1 m/s.

Background and concepts for this chapter are in Chapter 11

Influences on pedestrian walking speed

Effective walkway width

DETERMINING EFFECTIVE WALKWAY WIDTH

Effective walkway width is the portion of a walkway that can be used effectively by pedestrians. Several types of walkway obstructions (see Exhibit 18-1 and Exhibit 18-2) tend to make pedestrians shy away. Effective walkway width is computed using Equation 18-1.

$$W_E = W_T - W_o \tag{18-1}$$

where

- W_E = effective walkway width (m),
- W_T = total walkway width (m), and
- W_o = sum of widths and shy distances from obstructions on the walkway (m).

EXHIBIT 18-1. WIDTH ADJUSTMENTS FOR FIXED OBSTACLES

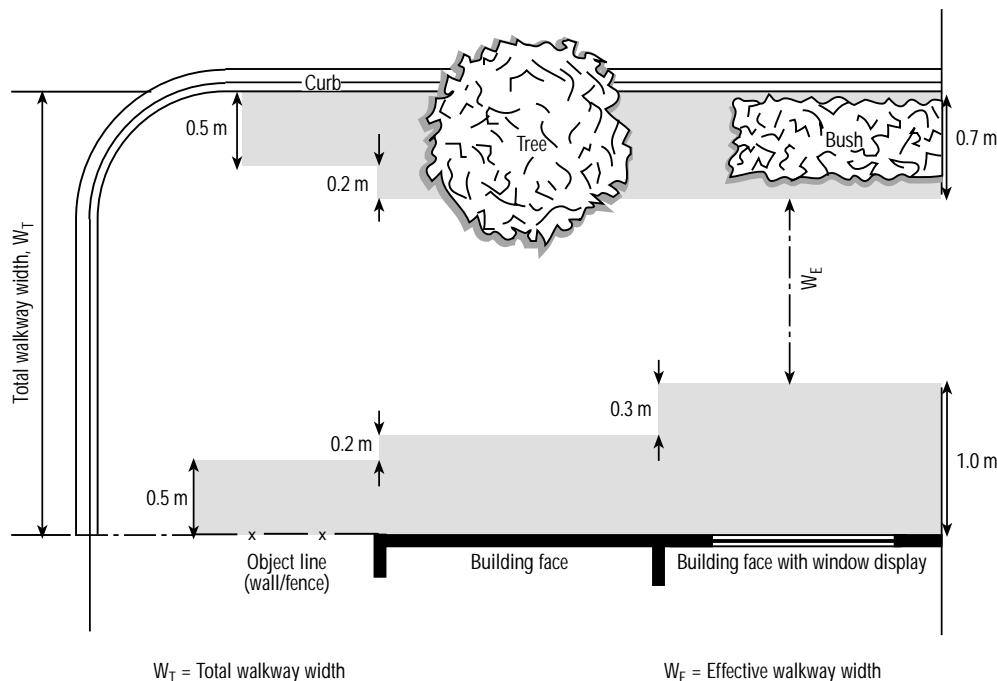

A schematic showing typical obstructions and the estimated width of walkway they preempt is provided in Exhibit 18-1. Exhibit 18-2 lists the width of walkway preempted by curbs, buildings, or fixed objects. The values in Exhibit 18-2 can be used when specific walkway configurations are not available.

The effective length of an occasional obstruction is assumed to be 5 times its effective width. The average effect of occasional obstructions such as trees and poles therefore should be obtained by multiplying their effective width by the ratio of their effective length to the average distance between them.

Also, at signalized intersection crossings, the analyst should observe if right-turning vehicles occupy part of the crosswalk during the crossing phase. If a significant portion of the crosswalk is not being used by pedestrians due to right-turning vehicles, effective crosswalk width can be computed by subtracting the appropriate time-space used by right-turning vehicles.

EXHIBIT 18-2. PREEMPTION OF WALKWAY WIDTH^a

Obstacle	Approx. Width Preempted (m)
Street Furniture	
Light pole	0.8–1.1
Traffic signal poles and boxes	0.9–1.2
Fire alarm boxes	0.8–1.1
Fire hydrants	0.8–0.9
Traffic signs	0.6–0.8
Parking meters	0.6
Mail boxes (0.5 m x 0.5 m)	1.0–1.1
Telephone booths (0.8 m x 0.8 m)	1.2
Waste baskets	0.9
Benches	1.5
Public Underground Access	
Subway stairs	1.7–2.1
Subway ventilation gratings (raised)	1.8+
Transformer vault ventilation gratings (raised)	1.5+
Landscaping	
Trees	0.6–1.2
Planter boxes	1.5
Commercial Uses	
Newsstands	1.2–4.0
Vending stands	variable
Advertising displays	variable
Store displays	variable
Sidewalk cafes (two rows of tables)	2.1
Building Protrusions	
Columns	0.8–0.9
Stoops	0.6–1.8
Cellar doors	1.5–2.1
Standpipe connections	0.3
Awning poles	0.8
Truck docks (trucks protruding)	variable
Garage entrance/exit	variable
Driveways	variable

Note:

a. To account for the avoidance distance between pedestrians and obstacles, 0.3 to 0.5 m must be added to the preemption width for individual obstacles. Widths are from curb to edge of object, or building face to edge of object.

Source: Pushkarev and Zupan (2).

UNINTERRUPTED-FLOW PEDESTRIAN FACILITIES

Uninterrupted pedestrian facilities include both exclusive and shared pedestrian paths (both indoor and outdoor) designated for pedestrian use. These pedestrian facilities are unique because pedestrians do not experience any disruption except the interaction with other pedestrians and, on shared paths, with other nonmotorized modes of transportation. These procedures should be used with pedestrian walking speed, pedestrian start-up time, and pedestrian space requirements as described in Chapter 11.

Walkways and Sidewalks

Walkway and sidewalk paths are separated from motor vehicle traffic and typically do not allow bicycles or users other than pedestrians. These facilities are often constructed to serve pedestrians on city streets, at airports, in subways, and at bus terminals. These pedestrian facilities include straight sections of sidewalk, terminals,

$$\text{Space} = \frac{1}{\text{Density}}$$

stairs, and cross-flow areas where streams of pedestrians cross. Such facilities accommodate the highest volumes of pedestrians of the three uninterrupted types of facility addressed here; they also provide the best levels of service, because pedestrians do not share the facility with other modes traveling at higher speeds.

The primary performance measure for walkways and sidewalks is space, the inverse of density. Space can be directly observed in the field by measuring the sample area of the facility and determining the maximum number of pedestrians at a given time in that area. Speed also can be observed readily in the field, and can be used as a supplementary criterion to analyze a walkway or sidewalk. For simplicity of field observation, pedestrian unit flow rate is used as a service measure. Determination of the peak 15-min count and the effective walkway width is required to compute pedestrian unit flow rate according to Equation 18-2.

$$v_p = \frac{v_{15}}{15 * W_E} \tag{18-2}$$

where

- v_p = pedestrian unit flow rate (p/min/m),
- v_{15} = peak 15-min flow rate (p/15-min), and
- W_E = effective walkway width (m).

$$\text{Capacity} = 75 \text{ p/min/m}$$

Volume to capacity (v/c) ratio can be computed assuming 75 p/min/m for capacity. Exhibit 18-3 lists the criteria for pedestrian LOS on walkways. It includes the service measure of space and the supplementary criteria of unit flow rate, speed, and v/c ratio. Note that LOS thresholds summarized in Exhibit 18-3 do not account for platoon flow, but instead assume average flow throughout the effective width.

EXHIBIT 18-3. AVERAGE FLOW LOS CRITERIA FOR WALKWAYS AND SIDEWALKS

LOS	Space (m ² /p)	Flow Rate (p/min/m)	Speed (m/s)	v/c Ratio
A	> 5.6	≤ 16	> 1.30	≤ 0.21
B	> 3.7–5.6	> 16–23	> 1.27–1.30	> 0.21–0.31
C	> 2.2–3.7	> 23–33	> 1.22–1.27	> 0.31–0.44
D	> 1.4–2.2	> 33–49	> 1.14–1.22	> 0.44–0.65
E	> 0.75–1.4	> 49–75	> 0.75–1.14	> 0.65–1.0
F	≤ 0.75	variable	≤ 0.75	variable

It is important for the analyst to determine if platooning or other traffic patterns alter the underlying assumptions of average flow in the LOS calculation. If platooning or other flow patterns occur, refer to the next sections to select appropriate LOS criteria. Even though LOS tables in the next sections represent platooning and other patterns of flow, the analyst enters the tables with average unit flow rate. Therefore, Equations 18-1 and 18-2 apply to all flow patterns.

Effect of Platoons on Walkways and Sidewalks

Exhibit 18-4 summarizes LOS thresholds for average flow rates when platoons arise. Research (2) indicates that impeded flow starts at 49 m²/p, which is equivalent to 1.6 p/min/m. This value is used as the threshold for LOS A. The same research (2) shows that jammed flow in platoons starts at 1.0 m²/p, which is equivalent to 59 p/min/m. This value is used as the LOS F threshold.

Effect of Platoons on Transportation Terminals

Transportation terminals provide a special case of platoon flow at airports, bus terminals, and other locations where platooning behavior is common. LOS criteria for

transportation terminals is provided in Chapter 27, "Transit;" for more discussion, refer to the *Transit Quality of Service Manual (3)*.

EXHIBIT 18-4. PLATOON-ADJUSTED LOS CRITERIA FOR WALKWAYS AND SIDEWALKS

LOS	Space (m ² /p)	Flow Rate ^a (p/min/m)
A	> 49	≤ 1.6
B	> 8-49	> 1.6-10
C	> 4-8	> 10-20
D	> 2-4	> 20-36
E	> 1-2	> 36-59
F	≤ 1	> 59

Note:

a. Rates in the table represent average flow rates over a 5- to 6-min period.

Stairs

Research (4) has developed LOS thresholds based on the Institute of Transportation Engineers stairways standards, which provide space and flow values listed in Exhibit 18-5. These modified LOS criteria are to ensure that the basic equation of traffic flow is satisfied. The volume to capacity (v/c) ratios are based on a stairway capacity of 49 p/min/m.

Institute of Transportation
Engineers stairway standards

EXHIBIT 18-5. LOS CRITERIA FOR STAIRWAYS

LOS	Space (m ² /p)	Flow Rate (p/min/m)	Average Horizontal Speed (m/s)	v/c Ratio
A	> 1.9	≤ 16	> 0.53	≤ 0.33
B	> 1.6-1.9	> 16-20	> 0.53	> 0.33-0.41
C	> 1.1-1.6	> 20-26	> 0.48-0.53	> 0.41-0.53
D	> 0.7-1.1	> 26-36	> 0.42-0.48	> 0.53-0.73
E	> 0.5-0.7	> 36-49	> 0.40-0.42	> 0.73-1.00
F	≤ 0.5	variable	≤ 0.40	variable

Cross Flows

A cross flow is a pedestrian flow that is approximately perpendicular to and crosses another pedestrian stream. In general, the smaller of the two flows is referred to as the cross-flow condition. Research (5) notes that pedestrian cross flows occur in hallways and corridors. The same procedure for estimating walkway and sidewalk space is used to analyze pedestrian facilities with cross flows. LOS criteria A through D are to be used from Exhibit 18-3 or, if platoons are observed, from Exhibit 18-4. In addition, Exhibit 18-6 lists LOS E criteria for pedestrian facilities with cross flows.

EXHIBIT 18-6. LOS CRITERIA FOR PEDESTRIAN CROSS FLOWS

LOS	Space (m ² /p)	Flow ^a (p/min/m)	Speed (m/s)	Density (p/m ²)
E	≥ 1.25	≤ 75	≥ 1.0	≤ 0.8

Note:

a. Total of the major and minor flows.

Queuing Areas

The average space available to pedestrians also can apply as the walkway service measure for queuing or waiting areas. The pedestrian stands temporarily in these areas, waiting to be served. The LOS thresholds listed in Exhibit 18-7 are related to the average space available to each pedestrian and to the degree of mobility allowed. In dense

standing crowds, there is little room to move, but limited circulation is possible as the average space per pedestrian increases.

EXHIBIT 18-7. LOS CRITERIA FOR PEDESTRIAN QUEUING AREAS

LOS	Space (m ² /p)
A	> 1.2
B	> 0.9–1.2
C	> 0.6–0.9
D	> 0.3–0.6
E	> 0.2–0.3
F	≤ 0.2

Shared Pedestrian-Bicycle Facilities

Shared pedestrian facilities typically are open to use by nonmotorized modes such as bicycles, skate boards, and wheelchairs. Shared-use paths often are constructed to serve areas without city streets and to provide recreational opportunities for the public. These paths are common on university campuses, where motor vehicle traffic and parking are often restricted. In the United States, there are few paths exclusively for pedestrians; most off-street paths, therefore, are for shared use.

On shared facilities, bicycles—because of their markedly higher speeds—can have a negative effect on pedestrian capacity and LOS. However, it is difficult to establish a bicycle-pedestrian equivalent because the relationship between the two differs depending on their respective flows, directional splits, and other factors.

This chapter deals with the LOS provided to pedestrians on shared facilities. Bicyclists have a different perspective as discussed in Chapter 19 of this manual.

LOS for shared paths is based on hindrance. Research (6) has established LOS guidelines both for pedestrians and for bicyclists based on the frequency of passing (same direction) and of meeting (opposite direction) other users on paths 2.4 m wide. Because pedestrians seldom overtake other pedestrians, the LOS for a pedestrian on a shared path depends on the frequency that the average pedestrian is overtaken by bicyclists (6). However, the analyst should observe pedestrian behavior in the field before assuming there is no pedestrian-to-pedestrian interaction.

Equation 18-3 is used to calculate the total number of bicycle passing events and the total number of opposing bicycle meeting events, per hour, for the average pedestrian on the shared path.

$$F_p = Q_{sb} \left(1 - \frac{S_p}{S_b} \right) \quad (18-3)$$

$$F_m = Q_{ob} \left(1 + \frac{S_p}{S_b} \right)$$

where

- F_p = number of passing events (events/h),
- F_m = number of opposing events (events/h),
- Q_{sb} = bicycle flow rate in the same direction (bicycles/h),
- Q_{ob} = bicycle flow rate in the opposing direction (bicycles/h),
- S_p = mean pedestrian speed on the path (m/s), and
- S_b = mean bicycle speed on the path (m/s).

The total number of events is calculated according to Equation 18-4.

$$F = F_p + 0.5 F_m \quad (18-4)$$

LOS is based on the overtaking of pedestrians by bicycles. Pedestrian-to-pedestrian interaction is negligible.

where

- F = total number of events on the path (events/h),
- F_p = number of passing events (events/h), and
- F_m = number of meeting events (events/h).

Meeting events allow direct visual contact, so that opposing bicycles tend to cause less hindrance to pedestrians.

A default average pedestrian speed of 1.5 m/s and a bicycle speed of 6.0 m/s applied to the equations above can produce LOS thresholds for two-way paths. These are summarized in Exhibit 18-8. The indicated bicycle service volumes apply only for a 50/50 directional split of bicycles on paths 2.4 m wide (6). Otherwise, LOS must be based on the total number of events per hour. For one-way paths, there are no meeting events, so that the LOS is determined from the number of passing events, calculated with Equation 18-3.

Meeting events create less hindrance than overtaking events

EXHIBIT 18-8. PEDESTRIAN LOS CRITERIA FOR SHARED TWO-WAY PATHS^a

Pedestrian LOS	Number of Events/h ^b	Corresponding Bicycle Service Volume per Direction ^c (bicycles/h)
A	≤ 38	≤ 28
B	> 38–60	> 28–44
C	> 60–103	> 44–75
D	> 103–144	> 75–105
E	> 144–180	> 105–131
F	> 180	> 131

Notes:

- a. Path 2.4 m wide.
- b. An "event" is a bicycle meeting or passing a pedestrian.
- c. Assuming 50/50 directional split of bicycles.

INTERRUPTED-FLOW PEDESTRIAN FACILITIES

The procedures of this chapter focus on the LOS provided to pedestrians. For the impact of pedestrians on motor vehicle traffic, consult other chapters in this manual.

Signalized Intersections

A signalized intersection covered by these procedures has a pedestrian crossing on at least one approach. The signalized intersection crossing is more complicated to analyze than a midblock crossing, because it involves intersecting sidewalk flows, pedestrians crossing the street, and others queued waiting for the signal to change. The service measure is the average delay experienced by a pedestrian. Research indicates that the average delay of pedestrians at signalized intersection crossings is not constrained by capacity, even when pedestrian flow rates reach 5,000 p/h (I). The average delay per pedestrian for a crosswalk is given by Equation 18-5.

$$d_p = \frac{0.5(C - g)^2}{C} \tag{18-5}$$

where

- d_p = average pedestrian delay (s),
- g = effective green time (for pedestrians) (s), and
- C = cycle length (s).

Exhibit 18-9 lists LOS criteria for pedestrians at signalized intersections, based on pedestrian delay. When pedestrians experience more than a 30-s delay, they become impatient, and engage in risk-taking behavior (7). Exhibit 18-9 includes a guide for the likelihood of pedestrian noncompliance (i.e., disregard for signal indications). The values

in Exhibit 18-9 reflect low to moderate conflicting vehicle volumes. At intersections with high conflicting vehicle volumes, pedestrians have little choice but to wait for the walk signal, and observed noncompliance is reduced.

EXHIBIT 18-9. LOS CRITERIA FOR PEDESTRIANS AT SIGNALIZED INTERSECTIONS

LOS	Pedestrian Delay (s/p)	Likelihood of Noncompliance
A	< 10	Low
B	≥ 10–20	
C	> 20–30	Moderate
D	> 30–40	
E	> 40–60	High
F	> 60	Very High

Even though delay has an impact on the travel time of pedestrians, it does not reflect the functions of street corners and crosswalks, where the circulation of pedestrians and the space for pedestrians queuing to cross are important. An overloaded street corner and crosswalk can affect vehicular operations by requiring additional green crossing time or by delaying turn movements.

Pedestrian Area Requirements at Street Corners

There are two types of pedestrian area requirements at street corners. First, a circulation area is needed to accommodate pedestrians crossing during the green signal phase, those moving to join the red-phase queue, and those moving between the adjoining sidewalks but not crossing the street. Second, a hold area is needed to accommodate pedestrians waiting during the red signal phase.

The methodology described in the following sections can identify problem locations that may require detailed field study and possible remedial measures (8). Corrective measures could include widening the sidewalk, adding restrictions on vehicle turns, and changing the signal timing. Exhibit 18-10 shows the variables required to perform an analysis.

Exhibits 18-11 and 18-12 show the signal phase conditions analyzed in corner and crosswalk computations. Condition 1 is the minor-street crossing phase during the major-street green, with pedestrians queuing on the major-street side during the minor-street red phase. Condition 2 is the major-street crossing phase, with pedestrians crossing during the minor-street green, and queuing on the minor-street side during the major-street red phase.

The analysis of street corners and crosswalks compares available time and space with pedestrian demand. The product of time and space (or time-space) is the critical parameter, because physical design limits available space, and signalized controls limit available time.

Pedestrian areas at intersections have two main functions:

- Circulation, and
- Temporary holding

EXHIBIT 18-10. INTERSECTION CORNER GEOMETRY AND PEDESTRIAN MOVEMENTS

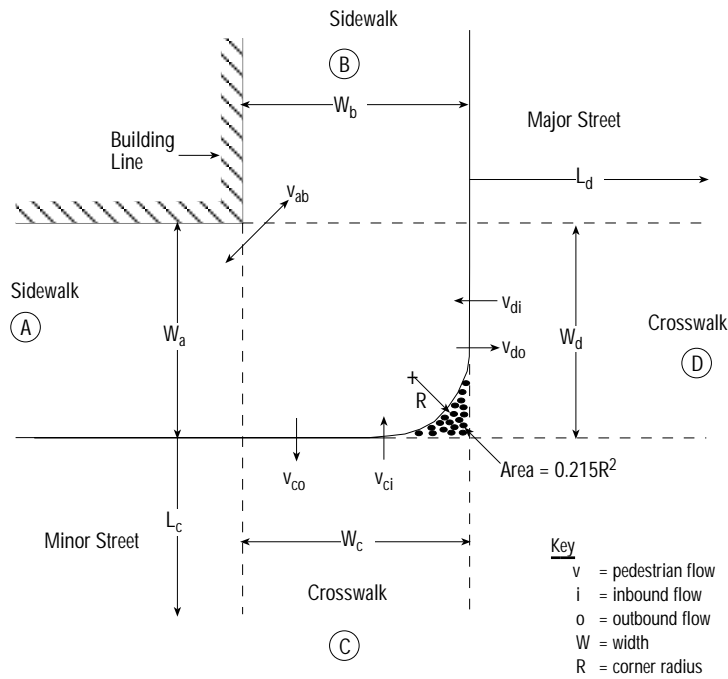

EXHIBIT 18-11. CONDITION 1: MINOR-STREET CROSSING

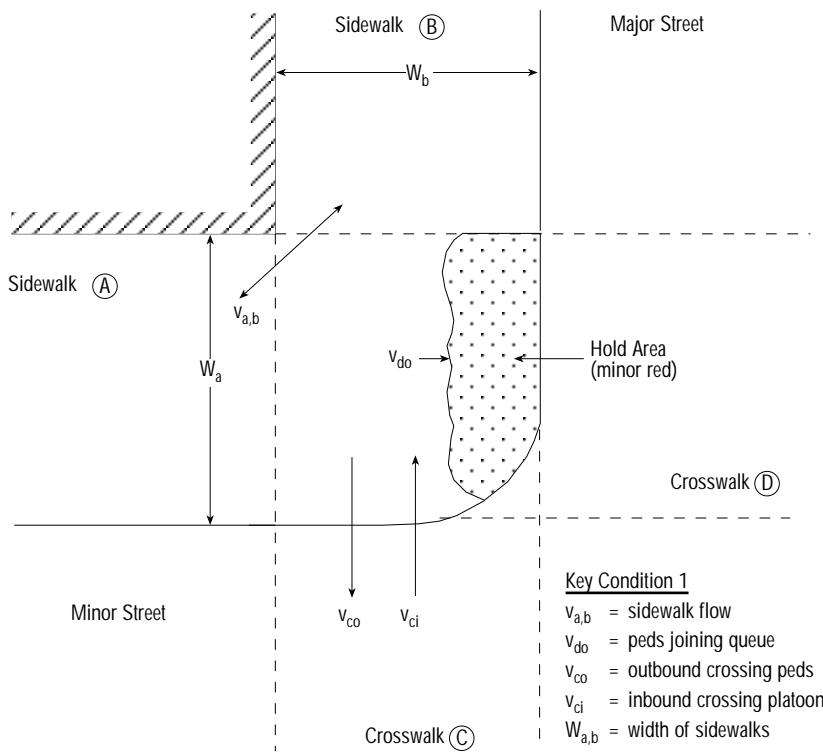
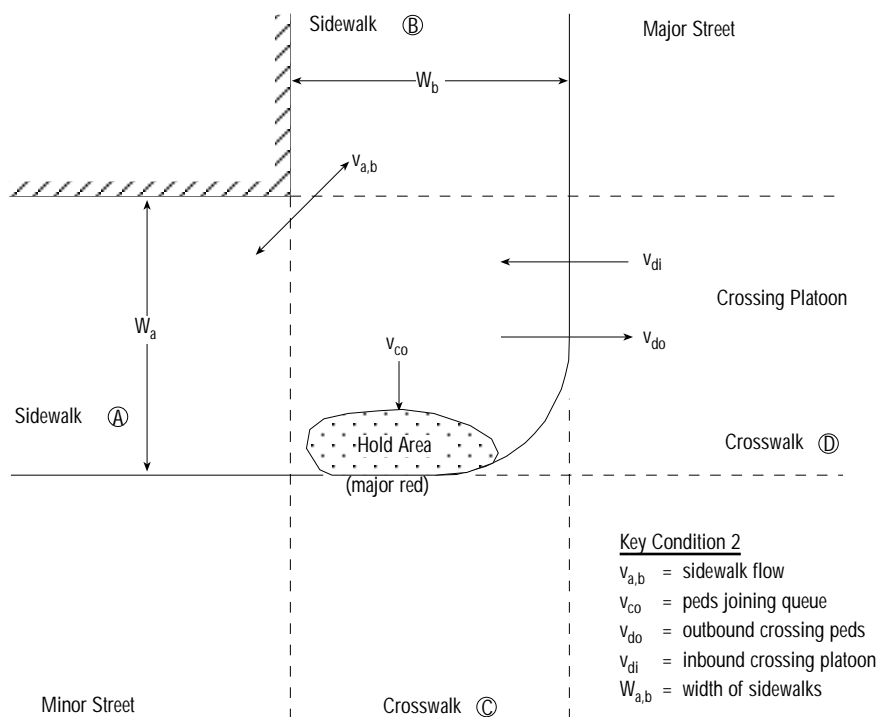

EXHIBIT 18-12. CONDITION 2: MAJOR-STREET CROSSING



A time-space approach is used for analyzing intersection corner areas

Determining Street Corner Time-Space

Available Time-Space

The total time-space available for circulation and queuing in the intersection corner during an analysis period is the product of the net corner area and the length of the analysis period. For street corners, the analysis period is one signal cycle and therefore is equal to the cycle length. Equation 18-6 is used to compute time-space available at an intersection corner. Exhibit 18-11 identifies dimensions used in the equation.

$$TS = C(W_a W_b - 0.215R^2) \tag{18-6}$$

where

- TS = available time-space ($m^2 \cdot s$),
- W_a = effective width of Sidewalk a (m),
- W_b = effective width of Sidewalk b (m),
- R = radius of corner curb (m), and
- C = cycle length (s).

Holding-Area Waiting Times

Assuming arrivals are uniform at the crossing queue, the average pedestrian holding times can be computed using Equations 18-7 and 18-8. These equations reflect the proportion of the cycle time that flows are held up, as well as their holding time based on the red signal phase.

For Condition 1, as shown in Exhibit 18-11, the following equation is used to compute holding-area waiting time.

$$Q_{tdo} = \frac{v_{do} R_{mi}^2}{2C} \tag{18-7}$$

where

- Q_{tdo} = total time spent by pedestrians waiting to cross the major street during one cycle (p-s);
- v_{do} = the number of pedestrians waiting to cross the major street during one cycle, $\frac{p}{15 \text{ min}} * \frac{1 \text{ min}}{60 \text{ s}} * C$ (p/cycle);
- R_{mi} = the minor-street red phase, or the Don't Walk phase if there are pedestrian signals (s); and
- C = cycle length (s).

For Condition 2, as shown in Exhibit 18-12, Equation 18-8 is used to compute holding-area waiting time.

$$Q_{tco} = \frac{v_{co} R_{mj}^2}{2C} \quad (18-8)$$

where

- Q_{tco} = total time spent by pedestrians waiting to cross the minor street during one cycle (p-s);
- v_{co} = the number of pedestrians waiting to cross the minor street during one cycle, $\frac{p}{15 \text{ min}} * \frac{1 \text{ min}}{60 \text{ s}} * C$ (p/cycle);
- R_{mj} = the major-street red phase, or the Don't Walk phase if there are pedestrian signals (s); and
- C = cycle length (s).

Determining Circulation Time-Space

The net corner time-space available for circulating pedestrians is the total available time-space minus the time-space occupied by the pedestrians waiting to cross. The holding area required for waiting pedestrians is the product of the total waiting time and the area used by waiting pedestrians. Equation 18-9 is used to compute the time-space available.

$$TS_c = TS - [0.5(Q_{tdo} + Q_{tco})] \quad (18-9)$$

where

- TS_c = total time-space available for circulating pedestrians (m²-s),
- TS = total time-space available (m²-s),
- Q_{tdo} = total time spent by pedestrians waiting to cross the major street during one cycle (p-s), and
- Q_{tco} = total time spent by pedestrians waiting to cross the minor street during one cycle (p-s).

Pedestrian Space

Finally, the space required for circulating pedestrians is computed by dividing the total time-space available for circulating pedestrians by the time that pedestrians consume walking through the corner area—that is, the sum of the total circulation volume multiplied by 4 s, the assumed average circulation time. This yields the area for each pedestrian, which is related to the LOS thresholds for walkways in Exhibit 18-3. Equation 18-10 is used for the computation.

$$M = \frac{TS_c}{4v_{tot}} \quad (18-10)$$

Circulation time is assumed to equal 4 s

A time-space approach is used for crosswalks

where

- M = circulation area per pedestrian (m^2/p);
- TS_c = total time-space available for circulating pedestrians (m^2-s); and
- v_{tot} = total number of circulating pedestrians in one cycle = $v_{ci} + v_{co} + v_{di} + v_{do} + v_{a,b}$, as shown in Exhibits 18-11 and 18-12 (p/cycle).

Determining Crosswalk Time-Space

Time-space of a crosswalk at a street corner is computed according to Equation 18-11 (9).

$$TS = LW_E \left((WALK + FDW) - \frac{L}{2S_p} \right) \quad \text{or} \quad (18-11)$$

$$TS = LW_E \left(G - \frac{L}{2S_p} \right) \quad \text{when } WALK + FDW \text{ is not installed}$$

where

- TS = time-space (m^2-s);
- L = crosswalk length (m);
- W_E = effective crosswalk width (m);
- $WALK + FDW$ = effective pedestrian green time on crosswalk (s);
- S_p = average speed of pedestrians (m/s); and
- G = green time for phase, if $WALK + FDW$ is not installed (s).

The analysis of crosswalk time-space requires a pedestrian flow rate during the cycle length interval. Equation 18-12 allows the analyst to calculate the number of pedestrians crossing during the cycle length interval. Total crossing time or effective green time required to clear an intersection crossing is computed according to Equation 18-13, which incorporates the effects of dispersion of platoons larger than 15 pedestrians (9).

$$N_{ped} = \frac{v(C - G)}{C} \quad (18-12)$$

where

- N_{ped} = number of pedestrians crossing during an interval (p);
- v = pedestrian volume on the subject walkway (p/15-min); and
- G = green time for phase, if $WALK + FDW$ is not installed.

$$t = 3.2 + \frac{L}{S_p} + \left(0.81 \frac{N_{ped}}{W} \right) \quad \text{for } W > 3.0 \text{ m} \quad (18-13)$$

$$t = 3.2 + \frac{L}{S_p} + (0.27 N_{ped}) \quad \text{for } W \leq 3.0 \text{ m}$$

where

- t = total crossing time (s),
- L = crosswalk length (m),
- S_p = average speed of pedestrians (m/s),
- N_{ped} = number of pedestrians crossing during an interval (p),
- W = crosswalk width (m), and
- 3.2 = pedestrian start-up time (s).

The total crosswalk occupancy time is computed as a product of the average crossing time and the number of pedestrians using the crosswalk during one signal cycle. Equation 18-14 is used for the computation.

$$T = (v_i + v_o) t \quad (18-14)$$

where

- T = total crosswalk occupancy time (p-s),
- v_i = inbound pedestrian volume for the subject crosswalk (p/cycle),
- v_o = outbound pedestrian volume for the subject crosswalk (p/cycle), and
- t = total crossing time from Equation 18-12 (s).

The circulation space provided for each pedestrian is determined by dividing the time-space available for crossing by the total occupancy time, as in Equation 18-15. This yields the area provided for each pedestrian, which is related to LOS thresholds for walkways listed in Exhibit 18-3.

$$M = \frac{TS}{T} \quad (18-15)$$

where

- M = circulation area per pedestrian (m^2/p),
- TS = time-space (m^2-s), and
- T = total crosswalk occupancy time (p-s).

The time-space method allows for an approximate estimate of the effect of turning vehicles on the LOS for pedestrians crossing during a given green phase. This assumes an area occupancy of a vehicle in the crosswalk, based on the product of vehicle swept-path, crosswalk width, and estimate of the time that the vehicle preempts this space. The swept-path for most vehicles is 2.4 m, and it can be assumed that a vehicle occupies the crosswalk for 5 s. Equation 18-16 can be used to estimate time-space occupied by turning vehicles, which is subtracted from the time-space value obtained from Equation 18-11.

$$TS_{tv} = 12N_{tv}W_E \quad (18-16)$$

where

- TS_{tv} = time-space occupied by turning vehicles (m^2-s),
- N_{tv} = number of vehicles during the green phase (veh), and
- W_E = effective width of crosswalk (m).

Determining Pedestrian Effective Green Time

Minimum effective green required for two-way flow conditions can be estimated using shock-wave theory and observation. If there are high pedestrian volumes, a shock-wave approach can ensure adequate crossing time for large two-way platoon flows. But in low-volume conditions, minimum time requirements can be determined using Equation 18-6, which also accounts for platoon flow.

Pedestrians use both the Walk interval and the first few seconds of the flashing Don't Walk interval to enter the intersection. For the delay calculations in Equation 18-5, the effective green interval is equal to the walk interval plus the first 4 s of the flashing Don't Walk (I, I_0).

Unsignalized Intersections

Another procedure applies to an unsignalized intersection with a pedestrian crossing against a free-flowing traffic stream or an approach not controlled by a stop sign. However, if there are zebra-striped crossings at an unsignalized intersection, this procedure does not apply, because pedestrians have the right-of-way; instead, pedestrian delay can be estimated using the method for two-way stop-controlled (TWSC) intersections.

A crossing of an unsignalized intersection is more complicated to analyze than one at midblock, because it involves intersecting sidewalk flows, pedestrians crossing the street,

The method for unsignalized intersections does not apply to zebra-striped crosswalks

Critical gap for pedestrians

and pedestrian judgment of an acceptable gap. The procedure for estimating the critical gap is similar to that described in Chapter 17, "Unsignalized Intersections."

The critical gap is the time in seconds below which a pedestrian will not attempt to begin crossing the street. Pedestrians use their own judgment to determine if the available gap is long enough for a safe crossing. If the available gap is greater than the critical gap, it is assumed that the pedestrian will cross, but if the available gap is less than the critical gap, it is assumed that the pedestrian will not cross.

For a single pedestrian, critical gap is computed according to Equation 18-17.

$$t_c = \frac{L}{S_p} + t_s \quad (18-17)$$

where

- t_c = critical gap for a single pedestrian (s),
- S_p = average pedestrian walking speed (m/s),
- L = crosswalk length (m), and
- t_s = pedestrian start-up time and end clearance time (s).

Platooning

If platooning is observed in the field, then the spatial distribution of pedestrians should be computed using Equation 18-18, to determine group critical gap. To compute spatial distribution, the analyst must observe in the field or estimate the platoon size using Equation 18-19. Group critical gap is determined using Equation 18-20. If no platooning is observed, spatial distribution of pedestrians is assumed to be 1.

$$N_p = \text{INT} \left[\frac{0.75(N_c - 1)}{W_E} \right] + 1 \quad (18-18)$$

where

- N_p = spatial distribution of pedestrians (p),
- N_c = total number of pedestrians in the crossing platoon (p),
- W_E = effective crosswalk width (m), and
- 0.75 = default clear effective width used by a single pedestrian to avoid interference when passing other pedestrians.

$$N_c = \frac{v_p e^{v_p t_c} + v e^{-v t_c}}{(v_p + v) e^{(v_p - v) t_c}} \quad (18-19)$$

where

- N_c = size of a typical pedestrian crossing platoon (p),
- v_p = pedestrian flow rate (p/s),
- v = vehicular flow rate (veh/s), and
- t_c = single pedestrian critical gap (s).

$$t_G = t_c + 2(N_p - 1) \quad (18-20)$$

where

- t_G = group critical gap (s),
- t_c = critical gap for a single pedestrian (s), and
- N_p = spatial distribution of pedestrians (p).

The delay experienced by a pedestrian is the service measure. Research indicates that average delay of pedestrians at an unsignalized intersection crossing depends on the critical gap, the vehicular flow rate of the subject crossing, and the mean vehicle headway (H). The average delay per pedestrian for a crosswalk is given by Equation 18-21.

$$d_p = \frac{1}{v} (e^{v t_G} - v t_G - 1) \quad (18-21)$$

where

- d_p = average pedestrian delay (s),
- v = vehicular flow rate (veh/s), and
- t_G = group critical gap from Equation 18-19 (s).

Exhibit 18-13 lists LOS criteria for pedestrians at unsignalized intersections, based on pedestrian delay. Pedestrians expect and tolerate smaller delays at unsignalized intersections than at signalized intersections. Exhibit 18-13 also includes a likelihood of pedestrian risk-taking behavior related to LOS.

EXHIBIT 18-13. LOS CRITERIA FOR PEDESTRIANS AT UNSIGNALIZED INTERSECTIONS

LOS	Average Delay/Pedestrian (s)	Likelihood of Risk-Taking Behavior ^a
A	< 5	Low
B	≥ 5–10	
C	> 10–20	Moderate
D	> 20–30	
E	> 30–45	High
F	> 45	Very High

Note:

- a. Likelihood of acceptance of short gaps.

Pedestrian Sidewalks on Urban Streets

This section focuses on the analysis of extended pedestrian facilities with both uninterrupted and interrupted flows. Average pedestrian travel speed, including stops, is the service measure. This average speed is based on the distance between two points and the average amount of time required—including stops—to traverse that distance.

Pedestrian sidewalks along urban streets comprise segments and intersections. The first step in analyzing an urban street is to define its limits, then to segment it for analysis. Each segment consists of a signalized intersection and an upstream segment of pedestrian sidewalk, beginning immediately after the nearest upstream signalized or unsignalized intersection. The average travel speed over the entire section is computed according to Equation 18-22.

$$S_A = \frac{L_T}{\sum \frac{L_i}{S_i} + \sum d_j} \quad (18-22)$$

where

- L_T = total length of the urban street under analysis (m),
- L_i = length of Segment i (m),
- S_i = pedestrian walking speed over Segment i (m/s),
- d_j = pedestrian delay at Intersection j (s), and
- S_A = average pedestrian travel speed (m/s).

There are many factors that affect pedestrian speed, including adjacent activities on the walkway, commercial and residential driveways, lateral obstructions, significant grades, effective width of sidewalk, and other local features. Research has been insufficient to produce specific recommendations on their individual and collective effect. Intersection delays, however, can be computed, as described earlier.

LOS criteria based on pedestrian travel speed are listed in Exhibit 18-14. The criteria generally resemble the urban street LOS criteria for motor vehicles; the thresholds are set at similar percentages of the base speed (4).

Analysis of extended facilities with both uninterrupted and interrupted flows

EXHIBIT 18-14. LOS CRITERIA FOR PEDESTRIAN SIDEWALKS ON URBAN STREETS

LOS	Travel Speed (m/s)
A	> 1.33
B	> 1.17–1.33
C	> 1.00–1.17
D	> 0.83–1.00
E	≥ 0.58–0.83
F	< 0.58

Guidelines for required inputs and estimated values are in Chapter 11

III. APPLICATIONS

The methodology presented in this chapter is for analyzing the capacity and LOS of pedestrian facilities. The analyst must address two fundamental questions. First, the primary outputs must be identified; these include LOS and effective width (W_E). Second, the default values or estimated values must be identified for use as input data for the analysis. Basically, there are three sources of input data:

1. Default values found in this manual;
2. Estimates or locally derived default values developed by the user; and
3. Values derived from field measurements and observation.

For each of the input variables, a value must be supplied to calculate both the primary and secondary outputs.

A common application of this method is to compute the LOS of a current or changed facility in the near term or the distant future. This application is termed operational, and its primary output is LOS. Alternatively, effective width, W_E , can be set as the primary output; this is known as a design analysis. It requires that a LOS goal be established, and the result typically is used to estimate the adequacy of a specific effective width.

Another general type of analysis can be defined as planning. Planning analysis uses estimates, HCM default values, and local default values as inputs and determines LOS or effective width as outputs. The difference between a planning analysis and an operational or design analysis is that most or all of the input values in planning come from estimates or default values, but operational and design analyses employ field measurements or known values for most or all of the variables.

COMPUTATIONAL STEPS

The worksheets for computations involving pedestrian facilities are shown in Exhibits 18-15 and 18-16. For all applications, the analyst provides general information and site information.

Operational (LOS)

For operational (LOS) analysis, all flow data are entered as input. Based on the type of pedestrian facility, performance measures are computed and LOS is determined.

Design (W_E)

The objective of design (W_E) analysis is to estimate the minimum effective width of a facility, given a desired LOS. For sidewalks and crosswalks, first the maximum pedestrian unit flow rate for the desired LOS is determined. Then effective widths are computed by solving the pedestrian unit flow-rate equation backwards.

PLANNING APPLICATIONS

Planning (LOS)

Planning (W_E)

The two planning applications—for LOS and W_E —correspond to procedures described for operations and design. The primary criterion that categorizes these as planning applications is the use of estimates, HCM default values, and local default values. Chapter 11 contains more information on the use of default values.

ANALYSIS TOOLS

The worksheets shown in Exhibits 18-15 and 18-16 and provided in Appendix A can be used to perform all applications of the methodology.

EXHIBIT 18-15. PEDESTRIANS WORKSHEET

PEDESTRIANS WORKSHEET										
General Information					Site Information					
Analyst	_____				Facility	_____				
Agency or Company	_____				Jurisdiction	_____				
Date Performed	_____				Analysis Year	_____				
Analysis Time Period	_____									
<input type="checkbox"/> Operational (LOS)		<input type="checkbox"/> Design (W_E)			<input type="checkbox"/> Planning (LOS)			<input type="checkbox"/> Planning (W_E)		
Walkways and Sidewalk Pedestrian Facilities										
					1		2			
Total width of crosswalks, W_T (m)										
Sum of obstructions width and/or shy distances, ¹ W_O (m)										
Effective crosswalk width, W_E (m), $W_E = W_T - W_O$										
Peak 15-min flow rate (both directions), v_{15} (p/15-min)										
Pedestrian unit flow rate, v_p (p/min/m), $v_p = \frac{v_{15}}{15 \times W_E}$										
LOS (Exhibits 18-3, 18-4, 18-5, 18-6, or 18-7)										
Shared Pedestrian-Bicycle Facilities										
Mean pedestrian speed, S_p (m/s)										
Mean bicycle speed, S_b (m/s)										
Same-direction bicycle flow rate, Q_{sb} (bicycles/h)										
Opposing-direction bicycle flow rate, Q_{ob} (bicycles/h)										
Passing events, F_p (events/h), $F_p = Q_{sb} \left(1 - \frac{S_p}{S_b}\right)$										
Opposing events, F_m (events/h), $F_m = Q_{ob} \left(1 + \frac{S_p}{S_b}\right)$										
Total events, F (events/h), $F = F_p + 0.5F_m$										
LOS (Exhibit 18-8)										
Crossings at Signalized Intersections, Unsignalized Intersections, and Urban Street Facilities										
Pedestrian Delay at Signalized Intersections										
	1	2	3	4	5	6	7	8		
Cycle length, C (s)										
Effective green time for pedestrians, g (s)										
Average delay, d_p (s), $d_p = \frac{0.5(C-g)^2}{C}$										
LOS at signalized intersections (Exhibit 18-9)										
Pedestrian Delay at TWSC Intersections										
Pedestrian walking speed, S_p (m/s)										
Pedestrian start-up time, t_s (s)										
Length of crosswalk, L (m)										
Single pedestrian critical gap, t_c (s), $t_c = \frac{L}{S_p} + t_s$										
Typical pedestrian number in crossing platoon, N_c										
Spatial pedestrian distribution, ² N_p (p), $N_p = \text{INT} \left[\frac{0.75(N_c - 1)}{W_E} \right] + 1$										
Group critical gap, t_G (s), $t_G = t_c + 2(N_p - 1)$										
Vehicular flow rate, v (veh/s)										
Average pedestrian delay, d_p (s), $d_p = \frac{1}{v} (e^{vt_G} - vt_G - 1)$										
LOS at unsignalized intersections (Exhibit 18-13)										
Average Pedestrian Travel Speeds Over Several Links										
Length of link, ³ L_i (m)										
Average travel speed, S_A (m/s), $S_A = \frac{L_i}{\sum \frac{L_i}{S_i} + \sum d_j}$										
LOS urban street pedestrian facility (Exhibit 18-14)										
Notes										
1. Includes curb width, street furniture, window shops, building protrusions, inside clearance, and all other field-observed obstructions.										
2. If there is no platoon crossing, assume $N_p = 1$.										
3. Link length includes segment length of sidewalk and upstream signal crosswalk length.										

IV. EXAMPLE PROBLEMS

Problem No.	Description	Application
1	Find LOS of a sidewalk segment.	Operational (LOS)
2	Find LOS of a shared pedestrian-bicycle facility, and if it fails, find LOS of a separate pedestrian path and bicycle path.	Operational (LOS)
3	Find LOS of a crosswalk at a signalized intersection. Also, find LOS and space requirements at the crosswalks and street corner.	Operational (LOS)
4	Find LOS of a crosswalk at a TWSC intersection.	Operational (LOS)
5	Find LOS of a pedestrian sidewalk on an urban street, and determine minimum effective sidewalk width to achieve LOS D.	Planning (W_e)

EXAMPLE PROBLEM 1

The Sidewalk 4.3-m-wide sidewalk segment bordered by curb on one side and stores with window-shopping displays on the other.

The Question What is the LOS during the peak 15 min on the average and within platoons?

The Facts

- √ 15-min peak flow rate = 1,250 p/15-min;
- √ Total sidewalk width = 4.3 m;
- √ Curb on one side;
- √ Window-shopping displays on one side; and
- √ No other obstructions.

Comments

- √ Assume building buffer (i.e., preempted width) for window displays is 0.9 m.

Outline of Solution All input parameters except curb width and obstruction due to window displays are known. Effective sidewalk width should be determined and then used to compute the average unit flow rate. LOS will be determined for average and for platoon flow conditions.

Steps

1. Determine width adjustments (shy distance) to walkway (use Exhibit 18-1).	W_{o1} (curb) = 0.5 m W_{o6} (window shopping) = 0.9 m
2. Determine effective width W_E (use Equation 18-1).	$W_E = W_T - W_o$ $W_E = 4.3 - 0.5 - 0.9 = 2.9$ m
3. Find v_p (use Equation 18-2).	$v_p = \frac{v_{15}}{15 * W_E}$ $v_p = \frac{1250}{15 * 2.9} = 28.7$ p/min/m
4. Determine LOS for average condition (use Exhibit 18-3).	LOS C
5. Determine LOS within platoon condition (use Exhibit 18-4).	LOS D

Results The sidewalk is expected to operate at LOS C for average conditions and at LOS D for conditions within platoons.

Example Problem 1

PEDESTRIANS WORKSHEET									
General Information					Site Information				
Analyst	JM/YE				Facility	3rd St.			
Agency or Company	CEI				Jurisdiction				
Date Performed	5/6/99				Analysis Year	1999			
Analysis Time Period	Peak								
<input checked="" type="checkbox"/> Operational (LOS)		<input type="checkbox"/> Design (W _E)			<input type="checkbox"/> Planning (LOS)			<input type="checkbox"/> Planning (W _E)	
Walkways and Sidewalk Pedestrian Facilities									
		1			2				
Total width of crosswalks, W _T (m)	4.3								
Sum of obstructions width and/or shy distances, ¹ W _O (m)	1.4								
Effective crosswalk width, W _E (m), W _E = W _T - W _O	2.9								
Peak 15-min flow rate (both directions), v ₁₅ (p/15-min)	1250								
Pedestrian unit flow rate, v _p (p/min/m), v _p = $\frac{v_{15}}{15 \cdot W_E}$	28.7								
LOS (Exhibits 18-3, 18-4, 18-5, 18-6, or 18-7)	C/D								
Shared Pedestrian-Bicycle Facilities									
Mean pedestrian speed, S _p (m/s)									
Mean bicycle speed, S _b (m/s)									
Same-direction bicycle flow rate, Q _{sb} (bicycles/h)									
Opposing-direction bicycle flow rate, Q _{ob} (bicycles/h)									
Passing events, F _p (events/h), F _p = $Q_{sb} \left(1 - \frac{S_p}{S_b}\right)$									
Opposing events, F _m (events/h), F _m = $Q_{ob} \left(1 + \frac{S_p}{S_b}\right)$									
Total events, F (events/h), F = F _p + 0.5F _m									
LOS (Exhibit 18-8)									
Crossings at Signalized Intersections, Unsignalized Intersections, and Urban Street Facilities									
Pedestrian Delay at Signalized Intersections									
Cycle length, C (s)	1	2	3	4	5	6	7	8	
Effective green time for pedestrians, g (s)									
Average delay, d _p (s), d _p = $\frac{0.5(C-g)^2}{C}$									
LOS at signalized intersections (Exhibit 18-9)									
Pedestrian Delay at TWSC Intersections									
Pedestrian walking speed, S _p (m/s)									
Pedestrian start-up time, t _s (s)									
Length of crosswalk, L (m)									
Single pedestrian critical gap, t _c (s), t _c = $\frac{L}{S_p} + t_s$									
Typical pedestrian number in crossing platoon, N _c									
Spatial pedestrian distribution, ² N _p (p), N _p = INT $\left[\frac{0.75(N_c - 1)}{W_E} \right] + 1$									
Group critical gap, t _G (s), t _G = t _c + 2(N _p - 1)									
Vehicular flow rate, v (veh/s)									
Average pedestrian delay, d _p (s), d _p = $\frac{1}{v} (e^{vt_G} - vt_G - 1)$									
LOS at unsignalized intersections (Exhibit 18-13)									
Average Pedestrian Travel Speeds Over Several Links									
Length of link, ³ L _i (m)									
Average travel speed, S _A (m/s), S _A = $\frac{L_i}{\sum \frac{L_i}{S_i} + \sum d_i}$									
LOS urban street pedestrian facility (Exhibit 18-14)									
Notes									
1. Includes curb width, street furniture, window shops, building protrusions, inside clearance, and all other field-observed obstructions. 2. If there is no platoon crossing, assume N _p = 1. 3. Link length includes segment length of sidewalk and upstream signal crosswalk length.									

EXAMPLE PROBLEM 2

The Shared Path An east-west, uninterrupted, two-way, pedestrian-bicycle facility 2.4 m wide.

The Question What is the LOS of this facility? If it is operating lower than LOS C, what is the LOS for pedestrians on a separate path?

The Facts

- √ Effective width = 2.4 m;
- √ Bicycle flow rate in the same direction = 100 bicycles/h;
- √ Bicycle flow rate in the opposing direction = 100 bicycles/h; and
- √ Peak pedestrian flow = 100 p/15-min.

Comments

- √ Assume a pedestrian speed of 1.2 m/s;
- √ Assume a bicycle speed of 5.0 m/s; and
- √ Assume bicycles need a 2.4-m-wide path. If a separate pedestrian path is needed, use a width of 1.5 m.

Outline of Solution All input parameters are known; therefore no default values are required. LOS for the shared path will be determined. If the result is LOS C or lower, average unit flow rate and LOS for a separate pedestrian facility will be determined.

Steps

<p>1. Determine number of passing events, F_p (use Equation 18-3).</p>	$F_p = Q_{sb} \left(1 - \frac{S_p}{S_b} \right)$ $F_p = 100 \left(1 - \frac{1.2}{5.0} \right) = 76 \text{ events/h}$
<p>2. Determine number of opposing events, F_m (use Equation 18-3).</p>	$F_m = Q_{ob} \left(1 + \frac{S_p}{S_b} \right)$ $F_m = 100 \left(1 + \frac{1.2}{5.0} \right) = 124 \text{ events/h}$
<p>3. Determine total number of events, F (use Equation 18-4).</p>	$F = F_p + 0.5F_m$ $F = 76 + 0.5(124) = 138 \text{ events/h}$
<p>4. Determine shared-path LOS (use Exhibit 18-8).</p>	<p>LOS D Need separate pedestrian path or walkway.</p>
<p>5. Find v_p (use Equation 18-2). Assume 1.5-m walkway will be constructed for pedestrians.</p>	$v_p = \frac{v_{15}}{15 * W_E}$ $v_p = \frac{100}{15 * 1.5} = 4.4 \text{ p/min/m}$
<p>6. Determine LOS for a separate pedestrian facility (use Exhibit 18-3).</p>	<p>LOS A</p>

Results The shared pedestrian-bicycle facility operates at LOS D for pedestrians. If a separate 1.5-m pedestrian walkway is provided, LOS A could be achieved for pedestrians.

Example Problem 2

PEDESTRIANS WORKSHEET									
General Information					Site Information				
Analyst	JMYE				Facility	Shared			
Agency or Company	CEI				Jurisdiction				
Date Performed	2/1/99				Analysis Year	1999			
Analysis Time Period	Peak								
<input checked="" type="checkbox"/> Operational (LOS)		<input type="checkbox"/> Design (W _c)			<input type="checkbox"/> Planning (LOS)			<input type="checkbox"/> Planning (W _p)	
Walkways and Sidewalk Pedestrian Facilities									
		1					2		
Total width of crosswalks, W _T (m)									
Sum of obstructions width and/or shy distances, ¹ W _O (m)									
Effective crosswalk width, W _E (m), W _E = W _T - W _O									
Peak 15-min flow rate (both directions), v ₁₅ (p/15-min)	1.5								
Pedestrian unit flow rate, v _p (p/min/m), v _p = $\frac{v_{15}}{15 \cdot W_E}$	100								
LOS (Exhibits 18-3, 18-4, 18-5, 18-6, or 18-7)	4.4								
	A								
Shared Pedestrian-Bicycle Facilities									
Mean pedestrian speed, S _p (m/s)	1.2								
Mean bicycle speed, S _b (m/s)	5.0								
Same-direction bicycle flow rate, Q _{sb} (bicycles/h)	100								
Opposing-direction bicycle flow rate, Q _{ob} (bicycles/h)	100								
Passing events, F _p (events/h), F _p = Q _{sb} (1 - $\frac{S_p}{S_b}$)	76								
Opposing events, F _m (events/h), F _m = Q _{ob} (1 + $\frac{S_p}{S_b}$)	124								
Total events, F (events/h), F = F _p + 0.5F _m	138								
LOS (Exhibit 18-8)	D								
Crossings at Signalized Intersections, Unsignalized Intersections, and Urban Street Facilities									
Pedestrian Delay at Signalized Intersections									
	1	2	3	4	5	6	7	8	
Cycle length, C (s)									
Effective green time for pedestrians, g (s)									
Average delay, d _p (s), d _p = $\frac{0.5(C - g)^2}{C}$									
LOS at signalized intersections (Exhibit 18-9)									
Pedestrian Delay at TWSC Intersections									
Pedestrian walking speed, S _p (m/s)									
Pedestrian start-up time, t _s (s)									
Length of crosswalk, L (m)									
Single pedestrian critical gap, t _c (s), t _c = $\frac{L}{S_p} + t_s$									
Typical pedestrian number in crossing platoon, N _c									
Spatial pedestrian distribution, ² N _p (p), N _p = INT $\left[\frac{0.75(N_c - 1)}{W_E} \right] + 1$									
Group critical gap, t _G (s), t _G = t _c + 2(N _p - 1)									
Vehicular flow rate, v (veh/s)									
Average pedestrian delay, d _p (s), d _p = $\frac{1}{v} (e^{vt_G} - vt_G - 1)$									
LOS at unsignalized intersections (Exhibit 18-13)									
Average Pedestrian Travel Speeds Over Several Links									
Length of link, ³ L _i (m)									
Average travel speed, S _A (m/s), S _A = $\frac{L_i}{\sum \frac{L_i}{S_i} + \sum d_i}$									
LOS urban street pedestrian facility (Exhibit 18-14)									
Notes									
1. Includes curb width, street furniture, window shops, building protrusions, inside clearance, and all other field-observed obstructions.									
2. If there is no platoon crossing, assume N _p = 1.									
3. Link length includes segment length of sidewalk and upstream signal crosswalk length.									

EXAMPLE PROBLEM 3

The Crosswalk A pedestrian crossing at a signalized intersection operating on a two-phase, 80.0-s cycle length, with 4.0-s clearance, and no pedestrian signals.

The Question What is the pedestrian LOS at the crossing, based on delay and available space?

The Facts

- Major street
 - √ Crosswalk length, $L_d = 14.0$ m;
 - √ Crosswalk width, $W_d = 5.0$ m;
 - √ Inbound pedestrian count, $v_{di} = 450$ p/15-min;
 - √ Outbound pedestrian count, $v_{do} = 240$ p/15-min; and
 - √ Phase green time, $G_d = 44.0$ s.

- Minor street
 - √ Crosswalk length, $L_c = 8.5$ m;
 - √ Crosswalk width, $W_c = 5.0$ m;
 - √ Inbound pedestrian count, $v_{ci} = 540$ p/15-min;
 - √ Outbound pedestrian count, $v_{co} = 300$ p/15-min; and
 - √ Phase green time, $G_c = 28.0$ s.

- Corner
 - √ Radius = 6.0 m;
 - √ Sidewalk flow, $v_{a,b} = 225$ p/15-min; and
 - √ Sidewalk width, $W_{a \text{ or } b} = 5.0$ m.

Comments

- √ Assume pedestrian crossing speed of 1.2 m/s and no pedestrian lost time.

Steps

<p>1. Compute average delay for pedestrians crossing both streets (use Equation 18-5). Based on the assumptions, the effective pedestrian green times are equivalent to the displayed parallel vehicle green time.</p>	$d_p = \frac{(C - G)^2}{2C}$ $d_p (\text{major}) = \frac{(80.0 - 28.0)^2}{2(80.0)} = 16.9 \text{ s}$ <p>Using Exhibit 18-9, LOS B.</p> $d_p (\text{minor}) = \frac{(80.0 - 44.0)^2}{2(80.0)} = 8.1 \text{ s}$ <p>Using Exhibit 18-9, LOS A.</p>
<p>2. Net time-space available for crossing major street (use Equation 18-11).</p>	$TS = L_d W_E \left(G_c - \frac{L}{2S_p} \right)$ $TS = (14)(5.0) \left(28.0 - \frac{14}{2.4} \right) = 1552 \text{ m}^2\text{-s}$
<p>3. Perform crosswalk LOS time-space analysis. Convert flows to p/cycle.</p>	$v_{ci} = \left(\frac{540}{15} \right) \left(\frac{80.0}{60} \right) = 48 \text{ p/cycle}$ <p>$v_{co} = 27$ p/cycle; $v_{di} = 40$ p/cycle; $v_{do} = 21$ p/cycle; $v_{a,b} = 20$ p/cycle</p>
<p>4. Perform street corner analysis. Total circulating pedestrian flow and available time-space (use Equation 18-6).</p>	$V_{tot} = 48 + 27 + 40 + 21 + 20 = 156 \text{ p/cycle}$ $TS = C(W_a W_b - 0.215R^2)$ $TS = 80.0[(5.0)(5.0) - 0.215(6.0)^2] = 1381 \text{ m}^2\text{-s}$

<p>4. (continued) Holding-area waiting time for pedestrians waiting to cross major-street. Note that the red time, R_{mi}, is equal to the major-street green plus the one clearance interval (use Equation 18-7).</p> <p>The holding time for pedestrians waiting to cross the minor street (use Equation 18-8).</p> <p>Net time-space available at corner—assume $0.50 \text{ m}^2/\text{p}$ in queue (use Equation 18-9).</p> <p>Space per circulating pedestrian (use Equation 18-10).</p>	$Q_{tdo} = \frac{v_{do}R_{mi}^2}{2C}$ $Q_{tdo} = \frac{21(44.0 + 4.0)^2}{2(80.0)} = 302.4 \text{ p-s}$ $Q_{tco} = \frac{v_{co}R_{mj}^2}{2C}$ $Q_{tco} = \frac{27(28.0 + 4.0)^2}{2(80.0)} = 172.8 \text{ p-s}$ $TS_c = TS - [0.50(Q_{tdo} + Q_{tco})]$ $TS_c = 1381 - 0.50(302.4 + 172.8) = 1143.4 \text{ m}^2\text{-s}$ $M = \frac{TS_c}{4v_{tot}}$ $M = \frac{1143.4}{4(156)} = 1.83 \text{ m}^2/\text{p}$ <p>Using Exhibit 18-3, LOS D.</p>
<p>5. Crossing the major street: number of pedestrians accumulated at start of pedestrian green time.</p> <p>Crossing time needed to service the 14 pedestrians (use Equation 18-13).</p>	$N = \frac{v_{do}(C - G_c)}{C}$ $N = \frac{21(80.0 - 28.0)}{80.0} = 14 \text{ p/cycle}$ $t = 3.2 + \frac{L}{S_p} + \left(0.81 * \frac{N}{W_E} \right)$ $t = 3.2 + \frac{14.0}{1.2} + \left(0.81 * \frac{14.0}{5.0} \right) = 17.1 \text{ s}$
<p>6. Total crosswalk occupancy time required for crossing (use Equation 18-14).</p> <p>Space per pedestrian crossing (use Equation 18-15).</p> <p>Crossing the minor street.</p>	$T = (v_{di} + v_{do}) t$ $T = (40 + 21) (17.1) = 1043 \text{ p-s}$ $M = \frac{TS}{T} = \frac{1552}{1043} = 1.49 \text{ m}^2/\text{p}$ <p>Using Exhibit 18-3, LOS D.</p> $N = 12 \text{ p/cycle}$ $t = 12.2 \text{ s}$ $TS = 1719 \text{ m}^2\text{-s}$ $T = 915 \text{ p-s}$ $M = \frac{TS}{T} = \frac{1719}{915} = 1.88 \text{ m}^2/\text{p}$ <p>Using Exhibit 18-3, LOS D.</p>

Example Problem 3

Results

Facility and Activity	LOS Criterion ^a	Value	LOS
Corner—waiting time, crossing major street	Delay (s)	16.9	B (Exhibit 18-9)
Corner—waiting time, crossing minor street	Delay (s)	8.1	A (Exhibit 18-9)
Corner—circulating space	Space (m ² /p)	1.83	D (Exhibit 18-3)
Crosswalk space on major street	Space (m ² /p)	1.49	D (Exhibit 18-3)
Crosswalk space on minor street	Space (m ² /p)	1.88	D (Exhibit 18-3)

Note:

a. Delay is the primary LOS criterion for corner areas.

Example Problem 3

PEDESTRIANS AT SIGNALIZED INTERSECTIONS WORKSHEET			
General Information		Site Information	
Analyst	<u>N.R.</u>	Intersection/Corner	<u>Signal Crossing</u>
Agency or Company	<u>NCSU</u>	Jurisdiction	
Date Performed	<u>6/23/99</u>	Analysis Year	<u>1999</u>
Analysis Period	<u>Peak</u>		
<input checked="" type="checkbox"/> Operational (LOS)		<input type="checkbox"/> Design (W _E)	
		<input type="checkbox"/> Planning (LOS)	
		<input type="checkbox"/> Planning (W _E)	
Inputs		Geometric Inputs	
Cycle length, C	<u>80.0</u> s		
Minor-street red phase, R _{mi}	<u>48.0</u> s		
Major-street red phase, R _{mj}	<u>32.0</u> s		
Minor-street effective green, g _i	<u>44.0</u> s		
Major-street effective green, g _j	<u>28.0</u> s		
	Flow, p/15-min	Flow, $\frac{p}{15\text{min}} \cdot \frac{1}{60} = \text{p/s}$	Flow, p/s * C
V _{ci}	540	0.60	48
V _{co}	300	0.33	27
V _{di}	450	0.50	40
V _{do}	240	0.27	21
V _{a, b}	225	0.25	20
V _{tot}	1755	1.95	156
Street Corner Time-Space Analysis			
Total time-space, TS (m ² -s) TS = C(W _a W _b - 0.215R ²)		1381	
Time spent by pedestrians crossing major street, Q _{tdo} (p-s), $Q_{tdo} = \frac{v_{do} R_{mi}^2}{2C}$		302.4	
Time spent by pedestrians crossing minor street, Q _{lco} (p-s), $Q_{lco} = \frac{v_{co} R_{mj}^2}{2C}$		172.8	
Total time-space available, TS _c (m ² -s), TS _c = TS - [0.5(Q _{tdo} + Q _{lco})]		1143.4	
Circulation area per pedestrian, M (m ² /p), M = $\frac{TS_c}{4V_{tot}}$		1.83	
LOS (Exhibit 18-3)		D	
Crosswalk Time-Space Analysis			
Average Pedestrian Delay at Signalized Intersections		Crosswalk D	Crosswalk C
Average delay, d _p (s), $d_p = \frac{0.5(C - g)^2}{C}$		16.9	8.1
LOS at signalized intersection (Exhibit 18-9)		B	A
Number of pedestrians arriving during Don't Walk or red indication, ¹ N _{ped} (p)		14	12
Average pedestrian walking speed, S _p (m/s)		1.2	1.2
Total crossing time, ² t (s)		17.1	12.2
Total time-space, TS (m ² -s), TS = LW(WALK + FDW - $\frac{L}{2S_p}$)		1552	1719
Total crosswalk occupancy time, T (p-s) T = (v _i + v _o)t		1043	915
Number of conflicting right-turning vehicles, N _{rv} (veh)			
Time-space of right-turning vehicles, TS _{rv} (m ² -s), TS _{rv} = 12N _{rv} W _E			
Effective time-space, TS _E (m ² -s), TS _E = TS - TS _{rv}		1552	1719
Circulation area per pedestrian, M (m ² /p), M = $\frac{TS_E}{T}$		1.49	1.88
LOS (Exhibit 18-3)		D	D
Notes			
1. Number of people in the subject movement who arrive before the WALK or concurrent green indication and exit the curb during the WALK or concurrent green indication. $N_{ped} = \frac{v_{co} \text{ or } v_{do} (C - G)}{C}$			
2. If W > 3.0 m, t = 3.2 + $\frac{L}{S_p}$ + (0.81 $\frac{N_{ped}}{W}$); but if W ≤ 3.0 m, t = 3.2 + $\frac{L}{S_p}$ + (0.27N _{ped}).			

EXAMPLE PROBLEM 4

The Crosswalk Crosswalk of TWSC intersection on a major street without a median.

The Question What is the LOS for pedestrians crossing the major street with no stop signs?

The Facts

- √ Pedestrian walking speed = 1.2 m/s;
- √ Pedestrian start-up time and end clearance time = 3.0 s;
- √ Crosswalk length = 12.0 m;
- √ Effective width of crosswalk = 3.0 m;
- √ Flow rate = 400 veh/h or 400/3600 = 0.11 veh/s; and
- √ Pedestrian flow rate = 72 p/h or 72/3600 = 0.02 p/s.

Outline of Solution All input parameters are known. Critical gap values are computed to determine the average delay of pedestrians. Use the delay to determine LOS.

Steps

1. Find t_c (use Equation 18-17).	$t_c = \frac{L}{S_p} + t_s$ $t_c = \frac{12.0}{1.2} + 3.0 = 13.0 \text{ s}$
2. Find N_c (use Equation 18-19).	$N_c = \frac{v_p e^{v_p t_c} + v e^{-v t_c}}{(v_p + v) e^{(v_p - v) t_c}}$ $N_c = \frac{0.02 e^{(0.02 \cdot 13.0)} + 0.11 e^{(-0.11 \cdot 13.0)}}{(0.02 + 0.11) e^{(0.02 - 0.11) 13.0}} = 1.3$
3. Find N_p (use Equation 18-18).	$N_p = \text{INT} \left[\frac{0.75(N_c - 1)}{W_E} \right] + 1$ $N_p = \text{INT} \left[\frac{0.75(1.3 - 1)}{3.0} \right] + 1 = 1$
4. Find t_G (use Equation 18-20).	$t_G = t_c + 2(N_p - 1)$ $t_G = 13.0 + 2(1 - 1) = 13.0 \text{ s}$
5. Find d_p (use Equation 18-21).	$d_p = \frac{1}{v} (e^{v t_G} - v t_G - 1)$ $d_p = \frac{1}{0.11} (e^{0.11(13)} - (0.11)(13) - 1) = 15.9 \text{ s}$
6. Determine LOS (use Exhibit 18-13).	LOS C

Results The pedestrian crossing operates at LOS C.

Example Problem 4

PEDESTRIANS WORKSHEET									
General Information					Site Information				
Analyst	JMYE				Facility	TWSC			
Agency or Company	CEI				Jurisdiction				
Date Performed	5/9/99				Analysis Year	1999			
Analysis Time Period	Peak								
<input checked="" type="checkbox"/> Operational (LOS)		<input type="checkbox"/> Design (W _E)			<input type="checkbox"/> Planning (LOS)			<input type="checkbox"/> Planning (W _E)	
Walkways and Sidewalk Pedestrian Facilities									
		1					2		
Total width of crosswalks, W _T (m)									
Sum of obstructions width and/or shy distances, ¹ W _O (m)									
Effective crosswalk width, W _E (m), W _E = W _T - W _O	3.0								
Peak 15-min flow rate (both directions), v ₁₅ (p/15-min)									
Pedestrian unit flow rate, v _p (p/min/m), v _p = $\frac{v_{15}}{15 \cdot W_E}$									
LOS (Exhibits 18-3, 18-4, 18-5, 18-6, or 18-7)									
Shared Pedestrian-Bicycle Facilities									
Mean pedestrian speed, S _p (m/s)									
Mean bicycle speed, S _b (m/s)									
Same-direction bicycle flow rate, Q _{sb} (bicycles/h)									
Opposing-direction bicycle flow rate, Q _{ob} (bicycles/h)									
Passing events, F _p (events/h), F _p = Q _{ob} $(1 - \frac{S_p}{S_b})$									
Opposing events, F _m (events/h), F _m = Q _{ob} $(1 + \frac{S_p}{S_b})$									
Total events, F (events/h), F = F _p + 0.5F _m									
LOS (Exhibit 18-8)									
Crossings at Signalized Intersections, Unsignalized Intersections, and Urban Street Facilities									
Pedestrian Delay at Signalized Intersections									
	1	2	3	4	5	6	7	8	
Cycle length, C (s)									
Effective green time for pedestrians, g (s)									
Average delay, d _p (s), d _p = $\frac{0.5(C-g)^2}{C}$									
LOS at signalized intersections (Exhibit 18-9)									
Pedestrian Delay at TWSC Intersections									
Pedestrian walking speed, S _p (m/s)	1.2								
Pedestrian start-up time, t _s (s)	3.0								
Length of crosswalk, L (m)	12.0								
Single pedestrian critical gap, t _c (s), t _c = $\frac{L}{S_p} + t_s$	13.0								
Typical pedestrian number in crossing platoon, N _c	1.3								
Spatial pedestrian distribution, ² N _p (p), N _p = INT $\left[\frac{0.75(N_c - 1)}{W_E} \right] + 1$	1								
Group critical gap, t _G (s), t _G = t _c + 2(N _p - 1)	13.0								
Vehicular flow rate, v (veh/s)	0.11								
Average pedestrian delay, d _p (s), d _p = $\frac{1}{v} (e^{vt_G} - vt_G - 1)$	15.9								
LOS at unsignalized intersections (Exhibit 18-13)	C								
Average Pedestrian Travel Speeds Over Several Links									
Length of link, ³ L _i (m)									
Average travel speed, S _A (m/s), S _A = $\frac{L_i}{\sum \frac{L_i}{S_i} + \sum d_i}$									
LOS urban street pedestrian facility (Exhibit 18-14)									
Notes									
1. Includes curb width, street furniture, window shops, building protrusions, inside clearance, and all other field-observed obstructions.									
2. If there is no platoon crossing, assume N _p = 1.									
3. Link length includes segment length of sidewalk and upstream signal crosswalk length.									

EXAMPLE PROBLEM 5

The Sidewalk A proposed 2.0-km pedestrian sidewalk on a new urban street with three signalized intersections.

The Question What is the LOS with the projected pedestrian volume? What is the minimum effective width required to achieve LOS B?

The Facts

- √ Projected peak 15-min pedestrian volume across the urban street = 600 p/15-min; and
- √ $L_1 = 500$ m, $L_2 = 200$ m, $L_3 = 1000$ m, $L_4 = 300$ m.

Comments

- √ Assume $C = 90.0$ s for all intersections;
- √ Assume $g = 0.5C - 4.0 = 0.5(90.0) - 4.0 = 41.0$ s for all intersections; and
- √ For planning, use default of 1.2 m/s for pedestrian walking speed.

Outline of Solution All inputs are known. Pedestrian delay at each intersection and speed over the entire urban street are determined. LOS for the whole facility is determined. The maximum unit flow rate to achieve LOS B will be used to estimate effective sidewalk width.

Steps

1. Compute average delay of pedestrians at intersections (use Equation 18-5).	$d_p = \frac{(C - g)^2}{2C}$ $d_p = \frac{(90.0 - 41.0)^2}{2(90.0)} = 13.3 \text{ s}$
2. Find S_A (use Equation 18-22).	$S_A = \frac{L_T}{\sum \frac{L_i}{S_i} + \sum d_i}$ $S_A = \frac{2000}{\frac{2000}{1.2} + 3(13.3)} = 1.17 \text{ m/s}$
3. Find LOS (use Exhibit 18-13).	LOS C
4. Find maximum unit flow rate for LOS B (use Exhibit 18-3).	23 p/min/m
5. Compute W_E (use Equation 18-2).	$v_p = \frac{v_{15}}{15 * W_E}$ $W_E = \frac{v_{15}}{15 * v_p}$ $W_E = \frac{600}{15 * 23} = 1.74 \text{ m}$

Results The proposed sidewalk will operate at LOS C. To achieve LOS B, the sidewalk requires an effective width of 1.74 m.

Example Problem 5

PEDESTRIANS WORKSHEET										
General Information					Site Information					
Analyst	JMYE				Facility	Urban Street				
Agency or Company	CEI				Jurisdiction					
Date Performed	5/9/99				Analysis Year	1999				
Analysis Time Period	Peak									
<input type="checkbox"/> Operational (LOS)		<input type="checkbox"/> Design (W _E)			<input type="checkbox"/> Planning (LOS)			<input checked="" type="checkbox"/> Planning (W _E)		
Walkways and Sidewalk Pedestrian Facilities										
					1		2			
Total width of crosswalks, W _T (m)										
Sum of obstructions width and/or shy distances, ¹ W _O (m)										
Effective crosswalk width, W _E (m), W _E = W _T - W _O					1.74					
Peak 15-min flow rate (both directions), v ₁₅ (p/15-min)					600					
Pedestrian unit flow rate, v _p (p/min/m), v _p = $\frac{v_{15}}{15 \cdot W_E}$					23					
LOS (Exhibits 18-3, 18-4, 18-5, 18-6, or 18-7)					B					
Shared Pedestrian-Bicycle Facilities										
Mean pedestrian speed, S _p (m/s)										
Mean bicycle speed, S _b (m/s)										
Same-direction bicycle flow rate, Q _{sb} (bicycles/h)										
Opposing-direction bicycle flow rate, Q _{ob} (bicycles/h)										
Passing events, F _p (events/h), F _p = $Q_{sb} \left(1 - \frac{S_p}{S_b}\right)$										
Opposing events, F _m (events/h), F _m = $Q_{ob} \left(1 + \frac{S_p}{S_b}\right)$										
Total events, F (events/h), F = F _p + 0.5F _m										
LOS (Exhibit 18-8)										
Crossings at Signalized Intersections, Unsignalized Intersections, and Urban Street Facilities										
Pedestrian Delay at Signalized Intersections										
	1	2	3	4	5	6	7	8		
Cycle length, C (s)	90.0	90.0	90.0							
Effective green time for pedestrians, g (s)	41.0	41.0	41.0							
Average delay, d _p (s), d _p = $\frac{0.5(C-g)^2}{C}$	13.3	13.3	13.3							
LOS at signalized intersections (Exhibit 18-9)										
Pedestrian Delay at TWSC Intersections										
Pedestrian walking speed, S _p (m/s)										
Pedestrian start-up time, t _s (s)										
Length of crosswalk, L (m)										
Single pedestrian critical gap, t _c (s), t _c = $\frac{L}{S_p} + t_s$										
Typical pedestrian number in crossing platoon, N _c										
Spatial pedestrian distribution, ² N _p (p), N _p = INT $\left[\frac{0.75(N_c - 1)}{W_E}\right] + 1$										
Group critical gap, t _G (s), t _G = t _c + 2(N _p - 1)										
Vehicular flow rate, v (veh/s)										
Average pedestrian delay, d _p (s), d _p = $\frac{1}{v} (e^{v t_G} - v t_G - 1)$										
LOS at unsignalized intersections (Exhibit 18-13)										
Average Pedestrian Travel Speeds Over Several Links										
Length of link, ³ L _i (m)	500	200	1000	300						
Average travel speed, S _A (m/s), S _A = $\frac{L_i}{\sum \frac{L_i}{S_i} + \sum d_i}$	1.17	1.17	1.17	1.17						
LOS urban street pedestrian facility (Exhibit 18-14)	C	C	C	C						
Notes										
1. Includes curb width, street furniture, window shops, building protrusions, inside clearance, and all other field-observed obstructions.										
2. If there is no platoon crossing, assume N _p = 1.										
3. Link length includes segment length of sidewalk and upstream signal crosswalk length.										

V. REFERENCES

1. Roupail, N., J. Hummer, P. Allen, and J. Milazzo. *Recommended Procedures for Chapter 13, Pedestrians, of the Highway Capacity Manual*. Report FHWA-RD-98-107. FHWA, U.S. Department of Transportation, 1999.
2. Pushkarev, B., and J. Zupan. *Urban Space for Pedestrians*. MIT Press, Cambridge, Mass., 1975.

3. Danaher, A., T. Parkinson, P. Ryus, and L. Nowlin. Appendix to Interim Report: Literature Review. In *TCRP A-15: Development of Transit Capacity and Quality of Service Principles, Practices, and Procedures*. Available from the Transit Cooperative Research Program, TRB, National Research Council, Washington, D.C., 1997.
4. Virkler, M. *Quality of Flow Along Pedestrian Arterials*. Combined 18th Annual Australian Road Research Board Transport Research Conference/Transit New Zealand Land Transport Symposium, Christchurch, New Zealand, September 1996.
5. Khisty, C. J. Pedestrian Cross Flows in Corridors. In *Transportation Research Record 847*, TRB, National Research Council, Washington, D.C., 1982, pp. 54–57.
6. Botma, H. Method to Determine Level of Service for Bicycle Paths and Pedestrian Bicycle Paths. In *Transportation Research Record 1502*, TRB, National Research Council, Washington, D.C., 1995, pp. 38–44.
7. Dunn, R., and R. Pretty. *Mid-Block Pedestrian Crossings - An Examination of Delay*. 12th Annual Australian Road Research Board Conference Proceedings, Hobart, Tasmania, Australia, August 1984.
8. *Special Report 209: Highway Capacity Manual*. TRB, National Research Council, Washington, D.C., 1994.
9. Virkler, M. R. Scramble and Crosswalk Signal Timing. In *Transportation Research Record 1636*, TRB, National Research Council, Washington, D.C., 1998, pp. 83–87.
10. Virkler, M. R. Pedestrian Compliance Effects on Signal Delay. In *Transportation Research Record 1636*, TRB, National Research Council, Washington, D.C., 1998, pp. 88–91.
11. Gerlough, D., and M. Huber. *Special Report 165: Traffic Flow Theory: A Monograph*. TRB, National Research Council, Washington, D.C., 1975.

APPENDIX A. WORKSHEETS

PEDESTRIANS WORKSHEET

PEDESTRIANS AT SIGNALIZED INTERSECTIONS WORKSHEET

PEDESTRIANS WORKSHEET									
General Information					Site Information				
Analyst _____					Facility _____				
Agency or Company _____					Jurisdiction _____				
Date Performed _____					Analysis Year _____				
Analysis Time Period _____									
<input type="checkbox"/> Operational (LOS)		<input type="checkbox"/> Design (W _E)			<input type="checkbox"/> Planning (LOS)			<input type="checkbox"/> Planning (W _E)	
Walkways and Sidewalk Pedestrian Facilities									
	1				2				
Total width of crosswalks, W _T (m)									
Sum of obstructions width and/or shy distances, ¹ W _O (m)									
Effective crosswalk width, W _E (m), W _E = W _T - W _O									
Peak 15-min flow rate (both directions), v ₁₅ (p/15-min)									
Pedestrian unit flow rate, v _p (p/min/m), v _p = $\frac{v_{15}}{15 \cdot W_E}$									
LOS (Exhibits 18-3, 18-4, 18-5, 18-6, or 18-7)									
Shared Pedestrian-Bicycle Facilities									
Mean pedestrian speed, S _p (m/s)									
Mean bicycle speed, S _b (m/s)									
Same-direction bicycle flow rate, Q _{sb} (bicycles/h)									
Opposing-direction bicycle flow rate, Q _{ob} (bicycles/h)									
Passing events, F _p (events/h), F _p = Q _{sb} (1 - $\frac{S_p}{S_b}$)									
Opposing events, F _m (events/h), F _m = Q _{ob} (1 + $\frac{S_p}{S_b}$)									
Total events, F (events/h), F = F _p + 0.5F _m									
LOS (Exhibit 18-8)									
Crossings at Signalized Intersections, Unsignalized Intersections, and Urban Street Facilities									
Pedestrian Delay at Signalized Intersections									
	1	2	3	4	5	6	7	8	
Cycle length, C (s)									
Effective green time for pedestrians, g (s)									
Average delay, d _p (s), d _p = $\frac{0.5(C-g)^2}{C}$									
LOS at signalized intersections (Exhibit 18-9)									
Pedestrian Delay at TWSC Intersections									
Pedestrian walking speed, S _p (m/s)									
Pedestrian start-up time, t _s (s)									
Length of crosswalk, L (m)									
Single pedestrian critical gap, t _c (s), t _c = $\frac{L}{S_p} + t_s$									
Typical pedestrian number in crossing platoon, N _c									
Spatial pedestrian distribution, ² N _p (p), N _p = INT $\left[\frac{0.75(N_c - 1)}{W_F} \right] + 1$									
Group critical gap, t _G (s), t _G = t _c + 2(N _p - 1)									
Vehicular flow rate, v (veh/s)									
Average pedestrian delay, d _p (s), d _p = $\frac{1}{v} (e^{vt_G} - vt_G - 1)$									
LOS at unsignalized intersections (Exhibit 18-13)									
Average Pedestrian Travel Speeds Over Several Links									
Length of link, ³ L _i (m)									
Average travel speed, S _A (m/s), S _A = $\frac{L_i}{\sum \frac{L_i}{S_i} + \sum d_j}$									
LOS urban street pedestrian facility (Exhibit 18-14)									
Notes									
1. Includes curb width, street furniture, window shops, building protrusions, inside clearance, and all other field-observed obstructions.									
2. If there is no platoon crossing, assume N _p = 1.									
3. Link length includes segment length of sidewalk and upstream signal crosswalk length.									

PEDESTRIANS AT SIGNALIZED INTERSECTIONS WORKSHEET				
General Information		Site Information		
Analyst _____	Intersection/Corner _____			
Agency or Company _____	Jurisdiction _____			
Date Performed _____	Analysis Year _____			
Analysis Period _____				
<input type="checkbox"/> Operational (LOS)	<input type="checkbox"/> Design (W_E)	<input type="checkbox"/> Planning (LOS)	<input type="checkbox"/> Planning (W_E)	
Inputs		Geometric Inputs		
Cycle length, C _____ s	Minor-street red phase, R_{mi} _____ s			
Major-street red phase, R_{mj} _____ s	Minor-street effective green, g_i _____ s			
Major-street effective green, g_j _____ s				
Flow, p/15-min	Flow, $\frac{p}{15 \text{ min}} \cdot \frac{1}{60} = p/s$			Flow, p/s * C
V_{ci}				
V_{co}				
V_{di}				
V_{do}				
$V_{a, b}$				
V_{tot}				
Street Corner Time-Space Analysis				
Total time-space, TS ($m^2 \cdot s$) $TS = C(W_a W_b - 0.215R^2)$				
Time spent by pedestrians crossing major street, Q_{ido} (p-s), $Q_{ido} = \frac{v_{do} R_{mi}^2}{2C}$				
Time spent by pedestrians crossing minor street, Q_{ico} (p-s), $Q_{ico} = \frac{v_{co} R_{mj}^2}{2C}$				
Total time-space available, TS_c ($m^2 \cdot s$), $TS_c = TS - [0.5(Q_{ido} + Q_{ico})]$				
Circulation area per pedestrian, M (m^2/p), $M = \frac{TS_c}{4V_{tot}}$				
LOS (Exhibit 18-3)				
Crosswalk Time-Space Analysis				
Average Pedestrian Delay at Signalized Intersections	Crosswalk D	Crosswalk C		
Average delay, d_p (s), $d_p = \frac{0.5(C - g)^2}{C}$				
LOS at signalized intersection (Exhibit 18-9)				
Number of pedestrians arriving during Don't Walk or red indication, ¹ N_{ped} (p)				
Average pedestrian walking speed, S_p (m/s)				
Total crossing time, ² t (s)				
Total time-space, TS ($m^2 \cdot s$), $TS = LW(WALK + FDW - \frac{L}{2S_p})$				
Total crosswalk occupancy time, T (p-s) $T = (v_i + v_o)t$				
Number of conflicting right-turning vehicles, N_{iv} (veh)				
Time-space of right-turning vehicles, TS_{iv} ($m^2 \cdot s$), $TS_{iv} = 12N_{iv}W_E$				
Effective time-space, TS_E ($m^2 \cdot s$), $TS_E = TS - TS_{iv}$				
Circulation area per pedestrian, M (m^2/p), $M = \frac{TS_E}{T}$				
LOS (Exhibit 18-3)				
Notes				
1. Number of people in the subject movement who arrive before the WALK or concurrent green indication and exit the curb during the WALK or concurrent green indication. $N_{ped} = \frac{v_{co} \text{ or } v_{do} (C - G)}{C}$				
2. If $W > 3.0$ m, $t = 3.2 + \frac{L}{S_p} + (0.81 \frac{N_{ped}}{W})$; but if $W \leq 3.0$ m, $t = 3.2 + \frac{L}{S_p} + (0.27N_{ped})$.				

CHAPTER 19

BICYCLES

CONTENTS

I. INTRODUCTION	19-1
Scope of the Methodology	19-1
Limitations of the Methodology	19-1
II. METHODOLOGY	19-1
Uninterrupted-Flow Bicycle Facilities	19-1
Exclusive Off-Street Bicycle Paths	19-2
Shared Off-Street Paths	19-3
On-Street Bicycle Lanes	19-4
Interrupted-Flow Bicycle Lanes	19-5
Signalized Intersections	19-5
Unsignalized Intersections	19-6
Urban Streets	19-7
III. APPLICATIONS	19-8
Computational Steps	19-8
Planning Applications	19-8
Analysis Tools	19-9
IV. EXAMPLE PROBLEMS	19-11
Example Problem 1	19-12
Example Problem 2	19-14
Example Problem 3	19-16
Example Problem 4	19-18
Example Problem 5	19-20
Example Problem 6	19-22
V. REFERENCES	19-24
APPENDIX A. WORKSHEET	19-24
Bicycle Worksheet	

EXHIBITS

Exhibit 19-1. LOS Criteria for Exclusive Bicycle Paths	19-3
Exhibit 19-2. LOS Criteria for Shared Off-Street Paths	19-4
Exhibit 19-3. Effect of Bicycle Mean and Standard Deviation of Speeds on Events for One-Way On-Street Bicycle Facilities	19-5
Exhibit 19-4. LOS for Bicycles at Signalized Intersections	19-6
Exhibit 19-5. LOS Criteria for Bicycle Lanes on Urban Streets	19-8
Exhibit 19-6. Bicycle Worksheet	19-9

I. INTRODUCTION

SCOPE OF THE METHODOLOGY

This chapter addresses the capacity and level-of-service (LOS) analysis of facilities serving bicycles. Specifically, procedures are provided for the following types of facilities:

- Exclusive off-street bicycle paths: paths physically separated from highway traffic for the exclusive use of bicycles;
- Shared off-street paths: paths physically separated from highway traffic for the use of bicycles, pedestrians, skateboards, roller skaters, in-line skaters, and other nonmotorized traffic;
- Bicycle lanes on streets: designated bicycle lanes on streets, usually directly adjacent to highway traffic lanes, operating under uninterrupted flow;
- Interrupted-flow bicycle facilities: designated bicycle lanes on streets, usually directly adjacent to highway traffic lanes, operating through fixed interruptions such as traffic signals and stop signs; and
- Bicycle lanes on urban streets: designated bicycle lanes on urban streets, incurring the impact of both uninterrupted-flow sections and fixed interruptions.

The material for this chapter resulted from FHWA-sponsored research (1). Note that quality of flow of bicycle traffic on each of these facilities is evaluated from a bicyclist's point of view. The discussion does not deal with the presence of wide outside roadway lanes, paved shoulders or bicycle lanes, volume of motorized vehicles, speed and presence of heavy vehicles, pavement condition, and other factors that bicyclists consider important quality-of-service measures. Research describes quality-of-service measures from a bicyclist's perspective (2). The procedures for assessing the impact of bicycles on vehicle capacity and LOS are incorporated into other chapters as appropriate by type of facility.

LIMITATIONS OF THE METHODOLOGY

The bicycle methodology does not account for bicycle paths or lane width reduction due to fixed objects adjacent to these facilities. No credible data were found on fixed objects and their effects on bicycles using these types of facilities. In addition, the methodology does not account for the effects of right-turning motor vehicles crossing bicycle lanes at intersections or midblock locations, and there is no consideration of grade. The methodology can be used for analysis of facilities with grades between -3 and +3 percent. The effects created by more extreme grades are unknown.

II. METHODOLOGY

This methodology provides the framework for bicycle facility evaluation. The analyst will be able to investigate the effects of pedestrians and traffic signals and the interaction between bicyclists on the LOS of a bicycle facility as measured in terms of meeting and passing events. A discussion of the concept of events is given in Chapter 11, "Pedestrian and Bicycle Concepts."

UNINTERRUPTED-FLOW BICYCLE FACILITIES

Uninterrupted-flow bicycle facilities include both exclusive and shared bicycle paths physically separated from vehicular roadways and without points of fixed interruption (except at terminal points).

These procedures should be used with the following cautions in mind:

For background and concepts, see Chapter 11

1. AASHTO recommends that the desirable width for separated bicycle paths be 3 m, with a minimum width of 2.4 m allowed under low-volume conditions (3). Only where field observations clearly indicate that bicyclists have formed and are using three lanes and greater than 2.4-m width should three-lane operation be assumed.
 2. European studies (2) report frequencies of events (meetings and passings) only for two-lane bicycle paths. These results have been extended to three-lane paths in this chapter using similar procedures.
 3. Procedures assume base conditions. Research is insufficient to identify the impact of such features as lateral obstructions, extended grades, and other local factors.
- For bicycle facilities, the flow rate during the most heavily traveled 15 min of the peak hour is used for analysis. LOS for other periods can, of course, be analyzed, but such analyses will not represent the critical periods of the day.

Exclusive Off-Street Bicycle Paths

Exclusive off-street bicycle paths are separated from motor vehicle traffic and do not allow pedestrians or users other than bicyclists. These facilities are often constructed to serve areas not served by city streets. They also provide recreational opportunities for the public. They accommodate the highest volumes of bicycles of the three uninterrupted-flow types of facility addressed in this manual and provide the best LOS, because bicycles are not forced to share the facility with other modes traveling at much higher or much lower speeds.

Research (4) has established Equations 19-1, 19-2, and 19-3 for predicting the number of events encountered by bicyclists on two-way exclusive off-street bicycle paths.

$$F_p = 0.188v_s \tag{19-1}$$

$$F_m = 2v_o \tag{19-2}$$

$$F = 0.5F_m + F_p \tag{19-3}$$

where

- F_p = number of passing events (with bicyclists in same direction) (events/h);
- F_m = number of opposing events (with bicyclists in opposing direction) (events/h);
- F = total number of events on path (events/h), with a weighting factor of 0.5 for meeting events;
- v_s = flow rate of bicycles in subject direction (bicycles/h); and
- v_o = flow rate of bicycles in opposing direction (bicycles/h).

These equations may also be applied to one-way bicycle facilities, with v_o set to zero, although such facilities are not common.

The equations for computing the number of events are based on an assumed normal distribution of bicycle speeds with a mean speed of 18 km/h and a standard deviation of 3 km/h. These equations can be used to determine the flow rate that can be accommodated for a designated LOS value of F and various directional distributions of bicycle flow. Equation 19-4 is used to compute bicycle flow rate.

$$v = \frac{F}{1 - 0.812p} \tag{19-4}$$

where

- v = total bicycle flow rate, both directions (bicycles/h), and
- p = proportion of total flow rate traveling in subject direction.

Exhibit 19-1 lists LOS criteria for exclusive off-street bicycle paths. The criteria were developed using the concepts of interference and events. Hindrance is the fraction of users over 1.0 km of a path experiencing interference due to passing and meeting

Refer to Chapter 11 for detailed description of hindrance

maneuvers. Events is defined as the number of times a bicycle is involved in passing and meeting maneuvers, which is strongly related to hindrance.

EXHIBIT 19-1. LOS CRITERIA FOR EXCLUSIVE BICYCLE PATHS

LOS	Frequency of Events, 2-Way, 2-Lane Paths ^a (events/h)	Frequency of Events, 2-Way, 3-Lane Paths ^b (events/h)
A	≤ 40	≤ 90
B	> 40–60	> 90–140
C	> 60–100	> 140–210
D	> 100–150	> 210–300
E	> 150–195	> 300–375
F	> 195	> 375

Notes:

a. 2.4-m-wide paths. Also used for on-street bicycle lanes.

b. 3.0-m-wide paths.

Note that by these criteria, the LOS afforded bicyclists in each direction is different unless the directional split is 50:50. Note also that three-lane bicycle paths will result in significantly higher service flow rates for any given LOS because many events on a three-lane bicycle path can occur without infringement on the lane of travel—that is, without hindrance of the bicyclist.

Shared Off-Street Paths

Shared off-street paths, like exclusive bicycle paths, are separated from motor vehicle traffic. However, shared-use paths are open to other nonmotorized modes, including pedestrians, skateboarders, wheelchairs, roller skaters, in-line skaters, and others. Shared-use paths are often constructed for the same reasons as exclusive paths. They serve areas without city streets and provide recreational opportunities for the public. Such paths are common on university campuses, where motor vehicle traffic and parking often are heavily restricted. In the United States, there are few paths limited exclusively to bicycles; therefore, most off-street paths in this country fall into this category.

On shared facilities, the presence of pedestrians can be detrimental to bicycle capacity and LOS because pedestrians move at markedly lower speeds. However, it is very difficult to establish a pedestrian-bicycle equivalent because the relationship between the two differs depending on their respective flows, directional splits, and other factors.

As mentioned earlier, bicycle LOS is based on a hindrance concept and its surrogate measure, events. Equations for the prediction of total events have been developed (4) on the basis of an assumption that bicycle speeds are normally distributed with a mean of 18 km/h and that pedestrian speeds are similarly distributed with a mean of 4.5 km/h.

Equations 19-5, 19-6, and 19-7 are used to predict total events for shared bicycle and pedestrian situations.

$$F_p = 3v_{ps} + 0.188v_{bs} \tag{19-5}$$

$$F_m = 5v_{po} + 2v_{bo} \tag{19-6}$$

$$F = 0.5F_m + F_p \tag{19-7}$$

where

F , F_p , F_m are as previously defined,

v_{ps} = flow rate of pedestrians in subject direction (p/h),

v_{bs} = flow rate of bicycles in subject direction (bicycles/h),

v_{po} = flow rate of pedestrians in opposing direction (p/h), and

v_{bo} = flow rate of bicycles in opposing direction (bicycles/h).

The uninterrupted-flow bicycle facility analysis is based on the concept of hindrance

If the directional split of both bicycles and pedestrians is assumed to be the same, p may be taken as the proportion of both in the subject direction. If v_p is the total two-way pedestrian traffic and v_b is the total two-way bicycle traffic, the number of total events (p) may be computed by Equation 19-8.

$$F = v_p (2.5 + 0.5p) + v_b (1 - 0.812p) \tag{19-8}$$

Exhibit 19-2 lists LOS criteria in terms of events for shared off-street paths.

EXHIBIT 19-2. LOS CRITERIA FOR SHARED OFF-STREET PATHS

LOS	Frequency of Events, 2-Way, 2-Lane Paths ^a (events/h)	Frequency of Events, 2-Way, 3-Lane Paths ^b (events/h)
A	≤ 40	≤ 90
B	> 40–60	> 90–140
C	> 60–100	> 140–210
D	> 100–150	> 210–300
E	> 150–195	> 300–375
F	> 195	> 375

Notes:
 a. 2.4-m-wide paths.
 b. 3.0-m-wide paths.

On-Street Bicycle Lanes

Designated bicycle lanes are lanes on a street that are assigned exclusively for the use of bicycles. These lanes are separated from motor vehicle traffic by pavement markings. Bicycle lanes are normally placed on streets where bicycle use is moderate to high and the separation of bicycles from motor vehicle traffic may be warranted. Bicycle lanes are generally used for flow in one direction only, with a lane provided on each side of the street.

Where paved shoulders are part of the cross section and not part of the designated traveled way for vehicles, bicycles may make use of the shoulder in much the same way as they do a designated bicycle lane. In such cases, bicycle traffic is separated from motor vehicle traffic by a right-edge marking. Although such shoulders may also be shared with pedestrians, they typically are only occasionally used by pedestrians. For this reason, designated bicycle lanes and paved shoulders used by bicyclists will be treated in a similar manner by the methodology of this chapter.

The widths of on-street bicycle facilities vary widely in the United States, ranging from a 1.2-m designated bicycle lane to a 3.0-m paved shoulder. However, because bicycles can borrow space from the adjacent lane when motor vehicle flow is light to moderate, there are few facilities that operate with fewer than two effective bicycle lanes.

It is expected that on-street bicycle lanes and paved shoulders with widths up to 1.8 m will operate as two effective lanes. However, heavy motor vehicle volumes, high speeds, roadway debris, or other local conditions may affect the actual width available to the bicyclists. An observation of facility operation before analysis is recommended to determine the actual number of effective lanes.

One important distinction between on-street facilities and exclusive off-street facilities is the existence of a multitude of factors affecting the LOS for on-street facilities, including adjacent motor vehicle traffic (which is often moving much faster than the bicycles), heavy-vehicle traffic, commercial and residential driveways, and adjacent on-street parking. These factors, in addition to lateral obstructions and extended sections with appreciable grades, may reduce the quality of service for a bicycle lane (2).

One possible approach to determining LOS for on-street bicycle facilities is to quantify the impact of prevailing geometric and traffic conditions on the average and standard deviation of bicycle speeds on the facility. Under this framework, the expectation is that friction with vehicular traffic, parked vehicles, and driveway density

Few on-street facilities operate with fewer than two lanes

would result in a lower mean speed and higher standard deviation than on a comparable off-street path. To illustrate this effect, Exhibit 19-3 lists the number of events for a range of bicycle flow rates and standard deviations of bicycle speeds. As indicated in Exhibit 19-3, the number of events increases as speed decreases and standard deviation increases. The standard deviation of speeds describes the variation in speeds about the average or mean bicycle speed. The standard deviation will be relatively smaller for facilities used primarily by commuters and relatively larger for recreational facilities. Using the number of events from Exhibit 19-3, the analyst can find LOS from Exhibit 19-1. If speed parameters are not available, use a mean bicycle speed of 18 km/h and a standard deviation as described in the footnote of Exhibit 19-3.

EXHIBIT 19-3. EFFECT OF BICYCLE MEAN AND STANDARD DEVIATION OF SPEEDS ON EVENTS FOR ONE-WAY ON-STREET BICYCLE FACILITIES

Bicycle Flow Rate (bicycles/h)	Standard Deviation ^a (km/h)	Number of Events = $\frac{2 * \text{Bicycle Flow Rate} * \text{Standard Deviation}}{\text{Mean Bicycle Speed} * \sqrt{\pi}}$								
		Bicycle Mean Speed (km/h)								
		12	13	14	15	16	17	18	19	20
100	1.5	14	13	12	11	11	10	9	9	8
	3.0	28	26	24	23	21	20	19	18	17
	4.5	42	39	36	34	32	30	28	27	25
200	1.5	28	26	24	23	21	20	19	18	17
	3.0	56	52	48	45	42	40	38	36	34
	4.5	85	78	73	68	63	60	56	53	51
300	1.5	42	39	36	34	32	30	28	27	25
	3.0	85	78	73	68	63	60	56	53	51
	4.5	127	117	109	102	95	90	85	80	76

Notes:

- a. Standard deviation of bicycle speeds. If standard deviation data are unavailable, use the following default values:
 - 1.5 km/h for facilities used primarily by commuters
 - 3.0 km/h for facilities used by various user types
 - 4.5 km/h for facilities used primarily for recreational purposes.

INTERRUPTED-FLOW BICYCLE LANES

Interrupted-flow bicycle facilities are on-street bicycle lanes that must pass through intersections (signalized and unsignalized). The procedures of this chapter focus on the LOS provided to bicyclists. To assess the impact of bicycles on motor vehicle traffic, methodologies in other chapters of this manual should be used.

Signalized Intersections

A signalized intersection covered by these procedures is one in which there is a designated on-street bicycle lane on at least one approach. The typical width of an on-street bicycle lane ranges between 1.2 m and 1.8 m. A wide range of capacities and saturation flow rates have been reported by many countries for these types of facilities. The base saturation flow rate may be as high as 2,600 bicycles/h on the basis of research observations (5). However, few intersections provide base conditions for bicyclists, and current information is insufficient to calibrate a series of appropriate adjustment factors. Until such factors are developed, it is recommended that a saturation flow rate of 2,000 bicycles/h be used as an average value achievable at most intersections. A saturation flow rate of 2,000 bicycles/h assumes that right-turning motor vehicles yield the right-of-way to through bicyclists. Where aggressive right-turning traffic exists, 2,000 bicycles/h may not be achievable. Local observations to determine a saturation flow rate are recommended in such cases. Using this default value for saturation flow rate, the

Effective green time is defined in Chapter 16

Interaction with right-turning vehicles is not accounted for in the methodology

capacity of the bicycle lane at a signalized intersection may be computed using Equation 19-9.

$$c_b = s_b \frac{g}{C} = 2000 \frac{g}{C} \tag{19-9}$$

where

- c_b = capacity of bicycle lane (bicycles/h),
- s_b = saturation flow rate of bicycle lane (bicycles/h),
- g = effective green time for bicycle lane (s), and
- C = signal cycle length (s).

Control delay is estimated using the first term of the delay equation for signalized intersections, the uniform delay term, which assumes that there is no overflow delay. Bicyclists will normally not tolerate an overflow situation and will select other routes or ignore traffic regulations to avoid the excessive delay that would occur in such situations. Control delay is estimated by using Equation 19-10.

$$d_b = \frac{0.5C \left(1 - \frac{g}{C}\right)^2}{1 - \left[\frac{g}{C} \min\left(\frac{v_b}{c_b}, 1.0\right) \right]} \tag{19-10}$$

where

- d_b = control delay (s/bicycle), and
- v_b = flow rate of bicycles in one-direction bicycle lane (bicycles/h).

Exhibit 19-4 gives LOS criteria for bicycles at signalized intersections, on the basis of control delay. At most signalized intersections, the only delay to through bicycles is caused by the signal itself because bicycles have the right-of-way over right-turning vehicles during the green phase. Where bicycles are forced to weave with right-turning traffic or where the bicycle right-of-way is disrupted because of high right-turning flows, additional delay could occur.

EXHIBIT 19-4. LOS FOR BICYCLES AT SIGNALIZED INTERSECTIONS

LOS	Control Delay (s/bicycle)
A	< 10
B	≥ 10–20
C	> 20–30
D	> 30–40
E	> 40–60
F	> 60

Unsignalized Intersections

An unsignalized intersection covered by these procedures is one in which there is a designated on-street bicycle lane on at least one of the minor approaches, controlled by a stop sign. Bicycles on the major street at an unsignalized location are not delayed at most intersections because they have the right-of-way over turning vehicles. Where bicycles are forced to weave against right-turning vehicles, additional delay may be incurred.

It is also assumed that bicycles on a minor approach turning right from one designated bicycle lane to another are not delayed because they do not have to wait for gaps in motor vehicle traffic. Experienced bicyclists making left turns from either the minor or major approach often leave the bicycle lane and queue with motor vehicles.

Critical gap distributions have been identified in the research (5,6) for bicycles crossing two-lane major streets. The methodology in this manual for motor vehicles at unsignalized intersections (see Chapter 17) is also applicable to bicycles. Thus, once critical gaps and follow-up times are determined for bicycles, the control delay for bicycles is computed using the delay equation from Chapter 17.

One caution is necessary. Bicycles differ from motor vehicles in that they normally do not queue linearly at a stop sign. As a result, multiple bicycles often use the same gap in the vehicular traffic stream. This fact will probably affect the determination of bicycle follow-up time. This phenomenon and others described in this section have not been researched and thus are not explicitly included in the methodology.

Once an average control delay is estimated, the LOS criteria of Exhibit 19-3 are applied directly. No procedures are specified for bicycles at all-way stop-controlled intersections.

Urban Streets

This section focuses on operational analysis of extended designated on-street bicycle lanes on urban streets with both uninterrupted- and interrupted-flow elements. Average bicycle travel speed, including stops, is used as the measure of effectiveness for such cases. The average travel speed is based on the distance between two points and the average amount of time required to traverse that distance, including stops.

For these procedures, bicycle facilities on urban streets are found along streets made up of both segments and intersections with designated bicycle lanes. The first step in analyzing the urban street is to define its limits. Once the limits are defined, the street is segmented for analysis. Each segment consists of a signalized intersection and an upstream segment of bicycle facility, beginning immediately after the nearest upstream signal. The average travel speed over the entire section is computed by Equation 19-11.

$$S_{ats} = \frac{L_T}{\left(\sum \frac{L_i}{S_i} + \frac{\sum d_j}{3600} \right)} \quad (19-11)$$

where

- S_{ats} = bicycle travel speed (km/h),
- L_T = total length of urban street under analysis (km),
- L_i = length of segment i (km),
- S_i = bicycle running speed over segment i (km/h), and
- d_j = average bicycle delay at intersection j (s).

For the purposes of analyzing bicycle flows, it is recommended that the average running speed of bicycles on arterials (between signalized intersections) be taken as 25 km/h. It is recognized that there are many factors that might affect bicycle speed, including adjacent motor vehicle traffic, adjacent on-street parking activity, commercial and residential driveways, lateral obstructions, and significant grades. To date, research has been insufficient to make any specific recommendations as to their individual and collective effects. Intersection delays are computed as described in previous sections of this chapter.

LOS criteria based on average travel speed of bicycles are listed in Exhibit 19-5. The criteria are generally based on arterial LOS criteria for motor vehicles, with thresholds set at similar percentages of base speed.

The critical gap approach is applied to bicycles at unsignalized intersections

EXHIBIT 19-5. LOS CRITERIA FOR BICYCLE LANES ON URBAN STREETS

LOS	Bicycle Travel Speed (km/h)
A	> 22
B	> 15–22
C	> 11–15
D	> 8–11
E	≥ 7–8
F	< 7

Guidelines on required inputs and estimated values are in Chapter 11

III. APPLICATIONS

The methodology in this chapter is for analyzing the capacity and LOS of bicycle facilities. The analyst must address two fundamental questions. First, the primary output must be identified. Primary outputs include LOS and achievable bicycle flow rate (v_b).

Second, the analyst must identify the default values or estimated values for use in the analysis. The analyst has three sources of input data: (a) default values found in this manual; (b) estimates or locally derived default values or both; and (c) values derived from field measurements and observation. For each of the input variables, a value must be supplied to calculate the outputs, both primary and secondary.

A common application of the method is to compute the LOS of an existing facility or of a changed facility in the near term or distant future. This type of application is termed operational, and its primary output is LOS. Alternatively, the achievable bicycle flow rate, v_b , can be solved for as the primary output. This analysis requires that an LOS goal be established, and it is typically used to estimate when a specified bicycle flow rate will be exceeded.

Another general type of analysis can be defined by the term planning. This type uses estimates, HCM default values, and local default values as inputs in the calculation. As outputs, LOS or bicycle flow rate can be determined. The difference between planning analysis and operational or design analysis is that most or all of the input values in planning come from estimates or default values, whereas operational and design analyses tend to utilize field measurements or known values for most or all of the input variables.

COMPUTATIONAL STEPS

The bicycle worksheet for computations is shown in Exhibit 19-6. For all applications, the analyst provides general information and site information.

For operational (LOS) analysis, all flow data are entered as input. Depending on the type of bicycle facility, different performance measures are computed, and LOS is determined.

The objective of design (v_b) analysis is to estimate the bicycle flow rate in bicycles per hour given a desired LOS. For exclusive off-street bicycle paths and shared off-street bicycle paths, a maximum number of events per hour allowed for the desired LOS is determined. Then by solving the events equation backwards, bicycle and pedestrian flow rates are computed. For interrupted-flow bicycle lanes, the key variable is the maximum allowed control delay to achieve the desired LOS. By back-solving the delay equation, X_b is determined. From X_b , bicycle flow rate is computed.

PLANNING APPLICATIONS

The two planning applications, planning for LOS and v_b , correspond directly to procedures described for operations and design. The primary criterion that categorizes these as planning applications is the use of estimates, HCM default values, and local default values. Chapter 11 contains more on the use of default values.

Operational (LOS)

Design (v_b)

Planning (LOS)

Planning (v_b)

ANALYSIS TOOLS

The worksheet shown in Exhibit 19-6 and provided in Appendix A can be used to perform all applications of the methodology.

EXHIBIT 19-6. BICYCLE WORKSHEET

BICYCLE WORKSHEET									
General Information					Site Information				
Analyst _____					Path or Bicycle Lane _____				
Agency or Company _____					Jurisdiction _____				
Date Performed _____					Analysis Year _____				
Analysis Time Period _____									
<input type="checkbox"/> Operational (LOS)			<input type="checkbox"/> Design (v_b)		<input type="checkbox"/> Planning (LOS)			<input type="checkbox"/> Planning (v_b)	
Input					Planning Input				
Bicycle path and lane width <input type="checkbox"/> 2.4 m					<input type="checkbox"/> 3.0 m <input type="checkbox"/> Other _____ m				
Bicycle peak-hour volume, V_b _____ bicycles/h					Average annual daily traffic, AADT = _____ bicycles/day				
Pedestrian peak-hour volume, V_p _____ p/h					Proportion of AADT during peak-hour, K = _____				
Bicycle peak-hour factor, PHF _____					Design hour volume, DHV = _____ bicycles/h				
Pedestrian peak-hour factor, PHF _____									
Bicycle directional split, P _____ / _____ (EB or NB/WB or SB)									
Pedestrian directional split, P _____ / _____ (EB or NB/WB or SB)									
Directional Flow Rate									
					EB or NB		WB or SB		
Peak 15-min bicycle flow rate, v_b (bicycles/h) $v_b = (V_b/PHF) \times P$									
Peak 15-min pedestrian flow rate, v_p (p/h) $v_p = (V_p/PHF) \times P$									
Exclusive Off-Street Path and On-Street Lane (One-Way)									
					EB or NB		WB or SB		
$F_p = 0.188v_b$ (Equation 19-1)									
$F_m = 2v_o$ (Equation 19-2)									
$F = 0.5F_m + F_p$ (Equation 19-3 or Exhibit 19-3)									
LOS (Exhibit 19-1 or 19-3)									
Shared Off-Street Paths									
					EB or NB		WB or SB		
$F_p = 3v_{ps} + 0.188v_{ps}$ (Equation 19-5)									
$F_m = 5v_{po} + 2v_{bo}$ (Equation 19-6)									
$F = 0.5F_m + F_p$ (events/h) (Equation 19-7)									
LOS (Exhibit 19-2)									
Bicycle Lane at Signalized Intersections and Urban Streets (One-Way)									
Intersection		1	2	3	4	5	6	7	8
Bicycle flow rate, v_b (bicycles/h)									
Capacity, c_b (bicycles/h) $c_b = 2000(g/C)$ (Equation 19-9)									
v_b/c_b Ratio, X_b									
Cycle length, C (s)									
g/C Ratio									
Delay, d_b (Equation 19-10) $d_b = \frac{0.5C(1 - g/C)^2}{1 - [(g/C)\min(\frac{v_b}{c_b}, 1.0)]}$									
LOS for lanes at signals (Exhibit 19-4)									
Length of link, L (km)									
Average travel speed, S_{ats} (km/h) (Equation 19-11) $S_{ats} = \left(\frac{\sum L_i}{\sum S_i + \frac{\sum d_i}{3600}} \right)$									
LOS urban street bicycle facility (Exhibit 19-5)									

IV. EXAMPLE PROBLEMS

Problem No.	Description	Application
1	Find LOS of an exclusive off-street bicycle facility	Operational (LOS)
2	Find LOS of a shared off-street bicycle lane	Operational (LOS)
3	Find LOS of an interrupted-flow bicycle lane at a signalized intersection	Operational (LOS)
4	Find LOS of a bicycle lane on an urban street with three signalized intersections	Operational (LOS)
5	Find LOS of an on-street lane with heavy side friction	Operational (LOS)
6	Find LOS of a shared off-street bicycle facility. If the procedure fails, assess separate pedestrian paths and bicycle paths.	Operational (LOS)

EXAMPLE PROBLEM 1

The Bicycle Facility A north-south uninterrupted-flow two-lane (2.4 m wide) exclusive bicycle path carrying two-way bicycle traffic.

The Question What is the LOS of this facility during the peak hour?

The Facts

- √ Two effective lanes,
- √ PHF = 0.60,
- √ Peak- hour volume = 90 bicycles/h, and
- √ Directional Split = 70/30 (NB/SB).

Outline of Solution All input parameters are known. The peak-hour volume is converted to a flow rate for the 15 min with the highest demand. Number of events in each direction and LOS are then computed.

Steps

1. Find directional flows.	$v_b = \frac{V_b}{PHF} \times P$ $v_b = \frac{90}{0.60} \times 0.7 = 105 \text{ bicycles/h (NB)}$ $v_b = \frac{90}{0.60} \times 0.3 = 45 \text{ bicycles/h (SB)}$
2. Find F_p (use Equation 19-1).	$F_p = 0.188v_s$ $F_p = 0.188(105) = 20 \text{ events/h (NB)}$ $F_p = 0.188(45) = 9 \text{ events/h (SB)}$
3. Find F_m (use Equation 19-2).	$F_m = 2v_o$ $F_m = 2(45) = 90 \text{ events/h (NB)}$ $F_m = 2(105) = 210 \text{ events/h (SB)}$
4. Find F (use Equation 19-3).	$F = 0.5F_m + F_p$ $F = 0.5(90) + 20 = 65 \text{ events/h (NB)}$ $F = 0.5(210) + 9 = 114 \text{ events/h (SB)}$
5. Determine LOS (use Exhibit 19-1).	LOS C (NB) LOS D (SB)

Results The northbound direction operates at LOS C, whereas the southbound direction operates at LOS D.

Example Problem 1

BICYCLE WORKSHEET									
General Information					Site Information				
Analyst <u>JMYE</u>					Path or Bicycle Lane <u>North-South</u>				
Agency or Company <u>CEI</u>					Jurisdiction _____				
Date Performed <u>5/19/99</u>					Analysis Year <u>1999</u>				
Analysis Time Period <u>Peak</u>									
<input checked="" type="checkbox"/> Operational (LOS)			<input type="checkbox"/> Design (v_b)		<input type="checkbox"/> Planning (LOS)			<input type="checkbox"/> Planning (v_b)	
Input					Planning Input				
Bicycle path and lane width <input checked="" type="checkbox"/> 2.4 m					<input type="checkbox"/> 3.0 m		<input type="checkbox"/> Other _____ m		
Bicycle peak-hour volume, V_b <u>90</u> bicycles/h					Average annual daily traffic, AADT = _____ bicycles/day				
Pedestrian peak-hour volume, V_p _____ p/h					Proportion of AADT during peak-hour, K = _____				
Bicycle peak-hour factor, PHF <u>0.60</u>					Design hour volume, DHV = _____ bicycles/h				
Pedestrian peak-hour factor, PHF _____									
Bicycle directional split, P <u>70 / 30</u> (EB or NB/WB or SB)									
Pedestrian directional split, P _____ / _____ (EB or NB/WB or SB)									
Directional Flow Rate									
					EB or (NB)		WB or (SB)		
Peak 15-min bicycle flow rate, v_b (bicycles/h) $v_b = (V_b/PHF) \times P$					<u>(90/0.60) \times .7 = 105</u>		<u>(90/0.60) \times .3 = 45</u>		
Peak 15-min pedestrian flow rate, v_p (p/h) $v_p = (V_p/PHF) \times P$									
Exclusive Off-Street Path and On-Street Lane (One-Way)									
					EB or (NB)		WB or (SB)		
$F_p = 0.188v_b$ (Equation 19-1)					<u>20</u>		<u>9</u>		
$F_m = 2v_o$ (Equation 19-2)					<u>90</u>		<u>210</u>		
$F = 0.5F_m + F_p$ (Equation 19-3 or Exhibit 19-3)					<u>65</u>		<u>114</u>		
LOS (Exhibit 19-1 or 19-3)					<u>C</u>		<u>D</u>		
Shared Off-Street Paths									
					EB or NB		WB or SB		
$F_p = 3v_{ps} + 0.188v_{bs}$ (Equation 19-5)									
$F_m = 5v_{po} + 2v_{bo}$ (Equation 19-6)									
$F = 0.5F_m + F_p$ (Equation 19-7)									
LOS (Exhibit 19-2)									
Bicycle Lane at Signalized Intersections and Urban Streets (One-Way)									
Intersection									
	1	2	3	4	5	6	7	8	
Bicycle flow rate, v_b (bicycles/h)									
Capacity, c_b (bicycles/h) $c_b = 2000(g/C)$ (Equation 19-9)									
v_b/c_b Ratio, X_b									
Cycle length, C (s)									
g/C Ratio									
Delay, d_b (Equation 19-10) $d_b = \frac{0.5C(1 - g/C)^2}{1 - [(g/C)\min(\frac{X_b}{c_b}, 1.0)]}$									
LOS for lanes at signals (Exhibit 19-4)									
Length of link, L (km)									
Average travel speed, S_{ats} (km/h) (Equation 19-11) $S_{ats} = \frac{L}{\sum \frac{L_i}{S_i} + \frac{\sum d_i}{3600}}$									
LOS urban street bicycle facility (Exhibit 19-5)									

EXAMPLE PROBLEM 2

The Bicycle Facility An east-west uninterrupted-flow shared path (3.0 m wide) carrying two-way pedestrian and bicycle traffic.

The Question What is the LOS of this facility for bicyclists in the peak hour?

The Facts

- √ Three effective lanes (3 m wide),
- √ Peak flow rate of bicycles = 150 bicycles/h,
- √ Peak flow rate of pedestrians = 80 p/h,
- √ Directional split of bicycles = 60/40 (EB/WB), and
- √ Directional split of pedestrians = 50/50 (EB/WB).

Outline of Solution All input parameters are known. Number of events in each direction and LOS for bicycles are computed. Note that the peak flow rates are given rather than hourly volumes. Because the directional splits for bicycles and pedestrians are not the same, Equations 19-5, 19-6, and 19-7 are used.

Steps

1. Find directional flows.	$EB\ bicycles = 0.6(150) = 90\ bicycles/h$ $WB\ bicycles = 0.4(150) = 60\ bicycles/h$ $EB\ peds = 0.5(80) = 40\ p/h$ $WB\ peds = 0.5(80) = 40\ p/h$
2. Find F_p (use Equation 19-5).	$F_p = 3v_{ps} + 0.188v_{bs}$ $F_p = 3(40) + 0.188(90) = 137\ events/h\ (EB)$ $F_p = 3(40) + 0.188(60) = 131\ events/h\ (WB)$
3. Find F_m (use Equation 19-6).	$F_m = 5v_{po} + 2v_{bo}$ $F_m = 5(40) + 2(60) = 320\ events/h\ (EB)$ $F_m = 5(40) + 2(90) = 380\ events/h\ (WB)$
4. Find F (use Equation 19-7).	$F = 0.5F_m + F_p$ $F = 0.5(320) + 137 = 297\ events/h\ (EB)$ $F = 0.5(380) + 131 = 321\ events/h\ (WB)$
5. Determine LOS (use Exhibit 19-2).	LOS D (EB) LOS E (WB)

Results The shared facility operates at LOS D for the eastbound direction and LOS E for the westbound direction.

Example Problem 2

BICYCLE WORKSHEET									
General Information					Site Information				
Analyst <u>JMYE</u>					Path or Bicycle Lane <u>East-West</u>				
Agency or Company <u>CEI</u>					Jurisdiction _____				
Date Performed <u>5/12/99</u>					Analysis Year <u>1999</u>				
Analysis Time Period <u>Peak</u>									
<input checked="" type="checkbox"/> Operational (LOS)			<input type="checkbox"/> Design (v_b)		<input type="checkbox"/> Planning (LOS)			<input type="checkbox"/> Planning (v_b)	
Input					Planning Input				
Bicycle path and lane width <input type="checkbox"/> 2.4 m					<input checked="" type="checkbox"/> 3.0 m				
Bicycle peak-hour volume, V_b _____ bicycles/h					Average annual daily traffic, AADT = _____ bicycles/day				
Pedestrian peak-hour volume, V_p _____ p/h					Proportion of AADT during peak-hour, K = _____				
Bicycle peak-hour factor, PHF <u>1.0</u>					Design hour volume, DHV = _____ bicycles/h				
Pedestrian peak-hour factor, PHF _____									
Bicycle directional split, P <u>60 / 40</u> (EB or NB/WB or SB)									
Pedestrian directional split, P <u>50 / 50</u> (EB or NB/WB or SB)									
Directional Flow Rate									
					(EB) or NB			(WB) or SB	
Peak 15-min bicycle flow rate, v_b (bicycles/h) $v_b = (V_b/PHF) \times P$					<u>150</u> \times <u>0.6</u> = <u>90</u>			<u>150</u> \times <u>0.4</u> = <u>60</u>	
Peak 15-min pedestrian flow rate, v_p (p/h) $v_p = (V_p/PHF) \times P$					<u>80</u> \times <u>0.5</u> = <u>40</u>			<u>80</u> \times <u>0.5</u> = <u>40</u>	
Exclusive Off-Street Path and On-Street Lane (One-Way)									
					EB or NB			WB or SB	
$F_p = 0.188v_s$ (Equation 19-1)									
$F_m = 2v_o$ (Equation 19-2)									
$F = 0.5F_m + F_p$ (Equation 19-3 or Exhibit 19-3)									
LOS (Exhibit 19-1 or 19-3)									
Shared Off-Street Paths									
					(EB) or NB			(WB) or SB	
$F_p = 3v_{ps} + 0.188v_{bs}$ (Equation 19-5)					<u>137</u>			<u>131</u>	
$F_m = 5v_{po} + 2v_{bo}$ (Equation 19-6)					<u>320</u>			<u>380</u>	
$F = 0.5F_m + F_p$ (events/h) (Equation 19-7)					<u>297</u>			<u>321</u>	
LOS (Exhibit 19-2)					<u>D</u>			<u>E</u>	
Bicycle Lane at Signalized Intersections and Urban Streets (One-Way)									
Intersection	1	2	3	4	5	6	7	8	
Bicycle flow rate, v_b (bicycles/h)									
Capacity, c_b (bicycles/h) $c_b = 2000(g/C)$ (Equation 19-9)									
v_b/c_b Ratio, X_b									
Cycle length, C (s)									
g/C Ratio									
Delay, d_b (Equation 19-10) $d_b = \frac{0.5C(1-g/C)^2}{1 - [(g/C)\min(\frac{v_b}{c_b}, 1.0)]}$									
LOS for lanes at signals (Exhibit 19-4)									
Length of link, L (km)									
Average travel speed, S_{ats} (km/h) (Equation 19-11) $S_{ats} = \left(\frac{\sum L_i}{\sum S_i + \frac{\sum d_i}{3600}} \right)$									
LOS urban street bicycle facility (Exhibit 19-5)									

EXAMPLE PROBLEM 3

The Bicycle Facility A 1.2-m-wide bicycle lane at a signalized intersection.

The Question What is the LOS of this bicycle lane?

The Facts

- √ Effective green time = 48 s,
- √ Cycle length = 120 s, and
- √ Peak bicycle flow rate = 120 bicycles/h.

Outline of Solution All input parameters are known. Capacity and control delay of the bicycle lane will be computed. Then, using control delay, LOS is determined.

Steps

1. Find g/C and c_b (use Equation 19-9).	$\frac{g}{C} = \frac{48}{120} = 0.40$ $c_b = 2000(g/C) = 800 \text{ bicycles/h}$
2. Find d (use Equation 19-10).	$d = \frac{0.5C(1-g/C)^2}{1-g/C \min\left(\frac{v_b}{c_b}, 1.0\right)}$ $d = \frac{0.5(120)(1-0.40)^2}{1-\left(0.40 * \frac{120}{800}\right)} = 23.0 \text{ s/bicycle}$
3. Determine LOS (use Exhibit 19-4).	LOS C

Results The bicycle facility at the signalized intersection operates at LOS C.

Example Problem 3

BICYCLE WORKSHEET									
General Information					Site Information				
Analyst <u>JMYE</u>					Path or Bicycle Lane <u>North-South</u>				
Agency or Company <u>CEI</u>					Jurisdiction _____				
Date Performed <u>5/19/99</u>					Analysis Year <u>1999</u>				
Analysis Time Period <u>Peak</u>									
<input checked="" type="checkbox"/> Operational (LOS)		<input type="checkbox"/> Design (v_b)		<input type="checkbox"/> Planning (LOS)		<input type="checkbox"/> Planning (v_b)			
Input					Planning Input				
Bicycle path and lane width <input type="checkbox"/> 2.4 m		<input type="checkbox"/> 3.0 m		<input checked="" type="checkbox"/> Other <u>1.2</u> m					
Bicycle peak-hour volume, V_b _____ bicycles/h					Average annual daily traffic, AADT = _____ bicycles/day				
Pedestrian peak-hour volume, V_p _____ p/h					Proportion of AADT during peak-hour, K = _____				
Bicycle peak-hour factor, PHF _____					Design hour volume, DHV = _____ bicycles/h				
Pedestrian peak-hour factor, PHF _____									
Bicycle directional split, P _____ / _____ (EB or NB/WB or SB)									
Pedestrian directional split, P _____ / _____ (EB or NB/WB or SB)									
Directional Flow Rate									
					EB or NB		WB or SB		
Peak 15-min bicycle flow rate, v_b (bicycles/h) $v_b = (V_b/PHF) \times P$					$v_b = 120$ bicycles/h				
Peak 15-min pedestrian flow rate, v_p (p/h) $v_p = (V_p/PHF) \times P$									
Exclusive Off-Street Path and On-Street Lane (One-Way)									
					EB or NB		WB or SB		
$F_p = 0.188v_b$ (Equation 19-1)									
$F_m = 2v_o$ (Equation 19-2)									
$F = 0.5F_m + F_p$ (Equation 19-3 or Exhibit 19-3)									
LOS (Exhibit 19-1 or 19-3)									
Shared Off-Street Paths									
					EB or NB		WB or SB		
$F_p = 3v_{ps} + 0.188v_{bs}$ (Equation 19-5)									
$F_m = 5v_{po} + 2v_{bo}$ (Equation 19-6)									
$F = 0.5F_m + F_p$ (events/h) (Equation 19-7)									
LOS (Exhibit 19-2)									
Bicycle Lane at Signalized Intersections and Urban Streets (One-Way)									
	Intersection	1	2	3	4	5	6	7	8
Bicycle flow rate, v_b (bicycles/h)		120							
Capacity, c_b (bicycles/h) $c_b = 2000(g/C)$ (Equation 19-9)		800							
v_b/c_b Ratio, X_b		0.15							
Cycle length, C (s)		120							
g/C Ratio		0.40							
Delay, d_b (Equation 19-10) $d_b = \frac{0.5C(1 - g/C)^2}{1 - [(g/C)\min(\frac{v_b}{c_b}, 1.0)]}$		23.0							
LOS for lanes at signals (Exhibit 19-4)		C							
Length of link, L (km)									
Average travel speed, S_{ats} (km/h) (Equation 19-11) $S_{ats} = \left(\frac{L_i + \sum d_i}{\sum \frac{L_i}{S_i} + \frac{\sum d_i}{3600}} \right)$									
LOS urban street bicycle facility (Exhibit 19-5)									

EXAMPLE PROBLEM 4

The Bicycle Facility A 2.0-km bicycle lane on an urban street with three signalized intersections and four segments (links).

The Question What is the eastbound peak-hour LOS of this bicycle facility?

The Facts

- √ Cycle length = 100.0 s (for all intersections),
- √ $g/C = 0.30$ (Intersection 1),
- √ $g/C = 0.50$ (Intersection 2),
- √ $g/C = 0.40$ (Intersection 3),
- √ Peak flow rate = 250 bicycles/h,
- √ $L_1 = 0.5$ km, $L_2 = 0.2$ km, $L_3 = 1.0$ km, $L_4 = 0.3$ km, and
- √ One-way, 1.2-m-wide bicycle lane.

Outline of Solution All inputs are known. Capacity and v/c ratio of the bicycle lane are computed for all intersections. Delay at the three intersections and average travel speed of bicycles are then computed to determine LOS.

Steps

1. Find c (use Equation 19-9).	$c = 2000(g/C)$ $c_1 = 2000(0.30) = 600$ bicycles/h $c_2 = 2000(0.50) = 1000$ bicycles/h $c_3 = 2000(0.40) = 800$ bicycles/h
2. Find v/c .	$(v/c)_1 = \frac{250}{600} = 0.42$ $(v/c)_2 = \frac{250}{1000} = 0.25$ $(v/c)_3 = \frac{250}{800} = 0.31$
3. Find d (use Equation 19-10).	$d = \frac{0.5C(1-g/C)^2}{1-g/C \min\left(\frac{v_b}{c_b}, 1.0\right)}$ $d_1 = \frac{0.5(100.0)(1-0.30)^2}{1-(0.30)(0.42)} = 28.0$ s/bicycle, LOS C $d_2 = \frac{0.5(100.0)(1-0.50)^2}{1-(0.50)(0.25)} = 14.3$ s/bicycle, LOS B $d_3 = \frac{0.5(100.0)(1-0.40)^2}{1-(0.40)(0.31)} = 20.5$ s/bicycle, LOS C
4. Find S_{ats} (use Equation 19-11).	$S_{ats} = \frac{L_T}{\left[\sum \frac{L_i}{S_i} + \frac{\sum d_i}{3600} \right]}$ $S_{ats} = \frac{2.0}{\left[\frac{(0.5+0.2+1.0+0.3)}{25} + \frac{(28.0+14.3+20.5)}{3600} \right]} = 20.5$ km/h
5. Determine LOS (use Exhibit 19-4).	LOS B

Results The bicycle lane on the arterial operates at LOS B. Assuming a mean speed of 18 km/h and a standard deviation of 3.0 km/h, the number of events is 47 events/h using Exhibit 19-3. This results in LOS B for the eastbound direction using Exhibit 19-1.

The LOS for each intersection based on delay is LOS C, B, and C for Intersections 1, 2, and 3, respectively.

Example Problem 4

BICYCLE WORKSHEET									
General Information					Site Information				
Analyst <u>JMYE</u>					Path or Bicycle Lane <u>North-South</u>				
Agency or Company <u>CEI</u>					Jurisdiction _____				
Date Performed <u>5/19/99</u>					Analysis Year <u>1999</u>				
Analysis Time Period <u>Peak</u>									
<input checked="" type="checkbox"/> Operational (LOS)		<input type="checkbox"/> Design (v_b)		<input type="checkbox"/> Planning (LOS)		<input type="checkbox"/> Planning (v_b)			
Input			Planning Input						
Bicycle path and lane width <input type="checkbox"/> 2.4 m			<input type="checkbox"/> 3.0 m			<input checked="" type="checkbox"/> Other <u>1.2</u> m			
Bicycle peak-hour volume, V_b _____ bicycles/h			Average annual daily traffic, AADT = _____ bicycles/day						
Pedestrian peak-hour volume, V_p _____ p/h			Proportion of AADT during peak-hour, K = _____						
Bicycle peak-hour factor, PHF _____			Design hour volume, DHV = _____ bicycles/h						
Pedestrian peak-hour factor, PHF _____									
Bicycle directional split, P _____ / _____ (EB or NB/WB or SB)									
Pedestrian directional split, P _____ / _____ (EB or NB/WB or SB)									
Directional Flow Rate									
					(EB) or NB			WB or SB	
Peak 15-min bicycle flow rate, v_b (bicycles/h) $v_b = (V_b/PHF) \times P$					<u>250 bicycles/h</u>				
Peak 15-min pedestrian flow rate, v_p (p/h) $v_p = (V_p/PHF) \times P$									
Exclusive Off-Street Path and On-Street Lane (One-Way)									
					EB or NB			WB or SB	
$F_p = 0.188v_b$ (Equation 19-1)					<u>47</u>				
$F_m = 2V_o$ (Equation 19-2)									
$F = 0.5F_m + F_p$ (Equation 19-3 or Exhibit 19-3)					<u>47</u>				
LOS (Exhibit 19-1 or 19-3)					<u>B</u>				
Shared Off-Street Paths									
					EB or NB			WB or SB	
$F_p = 3v_{ps} + 0.188v_{bs}$ (Equation 19-5)									
$F_m = 5v_{po} + 2v_{bo}$ (Equation 19-6)									
$F = 0.5F_m + F_p$ (events/h) (Equation 19-7)									
LOS (Exhibit 19-2)									
Bicycle Lane at Signalized Intersections and Urban Streets (One-Way)									
	Intersection	1	2	3	4	5	6	7	8
Bicycle flow rate, v_b (bicycles/h)		<u>250</u>	<u>250</u>	<u>250</u>					
Capacity, c_b (bicycles/h) $c_b = 2000(g/C)$ (Equation 19-9)		<u>600</u>	<u>1000</u>	<u>800</u>					
v_b/c_b Ratio, X_b		<u>0.42</u>	<u>0.25</u>	<u>0.31</u>					
Cycle length, C (s)		<u>100.0</u>	<u>100.0</u>	<u>100.0</u>					
g/C Ratio		<u>0.30</u>	<u>0.50</u>	<u>0.40</u>					
Delay, d_b (Equation 19-10) $d_b = \frac{0.5C(1 - g/C)^2}{1 - [(g/C)\min(\frac{v_b}{c_b}, 1.0)]}$		<u>28.0</u>	<u>14.3</u>	<u>20.5</u>					
LOS for lanes at signals (Exhibit 19-4)		<u>C</u>	<u>B</u>	<u>C</u>					
Length of link, L (km)		<u>0.5</u>	<u>0.2</u>	<u>1.0</u>	<u>0.3</u>				
Average travel speed, S_{ats} (km/h) (Equation 19-11) $S_{ats} = \frac{L}{\sum \frac{L_i}{S_i} + \frac{\sum d_i}{3600}}$		<u>20.5</u>							
LOS urban street bicycle facility (Exhibit 19-5)		<u>B</u>							

EXAMPLE PROBLEM 5

The Bicycle Facility An on-street bicycle lane (1.8 m wide) with passing allowed.

The Question What is the LOS of this facility during the peak hour?

The Facts

- √ A bicycle lane (1.8 m wide) with allowance for passing,
- √ Peak-hour volume = 150 bicycles/h,
- √ Peak-hour factor = 0.75,
- √ Heavy side friction due to large vehicle volume,
- √ High driveway density,
- √ Observed mean speed = 18 km/h, and
- √ Standard deviation of 4.5 km/h.

Comments Since the standard deviation of speeds of 4.5 km/h is different from the default value of 3.0 km/h, Equations 19-1 to 19-3 cannot be used. Exhibit 19-3 must be used to predict the number of passing events and LOS.

Outline of Solution First, hourly flow rate will be converted to 15-min peak flow rate. The number of passing events will be obtained from Exhibit 19-3 and LOS from Exhibit 19-1.

Steps

1. Find directional flows.	$v_b = \frac{V_b}{PHF}$ $v_b = \frac{150}{0.75} = 200 \text{ bicycles/h}$
2. Find F for mean speed of 18 km/h and standard deviation of 4.5 km/h (use Exhibit 19-3).	F = 56 events/h
3. Determine LOS (use Exhibit 19-1).	LOS B

Results The bicycle facility operates at LOS B. Note that if the default values were used (18 km/h, 3 km/h standard deviation), the predicted number of events would drop to 38 events/h. This would incorrectly represent LOS A as the operating condition.

Example Problem 5

BICYCLE WORKSHEET									
General Information					Site Information				
Analyst		JMYE			Path or Bicycle Lane		North-South		
Agency or Company		CEI			Jurisdiction				
Date Performed		5/26/99			Analysis Year		1999		
Analysis Time Period		Peak							
<input checked="" type="checkbox"/> Operational (LOS)		<input type="checkbox"/> Design (v _b)			<input type="checkbox"/> Planning (LOS)		<input type="checkbox"/> Planning (v _b)		
Input					Planning Input				
Bicycle path and lane width		<input type="checkbox"/> 2.4 m			<input type="checkbox"/> 3.0 m		<input checked="" type="checkbox"/> Other 1.8 m		
Bicycle peak-hour volume, V _b		150 bicycles/h			Average annual daily traffic, AADT =				
Pedestrian peak-hour volume, V _p		p/h			Proportion of AADT during peak-hour, K =				
Bicycle peak-hour factor, PHF		0.75			Design hour volume, DHV =				
Pedestrian peak-hour factor, PHF									
Bicycle directional split, P		/ (EB or NB/WB or SB)							
Pedestrian directional split, P		/ (EB or NB/WB or SB)							
Directional Flow Rate									
					EB or NB		WB or SB		
Peak 15-min bicycle flow rate, v _b (bicycles/h)					$\frac{150}{0.75} = 200$				
v _b = (V _b /PHF) × P									
Peak 15-min pedestrian flow rate, v _p (p/h)									
v _p = (V _p /PHF) × P									
Exclusive Off-Street Path and On-Street Lane (One-Way)									
					EB or NB		WB or SB		
F _p = 0.188v _s (Equation 19-1)									
F _m = 2v _o (Equation 19-2)									
F = 0.5F _m + F _p (Equation 19-3 or Exhibit 19-3)					56				
LOS (Exhibit 19-1 or 19-3)					B				
Shared Off-Street Paths									
					EB or NB		WB or SB		
F _p = 3v _{ps} + 0.188v _{bs} (Equation 19-5)									
F _m = 5v _{po} + 2v _{bo} (Equation 19-6)									
F = 0.5F _m + F _p (events/h) (Equation 19-7)									
LOS (Exhibit 19-2)									
Bicycle Lane at Signalized Intersections and Urban Streets (One-Way)									
Intersection		1	2	3	4	5	6	7	8
Bicycle flow rate, v _b (bicycles/h)									
Capacity, c _b (bicycles/h)									
c _b = 2000(g/C) (Equation 19-9)									
v _b /c _b Ratio, X _b									
Cycle length, C (s)									
g/C Ratio									
Delay, d _b (Equation 19-10)									
d _b = $\frac{0.5C(1-g/C)^2}{1 - [(g/C)\min(\frac{v_b}{c_b}, 1.0)]}$									
LOS for lanes at signals (Exhibit 19-4)									
Length of link, L (km)									
Average travel speed, S _{ats} (km/h)									
(Equation 19-11) S _{ats} = $\frac{L_T}{(\sum \frac{L_i}{S_i} + \frac{\sum d_i}{3600})}$									
LOS urban street bicycle facility (Exhibit 19-5)									

EXAMPLE PROBLEM 6

The Bicycle Facility An east-west uninterrupted-flow shared path (2.4 m wide).

The Question What is the LOS of this facility, and if it does not meet the goal, what is the LOS with pedestrians and bicycles on separate paths?

The Facts

- √ Two effective lanes (2.4 m wide),
- √ Peak pedestrian flow rate = 80 p/h,
- √ Directional split for pedestrians = 50/50 (EB/WB),
- √ Peak bicycle flow rate = 100 bicycles/h, and
- √ Directional split for bicycles = 70/30 (EB/WB).

Outline of Solution All input parameters are known. Number of events in each direction and LOS for bicycles are computed using Equations 19-5, 19-6, and 19-7 for the shared path. If LOS is D or worse, provide a 1.5-m pedestrian path and compute. Events and LOS in each direction are then computed for bicycle-only facility using Equations 19-1, 19-2, and 19-3.

Steps

1. Find directional flow.	EB bicycles = $0.7(100) = 70$ bicycles/h WB bicycles = $0.3(100) = 30$ bicycles/h EB peds = $0.5(80) = 40$ p/h WB peds = $0.5(80) = 40$ p/h
2. Find F_p (use Equation 19-5).	$F_p = 3v_{ps} + 0.188v_{bs}$ $F_p = 3(40) + 0.188(70) = 133$ events/h (EB) $F_p = 3(40) + 0.188(30) = 126$ events/h (WB)
3. Find F_m (use Equation 19-6).	$F_m = 5v_{po} + 2v_{bo}$ $F_m = 5(40) + 2(30) = 260$ events/h (EB) $F_m = 5(40) + 2(70) = 340$ events/h (WB)
4. Find F (use Equation 19-7).	$F = 0.5F_m + F_p$ $F = 0.5(260) + 133 = 263$ events/h (EB) $F = 0.5(340) + 126 = 296$ events/h (WB)
5. Determine LOS (use Exhibit 19-2).	LOS F (EB) LOS F (WB)
6. Find F_p (use Equation 19-1).	$F_p = 0.188v_s$ $F_p = 0.188(70) = 13$ events/h (EB) $F_p = 0.188(30) = 6$ events/h (WB)
7. Find F_m (use Equation 19-2).	$F_m = 2v_o$ $F_m = 2(30) = 60$ events/h (EB) $F_m = 2(70) = 140$ events/h (WB)
8. Find F (use Equation 19-3).	$F = 0.5F_m + F_p$ $F = 0.5(60) + 13 = 43$ events/h (EB) $F = 0.5(140) + 6 = 76$ events/h (WB)
9. Determine LOS (use Exhibit 19-1).	LOS B (EB) LOS C (WB)

Results By providing separate bicycle and pedestrian paths, the operation of the bicycle path is improved.

Shared Exclusive
 LOS F (EB) LOS B (EB)
 LOS F (WB) LOS C (WB)

Example Problem 6

BICYCLE WORKSHEET									
General Information					Site Information				
Analyst		<u>Alex S.</u>			Path or Bicycle Lane		<u>East-West</u>		
Agency or Company		<u>NWU</u>			Jurisdiction		_____		
Date Performed		<u>5/12/99</u>			Analysis Year		<u>1999</u>		
Analysis Time Period		<u>Peak</u>							
<input checked="" type="checkbox"/> Operational (LOS)		<input type="checkbox"/> Design (v_b)			<input type="checkbox"/> Planning (LOS)		<input type="checkbox"/> Planning (v_b)		
Input		Planning Input							
Bicycle path and lane width		<input checked="" type="checkbox"/> 2.4 m		<input type="checkbox"/> 3.0 m		<input type="checkbox"/> Other _____ m			
Bicycle peak-hour volume, V_b		_____ bicycles/h			Average annual daily traffic, AADT = _____ bicycles/day				
Pedestrian peak-hour volume, V_p		_____ p/h			Proportion of AADT during peak-hour, K = _____				
Bicycle peak-hour factor, PHF		_____			Design hour volume, DHV = _____ bicycles/h				
Pedestrian peak-hour factor, PHF		_____							
Bicycle directional split, P		<u>70 / 30</u> (EB or NB/WB or SB)							
Pedestrian directional split, P		<u>50 / 50</u> (EB or NB/WB or SB)							
Directional Flow Rate									
					(EB) or NB		(WB) or SB		
Peak 15-min bicycle flow rate, v_b (bicycles/h)					$0.7 \times 100 = 70$		$0.3 \times 100 = 30$		
$v_b = (V_b/PHF) \times P$									
Peak 15-min pedestrian flow rate, v_p (p/h)					$0.5 \times 80 = 40$		$0.5 \times 80 = 40$		
$v_p = (V_p/PHF) \times P$									
Exclusive Off-Street Path and On-Street Lane (One-Way)									
					(EB) or NB		(WB) or SB		
$F_p = 0.188v_{ps}$ (Equation 19-1)					13		6		
$F_m = 2v_{po}$ (Equation 19-2)					60		140		
$F = 0.5F_m + F_p$ (Equation 19-3 or Exhibit 19-3)					43		76		
LOS (Exhibit 19-1 or 19-3)					B		C		
Shared Off-Street Paths									
					(EB) or NB		(WB) or SB		
$F_p = 3v_{ps} + 0.188v_{bs}$ (Equation 19-5)					133		126		
$F_m = 5v_{po} + 2v_{bo}$ (Equation 19-6)					260		340		
$F = 0.5F_m + F_p$ (Equation 19-7)					263		296		
LOS (Exhibit 19-2)					F		F		
Bicycle Lane at Signalized Intersections and Urban Streets (One-Way)									
Intersection		1	2	3	4	5	6	7	8
Bicycle flow rate, v_b (bicycles/h)									
Capacity, c_b (bicycles/h)									
$c_b = 2000(g/C)$ (Equation 19-9)									
v_b/c_b Ratio, X_b									
Cycle length, C (s)									
g/C Ratio									
Delay, d_b (Equation 19-10)									
$d_b = \frac{0.5C(1-g/C)^2}{1 - [(g/C)\min(\frac{v_b}{c_b}, 1.0)]}$									
LOS for lanes at signals (Exhibit 19-4)									
Length of link, L (km)									
Average travel speed, S_{ats} (km/h)									
(Equation 19-11) $S_{ats} = \left(\frac{L}{\sum \frac{L_i}{S_i} + \frac{\sum d_i}{3600}} \right)$									
LOS urban street bicycle facility (Exhibit 19-5)									

V. REFERENCES

1. Roupail, N., J. Hummer, D. Allen, and J. Milazzo. *Recommended Procedures for Chapter 14, Bicycles, of the Highway Capacity Manual*. Report FHWA-RD-98-108. FHWA, U.S. Department of Transportation, Feb. 1998.
2. Markey, D., D. Reinfurt, H. Knuimou, J. Stewart, and A. Sorton. *Development of the Bicycle Compatibility Index: A Level-of-Service Concept, Final Report*. FHWA, U.S. Department of Transportation, Dec. 1998.
3. American Association of State Highway and Transportation Officials. *Guide for Development of Bicycle Facilities*. Washington, D.C., June 1999.
4. Botma, H. Method to Determine Levels of Service for Bicycle Paths and Pedestrian-Bicycle Paths. In *Transportation Research Record 1502*, TRB, National Research Council, Washington, D.C., 1995.
5. Opiela, K., K. Snehamay, and T. Datta. Determination of the Characteristics of Bicycle Traffic at Urban Intersections. In *Transportation Research Record 743*, TRB, National Research Council, Washington, D.C., 1980.
6. Ferrara, T.C. *A Study of Two-Lane Intersections and Crossings Under Combined Motor Vehicle and Bicycle Demands*. Final Report, Report No. 75-5. Civil Engineering Department, University of California, Davis, Dec. 1975.

APPENDIX A. WORKSHEET

BICYCLE WORKSHEET

BICYCLE WORKSHEET									
General Information					Site Information				
Analyst	_____				Path or Bicycle Lane	_____			
Agency or Company	_____				Jurisdiction	_____			
Date Performed	_____				Analysis Year	_____			
Analysis Time Period	_____								
<input type="checkbox"/> Operational (LOS)		<input type="checkbox"/> Design (v_b)			<input type="checkbox"/> Planning (LOS)			<input type="checkbox"/> Planning (v_b)	
Input					Planning Input				
Bicycle path and lane width		<input type="checkbox"/> 2.4 m			<input type="checkbox"/> 3.0 m			<input type="checkbox"/> Other _____ m	
Bicycle peak-hour volume, V_b		_____ bicycles/h			Average annual daily traffic, AADT =		_____ bicycles/day		
Pedestrian peak-hour volume, V_p		_____ p/h			Proportion of AADT during peak-hour, K =		_____		
Bicycle peak-hour factor, PHF		_____			Design hour volume, DHV =		_____ bicycles/h		
Pedestrian peak-hour factor, PHF		_____							
Bicycle directional split, P		_____/_____ (EB or NB/WB or SB)							
Pedestrian directional split, P		_____/_____ (EB or NB/WB or SB)							
Directional Flow Rate									
					EB or NB		WB or SB		
Peak 15-min bicycle flow rate, v_b (bicycles/h)									
$v_b = (V_b/PHF) \times P$									
Peak 15-min pedestrian flow rate, v_p (p/h)									
$v_p = (V_p/PHF) \times P$									
Exclusive Off-Street Path and On-Street Lane (One-Way)									
					EB or NB		WB or SB		
$F_p = 0.188v_s$ (Equation 19-1)									
$F_m = 2v_o$ (Equation 19-2)									
$F = 0.5F_m + F_p$ (Equation 19-3 or Exhibit 19-3)									
LOS (Exhibit 19-1 or 19-3)									
Shared Off-Street Paths									
					EB or NB		WB or SB		
$F_p = 3v_{ps} + 0.188v_{bs}$ (Equation 19-5)									
$F_m = 5v_{po} + 2v_{bo}$ (Equation 19-6)									
$F = 0.5F_m + F_p$ (events/h) (Equation 19-7)									
LOS (Exhibit 19-2)									
Bicycle Lane at Signalized Intersections and Urban Streets (One-Way)									
Intersection									
	1	2	3	4	5	6	7	8	
Bicycle flow rate, v_b (bicycles/h)									
Capacity, c_b (bicycles/h)									
$c_b = 2000(g/C)$ (Equation 19-9)									
v_b/c_b Ratio, X_b									
Cycle length, C (s)									
g/C Ratio									
Delay, d_b (Equation 19-10)									
$d_b = \frac{0.5C(1 - g/C)^2}{1 - [(g/C)\min(\frac{v_b}{c_b}, 1.0)]}$									
LOS for lanes at signals (Exhibit 19-4)									
Length of link, L (km)									
Average travel speed, S_{ats} (km/h)									
(Equation 19-11) $S_{ats} = \frac{L_T}{\sum \frac{L_i}{S_i} + \frac{\sum d_i}{3600}}$									
LOS urban street bicycle facility (Exhibit 19-5)									

CHAPTER 20

TWO-LANE HIGHWAYS

CONTENTS

I.	INTRODUCTION	20-1
	Scope of the Methodology	20-1
	Limitations of the Methodology	20-1
II.	METHODOLOGY	20-2
	Capacity	20-3
	Levels of Service	20-3
	Two-Way Segments	20-3
	Determining Free-Flow Speed	20-4
	Field Measurement	20-4
	Estimating FFS	20-5
	Determining Demand Flow Rate	20-6
	PHF	20-7
	Grade Adjustment Factor	20-7
	Adjustment for Heavy Vehicles	20-7
	Level Terrain	20-8
	Rolling Terrain	20-8
	Heavy-Vehicle Adjustment Factor	20-8
	Iterative Computations	20-9
	Determining Average Travel Speed	20-9
	Determining Percent Time-Spent-Following	20-9
	Determining LOS	20-10
	Other Traffic Performance Measures	20-11
	Directional Segments	20-12
	Determining FFS	20-13
	Determining Demand Flow Rate	20-13
	PHF	20-13
	Adjustments for Grade and Heavy Vehicles	20-13
	Iterative Computations	20-20
	Determining Average Travel Speed	20-20
	Determining Percent Time-Spent-Following	20-22
	Determining LOS	20-22
	Other Traffic Performance Measures	20-22
	Directional Segments with Passing Lanes	20-22
	Analysis of a Directional Segment with a Passing Lane	20-25
	Dividing the Segment into Regions	20-25
	Determining Percent Time-Spent-Following	20-26
	Determining Average Travel Speed	20-27
	Determining LOS	20-27
	Effects of Passing Lanes on Opposing Traffic	20-28
	Directional Segments with Climbing Lanes on Upgrades	20-28
	LOS Assessment for Directional Two-Lane Facilities	20-29
	LOS Assessment for Uninterrupted-Flow Facilities and Corridors with Two-Lane Highways	20-29
III.	APPLICATIONS	20-30
	Computational Steps	20-30
	Planning Applications	20-32
	Analysis Tools	20-32

IV. EXAMPLE PROBLEMS	20-32
Example Problem 1	20-33
Example Problem 2	20-36
Example Problem 3	20-39
Example Problem 4	20-42
V. REFERENCES	20-44
APPENDIX A. DESIGN AND OPERATIONAL TREATMENTS	20-44
Turnouts	20-44
Shoulder Use	20-45
Wide Cross Sections	20-45
Intersection Turn Lanes	20-46
Two-Way Left-Turn Lanes	20-47
APPENDIX B. WORKSHEETS	20-49
Two-Way Two-Lane Highway Segment Worksheet	
Directional Two-Lane Highway Segment Worksheet	
Directional Two-Lane Highway Segment with Passing Lane Worksheet	

EXHIBITS

Exhibit 20-1. Two-Lane Highway Methodology	20-2
Exhibit 20-2. LOS Criteria for Two-Lane Highways in Class I	20-3
Exhibit 20-3. LOS Criteria (Graphical) for Two-Lane Highways in Class I	20-4
Exhibit 20-4. LOS Criteria for Two-Lane Highways in Class II	20-4
Exhibit 20-5. Adjustment (f_{LS}) for Lane Width and Shoulder Width	20-6
Exhibit 20-6. Adjustment (f_A) for Access-Point Density	20-6
Exhibit 20-7. Grade Adjustment Factor (f_G) to Determine Speeds on Two-Way and Directional Segments	20-7
Exhibit 20-8. Grade Adjustment Factor (f_G) to Determine Percent Time-Spent- Following on Two-Way and Directional Segments	20-7
Exhibit 20-9. Passenger-Car Equivalents for Trucks and RVs to Determine Speeds on Two-Way and Directional Segments.....	20-8
Exhibit 20-10. Passenger-Car Equivalents for Trucks and RVs to Determine Percent Time-Spent-Following on Two-Way and Directional Segments	20-8
Exhibit 20-11. Adjustment (f_{np}) for Effect of No-Passing Zones on Average Travel Speed on Two-Way Segments	20-10
Exhibit 20-12. Adjustment ($f_{d/np}$) for Combined Effect of Directional Distribution of Traffic and Percentage of No-Passing Zones on Percent Time- Spent-Following on Two-Way Segments	20-11
Exhibit 20-13. Grade Adjustment Factor (f_G) for Estimating Average Travel Speed on Specific Upgrades	20-15
Exhibit 20-14. Grade Adjustment Factor (f_G) for Estimating Percent Time-Spent- Following on Specific Upgrades	20-16
Exhibit 20-15. Passenger-Car Equivalents for Trucks for Estimating Average Speed on Specific Upgrades	20-17
Exhibit 20-16. Passenger-Car Equivalents for Trucks and RVs for Estimating Percent Time-Spent-Following on Specific Upgrades	20-18
Exhibit 20-17. Passenger-Car Equivalents for RVs for Estimating Average Travel Speed on Specific Upgrades	20-19
Exhibit 20-18. Passenger-Car Equivalents for Estimating the Effect on Average Travel Speed of Trucks that Operate at Crawl Speeds on Long Steep Downgrades	20-20

Exhibit 20-19.	Adjustment (f_{np}) to Average Travel Speed for Percentage of No-Passing Zones in Directional Segments	20-21
Exhibit 20-20.	Adjustment (f_{np}) to Percent Time-Spent-Following for Percentage of No-Passing Zones in Directional Segments	20-23
Exhibit 20-21.	Values of Coefficients Used in Estimating Percent Time-Spent-Following for Directional Segments	20-24
Exhibit 20-22.	Operational Effect of a Passing Lane on Percent Time-Spent-Following	20-24
Exhibit 20-23.	Downstream Length of Roadway Affected by Passing Lanes on Directional Segments in Level and Rolling Terrain	20-24
Exhibit 20-24.	Factors (f_{pl}) for Estimation of Average Travel Speed and Percent Time-Spent-Following Within a Passing Lane	20-26
Exhibit 20-25.	Effect of a Passing Lane on Percent Time-Spent-Following as Represented in the Operational Analysis Methodology	20-26
Exhibit 20-26.	Effect of a Passing Lane on Average Travel Speed as Represented in the Operational Analysis Methodology	20-28
Exhibit 20-27.	Factors (f_{pl}) for Estimation of Average Travel Speed and Percent Time-Spent-Following Within a Climbing Lane	20-29
Exhibit 20-28.	Two-Way Two-Lane Highway Segment Worksheet	20-31
Exhibit A20-1.	Typical Turnout to Increase Passing Opportunities on a Two-Lane Highway	20-45
Exhibit A20-2.	Typical Two-Lane Highway Intersection with Left-Turn Lanes	20-46
Exhibit A20-3.	Effect of Turning Delays at Intersections on Percent Time-Spent-Following in a Two-Lane Highway	20-47
Exhibit A20-4.	Typical Shoulder Bypass Lane at a Three-Leg Intersection on a Two-Lane Highway	20-47
Exhibit A20-5.	Typical Two-Way Left-Turn Lane on a Two-Lane Highway	20-48
Exhibit A20-6.	Estimated Delay Reduction with a Two-Way Left-Turn Lane on a Two-Lane Highway Without Paved Shoulders	20-48

I. INTRODUCTION

This chapter presents a comprehensive study of two-lane highway operation (*I*). The development of the methodology used microscopic simulation, field data, and theoretical concepts. Analytical procedures are provided for two applications, operational and planning. Chapter 12, “Highway Concepts,” presents definitions of basic parameters and important concepts related to the methodology. Appendix A also covers design treatments not addressed by the methodology.

For background and concepts, see Chapter 12, “Highway Concepts”

SCOPE OF THE METHODOLOGY

This chapter presents operational analysis for two-way and directional segments of two-lane highways. Two-way segments may include longer sections of two-lane highway with homogeneous cross sections and relatively constant demand volumes and vehicle mixes over the length of the segment. Two-way segments may be located in level or rolling terrain. Two-lane highways in mountainous terrain or with grades of 3 percent or more for lengths of 1.0 km or more cannot be analyzed as two-lane segments. Instead, they are analyzed as specific upgrades or downgrades. Performance measures for the two-way segment methodology apply to both directions of travel combined.

The analysis can consider two directions combined or only one direction

Directional segments carry one direction of travel on a two-lane highway with homogeneous cross sections and relatively constant demand volume and vehicle mix. Any roadway segment can be evaluated with the directional segment procedure, but separate analysis by direction of travel is particularly appropriate for steep grades and for segments containing passing lanes.

The types of directional segments addressed by the operational applications include directional segments in level or rolling terrain, specific upgrades, and specific downgrades. When only one direction of travel on a two-way segment is analyzed, the procedure for directional segments in level and rolling terrain is used. All directional segments in mountainous terrain and all grades of 3 percent or more with a length of 1.0 km or more must be analyzed as specific upgrades or downgrades.

For analysis of specific upgrades or downgrades, the length of grade is its tangent length plus a portion of the vertical curves at its beginning and end. About one-fourth of the length of the vertical curves at the beginning and end of a grade are included. If two grades (in the same direction) are joined by a vertical curve, one-half the length of the curve is included in each grade segment. The performance measures determined by the directional segment methodology apply only to the direction of travel being analyzed. However, the traffic performance measures for the analysis direction are influenced by the flow rate and traffic characteristics in the opposing direction.

The objective of operational analysis is to determine the level of service (LOS) for an existing or proposed facility operating under current or projected traffic demand. Operational analysis also may be used to determine the capacity of a two-lane highway segment, or the service flow rate that can be accommodated at any given LOS.

LIMITATIONS OF THE METHODOLOGY

Some two-lane highways—particularly those that involve interactions among several passing or climbing lanes—are too complex to be addressed with the procedures of this chapter. For analytical problems beyond the scope of this chapter, see Part V of this manual, which describes the application of simulation modeling to two-lane highway analyses. Several design treatments discussed in Appendix A are not accounted for by the methodology.

The operational analysis methodologies in this chapter do not address two-lane highways with signalized intersections. Isolated signalized intersections on two-lane highways can be evaluated with the methodology in Chapter 16, “Signalized Intersections.” Two-lane highways in urban and suburban areas with multiple signalized

intersections at spacings of 3.2 km or less can be evaluated with the methodology of Chapter 15, "Urban Streets."

II. METHODOLOGY

The following discussion presents estimates of two-lane highway capacity, defines the LOS for two-lane highways, and documents the methodology for operational and for planning applications. Exhibit 20-1 summarizes the basic methodology for two-lane highways.

EXHIBIT 20-1. TWO-LANE HIGHWAY METHODOLOGY

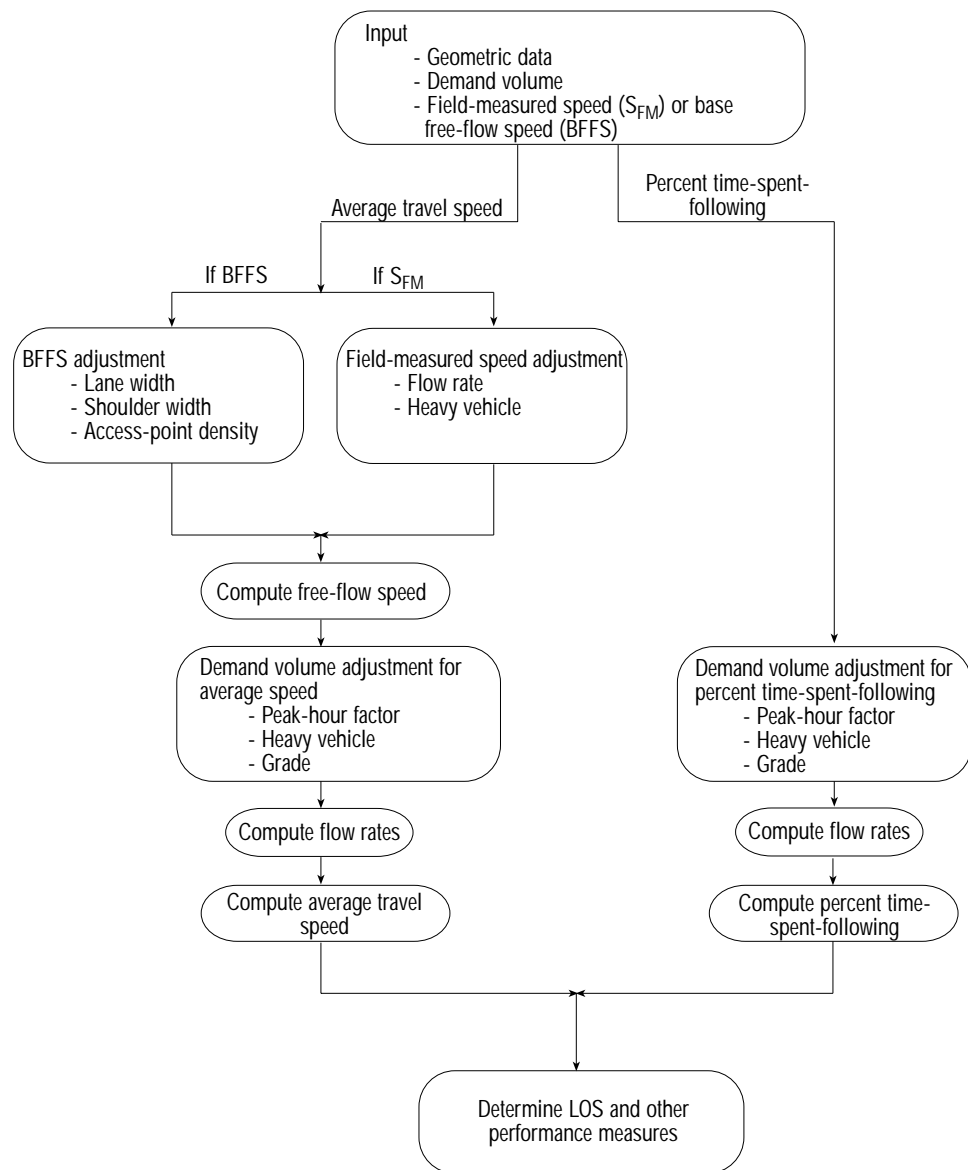

CAPACITY

The capacity of a two-lane highway is 1,700 pc/h for each direction of travel. The capacity is nearly independent of the directional distribution of traffic on the facility, except that for extended lengths of two-lane highway, the capacity will not exceed 3,200 pc/h for both directions of travel combined. For short lengths of two-lane highway—such as tunnels or bridges—a capacity of 3,200 to 3,400 pc/h for both directions of travel combined may be attained but cannot be expected for an extended length.

Capacity = 1,700 pc/h for each direction, and 3,200 for both directions combined

LEVELS OF SERVICE

The service measures for a two-lane highway are defined in Chapter 12, “Highway Concepts.” On Class I highways, efficient mobility is paramount, and LOS is defined in terms of both percent time-spent-following and average travel speed. On Class II highways, mobility is less critical, and LOS is defined only in terms of percent time-spent-following, without consideration of average travel speed. Drivers will tolerate higher levels of percent time-spent-following on a Class II facility than on a Class I facility, because Class II facilities usually serve shorter trips and different trip purposes.

For definitions of the service measures for two-lane highways, percent time-spent-following, and average travel speed, see Chapter 12, “Highway Concepts”

LOS criteria for two-lane highways in Classes I and II are presented in Exhibits 20-2, 20-3, and 20-4. Exhibit 20-2 reflects the maximum values of percent time-spent-following and average travel speed for each LOS for Class I highways. A segment of a Class I highway must meet the criteria for both the percent time-spent-following and the average travel speed shown in Exhibit 20-2 to be classified in any particular LOS. Exhibit 20-3 illustrates the LOS criteria for Class I highways. For example, a Class I two-lane highway with percent time-spent-following equal to 45 percent and an average travel speed of 65 km/h would be classified as LOS D based on Exhibit 20-2. However, a Class II highway with the same conditions would be classified as LOS B based on Exhibit 20-4. The difference between these LOS assessments represents the difference in motorist expectations for Class I and II facilities.

For definitions of Class I and II highways, also see Chapter 12

The LOS criteria in Exhibits 20-2 through 20-4 apply to all types of two-lane highways, including extended two-way segments, extended directional segments, specific upgrades, and specific downgrades.

TWO-WAY SEGMENTS

The two-way segment methodology estimates measures of traffic operation along a section of highway, based on terrain, geometric design, and traffic conditions. Terrain is classified as level or rolling, as described below. Mountainous terrain is addressed in the operational analysis of specific upgrades and downgrades, presented below. This methodology typically is applied to highway sections of at least 3.0 km.

Traffic data needed to apply the two-way segment methodology include the two-way hourly volume, a peak-hour factor (PHF), and the directional distribution of traffic flow. The PHF may be computed from field data, or appropriate default values may be selected from the tabulated values presented in Chapter 12. Traffic data also include the proportion of trucks and recreational vehicles (RVs) in the traffic stream. The operational analysis of extended two-way segments for a two-lane highway involves several steps, described in the following sections.

EXHIBIT 20-2. LOS CRITERIA FOR TWO-LANE HIGHWAYS IN CLASS I

LOS	Percent Time-Spent-Following	Average Travel Speed (km/h)
A	≤ 35	> 90
B	> 35–50	> 80–90
C	> 50–65	> 70–80
D	> 65–80	> 60–70
E	> 80	≤ 60

Note:
LOS F applies whenever the flow rate exceeds the segment capacity.

EXHIBIT 20-3. LOS CRITERIA (GRAPHICAL) FOR TWO-LANE HIGHWAYS IN CLASS I

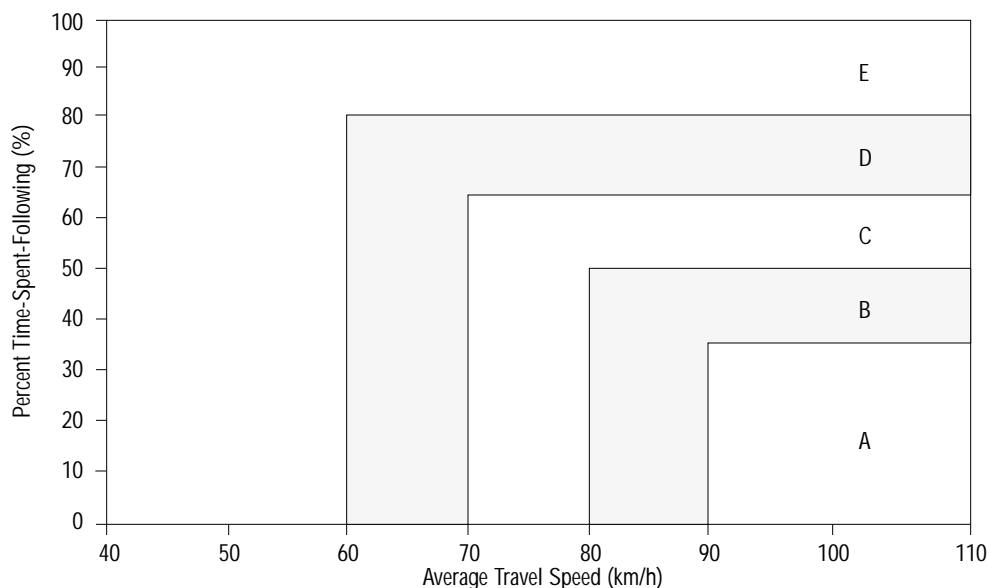

EXHIBIT 20-4. LOS CRITERIA FOR TWO-LANE HIGHWAYS IN CLASS II

LOS	Percent Time-Spent-Following
A	≤ 40
B	> 40–55
C	> 55–70
D	> 70–85
E	> 85

Note:
LOS F applies whenever the flow rate exceeds the segment capacity.

Free-flow speed occurs at two-way flows of 200 pc/h or less

Determining Free-Flow Speed

A key step in the assessment of the LOS of a two-lane highway is to determine the free-flow speed (FFS). The FFS is measured using the mean speed of traffic under low flow conditions (up to two-way flows of 200 pc/h). If field measurements must be made with two-way flow rates of more than 200 pc/h, a volume adjustment must be made in determining FFS. This volume adjustment is discussed below.

Two general methods can be used to determine the FFS for a two-lane highway: field measurement and estimation with the guidelines provided in this chapter. The field-measurement procedure assists in gathering these data directly or incorporating the measurements into a speed monitoring program. However, field measurements are not necessary for an operational analysis—the FFS can be estimated from field data and user knowledge of conditions on the highway.

Field Measurement

The FFS of a highway can be determined directly from a speed study conducted in the field. No adjustments are made to the field-measured data. The speed study should be conducted at a representative location within the highway segment being evaluated; for example, a site on a short upgrade should not be selected within a segment that is generally level. Any speed measurement technique acceptable for other types of traffic engineering speed studies may be used. The field study should be conducted in periods of low traffic flow (up to a two-way flow of 200 pc/h) and should measure the speeds of all vehicles or of a systematic sampling (e.g., of every 10th vehicle). A representative

sample of the speeds of at least 100 vehicles, impeded or unimpeded, should be obtained. Further guidance on speed studies is found in standard traffic engineering texts such as the *Manual of Transportation Engineering Studies* (2).

If the speed study must be conducted at a two-way flow rate of more than 200 pc/h, the FFS can be found by using the speed-flow relationships shown in Chapter 12, assuming that data on traffic volumes are recorded at the same time. The FFS can be computed based on field data as shown in Equation 20-1.

$$FFS = S_{FM} + 0.0125 \frac{V_f}{f_{HV}} \quad (20-1)$$

where

- FFS = estimated free-flow speed (km/h),
- S_{FM} = mean speed of traffic measured in the field (km/h),
- V_f = observed flow rate for the period when field data were obtained (veh/h),
and
- f_{HV} = heavy-vehicle adjustment factor, determined as shown in Equation 20-4.

If field measurement of the highway is not feasible, data taken at a similar facility may be used. The surrogate roadway should be similar with respect to the variables affecting FFS, which are identified in this chapter.

Highway agencies with ongoing speed-monitoring programs or with speed data on file may prefer to use those rather than conducting a new speed study or using indirect speed estimates. However, these data should be used directly only if collected in accordance with the previously described procedures.

Estimating FFS

The FFS can be estimated indirectly if field data are not available. This is a greater challenge on two-lane highways than on other types of uninterrupted-flow facilities because the FFS of a two-lane highway can range from 70 to 110 km/h. To estimate FFS, the analyst must characterize the operating conditions of the facility in terms of a base free-flow speed (BFFS) that reflects the character of traffic and the alignment of the facility. Because of the broad range of speed conditions on two-lane highways and the importance of local and regional factors that influence driver-desired speeds, no guidance on estimating the BFFS is provided. Estimates of BFFS can be developed based on speed data and local knowledge of operating conditions on similar facilities. The design speed and posted speed limit of the facility may be considered in determining the BFFS; however, the design speeds and speed limits for many facilities are not based on current operating conditions. Once BFFS is estimated, adjustments can be made for the influence of lane width, shoulder width, and access-point density. The FFS is estimated using Equation 20-2.

$$FFS = BFFS - f_{LS} - f_A \quad (20-2)$$

where

- FFS = estimated FFS (km/h);
- $BFFS$ = base FFS (km/h);
- f_{LS} = adjustment for lane width and shoulder width, from Exhibit 20-5; and
- f_A = adjustment for access points, from Exhibit 20-6.

The first adjustment to the estimated FFS relates to the effects of lane and shoulder widths. Base conditions for a two-lane highway require 3.6-m lane widths and 1.8-m shoulder widths. Exhibit 20-5 lists the adjustments to the estimated FFS for narrower lanes and shoulders. The data in Exhibit 20-5 indicate, for example, that a two-lane highway with 3.3-m lanes and full shoulder widths has an FFS that is 0.7 km/h less than a highway with base lane and shoulder widths. Similarly, a two-lane highway with 3.6-m

Speed measurements taken at flows exceeding 200 pc/h can be adjusted to FFS

lanes and 0.6-m shoulders has an FFS 4.2 km/h less than a highway with base lane and shoulder widths.

EXHIBIT 20-5. ADJUSTMENT (f_{LS}) FOR LANE WIDTH AND SHOULDER WIDTH

Lane Width (m)	Reduction in FFS (km/h)			
	Shoulder Width (m)			
	≥ 0.0 < 0.6	≥ 0.6 < 1.2	≥ 1.2 < 1.8	≥ 1.8
2.7 < 3.0	10.3	7.7	5.6	3.5
≥ 3.0 < 3.3	8.5	5.9	3.8	1.7
≥ 3.3 < 3.6	7.5	4.9	2.8	0.7
≥ 3.6	6.8	4.2	2.1	0.0

Exhibit 20-6 lists the adjustments for access-point density. The data indicate that each access point per kilometer decreases the estimated FFS by about 0.4 km/h. The access-point density is found by dividing the total number of intersections and driveways on both sides of the roadway segment by the length of the segment in kilometers. An intersection or driveway should only be included if it influences traffic flow; access points unnoticed by the driver or with little activity should not be included.

EXHIBIT 20-6. ADJUSTMENT (f_A) FOR ACCESS-POINT DENSITY

Access Points per km	Reduction in FFS (km/h)
0	0.0
6	4.0
12	8.0
18	12.0
≥ 24	16.0

When data on the number of access points on a two-lane highway segment are unavailable (e.g., when the highway has not yet been constructed), the guidelines in Chapter 12 may be used.

If a highway segment contains sharp horizontal curves with design speeds substantially below the rest of the segment, it may be desirable to determine the FFS separately for curves and tangents and compute a weighted-average FFS for the segment as a whole.

The data for the FFS relationships in this chapter include both commuter and noncommuter traffic. There were no significant differences between the two. However, it is expected that commuters or other regular drivers will use a facility more efficiently than recreational users and other occasional drivers. If the effect of a driver population is a concern, the FFS should be measured in the field. If field measurements cannot be made, an FFS should be selected to reflect the anticipated effect of the driver population. Care should be taken not to underestimate the BFFS of a highway by overstating the effect of a given driver population.

Determining Demand Flow Rate

Three adjustments must be made to hourly demand volumes, whether based on traffic counts or estimates, to arrive at the equivalent passenger-car flow rate used in LOS analysis. These adjustments are the PHF, the grade adjustment factor, and the heavy-vehicle adjustment factor. These adjustments are applied according to Equation 20-3.

$$v_p = \frac{V}{PHF * f_G * f_{HV}} \quad (20-3)$$

where

- v_p = passenger-car equivalent flow rate for peak 15-min period (pc/h),
- V = demand volume for the full peak hour (veh/h),
- PHF = peak-hour factor,
- f_G = grade adjustment factor, and
- f_{HV} = heavy-vehicle adjustment factor.

PHF

PHF represents the variation in traffic flow within an hour. Two-lane highway analysis is based on demand volumes for a peak 15-min period within the hour of interest—usually the peak hour. For operational analysis, the full-hour demand volumes must be converted to flow rates for the peak 15 min, as shown in Equation 20-3.

Grade Adjustment Factor

The grade adjustment factor, f_G , accounts for the effect of the terrain on travel speeds and percent time-spent-following, even if no heavy vehicles are present. The values of the grade adjustment factor are listed in Exhibit 20-7 for estimating average travel speeds and in Exhibit 20-8 for estimating percent time-spent-following.

EXHIBIT 20-7. GRADE ADJUSTMENT FACTOR (f_G) TO DETERMINE SPEEDS ON TWO-WAY AND DIRECTIONAL SEGMENTS

Range of Two-Way Flow Rates (pc/h)	Range of Directional Flow Rates (pc/h)	Type of Terrain	
		Level	Rolling
0–600	0–300	1.00	0.71
> 600–1200	> 300–600	1.00	0.93
> 1200	> 600	1.00	0.99

EXHIBIT 20-8. GRADE ADJUSTMENT FACTOR (f_G) TO DETERMINE PERCENT TIME-SPENT-FOLLOWING ON TWO-WAY AND DIRECTIONAL SEGMENTS

Range of Two-Way Flow Rates (pc/h)	Range of Directional Flow Rates (pc/h)	Type of Terrain	
		Level	Rolling
0–600	0–300	1.00	0.77
> 600–1200	> 300–600	1.00	0.94
> 1200	> 600	1.00	1.00

Adjustment for Heavy Vehicles

The presence of heavy vehicles in the traffic stream decreases the FFS, because at base conditions the traffic stream is assumed to consist only of passenger cars—a rare occurrence. Therefore, traffic volumes must be adjusted to an equivalent flow rate expressed in passenger cars per hour. This adjustment is accomplished by using the factor f_{HV} .

Adjustment for the presence of heavy vehicles in the traffic stream applies to two types of vehicles: trucks and RVs. Buses should not be treated as a separate type of heavy vehicle but should be included with trucks. The heavy-vehicle adjustment factor requires two steps. First, the passenger-car equivalency factors for trucks (E_T) and RVs (E_R) for the prevailing operating conditions must be found. Then, using these values, an adjustment factor must be computed to correct for all heavy vehicles in the traffic stream.

Heavy-vehicle adjustment considers trucks and RVs. Buses are included with trucks.

Passenger-car equivalents for extended two-way segments are determined from Exhibit 20-9 for estimating speeds and from Exhibit 20-10 for estimating percent time-spent-following. The terrain of extended two-way segments should be categorized as level or rolling.

EXHIBIT 20-9. PASSENGER-CAR EQUIVALENTS FOR TRUCKS AND RVs TO DETERMINE SPEEDS ON TWO-WAY AND DIRECTIONAL SEGMENTS

Vehicle Type	Range of Two-Way Flow Rates (pc/h)	Range of Directional Flow Rates (pc/h)	Type of Terrain	
			Level	Rolling
Trucks, E_T	0-600	0-300	1.7	2.5
	> 600-1,200	> 300-600	1.2	1.9
	> 1,200	> 600	1.1	1.5
RVs, E_R	0-600	0-300	1.0	1.1
	> 600-1,200	> 300-600	1.0	1.1
	> 1,200	> 600	1.0	1.1

EXHIBIT 20-10. PASSENGER-CAR EQUIVALENTS FOR TRUCKS AND RVs TO DETERMINE PERCENT TIME-SPENT-FOLLOWING ON TWO-WAY AND DIRECTIONAL SEGMENTS

Vehicle Type	Range of Two-Way Flow Rates (pc/h)	Range of Directional Flow Rates (pc/h)	Type of Terrain	
			Level	Rolling
Trucks, E_T	0-600	0-300	1.1	1.8
	> 600-1,200	> 300-600	1.1	1.5
	> 1,200	> 600	1.0	1.0
RVs, E_R	0-600	0-300	1.0	1.0
	> 600-1,200	> 300-600	1.0	1.0
	> 1,200	> 600	1.0	1.0

Level Terrain

Level terrain is any combination of horizontal and vertical alignment permitting heavy vehicles to maintain approximately the same speed as passenger cars; this generally includes short grades of no more than 1 or 2 percent.

Rolling Terrain

Rolling terrain is any combination of horizontal and vertical alignment causing heavy vehicles to reduce their speeds substantially below those of passenger cars, but not to operate at crawl speeds for any significant length of time or at frequent intervals; generally, this includes short- and medium-length grades of no more than 4 percent. Segments with substantial lengths of more than a 4 percent grade should be analyzed with the specific grade procedure for directional segments.

Heavy-Vehicle Adjustment Factor

Once values for E_T and E_R have been determined, the adjustment factor for heavy vehicles is computed using Equation 20-4.

$$f_{HV} = \frac{1}{1 + P_T (E_T - 1) + P_R (E_R - 1)} \quad (20-4)$$

where

- P_T = proportion of trucks in the traffic stream, expressed as a decimal;
- P_R = proportion of RVs in the traffic stream, expressed as a decimal;

- E_T = passenger-car equivalent for trucks, obtained from Exhibit 20-9 or Exhibit 20-10; and
- E_R = passenger-car equivalent for RVs, obtained from Exhibit 20-9 or Exhibit 20-10.

Iterative Computations

Exhibits 20-7 through 20-10—the grade adjustment factor f_G and the passenger-car equivalents for trucks (E_T) and RVs (E_R)—are stratified by flow rates expressed in passenger cars per hour. However, until Equation 20-3 is applied, the flow rate in passenger cars per hour is not known. Therefore, an iterative approach must be applied to determine the passenger-car equivalent flow rate v_p , and from that, either average travel speed or percent time-spent-following.

First, determine the flow rate, in vehicles per hour, as V/PHF. Second, select values of f_G , E_T , and E_R appropriate for that flow rate from the tables. Then, determine the v_p from those values using Equations 20-3 and 20-4. If the computed value of v_p is less than the upper limit of the selected flow-rate range for which f_G , E_T , and E_R were determined, then the computed value of v_p should be used. If the v_p is higher than the upper limit of the selected flow-rate range, repeat the process for successively higher ranges until an acceptable value of v_p is found. Because the highest range includes all flow rates greater than 1,200 pc/h in both directions of travel combined, it can be used if a computed value exceeds the upper limit of both lower flow-rate ranges.

Determining Average Travel Speed

The average travel speed is estimated from the FFS, the demand flow rate, and an adjustment factor for the percentage of no-passing zones. The demand flow rate for estimating average travel speed is determined with Equation 20-3 using the value of f_{HV} computed with the passenger-car equivalents in Exhibit 20-9. Average travel speed is then estimated using Equation 20-5.

$$ATS = FFS - 0.0125v_p - f_{np} \quad (20-5)$$

where

- ATS = average travel speed for both directions of travel combined (km/h),
- f_{np} = adjustment for percentage of no-passing zones (see Exhibit 20-11), and
- v_p = passenger-car equivalent flow rate for peak 15-min period (pc/h).

The FFS used in Equation 20-5 is the value estimated with Equation 20-1 or Equation 20-2. The adjustment for the effect of the percentage of no-passing zones on average travel speed (f_{np}) is listed in Exhibit 20-11. The exhibit shows that the effect of no-passing zones on average travel speed increases to a maximum at a two-way flow rate of 400 pc/h and then decreases at higher volumes. The maximum value of f_{np} is 7.3 km/h.

Determining Percent Time-Spent-Following

The percent time-spent-following is estimated from the demand flow rate, the directional distribution of traffic, and the percentage of no-passing zones. The demand flow rate (v_p) for estimating percent time-spent-following is determined with Equation 20-3 using the value of f_{HV} computed with passenger-car equivalents from Exhibit 20-10. Percent time-spent-following is then estimated using Equation 20-6. Appropriate values of base percent-time-spent following can be determined from Equation 20-7.

$$PTSF = BPTSF + f_{d/np} \quad (20-6)$$

where

- $PTSF$ = percent-time-spent following,

$BPTSF$ = base percent time-spent-following for both directions of travel combined (use Equation 20-7), and
 $f_{d/np}$ = adjustment for the combined effect of the directional distribution of traffic and of the percentage of no-passing zones on percent time-spent-following.

$$BPTSF = 100 \left(1 - e^{-0.000879v_p} \right) \quad (20-7)$$

An adjustment representing the combined effect of directional distribution of traffic and percentage of no-passing zones ($f_{d/np}$) is presented in Exhibit 20-12.

EXHIBIT 20-11. ADJUSTMENT (f_{np}) FOR EFFECT OF NO-PASSING ZONES ON AVERAGE TRAVEL SPEED ON TWO-WAY SEGMENTS

Two-Way Demand Flow Rate, v_p (pc/h)	Reduction in Average Travel Speed (km/h)					
	No-Passing Zones (%)					
	0	20	40	60	80	100
0	0.0	0.0	0.0	0.0	0.0	0.0
200	0.0	1.0	2.3	3.8	4.2	5.6
400	0.0	2.7	4.3	5.7	6.3	7.3
600	0.0	2.5	3.8	4.9	5.5	6.2
800	0.0	2.2	3.1	3.9	4.3	4.9
1000	0.0	1.8	2.5	3.2	3.6	4.2
1200	0.0	1.3	2.0	2.6	3.0	3.4
1400	0.0	0.9	1.4	1.9	2.3	2.7
1600	0.0	0.9	1.3	1.7	2.1	2.4
1800	0.0	0.8	1.1	1.6	1.8	2.1
2000	0.0	0.8	1.0	1.4	1.6	1.8
2200	0.0	0.8	1.0	1.4	1.5	1.7
2400	0.0	0.8	1.0	1.3	1.5	1.7
2600	0.0	0.8	1.0	1.3	1.4	1.6
2800	0.0	0.8	1.0	1.2	1.3	1.4
3000	0.0	0.8	0.9	1.1	1.1	1.3
3200	0.0	0.8	0.9	1.0	1.0	1.1

Determining LOS

The first step in determining LOS is to compare the passenger-car equivalent flow rate (v_p) to the two-way capacity of 3,200 pc/h. If v_p is greater than the capacity, then the roadway is oversaturated and the LOS is F. Similarly, if the demand flow rate in either direction of travel—as determined from the two-way flow rate and the directional split—is greater than 1,700 pc/h, then the roadway is oversaturated and the LOS is F. In LOS F, percent time-spent-following is nearly 100 percent and speeds are highly variable and difficult to estimate.

When a segment of a Class I facility has a demand less than its capacity, the LOS is determined by locating a point on Exhibit 20-3 that corresponds to the estimated percent time-spent-following and average travel speed. If a segment of a Class II facility has a demand less than its capacity, the LOS is determined by comparing the percent time-spent-following with the criteria in Exhibit 20-4. The analysis should include the LOS and the estimated values of percent time-spent-following and average travel speed. Although average travel speed is not considered in the LOS determination for a Class II highway, the estimate may be useful in evaluating the quality of service of two-lane highway facilities, highway networks, or systems including the segment.

EXHIBIT 20-12. ADJUSTMENT ($f_{d/np}$) FOR COMBINED EFFECT OF DIRECTIONAL DISTRIBUTION OF TRAFFIC AND PERCENTAGE OF NO-PASSING ZONES ON PERCENT TIME-SPENT-FOLLOWING ON TWO-WAY SEGMENTS

Two-Way Flow Rate, v_p (pc/h)	Increase in Percent Time-Spent-Following (%)					
	No-Passing Zones (%)					
	0	20	40	60	80	100
Directional Split = 50/50						
≤ 200	0.0	10.1	17.2	20.2	21.0	21.8
400	0.0	12.4	19.0	22.7	23.8	24.8
600	0.0	11.2	16.0	18.7	19.7	20.5
800	0.0	9.0	12.3	14.1	14.5	15.4
1400	0.0	3.6	5.5	6.7	7.3	7.9
2000	0.0	1.8	2.9	3.7	4.1	4.4
2600	0.0	1.1	1.6	2.0	2.3	2.4
3200	0.0	0.7	0.9	1.1	1.2	1.4
Directional Split = 60/40						
≤ 200	1.6	11.8	17.2	22.5	23.1	23.7
400	0.5	11.7	16.2	20.7	21.5	22.2
600	0.0	11.5	15.2	18.9	19.8	20.7
800	0.0	7.6	10.3	13.0	13.7	14.4
1400	0.0	3.7	5.4	7.1	7.6	8.1
2000	0.0	2.3	3.4	3.6	4.0	4.3
≥ 2600	0.0	0.9	1.4	1.9	2.1	2.2
Directional Split = 70/30						
≤ 200	2.8	13.4	19.1	24.8	25.2	25.5
400	1.1	12.5	17.3	22.0	22.6	23.2
600	0.0	11.6	15.4	19.1	20.0	20.9
800	0.0	7.7	10.5	13.3	14.0	14.6
1400	0.0	3.8	5.6	7.4	7.9	8.3
≥ 2000	0.0	1.4	4.9	3.5	3.9	4.2
Directional Split = 80/20						
≤ 200	5.1	17.5	24.3	31.0	31.3	31.6
400	2.5	15.8	21.5	27.1	27.6	28.0
600	0.0	14.0	18.6	23.2	23.9	24.5
800	0.0	9.3	12.7	16.0	16.5	17.0
1400	0.0	4.6	6.7	8.7	9.1	9.5
≥ 2000	0.0	2.4	3.4	4.5	4.7	4.9
Directional Split = 90/10						
≤ 200	5.6	21.6	29.4	37.2	37.4	37.6
400	2.4	19.0	25.6	32.2	32.5	32.8
600	0.0	16.3	21.8	27.2	27.6	28.0
800	0.0	10.9	14.8	18.6	19.0	19.4
≥1400	0.0	5.5	7.8	10.0	10.4	10.7

Other Traffic Performance Measures

The v/c ratio for an extended two-way segment can be computed using Equation 20-8.

$$v/c = \frac{v_p}{c} \tag{20-8}$$

where

- v/c = volume to capacity ratio;
- c = two-way segment capacity—normally 3,200 pc/h for two-way segment and 1,700 for a directional segment; and
- v_p = passenger-car equivalent flow rate for peak 15-min period (pc/h).

The total travel on the extended two-way segment during the peak 15-min period is computed using Equation 20-9.

$$VkmT_{15} = 0.25 \left(\frac{V}{PHF} \right) L_t \quad (20-9)$$

where

- $VkmT_{15}$ = total travel on the analysis segment during the peak 15-min period (veh-km), and
- L_t = total length of the analysis segment (km).

The total travel on the two-way segment during the peak hour is computed using Equation 20-10.

$$VkmT_{60} = V * L_t \quad (20-10)$$

where

- $VkmT_{60}$ = total travel on the analysis segment during the peak hour (veh-km).

Equation 20-11 can be used to compute the total travel time during the peak 15-min period using Equations 20-5 and 20-9.

$$TT_{15} = \frac{VkmT_{15}}{ATS} \quad (20-11)$$

where

- TT_{15} = total travel time for all vehicles on the analyzed segment during the peak 15-min period (veh-h).

DIRECTIONAL SEGMENTS

The methodology addresses three types of directional segments: extended directional segments, specific upgrades, and specific downgrades. The methodology for directional segments is analogous to the two-way segment methodology, except that it estimates traffic performance measures and LOS for one direction of travel at a time. However, the operational assessment of one direction of travel on a two-lane highway necessarily considers the opposing traffic volume. There is a strong interaction between the directions of travel on a two-lane highway because passing opportunities are reduced and eventually eliminated as the opposing traffic increases.

The directional segment methodology applies on level or rolling terrain, usually to highway sections of at least 3.0 km. Any grade of 3 percent or more and at least 1.0 km long must be addressed with the procedures for specific upgrades and downgrades. Mountainous terrain is addressed through an analysis of individual upgrades and downgrades. The specific upgrade and downgrade procedures differ from the extended segment procedure primarily in the handling of heavy-vehicle effects.

The basic directional segment methodology applies to segments on highways with one lane in each direction. However, there is a supplementary procedure to estimate the operational effect of an added passing lane within a directional segment. The operational analysis of a directional segment on a two-lane highway involves several steps, described below.

Directional analyses usually are applied to segments ≥ 3 km, or to grades ≥ 3 percent and ≥ 1 km in length

Determining FFS

The first step in the analysis of a directional segment is to determine FFS, using either of the methods for extended two-way segments. These methods should be applied on a directional basis rather than to both directions combined. If the FFS for a particular direction of travel is determined in the field, it should be under conditions of low traffic flow in both directions.

Determining Demand Flow Rate

The demand flow rate for the peak 15-min period in the direction analyzed is determined with Equation 20-12, which is analogous to Equation 20-3.

$$v_d = \frac{V}{\text{PHF} * f_G * f_{HV}} \quad (20-12)$$

where

- v_d = passenger-car equivalent flow rate for the peak 15-min period in the direction analyzed (pc/h),
- V = demand volume for the full peak hour in the direction analyzed (veh/h),
- f_G = grade adjustment factor, and
- f_{HV} = heavy-vehicle adjustment factor.

This demand flow rate should be based on the PHF, the traffic composition, and the terrain or actual grade in the specific direction of travel. As in the two-way segment procedure, different values of v_d are used for estimating average travel speed and percent time-spent-following, because the value of f_{HV} will differ for these applications.

Directional analysis also requires consideration of the demand flow rate in the opposing direction. The opposing demand flow rate is computed using Equation 20-13, which is analogous to Equation 20-12.

$$v_o = \frac{V_o}{\text{PHF} * f_G * f_{HV}} \quad (20-13)$$

where

- v_o = passenger-car equivalent flow rate for the peak 15-min period in the opposing direction of travel, and
- V_o = demand volume for the full peak hour in the opposing direction of travel.

The values of PHF and f_{HV} used in Equation 20-13 also should apply to the opposing direction of travel.

PHF

The PHF used in the directional segment procedure should be the same as that applied to a single direction of travel. If possible, the PHF should be determined from local field data, but if field data are not available, the default values given in Chapter 12 can be used.

Adjustments for Grade and Heavy Vehicles

The adjustment for the presence of heavy vehicles in directional segments is analogous to that for two-way segments in that the passenger-car equivalents for trucks (E_T) and RVs (E_R) are determined and used together with the proportions of trucks and RVs in Equation 20-4. However, the procedures for determining the values of E_T and E_R differ for extended directional segments, specific upgrades, and specific downgrades.

The values of E_T and E_R for an extended directional segment in level or rolling terrain are determined from Exhibits 20-9 and 20-10, based on the methodology for two-

Analysis of upgrades is only for segments with grades ≥ 3 percent and ≥ 0.4 km in length

Analysis of downgrades

way segments. For directional segments, the value of the grade adjustment factor, f_G , is given in Exhibits 20-7 and 20-8.

Any upgrade of 3 percent or more and a length of 0.4 km or more may be analyzed as a specific upgrade; however, any upgrade of 3 percent or more and a length of 1.0 km or more must be analyzed as a specific upgrade. This includes all upgrades on directional segments in mountainous terrain. If the grade varies, it should be analyzed as a single composite, using an average computed by dividing the total change in elevation by the total length of grade and expressing the result as a percentage.

The values of the grade adjustment factor f_G , used in estimating average travel speed for specific upgrades, are presented in Exhibit 20-13. The f_G for estimating percent time-spent-following on specific upgrades is presented in Exhibit 20-14. The grade adjustment factor accounts for the effect of the grade on average travel speeds and percent time-spent-following in a traffic stream composed entirely of passenger cars.

Passenger-car equivalents (E_T) for trucks used in estimating average travel speed and percent time-spent-following are presented in Exhibits 20-15 and 20-16, respectively. These factors account for the effect of trucks on average travel speed and percent time-spent-following on the specific upgrade, over and above the effect of the grade on passenger cars.

Exhibit 20-17 presents passenger-car equivalents (E_R) for RVs for estimating average travel speed on a specific upgrade. For estimating percent time-spent-following on specific upgrades, E_R is always 1.0, as shown in Exhibit 20-16.

Any downgrade of 3 percent or more and a length of 1.0 km or more must be analyzed as a specific downgrade. This includes all downgrades on directional segments in mountainous terrain. If the grade of a downgrade varies, it should be analyzed as a single composite using an average computed by dividing the total change in elevation by the total length of grade and expressing the result as a percentage. Because the definitions of specific upgrades and downgrades are similar, the opposing direction of any specific upgrade should be analyzed as a specific downgrade.

For most specific downgrades, the grade adjustment factor f_G is 1.0, and the heavy-vehicle adjustment factor f_{HV} is determined with passenger-car equivalencies from Exhibits 20-9 and 20-10. Some specific downgrades are long and steep enough that some heavy vehicles must travel at crawl speeds to avoid loss of control. This, of course, impedes other vehicles, increases percent time-spent-following, and decreases average travel speed. When this occurs, the heavy-vehicle adjustment factor f_{HV} , used to determine average travel speed, should be based on Equation 20-14 rather than on Equation 20-4.

$$f_{HV} = \frac{1}{1 + P_{TC} * P_T (E_{TC} - 1) + (1 - P_{TC}) P_T (E_T - 1) + P_R (E_R - 1)} \quad (20-14)$$

where

- P_{TC} = proportion (expressed as a decimal) of all trucks in the traffic stream using crawl speeds on the specific downgrade, and
- E_{TC} = passenger-car equivalent for trucks using crawl speeds, obtained from Exhibit 20-18.

In applying Equation 20-14, the passenger-car equivalent for trucks that use crawl speeds (E_{TC}) should be determined from Exhibit 20-18, based on the directional flow rate and the difference between the FFS and the truck crawl speed. The passenger-car equivalents for other trucks (E_T) and RVs (E_R) should be the values for level terrain in Exhibit 20-9. If more specific data are not available, the proportion of all trucks that use crawl speeds can be estimated as equal to the proportion of all trucks that are tractor-trailer combinations.

EXHIBIT 20-13. GRADE ADJUSTMENT FACTOR (f_G) FOR ESTIMATING AVERAGE TRAVEL SPEED ON SPECIFIC UPGRADES

Grade (%)	Length of Grade (km)	Grade Adjustment Factor, f_G		
		Range of Directional Flow Rates v_d (pc/h)		
		0-300	> 300-600	> 600
≥ 3.0 < 3.5	0.4	0.81	1.00	1.00
	0.8	0.79	1.00	1.00
	1.2	0.77	1.00	1.00
	1.6	0.76	1.00	1.00
	2.4	0.75	0.99	1.00
	3.2	0.75	0.97	1.00
	4.8	0.75	0.95	0.97
	≥ 6.4	0.75	0.94	0.95
≥ 3.5 < 4.5	0.4	0.79	1.00	1.00
	0.8	0.76	1.00	1.00
	1.2	0.72	1.00	1.00
	1.6	0.69	0.93	1.00
	2.4	0.68	0.92	1.00
	3.2	0.66	0.91	1.00
	4.8	0.65	0.91	0.96
	≥ 6.4	0.65	0.90	0.96
≥ 4.5 < 5.5	0.4	0.75	1.00	1.00
	0.8	0.65	0.93	1.00
	1.2	0.60	0.89	1.00
	1.6	0.59	0.89	1.00
	2.4	0.57	0.86	0.99
	3.2	0.56	0.85	0.98
	4.8	0.56	0.84	0.97
	≥ 6.4	0.55	0.82	0.93
≥ 5.5 < 6.5	0.4	0.63	0.91	1.00
	0.8	0.57	0.85	0.99
	1.2	0.52	0.83	0.97
	1.6	0.51	0.79	0.97
	2.4	0.49	0.78	0.95
	3.2	0.48	0.78	0.94
	4.8	0.46	0.76	0.93
	≥ 6.4	0.45	0.76	0.93
≥ 6.5	0.4	0.59	0.86	0.98
	0.8	0.48	0.76	0.94
	1.2	0.44	0.74	0.91
	1.6	0.41	0.70	0.91
	2.4	0.40	0.67	0.91
	3.2	0.39	0.67	0.89
	4.8	0.39	0.66	0.88
	≥ 6.4	0.38	0.66	0.87

EXHIBIT 20-14. GRADE ADJUSTMENT FACTOR (f_G) FOR ESTIMATING PERCENT TIME-SPENT-FOLLOWING ON SPECIFIC UPGRADES

Grade (%)	Length of Grade (km)	Grade Adjustment Factor, f_G		
		Range of Directional Flow Rates, v_d (pc/h)		
		0-300	> 300-600	> 600
≥ 3.0 < 3.5	0.4	1.00	0.92	0.92
	0.8	1.00	0.93	0.93
	1.2	1.00	0.93	0.93
	1.6	1.00	0.93	0.93
	2.4	1.00	0.94	0.94
	3.2	1.00	0.95	0.95
	4.8	1.00	0.97	0.96
	≥ 6.4	1.00	1.00	0.97
≥ 3.5 < 4.5	0.4	1.00	0.94	0.92
	0.8	1.00	0.97	0.96
	1.2	1.00	0.97	0.96
	1.6	1.00	0.97	0.97
	2.4	1.00	0.97	0.97
	3.2	1.00	0.98	0.98
	4.8	1.00	1.00	1.00
	≥ 6.4	1.00	1.00	1.00
≥ 4.5 < 5.5	0.4	1.00	1.00	0.97
	0.8	1.00	1.00	1.00
	1.2	1.00	1.00	1.00
	1.6	1.00	1.00	1.00
	2.4	1.00	1.00	1.00
	3.2	1.00	1.00	1.00
	4.8	1.00	1.00	1.00
	≥ 6.4	1.00	1.00	1.00
≥ 5.5 < 6.5	0.4	1.00	1.00	1.00
	0.8	1.00	1.00	1.00
	1.2	1.00	1.00	1.00
	1.6	1.00	1.00	1.00
	2.4	1.00	1.00	1.00
	3.2	1.00	1.00	1.00
	4.8	1.00	1.00	1.00
	≥ 6.4	1.00	1.00	1.00
≥ 6.5	0.4	1.00	1.00	1.00
	0.8	1.00	1.00	1.00
	1.2	1.00	1.00	1.00
	1.6	1.00	1.00	1.00
	2.4	1.00	1.00	1.00
	3.2	1.00	1.00	1.00
	4.8	1.00	1.00	1.00
	≥ 6.4	1.00	1.00	1.00

EXHIBIT 20-15. PASSENGER-CAR EQUIVALENTS FOR TRUCKS FOR ESTIMATING AVERAGE SPEED ON SPECIFIC UPGRADES

Grade (%)	Length of Grade (km)	Passenger-Car Equivalent for Trucks, E_T		
		Range of Directional Flow Rates, v_d (pc/h)		
		0-300	> 300-600	> 600
≥ 3.0 < 3.5	0.4	2.5	1.9	1.5
	0.8	3.5	2.8	2.3
	1.2	4.5	3.9	2.9
	1.6	5.1	4.6	3.5
	2.4	6.1	5.5	4.1
	3.2	7.1	5.9	4.7
	4.8	8.2	6.7	5.3
	≥ 6.4	9.1	7.5	5.7
≥ 3.5 < 4.5	0.4	3.6	2.4	1.9
	0.8	5.4	4.6	3.4
	1.2	6.4	6.6	4.6
	1.6	7.7	6.9	5.9
	2.4	9.4	8.3	7.1
	3.2	10.2	9.6	8.1
	4.8	11.3	11.0	8.9
	≥ 6.4	12.3	11.9	9.7
≥ 4.5 < 5.5	0.4	4.2	3.7	2.6
	0.8	6.0	6.0	5.1
	1.2	7.5	7.5	7.5
	1.6	9.2	9.0	8.9
	2.4	10.6	10.5	10.3
	3.2	11.8	11.7	11.3
	4.8	13.7	13.5	12.4
	≥ 6.4	15.3	15.0	12.5
≥ 5.5 < 6.5	0.4	4.7	4.1	3.5
	0.8	7.2	7.2	7.2
	1.2	9.1	9.1	9.1
	1.6	10.3	10.3	10.2
	2.4	11.9	11.8	11.7
	3.2	12.8	12.7	12.6
	4.8	14.4	14.3	14.2
	≥ 6.4	15.4	15.2	15.0
≥ 6.5	0.4	5.1	4.8	4.6
	0.8	7.8	7.8	7.8
	1.2	9.8	9.8	9.8
	1.6	10.4	10.4	10.3
	2.4	12.0	11.9	11.8
	3.2	12.9	12.8	12.7
	4.8	14.5	14.4	14.3
	≥ 6.4	15.4	15.3	15.2

EXHIBIT 20-16. PASSENGER-CAR EQUIVALENTS FOR TRUCKS AND RVs FOR ESTIMATING PERCENT TIME-SPENT-FOLLOWING ON SPECIFIC UPGRADES

Grade (%)	Length of Grade (km)	Passenger-Car Equivalent for Trucks, E_T			RVs, E_R
		Range of Directional Flow Rates, v_d (pc/h)			
		0-300	> 300-600	> 600	
≥ 3.0 < 3.5	0.4	1.0	1.0	1.0	1.0
	0.8	1.0	1.0	1.0	1.0
	1.2	1.0	1.0	1.0	1.0
	1.6	1.0	1.0	1.0	1.0
	2.4	1.0	1.0	1.0	1.0
	3.2	1.0	1.0	1.0	1.0
	4.8	1.4	1.0	1.0	1.0
	≥ 6.4	1.5	1.0	1.0	1.0
≥ 3.5 < 4.5	0.4	1.0	1.0	1.0	1.0
	0.8	1.0	1.0	1.0	1.0
	1.2	1.0	1.0	1.0	1.0
	1.6	1.0	1.0	1.0	1.0
	2.4	1.1	1.0	1.0	1.0
	3.2	1.4	1.0	1.0	1.0
	4.8	1.7	1.1	1.2	1.0
	≥ 6.4	2.0	1.5	1.4	1.0
≥ 4.5 < 5.5	0.4	1.0	1.0	1.0	1.0
	0.8	1.0	1.0	1.0	1.0
	1.2	1.0	1.0	1.0	1.0
	1.6	1.0	1.0	1.0	1.0
	2.4	1.1	1.2	1.2	1.0
	3.2	1.6	1.3	1.5	1.0
	4.8	2.3	1.9	1.7	1.0
	≥ 6.4	3.3	2.1	1.8	1.0
≥ 5.5 < 6.5	0.4	1.0	1.0	1.0	1.0
	0.8	1.0	1.0	1.0	1.0
	1.2	1.0	1.0	1.0	1.0
	1.6	1.0	1.2	1.2	1.0
	2.4	1.5	1.6	1.6	1.0
	3.2	1.9	1.9	1.8	1.0
	4.8	3.3	2.5	2.0	1.0
	≥ 6.4	4.3	3.1	2.0	1.0
≥ 6.5	0.4	1.0	1.0	1.0	1.0
	0.8	1.0	1.0	1.0	1.0
	1.2	1.0	1.0	1.3	1.0
	1.6	1.3	1.4	1.6	1.0
	2.4	2.1	2.0	2.0	1.0
	3.2	2.8	2.5	2.1	1.0
	4.8	4.0	3.1	2.2	1.0
	≥ 6.4	4.8	3.5	2.3	1.0

EXHIBIT 20-17. PASSENGER-CAR EQUIVALENTS FOR RVS FOR ESTIMATING AVERAGE TRAVEL SPEED ON SPECIFIC UPGRADES

Grade (%)	Length of Grade (km)	Passenger-Car Equivalent for RVs, E_R		
		Range of Directional Flow Rates, v_d (pc/h)		
		0-300	> 300-600	> 600
≥ 3.0 < 3.5	0.4	1.1	1.0	1.0
	0.8	1.2	1.0	1.0
	1.2	1.2	1.0	1.0
	1.6	1.3	1.0	1.0
	2.4	1.4	1.0	1.0
	3.2	1.4	1.0	1.0
	4.8	1.5	1.0	1.0
	≥ 6.4	1.5	1.0	1.0
≥ 3.5 < 4.5	0.4	1.3	1.0	1.0
	0.8	1.3	1.0	1.0
	1.2	1.3	1.0	1.0
	1.6	1.4	1.0	1.0
	2.4	1.4	1.0	1.0
	3.2	1.4	1.0	1.0
	4.8	1.4	1.0	1.0
	≥ 6.4	1.5	1.0	1.0
≥ 4.5 < 5.5	0.4	1.5	1.0	1.0
	0.8	1.5	1.0	1.0
	1.2	1.5	1.0	1.0
	1.6	1.5	1.0	1.0
	2.4	1.5	1.0	1.0
	3.2	1.5	1.0	1.0
	4.8	1.6	1.0	1.0
	≥ 6.4	1.6	1.0	1.0
≥ 5.5 < 6.5	0.4	1.5	1.0	1.0
	0.8	1.5	1.0	1.0
	1.2	1.5	1.0	1.0
	1.6	1.6	1.0	1.0
	2.4	1.6	1.0	1.0
	3.2	1.6	1.0	1.0
	4.8	1.6	1.2	1.0
	≥ 6.4	1.6	1.5	1.2
≥ 6.5	0.4	1.6	1.0	1.0
	0.8	1.6	1.0	1.0
	1.2	1.6	1.0	1.0
	1.6	1.6	1.0	1.0
	2.4	1.6	1.0	1.0
	3.2	1.6	1.0	1.0
	4.8	1.6	1.3	1.3
	≥ 6.4	1.6	1.5	1.4

EXHIBIT 20-18. PASSENGER-CAR EQUIVALENTS FOR ESTIMATING THE EFFECT ON AVERAGE TRAVEL SPEED OF TRUCKS THAT OPERATE AT CRAWL SPEEDS ON LONG STEEP DOWNGRADES

Difference Between FFS and Truck Crawl Speed (km/h)	Passenger-Car Equivalent for Trucks at Crawl Speeds, E_{TC}		
	Range of Directional Flow Rates, v_d (pc/h)		
	0-300	> 300-600	> 600
≤ 20	4.4	2.8	1.4
40	14.3	9.6	5.7
≥ 60	34.1	23.1	13.0

Iterative Computations

As with the two-way segment procedure, Equations 20-12 and 20-13 must be applied iteratively in some situations to determine appropriate values of v_d and v_o . This iterative process for directional segments is analogous to that for two-way segments, but with the following differences:

- For extended segments in level and rolling terrain and for specific downgrades, the directional flow rates from Exhibits 20-7 through 20-10 are used instead of the two-way rates;
- For specific upgrades, Exhibits 20-13 through 20-17 are used instead of Exhibits 20-7 through 20-10; and
- For specific downgrades on which some trucks travel at crawl speeds, Equation 20-14 is used instead of Equation 20-4.

Determining Average Travel Speed

The average travel speed is estimated from the FFS, the demand flow rate, the opposing flow rate, and an adjustment factor for the percentage of no-passing zones in the analysis direction. Average travel speed is then estimated using Equation 20-15.

$$ATS_d = FFS_d - 0.0125(v_d + v_o) - f_{np} \quad (20-15)$$

where

- ATS_d = average travel speed in the analysis direction (km/h),
- FFS_d = free-flow speed in the analysis direction (km/h),
- v_d = passenger-car equivalent flow rate for the peak 15-min period in the analysis direction (pc/h),
- v_o = passenger-car equivalent flow rate for the peak 15-min period in the opposing direction (pc/h), determined from Equation 20-13; and
- f_{np} = adjustment for percentage of no-passing zones in the analysis direction (see Exhibit 20-19).

The term containing v_d and v_o in Equation 20-15 represents the relationship between average travel speed and the directional and opposing flow rates presented in Chapter 12. The adjustment f_{np} accounts for the effect of the percentage of no-passing zones in the analysis direction. As shown in Exhibit 20-19, this effect is greatest when opposing flow rates are low; as the opposing flow rates increase, the effect decreases to zero, since passing and no-passing zones become irrelevant if the opposing flow allows no opportunities to pass.

EXHIBIT 20-19. ADJUSTMENT (f_{np}) TO AVERAGE TRAVEL SPEED FOR PERCENTAGE OF NO-PASSING ZONES IN DIRECTIONAL SEGMENTS

Opposing Demand Flow Rate, v_o (pc/h)	No-Passing Zones (%)				
	≤ 20	40	60	80	100
FFS = 110 km/h					
≤ 100	1.7	3.5	4.5	4.8	5.0
200	3.5	5.3	6.2	6.5	6.8
400	2.6	3.7	4.4	4.5	4.7
600	2.2	2.4	2.8	3.1	3.3
800	1.1	1.6	2.0	2.2	2.4
1000	1.0	1.3	1.7	1.8	1.9
1200	0.9	1.3	1.5	1.6	1.7
1400	0.9	1.2	1.4	1.4	1.5
≥ 1600	0.9	1.1	1.2	1.2	1.3
FFS = 100 km/h					
≤ 100	1.2	2.7	4.0	4.5	4.7
200	3.0	4.6	5.9	6.4	6.7
400	2.3	3.3	4.1	4.4	4.6
600	1.8	2.1	2.6	3.0	3.2
800	0.9	1.4	1.8	2.1	2.3
1000	0.9	1.1	1.5	1.7	1.9
1200	0.8	1.1	1.4	1.5	1.7
1400	0.8	1.0	1.3	1.3	1.4
≥ 1600	0.8	1.0	1.1	1.1	1.2
FFS = 90 km/h					
≤ 100	0.8	1.9	3.6	4.2	4.4
200	2.4	3.9	5.6	6.3	6.6
400	2.1	3.0	3.8	4.3	4.5
600	1.4	1.8	2.5	2.9	3.1
800	0.8	1.1	1.7	2.0	2.2
1000	0.8	0.9	1.3	1.5	1.8
1200	0.8	0.9	1.2	1.4	1.6
1400	0.8	0.9	1.1	1.2	1.4
≥ 1600	0.8	0.8	0.9	0.9	1.1
FFS = 80 km/h					
≤ 100	0.3	1.1	3.1	3.9	4.1
200	1.9	3.2	5.3	6.2	6.5
400	1.8	2.6	3.5	4.2	4.4
600	1.0	1.5	2.3	2.8	3.0
800	0.6	0.9	1.5	1.9	2.1
1000	0.6	0.7	1.1	1.4	1.8
1200	0.6	0.7	1.1	1.3	1.6
1400	0.6	0.7	1.0	1.1	1.3
≥ 1600	0.6	0.7	0.8	0.8	1.0
FFS = 70 km/h					
≤ 100	0.1	0.6	2.7	3.6	3.8
200	1.5	2.6	5.0	6.1	6.4
400	1.5	0.8	3.2	4.1	4.3
600	0.7	0.5	2.1	2.7	2.9
800	0.5	0.5	1.3	1.8	2.0
1000	0.5	0.5	1.0	1.3	1.8
1200	0.5	0.5	1.0	1.2	1.6
1400	0.5	0.5	1.0	1.0	1.2
≥ 1600	0.5	0.5	0.7	0.7	0.9

Determining Percent Time-Spent-Following

The percent time-spent-following is estimated from the demand flow rate, the opposing flow rate, and an adjustment factor for the percentage of no-passing zones in the analysis direction. Percent time-spent-following is estimated using Equation 20-16.

$$PTSF_d = BPTSF_d + f_{np} \quad (20-16)$$

where

- $PTSF_d$ = percent time-spent-following in the direction analyzed,
- $BPTSF_d$ = base percent time-spent-following in the direction analyzed, and
- f_{np} = adjustment for percentage of no-passing zones in the analysis direction (see Exhibit 20-20).

The percent time-spent-following for base conditions under actual traffic volumes in the direction analyzed in Equation 20-16 is estimated by Equation 20-17.

$$BPTSF_d = 100 \left(1 - e^{-av_d^b} \right) \quad (20-17)$$

The values of the coefficients a and b in Equation 20-17 are determined from the flow rate in the opposing direction of travel, as shown in Exhibit 20-21.

The adjustment f_{np} in Equation 20-16 accounts for the effect of the percentage of no-passing zones in the analysis direction. This effect, shown in Exhibit 20-20, is greatest at low opposing flow rates and decreases as the opposing flow rate increases, since passing and no-passing zones become irrelevant if the opposing flow rate is so high that there are no opportunities to pass.

Determining LOS

The first step in determining level of service is to compare the passenger-car equivalent flow rate (v_d) to the roadway capacity of 1,700 pc/h. If v_d is greater than the capacity, then the roadway is oversaturated and the LOS is F. In LOS F, percent time-spent-following is nearly 100 percent and speeds are highly variable and difficult to estimate.

For a segment on a Class I facility with demand less than capacity, the LOS is determined by locating the point corresponding to the estimated percent time-spent-following and average travel speed in Exhibit 20-3. For a segment on a Class II facility with demand less than capacity, the LOS is determined by comparing the directional percent time-spent-following to the criteria in Exhibit 20-4. The reported results of the analysis should include the LOS and the estimated values of percent time-spent-following and average travel speed. Although average travel speed is not considered in the LOS determination for a Class II roadway, the estimate of average travel speed may be useful in evaluating the quality of service of two-lane highway facilities, highway networks, or systems of which the roadway segment is a part.

Other Traffic Performance Measures

Other traffic performance measures, including v/c ratio, total travel, and total travel time, can be determined from Equations 20-8 through 20-11, but using directional volumes, flow rates, and speeds, rather than their two-way equivalents.

DIRECTIONAL SEGMENTS WITH PASSING LANES

Providing a passing lane on a two-lane highway in level or rolling terrain has an effect on its LOS; an operational analysis procedure allows this effect to be estimated. This procedure, however, does not address added lanes in mountainous terrain or on specific upgrades, which are known as climbing lanes. A separate operational analysis procedure for climbing lanes is presented later in this chapter.

The procedure should not be applied to mountainous terrain or specific upgrades

EXHIBIT 20-20. ADJUSTMENT (f_{np}) TO PERCENT TIME-SPENT-FOLLOWING FOR PERCENTAGE OF NO-PASSING ZONES IN DIRECTIONAL SEGMENTS

Opposing Demand Flow Rate, v_o (pc/h)	No-Passing Zones (%)				
	≤ 20	40	60	80	100
FFS = 110 km/h					
≤ 100	10.1	17.2	20.2	21.0	21.8
200	12.4	19.0	22.7	23.8	24.8
400	9.0	12.3	14.1	14.4	15.4
600	5.3	7.7	9.2	9.7	10.4
800	3.0	4.6	5.7	6.2	6.7
1000	1.8	2.9	3.7	4.1	4.4
1200	1.3	2.0	2.6	2.9	3.1
1400	0.9	1.4	1.7	1.9	2.1
≥ 1600	0.7	0.9	1.1	1.2	1.4
FFS = 100 km/h					
≤ 100	8.4	14.9	20.9	22.8	26.6
200	11.5	18.2	24.1	26.2	29.7
400	8.6	12.1	14.8	15.9	18.1
600	5.1	7.5	9.6	10.6	12.1
800	2.8	4.5	5.9	6.7	7.7
1000	1.6	2.8	3.7	4.3	4.9
1200	1.2	1.9	2.6	3.0	3.4
1400	0.8	1.3	1.7	2.0	2.3
≥ 1600	0.6	0.9	1.1	1.2	1.5
FFS = 90 km/h					
≤ 100	6.7	12.7	21.7	24.5	31.3
200	10.5	17.5	25.4	28.6	34.7
400	8.3	11.8	15.5	17.5	20.7
600	4.9	7.3	10.0	11.5	13.9
800	2.7	4.3	6.1	7.2	8.8
1000	1.5	2.7	3.8	4.5	5.4
1200	1.0	1.8	2.6	3.1	3.8
1400	0.7	1.2	1.7	2.0	2.4
≥ 1600	0.6	0.9	1.2	1.3	1.5
FFS = 80 km/h					
≤ 100	5.0	10.4	22.4	26.3	36.1
200	9.6	16.7	26.8	31.0	39.6
400	7.9	11.6	16.2	19.0	23.4
600	4.7	7.1	10.4	12.4	15.6
800	2.5	4.2	6.3	7.7	9.8
1000	1.3	2.6	3.8	4.7	5.9
1200	0.9	1.7	2.6	3.2	4.1
1400	0.6	1.1	1.7	2.1	2.6
≥ 1600	0.5	0.9	1.2	1.3	1.6
FFS = 70 km/h					
≤ 100	3.7	8.5	23.2	28.2	41.6
200	8.7	16.0	28.2	33.6	45.2
400	7.5	11.4	16.9	20.7	26.4
600	4.5	6.9	10.8	13.4	17.6
800	2.3	4.1	6.5	8.2	11.0
1000	1.2	2.5	3.8	4.9	6.4
1200	0.8	1.6	2.6	3.3	4.5
1400	0.5	1.0	1.7	2.2	2.8
≥ 1600	0.4	0.9	1.2	1.3	1.7

EXHIBIT 20-21. VALUES OF COEFFICIENTS USED IN ESTIMATING PERCENT TIME-SPENT-FOLLOWING FOR DIRECTIONAL SEGMENTS

Opposing Demand Flow Rate, v_o (pc/h)	a	b
≤ 200	-0.013	0.668
400	-0.057	0.479
600	-0.100	0.413
800	-0.173	0.349
1000	-0.320	0.276
1200	-0.430	0.242
1400	-0.522	0.225
≥ 1600	-0.665	0.199

Exhibit 20-22 illustrates the operational effect of a passing lane on percent time-spent-following. The figure shows that installation of a passing lane provides operational benefits for some distance downstream before percent time-spent-following returns to its former level. Thus, the effective length of a passing lane is greater than its actual length. Exhibit 20-23 shows how the traffic flow rate on a downstream length of a two-lane highway benefits from a passing lane in terms of both percent time-spent-following and average travel speed.

EXHIBIT 20-22. OPERATIONAL EFFECT OF A PASSING LANE ON PERCENT TIME-SPENT-FOLLOWING

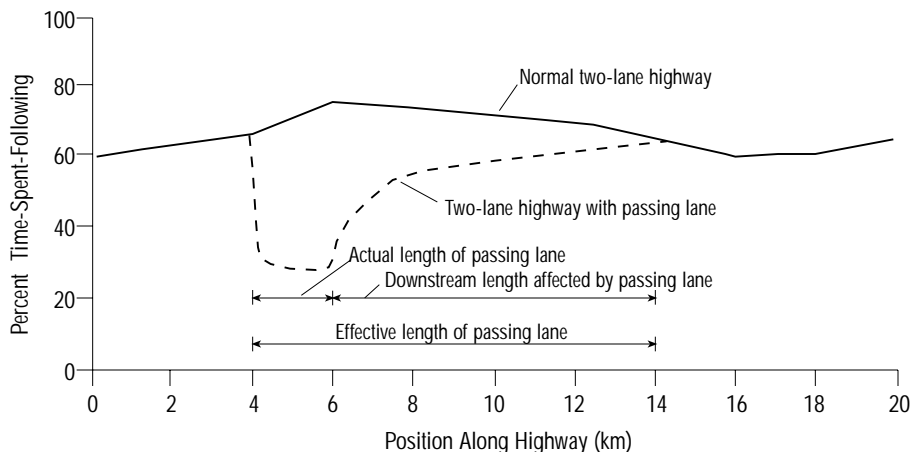

Source: Harwood and Hoban (3).

EXHIBIT 20-23. DOWNSTREAM LENGTH OF ROADWAY AFFECTED BY PASSING LANES ON DIRECTIONAL SEGMENTS IN LEVEL AND ROLLING TERRAIN

Directional Flow Rate (pc/h)	Downstream Length of Roadway Affected, L_{de} (km)	
	Percent Time-Spent-Following	Average Travel Speed
≤ 200	20.9	2.8
400	13.0	2.8
700	9.1	2.8
≥ 1000	5.8	2.8

For complex systems of passing lanes, consider use of a computer simulation model

The operational analysis procedures presented here for passing lanes in level or rolling terrain are applicable to directional segments of two-lane highways that include the entire passing lane. Sections of two-lane highway upstream and downstream of the passing lane also may be included. Whenever possible, the directional segment should

include not only the passing lane but also its full effective downstream length, as indicated in Exhibit 20-23. There are special procedures for directional segments that include only part of the effective downstream length of the passing lane (e.g., when an analysis segment must end because of the proximity of a small town or due to a change in the demand volume). The effects of providing another passing lane in the same direction of travel within the effective length of the first passing lane are too complex to evaluate. In such situations, an evaluation with a traffic simulation model is recommended. The operational analysis procedures for passing lanes in level or rolling terrain are described below.

Analysis of a Directional Segment with a Passing Lane

The first step in the operational analysis of a passing lane is to apply the procedure for directional segments in level or rolling terrain to the normal cross section without the passing lane. The data required are the demand volume in the analysis direction, demand volume in the opposing direction, vehicle mix, lane width, shoulder width, and percentage of no-passing zones. The result is the percent time-spent-following and the average travel speed for the normal two-lane cross section.

Dividing the Segment into Regions

The next step is to divide the analysis segment into four regions. These regions are

1. Upstream of the passing lane,
2. The passing lane,
3. Downstream of the passing lane but within its effective length, and
4. Downstream of the passing lane but beyond its effective length.

These four lengths must add up to the total length of the analysis segment. The analysis regions and their lengths will differ for estimations of percent time-spent-following and average travel speed, because the downstream lengths for these measures differ, as shown in Exhibit 20-23.

The length of the passing lane, L_{pl} , used in the analysis, is either the length of the passing lane as constructed or its planned length. The passing lane length should include the lengths of the lane addition and lane drop tapers. The analysis procedure is calibrated for passing lanes within the optimal ranges of length shown in Chapter 12. Passing lane lengths substantially shorter or longer than the optimum may provide less operational benefit than predicted by this procedure.

The length of the conventional two-lane highway segment upstream of the passing lane, L_u , is determined by the actual or planned placement of the passing lane within the analysis section. The length of the downstream highway segment within the effective length of the passing lane, L_{de} , is determined from Exhibit 20-23. Any remaining length within the analysis segment downstream of the passing lane is included in L_d as shown in Equation 20-18.

$$L_d = L_t - (L_u + L_{pl} + L_{de}) \quad (20-18)$$

where

- L_d = length of two-lane highway downstream of the passing lane and beyond its effective length (km),
- L_t = total length of analysis segment (km),
- L_u = length of two-lane highway upstream of the passing lane (km),
- L_{pl} = length of the passing lane including tapers (km), and
- L_{de} = downstream length of two-lane highway within the effective length of the passing lane (km) (from Exhibit 20-23).

For constraints on applicable lengths of lane additions see Chapter 12, "Highway Concepts"

Determining Percent Time-Spent-Following

Percent time-spent-following within lengths L_u and L_d is assumed to be equal to $PTSF_d$, as predicted by the directional segment procedure. Within the passing lane, percent time-spent-following is generally equal to 58 to 62 percent of its upstream value. This effect varies as a function of the directional flow rate, as shown in Exhibit 20-24. Within the downstream length, L_{de} , percent time-spent-following is assumed to increase linearly with distance from the passing-lane value to its normal upstream value. Thus, the average percent time-spent-following with the passing lane in place can be computed using Equation 20-19.

$$PTSF_{pl} = \frac{PTSF_d \left[L_u + L_d + f_{pl}L_{pl} + \left(\frac{1 + f_{pl}}{2} \right) L_{de} \right]}{L_t} \quad (20-19)$$

where

- $PTSF_{pl}$ = percent time-spent-following for the entire segment including the passing lane,
- $PTSF_d$ = percent time-spent-following for the entire segment without the passing lane from Equation 20-16, and
- f_{pl} = factor for the effect of a passing lane on percent time-spent-following (see Exhibit 20-24).

The variations in percent time-spent-following are shown in Exhibit 20-25.

EXHIBIT 20-24. FACTORS (f_{pl}) FOR ESTIMATION OF AVERAGE TRAVEL SPEED AND PERCENT TIME-SPENT-FOLLOWING WITHIN A PASSING LANE

Directional Flow Rate (pc/h)	Average Travel Speed	Percent Time-Spent-Following
0-300	1.08	0.58
> 300-600	1.10	0.61
> 600	1.11	0.62

EXHIBIT 20-25. EFFECT OF A PASSING LANE ON PERCENT TIME-SPENT-FOLLOWING AS REPRESENTED IN THE OPERATIONAL ANALYSIS METHODOLOGY

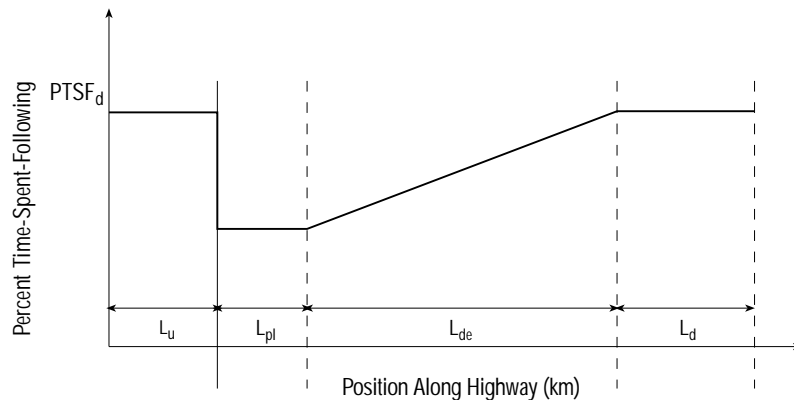

Special case:
downstream effective
length is truncated

If the analysis section is truncated by a town or a major intersection before the full downstream effective length of the passing lane has been reached, then distance L_d is not used and the actual downstream length within the analysis segment, L'_{de} , is less than the value of L_{de} tabulated in Exhibit 20-23. In this case, Equation 20-19 should be replaced

by Equation 20-20. Equation 20-20 applies whenever distance, L_d , computed with Equation 20-8, is negative.

$$PTSF_{pl} = \frac{PTSF_d \left[L_u + f_{pl} L_{pl} + f_{pl} L'_{de} + \left(\frac{1 - f_{pl}}{2} \right) \left(\frac{L'_{de}}{L_{de}} \right)^2 \right]}{L_t} \quad (20-20)$$

where

L'_{de} = actual distance from end of passing lane to end of analysis segment (km). L'_{de} must be less than or equal to the value of L_{de} from Exhibit 20-23.

Determining Average Travel Speed

Average travel speed within lengths L_u and L_d is assumed to equal ATS_d , as predicted by the directional segment procedure. Within the passing lane, average travel speed is generally 8 to 11 percent higher than its upstream value. This effect varies as a function of directional flow rate, as shown in Exhibit 20-24. Within the downstream length, L_{de} , average travel speed is assumed to decrease linearly with distance from the within-passing-lane value to its normal upstream value. Thus, the average travel speed with the passing lane in place can be computed using Equation 20-21.

$$ATS_{pl} = \frac{ATS_d * L_t}{L_u + L_d + \frac{L_{pl}}{f_{pl}} + \frac{2L_{de}}{1 + f_{pl}}} \quad (20-21)$$

where

ATS_{pl} = average travel speed for the entire segment including the passing lane (km/h),
 ATS_d = average travel speed for the entire segment without the passing lane from Equation 20-15 (km/h), and
 f_{pl} = factor for the effect of a passing lane on average travel speed (see Exhibit 20-23).

The variations in average travel speed are shown in Exhibit 20-26. If the analysis section is truncated by the presence of a town or a major intersection before the full downstream effective length of the passing lane has been reached, then distance L_d is not used and the actual downstream length within the analysis segment, L'_{de} , is less than the value of L_{de} tabulated in Exhibit 20-23. In this case, Equation 20-21 should be replaced by Equation 20-22. Equation 20-22 applies whenever distance, L_d , computed with Equation 20-18, is negative.

$$ATS_{pl} = \frac{ATS_d * L_t}{L_u + \frac{L_{pl}}{f_{pl}} + \frac{2L'_{de}}{\left[1 + f_{pl} + (f_{pl} - 1) \frac{L_{de} - L'_{de}}{L_{de}} \right]}} \quad (20-22)$$

Determining LOS

Determining LOS for a directional segment with a passing lane is similar to determining LOS for a directional segment without a passing lane; however, for the passing lane, the values of $PTSF_{pl}$ and ATS_{pl} are used instead of $PTSF_d$ and ATS_d . The LOS for a Class I highway segment with a passing lane is determined by locating the point corresponding to $PTSF_{pl}$ and AST_{pl} in Exhibit 20-3. The LOS for a Class II highway segment with a passing lane is determined by comparing $PTSF_{pl}$ to the LOS

thresholds in Exhibit 20-4. If the directional demand flow rate, v_d , exceeds 1,700 pc/h, the roadway is oversaturated, and the LOS is F. Although a passing lane section with two lanes in the same direction can serve more than 1,700 pc/h, the sections with a single directional lane between passing lanes will be oversaturated and will become bottlenecks.

EXHIBIT 20-26. EFFECT OF A PASSING LANE ON AVERAGE TRAVEL SPEED AS REPRESENTED IN THE OPERATIONAL ANALYSIS METHODOLOGY

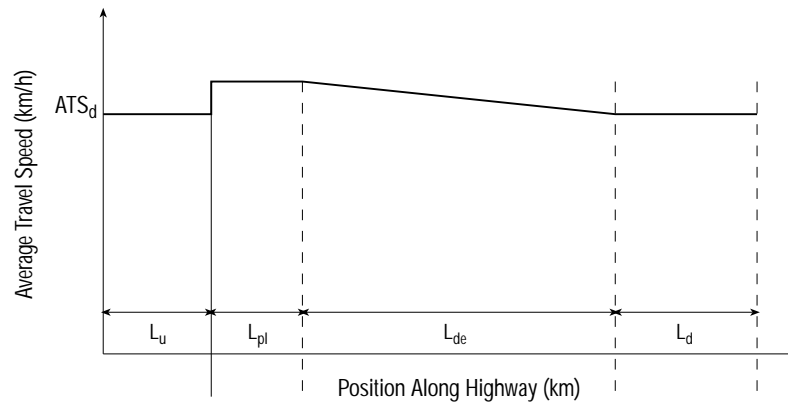

Effects of Passing Lanes on Opposing Traffic

If the installation of a passing lane on a directional segment changes the percentage of no-passing zones for the opposing direction of travel, the directional analysis for the opposing direction must be revised. This can occur, for example, if a highway agency routinely prohibits passing in the opposing direction of travel to a passing lane. However, if passing is permitted in the opposing direction of travel, the passing lane may have little effect on the LOS for the opposing direction. It is possible that a passing lane, by breaking up platoons in one direction of travel, may reduce passing opportunities for the other direction. However, this effect has not been quantified and is not reflected in the operational analysis procedure.

When passing lanes are provided in both directions of travel, the operational analyses for the two directions can proceed independently, unless the addition of the passing lane in one direction substantially changes the percentage of no-passing zones outside the passing lane in the other direction.

DIRECTIONAL SEGMENTS WITH CLIMBING LANES ON UPGRADES

A climbing lane is a passing lane added on an upgrade to allow traffic to pass heavy vehicles whose speeds are reduced. According to the American Association of State Highway and Transportation Officials (AASHTO) *Policy on Geometric Design of Highways and Streets (4)*, climbing lanes on two-lane highway upgrades are warranted when

- The directional flow rate on the upgrade exceeds 200 veh/h,
- The directional flow rate for trucks on the upgrade exceeds 20 veh/h, and
- Any of the following conditions apply: a speed reduction of 15 km/h for a typical heavy truck, LOS E or F on the grade, or a reduction of two or more levels of service from the approach segment to the grade.

The AASHTO policy on climbing lanes directly refers to the LOS determined with the HCM operational analysis procedures. Operational analysis of climbing lanes on specific upgrades can be performed with the same procedures for passing lanes in level and rolling terrain, with two major differences. First, in applying the directional segment procedure to the roadway without the added lane, the grade adjustment factor, f_G , and the heavy-vehicle adjustment factor, f_{HV} , should be the values for specific upgrades. If the

The operational analysis procedure does not address traffic operations on the roadway downstream of a climbing lane beyond the top of the grade. Consider use of a computer simulation model of two-lane highway operations to analyze such segments.

grade on which the lane is added is not sufficiently long or steep to be analyzed as a specific upgrade, then it should be analyzed as a passing lane rather than a climbing lane. Second, the values of the adjustment factors for average travel speed and percent time-spent-following in Exhibit 20-27 should be used instead of those in Exhibit 20-24.

EXHIBIT 20-27. FACTORS (f_{pl}) FOR ESTIMATION OF AVERAGE TRAVEL SPEED AND PERCENT TIME-SPENT-FOLLOWING WITHIN A CLIMBING LANE

Directional Flow Rate (pc/h)	Average Travel Speed	Percent Time-Spent-Following
0-300	1.02	0.20
> 300-600	1.07	0.21
> 600	1.14	0.23

Because climbing lanes are analyzed as part of a specific upgrade, the lengths L_u and L_d used in Equations 20-19 through 20-22 generally equal zero. The downstream effective length, L_{de} , also generally equals zero unless the climbing lane ends before the top of the grade. In this case, a value of L_{de} shorter than the values shown in Exhibit 20-23 should be considered.

LOS ASSESSMENT FOR DIRECTIONAL TWO-LANE FACILITIES

A directional two-lane highway facility is a series of contiguous directional two-lane highway segments. If an operational analysis has been conducted for each segment in the series, the results can be combined to obtain an operational assessment of the facility as a whole. The same approach can be used to combine operational results from directional segments in the opposing directions of travel on a two-lane highway. In either case, the applicable LOS criteria are shown in Exhibits 20-3 and 20-4 for Class I and II highways, respectively.

The combined percent time-spent-following for several directional segments can be determined by Equation 20-23.

$$PTSF_c = \frac{TT_1 * PTSF_1 + TT_2 * PTSF_2 + \dots + TT_n * PTSF_n}{TT_1 + TT_2 + \dots + TT_n} \quad (20-23)$$

where

- $PTSF_c$ = percent time-spent-following for all segments combined,
- TT_x = total travel time (veh-h) for Segment x (determined from Equation 20-11), and
- $PTSF_x$ = percent time-spent-following for Segment x.

The combined average travel speed for several directional segments can be determined using Equation 20-24.

$$ATS_c = \frac{VkmT_1 + VkmT_2 + \dots + VkmT_n}{TT_1 + TT_2 + \dots + TT_n} \quad (20-24)$$

where

- ATS_c = average travel speed for all segments combined (km/h) and
- $VkmT_x$ = total travel for Segment x, determined from Equation 20-9 (veh-km).

LOS ASSESSMENT FOR UNINTERRUPTED-FLOW FACILITIES AND CORRIDORS WITH TWO-LANE HIGHWAYS

A directional analysis procedure has been provided in this chapter so that operational analysis results for directional segments on two-lane facilities can be combined readily with results for interrupted-flow facilities, including multilane highways (see Chapter 21) and basic freeway segments (see Chapter 23). Operational analysis across different types

Results from individual segments may be combined

Guidelines on required inputs and estimated values are in Chapter 12, "Highway Concepts"

of uninterrupted-flow facilities should be based solely on average travel speed, because percent time-spent-following generally is a consideration only for two-lane highways. Equations 20-20, 20-21, and 20-22 can be used to combine estimates of average travel speed from segments on different types of facilities.

III. APPLICATIONS

The methodology of this chapter can be used to analyze the capacity and LOS of two-lane highways. The analyst must address two fundamental questions. First, what is the primary output? Primary outputs typically solved for in a variety of applications include LOS and achievable flow rate (v_p). Performance measures related to average travel speed (ATS) and percent time-spent-following (PTSF) are also achievable but are secondary.

Second, what are the default values or estimated values for use in the analysis? Basically, there are three sources of input data:

1. Default values found in this manual,
2. Estimates and locally derived default values developed by the user, and
3. Values derived from field measurements and observation.

For each of the input variables, a value must be supplied to calculate the primary and secondary outputs.

A common application of the method is to compute the LOS of a current or a changed facility in the near term or in the future. This type of application is often termed operational, and its primary output is LOS, with secondary outputs for ATS and PTSF. The achievable flow rate, v_p , can be solved for as the primary output. This analysis requires a LOS goal and geometric data as inputs for estimating when a flow rate will be exceeded, causing the highway to operate at an unacceptable LOS. Using the methodology to determine the number of lanes required (known as a design application in this manual) is of course not necessary for two-lane highways. Modifications to grade, alignment, and cross section, however, can improve the operational efficiency of a two-lane facility. Computational examples are provided for two design-related applications—the addition of a passing or climbing lane to a two-lane highway and the addition of through lanes to convert a two-lane highway to a four-lane highway. The latter example involves a comparison of results obtained from this chapter with results obtained from Chapter 21, "Multilane Highways."

Another general type of analysis is the planning analysis, which uses estimates, HCM default values, and local default values as inputs. As outputs, LOS or flow rate can be determined along with the secondary outputs of average travel speed and percent time-spent-following. The difference between this type of analysis and operational analysis is that most or all of the input values come from estimates or default values, while the operational analyses use field-measured values or known values.

COMPUTATIONAL STEPS

The worksheet for two-way, two-lane highway segment computations is shown in Exhibit 20-28. The worksheets for directional two-lane highway segments with or without a passing lane are included in Appendix B. For all applications, the analyst provides general information and site information.

For operational (LOS) analysis, the analyst inputs all the required data. For estimating average travel speed, equivalent flow is computed with the aid of exhibits for passenger-car equivalencies. FFS is estimated by applying adjustments to the base FFS. Then average travel speed is estimated. Similarly, equivalent flow is estimated by using passenger-car equivalency exhibits to estimate percent time-spent-following. Percent

Operational (LOS) analysis

time-spent-following is estimated by adjusting the base percent time-spent-following value for the percentage of no-passing zones. Finally, LOS is determined by average travel speed, percent time-spent-following, or both, depending on the highway classification.

EXHIBIT 20-28. TWO-WAY TWO-LANE HIGHWAY SEGMENT WORKSHEET

TWO-WAY TWO-LANE HIGHWAY SEGMENT WORKSHEET	
General Information	Site Information
Analyst _____	Highway _____
Agency or Company _____	From/To _____
Date Performed _____	Jurisdiction _____
Analysis Time Period _____	Analysis Year _____
<input type="checkbox"/> Operational (LOS)	<input type="checkbox"/> Design (v_p)
<input type="checkbox"/> Planning (LOS)	<input type="checkbox"/> Planning (v_p)
Input Data	
<p style="text-align: center;">Shoulder width _____ m Lane width _____ m Lane width _____ m Shoulder width _____ m Segment length, L_1 _____ km</p>	<input type="checkbox"/> Class I highway <input type="checkbox"/> Class II highway Terrain <input type="checkbox"/> Level <input type="checkbox"/> Rolling Two-way hourly volume _____ veh/h Directional split _____ / _____ Peak-hour factor, PHF _____ % Trucks and buses, P_T _____ % % Recreational vehicles, P_R _____ % % No-passing zone _____ % Access points/km _____ /km
Average Travel Speed	
Grade adjustment factor, f_G (Exhibit 20-7) _____	
Passenger-car equivalents for trucks, E_T (Exhibit 20-9) _____	
Passenger-car equivalents for RVs, E_R (Exhibit 20-9) _____	
Heavy-vehicle adjustment factor, f_{HV} $f_{HV} = \frac{1}{1 + P_T(E_T - 1) + P_R(E_R - 1)}$ _____	
Two-way flow rate, ¹ v_p (pc/h) $v_p = \frac{V}{PHF \cdot f_G \cdot f_{HV}}$ _____	
v_p * highest directional split proportion ² (pc/h) _____	
Free-Flow Speed from Field Measurement	Estimated Free-Flow Speed
Field measured speed, S_{FM} _____ km/h	Base free-flow speed, BFFS _____ km/h
Observed volume, V_f _____ veh/h	Adj. for lane width and shoulder width, f_{LS} (Exhibit 20-5) _____ km/h
Free-flow speed, FFS _____ km/h	Adj. for access points, f_A (Exhibit 20-6) _____ km/h
$FFS = S_{FM} + 0.0125 \left(\frac{V_f}{f_{HV}} \right)$ _____ km/h	Free-flow speed, FFS _____ km/h
	$FFS = BFFS - f_{LS} - f_A$
Adj. for no-passing zones, f_{np} (km/h) (Exhibit 20-11) _____	
Average travel speed, ATS (km/h) $ATS = FFS - 0.0125v_p - f_{np}$ _____	
Percent Time-Spent-Following	
Grade adjustment factor, f_G (Exhibit 20-8) _____	
Passenger-car equivalents for trucks, E_T (Exhibit 20-10) _____	
Passenger-car equivalents for RVs, E_R (Exhibit 20-10) _____	
Heavy-vehicle adjustment factor, f_{HV} $f_{HV} = \frac{1}{1 + P_T(E_T - 1) + P_R(E_R - 1)}$ _____	
Two-way flow rate, ¹ v_p (pc/h) $v_p = \frac{V}{PHF \cdot f_G \cdot f_{HV}}$ _____	
v_p * highest directional split proportion ² (pc/h) _____	
Base percent time-spent-following, BPTSF (%) $BPTSF = 100(1 - e^{-0.000879v_p})$ _____	
Adj. for directional distribution and no-passing zone, $f_{d/np}$ (%) (Exhibit 20-12) _____	
Percent time-spent-following, PTSF (%) $PTSF = BPTSF + f_{d/np}$ _____	
Level of Service and Other Performance Measures	
Level of service, LOS (Exhibit 20-3 for Class I or 20-4 for Class II) _____	
Volume to capacity ratio, v/c $v/c = \frac{v_p}{3,200}$ _____	
Peak 15-min vehicle-kilometers of travel, $VkmT_{15}$ (veh-km) $VkmT_{15} = 0.25L_1 \left(\frac{V}{PHF} \right)$ _____	
Peak-hour vehicle-kilometers of travel, $VkmT_{60}$ (veh-km) $VkmT_{60} = V \cdot L_1$ _____	
Peak 15-min total travel time, TT_{15} (veh-h) $TT_{15} = \frac{VkmT_{15}}{ATS}$ _____	
Notes	
1. If $v_p \geq 3,200$ pc/h, terminate analysis—the LOS is F.	
2. If highest directional split $v_p \geq 1,700$ pc/h, terminate analysis—the LOS is F.	

Design (v_p) analysis

The objective of design (v_p) analysis is to estimate the flow rate in passenger cars per hour given a set of traffic, roadway, and FFS conditions. A desired LOS is stated and entered in the worksheet. Then a flow rate is assumed and the procedure for operational (LOS) analysis is performed. This computed LOS is then compared with the desired LOS. If the desired LOS is not met, another flow rate is assumed. This iteration continues until the maximum flow rate for the desired LOS is achieved.

Planning (LOS) and planning (v_p) analyses

PLANNING APPLICATIONS

The two planning applications, planning for LOS and for v_p , correspond directly to the procedures for operational and design analyses. The criterion that categorizes these as planning applications is the use of estimates, HCM default values, and local default values as inputs. Another characteristic of a planning application is the use of annual average daily traffic (AADT) to estimate directional design-hour volume (DDHV). For guidelines in computing DDHV, see Chapter 8. Chapter 12 also lists the required data and estimated values to perform a planning application.

ANALYSIS TOOLS

Worksheets for two-way, directional, and directional with passing lane segments are provided in Appendix B. These worksheets can be used to perform operational (LOS), design (v_p), planning (LOS), and planning (v_p) analyses.

IV. EXAMPLE PROBLEMS

Problem No.	Description	Application
1	Find the two-way LOS of a Class I two-lane highway	Operational (LOS)
2	Find the two-way LOS of a Class II two-lane highway	Operational (LOS)
3	Find the directional LOS of a Class I two-lane highway	Operational (LOS)
4	Find the directional LOS of a Class I two-lane highway including a passing lane	Operational (LOS)

EXAMPLE PROBLEM 1

The Highway A Class I two-lane highway segment.

The Question What is the two-way segment LOS for the peak hour?

The Facts

- √ 1,600 veh/h (two-way volume),
- √ 14 percent trucks and buses,
- √ 0.95 PHF,
- √ Rolling terrain,
- √ 1.2-m shoulder width,
- √ 50 percent no-passing zones,
- √ 50/50 directional split,
- √ 4 percent RVs,
- √ 100-km/h base FFS,
- √ 3.4-m lane width,
- √ 10-km length, and
- √ 12 access points/km.

Outline of Solution Two-way average travel speed and percent time-spent-following will be determined, and from these parameters, the LOS.

Steps

1. Determine grade adjustment factor for average travel speed (use Exhibit 20-7).	$f_G = 0.99$
2. Compute f_{HV} for average travel speed (use Exhibit 20-9 and Equation 20-4).	$f_{HV} = \frac{1}{1 + P_T(E_T - 1) + P_R(E_R - 1)}$ $f_{HV} = \frac{1}{1 + 0.14(1.5 - 1) + 0.04(1.1 - 1)} = 0.931$
3. Compute v_p (use Equation 20-3).	$v_p = \frac{V}{PHF * f_G * f_{HV}}$ $v_p = \frac{1,600}{(0.95)(0.99)(0.931)} = 1,827 \text{ pc/h}$
4. Calculate highest directional flow rate.	$v_p * 0.50 = 1,827 * 0.50 = 914 \text{ pc/h}$
5. Check the highest directional flow rate and two-way flow rate against capacity values of 1,700 pc/h and 3,200 pc/h, respectively.	$914 \text{ pc/h} < 1,700 \text{ pc/h}$ $1,827 \text{ pc/h} < 3,200 \text{ pc/h}$
6. Compute the FFS (use Exhibits 20-5 and 20-6 and Equation 20-2).	$FFS = BFFS - f_{LS} - f_A$ $FFS = 100 - 2.8 - 8.0 = 89.2 \text{ km/h}$
7. Compute the average travel speed (use Exhibit 20-11 and Equation 20-5).	$ATS = FFS - 0.0125v_p - f_{np}$ $ATS = 89.2 - 0.0125(1827) - 1.3 = 65.1 \text{ km/h}$
8. Determine grade adjustment factor for percent time-spent-following (use Exhibit 20-8).	$f_G = 1.00$
9. Compute f_{HV} for time-spent-following (use Exhibit 20-10 and Equation 20-4).	$f_{HV} = \frac{1}{1 + 0.14(1.0 - 1) + 0.04(1.0 - 1)} = 1.000$
10. Compute v_p (use Equation 20-3).	$v_p = \frac{1,600}{(0.95)(1.000)(1.00)} = 1,684 \text{ pc/h}$
11. Calculate the highest directional flow rate.	$v_p * 0.50 = 1,684 * 0.50 = 842 \text{ pc/h}$
12. Check the highest directional flow rate and two-way flow rate against the capacity values of 1,700 pc/h and 3,200 pc/h, respectively.	$842 \text{ pc/h} < 1,700 \text{ pc/h}$ $1,684 \text{ pc/h} < 3,200 \text{ pc/h}$

13. Compute base percent time-spent-following (use Equation 20-7).	$\text{BPTSF} = 100 \left(1 - e^{-0.000879 v_p} \right)$ $\text{BPTSF} = 100 \left[1 - e^{-0.000879(1,684)} \right] = 77.2\%$
14. Compute percent time-spent-following (use Exhibit 20-12 and Equation 20-6).	$\text{PTSF} = \text{BPTSF} + f_{d/\eta_p}$ $\text{PTSF} = 77.2 + 4.8 = 82.0\%$
15. Determine LOS (use Exhibit 20-3).	ATS = 65.1 km/h and PTSF = 82.0% LOS E

Results The two-lane highway operates at LOS E.

Other Performance Measures

$$v/c = \frac{v_p}{3,200} = \frac{1,827}{3,200} = 0.57$$

$$\text{VkmT}_{15} = 0.25 L_t \left(\frac{V}{\text{PHF}} \right) = 0.25(10) \left(\frac{1,600}{0.95} \right) = 4,211 \text{ veh-km}$$

$$\text{VkmT}_{60} = V * L_t = (1,600)(10) = 16,000 \text{ veh-km}$$

$$\text{TT}_{15} = \frac{\text{VkmT}_{15}}{\text{ATS}} = \frac{4,211}{65.1} = 64.7 \text{ veh-h}$$

Example Problem 1

TWO-WAY TWO-LANE HIGHWAY SEGMENT WORKSHEET	
General Information	Site Information
Analyst <u>M.E.</u>	Highway <u>US 391</u>
Agency or Company <u>CEI</u>	From/To <u>SR-33/Adams Rd.</u>
Date Performed <u>5/20/99</u>	Jurisdiction _____
Analysis Time Period _____	Analysis Year <u>1999</u>
<input checked="" type="checkbox"/> Operational (LOS)	<input type="checkbox"/> Design (v _p)
<input type="checkbox"/> Planning (LOS)	<input type="checkbox"/> Planning (v _p)
Input Data	
	<input checked="" type="checkbox"/> Class I highway <input type="checkbox"/> Class II highway Terrain <input type="checkbox"/> Level <input checked="" type="checkbox"/> Rolling Two-way hourly volume <u>1,600</u> veh/h Directional split <u>50</u> / <u>50</u> Peak-hour factor, PHF <u>0.95</u> % Trucks and buses, P _T <u>14</u> % % Recreational vehicles, P _R <u>4</u> % % No-passing zone <u>50</u> % Access points/km <u>12</u> /km
Average Travel Speed	
Grade adjustment factor, f _G (Exhibit 20-7)	0.99
Passenger-car equivalents for trucks, E _T (Exhibit 20-9)	1.5
Passenger-car equivalents for RVs, E _R (Exhibit 20-9)	1.1
Heavy-vehicle adjustment factor, f _{HV} $f_{HV} = \frac{1}{1 + P_T(E_T - 1) + P_R(E_R - 1)}$	0.931
Two-way flow rate, ¹ v _p (pc/h) $v_p = \frac{V}{PHF \cdot f_G \cdot f_{HV}}$	1,827
v _p * highest directional split proportion ² (pc/h)	914
Free-Flow Speed from Field Measurement	Estimated Free-Flow Speed
Field measured speed, S _{FM} _____ km/h	Base free-flow speed, BFFS <u>100</u> km/h
Observed volume, V _f _____ veh/h	Adj. for lane width and shoulder width, f _{LS} (Exhibit 20-5) <u>2.8</u> km/h
Free-flow speed, FFS _____ km/h	Adj. for access points, f _A (Exhibit 20-6) <u>8.0</u> km/h
FFS = S _{FM} + 0.0125 $\left(\frac{V_f}{f_{HV}}\right)$	Free-flow speed, FFS <u>89.2</u> km/h
	FFS = BFFS - f _{LS} - f _A
Adj. for no-passing zones, f _{np} (km/h) (Exhibit 20-11)	1.3
Average travel speed, ATS (km/h) $ATS = FFS - 0.0125v_p - f_{np}$	65.1
Percent Time-Spent-Following	
Grade adjustment factor, f _G (Exhibit 20-8)	1.00
Passenger-car equivalents for trucks, E _T (Exhibit 20-10)	1.0
Passenger-car equivalents for RVs, E _R (Exhibit 20-10)	1.0
Heavy-vehicle adjustment factor, f _{HV} $f_{HV} = \frac{1}{1 + P_T(E_T - 1) + P_R(E_R - 1)}$	1.000
Two-way flow rate, ¹ v _p (pc/h) $v_p = \frac{V}{PHF \cdot f_G \cdot f_{HV}}$	1,684
v _p * highest directional split proportion ² (pc/h)	842
Base percent time-spent-following, BPTSF (%) BPTSF = 100(1 - e ^{-0.000879v_p})	77.2
Adj. for directional distribution and no-passing zone, f _{d/np} (%) (Exhibit 20-12)	4.8
Percent time-spent-following, PTSF (%) $PTSF = BPTSF + f_{d/np}$	82.0
Level of Service and Other Performance Measures	
Level of service, LOS (Exhibit 20-3 for Class I or 20-4 for Class II)	E
Volume to capacity ratio, v/c $v/c = \frac{v_p}{3,200}$	0.57
Peak 15-min vehicle-kilometers of travel, VkmT ₁₅ (veh-km) VkmT ₁₅ = 0.25L _L $\left(\frac{V}{PHF}\right)$	4,211
Peak-hour vehicle-kilometers of travel, VkmT ₆₀ (veh-km) $VkmT_{60} = V * L_L$	16,000
Peak 15-min total travel time, TT ₁₅ (veh-h) $TT_{15} = \frac{VkmT_{15}}{ATS}$	64.7
Notes	
1. If v _p ≥ 3,200 pc/h, terminate analysis—the LOS is F.	
2. If highest directional split v _p ≥ 1,700 pc/h, terminate analysis—the LOS is F.	

EXAMPLE PROBLEM 2

The Highway A Class II two-lane highway segment on a scenic and recreational route.

The Question What is the two-way segment LOS?

The Facts

- √ 1,050 veh/h (two-way volume),
- √ 5 percent trucks and buses,
- √ 0.85 PHF,
- √ Rolling terrain,
- √ 0.6-m shoulder width,
- √ 60 percent no-passing zones,
- √ 70/30 directional split,
- √ 7 percent RVs,
- √ 90-km/h base FFS,
- √ 3.0-m lane width,
- √ 10-km roadway length, and
- √ 6 access points/km.

Outline of Solution Two-way average travel speed and percent time-spent-following will be determined, and with these parameters, the LOS. Since $V/PHF = 1,050/0.85 = 1,235$, select truck equivalencies and grade adjustment factors for flow rates greater than 1,200 pc/h.

Steps

1. Determine grade adjustment factor for average travel speed (use Exhibit 20-7).	$f_G = 0.99$
2. Compute f_{HV} for average travel speed (use Exhibit 20-9 and Equation 20-4).	$f_{HV} = \frac{1}{1 + P_T(E_T - 1) + P_R(E_R - 1)}$ $f_{HV} = \frac{1}{1 + 0.05(1.5 - 1) + 0.07(1.1 - 1)} = 0.969$
3. Compute v_p (use Equation 20-3).	$v_p = \frac{V}{PHF * f_G * f_{HV}}$ $v_p = \frac{1,050}{(0.85)(0.99)(0.969)} = 1,288 \text{ pc/h}$
4. Calculate the highest directional flow rate.	$v_p * 0.70 = 1,288 * 0.70 = 902 \text{ pc/h}$
5. Check the highest directional flow rate and two-way flow rate against capacity values of 1,700 pc/h and 3,200 pc/h, respectively.	$902 \text{ pc/h} < 1,700 \text{ pc/h}$ $1,288 \text{ pc/h} < 3,200 \text{ pc/h}$
6. Compute FFS (use Exhibit 20-5 and 20-6 and Equation 20-2).	$FFS = BFFS - f_{LS} - f_A$ $FFS = 90 - 5.9 - 4.0 = 80.1 \text{ km/h}$
7. Compute ATS (use Exhibit 20-11 and Equation 20-5).	$ATS = FFS - 0.0125v_p - f_{np}$ $ATS = 80.1 - 0.0125(1288) - 2.3 = 61.7 \text{ km/h}$
8. Determine grade adjustment factor of percent time-spent-following (use Exhibit 20-8).	$f_G = 1.00$
9. Compute f_{HV} for percent time-spent-following (use Exhibit 20-10 and Equation 20-4).	$f_{HV} = \frac{1}{1 + 0.05(1.0 - 1) + 0.07(1.0 - 1)} = 1.000$
10. Compute v_p (use Equation 20-3).	$v_p = \frac{1,050}{(0.85)(1.000)(1.00)} = 1,235 \text{ pc/h}$
11. Calculate the highest directional flow rate.	$v_p * 0.70 = 1,235 * 0.70 = 865 \text{ pc/h}$

12. Check the highest directional flow rate and two-way flow rate against the capacity values of 1,700 pc/h and 3,200 pc/h, respectively.	865 pc/h < 1,700 pc/h 1,235 pc/h < 3,200 pc/h
13. Compute base percent time-spent-following (use Equation 20-7).	$BPTSF = 100 \left(1 - e^{-0.000879 v_p} \right)$ $BPTSF = 100 \left[1 - e^{-0.000879(1,235)} \right] = 66.2\%$
14. Compute percent time-spent-following (use Exhibit 20-12 and Equation 20-6).	$PTSF = BPTSF + f_{d/n_p}$ $PTSF = 66.2 + 9.0 = 75.2\%$
15. Determine LOS (use Exhibit 20-4).	PTSF = 75.2% LOS D

Results The two-lane highway operates at LOS D.

Other Performance Measures

$$v/c = \frac{v_p}{3,200} = \frac{1,288}{3,200} = 0.40$$

$$VkmT_{15} = 0.25L_t \left(\frac{V}{PHF} \right) = 0.25(10) \left(\frac{1,050}{0.85} \right) = 3,088 \text{ veh-km}$$

$$VkmT_{60} = V * L_t = (1,050)(10) = 10,500 \text{ veh-km}$$

$$TT_{15} = \frac{VkmT_{15}}{ATS} = \frac{3,088}{61.7} = 50.0 \text{ veh-h}$$

Example Problem 2

TWO-WAY TWO-LANE HIGHWAY SEGMENT WORKSHEET	
General Information	Site Information
Analyst <u>M.E.</u>	Highway <u>State Highway 34</u>
Agency or Company <u>CEI</u>	From/To <u>US 24/Creek Rd.</u>
Date Performed <u>5/20/99</u>	Jurisdiction _____
Analysis Time Period _____	Analysis Year <u>1999</u>
<input checked="" type="checkbox"/> Operational (LOS)	<input type="checkbox"/> Design (v_p)
<input type="checkbox"/> Planning (LOS)	<input type="checkbox"/> Planning (v_p)
Input Data	
	<input type="checkbox"/> Class I highway <input checked="" type="checkbox"/> Class II highway Terrain <input type="checkbox"/> Level <input checked="" type="checkbox"/> Rolling Two-way hourly volume <u>1,050</u> veh/h Directional split <u>70</u> / <u>30</u> Peak-hour factor, PHF <u>0.85</u> % Trucks and buses, P_T <u>5</u> % % Recreational vehicles, P_R <u>7</u> % % No-passing zone <u>60</u> % Access points/km <u>6</u> /km
Average Travel Speed	
Grade adjustment factor, f_G (Exhibit 20-7)	0.99
Passenger-car equivalents for trucks, E_T (Exhibit 20-9)	1.5
Passenger-car equivalents for RVs, E_R (Exhibit 20-9)	1.1
Heavy-vehicle adjustment factor, f_{HV} $f_{HV} = \frac{1}{1 + P_T(E_T - 1) + P_R(E_R - 1)}$	0.969
Two-way flow rate, v_p (pc/h) $v_p = \frac{V}{PHF \cdot f_G \cdot f_{HV}}$	1,288
v_p * highest directional split proportion ² (pc/h)	902
Free-Flow Speed from Field Measurement	Estimated Free-Flow Speed
Field measured speed, S_{FM} _____ km/h	Base free-flow speed, BFFS <u>90</u> km/h
Observed volume, V_f _____ veh/h	Adj. for lane width and shoulder width, f_{LS} (Exhibit 20-5) <u>5.9</u> km/h
Free-flow speed, FFS _____ km/h	Adj. for access points, f_A (Exhibit 20-6) <u>4.0</u> km/h
$FFS = S_{FM} + 0.0125 \left(\frac{V_f}{f_{HV}} \right)$	Free-flow speed, FFS <u>80.1</u> km/h
	$FFS = BFFS - f_{LS} - f_A$
Adj. for no-passing zones, f_{np} (km/h) (Exhibit 20-11)	2.3
Average travel speed, ATS (km/h) $ATS = FFS - 0.0125v_p - f_{np}$	61.7
Percent Time-Spent-Following	
Grade adjustment factor, f_G (Exhibit 20-8)	1.00
Passenger-car equivalents for trucks, E_T (Exhibit 20-10)	1.0
Passenger-car equivalents for RVs, E_R (Exhibit 20-10)	1.0
Heavy-vehicle adjustment factor, f_{HV} $f_{HV} = \frac{1}{1 + P_T(E_T - 1) + P_R(E_R - 1)}$	1.000
Two-way flow rate, v_p (pc/h) $v_p = \frac{V}{PHF \cdot f_G \cdot f_{HV}}$	1,235
v_p * highest directional split proportion ² (pc/h)	865
Base percent time-spent-following, BPTSF (%) $BPTSF = 100(1 - e^{-0.000879v_p})$	66.2
Adj. for directional distribution and no-passing zone, $f_{d/np}$ (%) (Exhibit 20-12)	9.0
Percent time-spent-following, PTSF (%) $PTSF = BPTSF + f_{d/np}$	75.2
Level of Service and Other Performance Measures	
Level of service, LOS (Exhibit 20-3 for Class I or 20-4 for Class II)	D
Volume to capacity ratio, v/c $v/c = \frac{v_p}{3,200}$	0.40
Peak 15-min vehicle-kilometers of travel, $VkmT_{15}$ (veh-km) $VkmT_{15} = 0.25L \left(\frac{V}{PHF} \right)$	3,088
Peak-hour vehicle-kilometers of travel, $VkmT_{60}$ (veh-km) $VkmT_{60} = V * L_t$	10,500
Peak 15-min total travel time, TT_{15} (veh-h) $TT_{15} = \frac{VkmT_{15}}{ATS}$	50.0
Notes	
1. If $v_p \geq 3,200$ pc/h, terminate analysis—the LOS is F. 2. If highest directional split $v_p \geq 1,700$ pc/h, terminate analysis—the LOS is F.	

EXAMPLE PROBLEM 3

The Highway A Class I two-lane highway segment.

The Question What is the LOS of the peak direction?

The Facts

- √ 1,200 veh/h (analysis direction volume),
- √ 14 percent trucks and buses,
- √ 4 percent RVs,
- √ 100-km/h base FFS,
- √ 3.3-m lane width,
- √ 10-km roadway length,
- √ 12 access points/km,
- √ 400 veh/h (opposing direction volume),
- √ 0.95 PHF,
- √ Rolling terrain,
- √ 1.2-m shoulder width, and
- √ 50 percent no-passing zones.

Outline of Solution Analysis direction average travel speed and percent time-spent-following will be determined, and with these parameters, the LOS.

Steps

1. Determine the grade adjustment factor, f_G , for average travel speed for the analysis direction (use Exhibit 20-7).	$f_G = 0.99$
2. Compute f_{HV} and v_d for average travel speed in the analysis direction (use Exhibit 20-9 and Equations 20-4 and 20-12).	$f_{HV} = \frac{1}{1 + 0.14(1.5 - 1) + 0.04(1.1 - 1)} = 0.931$ $v_d = \frac{1,200}{(0.95)(0.99)(0.931)} = 1,370 \text{ pc/h}$
3. Determine the grade adjustment factor, f_G , for average travel speed for the opposing direction (use Exhibit 20-7).	$f_G = 0.93$
4. Compute f_{HV} and v_o for average travel speed in the opposing direction (use Exhibit 20-9 and Equations 20-4 and 20-13).	$f_{HV} = \frac{1}{1 + 0.14(1.9 - 1) + 0.04(1.1 - 1)} = 0.885$ $v_o = \frac{400}{(0.95)(0.93)(0.885)} = 512 \text{ pc/h}$
5. Check v_d and v_o with the capacity value of 1,700 pc/h.	$1,370 \text{ pc/h} < 1,700 \text{ pc/h}$ $512 \text{ pc/h} < 1,700 \text{ pc/h}$
6. Compute FFS (use Exhibits 20-5 and 20-6, and Equation 20-2).	$FFS = BFFS - f_{LS} - f_A$ $FFS = 100 - 2.8 - 8.0 = 89.2 \text{ km/h}$
7. Compute average travel speed (use Exhibit 20-19 and Equation 20-15).	$ATS_d = FFS_d - 0.0125(v_d + v_o) - f_{np}$ $ATS_d = 89.2 - 0.0125(1370 + 512) - 2.7 = 63.0 \text{ km/h}$
8. Determine the grade adjustment factor, f_G , for percent time-spent-following for the analysis direction (use Exhibit 20-8).	$f_G = 1.00$
9. Compute f_{HV} and v_d for percent time-spent-following in the analysis direction (use Exhibit 20-10 and Equations 20-4 and 20-12).	$f_{HV} = \frac{1}{1 + 0.14(1.0 - 1) + 0.04(1.0 - 1)} = 1.000$ $v_d = \frac{1,200}{(0.95)(1.00)(1.000)} = 1,263 \text{ pc/h}$
10. Determine the grade adjustment factor, f_G , for percent time-spent-following for the opposing direction (use Exhibit 20-8).	$f_G = 0.94$

11. Compute f_{HV} and v_o for percent time-spent-following in the opposing direction (use Exhibit 20-10 and Equations 20-4 and 20-14).	$f_{HV} = \frac{1}{1 + 0.14(1.5 - 1) + 0.04(1.0 - 1)} = 0.935$ $v_o = \frac{400}{(0.95)(0.94)(0.935)} = 479 \text{ pc/h}$
12. Check v_d and v_o against the capacity value of 1,700 pc/h.	$1,263 \text{ pc/h} < 1,700 \text{ pc/h}$ $479 \text{ pc/h} < 1,700 \text{ pc/h}$
13. Compute base percent time-spent-following the analysis direction (use Exhibit 20-21 and Equation 20-17).	$BPTSF_d = 100 \left(1 - e^{av_d^b} \right)$ $BPTSF_d = 100 \left[1 - e^{(-0.074)(1,263)^{0.453}} \right] = 84.7\%$
14. Compute percent time-spent-following for the analysis direction (use Exhibit 20-20 and Equation 20-16).	$PTSF_d = BPTSF_d + f_{np}$ $PTSF_d = 84.7 + 11.7 = 96.4\%$
15. Determine LOS (use Exhibit 20-3).	$ATS_d = 63.0 \text{ km/h and } PTSF_d = 96.4\%$ <p>LOS E</p>

Results The two-lane highway operates at LOS E in the analysis direction.

Other Performance Measures

$$v/c = \frac{v_d}{1,700} = \frac{1,370}{1,700} = 0.81$$

$$VkmT_{15} = 0.25L_t \left(\frac{V_d}{PHF} \right) = 0.25(10) \left(\frac{1,200}{0.95} \right) = 3,158 \text{ veh-km}$$

$$VkmT_{60} = V_d * L_t = (1,200)(10) = 12,000 \text{ veh-km}$$

$$TT_{15} = \frac{VkmT_{15}}{ATS_d} = \frac{3,158}{63.0} = 50.1 \text{ veh-h}$$

Example Problem 3

DIRECTIONAL TWO-LANE HIGHWAY SEGMENT WORKSHEET		
General Information		Site Information
Analyst	M.E.	Highway/Direction of Travel
Agency or Company	CEI	From/To
Date Performed	5/20/99	Jurisdiction
Analysis Time Period		Analysis Year
<input checked="" type="checkbox"/> Operational (LOS)		<input type="checkbox"/> Design (v_p)
		<input type="checkbox"/> Planning (LOS)
		<input type="checkbox"/> Planning (v_p)
Input Data		
		<input checked="" type="checkbox"/> Class I highway <input type="checkbox"/> Class II highway Terrain <input type="checkbox"/> Level <input checked="" type="checkbox"/> Rolling Grade Length _____ km Up/down _____ % Peak-hour factor, PHF _____ % Trucks and buses, P_T _____ % % Recreational vehicles, P_R _____ % % No-passing zone _____ % Access points/km _____ /km
Analysis direction volume, V_d 1,200 veh/h		Opposing direction volume, V_o 400 veh/h
Average Travel Speed		
	Analysis Direction (d)	Opposing Direction (o)
Passenger-car equivalent for trucks, E_T (Exhibit 20-9 or 20-15)	1.5	1.9
Passenger-car equivalent for RVs, E_R (Exhibit 20-9 or 20-17)	1.1	1.1
Heavy-vehicle adjustment factor, ⁵ f_{HV} $f_{HV} = \frac{1}{1 + P_T(E_T - 1) + P_R(E_R - 1)}$	0.931	0.885
Grade adjustment factor, ¹ f_G (Exhibit 20-6 or 20-12)	0.99	0.93
Directional flow rate, ² v_i (pc/h) $v_i = \frac{V_i}{PHF \cdot f_{HV} \cdot f_G}$	1,370	512
Free-Flow Speed from Field Measurement		Estimated Free-Flow Speed
Field measured speed, ³ S_{FM} _____ km/h	Base free-flow speed, ³ BFFS _____ km/h	
Observed volume, ³ V_i _____ veh/h	Adj. for lane width and shoulder width, ³ f_{LS} (Exh. 20-5) 2.8 km/h	
Free-flow speed, FFS _d _____ km/h	Adj. for access points, ³ f_A (Exhibit 20-6) 8.0 km/h	
$FFS_d = S_{FM} + 0.0125 \left(\frac{V_i}{f_{HV}} \right)$	Free-flow speed, FFS _d 89.2 km/h	
	$FFS_d = BFFS - f_{LS} - f_A$	
Adjustment for no-passing zones, f_{np} (km/h) (Exhibit 20-19)	2.7	
Average travel speed, ATS_d (km/h) $ATS_d = FFS_d - 0.0125(v_d + v_o) - f_{np}$	63.0	
Percent Time-Spent-Following		
	Analysis Direction (d)	Opposing Direction (o)
Passenger-car equivalent for trucks, E_T (Exhibit 20-10 or 20-16)	1.0	1.5
Passenger-car equivalent for RVs, E_R (Exhibit 20-10 or 20-16)	1.0	1.0
Heavy-vehicle adjustment factor, f_{HV} $f_{HV} = \frac{1}{1 + P_T(E_T - 1) + P_R(E_R - 1)}$	1.000	0.935
Grade adjustment factor, ¹ f_G (Exhibit 20-8 or 20-14)	1.0	0.94
Directional flow rate, ² v_i (pc/h) $v_i = \frac{V_i}{PHF \cdot f_{HV} \cdot f_G}$	1,263	479
Base percent time-spent-following, ⁴ BPTSF _d (%) $BPTSF_d = 100(1 - e^{-0.0008 v_i})$	84.7	
Adjustment for no-passing zone, f_{np} (Exhibit 20-20)	11.7	
Percent time-spent-following, PTSF _d (%) $PTSF_d = BPTSF_d + f_{np}$	96.4	
Level of Service and Other Performance Measures		
Level of service, LOS (Exhibit 20-3 or 20-4)	E	
Volume to capacity ratio, v/c $v/c = \frac{V_d}{1700}$	0.81	
Peak 15-min vehicle-kilometers of travel, $VkmT_{15}$ (veh-km) $VkmT_{15} = 0.25L_i \left(\frac{V_d}{PHF} \right)$	3,158	
Peak-hour vehicle-kilometers of travel, $VkmT_{60}$ (veh-km) $VkmT_{60} = V_d \cdot L_i$	12,000	
Peak 15-min total travel time, TT_{15} (veh-h) $TT_{15} = \frac{VkmT_{15}}{ATS_d}$	50.1	
Notes		
1. If the highway is extended segment (level) or rolling terrain, $f_G = 1.0$ 2. If v_i (v_d or v_o) $\geq 1,700$ pc/h, terminate analysis—the LOS is F. 3. For the analysis direction only. 4. Exhibit 20-21 provides factors a and b. 5. Use alternative Equation 20-14 if some trucks operate at crawl speeds on a specific downgrade.		

EXAMPLE PROBLEM 4

The Highway A Class I two-lane highway segment described in Example Problem 3. In this analysis, a 2-km passing lane is to be added beginning at a location 2 km downstream from the beginning of the 10-km two-lane highway in the analysis direction.

The Question What is the LOS in the peak direction including the passing lane?

The Facts

- √ All input parameters listed in Example Problem 3,
- √ 2-km length of two-lane highway upstream of the passing lane, and
- √ 2-km length of passing lane including tapers.

Outline of Solution The length of roadway expected to be affected downstream of the passing lane will be determined. These lengths will be applied to the average travel speed and percent time-spent-following without a passing lane to compute the average travel speed and percent time-spent-following with the passing lane. Using these parameters, the LOS will be determined.

Steps

1. Compute L_d for average travel speed (use Exhibit 20-23 and Equation 20-18).	$L_d = L_t - (L_u + L_{pl} + L_{de})$ $L_d = 10 - (2 + 2 + 2.8) = 3.2 \text{ km}$
2. Compute average travel speed of the analysis direction including passing lane (use Exhibit 20-24 and Equation 20-21).	$ATS_{pl} = \frac{ATS_d * L_t}{L_u + L_d + \frac{L_{pl}}{f_{pl}} + \frac{2L_{de}}{1 + f_{pl}}}$ $ATS_{pl} = \frac{63.0(10)}{2 + 3.2 + \left(\frac{2}{1.11}\right) + \frac{2(2.8)}{1 + 1.11}} = 65.2 \text{ km/h}$
3. Compute L_d for percent time-spent-following (use Exhibit 20-23 and Equation 20-18).	$L_d = L_t - (L_u + L_{pl} + L_{de})$ $L_d = 10 - (2 + 2 + 5.8) = 0.2 \text{ km}$
4. Compute percent time-spent-following of the analysis direction including passing lane (use Exhibit 20-24 and Equation 20-19).	$PTSF_{pl} = \frac{PTSF_d \left[L_u + L_d + f_{pl}L_{pl} + \left(\frac{1 + f_{pl}}{2}\right)L_{de} \right]}{L_t}$ $PTSF_{pl} = \frac{96.4 \left[2 + 0.2 + 0.62(2) + \left(\frac{1 + 0.62}{2}\right)5.8 \right]}{10} = 78.5\%$
5. Determine LOS (use Exhibit 20-3).	$ATS_{pl} = 65.2 \text{ km/h}$ and $PTSF_{pl} = 78.5\%$ LOS D

Results The two-lane highway operates at LOS D in the analysis direction with the passing lane as compared to LOS E without the passing lane (from Example Problem 3).

Other Performance Measures

$$v/c = \frac{V_d}{1,700} = \frac{1,370}{1,700} = 0.81$$

$$VkmT_{15} = 0.25L_t \left(\frac{V_d}{PHF} \right) = 0.25(10) \left(\frac{1,200}{0.95} \right) = 3,158 \text{ veh-km}$$

$$VkmT_{60} = V_d * L_t = (1,200)(10) = 12,000 \text{ veh-km}$$

$$TT_{15} = \frac{VkmT_{15}}{ATS_{pl}} = \frac{3,158}{65.2} = 48.4 \text{ veh-h}$$

Example Problem 4

DIRECTIONAL TWO-LANE HIGHWAY SEGMENT WITH PASSING LANE WORKSHEET	
General Information	Site Information
Analyst <u>M.E.</u>	Highway/Direction of Travel <u>State Highway 45</u>
Agency or Company <u>CEI</u>	From/To <u>RD 20/RD 35</u>
Date Performed <u>5/20/99</u>	Jurisdiction _____
Analysis Time Period _____	Analysis Year <u>1999</u>
<input checked="" type="checkbox"/> Operational (LOS)	<input type="checkbox"/> Design (v_p)
<input type="checkbox"/> Planning (LOS)	<input type="checkbox"/> Planning (v_p)
Input Data	
<input checked="" type="checkbox"/> Class I highway <input type="checkbox"/> Class II highway	
Total length of analysis segment, L_t (km)	10
Length of two-lane highway upstream of the passing lane, L_u (km)	2
Length of passing lane including tapers, L_{pl} (km)	2
Average travel speed, ATS_d (from Directional Two-Lane Highway Segment Worksheet)	63.0
Percent time-spent-following, $PTSF_d$ (from Directional Two-Lane Highway Segment Worksheet)	96.4
Level of service, ¹ LOS_d (from Directional Two-Lane Highway Segment Worksheet)	E
Average Travel Speed	
Downstream length of two-lane highway within effective length of passing lane for average travel speed, L_{de} (km) (Exhibit 20-23)	2.8
Length of two-lane highway downstream of effective length of the passing lane for average travel speed, L_d (km) $L_d = L_t - (L_u + L_{pl} + L_{de})$	3.2
Adj. factor for the effect of passing lane on average speed, f_{pl} (Exhibit 20-24)	1.11
Average travel speed including passing lane, ² ATS_{pl}	65.2
$ATS_{pl} = \frac{ATS_d * L_t}{L_u + L_d + \frac{L_{pl}}{f_{pl}} + \frac{2L_{de}}{1 + f_{pl}}}$	
Percent Time-Spent-Following	
Downstream length of two-lane highway within effective length of passing lane for percent time-spent-following, L_{de} (km) (Exhibit 20-23)	5.8
Length of two-lane highway downstream of effective length of the passing lane for percent time-spent-following, L_d (km) $L_d = L_t - (L_u + L_{pl} + L_{de})$	0.2
Adj. factor for the effect of passing lane on percent time-spent-following, f_{pl} (Exhibit 20-24)	0.62
Percent time-spent-following including passing lane, ³ $PTSF_{pl}$ (%)	78.5
$PTSF_{pl} = \frac{PTSF_d [L_u + L_d + f_{pl} L_{pl} + (\frac{1 + f_{pl}}{2}) L_{de}]}{L_t}$	
Level of Service and Other Performance Measures ⁴	
Level of service including passing lane, LOS_{pl} (Exhibits 20-3 or 20-4)	D
Peak 15-min total travel time, TT_{15} (veh-h) $TT_{15} = \frac{VkmT_{15}}{ATS_{pl}}$	48.4
Notes	
1. If $LOS_d = F$, passing lane analysis cannot be performed. 2. If $L_d < 0$, use alternative Equation 20-22. 3. If $L_d < 0$, use alternative Equation 20-20. 4. v/c , $VkmT_{15}$, and $VkmT_{60}$ are calculated on Directional Two-Lane Highway Segment Worksheet.	

V. REFERENCES

1. Harwood, D. W., A. D. May, I. B. Anderson, L. Leiman, and A. R. Archilla. *Capacity and Quality of Service of Two-Lane Highways*. Final Report, NCHRP Project 3-55(3), Midwest Research Institute, 1999.
2. Robertson, H. Douglas (ed.) *Manual of Transportation Engineering Studies*. Prentice-Hall, Washington, D.C., 1994.
3. Harwood, D. W., and C. J. Hoban. *Low Cost Methods for Improving Traffic Operations on Two-Lane Roads—Informational Guide*. Report FHWA-IP-87/2, Federal Highway Administration, U.S. Department of Transportation, January 1987.
4. American Association of State Highway and Transportation Officials. *A Policy on Geometric Design of Highways and Streets*. Washington, D.C., 1994.

APPENDIX A. DESIGN AND OPERATIONAL TREATMENTS

Two-lane highways comprise approximately 80 percent of all paved rural highways in the United States but carry only about 30 percent of all traffic. For the most part, two-lane highways carry light volumes and experience few operational problems. Some two-lane highways, however, periodically experience significant operational and safety problems due to a variety of traffic, geometric, and environment causes. Such highways may require design or operation improvements to alleviate congestion.

When traffic operational problems occur on a two-lane highway, many highway agencies consider widening the highway to four lanes. Another effective method for alleviating operational problems on two-lane highways is to provide passing lanes at intervals in each direction of travel or to provide climbing lanes on steep upgrades. Passing and climbing lanes cannot increase the capacity of a two-lane highway but can improve its level of service. Short sections of four-lane highway can function as a pair of passing lanes in opposite directions of travel. Operational analysis procedures for passing and climbing lanes on two-lane highways are included in this chapter.

There are a number of other design and operational treatments that are effective in alleviating operational congestion on two-lane highways. These include

- Turnouts,
- Shoulder use,
- Wide cross sections,
- Intersection turn lanes, and
- Two-way left-turn lanes.

No calculation methodologies are provided in this chapter for these treatments; however, the treatments are discussed below to indicate their potential for improving traffic operations on two-lane highways.

TURNOUTS

A turnout is a widened, unobstructed shoulder area on a two-lane highway that allows slow-moving vehicles to pull out of the through lane so that vehicles following may pass. Turnouts are relatively short, generally less than 190 m. At a turnout, the driver of a slow-moving vehicle that is delaying one or more following vehicles is expected to pull out of the through lane, allowing the vehicles to pass. The driver of the slow-moving vehicle is expected to remain in the turnout only long enough for the following vehicles to pass and then should return to the through lane. When there are only one or two following vehicles, this maneuver usually can be completed smoothly and there is no need for the vehicle to stop in the turnout. When there are three or more

following vehicles, however, the vehicle in the turnout will usually need to stop so that all of the following vehicles may pass. Signs inform motorists of the turnout's location and reinforce the legal requirements concerning turnout use.

Turnouts have been used in several countries to provide additional passing opportunities on two-lane highways. In the United States, turnouts have been used most extensively in the western states. Exhibit A20-1 illustrates a typical turnout.

EXHIBIT A20-1. TYPICAL TURNOUT TO INCREASE PASSING OPPORTUNITIES ON A TWO-LANE HIGHWAY

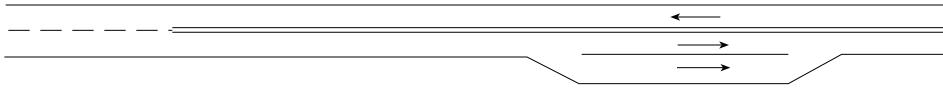

Turnouts may be used on nearly any type of two-lane highway that offers limited passing opportunities. Most often they appear on lower-volume highways in level or rolling terrain, on which long platoons are rare, and on difficult terrain with steep grades or with isolated slow-moving vehicles because the construction of a passing or climbing lane may not be cost-effective. To avoid confusing drivers, turnouts and passing lanes should not be intermixed on the same highway.

A single well-designed and well-located turnout can be expected to provide 20 to 50 percent of the number of passes that would occur in a 1.6-km passing lane in level terrain (1, 2). Turnouts have been found to operate safely—according to safety researchers turnout accidents occur at a rate of only 1 per 80,000 to 400,000 users (2–4).

SHOULDER USE

The primary purpose of the shoulder on a two-lane highway is to provide a stopping and recovery area for disabled or errant vehicles. However, paved shoulders also may be used to increase passing opportunities on a two-lane highway.

In some parts of the United States and Canada, if the paved shoulders are adequate, there is a longstanding custom for slower vehicles to move to the shoulder when another vehicle approaches from the rear and then return to the travel lane once the passing vehicle has cleared. This custom is regarded as a courtesy and requires little or no sacrifice in speed by either motorist. In this way, paved shoulders can function as continuous turnouts. A few highway agencies encourage drivers of slow-moving vehicles to use the shoulder in this way because it improves the LOS of two-lane highways without the expense of adding passing lanes or widening the highway. On the other hand, many highway agencies discourage this practice because their shoulders are not designed for frequent use by heavy vehicles.

One highway agency in the western United States generally does not permit shoulder use by slow-moving vehicles but designates specific sections on which the shoulder may be used by slow-moving vehicles. These shoulder-use sections range in length from 0.3 to 5.0 km and are identified by traffic signs.

Research has shown that a shoulder-use section is about 20 percent as effective in reducing platoons as a passing lane of comparable length (1, 2).

WIDE CROSS SECTIONS

Two-lane highways with lanes about 50 percent wider than normal have been used in several European countries as a less expensive alternative to passing lanes. Sweden, for example, has built approximately 800 km of roadways with two 5.5-m travel lanes and relatively narrow 1.0-m shoulders. The wider lane permits faster vehicles to pass slower vehicles while encroaching only slightly on the opposing lane of traffic. Opposing vehicles must move toward the shoulder to permit such maneuvers. Roadway sections with wider lanes can be provided at intervals, like passing lanes, to increase passing opportunities on two-lane highways.

Research has found that speeds at low traffic volumes tend to increase on wider lanes, but the effect on speeds at higher volumes varies (5). More than 70 percent of drivers indicated that they appreciate the increased passing opportunities on the wider lanes. No safety problems have been associated with the wider lanes (5).

Formal procedures have not yet been established for evaluating the traffic operational effectiveness of wider lanes in increasing the passing opportunities on a two-lane highway. It is reasonable to estimate the traffic operational performance of a directional two-lane highway segment containing a section with widened lanes as midway between the same segment with and without a passing lane of comparable length.

INTERSECTION TURN LANES

Intersection turn lanes are desirable at selected locations on two-lane highways to reduce delays to through vehicles caused by turning vehicles and to reduce accidents related to turning. Separate right-turn and left-turn lanes may be provided, as appropriate, to remove turning vehicles from the through-travel lanes. Left-turn lanes, in particular, provide a protected location for turning vehicles to wait for a gap in opposing traffic. This reduces the potential for collisions from the rear and also may encourage drivers of left-turning vehicles to wait for an adequate gap in opposing traffic before turning. Exhibit A20-2 shows a typical two-lane highway intersection with left-turn lanes.

EXHIBIT A20-2. TYPICAL TWO-LANE HIGHWAY INTERSECTION WITH LEFT-TURN LANES

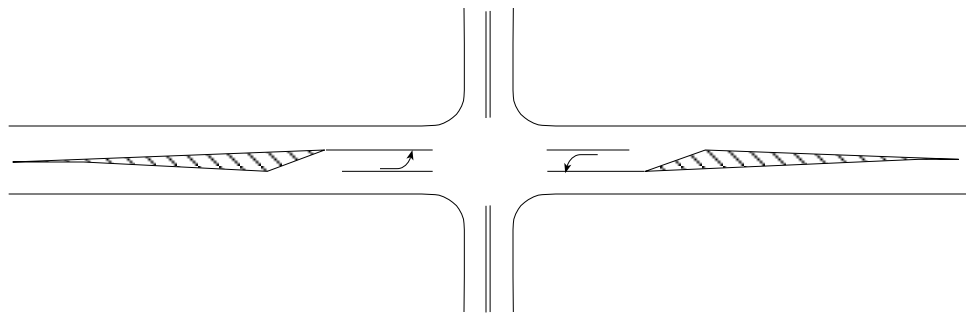

Research recommends specific traffic operational warrants for left-turn lanes at intersections on two-lane highways based on the directional volumes and the percentage of left turns (6). Intersection analysis with the methodologies of Chapter 16 for signalized intersections and Chapter 17 for unsignalized intersections can be used to quantify the effects of intersection turn lanes on delay at the intersection. There is no general methodology for estimating the effect of intersection turn lanes in increasing speed or reducing delay on the two-lane highway downstream. However, modeling of intersection delays shows the relative magnitude of likely effects of turning delays on percent time-spent-following (7); the results are shown in Exhibit A20-3. The top line in the exhibit shows that turning vehicles can increase percent time-spent-following substantially over a short road section. However, when these effects are averaged over a longer road section, the increase in percent time-spent-following is greatly reduced, as indicated by the dashed line in the exhibit. Provision of intersection turn lanes has the potential to minimize these delays.

Several highway agencies in the United States provide shoulder bypass lanes at three-leg intersections as a low-cost alternative to a left-turn lane. As shown in Exhibit A20-4, a portion of the paved shoulder opposite the minor-road leg may be marked as a lane for through traffic to bypass vehicles that are slowing or stopped to make a left turn. Shoulder bypass lanes may be appropriate for intersections that do not have volumes high enough to warrant a left-turn lane.

The delay reduction benefits of shoulder bypass lanes have not been quantified, but field studies have indicated that 97 percent of drivers who need to avoid delay will make

use of an available shoulder bypass lane. One state has reported a marked decrease in rear-end collisions after shoulder bypass lanes were provided (8).

EXHIBIT A20-3. EFFECT OF TURNING DELAYS AT INTERSECTIONS ON PERCENT TIME-SPENT-FOLLOWING IN A TWO-LANE HIGHWAY

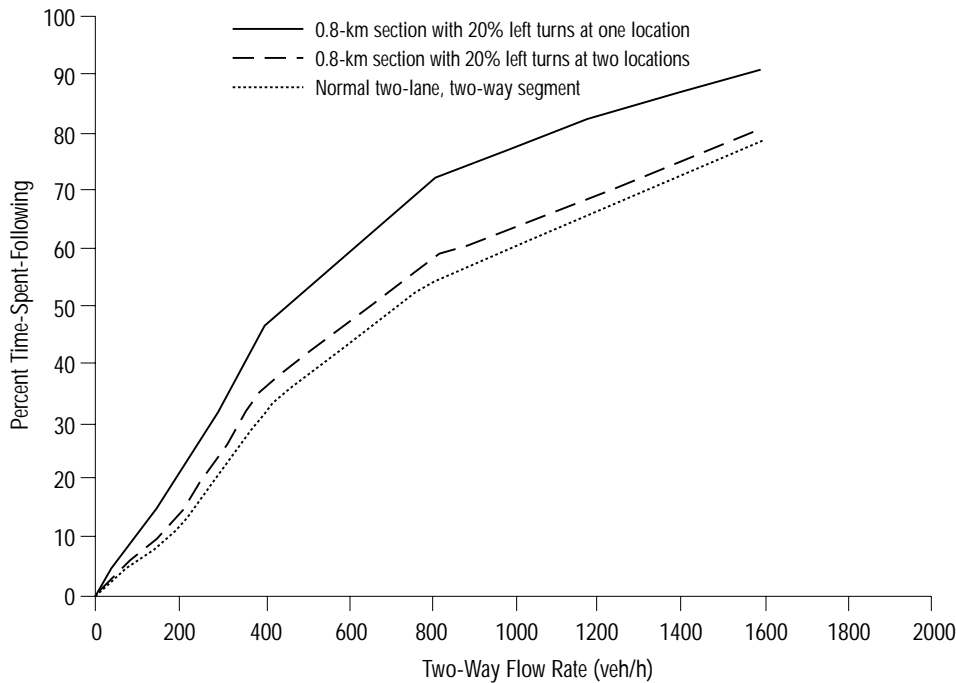

Source: Hoban (7).

EXHIBIT A20-4. TYPICAL SHOULDER BYPASS LANE AT A THREE-LEG INTERSECTION ON A TWO-LANE HIGHWAY

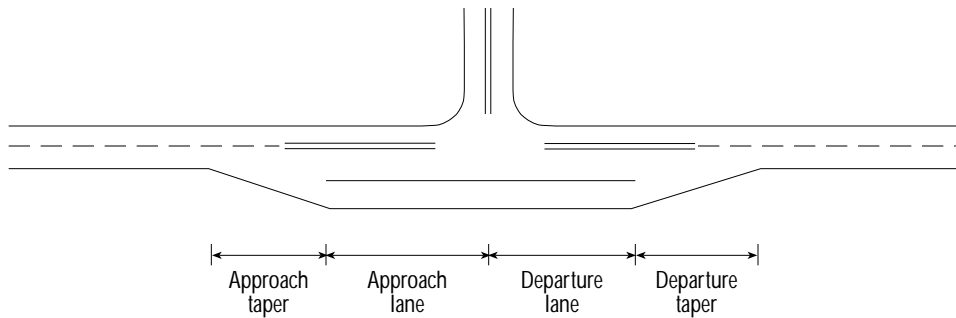

TWO-WAY LEFT-TURN LANES

A two-way left-turn lane (TWLTL) is a paved area in the highway median that extends continuously along a roadway section and is marked to provide a deceleration and storage area, for vehicles traveling in either direction and making left turns at intersections and driveways. TWLTLs have been used for many years on urban and suburban streets with high driveway densities and turning demands to improve safety and reduce delays to through vehicles. TWLTLs also can be used on two-lane highways in rural and urban fringe areas to obtain these same types of operational and safety benefits. Exhibit A20-5 illustrates a typical TWLTL on a two-lane highway.

EXHIBIT A20-5. TYPICAL TWO-WAY LEFT-TURN LANE ON A TWO-LANE HIGHWAY

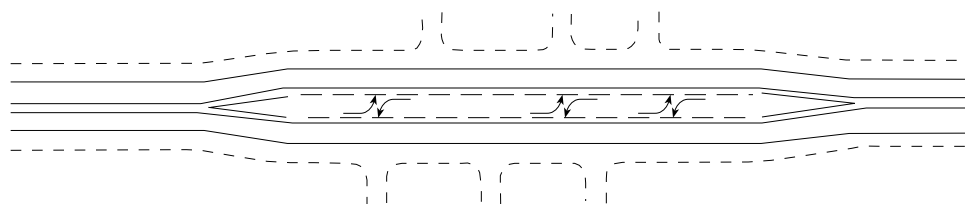

There is no formal methodology for evaluating the traffic operational effectiveness of TWLTLs on two-lane highways. Research has found that the delay reduction provided by a TWLTL depends on both the left-turn demand and the opposing traffic volume (2). Without a TWLTL or other left-turn treatment, vehicles that are slowing or stopped to make a left turn may create delays for following through vehicles. A TWLTL minimizes these delays and makes the roadway section operate more like two-way and directional segments with 100 percent no-passing zones. These research results apply to sites that do not have paved shoulders available for following vehicles to bypass turning vehicles. Paved shoulders may alleviate as much of the delay as a TWLTL.

Research has found little delay reduction at rural TWLTL sites with traffic volumes below 300 veh/h in one direction of travel (2). At several low-volume sites, no reduction was observed. The highest delay reduction observed was 3.4 s per left-turning vehicle. At low-volume rural sites, therefore, TWLTLs generally should be considered for reducing accidents but should not be expected to increase the operational performance of the highway.

At higher-volume urban fringe sites, greater delay reduction was found with TWLTLs on a two-lane highway. Exhibit A20-6 shows the expected delay reduction per left-turning vehicle as a function of opposing volume. As the delay reduction increases, a TWLTL can be justified for improving both traffic operation and safety.

EXHIBIT A20-6. ESTIMATED DELAY REDUCTION WITH A TWO-WAY LEFT-TURN LANE ON A TWO-LANE HIGHWAY WITHOUT PAVED SHOULDERS

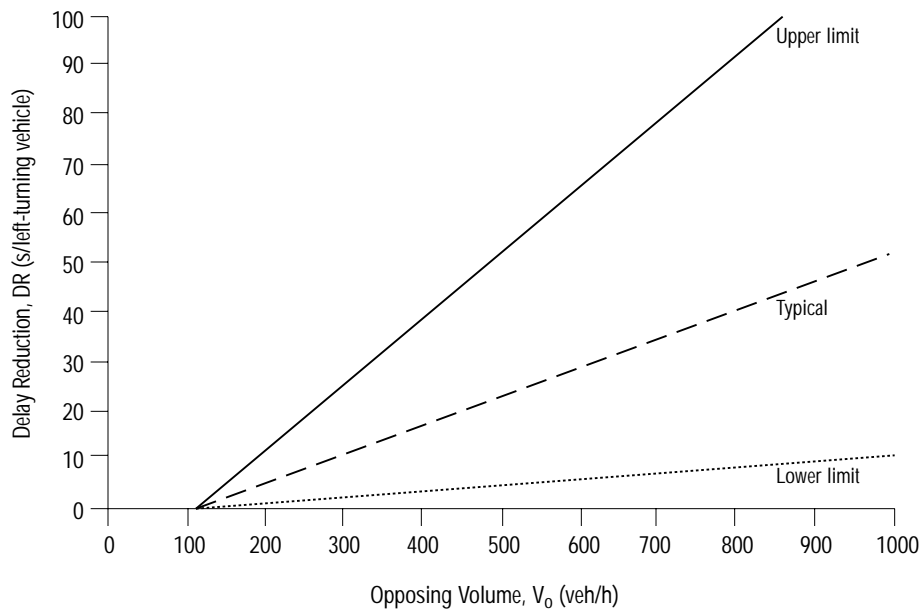

Note:
 $DR = -6.87 + 0.058V_o$
 Source: Harwood and St. John (2).

REFERENCES



1. Harwood, D. W., and C. J. Hoban. *Low Cost Methods for Improving Traffic Operations on Two-Lane Roads—Informational Guide*. Report FHWA-IP-87/2, Federal Highway Administration, U.S. Department of Transportation, January 1987.
2. Harwood, D. W., and A. D. St. John. *Passing Lanes and Other Operational Improvements on Two-lane Highways*. Report FHWA/RD-85/028, Federal Highway Administration, U.S. Department of Transportation, July 1984.
3. Rooney, F. D. *Turnouts—Summary Report: Traffic Operational Report No. 1*. California Department of Transportation, Sacramento, November 1976.
4. Rooney, F.D. *Turnouts: Traffic Operational Report No. 2*. California Department of Transportation, Sacramento, November 1976.
5. Bergh, T. *A2+1 Roads with Cable Barrier for Improved Traffic Safety*. Proceedings of the Third International Symposium on Highway Capacity, Road Directorate, Ministry of Transport, Denmark, June 1998.
6. Harmelink, M. D. Volume Warrants for Left-Turn Storage Lanes at Unsignalized Grade Intersections. In *Highway Research Record 211*, Highway Research Board, 1967, pp. 1–18.
7. Hoban, C. J. *A Model for Predicting Turning and Platooning Delays*. Internal Report AIR 359-16, Australian Road Research Board, 1986.
8. Sebastian, O. L., and R. S. Pusey. *Paved-Shoulder Left-Turn By-Pass Lanes: A Report on the Delaware Experience*. Delaware Department of Transportation, October 1982.

APPENDIX B. WORKSHEETS

TWO-WAY TWO-LANE HIGHWAY SEGMENT WORKSHEET

DIRECTIONAL TWO-LANE HIGHWAY SEGMENT WORKSHEET

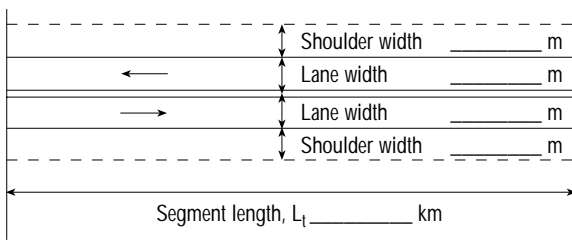
DIRECTIONAL TWO-LANE HIGHWAY SEGMENT WITH PASSING LANE WORKSHEET

TWO-WAY TWO-LANE HIGHWAY SEGMENT WORKSHEET	
General Information	Site Information
Analyst _____	Highway _____
Agency or Company _____	From/To _____
Date Performed _____	Jurisdiction _____
Analysis Time Period _____	Analysis Year _____
<input type="checkbox"/> Operational (LOS)	<input type="checkbox"/> Design (v_p)
<input type="checkbox"/> Design (v_p)	<input type="checkbox"/> Planning (LOS)
<input type="checkbox"/> Planning (LOS)	<input type="checkbox"/> Planning (v_p)
Input Data	
	<div style="display: flex; justify-content: space-between;"> <div style="text-align: center;">  <p>Show North Arrow</p> </div> <div style="width: 80%;"> <input type="checkbox"/> Class I highway <input type="checkbox"/> Class II highway Terrain <input type="checkbox"/> Level <input type="checkbox"/> Rolling Two-way hourly volume _____ veh/h Directional split _____ / _____ Peak-hour factor, PHF _____ % Trucks and buses, P_T _____ % % Recreational vehicles, P_R _____ % % No-passing zone _____ % Access points/km _____ /km </div> </div>
Average Travel Speed	
Grade adjustment factor, f_G (Exhibit 20-7)	
Passenger-car equivalents for trucks, E_T (Exhibit 20-9)	
Passenger-car equivalents for RVs, E_R (Exhibit 20-9)	
Heavy-vehicle adjustment factor, f_{HV} $f_{HV} = \frac{1}{1 + P_T(E_T - 1) + P_R(E_R - 1)}$	
Two-way flow rate, ¹ v_p (pc/h) $v_p = \frac{V}{PHF * f_G * f_{HV}}$	
v_p * highest directional split proportion ² (pc/h)	
Free-Flow Speed from Field Measurement	Estimated Free-Flow Speed
Field measured speed, S_{FM} _____ km/h	Base free-flow speed, BFFS _____ km/h
Observed volume, V_f _____ veh/h	Adj. for lane width and shoulder width, f_{LS} (Exhibit 20-5) _____ km/h
Free-flow speed, FFS _____ km/h	Adj. for access points, f_A (Exhibit 20-6) _____ km/h
$FFS = S_{FM} + 0.0125 \left(\frac{V_f}{f_{HV}} \right)$	Free-flow speed, FFS _____ km/h
	$FFS = BFFS - f_{LS} - f_A$
Adj. for no-passing zones, f_{np} (km/h) (Exhibit 20-11)	
Average travel speed, ATS (km/h) $ATS = FFS - 0.0125v_p - f_{np}$	
Percent Time-Spent-Following	
Grade adjustment factor, f_G (Exhibit 20-8)	
Passenger-car equivalents for trucks, E_T (Exhibit 20-10)	
Passenger-car equivalents for RVs, E_R (Exhibit 20-10)	
Heavy-vehicle adjustment factor, f_{HV} $f_{HV} = \frac{1}{1 + P_T(E_T - 1) + P_R(E_R - 1)}$	
Two-way flow rate, ¹ v_p (pc/h) $v_p = \frac{V}{PHF * f_G * f_{HV}}$	
v_p * highest directional split proportion ² (pc/h)	
Base percent time-spent-following, BPTSF (%) $BPTSF = 100(1 - e^{-0.000879v_p})$	
Adj. for directional distribution and no-passing zone, $f_{d/np}$ (%) (Exhibit 20-12)	
Percent time-spent-following, PTSF (%) $PTSF = BPTSF + f_{d/np}$	
Level of Service and Other Performance Measures	
Level of service, LOS (Exhibit 20-3 for Class I or 20-4 for Class II)	
Volume to capacity ratio, v/c $v/c = \frac{v_p}{3,200}$	
Peak 15-min vehicle-kilometers of travel, $VkmT_{15}$ (veh-km) $VkmT_{15} = 0.25L \left(\frac{V}{PHF} \right)$	
Peak-hour vehicle-kilometers of travel, $VkmT_{60}$ (veh-km) $VkmT_{60} = V * L_t$	
Peak 15-min total travel time, TT_{15} (veh-h) $TT_{15} = \frac{VkmT_{15}}{ATS}$	
Notes	
1. If $v_p \geq 3,200$ pc/h, terminate analysis—the LOS is F.	
2. If highest directional split $v_p \geq 1,700$ pc/h, terminate analysis—the LOS is F.	

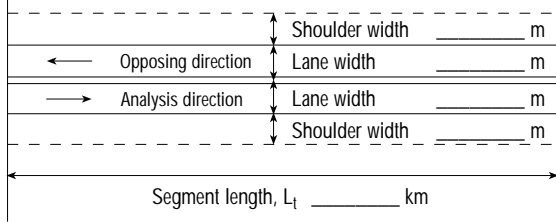
DIRECTIONAL TWO-LANE HIGHWAY SEGMENT WORKSHEET			
General Information		Site Information	
Analyst _____	Highway/Direction of Travel _____		
Agency or Company _____	From/To _____		
Date Performed _____	Jurisdiction _____		
Analysis Time Period _____	Analysis Year _____		
<input type="checkbox"/> Operational (LOS)		<input type="checkbox"/> Design (v_p)	
<input type="checkbox"/> Design (v_p)		<input type="checkbox"/> Planning (LOS)	
<input type="checkbox"/> Planning (LOS)		<input type="checkbox"/> Planning (v_p)	
Input Data			
		<input type="checkbox"/> Class I highway <input type="checkbox"/> Class II highway Terrain <input type="checkbox"/> Level <input type="checkbox"/> Rolling Grade Length _____ km Up/down _____ % Peak-hour factor, PHF _____ % Trucks and buses, P_T _____ % % Recreational vehicles, P_R _____ % % No-passing zone _____ % Access points/km _____ /km	
Analysis direction volume, V_d _____ veh/h		Opposing direction volume, V_o _____ veh/h	
Average Travel Speed			
		Analysis Direction (d)	Opposing Direction (o)
Passenger-car equivalent for trucks, E_T (Exhibit 20-9 or 20-15)			
Passenger-car equivalent for RVs, E_R (Exhibit 20-9 or 20-17)			
Heavy-vehicle adjustment factor, ⁵ f_{HV} $f_{HV} = \frac{1}{1 + P_T(E_T - 1) + P_R(E_R - 1)}$			
Grade adjustment factor, ¹ f_G (Exhibit 20-6 or 20-12)			
Directional flow rate, ² v_i (pc/h) $v_i = \frac{V_i}{PHF * f_{HV} * f_G}$			
Free-Flow Speed from Field Measurement		Estimated Free-Flow Speed	
Field measured speed, ³ S_{FM} _____ km/h		Base free-flow speed, ³ BFFS _____ km/h	
Observed volume, ³ V_f _____ veh/h		Adj. for lane width and shoulder width, ³ f_{LS} (Exh. 20-5) _____ km/h	
Free-flow speed, FFS_d _____ km/h		Adj. for access points, ³ f_A (Exhibit 20-6) _____ km/h	
$FFS_d = S_{FM} + 0.0125 \left(\frac{V_f}{f_{HV}} \right)$		Free-flow speed, FFS_d _____ km/h	
		$FFS_d = BFFS - f_{LS} - f_A$	
Adjustment for no-passing zones, f_{np} (km/h) (Exhibit 20-19)			
Average travel speed, ATS_d (km/h) $ATS_d = FFS_d - 0.0125(v_d + v_o) - f_{np}$			
Percent Time-Spent-Following			
		Analysis Direction (d)	Opposing Direction (o)
Passenger-car equivalent for trucks, E_T (Exhibit 20-10 or 20-16)			
Passenger-car equivalent for RVs, E_R (Exhibit 20-10 or 20-16)			
Heavy-vehicle adjustment factor, f_{HV} $f_{HV} = \frac{1}{1 + P_T(E_T - 1) + P_R(E_R - 1)}$			
Grade adjustment factor, ¹ f_G (Exhibit 20-8 or 20-14)			
Directional flow rate, ² v_i (pc/h) $v_i = \frac{V_i}{PHF * f_{HV} * f_G}$			
Base percent time-spent-following, ⁴ $BPTSF_d$ (%) $BPTSF_d = 100(1 - e^{-av_d^b})$			
Adjustment for no-passing zone, f_{np} (Exhibit 20-20)			
Percent time-spent-following, $PTSF_d$ (%) $PTSF_d = BPTSF_d + f_{np}$			
Level of Service and Other Performance Measures			
Level of service, LOS (Exhibit 20-3 or 20-4)			
Volume to capacity ratio, v/c $v/c = \frac{V_d}{1700}$			
Peak 15-min vehicle-kilometers of travel, $VkmT_{15}$ (veh-km) $VkmT_{15} = 0.25L_1 \left(\frac{V_d}{PHF} \right)$			
Peak-hour vehicle-kilometers of travel, $VkmT_{60}$ (veh-km) $VkmT_{60} = V_d * L_1$			
Peak 15-min total travel time, TT_{15} (veh-h) $TT_{15} = \frac{VkmT_{15}}{ATS_d}$			
Notes			
1. If the highway is extended segment (level) or rolling terrain, $f_G = 1.0$ 2. If v_i (v_d or v_o) $\geq 1,700$ pc/h, terminate analysis—the LOS is F. 3. For the analysis direction only. 4. Exhibit 20-21 provides factors a and b. 5. Use alternative Equation 20-14 if some trucks operate at crawl speeds on a specific downgrade.			

DIRECTIONAL TWO-LANE HIGHWAY SEGMENT WITH PASSING LANE WORKSHEET	
General Information	Site Information
Analyst _____	Highway/Direction of Travel _____
Agency or Company _____	From/To _____
Date Performed _____	Jurisdiction _____
Analysis Time Period _____	Analysis Year _____
<input type="checkbox"/> Operational (LOS)	<input type="checkbox"/> Design (v_p)
<input type="checkbox"/> Design (v_p)	<input type="checkbox"/> Planning (LOS)
<input type="checkbox"/> Planning (LOS)	<input type="checkbox"/> Planning (v_p)
Input Data	
<div style="display: flex; justify-content: space-between; align-items: center;"> <div style="text-align: center;"> <input type="checkbox"/> Class I highway <input type="checkbox"/> Class II highway </div> <div style="text-align: center;"> </div> </div>	
Total length of analysis segment, L_t (km)	
Length of two-lane highway upstream of the passing lane, L_u (km)	
Length of passing lane including tapers, L_{pl} (km)	
Average travel speed, ATS_d (from Directional Two-Lane Highway Segment Worksheet)	
Percent time-spent-following, $PTSF_d$ (from Directional Two-Lane Highway Segment Worksheet)	
Level of service, ¹ LOS_d (from Directional Two-Lane Highway Segment Worksheet)	
Average Travel Speed	
Downstream length of two-lane highway within effective length of passing lane for average travel speed, L_{de} (km) (Exhibit 20-23)	
Length of two-lane highway downstream of effective length of the passing lane for average travel speed, L_d (km) $L_d = L_t - (L_u + L_{pl} + L_{de})$	
Adj. factor for the effect of passing lane on average speed, f_{pl} (Exhibit 20-24)	
Average travel speed including passing lane, ² ATS_{pl}	
$ATS_{pl} = \frac{ATS_d \cdot L_t}{L_u + L_d + \frac{L_{pl}}{f_{pl}} + \frac{2L_{de}}{1 + f_{pl}}}$	
Percent Time-Spent-Following	
Downstream length of two-lane highway within effective length of passing lane for percent time-spent-following, L_{de} (km) (Exhibit 20-23)	
Length of two-lane highway downstream of effective length of the passing lane for percent time-spent-following, L_d (km) $L_d = L_t - (L_u + L_{pl} + L_{de})$	
Adj. factor for the effect of passing lane on percent time-spent-following, f_{pl} (Exhibit 20-24)	
Percent time-spent-following including passing lane, ³ $PTSF_{pl}$ (%)	
$PTSF_{pl} = \frac{PTSF_d [L_u + L_d + f_{pl} L_{pl} + (\frac{1 + f_{pl}}{2}) L_{de}]}{L_t}$	
Level of Service and Other Performance Measures ⁴	
Level of service including passing lane, LOS_{pl} (Exhibits 20-3 or 20-4)	
Peak 15-min total travel time, TT_{15} (veh-h) $TT_{15} = \frac{VkmT_{15}}{ATS_{pl}}$	
Notes	
<ol style="list-style-type: none"> 1. If $LOS_d = F$, passing lane analysis cannot be performed. 2. If $L_d < 0$, use alternative Equation 20-22. 3. If $L_d < 0$, use alternative Equation 20-20. 4. v/c, $VkmT_{15}$, and $VkmT_{60}$ are calculated on Directional Two-Lane Highway Segment Worksheet. 	

CHAPTER 21**MULTILANE HIGHWAYS****CONTENTS**

I.	INTRODUCTION	21-1
	Base Conditions for Multilane Highways	21-1
	Limitations of the Methodology	21-1
II.	METHODOLOGY	21-1
	LOS	21-2
	Determining FFS	21-3
	Estimating FFS	21-5
	Base FFS	21-5
	Adjustment for Lane Width	21-5
	Adjustment for Lateral Clearance	21-6
	Median Type	21-6
	Adjustment for Access-Point Density	21-7
	Determining Flow Rate	21-7
	PHF	21-7
	Heavy-Vehicle Adjustments	21-7
	Extended General Highway Segments	21-8
	Specific Grade	21-8
	Equivalents for Extended General Highway Segments	21-8
	Level Terrain	21-8
	Rolling Terrain	21-9
	Mountainous Terrain	21-9
	Equivalents for Specific Grades	21-9
	Equivalents for Specific Upgrades	21-9
	Equivalents for Specific Downgrades	21-9
	Equivalents for Composite Grades	21-9
	Driver Population Factor	21-11
	Determining LOS	21-11
	Sensitivity of Results to Input Variables	21-11
III.	APPLICATIONS	21-12
	Segmenting the Highway	21-13
	Computational Steps	21-13
	Planning Applications	21-13
	Analysis Tools	21-15
IV.	EXAMPLE PROBLEMS	21-15
	Example Problem 1 (Part I)	21-16
	Example Problem 1 (Part II)	21-18
	Example Problem 2 (Part I)	21-20
	Example Problem 2 (Part II)	21-22
	Example Problem 3	21-24
	Example Problem 4	21-26
	Example Problem 5	21-28
V.	REFERENCES	21-29
	APPENDIX A. WORKSHEET	21-30
	Multilane Highways Worksheet	

EXHIBITS

Exhibit 21-1. Multilane Highway Methodology 21-2

Exhibit 21-2. LOS Criteria for Multilane Highways 21-3

Exhibit 21-3. Speed-Flow Curves with LOS Criteria 21-4

Exhibit 21-4. Adjustment for Lane Width 21-5

Exhibit 21-5. Adjustment for Lateral Clearance 21-6

Exhibit 21-6. Adjustment for Median Type 21-6

Exhibit 21-7. Access-Point Density Adjustment 21-7

Exhibit 21-8. Passenger-Car Equivalents on Extended General
Highway Segments 21-8

Exhibit 21-9. Passenger-Car Equivalents for Trucks and Buses on
Uniform Upgrades 21-10

Exhibit 21-10. Passenger-Car Equivalents for RVs on Uniform Upgrades 21-10

Exhibit 21-11. Passenger-Car Equivalents for Trucks on Downgrades 21-11

Exhibit 21-12. Effect of v/c Ratio on Mean Speed 21-12

Exhibit 21-13. Multilane Highways Worksheet 21-14

I. INTRODUCTION

The procedures in this chapter are used to analyze the capacity, level of service (LOS), lane requirements, and impacts of traffic and design features of rural and suburban multilane highways.

The methodology in this chapter is based on the results of a National Cooperative Highway Research study (1). The study used additional references in developing the original methodology (2–6), which subsequently has been updated (7).

BASE CONDITIONS FOR MULTILANE HIGHWAYS

The procedures in this chapter determine the reduction in travel speed that occurs for less-than-base conditions. Under base conditions, the full speed and capacity of a multilane highway are achieved. These conditions include good weather, good visibility, and no incidents or accidents.

Studies of the flow characteristics of multilane highways have defined base conditions for developing flow relationships and adjustments to speed. The base conditions for multilane highways are as follows:

- 3.6-m minimum lane widths;
- 3.6-m minimum total lateral clearance in the direction of travel—this represents the total lateral clearances from the edge of the traveled lanes to obstructions along the edge of the road and in the median (in computations, lateral clearances greater than 1.8 m are considered in computations to be equal to 1.8 m);
- Only passenger cars in the traffic stream;
- No direct access points along the roadway;
- A divided highway; and
- Free-flow speed (FFS) higher than 100 km/h.

These base conditions represent the highest operating level of multilane rural and suburban highways.

LIMITATIONS OF THE METHODOLOGY

The methodology in this chapter does not take into account the following conditions:

- Transitory blockages caused by construction, accidents, or railroad crossings;
- Interference caused by parking on the shoulders (such as in the vicinity of a country store, flea market, or tourist attraction);
- Three-lane cross sections;
- The effect of lane drops and additions at beginning or end of segments;
- Possible queuing delays when transitions from a multilane segment into a two-lane segment are neglected;
- Differences between median barriers and two-way left-turn lanes; and
- FFS below 70 km/h or above 100 km/h.

II. METHODOLOGY

The methodology described in this chapter is intended for analysis of uninterrupted-flow highway segments. Chapter 15 presents the methodology for analyzing urban streets that have one or more of the following characteristics:

- Flow significantly influenced by other signals (i.e., a signal spacing less than or equal to 3.0 km),
- Significant presence of on-street parking,
- Presence of bus stops that have significant use, or
- Significant pedestrian activity.

For background and concepts, see Chapter 12, "Highway Concepts"

Methodology applies to signal spacing greater than 3.0 km

Exhibit 21-1 illustrates the inputs and the basic computational order for the method described in this chapter. The primary output is LOS.

Uninterrupted-flow facilities that allow access solely through a system of on-ramps and off-ramps from grade separations or service roads are considered freeways and should be evaluated using the methodology presented in Chapter 23.

EXHIBIT 21-1. MULTILANE HIGHWAY METHODOLOGY

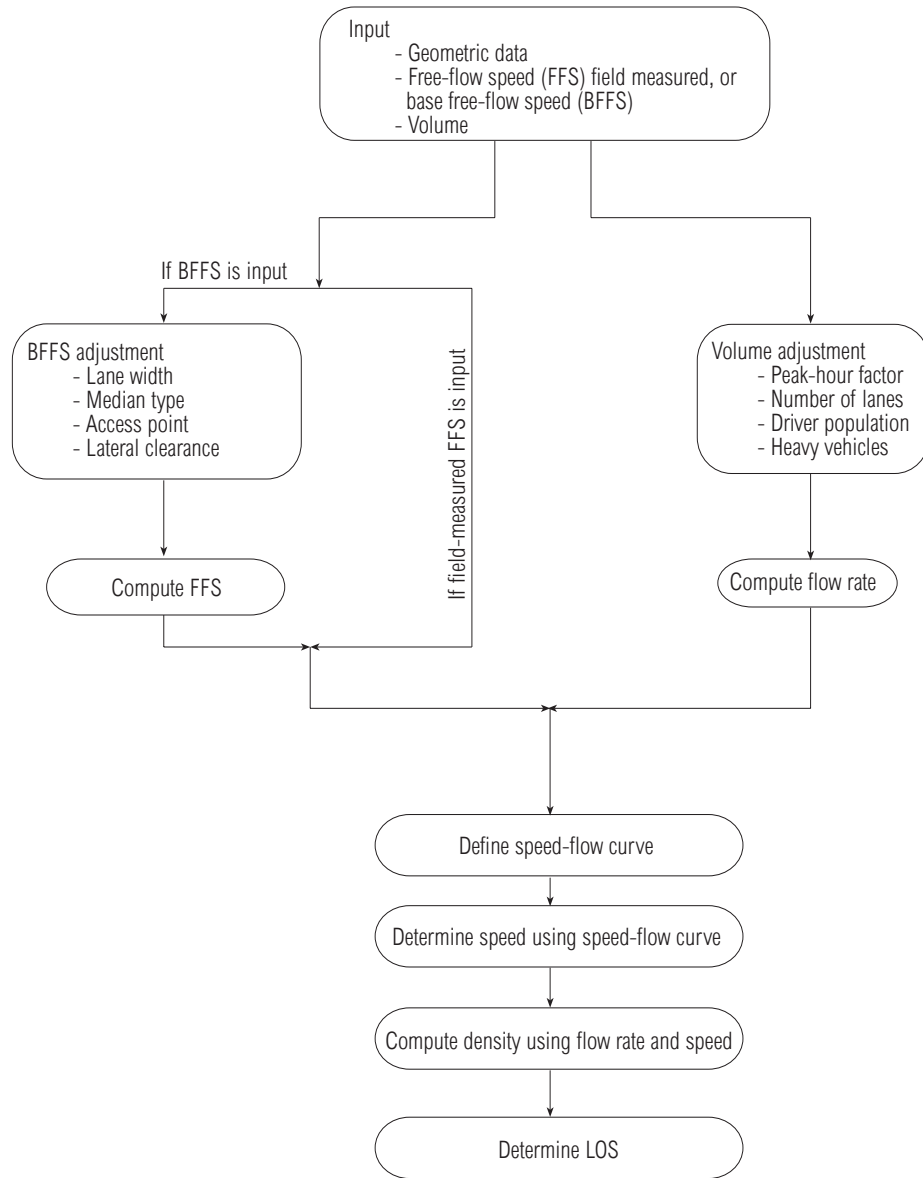

LOS

Although speed is a major concern of drivers, freedom to maneuver within the traffic stream and the proximity to other vehicles are also important. LOS criteria are listed in Exhibit 21-2. The criteria are based on the typical speed-flow and density-flow relationships shown in Exhibits 12-1 and 12-2. Exhibit 21-3 shows LOS boundaries as sloped lines, each corresponding to a constant value of density.

EXHIBIT 21-2. LOS CRITERIA FOR MULTILANE HIGHWAYS

Free-Flow Speed	Criteria	LOS				
		A	B	C	D	E
100 km/h	Maximum density (pc/km/ln)	7	11	16	22	25
	Average speed (km/h)	100.0	100.0	98.4	91.5	88.0
	Maximum volume to capacity ratio (v/c)	0.32	0.50	0.72	0.92	1.00
	Maximum service flow rate (pc/h/ln)	700	1100	1575	2015	2200
90 km/h	Maximum density (pc/km/ln)	7	11	16	22	26
	Average speed (km/h)	90.0	90.0	89.8	84.7	80.8
	Maximum v/c	0.30	0.47	0.68	0.89	1.00
	Maximum service flow rate (pc/h/ln)	630	990	1435	1860	2100
80 km/h	Maximum density (pc/km/ln)	7	11	16	22	27
	Average speed (km/h)	80.0	80.0	80.0	77.6	74.1
	Maximum v/c	0.28	0.44	0.64	0.85	1.00
	Maximum service flow rate (pc/h/ln)	560	880	1280	1705	2000
70 km/h	Maximum density (pc/km/ln)	7	11	16	22	28
	Average speed (km/h)	70.0	70.0	70.0	69.6	67.9
	Maximum v/c	0.26	0.41	0.59	0.81	1.00
	Maximum service flow rate (pc/h/ln)	490	770	1120	1530	1900

Note:

The exact mathematical relationship between density and volume to capacity ratio (v/c) has not always been maintained at LOS boundaries because of the use of rounded values. Density is the primary determinant of LOS. LOS F is characterized by highly unstable and variable traffic flow. Prediction of accurate flow rate, density, and speed at LOS F is difficult.

The LOS criteria reflect the shape of the speed-flow and density-flow curves, particularly as speed remains relatively constant across LOS A to D but is reduced as capacity is approached. For FFS of 100, 90, 80, and 70 km/h, Exhibit 21-2 gives the average speed, the maximum value of v/c, the maximum density, and the corresponding maximum service flow rate for each LOS.

As with other LOS criteria, the maximum service flow rates in Exhibit 21-2 are stated in terms of flow rate based on the peak 15-min volume. Demand or forecast hourly volumes generally are divided by the peak-hour factor (PHF) to reflect a maximum hourly flow rate before comparison with the criteria of Exhibit 21-2. Using the basic speed-flow curves (see Exhibit 21-3), the relationships between LOS, flow, and speed can be analyzed.

DETERMINING FFS

FFS is measured using the mean speed of passenger cars operating in low-to-moderate flow conditions (up to 1,400 pc/h/ln). Mean speed is virtually constant across this range of flow rates. Field measurement and estimation with guidelines provided in this chapter are methods that can be used to determine FFS.

The field measurement procedure is for those who prefer to gather data directly or to incorporate the measurements into a speed-monitoring program. However, field measurements are not necessary to apply the method.

The FFS of a highway can be determined directly from a speed study conducted in the field. If field-measured data are used, no adjustments need to be made to FFS. The speed study should be conducted along a reasonable length of highway within the segment under evaluation; for example, an upgrade should not be selected within a site that is generally level. Any speed measurement technique acceptable for other types of traffic engineering speed studies can be used.

The field study should be conducted in the more stable regime of low-to-moderate flow conditions (up to 1,400 pc/h/ln). If the speed study must be conducted at a flow rate of more than 1,400 pc/h/ln, the FFS can be found by using the model speed-flow curve, assuming that data on traffic volumes are recorded at the same time.

FFS occurs at flow rates \leq
1,400 pc/h/ln

EXHIBIT 21-3. SPEED-FLOW CURVES WITH LOS CRITERIA

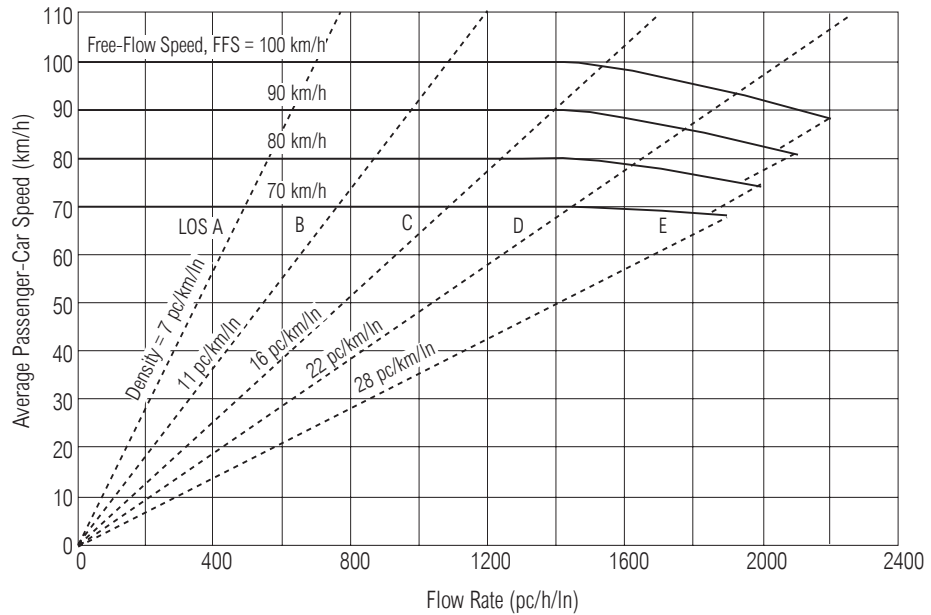

Note:

Maximum densities for LOS E occur at a v/c ratio of 1.0. They are 25, 26, 27, and 28 pc/km/ln at FFS of 100, 90, 80, and 70 km/h, respectively. Capacity varies by FFS. Capacity is 2,200, 2,100, 2,000, and 1,900 pc/h/ln at FFS of 100, 90, 80, and 70 km/h, respectively.

For flow rate (v_p), $v_p > 1,400$ and

$90 < \text{FFS} \leq 100$ then

$$S = \text{FFS} - \left[\left(\frac{9.3}{25} \text{FFS} - \frac{630}{25} \right) \left(\frac{v_p - 1,400}{15.7\text{FFS} - 770} \right)^{1.31} \right]$$

For $v_p > 1,400$ and

$80 < \text{FFS} \leq 90$ then

$$S = \text{FFS} - \left[\left(\frac{10.4}{26} \text{FFS} - \frac{696}{26} \right) \left(\frac{v_p - 1,400}{15.6\text{FFS} - 704} \right)^{1.31} \right]$$

For $v_p > 1,400$ and

$70 < \text{FFS} \leq 80$ then

$$S = \text{FFS} - \left[\left(\frac{11.1}{27} \text{FFS} - \frac{728}{27} \right) \left(\frac{v_p - 1,400}{15.9\text{FFS} - 672} \right)^{1.31} \right]$$

For $v_p > 1,400$ and

$\text{FFS} = 70$ then

$$S = \text{FFS} - \left[\left(\frac{3}{28} \text{FFS} - \frac{75}{14} \right) \left(\frac{v_p - 1,400}{25\text{FFS} - 1,250} \right)^{1.31} \right]$$

For $v_p \leq 1,400$, then

$S = \text{FFS}$

The speed study should measure the speeds of all passenger cars or of a systematic sampling of passenger cars (e.g., of every 10th passenger car). The speed study not only should measure speeds for unimpeded vehicles but also should include representative numbers of impeded vehicles. A sample should obtain at least 100 passenger-car speeds. Further guidance on the conduct of speed studies available in standard traffic engineering publications, such as the *Manual of Traffic Engineering Studies*, published by the Institute of Transportation Engineers (6).

The average passenger-car speed under low-volume conditions can be used as the free-flow speed if the field measurements were made at flow rates at or below 1,400 pc/h/ln. This FFS reflects the net effects of all conditions at the site that influence speed,

including those identified in this procedure (lane width, lateral clearance, type of median, and access points), as well as others, such as speed limit and vertical and horizontal alignment.

Highway agencies with ongoing speed-monitoring programs or with speed data on file might prefer to use those data rather than conduct a new speed study or use an indirect method to estimate speed. The data can be used directly if collected in accordance with the procedures presented above. Data including both passenger-car and heavy-vehicle speeds probably can be used for level terrain or moderate downgrades, but they should not be used for rolling or mountainous terrain.

ESTIMATING FFS

The FFS can be estimated indirectly when field data are not available.

$$FFS = BFFS - f_{LW} - f_{LC} - f_M - f_A \tag{21-1}$$

where

- $BFFS$ = base FFS (km/h);
- FFS = estimated FFS (km/h);
- f_{LW} = adjustment for lane width, from Exhibit 21-4 (km/h);
- f_{LC} = adjustment for lateral clearance, from Exhibit 21-5 (km/h);
- f_M = adjustment for median type, from Exhibit 21-6 (km/h); and
- f_A = adjustment for access points, from Exhibit 21-7 (km/h).

Base FFS

When it is not possible to use data from a similar roadway, an estimate might be necessary, based on available data, experience, and consideration of the variety of factors that have an identified effect on FFS. The speed limit is one factor that affects FFS. Recent research suggests that FFS on multilane highways under base conditions is approximately 11 km/h higher than the speed limit for 65 and 70 km/h speed limits, and it is 8 km/h higher for 80 and 90 km/h speed limits. Chapter 12 provides default values for base FFS.

Adjustment for Lane Width

Base conditions for multilane highways require 3.6-m lane widths. Exhibit 21-4 presents the adjustment to modify the estimated FFS to account for narrower lanes. Exhibit 21-4 shows that 3.0 m and 3.3 m lanes reduce free-flow speeds by 10.6 km/h and 3.1 km/h, respectively. For Exhibit 21-4, lane widths greater than 3.6 m are considered 3.6 m. There are no research data for lane widths less than 3.0 m.

EXHIBIT 21-4. ADJUSTMENT FOR LANE WIDTH

Lane Width (m)	Reduction in FFS (km/h)
3.6	0.0
3.5	1.0
3.4	2.1
3.3	3.1
3.2	5.6
3.1	8.1
3.0	10.6

For undivided highways and highways with two-way left-turn lanes (TWLTL), the left edge lateral clearance equals 1.8 m

Adjustment for Lateral Clearance

Exhibit 21-5 lists the speed reductions caused by the lateral clearance for fixed obstructions on the roadside or in the median. Fixed obstructions with lateral clearance effects include light standards, signs, trees, abutments, bridge rails, traffic barriers, and retaining walls. Standard raised curbs are not considered obstructions. Exhibit 21-5 shows the appropriate reduction in FFS based on the total lateral clearance, which is defined as

$$TLC = LC_R + LC_L \tag{21-2}$$

where

- TLC = total lateral clearance (m),
- LC_R = lateral clearance (m), from the right edge of the travel lanes to roadside obstructions (if greater than 1.8 m, use 1.8 m), and
- LC_L = lateral clearance (m), from the left edge of the travel lanes to obstructions in the roadway median (if the lateral clearance is greater than 1.8 m, use 1.8 m). For undivided roadways, there is no adjustment for left-side lateral clearance. The undivided design is taken into account by the median adjustment. To use Exhibit 21-5 for undivided highways, the lateral clearance on the left edge is always 1.8 m. Lateral clearance in the median of roadways with two-way left-turn lanes (TWLTLs) is considered to be 1.8 m.

EXHIBIT 21-5. ADJUSTMENT FOR LATERAL CLEARANCE

Four-Lane Highways		Six-Lane Highways	
Total Lateral Clearance ^a (m)	Reduction in FFS (km/h)	Total Lateral Clearance ^a (m)	Reduction in FFS (km/h)
3.6	0.0	3.6	0.0
3.0	0.6	3.0	0.6
2.4	1.5	2.4	1.5
1.8	2.1	1.8	2.1
1.2	3.0	1.2	2.7
0.6	5.8	0.6	4.5
0.0	8.7	0.0	6.3

Note:

a. Total lateral clearance is the sum of the lateral clearances of the median (if greater than 1.8 m, use 1.8 m) and shoulder (if greater than 1.8 m, use 1.8 m). Therefore, for purposes of analysis, total lateral clearance cannot exceed 3.6 m.

Thus, a total lateral clearance of 3.6 m is used for a completely unobstructed roadside and median; however, the actual value is used when obstructions are located closer to the roadway. The adjustment for lateral clearance on six-lane highways is slightly less than for four-lane highways because lateral obstructions have a minimal effect on traffic operations in the center lane of a three-lane roadway.

Median Type

The values in Exhibit 21-6 indicate that the average FFS should be decreased by 2.6 km/h for undivided highways to account for the friction caused by opposing traffic in an adjacent lane.

EXHIBIT 21-6. ADJUSTMENT FOR MEDIAN TYPE

Median Type	Reduction in FFS (km/h)
Undivided highways	2.6
Divided highways (including TWLTLs)	0.0

Adjustment for Access-Point Density

Exhibit 21-7 presents the adjustment to FFS for various levels of access-point density. The data indicate that for each access point per kilometer the estimated FFS decreases by approximately 0.4 km/h, regardless of the type of median. The access-point density on a divided roadway is determined by dividing the total number of access points (i.e., intersections and driveways) on the right side of the roadway in the direction of travel by the segment's total length in kilometers. An intersection or driveway should only be included if it influences traffic flow. Access points unnoticed by the driver or with little activity should not be included in determining access-point density.

EXHIBIT 21-7. ACCESS-POINT DENSITY ADJUSTMENT

Access Points/Kilometer	Reduction in FFS (km/h)
0	0.0
6	4.0
12	8.0
18	12.0
≥ 24	16.0

Although the access-point adjustments do not include data for one-way multilane highways, it might be appropriate to include intersections and driveways on both sides of a one-way roadway to determine the total number of access points per kilometer.

Guidelines for one-way highways

DETERMINING FLOW RATE

Two adjustments must be made to hourly volume counts or estimates to arrive at the equivalent passenger-car flow rate used in LOS analyses. These adjustments are the PHF and the heavy vehicle adjustment factor. The number of lanes also is used so that the flow rate can be expressed on a per-lane basis. These adjustments are applied in the following manner using Equation 21-3.

$$v_p = \frac{V}{PHF * N * f_{HV} * f_p} \quad (21-3)$$

where

- v_p = 15-min passenger-car equivalent flow rate (pc/h/ln),
- V = hourly volume (veh/h),
- PHF = peak-hour factor,
- N = number of lanes,
- f_{HV} = heavy-vehicle adjustment factor, and
- f_p = driver population factor.

PHF

PHF represents the variation in traffic flow within an hour. Observations of traffic flow consistently indicate that the flow rates found in the peak 15-min period within an hour are not sustained throughout the entire hour. The application of PHF in Equation 21-3 accounts for this phenomenon.

Heavy-Vehicle Adjustments

The presence of heavy vehicles in the traffic stream decreases the FFS because base conditions allow a traffic stream of passenger cars only. Therefore, traffic volumes must be adjusted to reflect an equivalent flow rate expressed in passenger cars per hour per lane (pc/h/ln). This is accomplished by applying the heavy-vehicle factor (f_{HV}). Once values for E_T and E_R have been determined, the adjustment factor for heavy vehicles may be computed as shown in Equation 21-4.

$$f_{HV} = \frac{1}{1 + P_T(E_T - 1) + P_R(E_R - 1)} \quad (21-4)$$

where

- E_T and E_R = passenger-car equivalents for trucks and buses and for recreational vehicles (RVs), respectively;
- P_T and P_R = proportion of trucks and buses, and RVs, respectively, in the traffic stream (expressed as a decimal fraction); and
- f_{HV} = adjustment factor for heavy vehicles.

Adjustment for heavy vehicles in the traffic stream applies to three types of vehicles: trucks, RVs, and buses. No evidence indicates any distinct differences in the performance characteristics of trucks and buses on multilane highways; therefore, buses are considered trucks in this method. Finding the heavy-vehicle adjustment factor requires two steps. First, find an equivalent truck factor (E_T) and RV factor (E_R) for prevailing operating conditions. Second, using E_T and E_R , compute an adjustment factor for all heavy vehicles in the traffic stream.

Extended General Highway Segments

Passenger-car equivalents can be selected for two conditions: extended general highway segments and specific grades. Values of passenger-car equivalents are selected from Exhibits 21-8 through 21-11. For long segments of highway in which no single grade has a significant impact on operations, Exhibit 21-8 is used to select passenger-car equivalents for trucks and buses (E_T) and for RVs (E_R).

EXHIBIT 21-8. PASSENGER-CAR EQUIVALENTS ON EXTENDED GENERAL HIGHWAY SEGMENTS

Factor	Type of Terrain		
	Level	Rolling	Mountainous
E_T (trucks and buses)	1.5	2.5	4.5
E_R (RVs)	1.2	2.0	4.0

A long multilane highway segment can be classified as an extended general highway segment if no grade exceeding 3 percent is longer than 0.8 km, and if grades of 3 percent or less do not exceed 1.6 km.

Specific Grade

Any grade of 3 percent or less that is longer than 1.6 km or a grade greater than 3 percent that is longer than 0.8 km should be treated as an isolated, specific grade. In addition, the upgrade and downgrade must be treated separately, because the impact of heavy vehicles differs substantially in each.

Equivalents for Extended General Highway Segments

For an extended general segment analysis, the terrain of the highway must be classified as level, rolling, or mountainous. These three classifications are discussed below.

Level Terrain

Level terrain is any combination of horizontal and vertical alignment that permits heavy vehicles to maintain approximately the same speed as passenger cars. This type of terrain generally includes short grades of no more than 1 to 2 percent.

Rolling Terrain

Rolling terrain is any combination of horizontal and vertical alignment that causes heavy vehicles to reduce their speeds substantially below those of passenger cars. However, the terrain does not cause heavy vehicles to operate at crawl speeds for any significant length of time or at frequent intervals.

Mountainous Terrain

Mountainous terrain is any combination of horizontal and vertical alignment that causes heavy vehicles to operate at crawl speeds for significant distances or at frequent intervals. For these general highway segments, values of E_T and E_R are selected from Exhibit 21-8.

Equivalents for Specific Grades

Any highway grade of more than 1.6 km for grades less than 3 percent or of 0.8 km for grades of 3 percent or more should be considered a separate segment. Analysis of such segments must consider the upgrade and downgrade conditions and whether the grade is single and isolated, with a constant percentage of change, or part of a series forming a composite grade.

Equivalents for Specific Upgrades

Exhibits 21-9 and 21-10 give passenger-car equivalents for trucks and buses (E_T) and for RVs (E_R), respectively, on uniform upgrades on four- and six-lane highways. Exhibit 21-9 is based on an average weight-to-power ratio of 100 kg/kW, which is typical of trucks on multilane highways in the United States.

Weight-to-power ratio for trucks

Equivalents for Specific Downgrades

Downgrade conditions for trucks and buses on four- or six-lane highways are analyzed using equivalents from Exhibit 21-11. For all downgrades less than 4 percent and for steeper downgrades less than or equal to 3.2 km long, use the passenger-car equivalents for trucks and buses in level terrain, given in Exhibit 21-8. For grades of at least 4 percent and longer than 3.2 km, use the specific values shown in Exhibit 21-11. For all cases of RVs on downgrades, use the passenger-car equivalents for level terrain, given in Exhibit 21-8.

Equivalents for Composite Grades

When several consecutive grades of different steepness form a composite grade, an average, uniform grade is computed and used in analysis. The average grade is commonly computed as the total rise from the beginning of the grade divided by the total horizontal distance over which the rise occurs.

The composite grade technique is reasonably accurate for segment lengths of 1200 m or less, or for grades of 4 percent or less. For steeper grades and longer segment lengths, a more exact technique is described in Appendix A of Chapter 23. If a large change in grade occurs for a significant length, the analyst should consider segmenting the roadway to apply the composite grade technique.

Sometimes a single, steep grade creates a critical effect that might not be identified in a length of highway to be analyzed; in this case, the composite grade technique can be supplemented by a specific grade analysis.

Generally, an average grade can be used to represent consecutive grades, but for a more detailed method, see Appendix A of Chapter 23

EXHIBIT 21-9. PASSENGER-CAR EQUIVALENTS FOR TRUCKS AND BUSES ON UNIFORM UPGRADES

Upgrade (%)	Length (km)	E_T								
		Percentage of Trucks and Buses								
		2	4	5	6	8	10	15	20	25
<2	All	1.5	1.5	1.5	1.5	1.5	1.5	1.5	1.5	1.5
≥ 2-3	0.0-0.4	1.5	1.5	1.5	1.5	1.5	1.5	1.5	1.5	1.5
	> 0.4-0.8	1.5	1.5	1.5	1.5	1.5	1.5	1.5	1.5	1.5
	> 0.8-1.2	1.5	1.5	1.5	1.5	1.5	1.5	1.5	1.5	1.5
	> 1.2-1.6	2.0	2.0	2.0	2.0	1.5	1.5	1.5	1.5	1.5
	> 1.6-2.4	2.5	2.5	2.5	2.5	2.0	2.0	2.0	2.0	2.0
	> 2.4	3.0	3.0	2.5	2.5	2.0	2.0	2.0	2.0	2.0
> 3-4	0.0-0.4	1.5	1.5	1.5	1.5	1.5	1.5	1.5	1.5	1.5
	> 0.4-0.8	2.0	2.0	2.0	2.0	2.0	2.0	1.5	1.5	1.5
	> 0.8-1.2	2.5	2.5	2.0	2.0	2.0	2.0	2.0	2.0	2.0
	> 1.2-1.6	3.0	3.0	2.5	2.5	2.5	2.5	2.0	2.0	2.0
	> 1.6-2.4	3.5	3.5	3.0	3.0	3.0	3.0	2.5	2.5	2.5
	> 2.4	4.0	3.5	3.0	3.0	3.0	3.0	2.5	2.5	2.5
> 4-5	0.0-0.4	1.5	1.5	1.5	1.5	1.5	1.5	1.5	1.5	1.5
	> 0.4-0.8	3.0	2.5	2.5	2.5	2.0	2.0	2.0	2.0	2.0
	> 0.8-1.2	3.5	3.0	3.0	3.0	2.5	2.5	2.5	2.5	2.5
	> 1.2-1.6	4.0	3.5	3.5	3.5	3.0	3.0	3.0	3.0	3.0
	> 1.6	5.0	4.0	4.0	4.0	3.5	3.5	3.0	3.0	3.0
> 5-6	0.0-0.4	2.0	2.0	1.5	1.5	1.5	1.5	1.5	1.5	1.5
	> 0.4-0.5	4.0	3.0	2.5	2.5	2.0	2.0	2.0	2.0	2.0
	> 0.5-0.8	4.5	4.0	3.5	3.0	2.5	2.5	2.5	2.5	2.5
	> 0.8-1.2	5.0	4.5	4.0	3.5	3.0	3.0	3.0	3.0	3.0
	> 1.2-1.6	5.5	5.0	4.5	4.0	3.0	3.0	3.0	3.0	3.0
	> 1.6	6.0	5.0	5.0	4.5	3.5	3.5	3.5	3.5	3.5
> 6	0.0-0.4	4.0	3.0	2.5	2.5	2.5	2.5	2.0	2.0	2.0
	> 0.4-0.5	4.5	4.0	3.5	3.5	3.5	3.0	2.5	2.5	2.5
	> 0.5-0.8	5.0	4.5	4.0	4.0	3.5	3.0	2.5	2.5	2.5
	> 0.8-1.2	5.5	5.0	4.5	4.5	4.0	3.5	3.0	3.0	3.0
	> 1.2-1.6	6.0	5.5	5.0	5.0	4.5	4.0	3.5	3.5	3.5
	> 1.6	7.0	6.0	5.5	5.5	5.0	4.5	4.0	4.0	4.0

EXHIBIT 21-10. PASSENGER-CAR EQUIVALENTS FOR RVs ON UNIFORM UPGRADES

Grade (%)	Length (km)	E_R								
		Percentage of RVs								
		2	4	5	6	8	10	15	20	25
≤2	All	1.2	1.2	1.2	1.2	1.2	1.2	1.2	1.2	1.2
> 2-3	0.0-0.8	1.2	1.2	1.2	1.2	1.2	1.2	1.2	1.2	1.2
	> 0.8	3.0	1.5	1.5	1.5	1.5	1.5	1.2	1.2	1.2
> 3-4	0.0-0.4	1.2	1.2	1.2	1.2	1.2	1.2	1.2	1.2	1.2
	> 0.4-0.8	2.5	2.5	2.0	2.0	2.0	2.0	1.5	1.5	1.5
	> 0.8	3.0	2.5	2.5	2.5	2.0	2.0	2.0	1.5	1.5
> 4-5	0.0-0.4	2.5	2.0	2.0	2.0	1.5	1.5	1.5	1.5	1.5
	> 0.4-0.8	4.0	3.0	3.0	3.0	2.5	2.5	2.0	2.0	2.0
	> 0.8	4.5	3.5	3.0	3.0	3.0	2.5	2.5	2.0	2.0
> 5	0.0-0.4	4.0	3.0	2.5	2.5	2.5	2.0	2.0	2.0	1.5
	> 0.4-0.8	6.0	4.0	4.0	3.5	3.0	3.0	2.5	2.5	2.0
	> 0.8	6.0	4.5	4.0	4.5	3.5	3.0	3.0	2.5	2.0

EXHIBIT 21-11. PASSENGER-CAR EQUIVALENTS FOR TRUCKS ON DOWNGRADES

Downgrade (%)	Length (km)	E_T			
		Percentage of Trucks			
		5	10	15	20
< 4	All	1.5	1.5	1.5	1.5
4-5	≤ 6.4	1.5	1.5	1.5	1.5
4-5	> 6.4	2.0	2.0	2.0	1.5
> 5-6	≤ 6.4	1.5	1.5	1.5	1.5
> 5-6	> 6.4	5.5	4.0	4.0	3.0
> 6	≤ 6.4	1.5	1.5	1.5	1.5
> 6	> 6.4	7.5	6.0	5.5	4.5

Driver Population Factor

The adjustment factor f_p reflects the effect weekend recreational and perhaps even midday drivers have on the facility. The values for f_p range from 0.85 to 1.00. Typically, the analyst should select 1.00, which reflects weekday commuter traffic (i.e., users familiar with the highway), unless there is sufficient evidence that a lesser value, reflecting more recreational or weekend traffic characteristics, should be applied. When greater accuracy is needed, comparative field studies of weekday and weekend traffic flow and speeds are recommended.

DETERMINING LOS

The LOS on a multilane highway can be determined directly from Exhibit 21-3 on the basis of the FFS and the service flow rate (v_p) in pc/h/ln. The procedure is as follows:

- Step 1. Define and segment the highway as appropriate.
- Step 2. On the basis of the measured or estimated FFS, construct an appropriate speed-flow curve of the same shape as the typical curves shown in Exhibit 21-3. The curve should intercept the y-axis at the FFS.
- Step 3. Based on the flow rate v_p , read up to the FFS curve identified in Step 2 and determine the average passenger-car speed and LOS corresponding to that point.
- Step 4. Determine the density of flow according to Equation 21-5.

$$D = \frac{v_p}{S} \quad (21-5)$$

where

- D = density (pc/km/ln),
- v_p = flow rate (pc/h/ln), and
- S = average passenger-car travel speed (km/h).

The LOS also can be determined by comparing the computed density with the density ranges provided in Exhibit 21-2.

SENSITIVITY OF RESULTS TO INPUT VARIABLES

Exhibit 21-12 shows the impact of v/c ratios on passenger-car speed for multilane highways. Note that speed is insensitive to demand until demand is at least 70 percent of capacity; also note that the mean speed on lower-speed segments is not sensitive to demand until the demand reaches at least 90 percent of capacity.

EXHIBIT 21-12. EFFECT OF v/c RATIO ON MEAN SPEED

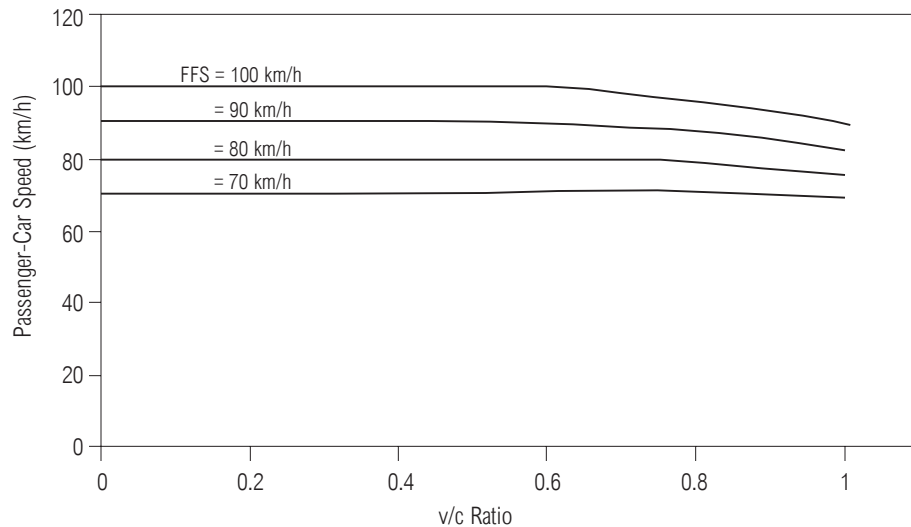

For guidelines on required inputs and estimated values, see Chapter 12, "Highway Concepts"

III. APPLICATIONS

The methodology of this chapter can be used to analyze the capacity and LOS of multilane highways. The analyst must address two fundamental questions. First, the primary output must be identified. Primary outputs typically solved for in a variety of applications include LOS, number of lanes required (N), and flow rate achievable (v_p). Performance measures related to density (D) and speed (S) are also achievable but are considered secondary outputs.

Second, the analyst must identify the default values or estimated values for use in the analysis. Basically, the analyst has three sources of input data:

1. Default values found in this manual;
2. Estimates and locally derived default values developed by the user; and
3. Values derived from field measurements and observation.

For each of the input variables, a value must be supplied to calculate the outputs, both primary and secondary.

A common application of the method is to compute the LOS of an existing segment or of a changed segment in the near term or distant future. This type of application is often termed operational, and its primary output is LOS, with secondary outputs for density and speed. Another application is to check the adequacy or to recommend the required number of lanes for a multilane highway given the volume or flow rate and LOS goal. This is termed a design application since its primary output is the number of lanes required to serve the assumed conditions. Other outputs from this application include speed and density. Finally, the achievable flow rate v_p can be calculated as a primary output. This analysis requires stating a LOS goal and a number of lanes as inputs. This analysis typically estimates the point at which a flow rate will cause the highway to operate at an unacceptable LOS.

Another general type of analysis can be termed planning. These analyses use estimates, *Highway Capacity Manual* (HCM) default values, and local default values as inputs in the calculation. As outputs, LOS, number of lanes, or flow rate can be determined, along with the secondary outputs of density and speed. The difference between planning analysis and operational or design analysis is that most or all of the input values in planning come from estimates or default values, but the operational and design analyses tend to use field measurements or known values for most or all of the

input variables. Note that for each of the analyses, FFS, either measured or estimated, is required as an input for the computation.

SEGMENTING THE HIGHWAY

The procedures described in this chapter are best applied to homogeneous segments of roadway, for which the variables affecting travel speeds are constant. Therefore, it is often necessary for the analyst to divide a section of highway into separate segments for analysis. The following conditions generally necessitate segmenting the highway:

- A change in the basic number of travel lanes along the highway,
- A change in the median treatment along the highway,
- A change of grade of 2 percent or more or a constant upgrade over 1220 m,
- The presence of a traffic signal or a stop sign along the multilane highway,
- A significant change in the density of access points,
- A change in speed limits, and
- The presence of a bottleneck condition.

In general, when segmenting a highway for analysis, the minimum length of a study segment should be 760 m. Also, the limits of study segments should be no closer than 0.4 km to a signalized intersection. The procedures in this chapter are based on average conditions observed over an extended highway segment with generally consistent physical characteristics.

Study segments should be at least 760 m long and 0.4 km from a signal

COMPUTATIONAL STEPS

The multilane highways worksheet for computations is shown in Exhibit 21-13. For all applications, the analyst provides general information and site information.

For operational (LOS) analysis, all speed and flow data are entered as inputs. Equivalent flow is then computed with the aid of the exhibits for passenger-car equivalencies. FFS is estimated by adjusting a base FFS. Finally, LOS is determined by entering (with v_p) the speed-flow graph at the top of the worksheet and intersecting the specific curve that has been selected or constructed for the highway segment.

Operational (LOS) analysis

This point of intersection identifies the LOS and, on the vertical axis of the graph, the estimated speed S . If the analyst requires a value for density D , it is calculated as v_p/S .

Design (N) analysis

The key to design analysis for number of lanes N is establishing an hourly volume. All information, with the exception of number of lanes, can be entered in the flow input and speed input portion of the worksheet (see Exhibit 21-13). An FFS, either computed or measured directly, is entered on the worksheet. The appropriate curve representing the FFS is established on the graph. The required or desired LOS is also entered. Then, the analyst assumes N and computes flow v_p with the aid of the exhibits for passenger-car equivalencies. LOS is determined by entering the speed-flow graph with v_p at the top of the worksheet. The derived LOS is compared with the desired LOS. This process is then repeated, adding one lane to the previously assumed number of lanes, until the determined LOS matches or is better than the desired LOS. Density is calculated using v_p and S .

Design (v_p) analysis

The objective of design analysis for flow rate v_p is to estimate the flow rate in pc/h/ln given a set of traffic, roadway, and FFS conditions. A desired LOS is entered on the worksheet. Then, the FFS of the segment is established using either the base FFS and the four adjustment factors or an FFS measured in the field. Once this segment speed-flow curve is established, the analyst can determine what flow rate is achievable with the given LOS. This would be considered the maximum flow rate achievable or allowable for the given level. Also directly available from the graph is the average passenger-car speed. Finally, if required, a value for density can be calculated, using v_p and S .

PLANNING APPLICATIONS

The three planning applications—planning for LOS, flow rate v_p , and number of lanes N —correspond directly to the procedures described for operations and design. The

Planning (LOS), Planning (v_p), and Planning (N) applications

primary criterion categorizing these as planning applications is the use of estimates, HCM default values, and local default values for inputs into the calculations. The use of annual average daily traffic (AADT) to estimate directional design-hour volume (DDHV) also characterizes a planning application. (For guidelines on computing DDHV, refer to Chapter 8.)

To perform planning applications, the analyst typically has few, if any, of the required input values. Chapter 12 contains more information on the use of default values.

EXHIBIT 21-13. MULTILANE HIGHWAYS WORKSHEET

MULTILANE HIGHWAYS WORKSHEET																								
		<table border="1" style="width: 100%; border-collapse: collapse;"> <thead> <tr> <th>Application</th> <th>Input</th> <th>Output</th> </tr> </thead> <tbody> <tr> <td>Operational (LOS)</td> <td>FFS, N, v_p</td> <td>LOS, S, D</td> </tr> <tr> <td>Design (N)</td> <td>FFS, LOS, v_p</td> <td>N, S, D</td> </tr> <tr> <td>Design (v_p)</td> <td>FFS, LOS, N</td> <td>v_p, S, D</td> </tr> <tr> <td>Planning (LOS)</td> <td>FFS, N, AADT</td> <td>LOS, S, D</td> </tr> <tr> <td>Planning (N)</td> <td>FFS, LOS, AADT</td> <td>N, S, D</td> </tr> <tr> <td>Planning (v_p)</td> <td>FFS, LOS, N</td> <td>v_p, S, D</td> </tr> </tbody> </table>		Application	Input	Output	Operational (LOS)	FFS, N, v _p	LOS, S, D	Design (N)	FFS, LOS, v _p	N, S, D	Design (v _p)	FFS, LOS, N	v _p , S, D	Planning (LOS)	FFS, N, AADT	LOS, S, D	Planning (N)	FFS, LOS, AADT	N, S, D	Planning (v _p)	FFS, LOS, N	v _p , S, D
Application	Input	Output																						
Operational (LOS)	FFS, N, v _p	LOS, S, D																						
Design (N)	FFS, LOS, v _p	N, S, D																						
Design (v _p)	FFS, LOS, N	v _p , S, D																						
Planning (LOS)	FFS, N, AADT	LOS, S, D																						
Planning (N)	FFS, LOS, AADT	N, S, D																						
Planning (v _p)	FFS, LOS, N	v _p , S, D																						
General Information		Site Information																						
Analyst _____ Agency or Company _____ Date Performed _____ Analysis Time Period _____		Highway/Direction of Travel _____ From/To _____ Jurisdiction _____ Analysis Year _____																						
<input type="checkbox"/> Operational (LOS) <input type="checkbox"/> Design (N) <input type="checkbox"/> Design (v _p) <input type="checkbox"/> Planning (LOS) <input type="checkbox"/> Planning (N) <input type="checkbox"/> Planning (v _p)																								
Flow Inputs																								
Volume, V _____ veh/h Annual avg. daily traffic, AADT _____ veh/day Peak-hour proportion of AADT, K _____ Peak-hour direction proportion, D _____ DDHV = AADT * K * D _____ veh/h Driver type <input type="checkbox"/> Commuter/Weekday <input type="checkbox"/> Recreational/Weekend		Peak-hour factor, PHF _____ % Trucks and buses, P _T _____ % RVs, P _R _____ General terrain <input type="checkbox"/> Level <input type="checkbox"/> Rolling <input type="checkbox"/> Mountainous Grade: Length _____ km Up/Down _____ % Number of lanes _____																						
Calculate Flow Adjustments																								
f _p _____ E _T _____		E _R _____ $f_{HV} = \frac{1}{1 + P_T(E_T - 1) + P_R(E_R - 1)}$																						
Speed Inputs		Calculate Speed Adjustments and FFS																						
Lane width, LW _____ m Total lateral clearance, TLC _____ m Access points, A _____ A/km Median type, M <input type="checkbox"/> Undivided <input type="checkbox"/> Divided FFS (measured) _____ km/h Base free-flow Speed, BFFS _____ km/h		f _{LW} _____ km/h f _{LC} _____ km/h f _A _____ km/h f _M _____ km/h FFS = BFFS - f _{LW} - f _{LC} - f _A - f _M _____ km/h																						
Operational, Planning (LOS); Design, Planning (v _p)		Design, Planning (N)																						
Operational (LOS) or Planning (LOS) $v_p = \frac{V \text{ or DDHV}}{PHF * N * f_{HV} * f_p}$ _____ pc/h/ln S _____ km/h D = v _p /S _____ pc/km/ln LOS _____ Design (v _p) or Planning (v _p) LOS _____ v _p _____ pc/h/ln V = v _p * PHF * N * f _{HV} * f _p _____ veh/h S _____ km/h D = v _p /S _____ pc/km/ln		Design (N) or Planning (N) 1st Iteration N _____ assumed $v_p = \frac{V \text{ or DDHV}}{PHF * N * f_{HV} * f_p}$ _____ pc/h/ln LOS _____ Design (N) or Planning (N) 2nd Iteration N _____ assumed $v_p = \frac{V \text{ or DDHV}}{PHF * N * f_{HV} * f_p}$ _____ pc/h/ln LOS _____ S _____ km/h D = v _p /S _____ pc/km/ln																						
Glossary		Factor Location																						
N - Number of lanes V - Hourly volume v _p - Flow rate LOS - Level of service DDHV - Directional design-hour volume		S - Speed D - Density FFS - Free-flow speed BFFS - Base free-flow speed																						
		E _T - Exhibit 21-8, 21-9, 21-11 E _R - Exhibit 21-8, 21-10 f _p - Page 21-11 LOS, S, FFS, v _p - Exhibit 21-2, 21-3																						
		f _{LW} - Exhibit 21-4 f _{LC} - Exhibit 21-5 f _M - Exhibit 21-6 f _A - Exhibit 21-7																						

ANALYSIS TOOLS

The multilane highways worksheet shown in Exhibit 21-13 and provided in Appendix A can be used to perform all applications, including operational for LOS; design for flow rate v_p and number of lanes N ; and planning for LOS, v_p , and N .

IV. EXAMPLE PROBLEMS

Problem No.	Description	Application
1	Find LOS on an undivided four-lane highway	Operational (LOS)
2	Find LOS on a five-lane highway with TWLTL	Operational (LOS)
3	Find the cross section required within a right-of-way to achieve desired LOS	Planning (N)
4	Find how much additional traffic can be accommodated by grade separation of a signalized intersection on a highway segment	Planning (v_p)
5	Find opening-day volume and number of lanes on a new suburban highway facility	Planning (N)

EXAMPLE PROBLEM 1 (PART I)

The Highway A 5.23-km undivided four-lane highway on level terrain. A 975-m segment with 2.5 percent grade also is included in the study.

The Question What are the peak-hour LOS, speed, and density for the level terrain portion of the highway?

The Facts

- √ Level terrain,
- √ 74.0-km/h field-measured FFS,
- √ 3.4-m lane width,
- √ 1,900-veh/h peak-hour volume,
- √ 13 percent trucks and buses,
- √ 2 percent RVs, and
- √ 0.90 PHF.

Outline of Solution All input parameters are known. Demand will be computed in terms of pc/h/ln, and the LOS determined from the speed-flow diagram. An estimate of passenger-car speed is determined from the graph, and a value of density is calculated using speed and flow rate.

Steps

<p>1. Find f_{HV} (use Exhibit 21-8 and Equation 21-4)</p>	$f_{HV} = \frac{1}{1 + P_T(E_T - 1) + P_R(E_R - 1)}$ $f_{HV} = \frac{1}{1 + 0.13(1.5 - 1) + 0.02(1.2 - 1)}$ $f_{HV} = 0.935$
<p>2. Find v_p (use Equation 21-3)</p>	$v_p = \frac{V}{PHF * N * f_{HV} * f_p}$ $v_p = \frac{1,900}{0.90 * 2 * 0.935 * 1.00}$ $v_p = 1,129 \text{ pc/h/ln}$
<p>3. Determine LOS (use Exhibit 21-3)</p>	<p>LOS C</p>

The Results

- LOS C,
- Speed = 74.0 km/h, and
- Density = 15.3 pc/km/ln.

MULTILANE HIGHWAYS WORKSHEET

Application	Input	Output
Operational (LOS)	FFS, N, v_p	LOS, S, D
Design (N)	FFS, LOS, v_p	N, S, D
Design (v_p)	FFS, LOS, N	v_p , S, D
Planning (LOS)	FFS, N, AADT	LOS, S, D
Planning (N)	FFS, LOS, AADT	N, S, D
Planning (v_p)	FFS, LOS, N	v_p , S, D

General Information

Analyst: JMYE
 Agency or Company: EHI
 Date Performed: 5/16/99
 Analysis Time Period: AM

Site Information

Highway/Direction of Travel: US 80 (East)
 From/To: MP 17 - MP 20
 Jurisdiction: M. County
 Analysis Year: 1999

Operational (LOS) Design (N) Design (v_p)

Planning (LOS) Planning (N) Planning (v_p)

Flow Inputs

Volume, V: <u>1,900</u> veh/h	Peak-hour factor, PHF: <u>0.90</u>
Annual avg. daily traffic, AADT: _____ veh/day	% Trucks and buses, P_T : <u>13</u>
Peak-hour proportion of AADT, K: _____	% RVs, P_R : <u>2</u>
Peak-hour direction proportion, D: _____	General terrain:
DDHV = AADT * K * D: _____ veh/h	<input checked="" type="checkbox"/> Level <input type="checkbox"/> Rolling <input type="checkbox"/> Mountainous
Driver type:	Grade: Length _____ km Up/Down _____ %
<input checked="" type="checkbox"/> Commuter/Weekday <input type="checkbox"/> Recreational/Weekend	Number of lanes: <u>2</u>

Calculate Flow Adjustments

f_p : <u>1.00</u>	E_R : <u>1.2</u>
E_T : <u>1.5</u>	$f_{HV} = \frac{1}{1 + P_T(E_T - 1) + P_R(E_R - 1)}$: <u>0.935</u>

Speed Inputs

Lane width, LW: 3.4 m
 Total lateral clearance, TLC: _____ m
 Access points, A: _____ A/km
 Median type, M: Undivided Divided
 FFS (measured): 74.0 km/h
 Base free-flow Speed, BFFS: _____ km/h

Calculate Speed Adjustments and FFS

f_{LW} : _____ km/h
 f_{LC} : _____ km/h
 f_A : _____ km/h
 f_M : _____ km/h
 $FFS = BFFS - f_{LW} - f_{LC} - f_A - f_M$: _____ km/h

Operational, Planning (LOS); Design, Planning (v_p)

Operational (LOS) or Planning (LOS)
 $v_p = \frac{V \text{ or } DDHV}{PHF * N * f_{HV} * f_p}$: 1129 pc/h/ln
 S : 74.0 km/h
 $D = v_p / S$: 15.3 pc/km/ln
 LOS: C

Design (v_p) or Planning (v_p)
 LOS: _____
 v_p : _____ pc/h/ln
 $V = v_p * PHF * N * f_{HV} * f_p$: _____ veh/h
 S : _____ km/h
 $D = v_p / S$: _____ pc/km/ln

Design, Planning (N)

Design (N) or Planning (N) 1st Iteration
 N : _____ assumed
 $v_p = \frac{V \text{ or } DDHV}{PHF * N * f_{HV} * f_p}$: _____ pc/h/ln
 LOS: _____

Design (N) or Planning (N) 2nd Iteration
 N : _____ assumed
 $v_p = \frac{V \text{ or } DDHV}{PHF * N * f_{HV} * f_p}$: _____ pc/h/ln
 LOS: _____
 S : _____ km/h
 $D = v_p / S$: _____ pc/km/ln

Glossary

N - Number of lanes
 V - Hourly volume
 v_p - Flow rate
 LOS - Level of service
 DDHV - Directional design-hour volume

Factor Location

E_T - Exhibit 21-8, 21-9, 21-11
 E_R - Exhibit 21-8, 21-10
 f_p - Page 21-11
 LOS, S, FFS, v_p - Exhibit 21-2, 21-3

f_{LW} - Exhibit 21-4
 f_{LC} - Exhibit 21-5
 f_M - Exhibit 21-6
 f_A - Exhibit 21-7

EXAMPLE PROBLEM 1 (PART II)

The Highway A 5.23-km undivided four-lane highway on level terrain. A 975-m segment with 2.5 percent grade also is included in the study.

The Question What are peak-hour LOS, speed, and density of traffic on the 2.5 percent grade? Does this operation still meet the minimum required LOS D?

The Facts

- √ 2.5 percent grade (upgrade and downgrade),
- √ 74.0-km/h field-measured FFS,
- √ 3.4-m lane width,
- √ 1,900-veh/h peak-hour volume,
- √ 13 percent trucks and buses,
- √ 2 percent RVs, and
- √ 0.90 PHF.

Comments

- √ For the 2.5 percent downgrade, trucks, buses, and RVs all operate as though on level terrain. Therefore, results obtained in Part I are applicable for downgrade results of the 2.5 percent grade segment.
- √ Assume FFS of 74.0 km/h applies to both upgrade and downgrade segments.

Outline of Solution All input parameters are known. Demand will be computed in terms of pc/h/ln, and the LOS determined from the speed-flow diagram. An estimate of passenger-car speed is determined from the graph, and a value of density is calculated using speed and flow rate.

Steps

1. Find f_{HV} (use Exhibits 21-9 and 21-10).	$f_{HV} = \frac{1}{1 + P_T(E_T - 1) + P_R(E_R - 1)}$ $f_{HV} = \frac{1}{1 + 0.13(1.5 - 1) + 0.02(3.0 - 1)}$ $f_{HV} = 0.905$
2. Find v_p .	$v_p = \frac{V}{PHF * N * f_{HV} * f_p}$ $v_p = \frac{1,900}{0.90 * 2 * 0.905 * 1.00}$ $v_p = 1,166 \text{ pc/h/ln}$
3. Determine LOS (use Exhibit 21-3).	LOS C (upgrade) LOS C (downgrade)

The Results

- | | |
|---|---|
| Downgrade: <ul style="list-style-type: none"> • LOS C, • Speed = 74.0 km/h, and • Density = 15.3 pc/km/ln. | Upgrade: <ul style="list-style-type: none"> • LOS C, • Speed = 74.0 km/h, and • Density = 15.8 pc/km/ln. |
|---|---|

MULTILANE HIGHWAYS WORKSHEET

Application	Input	Output
Operational (LOS)	FFS, N, v_p	LOS, S, D
Design (N)	FFS, LOS, v_p	N, S, D
Design (v_p)	FFS, LOS, N	v_p , S, D
Planning (LOS)	FFS, N, AADT	LOS, S, D
Planning (N)	FFS, LOS, AADT	N, S, D
Planning (v_p)	FFS, LOS, N	v_p , S, D

General Information

Analyst: JMYE
 Agency or Company: EHI
 Date Performed: 5/16/99
 Analysis Time Period: AM

Site Information

Highway/Direction of Travel: US 80 (East)
 From/To: MP 17 - MP 20
 Jurisdiction: M. County
 Analysis Year: 1999

Operational (LOS) Design (N) Design (v_p)

Planning (LOS) Planning (N) Planning (v_p)

Flow Inputs

Volume, V	<u>1,900</u> veh/h	Peak-hour factor, PHF	<u>0.90</u>
Annual avg. daily traffic, AADT	_____ veh/day	% Trucks and buses, P_T	<u>13</u>
Peak-hour proportion of AADT, K	_____	% RVs, P_R	<u>2</u>
Peak-hour direction proportion, D	_____	General terrain	
DDHV = AADT * K * D	_____ veh/h	<input type="checkbox"/> Level <input type="checkbox"/> Rolling <input type="checkbox"/> Mountainous	
Driver type		Grade: Length <u>0.975</u> km Up/Down <u>2.5 (up)</u> %	
<input checked="" type="checkbox"/> Commuter/Weekday <input type="checkbox"/> Recreational/Weekend		Number of lanes	<u>2</u>

Calculate Flow Adjustments

f_p	<u>1.00</u>	E_R	<u>3.0</u>
E_T	<u>1.5</u>	$f_{HV} = \frac{1}{1 + P_T(E_T - 1) + P_R(E_R - 1)}$	<u>0.905</u>

Speed Inputs

Lane width, LW: 3.4 m
 Total lateral clearance, TLC: _____ m
 Access points, A: _____ A/km
 Median type, M: Undivided Divided
 FFS (measured): 74.0 km/h
 Base free-flow Speed, BFFS: _____ km/h

Calculate Speed Adjustments and FFS

f_{LW} : _____ km/h
 f_{LC} : _____ km/h
 f_A : _____ km/h
 f_M : _____ km/h
 FFS = BFFS - f_{LW} - f_{LC} - f_A - f_M : _____ km/h

Operational, Planning (LOS); Design, Planning (v_p)

Operational (LOS) or Planning (LOS)
 $v_p = \frac{V \text{ or DDHV}}{PHF * N * f_{HV} * f_p}$: 1166 pc/h/ln
 S: 74.0 km/h
 D = v_p/S : 15.8 pc/km/ln
 LOS: C

Design (v_p) or Planning (v_p)
 LOS: _____
 v_p : _____ pc/h/ln
 $V = v_p * PHF * N * f_{HV} * f_p$: _____ veh/h
 S: _____ km/h
 D = v_p/S : _____ pc/km/ln

Design, Planning (N)

Design (N) or Planning (N) 1st Iteration
 N: _____ assumed
 $v_p = \frac{V \text{ or DDHV}}{PHF * N * f_{HV} * f_p}$: _____ pc/h/ln
 LOS: _____

Design (N) or Planning (N) 2nd Iteration
 N: _____ assumed
 $v_p = \frac{V \text{ or DDHV}}{PHF * N * f_{HV} * f_p}$: _____ pc/h/ln
 LOS: _____
 S: _____ km/h
 D = v_p/S : _____ pc/km/ln

Glossary

N - Number of lanes
 V - Hourly volume
 v_p - Flow rate
 LOS - Level of service
 DDHV - Directional design-hour volume

Factor Location

E_T - Exhibit 21-8, 21-9, 21-11
 E_R - Exhibit 21-8, 21-10
 f_p - Page 21-11
 LOS, S, FFS, v_p - Exhibit 21-2, 21-3

S - Speed
 D - Density
 FFS - Free-flow speed
 BFFS - Base free-flow speed

f_{LW} - Exhibit 21-4
 f_{LC} - Exhibit 21-5
 f_M - Exhibit 21-6
 f_A - Exhibit 21-7

EXAMPLE PROBLEM 2 (PART I)

The Highway A 3.4-km segment of an east-west five-lane highway with two travel lanes in each direction separated by a two-way left-turn lane (TWLTL). The highway includes a 4 percent grade, 1830-m in length, followed by level terrain of 1570 m.

The Question What is the LOS of the highway on level terrain during the peak hour?

The Facts

- √ Level terrain, √ 83.0-km/h 85th-percentile speed,
- √ 3.6-m lane width, √ 1,500-veh/h peak-hour volume,
- √ 6 percent trucks and buses, √ 8 access points/km (westbound), and
- √ 6 access points/km (eastbound), √ 0.90 PHF.
- √ 3.6-m and greater lateral clearance for westbound and eastbound,

Comments

- √ Assume base FFS to be 3.0 km/h less than 85th-percentile speed.
BFFS = 83.0 – 3.0 = 80.0 km/h
- √ Assume no RVs, since none is indicated.

Outline of Solution All input parameters are known. Demand will be computed in terms of pc/h/ln, an FFS estimate, and the LOS determined from the speed-flow diagram. An estimate of passenger-car speed is determined from the graph, and a value of density is calculated using speed and flow rate.

Steps

1. Find f_{HV} (EB and WB) (use Exhibit 21-8).	$f_{HV} = \frac{1}{1 + P_T(E_T - 1) + P_R(E_R - 1)}$ $f_{HV} = \frac{1}{1 + 0.06(1.5 - 1) + 0}$ $f_{HV} = 0.971$
2. Find v_p (EB and WB) (use Equation 21-3).	$v_p = \frac{V}{PHF * N * f_{HV} * f_p}$ $v_p = \frac{1,500}{0.90 * 2 * 0.971 * 1.00}$ $v_p = 858 \text{ pc/h/ln}$
3. Compute EB and WB free-flow speeds (use Exhibits 21-4, 21-5, 21-6, 21-7, and Equation 21-1).	$FFS = BFFS - f_{LW} - f_{LC} - f_A - f_M$ $FFS = 80 - 0.0 - 0.0 - 4.0 - 0.0$ $FFS = 76.0 \text{ km/h (EB)}$ $FFS = 80 - 0.0 - 0.0 - 5.3 - 0.0$ $FFS = 74.7 \text{ km/h (WB)}$
4. Determine LOS (use Exhibit 21-3).	LOS C (EB and WB)

The Results

Eastbound:

- LOS C,
- Speed = 76.0 km/h, and
- Density = 11.3 pc/km/ln.

Westbound:

- LOS C,
- Speed = 74.7 km/h, and
- Density = 11.5 pc/km/ln.

Example Problem 2 (Part I)

MULTILANE HIGHWAYS WORKSHEET																								
		<table style="width:100%; border-collapse: collapse;"> <thead> <tr> <th style="text-align: left;">Application</th> <th style="text-align: left;">Input</th> <th style="text-align: left;">Output</th> </tr> </thead> <tbody> <tr> <td>Operational (LOS)</td> <td>FFS, N, v_p</td> <td>LOS, S, D</td> </tr> <tr> <td>Design (N)</td> <td>FFS, LOS, v_p</td> <td>N, S, D</td> </tr> <tr> <td>Design (v_p)</td> <td>FFS, LOS, N</td> <td>v_p, S, D</td> </tr> <tr> <td>Planning (LOS)</td> <td>FFS, N, AADT</td> <td>LOS, S, D</td> </tr> <tr> <td>Planning (N)</td> <td>FFS, LOS, AADT</td> <td>N, S, D</td> </tr> <tr> <td>Planning (v_p)</td> <td>FFS, LOS, N</td> <td>v_p, S, D</td> </tr> </tbody> </table>		Application	Input	Output	Operational (LOS)	FFS, N, v _p	LOS, S, D	Design (N)	FFS, LOS, v _p	N, S, D	Design (v _p)	FFS, LOS, N	v _p , S, D	Planning (LOS)	FFS, N, AADT	LOS, S, D	Planning (N)	FFS, LOS, AADT	N, S, D	Planning (v _p)	FFS, LOS, N	v _p , S, D
Application	Input	Output																						
Operational (LOS)	FFS, N, v _p	LOS, S, D																						
Design (N)	FFS, LOS, v _p	N, S, D																						
Design (v _p)	FFS, LOS, N	v _p , S, D																						
Planning (LOS)	FFS, N, AADT	LOS, S, D																						
Planning (N)	FFS, LOS, AADT	N, S, D																						
Planning (v _p)	FFS, LOS, N	v _p , S, D																						
General Information		Site Information																						
Analyst	<u>JMYE</u>	Highway/Direction of Travel	<u>Buckeye Rd. (EB/WB)</u>																					
Agency or Company	<u>EHI</u>	From/To	<u>50th - 58th St.</u>																					
Date Performed	<u>5/16/99</u>	Jurisdiction	<u>N. County</u>																					
Analysis Time Period	<u>PM</u>	Analysis Year	<u>1999</u>																					
<input checked="" type="checkbox"/> Operational (LOS) <input type="checkbox"/> Design (N) <input type="checkbox"/> Design (v _p) <input type="checkbox"/> Planning (LOS) <input type="checkbox"/> Planning (N) <input type="checkbox"/> Planning (v _p)																								
Flow Inputs																								
Volume, V	<u>1,500</u> veh/h	Peak-hour factor, PHF	<u>0.90</u>																					
Annual avg. daily traffic, AADT	_____ veh/day	% Trucks and buses, P _T	<u>6</u>																					
Peak-hour proportion of AADT, K	_____	% RVs, P _R	<u>0</u>																					
Peak-hour direction proportion, D	_____	General terrain																						
DDHV = AADT * K * D	_____ veh/h	<input checked="" type="checkbox"/> Level <input type="checkbox"/> Rolling <input type="checkbox"/> Mountainous																						
Driver type		Grade: Length _____ km Up/Down _____ %																						
<input checked="" type="checkbox"/> Commuter/Weekday <input type="checkbox"/> Recreational/Weekend		Number of lanes	<u>2</u>																					
Calculate Flow Adjustments																								
f _p	<u>1.00</u>	E _R	_____																					
E _T	<u>1.5</u>	f _{HV} = $\frac{1}{1 + P_T(E_T - 1) + P_R(E_R - 1)}$	<u>0.971</u>																					
Speed Inputs		Calculate Speed Adjustments and FFS																						
Lane width, LW	<u>3.6</u> m	f _{LW}	_____ km/h																					
Total lateral clearance, TLC	<u>> 3.6</u> m	f _{LC}	_____ km/h																					
Access points, A	<u>6/8</u> A/km	f _A	<u>4.0/5.3</u> km/h																					
Median type, M <input type="checkbox"/> Undivided <input checked="" type="checkbox"/> Divided		f _M	_____ km/h																					
FFS (measured)	_____ km/h	FFS = BFFS - f _{LW} - f _{LC} - f _A - f _M	<u>76.0/74.7</u> km/h																					
Base free-flow Speed, BFFS	<u>80</u> km/h																							
Operational, Planning (LOS); Design, Planning (v _p)		Design, Planning (N)																						
Operational (LOS) or Planning (LOS)		Design (N) or Planning (N) 1st Iteration																						
v _p = $\frac{V \text{ or } DDHV}{PHF * N * f_{HV} * f_p}$	<u>858</u> pc/h/ln	N	_____ assumed																					
S	<u>76.0/74.7</u> km/h	v _p = $\frac{V \text{ or } DDHV}{PHF * N * f_{HV} * f_p}$	_____ pc/h/ln																					
D = v _p /S	<u>11.3/11.5</u> pc/km/ln	LOS	_____																					
LOS	<u>C/C</u>																							
Design (v _p) or Planning (v _p)		Design (N) or Planning (N) 2nd Iteration																						
LOS	_____	N	_____ assumed																					
v _p	_____ pc/h/ln	v _p = $\frac{V \text{ or } DDHV}{PHF * N * f_{HV} * f_p}$	_____ pc/h/ln																					
V = v _p * PHF * N * f _{HV} * f _p	_____ veh/h	LOS	_____																					
S	_____ km/h	S	_____ km/h																					
D = v _p /S	_____ pc/km/ln	D = v _p /S	_____ pc/km/ln																					
Glossary		Factor Location																						
N - Number of lanes	S - Speed	E _T - Exhibit 21-8, 21-9, 21-11	f _{LW} - Exhibit 21-4																					
V - Hourly volume	D - Density	E _R - Exhibit 21-8, 21-10	f _{LC} - Exhibit 21-5																					
v _p - Flow rate	FFS - Free-flow speed	f _p - Page 21-11	f _M - Exhibit 21-6																					
LOS - Level of service	BFFS - Base free-flow speed	LOS, S, FFS, v _p - Exhibit 21-2, 21-3	f _A - Exhibit 21-7																					
DDHV - Directional design-hour volume																								

EXAMPLE PROBLEM 2 (PART II)

The Highway A 3.4-km segment of an east-west five-lane highway with two travel lanes in each direction separated by a TWLTL. The highway characteristics include a 4 percent grade, 1830 m in length, followed by level terrain of 1570 m.

The Question What is the LOS of the 4 percent grade segment during the peak hour?

Additional Facts

- √ 4.0 percent grade (EB downgrade, WB upgrade),
- √ 87.0-km/h eastbound 85th-percentile speed,
- √ 77.0-km/h westbound 85th-percentile speed,
- √ 3.6-m lane width,
- √ 6 access points/km (EB), and
- √ 0 access points (WB).

Comments

- √ Assume base FFS to be 3.0 km/h less than 85th-percentile speed.
BFFS (EB) = 87.0 – 3.0 = 84.0 km/h
- √ BFFS (WB) = 77.0 – 3.0 = 74.0 km/h
- √ Assume no RVs, since none indicated.

Outline of Solution All input parameters are known. Demand will be computed in terms of pc/h/ln, an FFS estimate, and the LOS determined from the speed-flow diagram. An estimate of passenger-car speed is determined from the graph, and a value of density is calculated using speed and flow rate.

Steps

<p>1. Find f_{HV} (EB and WB) (use Exhibits 21-9 and 21-11).</p>	$f_{HV} = \frac{1}{1 + P_T(E_T - 1) + P_R(E_R - 1)}$ $f_{HV} = \frac{1}{1 + 0.06(1.5 - 1) + 0} = 0.971 \text{ (EB)}$ $f_{HV} = \frac{1}{1 + 0.06(3.0 - 1) + 0} = 0.893 \text{ (WB)}$
<p>2. Find v_p (EB and WB).</p>	$v_p = \frac{V}{PHF * N * f_{HV} * f_p}$ $v_p = \frac{1,500}{0.90 * 2 * 0.971 * 1.00} = 858 \text{ pc/h/ln (EB)}$ $v_p = \frac{1,500}{0.90 * 2 * 0.893 * 1.00} = 933 \text{ pc/h/ln (WB)}$
<p>3. Compute EB and WB FFS (use Exhibits 21-4, 21-5, 21-6, and 21-7).</p>	$FFS = BFFS - f_{LW} - f_{LC} - f_A - f_M$ $FFS = 84.0 - 0.0 - 0.0 - 4.0 - 0.0 = 80.0 \text{ km/h (EB)}$ $FFS = 74.0 - 0.0 - 0.0 - 0.0 - 0.0 = 74.0 \text{ km/h (WB)}$
<p>4. Determine LOS (use Exhibit 21-3).</p>	<p>LOS B (EB) LOS C (WB)</p>

The Results

Eastbound:

- LOS B,
- Speed = 80.0 km/h, and
- Density = 10.7 pc/km/ln.

Westbound:

- LOS C,
- Speed = 74.0 km/h, and
- Density = 12.6 pc/km/ln.

Example Problem 2 (Part II)

MULTILANE HIGHWAYS WORKSHEET

Application	Input	Output
Operational (LOS)	FFS, N, v_p	LOS, S, D
Design (N)	FFS, LOS, v_p	N, S, D
Design (v_p)	FFS, LOS, N	v_p , S, D
Planning (LOS)	FFS, N, AADT	LOS, S, D
Planning (N)	FFS, LOS, AADT	N, S, D
Planning (v_p)	FFS, LOS, N	v_p , S, D

General Information

Analyst: JMYE

Agency or Company: EHI

Date Performed: 5/16/99

Analysis Time Period: PM

Site Information

Highway/Direction of Travel: Buckeye Rd. (EB/WB)

From/To: 50th - 58th St.

Jurisdiction: N. County

Analysis Year: 1999

Operational (LOS) Design (N) Design (v_p)

Planning (LOS) Planning (N) Planning (v_p)

Flow Inputs

Volume, V: <u>1,500</u> veh/h	Peak-hour factor, PHF: <u>0.90</u>
Annual avg. daily traffic, AADT: _____ veh/day	% Trucks and buses, P_T : <u>6</u>
Peak-hour proportion of AADT, K: _____	% RVs, P_R : <u>0</u>
Peak-hour direction proportion, D: _____	General terrain:
DDHV = AADT * K * D: _____ veh/h	<input type="checkbox"/> Level <input type="checkbox"/> Rolling <input type="checkbox"/> Mountainous
Driver type:	Grade: Length <u>1.830</u> km Up/Down <u>4</u> %
<input checked="" type="checkbox"/> Commuter/Weekday <input type="checkbox"/> Recreational/Weekend	Number of lanes: <u>2</u>

Calculate Flow Adjustments

f_p : <u>1.00</u>	E_R : _____
E_T : <u>1.5/3.0</u>	$f_{HV} = \frac{1}{1 + P_T(E_T - 1) + P_R(E_R - 1)}$: <u>0.97/0.893</u>

Speed Inputs

Lane width, LW: 3.6 m

Total lateral clearance, TLC: > 3.6 m

Access points, A: 6/0 A/km

Median type, M: Undivided Divided

FFS (measured): _____ km/h

Base free-flow Speed, BFFS: 84.0/74.0 km/h

Calculate Speed Adjustments and FFS

f_{LW} : _____ km/h

f_{LC} : _____ km/h

f_A : 4.0/0.0 km/h

f_M : _____ km/h

FFS = BFFS - f_{LW} - f_{LC} - f_A - f_M : 80.0/74.0 km/h

Operational, Planning (LOS); Design, Planning (v_p)

Operational (LOS) or Planning (LOS)

$v_p = \frac{V \text{ or } DDHV}{PHF * N * f_{HV} * f_p}$: 858/933 pc/h/ln

S: 80.0/74.0 km/h

D = v_p/S : 10.7/12.6 pc/km/ln

LOS: B/C

Design (v_p) or Planning (v_p)

LOS: _____

v_p : _____ pc/h/ln

$V = v_p * PHF * N * f_{HV} * f_p$: _____ veh/h

S: _____ km/h

D = v_p/S : _____ pc/km/ln

Design, Planning (N)

Design (N) or Planning (N) 1st Iteration

N: _____ assumed

$v_p = \frac{V \text{ or } DDHV}{PHF * N * f_{HV} * f_p}$: _____ pc/h/ln

LOS: _____

Design (N) or Planning (N) 2nd Iteration

N: _____ assumed

$v_p = \frac{V \text{ or } DDHV}{PHF * N * f_{HV} * f_p}$: _____ pc/h/ln

LOS: _____

S: _____ km/h

D = v_p/S : _____ pc/km/ln

Glossary

N - Number of lanes

V - Hourly volume

v_p - Flow rate

LOS - Level of service

DDHV - Directional design-hour volume

S - Speed

D - Density

FFS - Free-flow speed

BFFS - Base free-flow speed

Factor Location

E_T - Exhibit 21-8, 21-9, 21-11

E_R - Exhibit 21-8, 21-10

f_p - Page 21-11

LOS, S, FFS, v_p - Exhibit 21-2, 21-3

f_{LW} - Exhibit 21-4

f_{LC} - Exhibit 21-5

f_M - Exhibit 21-6

f_A - Exhibit 21-7

EXAMPLE PROBLEM 3

The Highway A new 3.2-km segment of multilane highway with right-of-way width of 27.4 m.

The Question What is the cross section required to meet the design criterion of LOS D? What is the expected travel speed for passenger cars?

The Facts

- √ 60,000 annual average daily traffic,
- √ 80.0-km/h speed limit,
- √ Peak-hour volume is 10 percent of daily traffic,
- √ Peak-hour traffic has 55/45 directional split,
- √ Rolling terrain,
- √ 5 percent trucks,
- √ 6 access points/km, and
- √ 0.90 peak-hour factor.

Comments

- √ This solution assumes that the given AADT is for the design year and that the other factors, although current, are accepted as representative of expected design year conditions.
- √ Assume base FFS to be 8.0 km/h greater than the posted speed.
BFFS = 80.0 + 8.0 = 88.0 km/h

Steps

1. Convert AADT to design-hour volume.	DDHV = AADT * K * D DDHV = 60,000 * 0.10 * 0.55 = 3,300 veh/h
2. Find f_{HV} (use Exhibit 21-8). $f_{HV} = \frac{1}{1 + P_T(E_T - 1) + P_R(E_R - 1)}$	$f_{HV} = \frac{1}{1 + 0.05(2.5 - 1) + 0} = 0.930$
3. Compute free-flow speed (use Exhibits 21-4, 21-5, 21-6, and 21-7).	FFS = BFFS - f_{LW} - f_{LC} - f_A - f_M FFS = 88.0 - 0.0 - 0.0 - 4.0 - 0.0 = 84.0 km/h
4. Determine maximum v_p (use Exhibit 21-3).	$v_p = 1,775$ pc/h/ln
5. Determine minimum N required.	$N = \frac{V}{PHF * v_p * f_{HV} * f_p}$ $N = \frac{3,300}{0.90 * 1,775 * 0.930 * 1.00} = 2.2$ (use 3)
6. Compute v_p using minimum N required.	$v_p = \frac{3,300}{0.90 * 3 * 0.930 * 1.00} = 1,314$ pc/h/ln
7. Determine if base conditions will fit within available right-of-way with a 3.6-m median to accommodate left-turn bays in the future.	Median width = 3.6 m Lane width = 3.6 m Lateral clearance (shoulder) = 1.8 m Total required width = 3.6 + 6 * 3.6 + 2 * 1.8 = 28.8 m (greater than available width)
8. Assume different design to fit available right-of-way. Use 1.8-m median and do not use shoulder at median.	Median width = 1.8 m (raised) Lane width = 3.6 m Lateral clearance (shoulder) = 1.8 m Total required width = 1.8 + 21.6 + 2 * 1.8 = 27.0 m (fits within available 27.4 m)
9. Compute FFS (use Exhibits 21-4, 21-5, 21-6, and 21-7).	FFS = 88.0 - 0.0 - 0.0 - 4.0 - 0.0 = 84.0 km/h
10. Determine LOS (use Exhibit 21-3).	LOS D

The Results A six-lane highway with lane widths of 3.6 m, a 1.8-m median, and lateral clearances of 1.8 m on the right will meet the operational objective of LOS D during the

peak-hour period. The passenger-car speed of 84.0 km/h and density of 15.6 pc/km/ln are computed.

Example Problem 3

MULTILANE HIGHWAYS WORKSHEET																								
		<table border="1" style="width: 100%; border-collapse: collapse;"> <thead> <tr> <th>Application</th> <th>Input</th> <th>Output</th> </tr> </thead> <tbody> <tr> <td>Operational (LOS)</td> <td>FFS, N, v_p</td> <td>LOS, S, D</td> </tr> <tr> <td>Design (N)</td> <td>FFS, LOS, v_p</td> <td>N, S, D</td> </tr> <tr> <td>Design (v_p)</td> <td>FFS, LOS, N</td> <td>v_p, S, D</td> </tr> <tr> <td>Planning (LOS)</td> <td>FFS, N, AADT</td> <td>LOS, S, D</td> </tr> <tr> <td>Planning (N)</td> <td>FFS, LOS, AADT</td> <td>N, S, D</td> </tr> <tr> <td>Planning (v_p)</td> <td>FFS, LOS, N</td> <td>v_p, S, D</td> </tr> </tbody> </table>		Application	Input	Output	Operational (LOS)	FFS, N, v _p	LOS, S, D	Design (N)	FFS, LOS, v _p	N, S, D	Design (v _p)	FFS, LOS, N	v _p , S, D	Planning (LOS)	FFS, N, AADT	LOS, S, D	Planning (N)	FFS, LOS, AADT	N, S, D	Planning (v _p)	FFS, LOS, N	v _p , S, D
Application	Input	Output																						
Operational (LOS)	FFS, N, v _p	LOS, S, D																						
Design (N)	FFS, LOS, v _p	N, S, D																						
Design (v _p)	FFS, LOS, N	v _p , S, D																						
Planning (LOS)	FFS, N, AADT	LOS, S, D																						
Planning (N)	FFS, LOS, AADT	N, S, D																						
Planning (v _p)	FFS, LOS, N	v _p , S, D																						
General Information		Site Information																						
Analyst <u>JMYE</u>		Highway/Direction of Travel <u>US 6 (N/E)</u>																						
Agency or Company <u>EHI</u>		From/To <u>31st to 156th St.</u>																						
Date Performed <u>5/16/99</u>		Jurisdiction <u>M. County</u>																						
Analysis Time Period <u>PM</u>		Analysis Year <u>1999</u>																						
<input type="checkbox"/> Operational (LOS) <input type="checkbox"/> Design (N) <input type="checkbox"/> Design (v _p) <input type="checkbox"/> Planning (LOS) <input checked="" type="checkbox"/> Planning (N) <input type="checkbox"/> Planning (v _p)																								
Flow Inputs																								
Volume, V _____ veh/h		Peak-hour factor, PHF <u>0.90</u>																						
Annual avg. daily traffic, AADT <u>60,000</u> veh/day		% Trucks and buses, P _T <u>5</u>																						
Peak-hour proportion of AADT, K <u>0.10</u>		% RVs, P _R <u>0</u>																						
Peak-hour direction proportion, D <u>55/45</u>		General terrain																						
DDHV = AADT * K * D <u>3300</u> veh/h		<input type="checkbox"/> Level <input checked="" type="checkbox"/> Rolling <input type="checkbox"/> Mountainous																						
Driver type		Grade: Length _____ km Up/Down _____ %																						
<input checked="" type="checkbox"/> Commuter/Weekday <input type="checkbox"/> Recreational/Weekend		Number of lanes _____																						
Calculate Flow Adjustments																								
f _p <u>1.00</u>		E _R <u>0</u>																						
E _T <u>2.5</u>		f _{HV} = $\frac{1}{1 + P_T(E_T - 1) + P_R(E_R - 1)}$ <u>0.930</u>																						
Speed Inputs		Calculate Speed Adjustments and FFS																						
Lane width, LW <u>3.6/3.6</u> m		f _{LW} <u>0.0/0.0</u> km/h																						
Total lateral clearance, TLC <u>3.6</u> m		f _{LC} <u>0.0/0.0</u> km/h																						
Access points, A <u>6</u> A/km		f _A <u>4.0/4.0</u> km/h																						
Median type, M <input type="checkbox"/> Undivided <input checked="" type="checkbox"/> Divided		f _M <u>0.0</u> km/h																						
FFS (measured) _____ km/h		FFS = BFFS - f _{LW} - f _{LC} - f _A - f _M <u>84.0/84.0</u> km/h																						
Base free-flow Speed, BFFS <u>88.0</u> km/h																								
Operational, Planning (LOS); Design, Planning (v_p)		Design, Planning (N)																						
Operational (LOS) or Planning (LOS)		Design (N) or Planning (N) 1st Iteration																						
v _p = $\frac{V \text{ or DDHV}}{\text{PHF} * N * f_{HV} * f_p}$ _____ pc/h/ln		N <u>2.2</u> assumed																						
S _____ km/h		v _p = $\frac{V \text{ or DDHV}}{\text{PHF} * N * f_{HV} * f_p}$ <u>1,775</u> pc/h/ln																						
D = v _p /S _____ pc/km/ln		LOS _____																						
LOS _____		Design (N) or Planning (N) 2nd Iteration																						
Design (v _p) or Planning (v _p)		N <u>3</u> assumed																						
LOS _____		v _p = $\frac{V \text{ or DDHV}}{\text{PHF} * N * f_{HV} * f_p}$ <u>1,314</u> pc/h/ln																						
v _p _____ pc/h/ln		LOS _____																						
V = v _p * PHF * N * f _{HV} * f _p _____ veh/h		S <u>84.0</u> km/h																						
S _____ km/h		D = v _p /S <u>15.6</u> pc/km/ln																						
D = v _p /S _____ pc/km/ln																								
Glossary		Factor Location																						
N - Number of lanes	S - Speed	E _T - Exhibit 21-8, 21-9, 21-11	f _{LW} - Exhibit 21-4																					
V - Hourly volume	D - Density	E _R - Exhibit 21-8, 21-10	f _{LC} - Exhibit 21-5																					
v _p - Flow rate	FFS - Free-flow speed	f _p - Page 21-11	f _M - Exhibit 21-6																					
LOS - Level of service	BFFS - Base free-flow speed	LOS, S, FFS, v _p - Exhibit 21-2, 21-3	f _A - Exhibit 21-7																					
DDHV - Directional design-hour volume																								

EXAMPLE PROBLEM 4

The Highway A 4.0-km segment of a six-lane highway in a growing urban area to be improved.

The Question What is the estimated LOS for the existing and improved roadway? How much additional traffic can be added and still maintain the improved LOS?

The Facts

- √ 1,400 pc/h/ln flow rate,
- √ Free-flow travel time is 180 s, and
- √ Improved free-flow travel time is 150 s.

Comments

This problem involves upgrading the design of a substandard section of multilane highway. The substandard highway has a measured FFS of 80 km/h. It is proposed to upgrade the design to a 96-km/h FFS through wider shoulders, widening the lanes to current standards, straightening the alignment on a few critical curves, restricting access to fronting properties and constructing a median.

Outline of Solution Using given peak-hour volume and FFS, determine LOS for improved and for current conditions. Determine additional volume that can be accommodated while still maintaining the improved LOS.

Steps

1. Determine LOS and speed of existing highway (use Exhibit 21-3).	$v_p = 1,400$ pc/h/ln, $S = 80.0$ km/h, LOS D
2. Determine maximum allowable flow at improved LOS and FFS (use Exhibit 21-3).	$v_p = 1,400$ pc/h/ln, FFS = 96.0 km/h, LOS C, Speed = 96.0 km/h
3. Compute additional volume.	Additional volume = $1,536 - 1,400 = 136$ pc/h/ln

The Results

- Currently LOS D,
- Improved LOS C,
- Additional volume = 136 pc/h/ln,
- Speed = 96.0 km/h, and
- Density = 14.6 pc/km/ln.

Example Problem 4

MULTILANE HIGHWAYS WORKSHEET

The graph plots Average Passenger-Car Speed (km/h) on the y-axis (40 to 110) against Flow Rate (pc/h/ln) on the x-axis (0 to 2400). It shows five curves representing different Levels of Service (LOS): A, B, C, D, and E. An arrow indicates 'Additional growth with LOS C'.

Application	Input	Output
Operational (LOS)	FFS, N, v_p	LOS, S, D
Design (N)	FFS, LOS, v_p	N, S, D
Design (v_p)	FFS, LOS, N	v_p , S, D
Planning (LOS)	FFS, N, AADT	LOS, S, D
Planning (N)	FFS, LOS, AADT	N, S, D
Planning (v_p)	FFS, LOS, N	v_p , S, D

General Information

Analyst: JMYE

Agency or Company: EHI

Date Performed: 5/16/99

Analysis Time Period: PM

Site Information

Highway/Direction of Travel: Georgia Dr.

From/To: Meno to Woodstock

Jurisdiction: M. County

Analysis Year: 1999

Operational (LOS) Design (N) Design (v_p)

Planning (LOS) Planning (N) Planning (v_p)

Flow Inputs

Volume, V: _____ veh/h Peak-hour factor, PHF: _____

Annual avg. daily traffic, AADT: _____ veh/day % Trucks and buses, P_T : _____

Peak-hour proportion of AADT, K: _____ % RVs, P_R : _____

Peak-hour direction proportion, D: _____ General terrain:

DDHV = AADT * K * D: _____ veh/h Level Rolling Mountainous

Driver type: _____ Grade: Length _____ km Up/Down _____ %

Commuter/Weekday Recreational/Weekend Number of lanes: 3

Calculate Flow Adjustments

f_p : _____ E_R : _____

E_T : _____ $f_{HV} = \frac{1}{1 + P_T(E_T - 1) + P_R(E_R - 1)}$: _____

Speed Inputs

Lane width, LW: _____ m

Total lateral clearance, TLC: _____ m

Access points, A: _____ A/km

Median type, M: Undivided Divided

FFS (measured): 96.0 km/h

Base free-flow Speed, BFFS: _____ km/h

Calculate Speed Adjustments and FFS

f_{LW} : _____ km/h

f_{LC} : _____ km/h

f_A : _____ km/h

f_M : _____ km/h

FFS = BFFS - f_{LW} - f_{LC} - f_A - f_M : _____ km/h

Operational, Planning (LOS); Design, Planning (v_p)

Operational (LOS) or Planning (LOS)

$v_p = \frac{V \text{ or DDHV}}{PHF * N * f_{HV} * f_p}$: _____ pc/h/ln

S: _____ km/h

D = v_p / S : _____ pc/km/ln

LOS: _____

Design (v_p) or Planning (v_p)

LOS: _____

$v_p = \frac{1,536 - 1,400}{1} = 136$ pc/h/ln

V = $v_p * PHF * N * f_{HV} * f_p$: _____ veh/h

S: 96.0 km/h

D = v_p / S : 14.6 pc/km/ln

Design, Planning (N)

Design (N) or Planning (N) 1st Iteration

N: _____ assumed

$v_p = \frac{V \text{ or DDHV}}{PHF * N * f_{HV} * f_p}$: _____ pc/h/ln

LOS: _____

Design (N) or Planning (N) 2nd Iteration

N: _____ assumed

$v_p = \frac{V \text{ or DDHV}}{PHF * N * f_{HV} * f_p}$: _____ pc/h/ln

LOS: _____

S: _____ km/h

D = v_p / S : _____ pc/km/ln

Glossary

N - Number of lanes S - Speed

V - Hourly volume D - Density

v_p - Flow rate FFS - Free-flow speed

LOS - Level of service BFFS - Base free-flow speed

DDHV - Directional design-hour volume

Factor Location

E_T - Exhibit 21-8, 21-9, 21-11 f_{LW} - Exhibit 21-4

E_R - Exhibit 21-8, 21-10 f_{LC} - Exhibit 21-5

f_p - Page 21-11 f_M - Exhibit 21-6

LOS, S, FFS, v_p - Exhibit 21-2, 21-3 f_A - Exhibit 21-7

EXAMPLE PROBLEM 5

The Highway New suburban facility under planning with an opening-day AADT forecast of 42,000 veh/day.

The Question For opening-day volumes, how many lanes will be needed to provide LOS C during the peak hour?

The Facts

- √ 42,000 veh/day,
- √ Rolling terrain, and
- √ 10 percent trucks.

Comments

- √ Several input variables are not given. Reasonable default values based on the traffic engineer's knowledge of local conditions are selected as 10 percent trucks, 0 percent RVs, lane width of 3.6 m, undivided highway, $K = 0.10$, directional split of 60/40, BFFS = 90.0 km/h, access-point density of 4 access points/km, PHF = 0.90, and shoulder width of 1.8 m.
- √ Assume commuter traffic ($f_p = 1.00$).

Outline of Solution Using the multilane highways worksheet (Appendix A), determine required lane configuration.

Steps

1. Convert AADT to directional design-hour volume (DDHV).	$DDHV = AADT * K * D$ $DDHV = 42,000 * 0.10 * 0.60$ $DDHV = 2,520 \text{ veh/h}$
2. Find f_{HV} (use Exhibit 21-8).	$f_{HV} = \frac{1}{1 + P_T(E_T - 1) + P_R(E_R - 1)}$ $f_{HV} = \frac{1}{1 + 0.1(2.5 - 1) + 0} = 0.870$
3. Compute free-flow speed (use Exhibits 21-4, 21-5, 21-6, and 21-7).	$FFS = BFFS - f_{LW} - f_{LC} - f_A - f_M$ $FFS = 90.0 - 0.0 - 0.0 - 2.7 - 2.6$ $= 84.7 \text{ km/h}$
4. Assume four-lane highway and compute v_p (use Equation 21-3).	$v_p = \frac{2,520}{0.90 * 0.870 * 2 * 1.00} = 1,609 \text{ pc/h/ln}$
5. Determine LOS (use Exhibit 21-3).	LOS D
6. Assume six-lane highway and compute v_p (use Equation 21-3).	$v_p = \frac{2,520}{0.90 * 0.870 * 3 * 1.00} = 1,073 \text{ pc/h/ln}$
7. Determine LOS (use Exhibit 21-3).	LOS C

The Results

- A 6-lane freeway is needed,
- LOS C,
- Speed = 84.7 km/h, and
- D = 12.7 pc/km/h.

Example Problem 5

MULTILANE HIGHWAYS WORKSHEET																								
		<table style="width: 100%; border-collapse: collapse;"> <tr> <th style="text-align: left;">Application</th> <th style="text-align: left;">Input</th> <th style="text-align: left;">Output</th> </tr> <tr> <td>Operational (LOS)</td> <td>FFS, N, v_p</td> <td>LOS, S, D</td> </tr> <tr> <td>Design (N)</td> <td>FFS, LOS, v_p</td> <td>N, S, D</td> </tr> <tr> <td>Design (v_p)</td> <td>FFS, LOS, N</td> <td>v_p, S, D</td> </tr> <tr> <td>Planning (LOS)</td> <td>FFS, N, AADT</td> <td>LOS, S, D</td> </tr> <tr> <td>Planning (N)</td> <td>FFS, LOS, AADT</td> <td>N, S, D</td> </tr> <tr> <td>Planning (v_p)</td> <td>FFS, LOS, N</td> <td>v_p, S, D</td> </tr> </table>		Application	Input	Output	Operational (LOS)	FFS, N, v_p	LOS, S, D	Design (N)	FFS, LOS, v_p	N, S, D	Design (v_p)	FFS, LOS, N	v_p , S, D	Planning (LOS)	FFS, N, AADT	LOS, S, D	Planning (N)	FFS, LOS, AADT	N, S, D	Planning (v_p)	FFS, LOS, N	v_p , S, D
Application	Input	Output																						
Operational (LOS)	FFS, N, v_p	LOS, S, D																						
Design (N)	FFS, LOS, v_p	N, S, D																						
Design (v_p)	FFS, LOS, N	v_p , S, D																						
Planning (LOS)	FFS, N, AADT	LOS, S, D																						
Planning (N)	FFS, LOS, AADT	N, S, D																						
Planning (v_p)	FFS, LOS, N	v_p , S, D																						
General Information		Site Information																						
Analyst <u>JMYE</u>		Highway/Direction of Travel _____																						
Agency or Company <u>EHI</u>		From/To _____																						
Date Performed <u>5/16/99</u>		Jurisdiction <u>M. County</u>																						
Analysis Time Period <u>PM</u>		Analysis Year <u>1999</u>																						
<input type="checkbox"/> Operational (LOS) <input type="checkbox"/> Design (N) <input type="checkbox"/> Design (v_p) <input type="checkbox"/> Planning (LOS) <input checked="" type="checkbox"/> Planning (N) <input type="checkbox"/> Planning (v_p)																								
Flow Inputs																								
Volume, V _____ veh/h		Peak-hour factor, PHF <u>0.90</u>																						
Annual avg. daily traffic, AADT <u>42,000</u> veh/day		% Trucks and buses, P_T <u>10</u>																						
Peak-hour proportion of AADT, K <u>0.10</u>		% RVs, P_R <u>0</u>																						
Peak-hour direction proportion, D <u>0.60</u>		General terrain																						
DDHV = AADT * K * D <u>2520</u> veh/h		<input type="checkbox"/> Level <input checked="" type="checkbox"/> Rolling <input type="checkbox"/> Mountainous																						
Driver type		Grade: Length _____ km Up/Down _____ %																						
<input checked="" type="checkbox"/> Commuter/Weekday <input type="checkbox"/> Recreational/Weekend		Number of lanes _____																						
Calculate Flow Adjustments																								
f_p <u>1.00</u>		E_R _____																						
E_T <u>2.5</u>		$f_{HV} = \frac{1}{1 + P_T(E_T - 1) + P_R(E_R - 1)}$ <u>0.870</u>																						
Speed Inputs		Calculate Speed Adjustments and FFS																						
Lane width, LW <u>3.6</u> m		f_{LW} <u>0.0</u> km/h																						
Total lateral clearance, TLC <u>3.6</u> m		f_{LC} <u>0.0</u> km/h																						
Access points, A <u>4</u> A/km		f_A <u>2.7</u> km/h																						
Median type, M <input checked="" type="checkbox"/> Undivided <input type="checkbox"/> Divided		f_M <u>2.6</u> km/h																						
FFS (measured) _____ km/h		FFS = BFFS - f_{LW} - f_{LC} - f_A - f_M <u>84.7</u> km/h																						
Base free-flow Speed, BFFS <u>90</u> km/h																								
Operational, Planning (LOS); Design, Planning (v_p)		Design, Planning (N)																						
Operational (LOS) or Planning (LOS)		Design (N) or Planning (N) 1st Iteration																						
$v_p = \frac{V \text{ or DDHV}}{PHF * N * f_{HV} * f_p}$ _____ pc/h/ln		N <u>2</u> assumed																						
S _____ km/h		$v_p = \frac{V \text{ or DDHV}}{PHF * N * f_{HV} * f_p}$ <u>1,609</u> pc/h/ln																						
D = v_p/S _____ pc/km/ln		LOS _____																						
LOS _____		Design (N) or Planning (N) 2nd Iteration																						
Design (v_p) or Planning (v_p)		N <u>3</u> assumed																						
LOS _____		$v_p = \frac{V \text{ or DDHV}}{PHF * N * f_{HV} * f_p}$ <u>1,073</u> pc/h/ln																						
v_p _____ pc/h/ln		LOS <u>C</u>																						
V = $v_p * PHF * N * f_{HV} * f_p$ _____ veh/h		S <u>84.7</u> km/h																						
S _____ km/h		D = v_p/S <u>12.7</u> pc/km/ln																						
D = v_p/S _____ pc/km/ln																								
Glossary		Factor Location																						
N - Number of lanes		E_T - Exhibit 21-8, 21-9, 21-11																						
V - Hourly volume		E_R - Exhibit 21-8, 21-10																						
v_p - Flow rate		f_{LW} - Exhibit 21-4																						
LOS - Level of service		f_{LC} - Exhibit 21-5																						
DDHV - Directional design-hour volume		f_p - Page 21-11																						
S - Speed		LOS, S, FFS, v_p - Exhibit 21-2, 21-3																						
D - Density		f_A - Exhibit 21-6																						
FFS - Free-flow speed		f_M - Exhibit 21-7																						
BFFS - Base free-flow speed																								

V. REFERENCES

1. Reilly, W., D. Harwood, J. Schoen, and M. Holling. *Capacity and LOS Procedures for Rural and Urban Multilane Highways*. NCHRP Project 3-33, Final Report, JHK & Associates, Tucson, Ariz., May 1990.

2. Hool, J. N., S. Maghsoodloo, A. D. Veren, and D. D. Brown. Analysis of Selective Enforcement Strategy Effects on Rural Alabama Traffic Speeds. In *Transportation Research Record 910*, TRB, National Research Council, Washington, D.C., 1983, pp. 74–81.
3. Armour, M. The Effect of Police Presence on Urban Driving Speeds. *Australian Road Research*, Vol. 14, No. 3, Sept. 1984, pp. 142–148.
4. Hauer, E., and F. J. Ahlin. Speed Enforcement and Speed Choice. *Accident Analysis and Prevention*, Vol. 14, No. 4, 1982, pp. 267–278.
5. Tignor, S. C. *Driver Speed Behavior on U.S. Streets and Highways*. Compendium of Technical Papers, Institute of Transportation Engineers, August 5–8, 1990.
6. *Manual of Traffic Engineering Studies*. Institute of Transportation Engineers, Arlington, Va., 1976.
7. Webster, N., and L. Elefteriadou. *A Simulation Study of Truck Passenger Car Equivalents (PCE) on Basic Freeway Sections*. Transportation Research B33, Washington, D.C., 1999, pp. 323–336.

APPENDIX A. WORKSHEET

MULTILANE HIGHWAYS WORKSHEET

MULTILANE HIGHWAYS WORKSHEET

Application	Input	Output
Operational (LOS)	FFS, N, v _p	LOS, S, D
Design (N)	FFS, LOS, v _p	N, S, D
Design (v _p)	FFS, LOS, N	v _p , S, D
Planning (LOS)	FFS, N, AADT	LOS, S, D
Planning (N)	FFS, LOS, AADT	N, S, D
Planning (v _p)	FFS, LOS, N	v _p , S, D

General Information

Analyst _____

Agency or Company _____

Date Performed _____

Analysis Time Period _____

Site Information

Highway/Direction of Travel _____

From/To _____

Jurisdiction _____

Analysis Year _____

Operational (LOS)

Design (N)

Design (v_p)

Planning (LOS)

Planning (N)

Planning (v_p)

Flow Inputs

Volume, V _____ veh/h	Peak-hour factor, PHF _____
Annual avg. daily traffic, AADT _____ veh/day	% Trucks and buses, P _T _____
Peak-hour proportion of AADT, K _____	% RVs, P _R _____
Peak-hour direction proportion, D _____	General terrain
DDHV = AADT * K * D _____ veh/h	<input type="checkbox"/> Level <input type="checkbox"/> Rolling <input type="checkbox"/> Mountainous
Driver type	Grade: Length _____ km Up/Down _____ %
<input type="checkbox"/> Commuter/Weekday <input type="checkbox"/> Recreational/Weekend	Number of lanes _____

Calculate Flow Adjustments

f _p _____	E _R _____
E _T _____	f _{HV} = $\frac{1}{1 + P_T(E_T - 1) + P_R(E_R - 1)}$ _____

Speed Inputs

Lane width, LW _____ m

Total lateral clearance, TLC _____ m

Access points, A _____ A/km

Median type, M Undivided Divided

FFS (measured) _____ km/h

Base free-flow Speed, BFFS _____ km/h

Calculate Speed Adjustments and FFS

f_{LW} _____ km/h

f_{LC} _____ km/h

f_A _____ km/h

f_M _____ km/h

FFS = BFFS - f_{LW} - f_{LC} - f_A - f_M _____ km/h

Operational, Planning (LOS); Design, Planning (v_p)

Operational (LOS) or Planning (LOS)

$V_p = \frac{V \text{ or DDHV}}{PHF * N * f_{HV} * f_p}$ _____ pc/h/ln

S _____ km/h

D = v_p/S _____ pc/km/ln

LOS _____

Design (v_p) or Planning (v_p)

LOS _____

v_p _____ pc/h/ln

V = v_p * PHF * N * f_{HV} * f_p _____ veh/h

S _____ km/h

D = v_p/S _____ pc/km/ln

Design, Planning (N)

Design (N) or Planning (N) 1st Iteration

N _____ assumed

$v_p = \frac{V \text{ or DDHV}}{PHF * N * f_{HV} * f_p}$ _____ pc/h/ln

LOS _____

Design (N) or Planning (N) 2nd Iteration

N _____ assumed

$v_p = \frac{V \text{ or DDHV}}{PHF * N * f_{HV} * f_p}$ _____ pc/h/ln

LOS _____

S _____ km/h

D = v_p/S _____ pc/km/ln

Glossary

N - Number of lanes S - Speed

V - Hourly volume D - Density

v_p - Flow rate FFS - Free-flow speed

LOS - Level of service BFFS - Base free-flow speed

DDHV - Directional design-hour volume

Factor Location

E_T - Exhibit 21-8, 21-9, 21-11 f_{LW} - Exhibit 21-4

E_R - Exhibit 21-8, 21-10 f_{LC} - Exhibit 21-5

f_p - Page 21-11 f_M - Exhibit 21-6

LOS, S, FFS, v_p - Exhibit 21-2, 21-3 f_A - Exhibit 21-7

CHAPTER 22

FREEWAY FACILITIES

CONTENTS

I.	INTRODUCTION	22-1
	Scope of Methodology	22-1
	Limitations to Methodology	22-1
II.	METHODOLOGY	22-2
	Performance Measures	22-3
	Segmenting Freeway Facilities	22-4
	Freeway Facility Demands and Estimation of Traffic Demand	22-5
	Adjustments of Segment Capacity	22-6
	Permanent Capacity Reduction	22-7
	Construction Activities Capacity Reduction	22-7
	Short-Term Work Zones	22-7
	Long-Term Construction Zones	22-8
	Lane Width Consideration	22-8
	Adverse Weather Capacity Reduction	22-8
	Rain	22-9
	Snow	22-9
	Fog	22-9
	Environmental Capacity Reduction	22-9
	Capacity Reductions due to Traffic Accidents or	
	Vehicular Breakdowns	22-10
	Applying Capacity Reductions	22-11
	Demand-Capacity Ratio	22-12
	Undersaturated Conditions	22-14
	Oversaturated Conditions	22-15
	Flow Fundamentals	22-15
	Segment Initialization	22-16
	Mainline Flow Calculation	22-16
	Mainline Input	22-16
	Mainline Output	22-16
	Mainline Output from Ramps	22-16
	Mainline Output from Segment Storage	22-17
	Mainline Output from Front-Clearing Queue	22-17
	Mainline Flow	22-17
	Determining On-Ramp Flow	22-17
	Determining Off-Ramp Flow	22-17
	Determining Segment Flow	22-18
	Determining Segment Service Measures	22-18
	Determining Freeway Facility Performance Measures	22-18
III.	APPLICATIONS	22-19
	Computational Steps	22-19
	Traffic Management Strategies	22-21
IV.	EXAMPLE PROBLEMS	22-23
	Example Problem 1	22-24
	Example Problem 2	22-28
	Example Problem 3	22-32
	Example Problem 4	22-34
	Example Problem 5	22-37

Example Problem 6	22-38
V. REFERENCES	22-41
APPENDIX A. DETAILED COMPUTATIONAL MODULES FOR FREEWAY FACILITIES	22-42
A.1 Scope of Appendix Material	22-42
A.1.1 Limitations	22-42
A.1.2 Glossary	22-42
Global Variables	22-43
Segment Variables	22-43
Node Variables	22-44
On-Ramp Variables	22-44
Off-Ramp Variables	22-44
Facilitywide Variables	22-45
A.2 Overall Procedure Description	22-45
A.2.1 Input Module	22-45
A.2.2 Demand Estimation Module	22-45
A.2.3 Establish Spatial and Time Units	22-47
A.2.4 Demand Adjustment Module	22-47
A.2.5 Segment Capacity Estimation and Adjustment Module	22-47
A.2.6 Demand-to-Capacity Ratio Module	22-48
A.3 Undersaturated Segment MOE Module	22-49
A.4 Oversaturated Segment MOE Module	22-50
A.4.1 Procedure Parameters	22-50
A.4.2 Flow Estimation	22-51
A.4.2.1 Segment Initialization (Exhibit A22-6, Steps 1 Through 4)	22-55
A.4.2.2 Mainline Flow Calculations (Exhibit A22-6, Steps 9 and 16 Through 23)	22-56
A.4.2.2.1 Mainline Input (Exhibit A22-6, Step 9)	22-57
A.4.2.2.2 Mainline Output (Exhibit A22-6, Steps 16 Through 21)	22-57
A.4.2.2.2.1 Mainline Output 1—Ramp Flows (Exhibit A22-6, Step 16)	22-57
A.4.2.2.2.2 Mainline Output 2—Segment Storage (Exhibit A22-6, Steps 20 and 21)	22-57
A.4.2.2.2.3 Mainline Output 3—Front-Clearing Queues (Exhibit A22-6, Steps 17 Through 19)	22-58
A.4.2.2.3 Mainline Flow (Exhibit A22-6, Steps 22 and 23)	22-59
A.4.2.3 On-Ramp Calculations (Exhibit A22-6, Steps 10 Through 15)	22-59
A.4.2.3.1 On-Ramp Input (Exhibit A22-6, Steps 10 and 11)	22-59
A.4.2.3.2 On-Ramp Output (Exhibit A22-6, Step 12)	22-59
A.4.2.3.3 On-Ramp Flows, Queues, and Delays (Exhibit A22-6, Steps 13 Through 15)	22-60
A.4.2.4 Off-Ramp Flow Calculation (Exhibit A22-6, Steps 5 Through 8)	22-61
A.4.2.5 Segment Flow Calculation (Exhibit A22-6, Steps 24 and 25)	22-61
A.4.3 Segment and Ramp Performance Measures (Exhibit A22-6, Steps 26 Through 30)	22-62
A.5 Directional Facility Module (Exhibit A22-6, Step 36)	22-63

Exhibits

Exhibit 22-1.	Freeway Facility Methodology	22-2
Exhibit 22-2.	Time-Space Domain of a Freeway Facility	22-4
Exhibit 22-3.	Conversion of Freeway Sections into Freeway Segments	22-5
Exhibit 22-4.	Summary of Capacity Values for Long-Term Construction Zones	22-8
Exhibit 22-5.	Capacities on German Autobahns Under Varying Conditions (veh/h/ln)	22-10
Exhibit 22-6.	Proportion of Freeway Segment Capacity Available Under Incident Conditions	22-11
Exhibit 22-7.	Speed-Flow Curves for Different Weather Conditions	22-12
Exhibit 22-8.	Adjusted Speed-Flow Curves for Indicated Capacity Adjustments	22-13
Exhibit 22-9.	Node-Segment Representation of a Freeway Facility	22-15
Exhibit 22-10.	Mainline and Segment Flow at On- and Off-Ramps	22-15
Exhibit 22-11.	Implementation of Freeway Facility Methodology	22-19
Exhibit 22-12.	Required Input Data for Freeway Facility Analysis	22-20
Exhibit A22-1.	Overall Procedure Layout	22-46
Exhibit A22-2.	Alternative Speed-Flow Curves for Indicated Capacity Adjustment Factors	22-49
Exhibit A22-3.	Node-Segment Representation of a Directional Freeway Facility	22-50
Exhibit A22-4.	Recommended Time Step Duration for Oversaturated Analysis	22-50
Exhibit A22-5.	Segment Flow-Density Function	22-51
Exhibit A22-6.	Oversaturated Analysis Procedure	22-52
Exhibit A22-7.	Definitions of Mainline and Segment Flows	22-57
Exhibit A22-8.	Flow-Density Function with a Shock Wave	22-59

I. INTRODUCTION

Freeway facilities are composed of connected segments consisting of basic freeway segments, ramp segments, and weaving segments. When several of these segments occur in sequence, they form a freeway facility. A freeway facility is the fundamental unit of analysis in this chapter. A freeway facility is analyzed by direction, and the independent analysis of both directions constitutes the analysis of a two-direction freeway facility. The reader is referred to Chapter 13 for discussion of freeway concepts.

SCOPE OF METHODOLOGY

In Chapters 23, 24, and 25, freeway components are addressed as isolated segments that are assumed to have no significant interaction. A procedure that integrates the methodologies of Chapters 23, 24, and 25 is provided in this chapter, subject to several limitations. The freeway facility has spatial and time dimensions subject to defined limits. The spatial dimension consists of continuous connected segments of defined length, type, and width. The segments could include basic freeway segments, on-ramp junction segments, off-ramp junction segments, or weaving area segments. Free-flow conditions must exist at the upstream and downstream ends of the freeway facility. The maximum length of a freeway facility that should be considered is on the order of 15 to 20 km, so that traffic enters and leaves the freeway in the same time interval.

The temporal dimension consists of connected time intervals. Undersaturated conditions must occur in the first and last time interval. The analysis period to be considered is divided into 15-min time intervals. The material developed for this chapter resulted from research sponsored by the Federal Highway Administration (1).

LIMITATIONS TO METHODOLOGY

A complete discussion of freeway control systems or even the analysis of the performance alternatives is beyond the scope of this chapter. The reader should consult references identified in a later section of this chapter. The methodology does not account for delays caused by vehicles using alternate routes or vehicles leaving before or after the study time duration.

Certain freeway traffic conditions cannot easily be analyzed by the methodology. Multiple overlapping bottlenecks are an example. Therefore, other tools may be more appropriate for specific applications beyond the capabilities of the methodology. Refer to Part V of this manual for a discussion of simulation and other models.

User demand responses such as spatial, temporal, modal, or total demand responses caused by traffic management strategies are not automatically incorporated within the methodology. On viewing the facility traffic performance results, the analyst can modify the demand input manually to analyze the effect of user demand responses or traffic growth. The accuracy of the results depends on the accuracy of the estimation of the user demand responses.

The freeway facility methodology is limited to the extent that it can accommodate demand in excess of capacity. The procedures address only local oversaturated flow situations, not systemwide oversaturated flow conditions.

The completeness of the analysis will be limited if freeway segments in the first time interval, the last time interval, and the first freeway segment do not all have demand-to-capacity ratios less than 1.00. The rationale for these limitations is discussed in the section labeled demand-capacity ratio.

The analyst can, given enough time, analyze a completely undersaturated time-space domain manually, although this is difficult. It is not expected that analysts will ever manually analyze a time-space domain that includes oversaturation. For heavily congested freeway facilities with interacting bottleneck queues, the analyst may wish to review Part V of this manual before undertaking this methodology.

Background and concepts for this chapter are in Chapter 13

II. METHODOLOGY

Exhibit 22-1 summarizes the methodology for analyzing freeway facilities. The methodology integrates the basic freeway segment, ramp segment, and weaving segment procedures into a freeway facility analysis. The methodology adjusts vehicle speeds appropriately to account for effects in adjacent segments. The methodology can analyze freeway traffic management strategies only in cases for which 15-min time intervals are appropriate and for which reliable data for capacity and demand estimates exist.

EXHIBIT 22-1. FREEWAY FACILITY METHODOLOGY

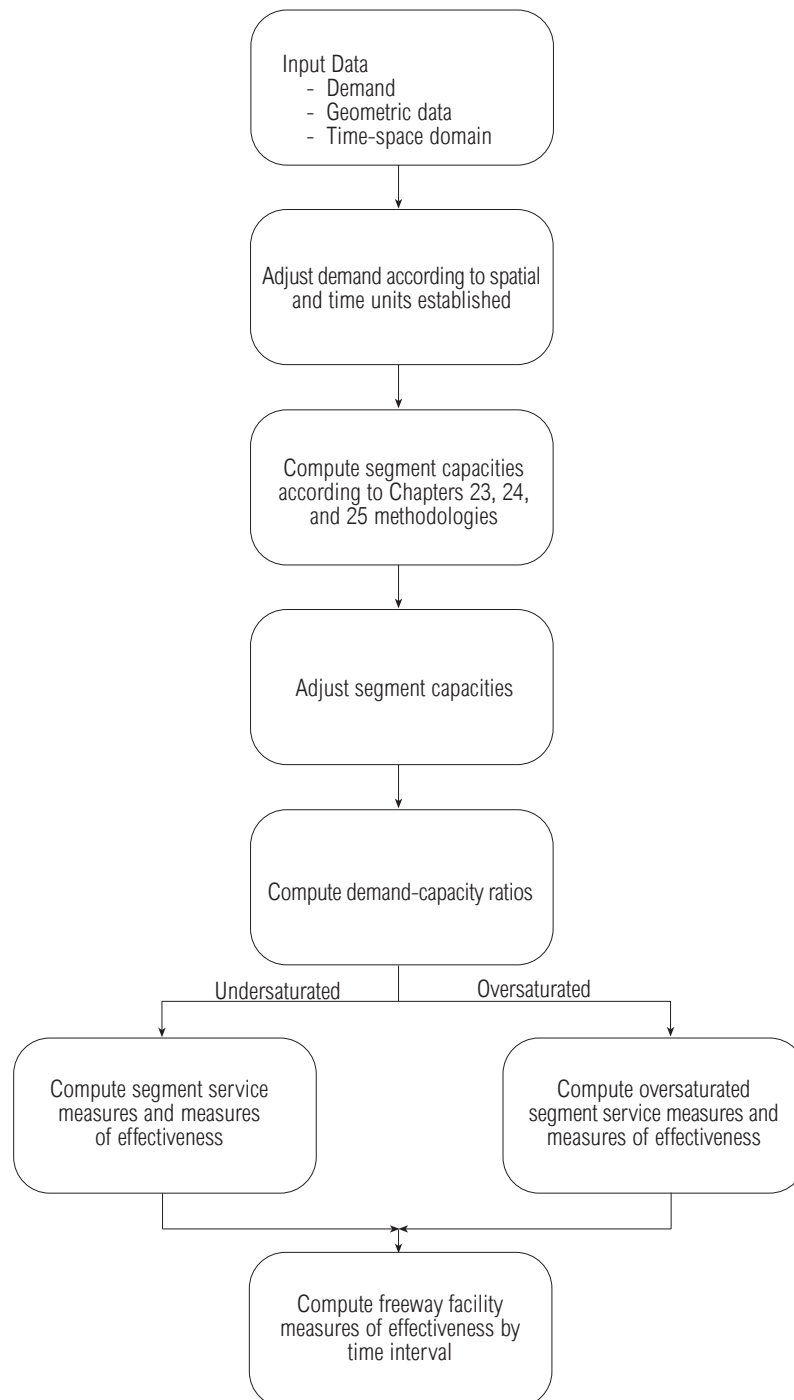

The effect of various demand management techniques can be assessed by varying the demand associated with the technique. The methodology is limited to applications for which data are available to quantify the effects of demand management and whose complexity does not exceed the capabilities of the methodology. This is especially true when periods of oversaturation occur. The analysis should begin and end with no portion of the freeway having oversaturation.

Freeway control is frequently motivated by operational problems such as one or more bottlenecks with significant mainline congestion. Ramp metering is a strategy to reduce the amount of congestion by limiting demand. The effectiveness of a particular ramp-metering strategy in improving freeway performance can be analyzed by the methodology. The ability of the methodology to assess the total effects of the strategy depends on assumptions related to where excess demand would relocate. If the demand is diverted to another time or location within the analysis period, effects can be accounted for.

The use of high-occupancy vehicle (HOV) lanes on freeways raises the issues of the operating characteristics of such lanes and the effects on the remainder of the freeway. The issues are complex because HOV lanes come in many forms including separated facilities, reserved freeway lanes (concurrent flow and contraflow lanes), and priority access (ramp meter bypass lanes). The methodology addresses separated facilities but not the interactions between the HOV lane and the mixed-flow lanes.

There are a number of data requirements for conducting an analysis, and some applications are beyond the capabilities of the methodology. The issue of capacity must be addressed first. This is a difficult issue because data are limited and by design most HOV freeway facilities operate below capacity to maintain a high level of service. Single-lane HOV facilities generally have different speed characteristics because of the lack of passing opportunities. Therefore, it is recommended that single-lane analyses be conducted only when HOV lane demand is less than 1,600 veh/h/ln.

The methodology for analyzing freeway facilities is comprehensive in that it interacts with three other chapters of this manual and incorporates both undersaturated and oversaturated flow analysis capabilities. In this portion of the chapter an overview of the methodology is given. The time-space domain of a freeway facility is described with particular attention to facility geometrics, facility traffic demands, demand-capacity analysis, and optional traffic management strategies. Service measures, levels of service (LOS), and performance measures are also discussed.

The purpose of this section is to describe the computational modules of the methodology. To simplify the presentation, the focus is on the function of and rationale for each module. An expanded version of this section containing all the supporting analytical models and equations is presented in Appendix A.

PERFORMANCE MEASURES

Facilitywide service measures and LOS designations are not incorporated in this chapter, as they are in other chapters in Part III of this manual. This is due to the complexity of assessing freeway facilities when oversaturated flow conditions are encountered. A freeway facility may contain both uncongested and heavily congested segments, and any average service measure for the entire length is likely to be misleading and difficult to classify by LOS.

The methodology provides estimates of speed, travel time, density, flow rate (vehicle and person), volume-to-capacity ratio, and congestion status for each cell in the time-space domain. From these estimates, vehicle hours (person-hours) of travel as well as vehicle kilometers (person kilometers) of travel for each cell can be determined.

The previously discussed traffic performance measures can be aggregated by the analyst over the length of the freeway facility, over the study time duration, and over the entire time-space domain.

Single-lane HOV facilities can be analyzed only when flow rates are less than 1,600 veh/h/ln

Systemwide measures can be generated, but no LOS guidelines are given

SEGMENTING FREEWAY FACILITIES

The time-space domain of a freeway facility is used to provide an overview of the methodology. A typical time-space domain is shown in Exhibit 22-2.

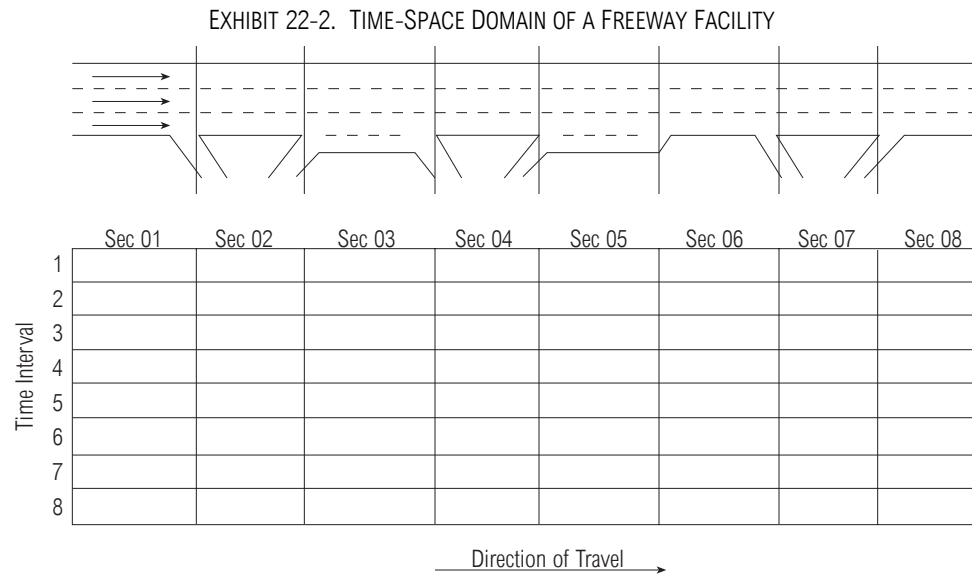

Freeway facilities up to 20 km long can be analyzed with the methodology

The horizontal scale indicates the distance along the freeway facility. Traffic moves from left to right, and the scale is divided into freeway sections. A freeway section boundary occurs wherever there is a change in traffic demand (i.e., on-ramp or off-ramp) or a change in segment capacity (i.e., lane drop or lane addition). Freeway facilities up to 15 to 20 km long can be analyzed by this methodology. Estimates of traffic demand on longer freeway facilities cannot be reliably developed with the methodology, because the travel time between some origins and destinations will exceed the standard time interval (15 min).

The vertical scale indicates the study time duration. Time extends down the time-space domain, and the scale is divided into 15-min intervals. The study time duration can include any number of contiguous 15-min intervals. The number of section-based cells in the time-space domain is the product of the number of sections and the number of 15-min intervals. In Exhibit 22-2 there are 64 section-based cells.

The boundary conditions of the time-space domain are extremely important since the time-space domain will be analyzed as an independent freeway facility having no interactions with the upstream or downstream portions of any connecting facilities (including freeways and surface streets) or with time periods before or after the study time duration. This means that no congestion should occur along the four boundaries of the time-space domain. The cells located along the four boundaries should all have demands less than capacities and should contain undersaturated flow conditions.

Exhibit 22-2 shows the division of the freeway facility into connected freeway sections. However, to use the predictions of capacity and performance measures from the basic freeway, ramp, and weaving segment chapters, the sections must be further divided into segments. Each section contains one or more segments depending on the freeway geometrics.

First, any weaving segment, as defined in Chapter 24, Freeway Weaving, is labeled as a weaving segment. Next, any on-ramp or off-ramp segment, as defined in Chapter 25, Ramps and Ramp Junctions, is labeled as an on-ramp or off-ramp segment. The remaining portions of the freeway facility are labeled as basic freeway segments (Chapter 23).

Special labeling of segments may be required under certain circumstances. For example, a long freeway section between an on-ramp and an off-ramp can be subdivided into three segments: on-ramp, basic freeway, and off-ramp. A complication may occur when a short freeway section contains an on-ramp followed by an off-ramp without an auxiliary lane between the two ramps. The problem arises if the length of the freeway section is insufficient to meet the requirements of the sum of the lengths of the on-ramp segment and the off-ramp segment as stated in Chapter 25. In that case, the overlapping freeway segment is analyzed both as an on-ramp segment and an off-ramp segment, and the more restrictive option is selected. Similarly, weaving sections with lengths exceeding 750 m can be analyzed as basic segments with the added auxiliary lane and ramp demands. Other special types of freeway sections requiring special attention may be encountered. In those cases, Chapters 23, 24, and 25 should be consulted. The transformation of freeway sections into freeway segments for the freeway facility of Exhibit 22-2 is shown in Exhibit 22-3. The estimated segment capacities and traffic performance algorithms filter down through the time-space domain so that each cell has an estimated capacity and an algorithm for predicting traffic performance measures.

EXHIBIT 22-3. CONVERSION OF FREEWAY SECTIONS INTO FREEWAY SEGMENTS

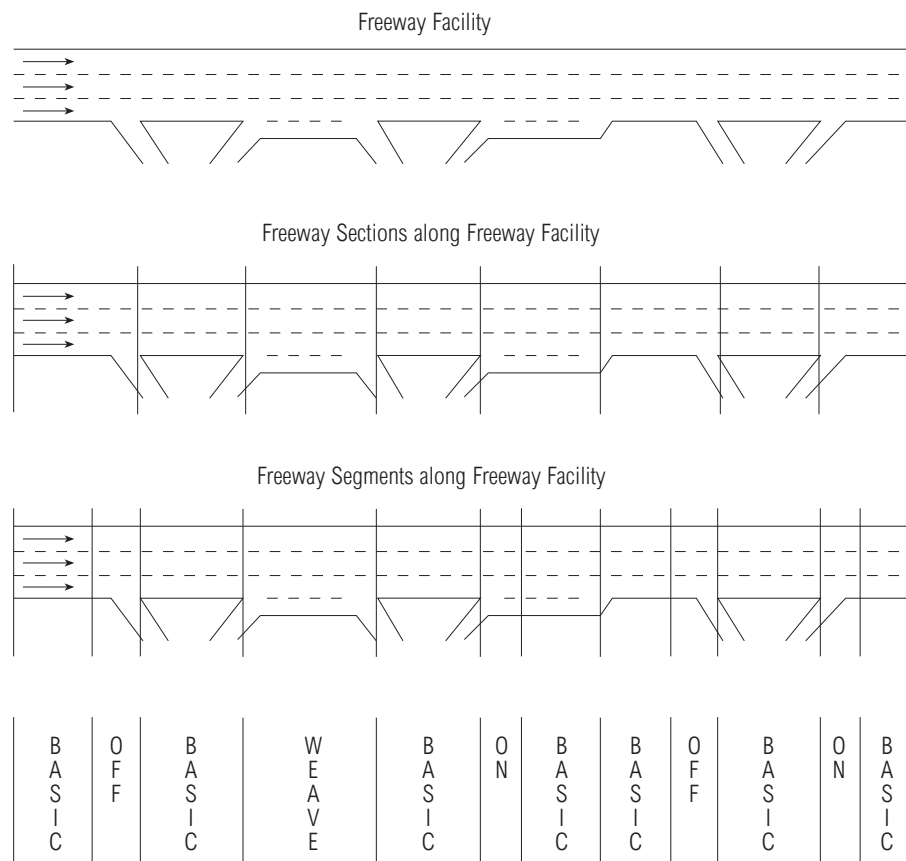

FREEWAY FACILITY DEMANDS AND ESTIMATION OF TRAFFIC DEMAND

Traffic counts at each entrance to and exit from the freeway facility (including the mainline entrance and the mainline exit) for each time interval serve as input to the methodology. Whereas entrance counts are considered to represent the current entrance demands for the freeway facility (provided that there is not a queue on the freeway entrance), the exit counts may not represent the current exit demands for the freeway facility because of freeway congestion.

Estimation of traffic demand requires careful differentiation of volume, as counted, and demand

Time interval scale factor defined

In this chapter, capacity computations are on a veh/h basis

Capacities can be selected to reflect a variety of controls or conditions

For planning applications, estimated traffic demands at each entrance to and exit from the freeway facility for each time interval serve as input to the methodology. The sum of the input demands must be equal to the sum of the output demands in every time interval.

Once the entrance and exit demands are calculated, the demands for each cell in every time interval can be estimated. The segment demands can be thought of as filtering across the time-space domain and filling each cell in the time-space matrix.

Demand estimation is required if the methodology uses actual freeway counts. If demand flows are known or can be projected, they are used directly. The demand estimation module converts the input set of freeway exit 15-min traffic counts into a set of freeway exit 15-min traffic demands. Freeway exit demand is defined as the number of vehicles that desire to exit the freeway in a given 15-min time interval. This demand may not be represented by the 15-min exit count because of upstream freeway congestion within the facility.

The procedure followed is to sum the freeway entrance demands along the entire freeway facility (including the freeway mainline entrance) and to compare it with the sum of the freeway exit counts along the entire directional freeway facility (including the freeway mainline exit) for each time interval. The ratio of the total freeway entrance demands to the freeway exit counts in each time interval is called the time interval scale factor. Theoretically, the scale factor should approach 1.00 when the freeway exit counts are, in fact, freeway exit demands.

Scale factors greater than 1.00 indicate increasing levels of congestion within the freeway facility, with exit traffic counts underestimating actual freeway exit demands. Scale factors less than 1.00 indicate decreasing levels of congestion, with exit traffic counts exceeding actual freeway exit demands. To provide an estimate of freeway exit demand, each freeway exit count is multiplied by the time interval scale factor.

Once the entrance and exit demands are determined, the traffic demands for each freeway section in each time interval can be calculated. On the time-space domain diagram, the section demands can be viewed as projecting horizontally across the diagram with each cell containing an estimate of its 15-min demand.

ADJUSTMENTS OF SEGMENT CAPACITY

Segment capacity estimates are determined directly from Chapters 23, 24, and 25 for basic, weaving, and ramp segments, respectively. All estimates of segment capacity should be carefully reviewed and compared with local knowledge and available traffic information for the study site, particularly for known bottleneck segments.

On-ramp and off-ramp roadway capacities are also determined in this module. On-ramp demands may exceed on-ramp capacities and limit the traffic demand entering the facility. Off-ramp demands may exceed off-ramp capacities and cause congestion on the freeway, although that effect is not accounted for in the methodology. Unlike the computations performed in the basic freeway, weaving, and ramp chapters, all capacity computations performed in this chapter are on the basis of vehicles per hour and not passenger cars.

The effect of a predetermined ramp-metering plan can be evaluated in this methodology by overriding the computed ramp roadway capacities. The capacity of each entrance ramp in each time interval is changed to the specified metering rate. This feature not only permits the evaluation of a prespecified ramp-metering plan, but also permits the user to improve the ramp-metering plan by experimentation.

Freeway design improvements can be evaluated within this methodology by modifying the design features of any portion or portions of the freeway facility. For example, the effect of adding auxiliary lanes at critical locations and full lanes over multiple segments can be assessed.

Reduced-capacity situations can also be investigated. The capacity in any cell of the time-space domain can be reduced to represent incident situations such as construction

and maintenance activities, adverse weather, and traffic accidents/vehicular breakdowns. Conversely, capacity can be increased to match field measurements. In analyzing adjusted capacity, use of an alternative speed-flow relationship is important. The computational details for this case are provided later in this chapter.

Permanent Capacity Reduction

A lane drop is in many ways the simplest capacity-reducing situation to deal with. Capacity in both segments, that with the smaller number of lanes and that with the larger number, can be calculated using Chapter 23, 24, or 25 methodologies. So long as the arriving demand is less than the lower capacity, no queue will form upstream of the lane drop. If the arriving demand begins to exceed the reduced capacity, a queue will begin to form immediately upstream of the reduced-capacity section, which will have become a bottleneck. Some results suggest that a poorly designed merge at the lane drop can negatively affect the capacity of the segment with the smaller number of lanes because of the increase in friction and turbulence, but this effect has not yet been quantified.

Construction Activities Capacity Reduction

Capacity reductions due to construction activities can be divided into short-term maintenance work zone lane closures and long-term construction zone closures. One of the primary distinctions between short-term work zones and long-term construction zones is the nature of the barriers used to demarcate the work area. Long-term construction zones generally have portable concrete barriers; short-term work zones use standard channeling devices (traffic cones, drums) in accordance with the *Manual on Uniform Traffic Control Devices* (2). Generally, reduction of capacity brought about by reconstruction or major maintenance activities will last for several weeks or even months, although some short-term maintenance activities last only a few hours.

Short-Term Work Zones

Research (3) suggests that a capacity of 1,600 pc/h/ln be used for short-term freeway work zones, regardless of the lane closure configurations. For some types of closures, capacity may be higher (3).

The base value should be adjusted for other conditions, as follows.

- **Intensity of work activity:** The intensity of work activity refers to the number of workers on site, the number and size of work vehicles in use, and the proximity of work to the travel lanes in use. Unusual types of work also contribute to the apparent intensity, simply in terms of the rubbernecking factor. Research data did not result in explicit quantification of these effects, but it is suggested that the capacity of 1,600 pc/h/ln be adjusted by up to ± 10 percent for work activity that is more or less intense than normal (3). The research did not define what constitutes normal intensity. Hence, this factor should be applied on the basis of professional judgment, recognizing that 1,600 pc/h/ln is an average over a variety of conditions.

- **Effects of heavy vehicles:** It is recommended that the heavy-vehicle adjustment factor, f_{HV} , found elsewhere in the manual be used to account for the effect of heavy vehicles in the traffic stream moving through the work zone, as shown in Equation 22-1.

$$f_{HV} = \frac{1}{1 + P_T (E_T - 1)} \quad (22-1)$$

where

- f_{HV} = heavy-vehicle adjustment factor,
- P_T = proportion of heavy vehicles, and
- E_T = passenger-car equivalent for heavy vehicles.

The value of E_T can be taken from Chapter 23, Basic Freeway Segments.

Intensity of work will affect capacity

Heavy vehicles should be accounted for

Entrance ramps within 150 m of a lane closure will affect capacity

- Presence of ramps: If there is an entrance ramp within the taper area approaching the lane closure or within 150 m downstream of the beginning of the full lane closure, the ramp will have a noticeable effect on the capacity of the work zone for handling mainline traffic. This arises in two ways. First, the ramp traffic will generally force its way in, so it will directly reduce the amount of mainline traffic that can be handled. Second, the added turbulence in the merging area due to the entrance ramp may itself reduce the capacity slightly. If at all possible, ramps should be located at least 450 m upstream from the beginning of the full closure to maximize the total work zone throughput. If that cannot be done, then either the ramp volume should be added to the mainline volume to be served or the capacity of the work zone should be decreased by the ramp volume (up to a maximum of half of the capacity of one lane, on the assumption that at very high volumes mainline and ramp vehicles will alternate). Equation 22-2 is used to compute the resulting reduced capacity.

$$c_a = (1,600 + I - R) * f_{HV} * N \tag{22-2}$$

where

- c_a = adjusted mainline capacity (veh/h);
- f_{HV} = adjustment for heavy vehicles as defined in Equation 22-1;
- I = adjustment factor for type, intensity, and location of the work activity, as discussed above (ranges from -160 to +160 pc/h/ln);
- R = adjustment for ramps, as described in the preceding paragraph; and
- N = number of lanes open through the short-term work zone.

Long-Term Construction Zones

For long-term construction zones, capacity values are given in Exhibit 22-4. If traffic crosses over to lanes that are normally used by the opposite direction of travel, the capacity is close to the 1,550 veh/h/ln value in Exhibit 22-4 (5). If no crossover is needed, but only a merge down to a single lane, the value is typically higher and may average about 1,750 veh/h/ln (6).

EXHIBIT 22-4. SUMMARY OF CAPACITY VALUES FOR LONG-TERM CONSTRUCTION ZONES

No. of Normal Lanes	Lanes Open	Number of Studies	Range of Values (veh/h/ln)	Average per Lane (veh/h/ln)
3	2	7	1780–2060	1860
2	1	3	–	1550

Source: Dudek (4).

Lane Width Consideration

An additional adjustment factor can be added to the long-term and short-term reduction model for the effect of lane width (7). For traffic with passenger cars only, headways increase by about 10 percent in going from 3.5-m widths to 3.25- or 3.0-m widths and by an additional 6 percent in going to 2.75-m widths. These increases in headways translate to 9 and 14 percent drops in capacity for the narrower lane widths within construction zones.

Adverse Weather Capacity Reduction

There have been several research studies on the effect of rain, snow, and fog. It has become clear that adverse weather can significantly reduce not only capacity but also operating speeds. The following sections discuss the effects of each of these weather conditions and address the issue of when and how to take these effects into account in applying the methodology.

Rain

Research found that speeds are not particularly affected by wet pavement until visibility is also affected (8). This result suggests that light rain will not have much effect on speeds (and presumably not on capacities) unless it is of such extended duration that there is considerable water on the pavement. Heavy rain, on the other hand, affects visibility immediately and can be expected to have a noticeable effect on traffic flow.

This expectation is borne out by studies of freeway traffic. Research found minimal reductions in maximum observed flows for light rain but significant reductions for heavy rain (9). Likewise, the research found a small effect on operating speeds for light rain and larger effects for heavy rain. These changes in operating speeds are important because they directly affect traffic performance.

For light rain, a reduction in free-flow speeds of 2.0 km/h was observed (9). At a flow rate of 2,400 veh/h, the effect of light rain was to reduce speeds to about 82 km/h, compared with speeds of 89 to 95 km/h under clear and dry conditions. Under light rain conditions, little if any effect was observed on flow or capacity.

For heavy rain, the drop in free-flow speeds was 5 and 7 km/h. The result of heavy rain is to reduce speeds at 2,400 veh/h to 76 and 79 km/h from, respectively, 89 and 95 km/h. These are reductions of 13 and 16 km/h. Maximum flow rates can also be affected and might be 14 to 15 percent lower than those observed under clear and dry conditions.

Snow

For snow, major differences were found depending on the quantity or rate of snowfall, with light snow having minimal effects and heavy snow having potentially very large effects (9). If snow-clearing operations cannot keep the road relatively clear during a heavy snowfall, the snow accumulation on the highway obscures the lane markings. Observation suggests that under these circumstances, drivers often seek not only longer headways, but also greater lateral clearance. As a result, a three-lane freeway segment is used as if it had only two widely separated lanes. This alone has a considerable effect on capacity.

Light snow was associated with a statistically significant drop of 1 km/h in free-flow speeds. The effect on maximum observed flows was midway between the effects of light and heavy rain or between a 5 and 10 percent reduction.

Heavy snow significantly influences the speed-flow curve. Free-flow speeds were reduced by 37 and 42 km/h at the two stations from what they were under clear and dry conditions (102 and 106 km/h, respectively). Maximum observed flows dropped from 2,160 to 1,200 veh/h/ln at the station upstream of the queue. At the station that might be a bottleneck itself for part of the peak period, the maximum observed flows dropped from 2,400 to 1,680 veh/h/ln. This suggests a 30 percent drop in capacity due to heavy snow in an urban area where traffic will generally keep moving to some extent.

Fog

Although no studies have quantified the effects of fog on capacity, work has been done in Europe on fog warning systems, which use variable speed limit signs to reduce speeds during foggy conditions. Those studies tend to report on the effectiveness of the speed warning signs in reducing mean speeds, not on what speeds (or capacities) are due to the fog alone. For example, they report effectiveness of fog warning devices of 8 to 10 km/h in reducing speed but provide no information on capacity effects (10, 11).

Environmental Capacity Reduction

Research in Germany used speed-flow-density relationships to fit speed-flow curves to the field observations (12). The capacity of each study site under a variety of conditions was estimated from these curves. The results are useful not only in extending the research results cited on rain and wet pavement but also in identifying some other

causes of temporary capacity reduction that have not generally been discussed (e.g., the difference between daylight and darkness and between weekdays and weekends).

A set of relationships for 10 to 15 percent heavy vehicles has been used for comparison in Exhibit 22-5. Although this exhibit shows the per lane capacities found in Germany, the numbers clearly do not translate directly to North American conditions. The most obvious difference is that capacity per lane is lower than would be found in North America. In addition, the capacity per lane for a six-lane freeway is lower than that of a four-lane freeway for all but one of the conditions. These results are no doubt a consequence of the function the researchers were fitting, together with the fact that there were few data near capacity because hourly data were analyzed. What is important in the exhibit is the percentage reduction in capacity under each of the sets of conditions, which is shown on the second line for each type of freeway and type of day (weekday or weekend).

EXHIBIT 22-5. CAPACITIES ON GERMAN AUTOBAHNS UNDER VARYING CONDITIONS (veh/h/ln)

Freeway Type	Weekday or Weekend	Daylight and Dry	Dark and Dry	Daylight and Wet	Dark and Wet
Six-lane freeway	Weekday	1489	1299	1310	923
	Change ^a (%)		13	12	38
Six-lane freeway	Weekend	1380	1084	1014	-
	Change ^a (%)		21	27	-
Four-lane freeway	Weekday	1739	1415	1421	913
	Change ^a (%)		19	18	47
Four-lane freeway	Weekend	1551	1158	1104	-
	Change ^a (%)		25	29	-

Note:

a. The percentage reduction from daylight and dry conditions for the same day of the week.

Source: Brilon and Ponzlet (12).

The estimates for weekdays and daylight for the reduction due to wet pavement, 12 and 18 percent, are consistent with the estimates discussed above for the effects of rain. The reductions in capacity due to darkness are of the same order as those due to rain: 13 and 19 percent for six- and four-lane facilities, respectively. Since winter peak-period commuter traffic occurs in darkness in many locations, these capacity reductions are important to recognize.

The capacity of a freeway on weekends or holidays can be substantially less than when it carries commuter traffic. Although the percentage change is not shown in the exhibit, it amounts to a 7 to 10 percent reduction during dry daylight conditions.

Capacity Reductions due to Traffic Accidents or Vehicular Breakdowns

Capacity reductions due to traffic accidents or vehicular breakdowns are generally short-lived, ranging from less than 1 h before they can be cleared (for a minor fender-bender involving only passenger vehicles) to as long as 12 h (for a major accident involving fully loaded tractor-trailer rigs). For example, on the basis of research, the mean duration of a traffic incident was 37 min, with just over half of the incidents lasting 30 min or less and 82 percent of the incidents lasting 1 h or less (13). When trucks were involved, however, the duration was longer; accidents involving trucks lasted 63 min on the average.

The effect of an incident on capacity depends on the proportion of the traveled roadway that is blocked by the stopped vehicles, as well as on the number of lanes on the roadway at that point. Exhibit 22-6 gives information on these effects (14, 15).

Mean duration of an incident was 37 min but was highly variable

EXHIBIT 22-6. PROPORTION OF FREEWAY SEGMENT CAPACITY AVAILABLE UNDER INCIDENT CONDITIONS

Number of Freeway Lanes by Direction	Shoulder Disablement	Shoulder Accident	One Lane Blocked	Two Lanes Blocked	Three Lanes Blocked
2	0.95	0.81	0.35	0.00	N/A
3	0.99	0.83	0.49	0.17	0.00
4	0.99	0.85	0.58	0.25	0.13
5	0.99	0.87	0.65	0.40	0.20
6	0.99	0.89	0.71	0.50	0.26
7	0.99	0.91	0.75	0.57	0.36
8	0.99	0.93	0.78	0.63	0.41

N/A - not applicable.

Source: Reiss and Dunn (14) and Gordon et al. (15).

Note that in the case of a blocked lane, the loss of capacity is likely to be greater than simply the proportion of original capacity that is physically blocked. For example, a four-lane (in one direction) freeway with two lanes blocked retains only 25 percent of its original capacity (Exhibit 22-6). The added loss of capacity arises because drivers slow to look at the incident while they are abreast of it and are slow to react to the possibility of speeding up to move through the incident area.

The rubbernecking factor is also responsible for a reduction in capacity in the direction of travel opposite to that in which the accident occurred. No quantitative studies of this effect have been published, but experience suggests that it depends on the magnitude of the incident (including the number of emergency vehicles present). The reduction may range from 5 percent for a single-car accident and one emergency vehicle to 25 percent for a multivehicle accident with several emergency vehicles.

Applying Capacity Reductions

There are several ways to use the information on reduced capacities contained in the preceding material, ranging from quick approximations, through the application of the methodology described in this chapter, to other quantitative approaches involving queuing analysis or shock wave analysis. The quick approximations simply require reviewing the expected traffic demands and comparing them with the applicable capacity reduction. If the demands do not exceed the reduced capacity, there will not be any major difficulties in handling the traffic. A more detailed analysis may be desired to estimate the expected traffic performance, in which case use of the methodology would be appropriate.

The methodology works with the full speed-flow curve (for the undersaturated part of the relationship), but in many of the cases described above, only the effect on capacity has been identified by research reported to date. The literature does not describe the effect of the factor (incident, construction) on speeds and hence on the speed-flow curve. Without a full speed-flow curve, the analyst is forced to use other methods or to work around this limitation of the model. Consider each of the capacity reductions in turn, from the simplest to the most difficult to deal with.

Adverse weather is the easiest to deal with, because the results cited above indicate effects on both speeds and capacity. Consequently, the analyst can simply use a speed-flow curve for a lower free-flow speed (FFS) to model the effects of inclement weather. Neither of the research studies reported a method that would equate to a reduction in FFS, but their results can be reasonably well approximated that way (9, 12). For light rain or snow, for example, speeds at capacity drop by 7 to 13 km/h, which can be approximated by a reduction in FFS of 10 km/h. For heavy rain, the approximation would be a reduction in FFS of 20 km/h. For heavy snow, the reduction would be 50 km/h. Exhibit 22-7 shows the approximate curves for these conditions, using a constant density to determine the capacity for each curve.

Assumptions regarding effects on speeds

EXHIBIT 22-7. SPEED-FLOW CURVES FOR DIFFERENT WEATHER CONDITIONS

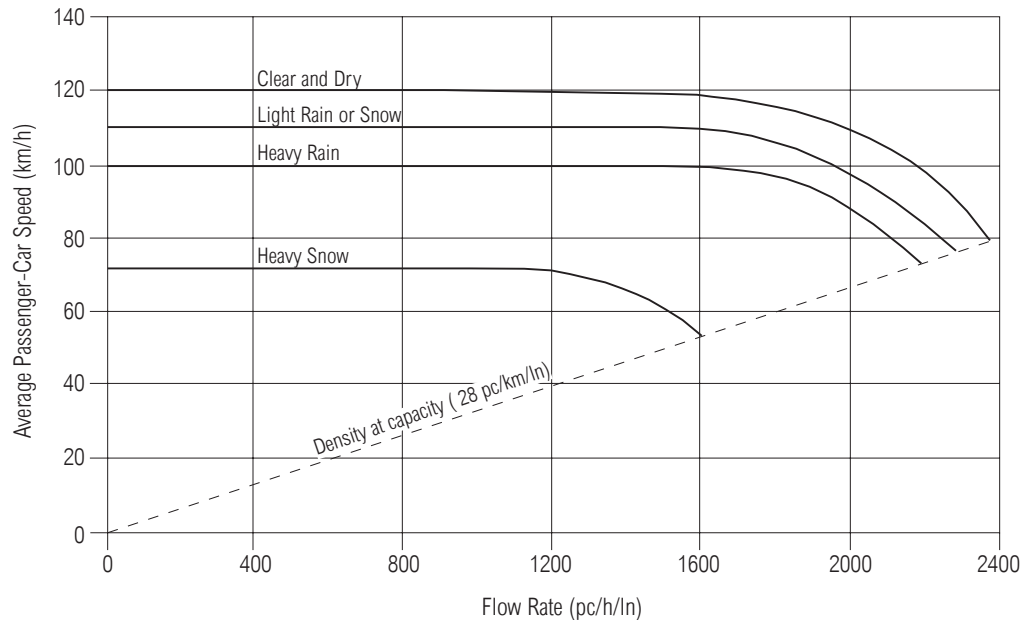

Note:
FFS = 120 km/h (base conditions).

For the other temporary capacity reductions, the research findings deal only with the change in capacity. In most of these cases, reasonable estimates of speed conditions can be made. For example, in construction zones, a reduced speed is usually posted, and lower speeds usually do occur, particularly where actual construction operations are taking place. Likewise, for incidents, traffic naturally slows as drivers pass the incidents and try to get a look at what happened. Thus, one can attempt to model these situations on the basis of a downward-shifted speed-flow curve, like those shown in Exhibit 22-8.

If the analyst were not interested in the speeds, the capacity reduction could be modeled by using a fractional number of lanes that would reflect the new capacity of the roadway, rather than the real number of lanes. For example, in the case of a four-lane (in one direction) freeway facility with two lanes blocked, Exhibit 22-6 shows that only 25 percent of the original capacity is available. To reflect this, the analyst could show only a single lane through the area of the incident, even though it is in fact a four-lane segment. However, since most of the performance measures rely on or are based on speed, this simplified approach will not permit a complete analysis. Consequently, use of a speed-flow curve from the family shown in Exhibit 22-7 or 22-8 is recommended.

The methodology and other methods have a role in analyzing the effect of incidents, even when they are of short duration, by assisting in the planning of responses to various types and locations of incidents before they occur. The advantage of planning is that it can minimize the need for improvising decisions about diversion plans and other methods of responding to incidents.

DEMAND-CAPACITY RATIO

Each cell in the time-space domain now contains an estimate of demand and capacity as well as an algorithm for calculating traffic performance measures. A demand-to-capacity ratio can be calculated for each cell, and the cell values should be reviewed to see whether in fact the time-space domain is free of congestion on its boundary and whether oversaturated flow conditions will occur anywhere in the time-space domain.

EXHIBIT 22-8. ADJUSTED SPEED-FLOW CURVES FOR INDICATED CAPACITY ADJUSTMENTS
(SEE FOOTNOTE FOR ASSUMED VALUES)

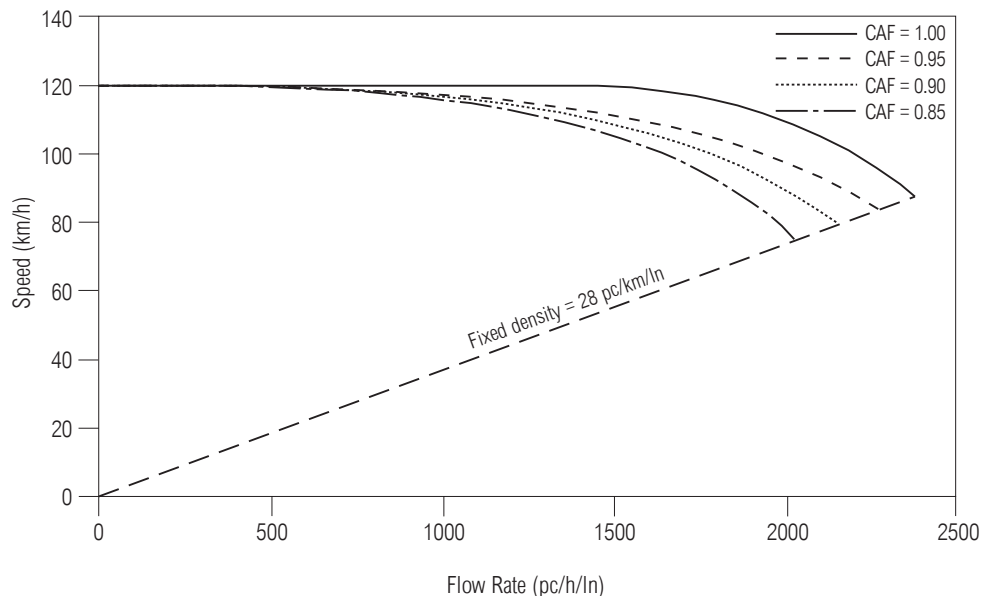

Note:
Assumptions: FFS = 120 km/h, capacity adjustment factor (CAF) of 1.0, 0.95, 0.90, and 0.85.

The demand-to-capacity ratio values should be less than 1.0 for all cells along the four boundaries of the time-space domain. If they are not, further analysis may be flawed and in some cases should not be undertaken. For example, if any cell in the first time interval has a demand-to-capacity ratio value greater than 1.0, there may have been oversaturated conditions in earlier time intervals without transfer of unsatisfied demand into the time-space domain. If any cell in the last time interval has a demand-to-capacity ratio greater than 1.0, the analysis will not be complete, since the unsatisfied demand within the time-space domain cannot be transferred to later time intervals. If any cell in the last downstream segment has a demand-to-capacity ratio greater than 1.0, there may be downstream bottlenecks that should be checked before proceeding with the analysis. Finally, if any cell in the first upstream segment has a demand-to-capacity ratio greater than 1.0, then oversaturation will be extended upstream of the freeway facility, but its effect will not be analyzed within the time-space domain.

These checks do not assure the analyst that the boundaries may not be violated later as the result of the more detailed analysis. If the initial checks indicate that demands exceed capacities at the boundary segments, the problem analysis domain should be adjusted. As the analysis is undertaken, the problem of demand exceeding capacity may occur again at the time-space domain boundaries, requiring that the problem be reformulated or that other techniques as described in Part V of this manual be considered. For example, oversaturated conditions at a downstream bottleneck may be so severe as to extend upstream into or beyond the first freeway segment or beyond the last time interval.

Another important check is to observe whether any cell in the entire time-space domain has a demand-to-capacity ratio value greater than 1.0. If all cells have demand-to-capacity ratio values less than 1.0, then the entire time-space domain contains undersaturated flow conditions, and the analysis is greatly simplified.

If any cell in the time-space domain has a demand-to-capacity ratio value greater than 1.0, then the time-space domain will contain both undersaturated and oversaturated flow conditions. Analysis of oversaturated flow conditions is much more complex because of the interactions between freeway segments.

The analysis begins in the first cell in the upper left-hand corner of the time-space domain (first segment in first time interval) and continues downstream along the freeway

Demand/capacity should be less than 1.0 for all cells along the four boundaries of the time-space domain

Four-step process to analyze bottlenecks:

1. Bottleneck cell analysis
2. Downstream demand modifications
3. Upstream flow modifications
4. Demand transfer to next time interval

Shock wave analysis is used to analyze queue backup

facility for each segment in the first time interval. The analysis then returns to the first upstream segment in the second time interval and continues downstream along the freeway for each segment in the second time interval. This process is continued until all cells in the time-space domain have been analyzed.

As each cell is analyzed, the question is asked, Is the cell demand-capacity ratio less than or equal to 1.0? If the answer is yes, then the cell is not a bottleneck and is assumed to be able to handle all traffic that wants to enter. This process is continued in the sequence order described in the preceding paragraph until an answer of no is encountered, indicating that the demand-capacity ratio in this cell is greater than 1.0. This cell is identified as a bottleneck, and the traffic that wishes to enter cannot do so. The following four-step process is required to analyze each cell identified as a bottleneck: bottleneck cell analysis, downstream demand modifications, upstream flow modifications, and demand transfer to next time interval.

Since the demand in the bottleneck cell exceeds the bottleneck cell capacity, the flow in the cell will be equal to capacity, not demand. Each bottleneck cell will have a volume-capacity ratio of exactly 1.0. On the basis of this volume-capacity ratio, traffic performance measures can be estimated.

Since the bottleneck cell can only pass a flow equal to capacity (not demand) to the downstream segments in this time interval, the demands for all downstream cells must be modified in accordance with the destinations of the unsatisfied demand at the bottleneck.

The unsatisfied demand at the bottleneck cell must be stored in the upstream segment(s), and flow conditions and traffic performance measures in the upstream segments must be modified. This is accomplished through shock wave analysis.

The unsatisfied demand stored upstream of the bottleneck cell must be transferred to the next time interval. This is accomplished by adding the unsatisfied demand by desired destination to the origin-destination table of the next time interval.

This four-step process is implemented for each bottleneck encountered following the specified sequence of analyzing cells. If no bottleneck cells are encountered, then the entire time-space domain will have undersaturated conditions, and the sequence of analysis for oversaturation is not used. If major bottlenecks are encountered, the storage of unsatisfied demand may extend beyond the upstream boundary of the freeway facility or beyond the last time interval of the time-space domain. In such cases, the analysis will be flawed, and the time-space domain should be reformulated.

Once traffic performance measures have been estimated for each cell in the time-space domain, they can be aggregated for the entire freeway facility for each time interval and for the entire study time duration. The methodology for calculating these freeway traffic performance measures is described in the following section.

UNDERSATURATED CONDITIONS

The analysis begins by examining the demand-to-capacity ratios for all segments during the first time interval. If all segments have a demand-to-capacity ratio less than 1.0, then this time interval is completely undersaturated. The flow (or volume) is equal to demand for each cell, and undersaturated flow conditions occur. Performance measures for the first segment during the first time interval are calculated by using the methodology for the corresponding segment type in Chapters 23, 24, and 25.

The analysis continues to the next downstream freeway segment in the same time interval, and the performance measures are calculated for all subsequent downstream segments. The analysis then resumes in the second time interval from the furthest upstream segment and moves downstream until all freeway segments in that time interval have been analyzed. This pattern continues until the methodology encounters a time interval having one or more segments with a demand-to-capacity ratio greater than 1.0. If this occurs, the oversaturated analysis module is executed.

When the analysis moves from isolated segments to a system, an additional constraint may be necessary. A maximum achievable speed constraint is imposed to limit the predicted speed downstream of a segment experiencing low speeds. This process prevents large speed fluctuations that can be predicted when applying the segment-based methods in Chapters 23, 24, and 25.

OVERSATURATED CONDITIONS

Once oversaturation is encountered, the methodology changes its temporal and spatial units of analysis. The spatial units become nodes and segments, and the temporal unit moves from a time interval of 15 min to smaller time steps as recommended in Appendix A. A node is defined as the junction of two segments. There is always one more node than segment, with a node analyzed at the beginning and end of the freeway facility as shown in Exhibit 22-9. The numbering of nodes and segments begins at the upstream end and moves to the downstream end, with the segment upstream of Node (i) numbered (i - 1) and the downstream segment numbered (i), as shown in Exhibit 22-10. The oversaturated analysis moves from the first node to each downstream node for a time step. After the completion of a time step, the same nodal analysis is performed for the following time steps. Many flow variables are computed in this analysis, with the most prominent described in the next section.

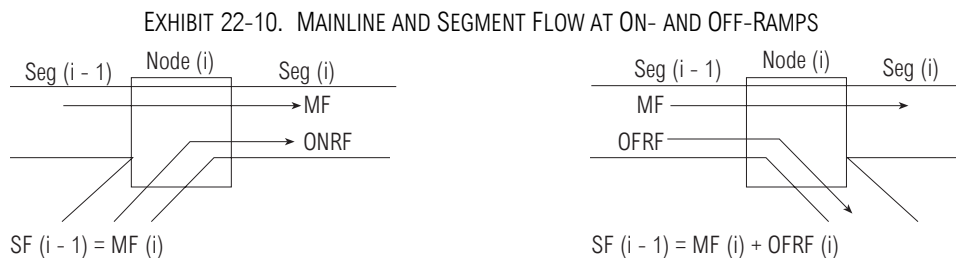
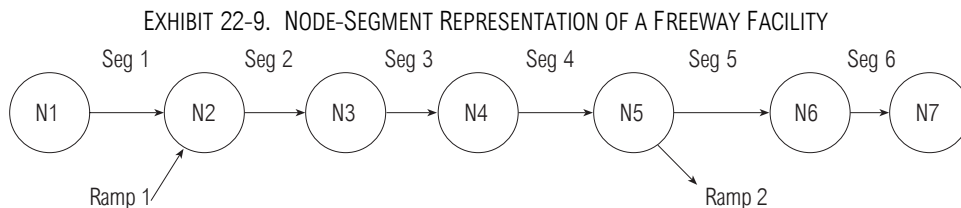

Flow Fundamentals

Segment flow rates are calculated in each time step and are used to calculate the number of vehicles on each segment at the end of every time step. The number of vehicles on each segment is used to track queue accumulation and discharge and to calculate the average segment density.

The conversion from time intervals to time steps occurs during the first oversaturated time interval, and time steps continue in use until the end of the analysis. The transition to time steps is essential because at certain points in the methodology future performance is estimated from past performance of an individual variable. Use of time steps also allows more accurate tracking of queues.

Freeway analysis depends on the relationships between speed, flow, and density. Chapters 23, 24, and 25 define a relationship between these variables and the calculation of performance measures in the undersaturated regime. The methodology uses this relationship in the calculations for undersaturated segments. Calculations for segments

Additional system considerations:

- Speed on a segment may be constrained by a slower speed on an upstream segment
- Speed estimate is made for the full roadway width in a ramp influence area

Node defined

Time steps of less than 15 min are used

performing in the oversaturated regime use a simplified linear flow-density relationship in the congested region, as detailed in Appendix A.

Segment Initialization

For the number of vehicles on each segment at the various time steps to be calculated, the segments must contain the proper number of vehicles before the queuing analysis places unserved vehicles on segments. The initialization of each segment is described below.

A simplified queuing analysis is initially performed to account for the effects of upstream bottlenecks. These bottlenecks meter traffic downstream. To obtain the proper number of vehicles on each segment, the segment's expected demand is calculated. The expected demand is based on demands for and capacities of the segment including the effects of all upstream segments. Expected demand represents the flow of traffic that would be expected to arrive at each segment if all queues were stacked vertically (i.e., if queues had no upstream effects). Thus, all segments upstream of a bottleneck have expected demands equal to actual demands. For the bottleneck and all further downstream segments, a capacity constraint at the bottleneck (which meters traffic to downstream segments) is applied in the computation of expected demand. From the expected segment demand, the background density can be obtained for each segment using the appropriate segment density estimation procedures from Chapters 23, 24, and 25.

Mainline Flow Calculation

Flows analyzed in oversaturated conditions are calculated for every time step and are expressed in vehicles per time step. They are analyzed separately on the basis of the origin and destination of the flow across the node. The flow from the mainline upstream Segment ($i - 1$) to mainline downstream Segment (i) is the mainline flow (MF). The flow from the mainline to an off-ramp is the off-ramp flow (OFRF). The flow from an on-ramp to the mainline is the on-ramp flow (ONRF). Each of these flows is shown in Exhibit 22-10 with its origin and destination and relationship to Segment (i) and Node (i).

The segment flow is the total output of a segment, as shown in Exhibit 22-10. The mainline flow is calculated as the minimum of six values. These constraints are the mainline input, Mainline Output 1, Mainline Output 2, Mainline Output 3, the upstream Segment ($i - 1$) capacity, and the downstream Segment (i) capacity.

Mainline Input

The mainline input is the number of vehicles that wish to travel through a node during the time step. The calculation includes the effects of bottlenecks upstream of the subject node. The effects include the metering of traffic during queue accumulation and the presence of additional traffic during queue discharge.

The mainline input is calculated by taking the number of vehicles entering the node upstream of the analysis node, adding on-ramp flows or subtracting off-ramp flows, if needed, and adding to it the number of unserved vehicles on the upstream segment. This is the maximum number of vehicles that desire to enter a node during a time step.

Mainline Output

The mainline output is the maximum number of vehicles that can exit a node, constrained by downstream bottlenecks or by merging traffic. Different constraints on the output of a node result in three separate types of mainline outputs (MO1, MO2, and MO3).

Mainline Output from Ramps

Mainline Output 1 (MO1) is the constraint caused by the flow of vehicles from an on-ramp. The capacity of an on-ramp segment is shared by two competing flows. This

on-ramp flow limits the flow from the mainline at this node. The total flow that can pass the node is estimated as the minimum of the Segment (i) capacity and the mainline outputs (MO2 and MO3 below) calculated in the preceding time step.

Mainline Output from Segment Storage

The output of mainline flow through a node is also constrained by the growth of queues on the downstream segment. The presence of a queue limits the flow into the segment once the queue reaches its upstream end. The queue position is calculated from shock wave analysis.

The MO2 limitation is determined first by calculating the maximum number of vehicles allowed on a segment at a given queue density. The maximum flow that can enter a queued segment is the number of vehicles leaving the segment plus the difference between the maximum number of vehicles allowed on a segment and the number of vehicles already on the segment. The queue density is determined from the linear, congested portion of the density-flow relationship shown in Appendix A.

Mainline Output from Front-Clearing Queue

The final limitation on exiting mainline flows at a node is caused by front-clearing downstream queues or MO3. These queues typically occur when temporary incidents clear. Two conditions must be satisfied. First, the segment capacity (minus the on-ramp demand if present) for the current time interval must be greater than the segment capacity (minus on-ramp demand) in the preceding time interval. The second condition is that the segment capacity minus the ramp demand for the current time interval be greater than the segment demand in the same interval.

Front-clearing queues do not affect the segment throughput (which is limited by the queue throughput) until the recovery wave has reached the upstream end of the segment. The shock wave speed is estimated from the slope of the line connecting the bottleneck throughput and the segment capacity points.

Mainline Flow

The mainline flow across Node (i) is the minimum of the following variables: Node (i) mainline input, Node (i) Mainline Output 1, Node (i) Mainline Output 2, Node (i) Mainline Output 3, Segment (i – 1) capacity, and downstream Segment (i) capacity.

Determining On-Ramp Flow

The on-ramp flow is the minimum of the on-ramp input and output. Ramp input in a time interval is the ramp demand plus any unserved ramp vehicles from a previous time interval.

On-ramp output is limited by the ramp roadway capacity and the ramp-metering rate. It is also affected by the volumes on the mainline segments. The latter is a very complex process that depends on the various flow combinations on the segment, the segment capacity, and the ramp roadway volumes. Details of the calculations are presented in Appendix A.

Determining Off-Ramp Flow

The off-ramp flow is determined by calculating a diverge percentage based on the segment and off-ramp demands. The diverge percentage varies only by time interval and remains constant for vehicles that are associated with a particular time interval. If there is an upstream queue, then there may be metering of traffic to this off-ramp. This will cause a decrease in the off-ramp flow. When the vehicles that were metered arrive in the next time interval, they use the diverge percentage associated with the preceding time interval. The methodology ensures that all off-ramp vehicles prevented from exiting during the presence of a bottleneck are appropriately discharged in later time intervals.

Ramp diverge percentages may vary by time interval, and this will be affected by queuing at bottlenecks

Determining Segment Flow

The segment flow is the number of vehicles that flow out of a segment during the current time step. These vehicles enter the current segment either to the mainline or to an off-ramp at the current node as shown in Exhibit 22-9. The number of vehicles on each segment is calculated on the basis of the following: the number of vehicles that were on the segment in the previous time step, the number of vehicles that have entered the segment in the current time step, and the number of vehicles that can leave the segment in the current time step. Because the number of vehicles that leave a segment must be known, the number of vehicles on the current segment cannot be determined until the upstream segment is analyzed.

The number of unserved vehicles stored on a segment is calculated as the difference between the number of vehicles on the segment and the number of vehicles that would be on the segment at the background density.

Determining Segment Service Measures

In the last time step of a time interval, the segment flows in each time step are averaged over the time interval, and the measures of effectiveness for each segment are calculated. If there were no queues on a particular segment during the entire time interval, then the performance measures are calculated from Chapters 23, 24, and 25 as appropriate.

If there was a queue on the current segment during the time interval, then the performance measures are calculated in three steps. First, the average number of vehicles over a time interval is calculated for each segment. Next, the average segment density is calculated by taking the average number of vehicles in all time steps in the time interval and dividing it by the segment length. Finally, the average speed on the current segment during the current time interval is calculated as the ratio of segment flow to density. The final segment performance measure is the length of the queue at the end of the time interval (if it exists), which is calculated from shock wave theory.

Queue length on on-ramps can also be calculated. A queue will form on the on-ramp roadway only if the flow is limited by a meter or by freeway traffic in the gore area. If the flow is limited by the ramp roadway capacity, unserved vehicles will be stored on a facility upstream of the ramp roadway, most likely a surface street. The methodology does not account for this delay. If the queue is on the ramp roadway, the queue length is calculated by using the difference in background and queue densities.

DETERMINING FREEWAY FACILITY PERFORMANCE MEASURES

The previously discussed traffic performance measures can be aggregated over the length of the freeway facility, over the time duration of the study interval, or over the entire time-space domain.

Aggregating the estimated traffic performance measures over the entire length of the freeway facility provides facilitywide estimates for each time interval. Averages and cumulative distributions of speed and density for each time interval can be determined, and patterns of their variation over the connected time intervals can be assessed. Trip times, vehicle (and person) distance of travel, and vehicle (and person) hours of travel can be computed and patterns of their variation over the connected time intervals can be assessed.

Aggregating the estimated traffic performance measures over the time duration of the study interval provides an assessment of the performance of each segment along the freeway facility. Average and cumulative distributions of speed and density for each segment can be determined, and patterns of the variation over connected freeway segments can be compared. Average trip times, vehicle (and person) distance of travel, and vehicle (and person) hours of travel are easily assessed for each segment and compared.

Three-step procedure

Queues on ramps

Facilitywide measures:

- Trip time
- Vehicle and person distance of travel
- Vehicle and person-hours of travel

III. APPLICATIONS

The methodology is applied in the sequence indicated in Exhibit 22-11. The process consists of nine steps and is based on the methodology described in the preceding section. A detailed flowchart that processes the oversaturation portion of the analysis is provided in Appendix A.

Guidelines on required inputs and estimated values are given in Chapter 13

EXHIBIT 22-11. IMPLEMENTATION OF FREEWAY FACILITY METHODOLOGY

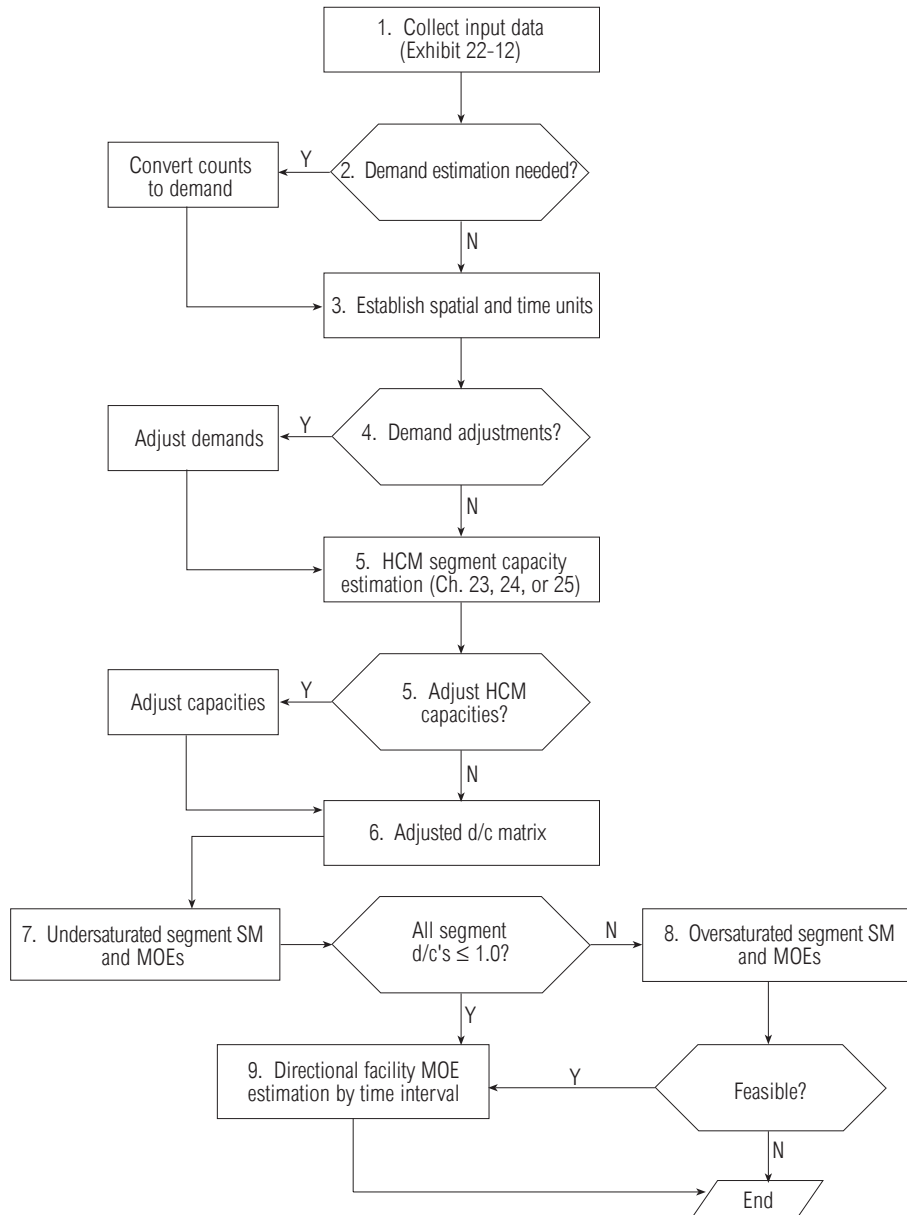

Notes:
 d/c = demand-to-capacity ratio.
 SM = service measure.
 MOE = measure of effectiveness.

COMPUTATIONAL STEPS

1. Collect input data for the directional facility. Provide guidance on limits of congestion in time and space. Document any demand and capacity adjustments that should be considered in the analysis. The input data define the time-space domain of the

freeway facility. The data include the specification of the facility in terms of length, number of sections, and geometric attributes. Exhibit 22-12 summarizes the inputs required to perform an analysis.

EXHIBIT 22-12. REQUIRED INPUT DATA FOR FREEWAY FACILITY ANALYSIS

Geometric Data for Each Section
<ul style="list-style-type: none"> • Section length (m) • Mainline number of lanes • Mainline average lane width (m) • Mainline lateral clearance (m) • Terrain (level, rolling, or mountainous) • Ramp number of lanes • Ramp acceleration or deceleration lane length (m)
Traffic Characteristics Data
<ul style="list-style-type: none"> • Mainline free-flow speed (km/h) (optional) • Vehicle occupancy (passengers/veh) • Percent trucks and buses (%) • Percent recreational vehicles (%) • Driver population (commuter or recreational) • Ramp free-flow speeds (km/h)
Demand Data
<ul style="list-style-type: none"> • Mainline entry demand for each time interval • On-ramp demands for each time interval • Off-ramp demands for each time interval • Weaving demand on weaving segments

2. Check whether adjustments from counts to estimate demands are needed. If the demands represent actual counts from a freeway facility (for example, from a freeway management system) and the system is experiencing oversaturation, an adjustment from counts to demands may be carried out in this step.

3. Establish spatial and time analysis units. Convert sections to segments as described, calculate time step for oversaturation, and establish other time units such as time intervals and analysis duration.

Spatially, the HCM analysis unit is a segment. On the basis of the definitions of ramp influence areas (450 m upstream of off-ramps and downstream of on-ramps as indicated in Chapter 25), sections are subdivided into segments. Similarly, weaving sections are defined as having a maximum length of 750 m. The analysis duration can vary from one to twelve 15-min intervals. Demand and capacity rates are fixed during an interval. The time step for oversaturation analysis depends on the length of the shortest segment on the facility and can vary from 15 to 60 s.

4. The procedure permits manual adjustments of segment demands. This may encompass the application of overall growth factors to test the adequacy of the facility to meet projected demands or simulate the effect of demand diversion onto adjacent facilities. The factors can be applied to individual origin and destination points.

5. Calculate segment capacity using HCM methods and adjust capacity as needed. Using the segment analysis methodologies of Chapters 23 through 25, segmentwide capacities in vehicles per hour are computed. These values are assumed to reflect normal capacity conditions. If the user is interested in adjusting capacities to reflect field measurements or to simulate a capacity reduction occurrence such as an incident or a work zone, a capacity adjustment factor is introduced. This factor changes both the capacity value and the speed-flow relationship for the affected segment during the affected time intervals.

Time steps can range from 15 to 60 s

6. Generate an adjusted demand-to-capacity (d/c) matrix by segment and time interval. Identify whether this facility is completely undersaturated or has some oversaturated time intervals.

Each segment demand is divided by its corresponding capacity in each time interval. The resulting d/c matrix is then used to evaluate the feasibility of the analysis and to identify which intervals have oversaturated segments.

The segment procedures are applied to undersaturated time intervals. The analyst is referred to the speed, density, and LOS estimation methods for basic, weaving, and ramp segments in Chapters 23, 24, and 25, respectively.

7. For the first time interval with $d/c > 1.0$ for some segment, begin using the reduced time step to carry out all computations. Calculate the position of bottlenecks and queues in each time step. Use appropriate flow regimes (undersaturated for segments with no queues and oversaturated for segments with queues) to estimate speeds and densities on each segment. Aggregate measures of effectiveness (MOEs) for each segment by time interval. Proceed to the next time interval until all time intervals in the period are analyzed.

The purpose of the oversaturated analysis is to calculate the actual flows on and the number of vehicles occupying each segment. By comparing the current number of vehicles on a segment with the number of vehicles that would be expected on it at the background density, segment queues can be identified and tracked each minute. The smaller time step is necessary to ensure that fast-growing queues do not jump over a short segment if not updated frequently.

8. The bottleneck analysis begins by setting the flow-to-capacity ratio on that segment to 1.0. The unmet demand is transferred to the next time interval, and the reduced flow rate through the bottleneck is propagated upstream in the form of a queue whose density depends on the severity of the bottleneck. When an upstream on-ramp is encountered, its flow rate is calculated on the basis of the level of congestion on the segment immediately downstream of the on-ramp and the magnitude of mainline and on-ramp flows at that node. Downstream of the bottleneck, flows are metered at the bottleneck capacity rate, which may result in starving subsequent mainline segments and off-ramp flows. Only when the bottleneck effects clear (when demands drop or capacity increases) do the flows on downstream segments increase to serve the unmet demand from the preceding time interval. Given adequate time, the flows will catch up with demand, and undersaturated operations will resume.

9. Aggregate individual segment MOEs into a directional facility MOE for each time interval. Examples include average speed, density, vehicle kilometers of travel (VkmT), vehicle hours of travel (VHT), vehicle hours of delay (VHD), and travel time. Facilitywide performance measure calculations by time interval are detailed in Appendix A.

TRAFFIC MANAGEMENT STRATEGIES

The methodology for freeway facilities has incorporated procedures for the assessment of a variety of traffic management strategies. The methodology permits the modification of previously calculated cell demands or capacities (or both) within the time-space domain to assess a traffic management strategy or a combination of strategies, as described below.

1. A growth factor parameter has been incorporated to evaluate traffic performance when traffic demands are higher or lower than the demand calculated from the traffic counts. This parameter would be used to undertake a sensitivity analysis of the effect of demand on freeway performance and to evaluate future scenarios. In these cases, all cell demand estimates are multiplied by the growth factor parameter.

2. The effect of a predetermined ramp-metering plan can be evaluated by modifying the ramp roadway capacities. The capacity of each entrance ramp in each time interval is changed to the desired metering rate. This feature permits both evaluation of a

predetermined ramp-metering plan and experimentation to obtain an improved ramp-metering plan.

3. Freeway design improvements can be evaluated within this methodology by modifying the design features of any portion or portions of the freeway facility. For example, the effect of adding an auxiliary lane at a critical location can be assessed. The effect of adding merging or diverging lanes can also be assessed.

4. Reduced-capacity situations can be investigated. The capacity in any cell or cells of the time-space domain can be reduced to represent situations such as construction and maintenance activities, adverse weather, and traffic accidents and vehicle breakdowns.

5. An independent HOV facility can be evaluated with this methodology. The analysis is similar to that of a freeway facility without an HOV lane. The methodology does not permit the analysis of concurrent HOV lanes.

User demand responses such as spatial, temporal, modal, or total demand responses caused by a traffic management strategy are not automatically incorporated into the methodology. On viewing the new freeway traffic performance results, the user can modify the demand input manually to evaluate the effect of anticipated demand responses.

As stated earlier, these traffic management strategies can be evaluated individually or in combinations. For more complex traffic management strategies for which the chapter methodology is not appropriate (such as concurrent HOV-lane freeways or significant demand responses), refer to Part V of this manual.

IV. EXAMPLE PROBLEMS

Problem No.	Description
1	Fully undersaturated directional freeway facility with 6 sections and 11 segments
2	Application of demand growth factors resulting in recurring oversaturation
3	Treatment of oversaturation by means of geometric improvements of the facility
4	Effect of temporary capacity reduction due to incident
5	Effect of reduced incident response time on freeway facility operation
6	Effect of ramp metering on freeway facility operation

EXAMPLE PROBLEM 1

The Facility The freeway facility is operating under capacity, and traffic is expected to grow in the near future.

The Question What is the capacity and level-of-service profile for the given directional freeway facility under existing conditions?

The Facts

- √ The facts known about this freeway facility are shown in the exhibits below.
- √ Acceleration and deceleration lanes are 100 m long.
- √ Each time interval is 15 min, and all demands are expressed as hourly flow rates during each time interval.

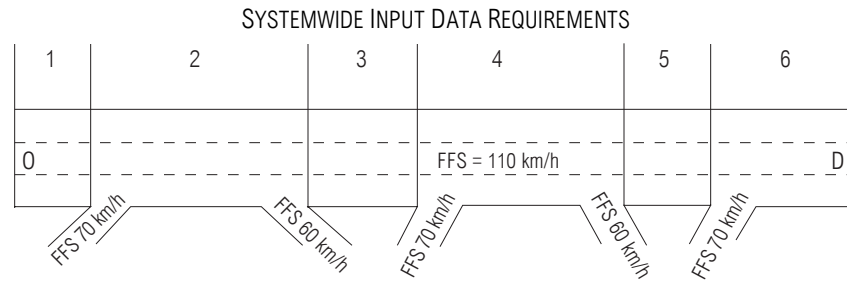

Section Characteristics	Freeway Section					
	1	2	3	4	5	6
Length (m)	300	2200	800	700	350	1150
Number of lanes	3	3	3	3	3	3
Mainline FFS (km/h)	110	110	110	110	110	110
Vehicle occupancy (pass/veh)	1.20	1.20	1.20	1.20	1.20	1.20
Lane width (m)	N/A	N/A	N/A	N/A	N/A	N/A
Lateral clearance (m)	N/A	N/A	N/A	N/A	N/A	N/A
Trucks (%)	3	3	3	3	3	3
RVs (%)	0	0	0	0	0	0
Terrain	Level	Level	Level	Level	Level	Level
Driver population	Commuter	Commuter	Commuter	Commuter	Commuter	Commuter

Note:
 Each ramp has one lane.
 N/A - not available.

INPUT DEMANDS

Time Interval	Entry Mainline (O)	On-Ramp			Off-Ramp		Exit Mainline (D)
		O1	O2	O3	D1	D2	
1	4796	756	1456	648	656	560	6440
2	4772	973	1164	636	588	477	6480
3	4700	1002	1712	596	636	802	6572
4	4164	555	1548	580	520	608	5719
5	3727	485	1180	484	632	448	4796

Outline of Solution The facility is analyzed assuming undersaturated conditions. First, the facility is divided into segments to enable the application of the segment analysis methods in Chapters 23 through 25. The performance results are summarized by each

time interval and across time intervals using appropriate tables and charts. The steps below follow Exhibit 22-11.

Steps

1. Collection of input data: The input data are summarized in the tables. Note the heavy ramp demand volumes for On-Ramp O2, which exceed 1,700 veh/h in Time Interval 3. These demands are still below the ramp roadway capacity, estimated at about 2,000 veh/h for the ramp FFS of 70 km/h. Thus, whereas there may be no capacity problem on the ramp roadway proper, these demands may cause a merge problem on the segment immediately downstream of that ramp.

2. Demand estimation: No adjustments are necessary at this stage since the facility has been observed to operate under capacity.

3. Establishment of spatial and time units: Using the definition of ramp influence area, the original 6 sections are further subdivided into 11 analysis segments. The conversion is shown graphically in the exhibit below. Section 4, with no auxiliary lanes and less than 900 m long, contains an overlap segment (7) that is labeled R. This segment's performance is calculated as the worse of Segments 6 and 8. The time intervals have been set at 15 min. Furthermore, since the shortest segment length is 250 m, a time step of 1 min is sufficient to carry out the oversaturated analysis.

4. Demand adjustments: The values in the Input Demands table are used directly to calculate segment demands by adding or subtracting ramp demands at each section.

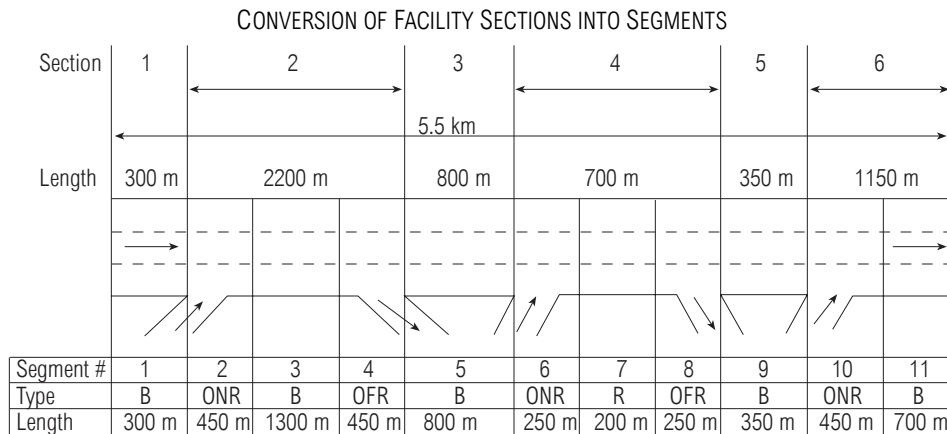

5. HCM segment capacity estimation and adjustment: The facility has five basic freeway segments (numbered 1, 3, 5, 9, and 11), three on-ramp segments (2, 6, and 10), two off-ramp segments (4 and 8), and the overlap segment (7). For each segment type, the appropriate HCM chapter (23 or 25) is consulted and the segment capacity computed. The major difference in this chapter is that all segment capacities are expressed in units of vehicles per hour. No adjustments of the estimated capacities are needed.

6. Adjusted d/c matrix: After capacities are computed, the d/c matrix is generated for each segment and time interval. Both segment capacity and d/c ratios are shown in the exhibit below. As suspected, all segments have d/c ratios less than 1.0, and therefore a complete undersaturated analysis can be carried out. A review of the matrix indicates that Time Intervals 1 through 3 are critical and that Segments 6 through 8, 10, and 11 have d/c ratios above 0.90 during those three intervals. Traffic demands subside considerably in Time Intervals 4 and 5, with a maximum d/c ratio of 0.83 on Segment 8 in Time Interval 4.

ESTIMATED CAPACITY AND d/c RATIO MATRIX

Time Interval	Segment Number and Type										
	1 B	2 ONR	3 B	4 OFR	5 B	6 ONR	7 R	8 OFR	9 B	10 ONR	11 B
1	0.69	0.80	0.80	0.80	0.70	0.91	0.91	0.91	0.83	0.93	0.93
2	0.69	0.83	0.83	0.83	0.74	0.91	0.91	0.91	0.84	0.93	0.93
3	0.68	0.82	0.82	0.82	0.73	0.98	0.98	0.98	0.86	0.95	0.95
4	0.60	0.68	0.68	0.68	0.60	0.83	0.83	0.83	0.74	0.82	0.82
5	0.54	0.61	0.61	0.61	0.52	0.69	0.69	0.69	0.62	0.69	0.69
Capacity	6946	6946	6946	6946	6946	6946	6946	6946	6946	6946	6946

7. Undersaturated segment service measure and MOEs: The methods in Chapters 23 through 25 are applied to estimate individual segment speeds, densities, and travel times. The two exhibits below summarize the results for segment speed, density (the service measure), and LOS for the entire time-space domain.

ESTIMATED SEGMENT SPEEDS (km/h)

Time Interval	Segment Number and Type										
	1 B	2 ONR	3 B	4 OFR	5 B	6 ONR	7 R	8 OFR	9 B	10 ONR	11 B
1	109.6	94.5	106.2	96.5	109.4	86.9	86.9	93.3	104.1	91.1	94.9
2	109.7	93.4	104.5	96.6	108.6	89.2	89.2	94.9	103.5	90.8	94.2
3	109.8	93.4	104.9	96.5	108.9	77.8	77.8	91.3	102.0	90.0	92.4
4	110.0	96.9	109.8	97.1	109.5	90.3	90.3	92.1	106.3	94.4	104.8
5	110.0	98.0	109.9	96.7	109.5	95.8	93.8	93.8	106.7	96.8	109.4

ESTIMATED SEGMENT DENSITIES (veh/km/ln) AND LOS

Time Interval	Segment Number and Type										
	1 B	2 ONR	3 B	4 OFR	5 B	6 ONR	7 R	8 OFR	9 B	10 ONR	11 B
1	14.6	19.2	17.4	19.1	14.9	21.6	22.4	22.4	18.6	22.4	22.6
	C	D	D	D	C	D	E	E	D	E	E
2	14.5	19.8	18.3	19.8	15.8	21.6	22.1	22.1	18.8	22.5	22.9
	C	D	D	D	C	D	E	E	D	E	E
3	14.3	19.6	18.1	19.6	15.5	22.9	24.1	24.1	19.5	22.8	23.7
	C	D	D	D	C	D	E	E	D	E	E
4	12.6	16.5	14.3	16.3	12.8	19.6	20.5	20.5	16.1	19.9	18.2
	C	C	C	C	C	D	D	D	D	D	D
5	11.3	14.8	12.8	16.6	10.9	16.4	16.9	16.9	13.5	16.8	14.6
	C	C	C	C	B	C	C	C	C	C	C

8. Oversaturated segment service measure and MOEs: Does not apply in this case since the facility is fully undersaturated.

9. Directional facility MOE estimation: The individual segment performance measures are aggregated for each time interval. The exhibit below summarizes these results. Note that the average speed is defined as the ratio of vehicle kilometers to vehicle hours of travel in each time interval and therefore does not consider the effect of any on-ramp delays. On the other hand, vehicle hours of delay is the sum of mainline delays and ramp delays. Mainline delays are computed as the difference between total mainline travel time and free-flow travel time.

SUMMARY OF FACILITYWIDE PERFORMANCE MEASURES

Time Interval	Performance Measures					
	Vehicle-km of Travel	Vehicle-h of Travel	Vehicle-h of Delay	Average Speed (km/h)	Average Density (veh/km/ln)	Facility Travel Time (min)
1	7862	79.5	8.0	98.9	18.9	3.31
2	8030	81.4	8.4	98.7	19.4	3.33
3	8100	83.9	10.3	96.5	19.7	3.39
4	6847	67.1	4.8	102.1	16.1	3.22
5	5901	56.9	3.2	103.8	13.8	3.17
Overall	36 740	368.8	34.7	99.6	-	3.30

Results It is evident from the results that the facility provides free-flow conditions. Time Intervals 1 through 3 are fairly similar, with average speeds varying within a 3-km/h range and densities slightly below 20 veh/km/ln. Time Intervals 4 and 5 have higher average speeds exceeding 102 km/h and average densities under 17 veh/km/ln.

EXAMPLE PROBLEM 2

The Facility In this example, the facility described in Example Problem 1 is evaluated under revised traffic demands.

The Question What is the capacity and level-of-service profile for a directional freeway facility using the revised demands?

The Facts

- ✓ The facts shown in Example Problem 1 apply.
- ✓ Demand is adjusted upward by 6 percent uniformly. The new demand rates are shown in the exhibit below.

REVISED INPUT DEMANDS

Time Interval	Entry Mainline (O)	On-Ramp			Off-Ramp		Exit Mainline (D)
		O1	O2	O3	D1	D2	
1	5084	801	1543	689	695	594	6826
2	5058	1031	1234	674	623	506	6869
3	4982	1062	1815	632	674	850	6966
4	4414	588	1641	615	551	644	6062
5	3951	514	1251	513	670	475	5084

Outline of Solution Since the base demands and capacities have not changed, Steps 1 to 3 of Example Problem 1 are skipped. The analysis begins by adjusting demands and then proceeds to determine whether oversaturated conditions will prevail. If they do, a shorter time step will be used to track the position of the queues, the location of the bottlenecks, and their effect on both mainline and ramp flows, speeds, and densities.

Steps

1. Demand adjustments: The input demands shown in the exhibit above represent increases of 6 percent compared with Example Problem 1.
2. HCM capacity estimation and adjustment: Normally, no adjustments of the capacities computed in Example Problem 1 are needed since the facility geometrics are fixed. There is evidence, however, that when queuing occurs on a segment, the discharge flow rate in the queue may be less than the HCM-estimated capacity (by 3 to 5 percent). The HCM capacities assume undersaturated flow conditions. To implement a variable segment capacity under queuing, the analyst must first identify which, if any, segments have a queue and then make a second run with a reduced capacity for those segments using the capacity adjustment factor. For simplicity, in this example the HCM capacity is assumed to apply to queued segments as well.
3. Adjusted d/c matrix: Using the adjusted demands, a revised d/c matrix, shown in the exhibit below, is generated. Cells having d/c > 1.0 are underlined.

ESTIMATED CAPACITY AND d/c RATIO MATRIX

Time Interval	Segment Number and Type										
	1 B	2 ONR	3 B	4 OFR	5 B	6 ONR	7 B	8 OFR	9 B	10 ONR	11 B
1	0.73	0.85	0.85	0.85	0.75	0.97	0.97	0.97	0.88	0.98	0.98
2	0.73	0.88	0.88	0.88	0.79	0.96	0.96	0.96	0.89	0.99	0.99
3	0.72	0.87	0.87	0.87	0.77	<u>1.03</u>	<u>1.03</u>	<u>1.03</u>	0.91	<u>1.003</u>	<u>1.003</u>
4	0.64	0.72	0.72	0.72	0.64	0.88	0.88	0.88	0.78	0.87	0.87
5	0.57	0.64	0.64	0.64	0.55	0.73	0.73	0.73	0.66	0.73	0.73
Capacity	6946	6946	6946	6946	6946	6946	6946	6946	6946	6946	6946

The d/c matrix indicates that fully undersaturated conditions prevail in the first two and the last two time intervals. Two sets of bottlenecks occur in Time Interval 3. The first and more severe bottleneck is on Segments 6 through 8 with a d/c of 1.03. The second and less severe bottleneck is on Segments 10 and 11 with a d/c of 1.003. It is likely that the second bottleneck will be hidden as a result of the metering effect of the first one. Whether the two queues from the bottlenecks will overlap, thus violating an important constraint of the methodology, remains to be seen.

4. Undersaturated segment service measure and MOEs: The first two time intervals are undersaturated, and therefore all MOEs are derived directly from the procedures in Chapters 23, 24, and 25.

5. Oversaturated segment service measure and MOEs: Starting with Time Interval 3, the analysis is performed in 1-min increments, and a set of nodes is defined at each ramp terminal. First, flow rates are determined in each time step. Starting from the furthest upstream segment in Time Interval 3, flows across nodes are calculated until the bottleneck Segment 6 is reached. On Segment 6, flow is equated to capacity, and the residual demand is applied at that bottleneck in Time Interval 4. Upstream of Segment 6, the queue density is calculated, and queue length is tracked on Segments 5, 4, and so forth. Downstream of Segment 6, flows are metered at the segment capacity rate. The same process is applied to the bottlenecks on Segments 10 and 11. Since the demands in Time Intervals 4 and 5 drop significantly, queues will begin to clear and dissipate by the end of the analysis period. The exhibit below shows the actual volume-to-capacity ratios estimated on each segment and time interval. Note that volumes are averaged over the 15 time steps per interval and reflect the output flow for a segment. By definition no v/c ratio can exceed 1.00.

As anticipated, the bottleneck Segments 6 through 8 are operating at capacity in Time Interval 3. The metering effect of this bottleneck hides the second bottleneck on Segments 10 and 11, which have a v/c < 1.0 in Time Interval 3. A comparison of the d/c and v/c matrices indicates that flows exceed demands in Time Interval 4, which indicates that the unserved demand in Time Interval 3 is now being served in Time Interval 4. There are no differences in demand and flows in the last time interval, suggesting that the facility performance has fully recovered by the end of the analysis period.

ESTIMATED CAPACITY AND v/c RATIO MATRIX

Time Interval	Segment Number and Type										
	1 B	2 ONR	3 B	4 OFR	5 B	6 ONR	7 B	8 OFR	9 B	10 ONR	11 B
1	0.73	0.85	0.85	0.85	0.75	0.97	0.97	0.97	0.88	0.98	0.98
2	0.73	0.88	0.88	0.88	0.79	0.96	0.96	0.96	0.89	0.99	0.99
3	0.72	0.87	0.87	0.87	0.77	1.00	1.00	1.00	0.88	0.97	0.97
4	0.64	0.72	0.72	0.72	0.64	0.91	0.91	0.91	0.81	0.90	0.90
5	0.57	0.64	0.64	0.64	0.55	0.73	0.73	0.73	0.66	0.73	0.73
Capacity	6946	6946	6946	6946	6946	6946	6946	6946	6946	6946	6946

The next performance measure investigated is the queue lengths observed on the mainline segments and on the ramps. These values represent instantaneous observations at the end of each time interval. The results are shown in the exhibit below, by segment and time interval. Blank entries indicate no queuing. The v/c matrix above indicates that a queue develops on the on-ramp roadway on Segment 6 in Time Interval 3. This queue is caused by the heavy on-ramp demand of 1,815 veh/h in that time interval. Since the mainline entering demand is under 1,800 veh/h/ln, no queuing occurs on the freeway mainline. The actual on-ramp flow is estimated at 1,576 veh/h, and the difference (1,815 – 1,576) causes a queue to develop and reach a length of 1189 m at the end of Interval 3. That queue is fully dissipated by the end of Time Interval 4. While there are no

queues in Time Interval 5, the excess flows withheld in the previous intervals are served fully, and all vehicles are discharged at the end of the analysis period.

ESTIMATED QUEUE LENGTH (m) ON MAINLINE AND RAMPS (R) AT END OF EACH TIME INTERVAL

Time Interval	Segment Number and Type										
	1 B	2 ONR	3 B	4 OFR	5 B	6 ONR	7 R	8 OFR	9 B	10 ONR	11 B
1											
2											
3						1189 (R)					
4											
5											

To complete the oversaturated segment analysis, a summary of the resulting segment speeds, segment densities, and segment LOS for each time interval is given in the two exhibits below.

ESTIMATED SEGMENT SPEEDS (km/h)

Time Interval	Segment Number and Type										
	1 B	2 ONR	3 B	4 OFR	5 B	6 ONR	7 R	8 OFR	9 B	10 ONR	11 B
1	108.9	93.2	103.1	96.2	108.4	82.5	82.5	93.0	99.8	87.5	86.9
2	109.0	91.7	100.5	96.3	106.8	85.8	85.8	94.6	99.0	87.0	85.8
3	109.2	91.8	101.8	96.2	107.5	75.7	75.7	92.0	100.0	88.3	88.5
4	110.0	96.3	109.1	97.0	109.5	83.8	83.8	90.6	105.3	92.2	97.8
5	110.0	97.5	109.9	96.6	109.5	94.8	93.6	93.6	106.7	96.7	108.9

ESTIMATED SEGMENT DENSITIES (veh/km/ln) AND LOS

Time Interval	Segment Number and Type										
	1 B	2 ONR	3 B	4 OFR	5 B	6 ONR	7 R	8 OFR	9 B	10 ONR	11 B
1	15.6	20.3	19.0	20.3	16.0	22.9	23.8	23.8	20.5	23.6	26.2
	C	D	D	D	D	E	E	E	D	E	E
2	15.5	21.0	20.2	21.0	17.1	22.9	23.4	23.4	20.9	23.8	26.7
	C	D	D	D	D	E	E	E	D	E	E
3	15.2	20.8	19.9	20.8	16.7	23.5	24.5	24.5	20.4	23.4	25.4
	C	D	D	D	D	E	E	E	D	E	E
4	13.4	17.4	15.3	17.2	13.5	21.4	22.8	22.8	17.9	21.9	21.4
	C	D	C	D	C	D	E	E	D	D	D
5	12.0	15.6	13.5	15.4	11.6	17.3	17.9	17.9	14.3	17.7	15.6
	C	C	C	C	C	D	D	D	C	D	C

6. Directional facility MOE estimation: The individual segment performance measures are aggregated for each time interval. An important addition in this example is the inclusion of two VkmT measures, the first based on demands, VkmT(D), and the second based on actual flow rates, VkmT(F). These values are used to detect whether vehicle storage [when VkmT(D) > VkmT(F)] or queue release [VkmT(D) < VkmT(F)] is occurring in each interval. Appendix A provides details of the computations needed to obtain the facilitywide measures. The exhibit below summarizes the facilitywide results by time interval.

SUMMARY OF FACILITYWIDE PERFORMANCE MEASURES

Time Interval	Performance Measures						
	Vehicle-km of Travel (Demand)	Vehicle-km of Travel (Flow Rate)	Vehicle-h of Travel	Vehicle-h of Delay	Average Speed (km/h)	Average Density (veh/km/ln)	Facility Travel Time (min)
1	8334	8334	87.2	11.5	95.5	20.5	3.43
2	8511	8511	89.6	12.2	95.0	21.5	3.45
3	8586	8466	89.7	20.2	94.4	20.9	3.47
4	7258	7379	74.1	10.9	99.5	17.6	3.28
5	6255	6255	60.4	3.6	103.5	14.7	3.18
Overall	38 944	38 945	401.0	58.4	97.1	-	3.4

Result It is instructive to compare the above results with those obtained in Example Problem 1. Whereas the total VkmT between the two problems increased only by 6 percent, the total vehicle hours of travel on the mainline increased by 8.9 percent. The total vehicle delay on the system, which includes estimated delay on the on-ramps, went up by 68 percent. If one compares the performance in the third time interval, the difference is even greater, with delays increasing by more than 96 percent. On average, the system density appears to have increased by 10 percent. Interestingly, the average speeds do not vary substantially. This may be due to boundary segments, which contribute significantly to the overall speed value by virtue of their length but typically experience little congestion.

EXAMPLE PROBLEM 3

The Facility In this example, the facility analyzed in Example Problem 2 is evaluated with revised geometry.

The Question What is the capacity and level-of-service profile for the directional freeway facility using the revised geometry?

The Facts

- √ The facts from Example Problem 2 apply.
- √ Recurring congestion is observed during the first hour downstream of on-ramp Segment 6 to the end of the study section. An auxiliary lane on the freeway mainline between Segments 6 and 8 over a distance of 700 m is proposed.

Outline of Solution The capacity of the upgraded segment (which is now a Type A weave) is first estimated. Its effects on the segment and facility performance measures are shown. For ease of reference, this segment is labeled “678.” The total number of segments on the facility is reduced from 11 to 9.

Steps

1. The analysis of Weaving Segment 678 requires knowledge of weaving and nonweaving demand volume. In this example, weaving demands of 1,868, 1,340, 2,065, 1,925, and 1,326 veh/h are assumed to occur in Time Intervals 1 through 5, respectively.
2. HCM capacity estimation and adjustments: The number of lanes on Segments 6 through 11 is now adjusted to four. No changes in segment types or other geometric data are made.
3. Adjusted d/c matrix: The application of the methodology yields the revised d/c matrix and segment capacities indicated in the exhibit below. The auxiliary lane addition to Segment 678 was sufficient to restore undersaturated conditions on that segment. However, the second bottleneck on Segments 10 and 11 still exists. This implies that the improved facility can, for the most part, absorb the additional growth rate in traffic demands and still operate at an acceptable level.

ESTIMATED CAPACITY (veh/h) AND d/c RATIO MATRIX

Time Interval	Segment Number and Type								
	1 B	2 ONR	3 B	4 OFR	5 B	678 W	9 B	10 ONR	11 B
1	0.73	0.85	0.85	0.85	0.75	0.80 (8410)	0.88	0.98	0.98
2	0.73	0.88	0.88	0.88	0.79	0.75 (8946)	0.89	0.99	0.99
3	0.72	0.87	0.87	0.87	0.77	0.87 (8272)	0.91	1.003	1.003
4	0.64	0.72	0.72	0.72	0.64	0.76 (8055)	0.78	0.87	0.87
5	0.57	0.64	0.64	0.64	0.55	0.60 (8469)	0.66	0.73	0.73
Capacity	6946	6946	6946	6946	6946	(capacity)	6946	6946	6946

4. Undersaturated segment service measure and MOEs: The segment speeds, densities, and level of service for the upgraded facility are summarized in the exhibits below. In Time Interval 3, the oversaturated analysis is initiated.

5. Oversaturated segment service measures and MOEs: The now-active bottleneck on Segments 10 and 11 yields a queue 122 m long on Segment 9 in Time Interval 3. The

queue is dissipated at the start of Time Interval 4. More important, however, is that the geometric improvement on Segment 678 has eliminated the 1189-m queue that was observed on the ramp roadway in the preceding example.

6. Directional facility MOE estimation: The individual segment performance measures are aggregated for each time interval. The results are shown in the three exhibits below.

Results The upgraded facility performance is compared with that given in Example Problem 2. The mainline travel time has increased slightly (by 0.6 percent) because of the now-active bottleneck on Segments 10 and 11 in Time Interval 3. However, the overall system delay, including on-ramp delays, dropped by 15 percent. There were minor changes in overall facility speeds, densities, and travel times.

ESTIMATED SEGMENT SPEEDS (km/h)

Time Interval	Segment Number and Type								
	1 B	2 ONR	3 B	4 OFR	5 B	678 W	9 B	10 ONR	11 B
1	108.9	93.2	103.1	96.2	108.4	84.0	99.8	87.3	86.9
2	109.0	91.7	100.5	96.3	106.8	91.2	99.0	86.8	85.8
3	109.2	91.8	101.1	96.2	107.5	80.9	86.2	85.9	83.9
4	110.0	96.3	109.1	97.0	109.5	82.0	107.4	92.7	100.6
5	110.0	97.5	109.9	96.6	109.5	90.6	108.8	96.0	108.9

ESTIMATED SEGMENT DENSITIES (veh/km/ln) AND LOS

Time Interval	Segment Number and Type								
	1 B	2 ONR	3 B	4 OFR	5 B	678 W	9 B	10 ONR	11 B
1	15.6 C	20.3 D	19.0 D	20.3 D	16.0 C	20.0 D	20.5 D	23.6 E	26.2 E
2	15.5 C	21.0 D	20.2 D	21.0 D	17.1 D	18.4 D	20.9 D	23.8 E	26.7 E
3	15.2 C	20.8 D	19.9 D	20.8 D	16.7 D	22.2 E	24.4 E	24.0 E	27.6 E
4	13.4 C	17.4 D	15.3 C	17.2 D	13.5 C	18.6 D	17.0 D	21.1 D	20.2 D
5	12.0 C	15.6 C	13.5 C	15.4 C	11.6 C	13.9 C	14.0 C	17.7 D	15.6 C

SUMMARY OF FACILITYWIDE PERFORMANCE MEASURES

Time Interval	Performance Measures						
	Vehicle-km of Travel (Demand)	Vehicle-km of Travel (Flow Rate)	Vehicle-h of Travel	Vehicle-h of Delay	Average Speed (km/h)	Average Density (veh/km/ln)	Facility Travel Time (min)
1	8334	8334	87.6	11.8	95.2	20.1	3.44
2	8511	8511	89.2	11.9	95.4	20.4	3.44
3	8586	8579	92.4	14.9	92.4	21.3	3.54
4	7258	7266	73.1	7.1	99.4	17.0	3.29
5	6255	6255	60.7	3.9	103.0	14.2	3.19
Overall	38 944	38 945	403.0	49.6	96.5	-	3.38

EXAMPLE PROBLEM 4

The Facility In this example, the facility analyzed in Example Problem 1 is evaluated with reduction of capacity on Segment 9 in the first four time intervals due to an accident on the shoulder (nonrecurring congestion).

The Question What is the capacity and level-of-service profile for a directional freeway facility with nonrecurring congestion on Segment 9?

The Facts

√ The facts shown in Example Problem 1 apply.

Outline of Solution The segment capacity adjustment factor is used. This factor reduces the subject segment capacity for a limited number of time intervals. A revised speed-flow curve is also used in this case. Because of space limitations, the results that follow are confined to the effect of the incident on segment and facility performance. The results are compared with those obtained in Example Problem 1.

Steps

1. Adjustment of HCM capacities: in this example, the previously computed capacity for Segment 9 (6,946 veh/h) is multiplied by the capacity adjustment factor for shoulder accidents. This value is taken from Exhibit 22-6 and is estimated at 0.83. It yields a revised segment capacity of 5,765 veh/h. The revised capacity is applied in Time Intervals 1 through 4 only.

2. Adjusted d/c matrix: The matrix is shown in the exhibit below. As suspected, a single bottleneck on Segment 9 appears and is active during the first three time intervals. As stated in Example Problem 2, the incident causes oversaturation in the first time interval, and therefore it may be desirable for the user to begin the analysis one time interval earlier. However, because the level of oversaturation is very light (Segment 9 d/c is 1.005), the methodology will still produce correct estimates of performance in this case. Note that demand drops significantly in Time Interval 4 and demand flows can still pass through the reduced segment capacity.

ESTIMATED CAPACITY (veh/h) AND d/c RATIO MATRIX

Time Interval	Segment Number and Type										
	1 B	2 ONR	3 B	4 OFR	5 B	6 ONR	7 R	8 OFR	9 B	10 ONR	11 B
1	0.69	0.80	0.80	0.80	0.70	0.91	0.91	0.91	1.005	0.93	0.93
2	0.69	0.83	0.83	0.83	0.74	0.91	0.91	0.91	1.01	0.93	0.93
3	0.68	0.82	0.82	0.82	0.73	0.98	0.98	0.98	1.04	0.95	0.95
4	0.60	0.68	0.68	0.68	0.60	0.83	0.83	0.83	0.89	0.82	0.82
5	0.54	0.61	0.61	0.61	0.52	0.69	0.69	0.69	0.62	0.69	0.69
Capacity	6946	6946	6946	6946	6946	6946	6946	6946	5765 ^a 6946	6946	6946

Note:

a. Applies to Time Intervals 1 through 4 only.

3. Oversaturated segment service measures and LOS: The results of the oversaturated analysis are shown in the exhibit below for queue length position at the end of each interval.

ESTIMATED QUEUE LENGTH (m) AT END OF EACH TIME INTERVAL

Time Interval	Segment Number and Type										
	1 B	2 ONR	3 B	4 OFR	5 B	6 ONR	7 R	8 OFR	9 B	10 ONR	11 B
1								181			
2						55 100 (R) 204	200	250			
3						1430 (R) 430 (R)	200	250			
4											
5											

The exhibits below illustrate segment speeds, densities, and levels of service.

ESTIMATED SEGMENT SPEEDS (km/h)

Time Interval	Segment Number and Type										
	1 B	2 ONR	3 B	4 OFR	5 B	6 ONR	7 R	8 OFR	9 B	10 ONR	11 B
1	109.6	94.5	106.2	96.5	109.4	86.9	75.2	75.2	69.7	91.3	95.4
2	109.7	93.4	104.5	96.6	108.6	88.9	65.5	56.9	69.7	91.4	95.6
3	109.8	93.4	104.9	96.5	107.8	79.2	74.6	65.8	70.4	91.8	96.8
4	110.0	96.9	109.8	97.1	109.5	102.4	104.7	101.5	78.3	93.5	101.7
5	110.0	98.0	109.9	96.7	109.5	95.5	93.5	93.5	106.6	96.7	109.4

ESTIMATED SEGMENT DENSITIES (veh/km/ln) AND LOS

Time Interval	Segment Number and Type										
	1 B	2 ONR	3 B	4 OFR	5 B	6 ONR	7 R	8 OFR	9 B	10 ONR	11 B
1	14.6	19.2	17.4	19.1	14.9	21.6	28.0	28.0	27.6	22.3	22.4
	C	D	D	D	C	D	F	F	E	E	E
2	14.5	19.8	18.3	19.8	15.8	23.6	31.8	36.6	27.6	22.3	22.3
	C	D	D	D	C	F	F	F	E	E	E
3	14.3	19.6	18.1	19.6	15.7	27.2	29.0	32.9	27.2	22.1	21.8
	C	D	D	D	C	F	F	F	E	E	D
4	12.6	16.5	14.3	16.3	12.8	19.6	19.2	19.9	23.1	20.9	19.7
	C	C	C	C	C	D	D	D	E	E	D
5	11.3	14.8	12.8	14.6	10.9	16.6	17.2	17.2	13.7	17.0	14.8
	C	C	C	C	B	C	D	D	C	D	C

The above results indicate that the incident causes queues to develop on both the freeway mainline and the on-ramp at Segment 6 in Time Intervals 1 through 3. Since traffic demand drops sharply in Interval 4, the mainline queues dissipate by the end of that interval. A residual queue 430 m long remains on the on-ramp roadway proper at the end of Time Interval 4. Poor level of service is observed in Segments 6 through 8 upstream of the bottleneck during the first three time intervals. However, all queues are cleared and undersaturated operations are restored during Time Interval 5.

4. Directional facility MOE estimation: The individual segment performance measures are aggregated for each time interval. Both VkmT measures based on demands [VkmT(Demand)] and the actual flow rates [VkmT(Flow Rate)] are computed. The following exhibit summarizes the facilitywide results by time interval.

SUMMARY OF FACILITYWIDE PERFORMANCE MEASURES

Time Interval	Performance Measures						
	Vehicle-km of Travel (Demand)	Vehicle-km of Travel (Flow Rate)	Vehicle-h of Travel	Vehicle-h of Delay	Average Speed (km/h)	Average Density (veh/km/ln)	Facility Travel Time (min)
1	7862	7851	83.3	11.9	94.3	19.9	3.47
2	8030	7989	87.1	15.4	91.7	21.0	3.57
3	8100	7960	85.8	24.5	92.8	20.7	3.53
4	6847	7005	69.3	18.1	101.0	16.8	3.25
5	5901	5937	57.3	3.45	103.7	13.9	3.17
Overall	36 740	36 742	382.8	73.35	96.0	-	3.40

Results It is instructive to compare the results of this example problem with those obtained in Example Problem 1. While serving the same VkmT, the total vehicle hours of travel on the mainline due to the incident increases by 3.8 percent. The total vehicle delay on the system, which includes estimated delay on the on-ramps, increases by 111 percent. In the fourth time interval, the differences are even greater, with delays increasing by 320 percent. On average, the system density under incident conditions appears to have increased by 10 percent, and the average speed has dropped by about 3.6 percent.

EXAMPLE PROBLEM 5

The Facility In this example problem, the facility analyzed in Example Problem 4 is evaluated with incident management to mitigate the effect of the incident.

The Question For normal conditions, a 60-min incident, and a 30-min incident, compare quality-of-service and performance measures.

The Facts

√ The facts of Example Problem 1 apply, except that the incident effect on the capacity of Segment 9 is limited to the first two time intervals.

Steps

1. A summary of the results is given in the exhibit below.

EFFECT OF REDUCED INCIDENT DURATION ON SELECTED FACILITY PERFORMANCE MEASURES

Facility Performance Measure	Normal Conditions Example 1	60-min Incident Example 4	30-min Incident Example 5
Vehicle-km mainline travel	36 741	36 741	36 741
Vehicle-h mainline travel	368.7	382.7	378.2
Vehicle-h mainline delay (h)	34.7	48.7	44.2
Vehicle-h on-ramp delay (h)	0.0	24.5	8.7
Vehicle-h total delay (h)	34.7	73.2	52.9
Overall maximum d/c ratio (segment)	0.98 (6, 7, 8)	1.04 (9)	1.01 (9)
Average mainline facility speed (km/h)	99.6	96.0	97.1
Average mainline travel time (min)	3.30	3.40	3.40
Maximum mainline queue ^a (m)	0	654	505
Time interval with max. mainline queue	N/A	3	2
Maximum ramp queue (m)	0	1430	842
Time interval with max. ramp queue	N/A	3	3

Note:

a. Measured from the downstream end of Segment 8, just upstream of Segment 9.

N/A - not applicable.

Results As expected, the reduced incident duration improves both mainline and ramp traffic performance. Overall, mainline delays drop by a modest 9.2 percent, while ramp delays are reduced by 65 percent. Similarly, the maximum queue length on the mainline drops by 23 percent compared with a 41 percent drop in ramp queues. The maximum on-ramp demand occurs at the start of Interval 3, by which time the incident has been cleared under the 30-min incident scenario.

EXAMPLE PROBLEM 6

The Facility In this example problem the facility analyzed in Example Problem 5 is evaluated with ramp metering for the on-ramp flow on Segment 6.

The Question What are the performance measures of normal, 60-min incident, and ramp-metering conditions?

The Facts

- √ The facts shown in Example Problem 4 apply.
- √ Metering rates of 900 veh/h and 1,200 veh/h are selected.

Outline of Solution This strategy is intended to minimize the queues on the freeway at the expense of ramp queues and delays. The effect on the adjacent surface operation is not considered in this analysis, and therefore the results should be viewed with caution. The metering rate selected was 900 veh/h, which is the maximum rate recommended for single-lane on-ramps (15). Ramp metering is applied only to the first three time intervals, since the on-ramp demand drops significantly in Time Interval 4. A second metering strategy is also evaluated. This strategy uses a two-lane ramp-metering rate of 1,200 veh/h, in which vehicle departures alternate at the higher rate. As in Example Problem 5, only facilitywide measures are reported.

Steps

1. A summary of the facility performance measures is given in the exhibit below. As expected, the single-lane ramp metering causes severe congestion and queuing on the on-ramp at Segment 6 while eliminating the mainline queue. In fact, the on-ramp queues on Segment 6 are not cleared by the end of the analysis period, resulting in fewer vehicle kilometers of travel production. However, it is virtually impossible that the observed maximum ramp queue of 9788 m could ever materialize in the field without spilling back onto the surface street system or causing ramp drivers at Segment 6 to divert elsewhere.

EFFECT OF RAMP-METERING STRATEGIES ON SELECTED FACILITY PERFORMANCE MEASURES

Facility Performance Measure	Normal Conditions Example 1	60-min Incident Example 4 No Metering	Metering Rate 900 veh/h Single Lane	Metering Rate 1200 veh/h Two Lanes
Vehicle-km mainline travel	36 741	36 741	36 658	36 741
Vehicle-h mainline travel	368.7	382.7	370.9	380.1
Vehicle-h mainline delay (h)	34.7	48.7	37.7	46.0
Vehicle-h on-ramp delay (h)	0.0	24.5	260.5	94.9
Vehicle-h total delay (h)	34.7	73.2	298.2	140.9
Overall maximum d/c ratio (segment)	0.98 (6, 7, 8)	1.04 (9)	1.04 (9)	1.04 (9)
Average mainline facility speed (km/h)	99.6	96.0	98.8	96.7
Average mainline travel time (min)	3.30	3.40	3.30	3.40
Maximum mainline queue ^a (m)	0	654	0	338
Time interval with max. mainline queue	N/A	3	N/A	2
Maximum ramp queue (m)	0	1430	9788	3011
Time interval with max. ramp queue	N/A	3	4	2

Note:
 a. Measured from the downstream end of Segment 8.
 N/A - not applicable.

With two-lane metering, the on-ramp queue is reduced to 3011 m, which is still quite high. Furthermore, there is now queuing on the mainline. Thus, it appears that the two ramp-metering strategies presented in this example are not as effective in improving

system performance as the reduction in incident response time performed in Example Problem 5.

The user may test additional strategies that can be handled by the methodology. They include, for example, a combination of reduced incident response and ramp metering and systemwide ramp metering in which metering rates on Segments 3 and 6 are jointly determined. Diversion strategies in which the excess demand on Segment 6 is rerouted to the surface street system and back onto the freeway downstream of the incident location can also be evaluated.

Results An overall comparison of the freeway facility performance measures is shown in the exhibit below. Scenarios 1 through 5 represent the conditions described in Examples Problems 1 through 5, respectively. Scenarios 6 and 7 represent the effects of the two ramp-metering strategies described in Example Problem 6.

The purpose of this chart is to demonstrate the sensitivity of various facility performance measures to key geometric and traffic management improvement strategies. The results suggest that mainline speed, total vehicle kilometers of travel, and total vehicle hours of travel are not very sensitive to the various strategies. On the other hand, total system delay (VHD) appears to vary considerably across scenarios. VHD is defined as the difference between the actual mainline travel time and travel time at the free-flow speed + the sum of all ramp delays. Since this is the only performance measure that incorporates ramp delays in its calculations, it should be considered a key measure in evaluating the operational performance of freeway facilities.

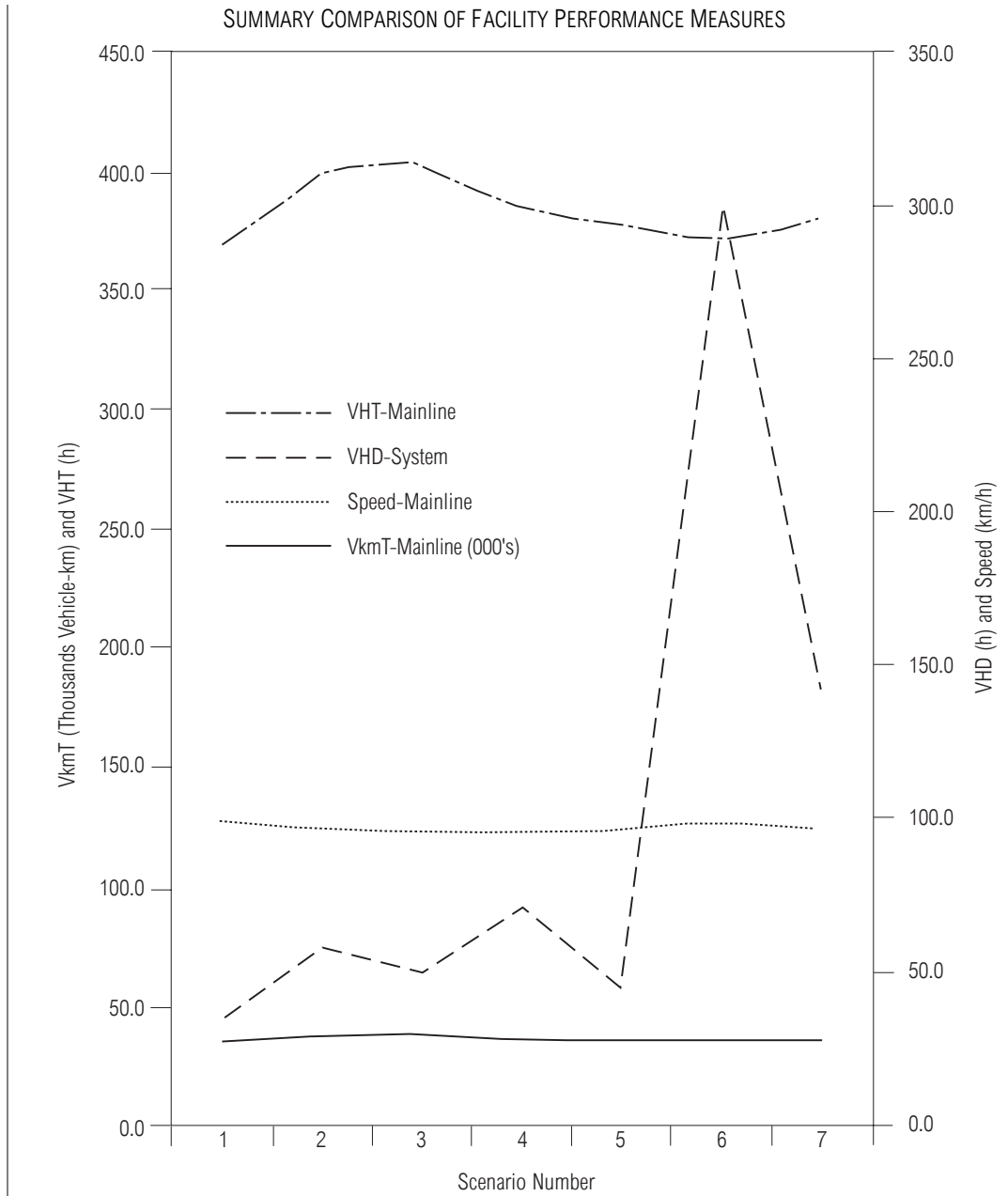

- Notes:
- Scenario 1: base scenario - Example 1
 - Scenario 2: base + 6% demand growth
 - Scenario 3: Scenario 2 + auxiliary lane on Section 4
 - Scenario 4: base + 60-min incident on Section 5
 - Scenario 5: base + 30-min incident on Section 5
 - Scenario 6: base + 60-min incident + 900 veh/h single-lane meter - second on-ramp
 - Scenario 7: base + 60-min incident + 1,200 veh/h two-lane meter - second on-ramp

V. REFERENCES

1. May, A. D., et al. *Capacity and Level of Service Analysis for Freeway Facilities, Fourth Interim Report*. SAIC Corp., March 1999.
2. *Manual on Uniform Traffic Control Devices*. Federal Highway Administration, U.S. Department of Transportation, 1986.
3. Krammes, R. A., and G. O. Lopez. Updated Capacity Values for Short-Term Freeway Work Zone Lane Closures. In *Transportation Research Record 1442*, TRB, National Research Council, Washington D.C., 1994, pp. 49–56.
4. Dudek, C. L. *Notes on Work Zone Capacity and Level of Service*. Texas Transportation Institute, Texas A&M University, College Station, Tex., 1984.
5. Dudek, C. L., S. H. Richards, and J. L. Buffington. *Improvements and New Concepts for Traffic Control in Work Zones, Volume 1: Four-Lane Divided Highways*. Report FHWA-RD-85-034. Federal Highway Administration, U.S. Department of Transportation, 1985.
6. Burns, E. N., C. L. Dudek, and O. J. Pendleton. *Construction Costs and Safety Impacts of Work Zone Traffic Control Strategies, Volume 1: Final Report*. Report FHWA-RD-89-209. Federal Highway Administration, U.S. Department of Transportation, 1989.
7. Ressel, W. Traffic Flow and Capacity at Work Sites on Freeways. *Highway Capacity and Level of Service: Proc., International Symposium on Highway Capacity*, Karlsruhe, Germany. Balkema, Rotterdam, Netherlands, 1991, pp. 321–328.
8. Lamm, R., E. M. Choueiri, and T. Mailaender. Comparison of Operating Speeds on Dry and Wet Pavements of Two-Lane Rural Highways. In *Transportation Research Record 1280*, TRB, National Research Council, Washington D.C., 1990, pp. 199–207.
9. Ibrahim, A. T., and F. L. Hall. Effect of Adverse Weather Conditions on Speed-Flow-Occupancy Relationships. In *Transportation Research Record 1457*, TRB, National Research Council, Washington D.C., 1994, pp. 184–191.
10. Hogema, J. H., A. R. A. Vanderhorst, and P. J. Bakker. *Evaluation of the 16 Fog-Signaling System with Respect to Driving Behaviour (Evaluatie Van Het a 16 Mistsignaleringsysteem in Termen Van Het Rijgedrag)*. Report TNO-TM 1994 C-48. TNO Technische Menskunde, Soesterberg, Netherlands, 1994.
11. Aron, M., M. Ellenberg, P. Fabre, and P. Veyre. Weather Related Traffic Management. In *Towards an Intelligent Transport System: Proc., First World Congress on Applications of Transport Telematics and Intelligent Vehicle-Highway Systems*, Paris, Vol. 3, Ertico, Brussels, Belgium, 1994, pp. 1089–1096.
12. Brilon, W., and M. Ponzlet. *Auswirkungen on Zeitlich Veraenderlichen Leistungsfahigkeiten, Schlussbericht*. Lehrstuhl fur Verkeshrswesen, Ruhr Universitat Bochum, Germany, 1995.
13. Giuliano, G. Incident Characteristics, Frequency, and Duration on a High Volume Urban Freeway. *Transportation Research*, Vol. 23A, No. 5, 1989, pp. 387–396.
14. Reiss, R. A., and W. M. Dunn, Jr. *Freeway Incident Management Handbook*. Report FHWA-SA-91-056. Federal Highway Administration, U.S. Department of Transportation, 1991.
15. Gordon, R. L., R. A. Reiss, H. Haenel, E. R. Case, R. L. French, A. Mohaddes, and R. Wolcott. *Traffic Control Systems Handbook*. Report FHWA-SA-95-032. Federal Highway Administration, U.S. Department of Transportation, 1996.

APPENDIX A. DETAILED COMPUTATIONAL MODULES FOR FREEWAY FACILITIES

A.1 SCOPE OF APPENDIX MATERIAL

The freeway facility analytical methodology is described in the main body of this chapter. The computations contained within the methodology are detailed in this appendix. In Section II of the main body, the characteristics of freeway flow that are computed in the methodology are discussed. The computational steps are given in Section III. In Section A.1 of this appendix, the limitations of the methodology are outlined, and a glossary of all relevant variables is presented. The overall procedure presented in Section III of the main body is described in more detail in Section A.2. The computations for the undersaturated portion of the methodology are detailed in Section A.3. The oversaturated computations of the methodology are detailed in Section A.4. Section A.5 contains the directional facility computations.

A.1.1 Limitations

The procedure described herein becomes extremely complex when the queue from a downstream bottleneck extends into an upstream bottleneck causing a queue collision. When such cases arise, the reliability of the methodology is questionable, and the user is cautioned about the validity of the results. However, noninteracting bottlenecks are accommodated by the methodology.

The completeness of the analysis will be limited if freeway segment cells in the first time interval, the last time interval, and the first freeway segment do not all have demand-to-capacity ratios less than 1.00. The methodology can handle congestion in the first interval properly, although it will not quantify any congestion that could have occurred before the analysis. To ensure complete quantification of the effects of congestion, it is recommended that the analysis contain an initial undersaturated time interval. If all freeway segments in the last time interval do not exhibit demand-to-capacity ratios less than 1.00, congestion continues beyond the last time interval, and additional time intervals should be added. This fact will be noted as a difference between the vehicle kilometers of travel demand desired at the end of the analysis and the corresponding vehicle kilometers of travel flow generated. If queues extend upstream of the first segment, the analysis will not account for the congestion outside the freeway facility but will store the vehicles vertically until the congestion clears the first segment. The same process is followed for queues on on-ramp roadways.

The analyst could, given enough time, analyze a completely undersaturated time-space domain manually, although this is highly unlikely. It is not expected that an analyst will ever manually analyze a time-space domain that includes oversaturation. For heavily congested directional freeway facilities with interacting bottleneck queues, a simulation model might be more applicable.

A.1.2 Glossary

In this glossary internal variables used exclusively in the freeway facilities methodology are defined. The glossary of variables covers six parts: global variables, segment variables, node variables, on-ramp variables, off-ramp variables, and facilitywide variables. Segment variables represent conditions on segments. Node variables denote flows across a node connecting two segments. Facilitywide variables pertain to aggregate traffic performance over the entire facility. On-ramp and off-ramp variables are variables that correspond to flow on ramps. In addition to these spatial categories, there are temporal divisions that represent characteristics over either a time step or a time interval. The first dimension associated with each variable specifies whether the variable refers to segment or node characteristics. The labeling scheme for nodes and segments is such that Segment (i) is immediately downstream of Node (i).

Thus, there is always one more node than the number of segments on a facility. The second and third dimensions denote a time step (t) and a time interval (p). Facility variables are estimates of the average performance over the entire length of the facility. The units of flow are in vehicles per time step. The selection of the time step size is discussed later in this appendix.

Global Variables

- **KC**—Density at capacity: the ideal density at capacity (veh/km/ln). The density at capacity is 28 pc/km/ln, which must be converted to veh/km/ln using the heavy-vehicle factor (f_{HV}) described in Chapter 23.
- **KJ**—Jam density: the facilitywide jam density (veh/km/ln).
- **NS**—Number of segments: the number of segments on the facility.
- **i**—Index to segment or node number: $i = 1, 2, \dots, NS$ (for segments) and $i = 1, 2, \dots, NS + 1$ (for nodes).
- **P**—Number of time intervals: number of time intervals in the analysis period.
- **p**—Time interval number: $p = 1, 2, \dots, P$.
- **S**—Time steps per interval: number of time steps in a time interval (integer).
- **t**—Number of time steps in a single interval: $t = 1, 2, \dots, S$.
- **T**—Time steps per hour: number of time steps in 1 h (integer).

Segment Variables

- **ED(i, p)**—Expected demand: the demand that would arrive at Segment (i) on the basis of upstream conditions over Time Interval (p). The upstream queuing effects include the metering of traffic from an upstream queue, but not the spillback of vehicles from a downstream queue.
- **K(i, p)**—Average segment density: the average traffic density of Segment (i) over Time Interval (p), as estimated by the oversaturated procedure.
- **KB(i, p)**—Background density: Segment (i) density (veh/km/ln) over Time Interval (p) assuming there is no queuing on the segment. This density is calculated using the expected demand on the segment in the corresponding undersaturated procedure in Chapters 23 through 25.
- **KQ(i, t, p)**—Queue density: vehicle density in the queue on Segment (i) during Time Step (t) in Time Interval (p). The queue density is calculated on the basis of a linear density-flow relationship in the congested regime (see Exhibit A22-5).
- **L(i)**—Length: the length of Segment (i) (km).
- **N(i, p)**—Number of lanes: the number of lanes on Segment (i) in Time Interval (p). Could vary by time interval if a temporary lane closure is in effect.
- **NV(i, t, p)**—Number of vehicles: the number of vehicles present on Segment (i) at the end of Time Step (t) during Time Interval (p). The number of vehicles is initially based on the calculations of Chapters 23 through 25, but as queues grow and dissipate, input-output analysis updates these values in each time step.
- **Q(i, t, p)**—Queue length: total queue length on Segment (i) at the end of Time Step (t) in Time Interval (p) (m).
- **SC(i, p)**—Segment capacity: maximum number of vehicles that can pass through Segment (i) in Time Interval (p) based strictly on traffic and geometric properties. These capacities are calculated using Chapters 23 through 25.
- **SD(i, p)**—Segment demand: the desired flow rate through Segment (i) including on- and off-ramp demands in Time Interval (p) (veh). This segment demand is calculated without any capacity constraints.
- **SF(i, t, p)**—Segment flow: the segment flow out of Segment (i) during Time Step (t) in Time Interval (p) (veh).
- **WS(i, p)**—Wave speed: the speed at which a front-clearing queue shock wave travels through Segment (i) during Time Interval (p) (m/s).

- $WTT(i, p)$ —Wave travel time: the time taken by the shock wave traveling at the wave speed (WS) to travel from the downstream end of Segment (i) to the upstream end of the segment during Time Interval (p), in time steps.
- $U(i, p)$ —Average segment speed: the average space-mean speed over the length of Segment (i) during Time Interval (p) (km/h).
- $UV(i, t, p)$ —Unserved vehicles: the additional number of vehicles stored on Segment (i) at the end of Time Step (t) in Time Interval (p) due to a downstream bottleneck.

Node Variables

- $MI(i, t, p)$ —Maximum mainline input: the maximum flow desiring to enter Node (i) during Time Step (t) in Time Interval (p), based on flows from all upstream segments, taking into account all geometric and traffic constraints upstream of the node including queues accumulated from previous time intervals.
- $MF(i, t, p)$ —Mainline flow: the actual mainline flow rate that can cross Node (i) during Time Step (t) in Time Interval (p).
- $MO1(i, t, p)$ —Maximum Mainline Output 1: the maximum allowable mainline flow rate across Node (i) during Time Step (t) in Time Interval (p), limited by the flow from an on-ramp at Node (i).
- $MO2(i, t, p)$ —Maximum Mainline Output 2: the maximum allowable mainline flow rate across Node (i) during Time Step (t) in Time Interval (p), limited by the available storage on Segment (i) due to a downstream queue.
- $MO3(i, t, p)$ —Maximum Mainline Output 3: the maximum allowable mainline flow rate across Node (i) during Time Step (t) in Time Interval (p), limited by the presence of queued vehicles at the upstream end of Segment (i) while the queue clears from the downstream end of Segment (i).

On-Ramp Variables

- $ONRI(i, t, p)$ —On-ramp input: ramp flow rate desiring to enter the merge point at On-Ramp (i) during Time Step (t) in Time Interval (p), based on current ramp demand and ramp queues accumulated from previous time intervals.
- $ONRD(i, p)$ —On-ramp demand: desired entry flow rate for on-ramp at Node (i) in Time Interval (p).
- $ONRC(i, p)$ —On-ramp capacity: geometric carrying capacity of on-ramp at Node (i) roadway during Time Interval (p).
- $ONRF(i, t, p)$ —On-ramp flow: actual ramp flow rate that can cross On-Ramp Node (i) during Time Step (t) in Time Interval (p); takes into account control constraints (e.g., ramp meters).
- $ONRQL(i, t, p)$ —On-ramp queue length: queue length on On-Ramp (i) at the end of Time Step (t) in Time Interval (p).
- $ONRO(i, t, p)$ —On-ramp output: maximum flow rate that can enter the merge point from On-Ramp (i) during Time Step (t) in Time Interval (p); constrained by Lane 1 (shoulder lane) flow on Segment (i) and the Segment (i) capacity or by a queue spillback filling the mainline segment from a bottleneck further downstream, whichever governs.
- $ONRQ(i, t, p)$ —On-ramp queue: the unmet demand that is stored on the on-ramp roadway at Node (i) during Time Step (t) in Time Interval (p) (veh).
- $RM(i, p)$ —Ramp-metering rate: the maximum allowable rate of an on-ramp meter at on-ramp at Node (i) during Time Interval (p) (veh/h).

Off-Ramp Variables

- $DEF(i, t, p)$ —Deficit: the unmet demand from a previous Time Interval (p) that flows past Node (i) during Time Step (t); used in off-ramp flow calculations downstream of a bottleneck.

- OFRD(i, p)—Off-ramp demand: the desired flow exiting at Off-Ramp (i) during Time Interval (p).
- OFRF(i, t, p)—Off-ramp flow: the actual flow that can exit at Off-Ramp (i) during Time Step (t) in Time Interval (p).

Facilitywide Variables

- SMS(NS, p)—Average time interval facility speed: the average space-mean speed over the entire facility during Time Interval (p).
- K(NS, p)—Average time interval facility density: the average vehicle density over the entire facility during Time Interval (p).
- SMS(NS, P)—Average analysis period facility speed: the average space-mean speed over the entire facility during the entire analysis period (P).
- K(NS, P)—Average analysis period facility density: the average vehicle density over the entire facility during the entire analysis period (P).

A.2 OVERALL PROCEDURE DESCRIPTION

The procedure is described according to the nine-step process shown in Exhibit A22-1.

A.2.1 Input Module

The first step in the methodology is to gather all geometric and traffic data. The most basic data are required for sizing the analysis. These basic data are listed below.

- Number of time intervals: the number of time intervals is input to size the analysis with the correct time dimension. There is no practical limit on the number time intervals, although the current computer implementation is limited to 12 intervals.
- Time interval duration: the time interval duration can vary to allow for finer or broader analysis of freeway facilities. Caution should be used when using other than the recommended 15-min time interval. First, the capacities that are calculated are based on the maximum hourly flow rate that can travel through a segment during a 15-min analysis interval. As the interval duration decreases, the capacity may actually increase, and vice versa. The methodology assumes that there is instantaneous travel time between segments when demands are computed on segments. In other words, there is no demand shock wave at any point where the demand changes (i.e., when a new time interval begins). For this assumption to be reasonable, the uncongested travel time of the freeway facility being analyzed (which is directly related to its length) should not be longer than the duration of the time intervals being used.
- Time step duration: once oversaturation begins, the procedure moves to time steps. The duration of the time steps should be determined on the basis of the segment lengths as shown later in Exhibit A22-4. There must be an integer number of time steps in a time interval.
- Number of segments: the number of segments must be determined from the freeway facility chapter. Refer to Exhibit 22-3 for a suggested process to divide a facility into sections and segments.
- Jam density: the systemwide jam density is required for oversaturated analysis.

The default value is 120 pc/km/ln.

The geometric, traffic, and demand data required for a freeway facility analysis are shown in Exhibit 22-12.

A.2.2 Demand Estimation Module

The demand estimation module is invoked when the methodology uses actual freeway counts. If demand flows are known or can be projected, those values can be used directly. The demand estimation module is designed to convert the input set of freeway exit 15-min traffic counts into a set of freeway exit 15-min traffic demands. Freeway exit demand is defined as the number of vehicles that desire to exit the freeway in a given 15-

min time interval. This demand may not be represented by the 15-min exit count because of upstream freeway congestion within the freeway facility.

EXHIBIT A22-1. OVERALL PROCEDURE LAYOUT

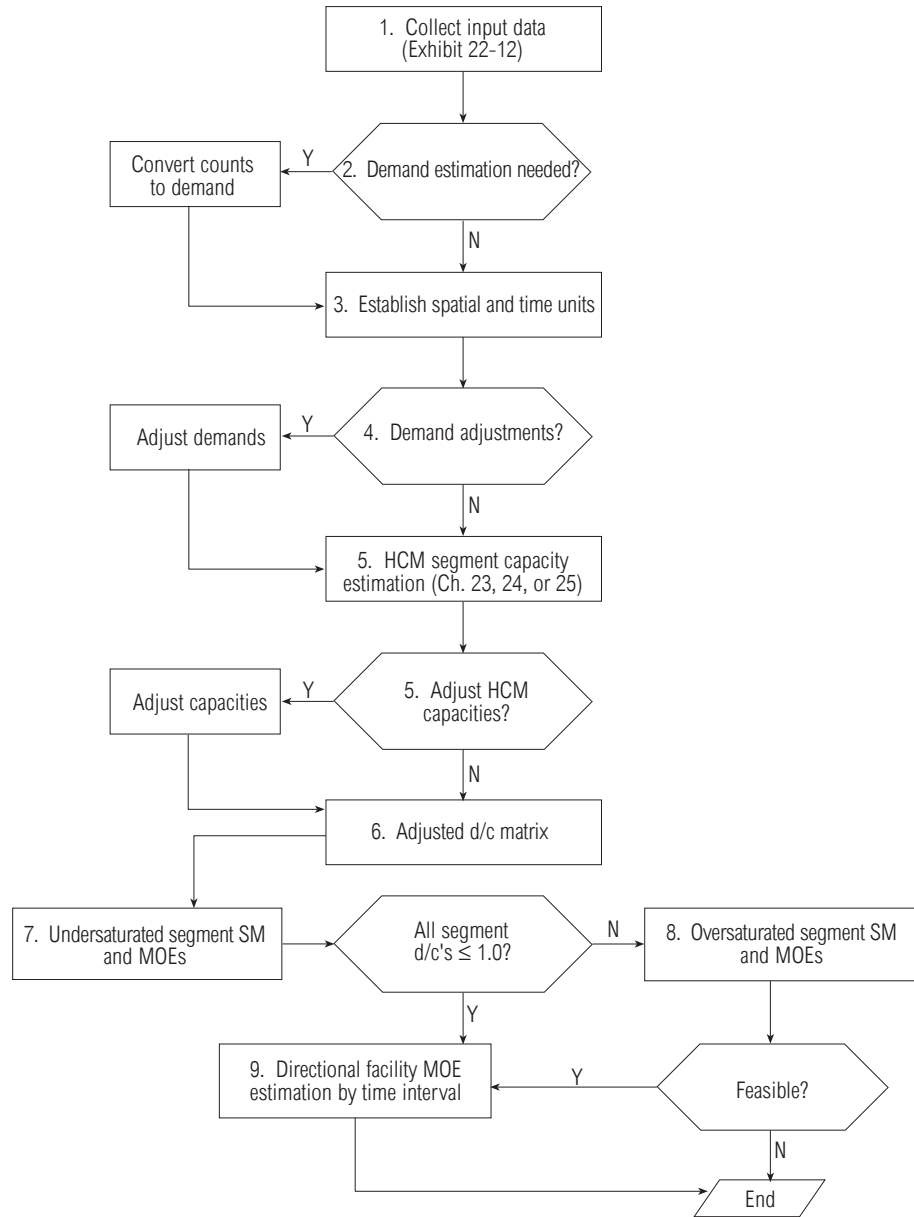

Notes:

d/c = demand-to-capacity ratio.
 SM = service measure.
 MOE = measure of effectiveness.

The procedure followed is to sum the freeway entrance demands along the entire freeway facility (including the freeway mainline entrance) and to compare it with the sum of the freeway exit counts along the entire freeway facility (including the freeway mainline exit) for each time interval. The ratio of the freeway entrance demands to the freeway exit counts is calculated for each time interval and will be referred to as the time interval scale factor. Theoretically, the scale factor should approach 1.00 when the freeway exit counts are, in fact, freeway exit demands.

Scale factors greater than 1.00 indicate increasing levels of congestion within the freeway facility (and the storing of vehicles on the freeway). Here, the exit traffic counts underestimate the actual freeway exit demands. Scale factors less than 1.00 indicate decreasing levels of congestion within the freeway facility (and the release of stored vehicles on the freeway). Here, the exit traffic counts overestimate actual freeway exit demands. To provide an estimate of freeway exit demand, each freeway exit count in the time interval is multiplied by the time interval scale factor.

The accuracy of this procedure primarily depends on the quality of the set of freeway traffic counts and to a lesser extent on the length of the freeway facility. With the use of 15-min time intervals, freeway facility lengths up to 15 to 20 km should not introduce significant errors into the procedure. The calculated scale factor pattern over the study period duration offers a means of checking the quality of the traffic count data. For example, if there is no congestion over the entire time-space domain, then there should be no pattern in the calculated 15-min scale factors, and they all should be within the range of 0.95 to 1.05. If there is congestion within the time-space domain, then there should be a pattern in the calculated 15-min scale factors. During the early time intervals with no congestion, the scale factors are expected to approach 1.00 and be within the range of 0.95 to 1.05. As congestion begins to occur and increase over time, the scale factors are expected to increase over 1.00 and be within the range of 1.00 to 1.10. When the extent of congestion reaches its highest level, the scale factor is expected to approach 1.00 and be within the range of 0.95 to 1.05. As the level of congestion recedes, the scale factor is expected to be less than 1.00 and be within the range of 0.90 to 1.00. If the final time intervals exhibit no congestion over the complete time-space domain, then there should be no pattern in the calculated 15-min scale factors, and they all should be within the range of 0.95 to 1.05. Once the freeway entrance and exit demands are estimated using the scale factors, the traffic demands for each freeway section in each time interval can be determined.

A.2.3 Establish Spatial and Time Units

The procedure analyzes a freeway in spatial units called segments, which are defined in Chapters 23 through 25. The division of a freeway facility into segments is described in Section II of this chapter. Time units are described in Section A.2.1.

A.2.4 Demand Adjustment Module

Driver responses such as spatial, temporal, or modal shifts caused by traffic management strategies are not automatically incorporated in the methodology. On viewing the facility traffic performance results, the analyst can modify the demand input manually to simulate the effect of user demand responses or traffic growth effects. The accuracy of the results depends on the accuracy of the estimation of the user demand responses. Ramp-metering strategies are evaluated through adjusting the ramp roadway capacity, and this application is described in the segment capacity adjustment module.

A.2.5 Segment Capacity Estimation and Adjustment Module

Segment capacity estimates are determined from Chapters 23 through 25 for basic segments, weaving segments, and ramp segments, respectively. All capacities are expressed in vehicles per hour. All estimates of segment capacity should be carefully reviewed and compared with local knowledge and available traffic information for the study site. The capacity value used for bottleneck segments has the greatest effect on the predicted freeway traffic performance. Actual field-observed capacities at bottlenecks should be obtained whenever practical and substituted for estimated capacities.

On-ramp and off-ramp roadway capacities are also determined in this capacity module. On-ramp demands may exceed on-ramp capacities and limit the traffic demand entering the freeway. Off-ramp demands may exceed off-ramp capacities and cause congestion on the freeway, although this particular effect is not accounted for in the

methodology. The relationships of demand and capacity for each on-ramp and off-ramp, as well as for each freeway segment, will be addressed later in the demand-to-capacity analysis module.

Again, unlike the analyses in the basic freeway, freeway weaving, and ramp chapters, all analyses in this chapter are on a vehicle-based capacity and not in passenger-car units.

The effect of a predetermined ramp-metering plan can be evaluated in this methodology by modifying the ramp roadway capacities. The capacity of each entrance ramp in each time interval is changed to the desired metering rate specified. This feature not only permits the evaluation of the prespecified ramp-metering plan but also permits the user to experiment to obtain an improved ramp-metering plan.

Freeway design improvements can be evaluated within this methodology by modifying the design features of any segment or segments of the freeway facility, as described in Section II of this chapter.

Reduced-capacity situations can also be investigated. The capacity in any cell of the time-space domain can be reduced to represent incident situations such as construction and maintenance activities, adverse weather, and traffic accidents/vehicular breakdowns. Similarly, capacity can be increased to match field measurements. When analyzing adjusted capacity situations, it is important to use an alternative speed-flow relationship. The following relationship assures a constant ideal density of 28 pc/km/ln at capacity as indicated in Chapter 23 of the manual. Exhibit A22-2 shows speed-flow plots for capacity adjustment factors (CAFs) of 100, 95, 90, and 85 percent of the original capacity. The predicted speed for the alternative speed-flow model can be computed by using Equation A22-1.

$$S = FFS + \left[1 - e^{-\ln\left(\frac{FFS+1 - \frac{C * CAF}{28}}{C * CAF}\right) \frac{v_p}{C * CAF}} \right] \quad (A22-1)$$

where

- S = segment speed (km/h),
- FFS = segment free-flow speed (km/h),
- C = original segment capacity (pc/h/ln),
- CAF = capacity adjustment factor (CAF = 1.0, use Chapters 23 through 25 speed estimation procedures), and
- v_p = segment flow rate (pc/h/ln).

Note that when $v_p \approx 0$ in Equation A22-1, S approaches FFS. Similarly, when $v_p \approx C * CAF$, S approaches speed at capacity.

A.2.6 Demand-to-Capacity Ratio Module

Once all freeway segment cells have been analyzed, demand-to-capacity ratios are modified into volume-to-capacity ratios for later use in calculating freeway traffic performance measures. As stated earlier, if all freeway segment cells are undersaturated (demands less than capacities), the volume-to-capacity ratios are identical to the demand-to-capacity ratios, and the analysis is simple. However, if demand is greater than capacity in one or more of the freeway segment cells, oversaturated flow conditions will occur, and the time step analysis procedure is invoked.

Until oversaturated conditions are encountered, segments are analyzed using the undersaturated segment MOE module. All subsequent time intervals, however, are analyzed using the oversaturated segment MOE module.

EXHIBIT A22-2. ALTERNATIVE SPEED-FLOW CURVES FOR INDICATED CAPACITY ADJUSTMENT FACTORS
(SEE FOOTNOTE FOR ASSUMED VALUES)

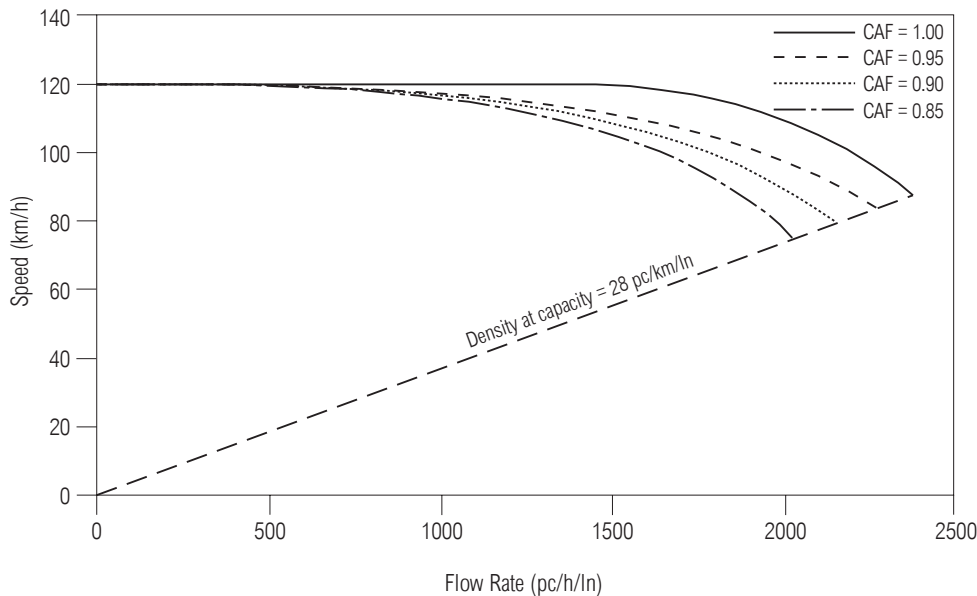

Notes:
Assumptions: FFS = 120 km/h, capacity adjustment factor (CAF) of 1.0, 0.95, 0.90, and 0.85.

A.3 UNDERSATURATED SEGMENT MOE MODULE

This module begins with the first segment in the first time interval. For each cell the flow (or volume) is equal to demand, the volume-to-capacity ratio is equal to the demand-to-capacity ratio, and undersaturated flow conditions prevail. Performance measures for the first segment during the first time interval are calculated using the procedures for the corresponding segment type in Chapters 23 through 25.

The analysis continues to the next downstream freeway segment in the same time interval, and the performance measures are calculated. The process is continued until the last downstream freeway segment cell in this time interval has been analyzed. For each cell, the volume-to-capacity ratio and performance measures are calculated for each freeway segment in the first time interval. The analysis continues in the second time interval beginning at the furthest upstream freeway segment and moving downstream until all freeway segments in that time interval have been analyzed. This pattern continues for the third time interval, fourth time interval, and so on until the methodology encounters a time interval that contains one or more segments with a demand-to-capacity ratio greater than 1.00 or when the last segment in the last time interval is analyzed. If none is encountered, the segment performance measures are taken directly from Chapters 23 through 25, and the facility performance measures are calculated as in Section A.4.

When the analysis moves from isolated segments to a facility, an additional constraint is necessary. To limit the speeds downstream of a segment experiencing a low average speed, a maximum achievable speed is imposed on each segment average speed. This maximum speed is based on acceleration characteristics reported by the American Association of State Highway and Transportation Officials and is shown in Equation A22-2 (1).

$$V_{max} = FFS - (FFS - V_{prev})e^{-0.0053L} \tag{A22-2}$$

where

- V_{max} = maximum achievable segment speed (km/h),
- FFS = segment free-flow speed (km/h),
- V_{prev} = average speed on immediate upstream segment (km/h), and

L = distance from midpoints of the upstream segment and the subject segment (m).

A.4 OVERSATURATED SEGMENT MOE MODULE

Oversaturated flow conditions occur when the demand on one or more freeway segment cells exceeds its capacity. Once oversaturation is encountered, the methodology changes its temporal and spatial units of analysis. The spatial units become nodes and segments, and the temporal unit moves from a time interval to smaller time steps. A node is defined as the junction of two segments. There is always one more node than segment, with nodes added at the beginning and end of each segment. The numbering of nodes and segments begins at the upstream end and moves to the downstream end, with the segment upstream of Node (i) numbered Segment (i - 1) and the downstream segment numbered (i), as shown in Exhibit A22-3. The intermediate segments and node numbers represent the division of the section between Ramps 1 and 2 into three segments numbered 2 (ONR), 3 (BASIC), and 4 (OFR). The oversaturated analysis moves from the first node to each downstream node in the same time step. After the completion of a time step, the same nodal analysis is performed for the subsequent time steps.

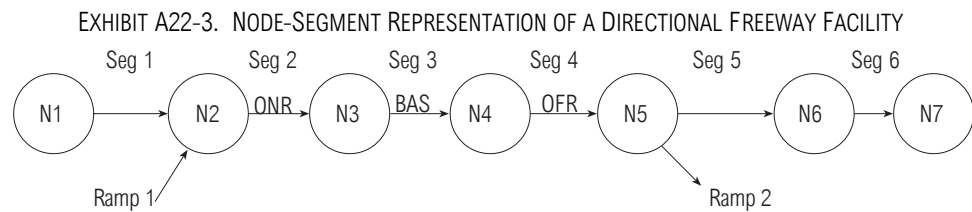

The oversaturated analysis focuses on the computation of segment average flows and densities in each time interval. These parameters are later aggregated to produce facilitywide estimates. Two key inputs into the flow estimation procedures are the time step duration for flow updates and a flow-density function. They are described in the next sections.

A.4.1 Procedure Parameters

Segment flows are calculated in each time step and are used to calculate the number of vehicles on each segment at the end of every time step. The number of vehicles on each segment is used to track queue accumulation and discharge and to calculate the average segment density.

To provide accurate estimates of flows in oversaturated conditions, the time intervals are divided into smaller time steps. The conversion from time intervals to time steps occurs during the first oversaturated time interval and remains until the end of the analysis. The transition to time steps is essential because at certain points in the methodology future performance estimates are made on the basis of the past value of a variable. The time steps correspond to the following lengths in Exhibit A22-4. These values are vital in two major situations.

EXHIBIT A22-4. RECOMMENDED TIME STEP DURATION FOR OVERSATURATED ANALYSIS

Shortest segment length (m)	≤ 100	200	300	400	≥ 450
Time step duration (s)	15	25	40	60	60

The first situation is when segments are short and the rate of queue growth is rapid. Under these conditions, a short segment may be completely undersaturated in one time step and completely queued in another. The methodology may store more vehicles in this segment during a time step than there is allowable space. Fortunately, this error is

compensated for in the next time step, and the procedure continues to accurately track queues and store vehicles after this correction.

The second situation in which small time steps are important is when two queues interact. There is a temporary inaccuracy due to the maximum output of a segment changing, thus causing the estimation of available storage to be slightly in error. This results in the storage of too many vehicles on a particular segment. This supersaturation is temporary and is compensated for in the next time step. Inadequate time step size will result in erroneous estimation of queue lengths and may affect other performance measures as well. Regardless, if interacting queues occur, the results should be viewed with extreme caution.

Analysis of freeway segments depends on the relationships between segment speed, flow, and density. Chapter 23 of this manual defines a relationship between these variables and the calculation of performance measures in the undersaturated regime. The methodology presented here uses the same relationships for undersaturated segments. Calculations for oversaturated segments use a simplified linear flow-density diagram in the congested region. Exhibit A22-5 shows this flow-density diagram for a segment having a free-flow speed of 120 km/h. For other free-flow speeds, the corresponding capacities in Chapters 23 through 25 should be used.

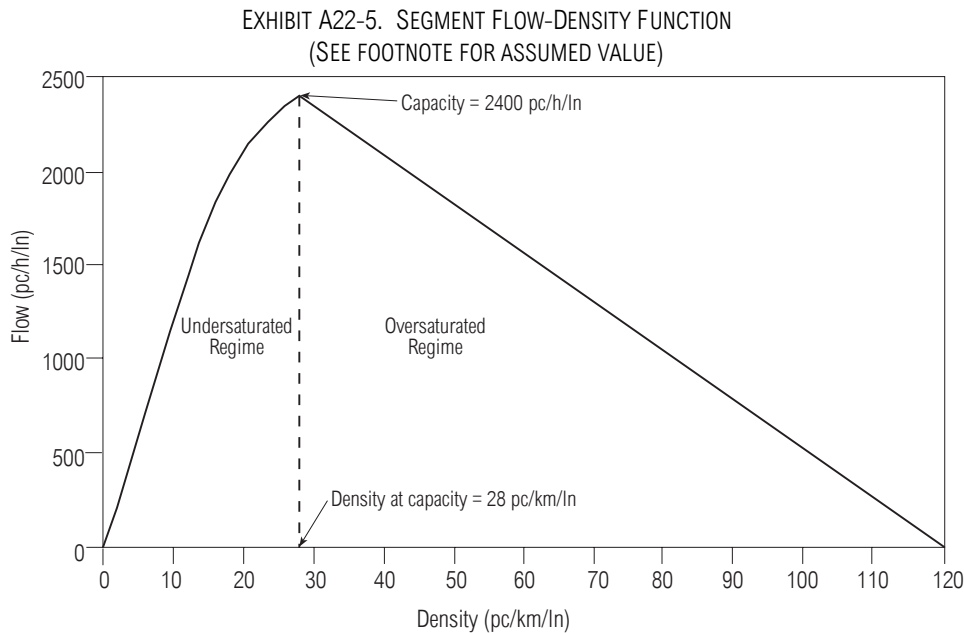

Note:
Assumption: FFS = 120 km/h.

A.4.2 Flow Estimation

The oversaturated portion of the methodology is detailed in a flowchart as Exhibit A22-6. The flowchart is divided into nine parts, which are discussed in this section. Within each subsection, computations are detailed and labeled according to each step of the flowchart.

The procedure first calculates a number of flow variables starting at the first node during the first time step of oversaturation, followed by each downstream node and segment in that same time step. After all computations in the first time step are completed, calculations are performed at each node and segment during subsequent time steps for all remaining time intervals until the analysis is completed.

EXHIBIT A22-6. OVERSATURATED ANALYSIS PROCEDURE

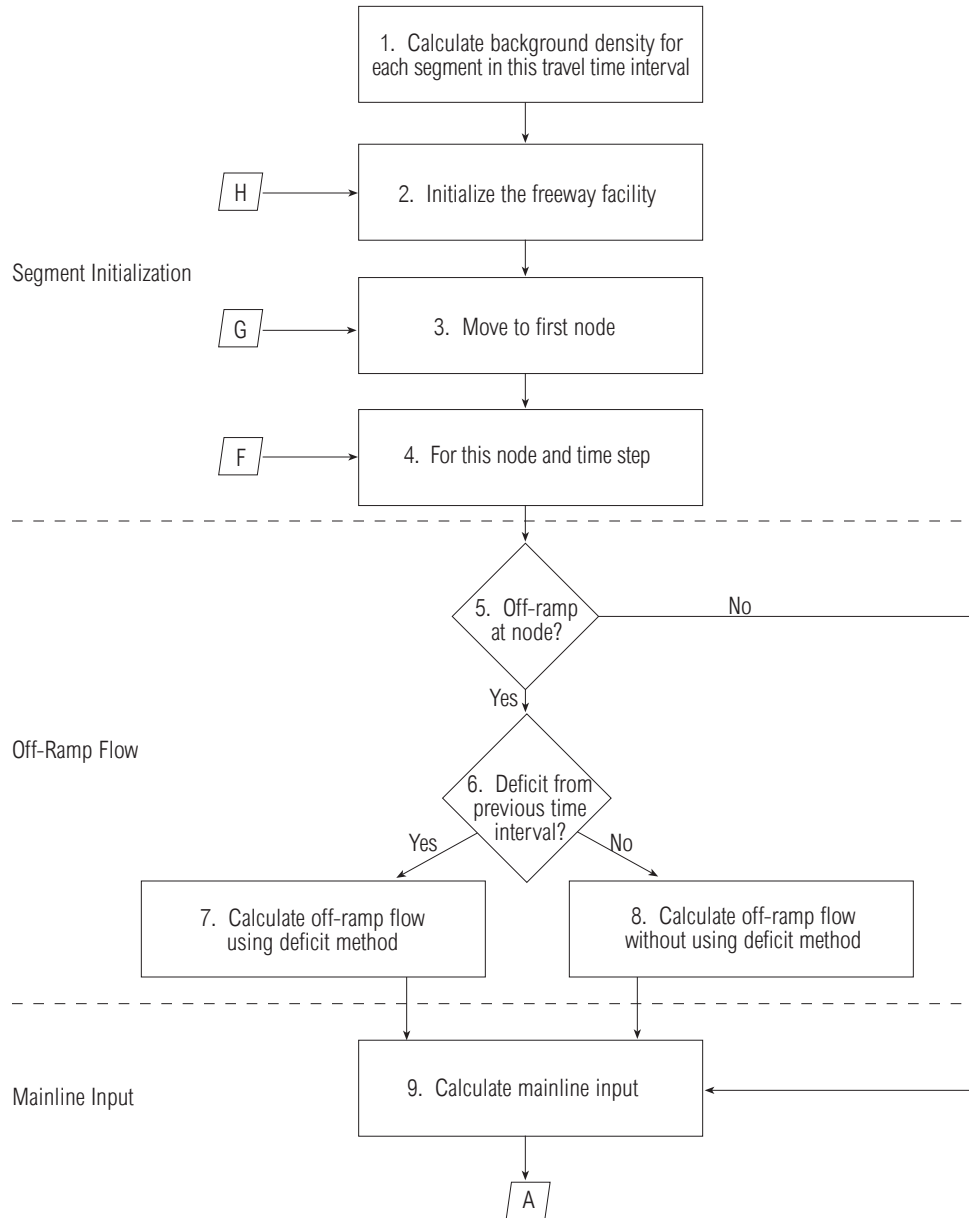

Exhibit A22-6 is continued on next page

EXHIBIT A22-6 (CONTINUED). OVERSATURATED ANALYSIS PROCEDURE

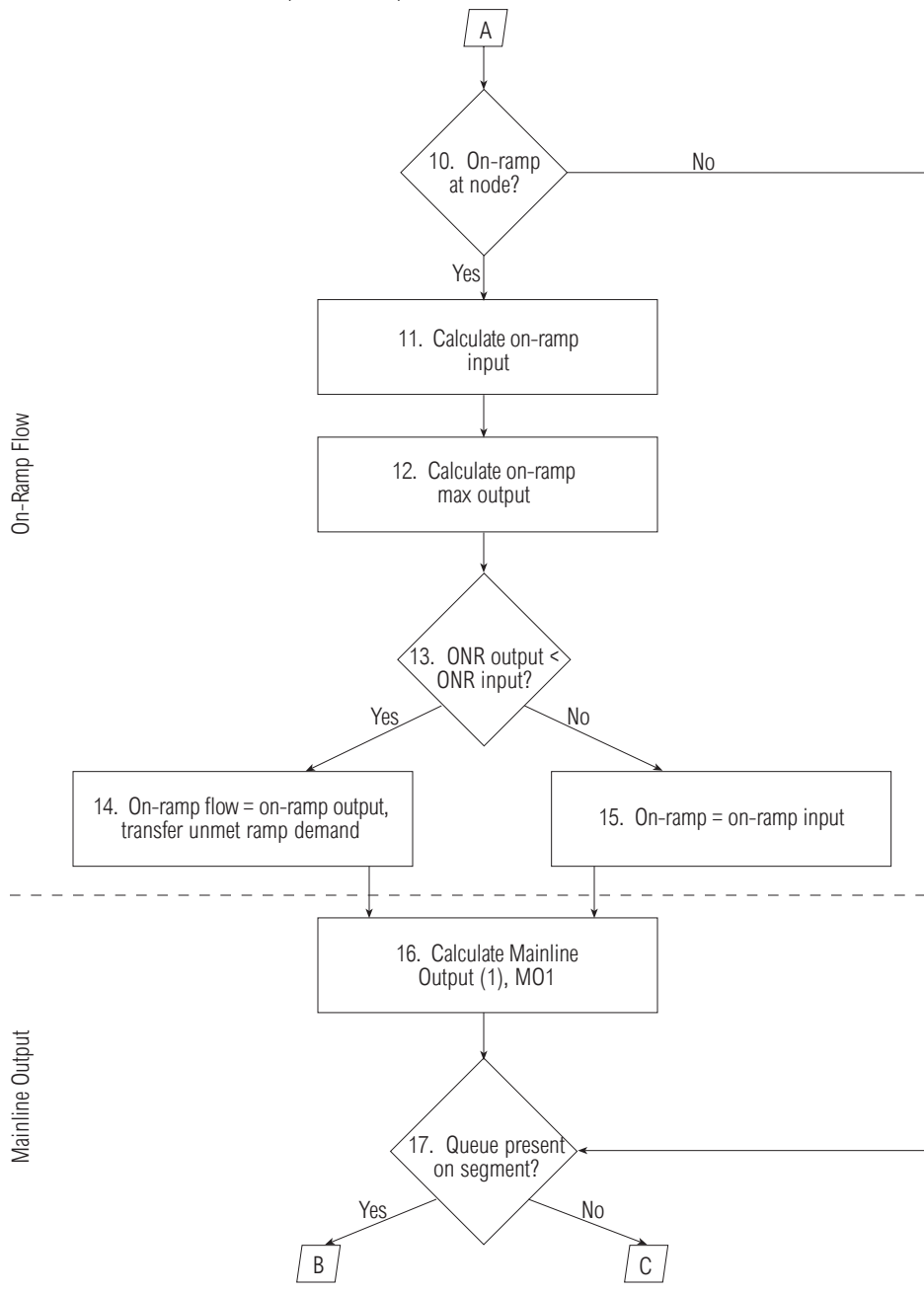

Exhibit A22-6 is continued on next page

EXHIBIT A22-6 (CONTINUED). OVERSATURATED ANALYSIS PROCEDURE

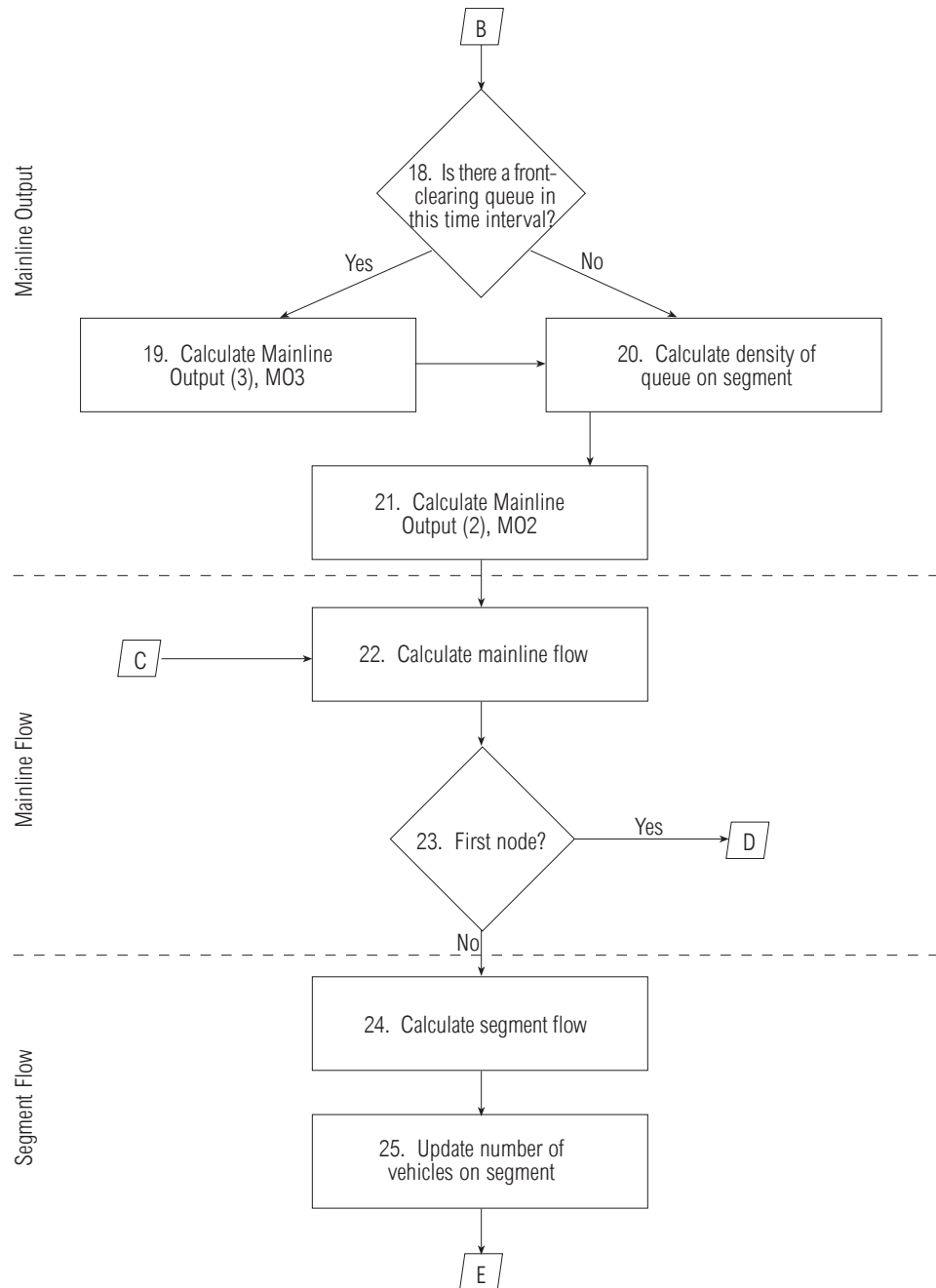
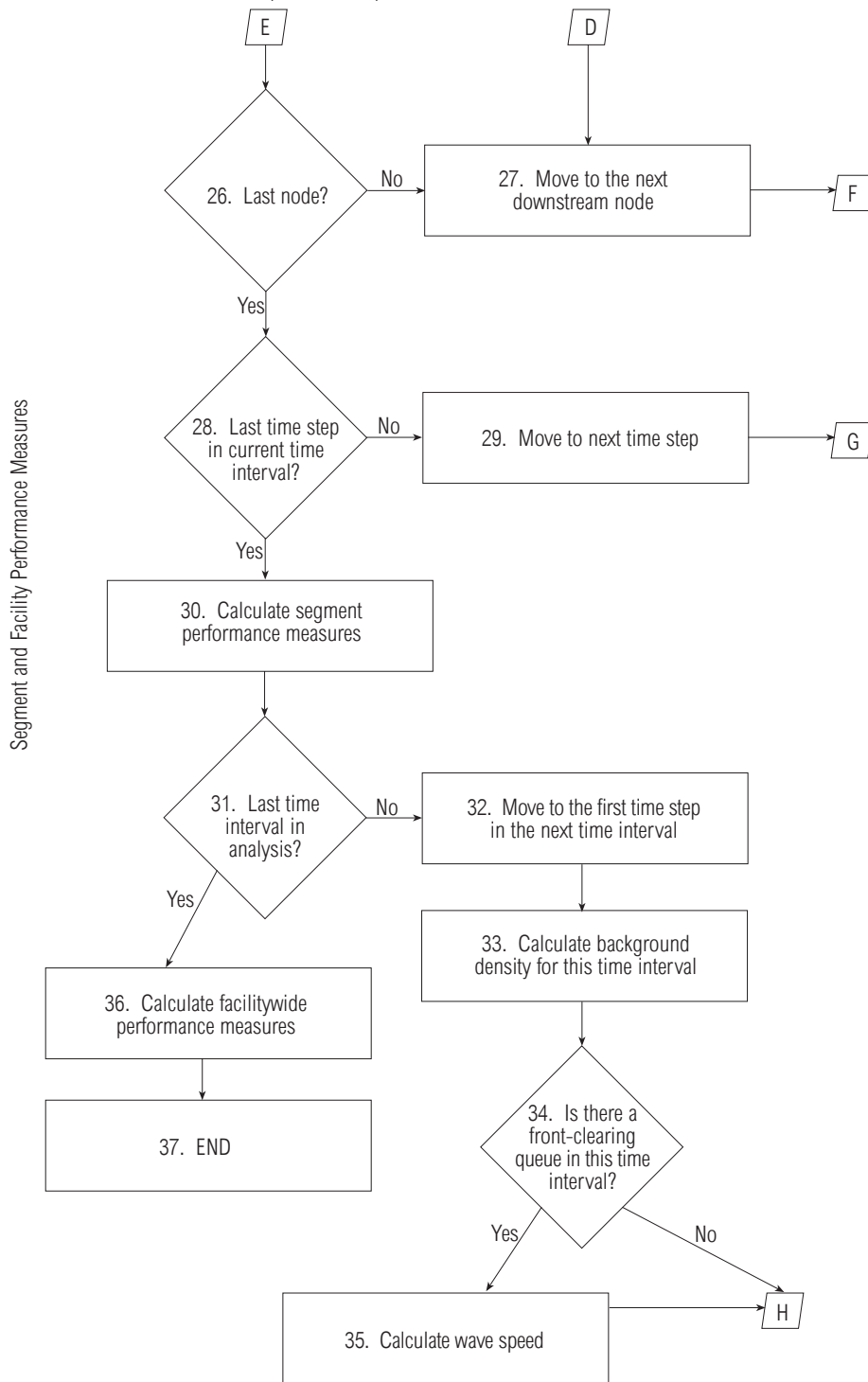

Exhibit A22-6 is continued on next page

EXHIBIT A22-6 (CONTINUED). OVERSATURATED ANALYSIS PROCEDURE



A.4.2.1 Segment Initialization (Exhibit A22-6, Steps 1 Through 4)

Steps 1 through 4 of the oversaturated procedure prepare the flow calculations for the first time step and specify return points for subsequent time steps. To calculate the number of vehicles on each segment at the various time steps, the segments must contain

the proper number of vehicles before the queuing analysis places unserved vehicles on segments. The initialization of each segment is described below.

A simplified queuing analysis is initially performed to account for the effects of upstream bottlenecks. These bottlenecks meter traffic downstream of their location. The storage of unserved vehicles (those unable to enter the bottleneck) on upstream segments is performed in a later module. To obtain the proper number of vehicles on each segment, the expected demand (ED) is calculated. ED is based on demands for and capacities of the segment and includes the effects of all upstream segments. The expected demand is the flow of traffic expected to arrive at each segment if all queues were stacked vertically (i.e., no upstream effects of queues). In other words, all segments upstream of a bottleneck have expected demands equal to their actual demand. The expected demand of the bottleneck segment and all further downstream segments are calculated assuming a capacity constraint at the bottleneck, which meters traffic to downstream segments. The expected demand is calculated for each segment using Equation A22-3.

$$ED(i, p) = \min[SC(i, p), ED(i - 1, p) + ONRD(i, p) - OFRD(i, p)] \quad (A22-3)$$

Note that the segment capacity (SC) applies to the entire length of the segment. With the expected demand calculated, the background density (KB) can be obtained for each segment using the appropriate segment density estimation procedures in Chapters 23 through 25. The background density is used to calculate the number of vehicles on each segment (NV) using Equation A22-4. If there are unserved vehicles at the end of the preceding time interval, the unserved vehicles (UV) are transferred to the current time interval. Here, S refers to the last time step in the preceding time interval. The (0) term in NV represents the start of the first time step in Time Interval (p). The corresponding term at the end of the time step is NV(i, 1, p).

$$NV(i, 0, p) = KB(i, p) * L(i) + UV(i, S, p - 1) \quad (A22-4)$$

The number of vehicles calculated from the background density is the minimum number of vehicles that can be on the segment at any time. This is a powerful check on the methodology because the existence of queues downstream cannot reduce this minimum. Rather, the segment can only store additional vehicles. The storage of unserved vehicles will be determined in the segment flow calculation module later in this appendix.

A.4.2.2 Mainline Flow Calculations (Exhibit A22-6, Steps 9 and 16 Through 23)

The description of ramp flows will follow the description of mainline flows. Thus, Steps 5 through 8 and 10 through 15 are skipped at this time to focus first on mainline flow computations. Because of the skipping of steps in the descriptions, some computations may include variables that have not been described but that have been previously calculated within the flowchart.

Flows analyzed in oversaturated conditions are calculated every time step and are expressed in terms of vehicles per time step. The procedure separately analyzes the flow across a node on the basis of the origin and destination of the flow across the node. The mainline flow is defined as the flow passing from upstream Segment (i - 1) to downstream Segment (i). It does not include the on-ramp flow. The flow to an off-ramp is the off-ramp flow. The flow from an on-ramp is the on-ramp flow. Each of these flows is shown in Exhibit A22-7 with their origin, destination, and relationship to Segment (i) and Node (i).

The segment flow is the total output of a segment, as shown in Exhibit A22-7. Segment flows are calculated by determining the mainline and ramp flows. The mainline flow is calculated as the minimum of six constraints: the mainline input, Mainline Output 1 (MO1), Mainline Output 2 (MO2), Mainline Output 3 (MO3), the upstream Segment (i - 1) capacity, and the downstream Segment (i) capacity, as explained next.

EXHIBIT A22-7. DEFINITIONS OF MAINLINE AND SEGMENT FLOWS

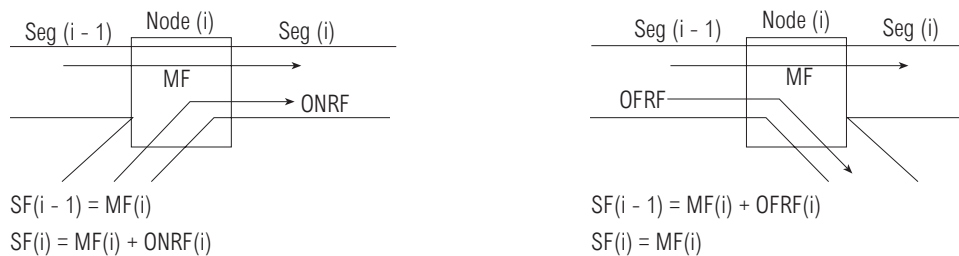

A.4.2.2.1 Mainline Input (Exhibit A22-6, Step 9)

The mainline input (MI) is the number of vehicles that wish to travel through a node during the time step. The calculation includes (a) the effects of bottlenecks upstream of the analysis node, (b) the metering of traffic during queue accumulation, and (c) the presence of additional traffic during upstream queue discharge.

The mainline input is calculated by taking the number of vehicles entering the node upstream of the analysis node, adding on-ramp flows or subtracting off-ramp flows, and adding the number of unserved vehicles on the upstream segment. This is the maximum number of vehicles that wish to enter a node during a time step. The mainline input is calculated using Equation A22-5, where all values have units of vehicles per time step.

$$\begin{aligned}
 MI(i, t, p) = & MF(i-1, t, p) + ONRF(i-1, t, p) - OFRF(i, t, p) \\
 & + UV(i-1, t-1, p)
 \end{aligned}
 \tag{A22-5}$$

A.4.2.2.2 Mainline Output (Exhibit A22-6, Steps 16 Through 21)

The mainline output is the maximum number of vehicles that can exit a node, constrained by downstream bottlenecks or by merging on-ramp traffic. Different constraints on the output of a node result in three separate types of mainline outputs (MO1, MO2, and MO3).

A.4.2.2.2.1 Mainline Output 1—Ramp Flows (Exhibit A22-6, Step 16)

MO1 is the constraint caused by the flow of vehicles from an on-ramp. The capacity of an on-ramp segment is shared by two competing flows. This on-ramp flow limits the flow from the mainline through this node. The total flow that can pass the node is estimated as the minimum of the Segment (i) capacity and the mainline outputs from the preceding time step. The sharing of Lane 1 (shoulder lane) capacity is determined in the calculation of the on-ramp flow and is described in Section A.4.2.4. MO1 is calculated using Equation A22-6.

$$MO1(i, t, p) = \min[SC(i, t, p) - ONRF(i, t, p), MO2(i, t-1, p), MO3(i, t-1, p)]
 \tag{A22-6}$$

A.4.2.2.2.2 Mainline Output 2—Segment Storage (Exhibit A22-6, Steps 20 and 21)

The second constraint on the output of mainline flow through a node is caused by the growth of queues on a downstream segment. As a queue grows on a segment, it may eventually limit the flow into the current segment once the boundary of the queue reaches the upstream end of the segment. The boundary of the queue is treated as a shock wave. MO2 is a limit on the flow exiting a node due to the presence of a queue on the downstream segment.

The MO2 limitation is determined first by calculating the maximum number of vehicles allowed on a segment at a given queue density. The maximum flow that can enter a queued segment is the number of vehicles that leave the segment plus the

difference between the maximum number of vehicles allowed on the segment and the number of vehicles already on the segment. The density of the queue is calculated using Equation A22-7 for the linear density-flow relationship shown in Exhibit A22-5 earlier.

$$KQ(i, t, p) = KJ - \frac{(KJ - KC) * SF(i, t - 1, p)}{SC(i, p)} \quad (A22-7)$$

Once the queue density is computed, MO2 can be computed using Equation A22-8.

$$MO2(i, t, p) = SF(i, t - 1, p) - ONRF(i, t, p) + [KQ(i, t, p) * L(i)] - NV(i, t - 1, p) \quad (A22-8)$$

The performance of the downstream node is estimated by taking the performance during the preceding time step. This estimation remains valid when there are no interacting queues. When queues do interact and the time steps are small enough, the error in the estimations are corrected in the next time step.

A.4.2.2.2.3 Mainline Output 3—Front-Clearing Queues (Exhibit A22-6, Steps 17 Through 19)

The final constraint on exiting mainline flows at a node is caused by downstream queues clearing from their downstream end. These front-clearing queues are typically caused by incidents where there is a temporary reduction in capacity. A queue will clear from the front if two conditions are satisfied. First, the segment capacity (minus the on-ramp demand if present) for this time interval must be greater than the segment capacity (minus the ramp demand if present) in the preceding time interval. The second condition is that the segment capacity minus the ramp demand for this time interval be greater than the segment demand for this time interval. A queue will clear from the front if both conditions in the following inequality (Equation A22-9) are met.

$$\begin{aligned} \text{If } [SC(i, p) - ONRD(i, p)] > [SC(i, p - 1) - ONRD(i, p - 1)] \\ \text{and } [SC(i, p) - ONRD(i, p)] > SD(i, p) \end{aligned} \quad (A22-9)$$

A segment with a front-clearing queue will have the number of vehicles stored decrease during recovery, while the back of queue position is unaffected. Thus, the clearing does not affect the segment throughput until the recovery wave has reached the upstream end of the segment. In the flow-density graph shown in Exhibit A22-8, the wave speed is estimated by the slope of the dotted line connecting the bottleneck throughput and the segment capacity points.

The assumption of a linear flow-density function greatly simplifies the calculated wave speed. The bottleneck throughput value is not required to estimate the speed of the shock wave that travels along a known line. All that is required is the slope of the line, which is calculated using Equation A22-10.

$$WS(i, p) = \frac{SC(i, p)}{N(i, p) * (KJ - KC)} \quad (A22-10)$$

The wave speed is used to calculate the time it takes the front queue-clearing shock wave to traverse this segment, called the wave travel time (WTT). Dividing the wave speed (WS) by the segment length in kilometers gives the wave travel time.

The recovery wave travel time is the time required for the conditions at the downstream end of the current segment to reach the upstream end of the current segment. To place a limit on the current node, the conditions at the downstream node are observed at a time in the past. This time is the wave travel time. This constraint on the current node is called the Mainline Output 3, or MO3. The calculation of MO3 is performed by using Equations A22-11 and A22-12. If the wave travel time is not an integer number of time steps, then the weighted average performance of each variable is taken for the time steps nearest to the wave travel time. This method is based on the process described in References 2-4.

$$WTT = \frac{T * L(i)}{WS(i, p)} \quad (A22-11)$$

$$\begin{aligned}
 MO3(i, t, p) = & \min[MO1(i + 1, t - WTT, p), \\
 & MO2(i + 1, t - WTT, p) + OFRF(i + 1, t - WTT, p), MO3(i + 1, t - WTT, p) \\
 & + OFRF(i + 1, t - WTT, p), SC(i, t - WTT, p), SC(i + 1, t - WTT, p) \\
 & + OFRF(i + 1, t - WTT, p)] - ONRF(i, t, p) \qquad (A22-12)
 \end{aligned}$$

EXHIBIT A22-8. FLOW-DENSITY FUNCTION WITH A SHOCK WAVE
(SEE FOOTNOTE FOR ASSUMED VALUE)

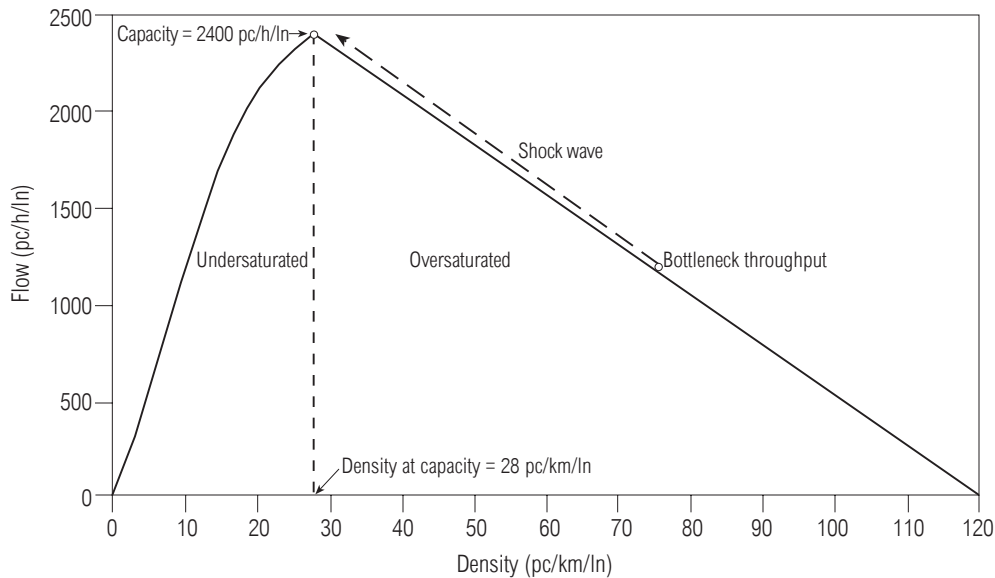

Note:
Assumption: FFS = 120 km/h.

A.4.2.2.3 Mainline Flow (Exhibit A22-6, Steps 22 and 23)

The flow across a node is called the mainline flow and is the minimum of the following variables: mainline input, MO1, MO2, MO3, upstream Segment (i - 1) capacity, and downstream Segment (i) capacity.

$$\begin{aligned}
 MF(i, t, p) = & \min [MI(i, t, p), MO1(i, t, p), MO2(i, t, p), MO3(i, t, p), \\
 & SC(i, t, p), SC(i - 1, t, p)] \qquad (A22-13)
 \end{aligned}$$

In addition to mainline flows, ramp flows must be analyzed. The presence of mainline queues also affects ramp flows.

A.4.2.3 On-Ramp Calculations (Exhibit A22-6, Steps 10 Through 15)

A.4.2.3.1 On-Ramp Input (Exhibit A22-6, Steps 10 and 11)

The maximum on-ramp input is calculated by adding the on-ramp demand and the number of vehicles queued on the ramp. The queued vehicles are treated as unmet ramp demand that was not served in previous time steps. The on-ramp input is calculated using Equation A22-14.

$$ONRI(i, t, p) = ONRD(i, t, p) + ONRQ(i, t - 1, p) \qquad (A22-14)$$

A.4.2.3.2 On-Ramp Output (Exhibit A22-6, Step 12)

The maximum on-ramp output is calculated on the basis of the mainline traffic through the node where the on-ramp is located. The on-ramp output is the minimum of

two values. The first is Segment (i) capacity minus the mainline input, in the absence of downstream queues. Otherwise, the segment capacity is replaced by the throughput of the queue. This estimation implies that vehicles entering an on-ramp segment will fill lanes 2 to N (where N is the number of lanes on the current segment) to capacity before entering Lane 1. This assumption appears to be consistent with the estimation of V_{12} from Chapter 25 of this manual.

The second case is when the Lane 1 flow on Segment (i) is greater than one-half of the Lane 1 capacity. At this point the on-ramp maximum output is set to one-half of Lane 1 capacity. This implies that when the demands from the freeway and the on-ramp are very high, there will be forced merging in a one-to-one fashion on the freeway from the freeway mainline and the on-ramp in Lane 1. An important characteristic of traffic behavior is that in a forced merging situation, ramp and right-lane freeway vehicles will generally merge one on one, sharing the capacity of the rightmost freeway lane (5). In all cases, the on-ramp maximum output is also limited to the physical ramp road capacity and the ramp-metering rate, if present. The maximum on-ramp output is an important limitation on the ramp flow. Queuing occurs when the combined demand from the upstream segment and the demand on the on-ramp exceed the throughput of the ramp segment. The queue can be located on the upstream segment, on the ramp, or on both and is dependent on the on-ramp maximum output. Equation A22-15 determines the value of the maximum on-ramp output.

$$\begin{aligned}
 ONRO(i, t, p) = & \min\{RM(i, p), ONRC(i, p), \max[\min\{SC(i, p), \\
 MO2(i, t - 1, p) + & ONRF(i, t - 1, p), MO3(i, t - 1, p) + ONRF(i, t - 1, p)\} - MI(i, t, p), \\
 \min\{SC(i, p), MO2(i, t - p) + & ONRF(i, t - 1, p), MO3(i, t - 1, p) \\
 + ONRF(i, t - 1, p)\}/2N(i, p)]\} & \qquad \qquad \qquad (A22-15)
 \end{aligned}$$

Note that this model incorporates the maximum mainline output constraints from downstream queues, not just the segment capacity. This is significant because as a queue spills over an on-ramp segment, the flow through Lane 1 is constrained. This, in turn, limits the flow that can enter Lane 1 from the on-ramp. The values of MO2 and MO3 for this time step are not yet known, so they are estimated from the preceding time step. This estimation is one rationale for using small time steps. If there is forced merging during the time step where the queue spills back over the current node, the on-ramp will discharge more than its share of vehicles (i.e., more than 50 percent of the Lane 1 flow). This will cause the mainline flow past Node i to be underestimated. But during the next time step, the on-ramp flow will be at its correct flow rate, and a one-to-one sharing of Lane 1 will occur.

A.4.2.3.3 On-Ramp Flows, Queues, and Delays (Exhibit A22-6, Steps 13 Through 15)

Finally, the on-ramp flow is calculated on the basis of the on-ramp input and output values computed above. If the on-ramp input is less than the on-ramp output, then the on-ramp demand can be fully served in this time step and Equation A22-16 is used.

$$ONRF(i, t, p) = ONRI(i, t, p) \qquad \qquad \qquad (A22-16)$$

Otherwise, the ramp flow is constrained by the maximum on-ramp output, and Equation A22-17 is used.

$$ONRF(i, t, p) = ONRO(i, t, p) \qquad \qquad \qquad (A22-17)$$

In the latter case, the number of vehicles in the ramp queue is updated using Equation A22-18.

$$ONRQ(i, t, p) = ONRQ(i, t - 1, p) + ONRI(i, t, p) - ONRO(i, t, p) \qquad \qquad \qquad (A22-18)$$

The total delay for on-ramp vehicles can be estimated by integrating the value of on-ramp queues over time. The methodology uses the discrete queue lengths estimated at the end of each interval, $ONRQ(i, S, p)$, to produce overall ramp delays by time interval.

A.4.2.4 Off-Ramp Flow Calculation (Exhibit A22-6, Steps 5 Through 8)

The off-ramp flow is determined by calculating a diverge percentage on the basis of the segment and off-ramp demands. The diverge percentage varies only by time interval and remains constant for vehicles that are associated with a particular time interval. If there is an upstream queue, traffic may be metered to this off-ramp. This will cause a decrease in the off-ramp flow. When the vehicles that were metered arrive in the next time interval, they use the diverge percentage associated with the preceding time interval.

A deficit in flow, caused by traffic from an upstream queue meter, creates delays for vehicles destined to this off-ramp and other downstream destinations. The upstream segment flow is used because the procedure assumes that a vehicle destined for an off-ramp is able to exit at the off-ramp once it enters the off-ramp segment. The calculation of this deficit is performed using Equation A22-19.

$$DEF(i, t, p) = \text{Max} \left\{ 0, \sum_{X=1}^{p-1} SD(i-1, X) - \left[\sum_{X=1}^{p-1} \sum_{t=1}^T [MF(i-1, t, X) + ONRF(i-1, t, X)] + \sum_{t=1}^{t-1} [MF(i-1, t, p) + ONRF(i-1, t, p)] \right] \right\} \quad (\text{A22-19})$$

If there is a deficit, then the off-ramp flow is calculated using the deficit method. The deficit method is used differently in two different situations. If the upstream mainline flow plus the flow from an on-ramp at the upstream node (if present) is less than the deficit for this time step, then the off-ramp flow is equal to the mainline and on-ramp flows times the off-ramp turning percentage in the preceding time interval, as indicated below.

$$OFRF(i, t, p) = [MF(i-1, t, p) + ONRF(i-1, t, p)] * [OFRD(i, p-1)/SD(i-1, p-1)] \quad (\text{A22-20})$$

If the deficit is less than the upstream mainline flow plus the on-ramp flow from an on-ramp at the upstream node (if present), then Equation A22-21 is used. This equation separates the flow into the remaining deficit flow and the balance of the arriving flow.

$$OFRF(i, t, p) = DEF(i, t, p) * [OFRD(i, p-1)/SD(i-1, p-1)] + [MF(i-1, t, p) + ONRF(i-1, t, p) - DEF(i, t, p)] * [OFRD(i, p)/SD(i-1, p)] \quad (\text{A22-21})$$

If there is no deficit, then the off-ramp flow is equal to the sum of upstream mainline flow plus the on-ramp flow from an on-ramp at the upstream node (if present), multiplied by the off-ramp turning percentage for this time interval according to Equation A22-22.

$$OFRF(i, t, p) = [MF(i-1, t, p) + ONRF(i-1, t, p)] * [OFRD(i, p)/SD(i-1, p)] \quad (\text{A22-22})$$

Note that the procedure does not currently incorporate any delay or queue length computations for off-ramps.

A.4.2.5 Segment Flow Calculation (Exhibit A22-6, Steps 24 and 25)

The segment flow is the number of vehicles that flow out of a segment during the current time step. These vehicles enter the current segment either to the mainline or to an off-ramp at the current node. The vehicles that entered the upstream segment may or may not have become queued within the segment. The segment flow is calculated using Equation A22-23.

$$SF(i-1, t, p) = MF(i, t, p) + OFRF(i, t, p) \quad (\text{A22-23})$$

The number of vehicles on each segment is calculated on the basis of the number of vehicles that were on the segment in the preceding time step, the number of vehicles that entered the segment in this time step, and the number of vehicles that leave the segment in this time step. Because the number of vehicles that leave a segment must be known, the number of vehicles on the current segment cannot be determined until the upstream segment is analyzed. The number of vehicles on each segment is calculated using Equation A22-24.

$$NV(i-1, t, p) = NV(i-1, t-1, p) + MF(i-1, t, p) + ONRF(i-1, t, p) - MF(i, t, p) - OFRF(i, t, p) \quad (A22-24)$$

The number of unserved vehicles stored on a segment is calculated as the difference between the number of vehicles on the segment and the number of vehicles that would be on the segment at the background density. The number of unserved vehicles stored on a segment is calculated using Equation A22-25.

$$UV(i-1, t, p) = NV(i-1, t, p) - [KB(i-1, p) * L(i-1)] \quad (A22-25)$$

A.4.3 Segment and Ramp Performance Measures (Exhibit A22-6, Steps 26 Through 30)

In the last time step of a time interval, the segment flows are averaged over the time interval and the measures of effectiveness for each segment are calculated. If there was no queue on a particular segment during the entire time interval, then the performance measures are calculated from the corresponding HCM 2000 method for that segment in Chapters 23 through 25. Since there are T time steps in an hour, the average segment flow rate in vehicles per hour in Time Interval (p) is calculated using Equation A22-26.

$$SF(i, p) = \frac{T}{S} \sum_{t=1}^S SF(i, t, p) \quad (A22-26)$$

Note that if T = 60 (1-min time step) and S = 15 (interval = 15 min), then T/S = 4. If there was a queue on the current segment in any time step during the time interval, then the segment performance measures are calculated in three steps. First, the average number of vehicles over a time interval is calculated for each segment using Equation A22-27.

$$NV(i, p) = \frac{1}{S} \sum_{t=1}^S NV(i, t, p) \quad (A22-27)$$

Next, the average segment density is calculated by taking the average number of vehicles (NV) for all time steps in the time interval and dividing it by the segment length using Equation A22-28.

$$K(i, p) = \frac{NV(i, p)}{L(i)} \quad (A22-28)$$

Next, the average speed on the current segment (i) during the current time interval (p) is calculated using Equation A22-29.

$$U(i, p) = \frac{SF(i, p)}{K(i, p)} \quad (A22-29)$$

Additional segment performance measures can be derived from the basic measures shown in Equations A22-26 through A22-28. Most prominent is segment delay, which can be computed as the difference in segment travel time at speed U(i, p) and at the segment free-flow speed.

The final segment performance measure is the length of the queue at the end of the time interval (i.e., Step S in Time Interval p). The length of a queue in meters on the segment is calculated using Equation A22-30.

$$Q(i, S, p) = \frac{UV(i, S, p)}{KQ(i, S, p) - KB(i, p)} * 1000 \quad (A22-30)$$

Queue length on on-ramps can also be calculated. A queue will form on the on-ramp roadway only if the flow is limited by a metering rate or by the merge area capacity. If the flow is limited by the ramp capacity, then unserved vehicles will be stored upstream of the ramp roadway, most likely a surface street. The methodology does not account for this delay, since vehicles cannot enter the ramp roadway. However, the unserved vehicles in this case are transferred as added demand in subsequent time intervals. If the queue is on the ramp roadway, the queue length is calculated by using the difference in background density and queue density. For an on-ramp, the background density is assumed to be the density at capacity and the queue density is calculated within Equation A22-31. For on-ramp queue length, Equation A22-31 is used.

$$ONRQL(i, S, p) = \frac{ONRQ(i, S, p)}{KJ - \frac{\min[RM(i, p), ONRO(i, S, p)] * (KJ - KC)}{ONRC(i, p)}} \quad (A22-31)$$

A.5 DIRECTIONAL FACILITY MODULE (EXHIBIT A22-6, STEP 36)

The previously discussed traffic performance measures can be aggregated over the length of the directional freeway facility, over the time duration of the study interval, or over the entire time-space domain. Each will be discussed in the following paragraphs.

Aggregating the estimated traffic performance measures over the entire length of the freeway facility provides facilitywide estimates for each time interval. Facilitywide travel times, vehicle (and person) distance of travel, and vehicle (and person) hours of travel and delay can be computed, and patterns of their variation over the connected time intervals can be assessed. The current computer implementation of the methodology is limited to 15-min time intervals and 1-min time steps.

Aggregating the estimated traffic performance measures over the time duration of the study interval provides an assessment of the performance of each segment along the freeway facility. Average and cumulative distributions of speed and density for each segment can be determined, and patterns of the variation over connected freeway segments can be compared. Average trip times, vehicle (and person) distance of travel, and vehicle (and person) hours of travel are easily assessed for each segment and compared.

Aggregating the estimated traffic performance measures over the entire time-space domain provides an overall assessment over the study interval time duration. Overall average speeds, average trip times, total vehicle (and person) distance traveled, and total vehicle (and person) hours of travel and delay are the most obvious overall traffic performance measures. Equations A22-32 through A22-35 show how some of the facilitywide MOEs are calculated.

Facility space-mean speed in Time Interval (p):

$$SMS(NS, p) = \frac{\sum_{i=1}^{NS} SF(i, p) * L(i)}{\sum_{i=1}^{NS} SF(i, p) * \frac{L(i)}{U(i, p)}} \quad (A22-32)$$

Average facility density in Time Interval (p):

$$K(NS, p) = \frac{\sum_{i=1}^{NS} K(i, p) * L(i)}{\sum_{i=1}^{NS} L(i)N(i, p)} \quad (A22-33)$$

Overall space-mean speed across all intervals:

$$SMS(NS, P) = \frac{\sum_{p=1}^P \sum_{i=1}^{NS} SF(i, p)L(i)}{\sum_{p=1}^P \sum_{i=1}^{NS} SF(i, p) \frac{L(i)}{U(i, p)}} \quad (A22-34)$$

Overall average density across all intervals:

$$K(NS, P) = \frac{\sum_{p=1}^P \sum_{i=1}^{NS} K(i, p) * L(i)}{\sum_{p=1}^P \sum_{i=1}^{NS} L(i)N(i, p)} \quad (A22-35)$$

REFERENCES

1. *A Policy on Geometric Design of Highways and Streets*. American Association of State Highway and Transportation Officials, Washington, D.C., 1994.
2. Newell, G. F. A Simplified Theory of Kinematic Waves in Highway Traffic, Part I: General Theory. *Transportation Research*, Vol. 27B, No. 4, 1993, pp. 281–287.
3. Newell, G. F. A Simplified Theory of Kinematic Waves in Highway Traffic, Part II: Queuing at Freeway Bottlenecks. *Transportation Research*, Vol. 27B, No. 4, 1993, pp. 289–303.
4. Newell, G. F. A Simplified Theory of Kinematic Waves in Highway Traffic, Part III: Multidestination Flows. *Transportation Research*, Vol. 27B, No. 4, 1993, pp. 305–313.
5. Newman, L. *Freeway Operations Analysis*. University of California Institute of Transportation Studies University Extension Course Notes, 1986.

CHAPTER 23**BASIC FREEWAY SEGMENTS****CONTENTS**

I.	INTRODUCTION	23-1
	Base Conditions for Basic Freeway Segments	23-1
	Limitations of the Methodology	23-1
II.	METHODOLOGY	23-2
	LOS	23-2
	Determining FFS	23-4
	BFFS	23-5
	Adjustment for Lane Width	23-5
	Adjustment for Lateral Clearance	23-5
	Adjustment for Number of Lanes	23-6
	Adjustment for Interchange Density	23-6
	Determining Flow Rate	23-7
	Peak-Hour Factor	23-7
	Heavy-Vehicle Adjustments	23-7
	Extended Freeway Segments	23-8
	Specific Grades	23-8
	Equivalents for Extended Freeway Segments	23-8
	Level Terrain	23-8
	Rolling Terrain	23-8
	Mountainous Terrain	23-9
	Equivalents for Specific Grades	23-9
	Equivalents for Specific Upgrades	23-9
	Equivalents for Specific Downgrades	23-11
	Equivalents for Composite Grades	23-11
	Driver Population Factor	23-11
	Determining LOS	23-12
	Sensitivity of Results to Input Variables	23-12
III.	APPLICATIONS	23-14
	Segmenting the Freeway	23-15
	Computational Steps	23-15
	Planning Applications	23-16
	Analysis Tools	23-17
IV.	EXAMPLE PROBLEMS	23-17
	Example Problem 1	23-18
	Example Problem 2	23-20
	Example Problem 3	23-22
	Example Problem 4	23-24
	Example Problem 5	23-26
V.	REFERENCES	23-27
	APPENDIX A. COMPOSITE GRADE	23-28
	APPENDIX B. WORKSHEET	23-30
	Basic Freeway Segments Worksheet	

EXHIBITS

Exhibit 23-1. Basic Freeway Segment Methodology 23-2

Exhibit 23-2. LOS Criteria for Basic Freeway Segments 23-3

Exhibit 23-3. Speed-Flow Curves and LOS for Basic Freeway Segments 23-4

Exhibit 23-4. Adjustments for Lane Width 23-5

Exhibit 23-5. Adjustments for Right-Shoulder Lateral Clearance 23-6

Exhibit 23-6. Adjustments for Number of Lanes 23-6

Exhibit 23-7. Adjustments for Interchange Density 23-7

Exhibit 23-8. Passenger-Car Equivalents on Extended Freeway Segments 23-9

Exhibit 23-9. Passenger-Car Equivalents for Trucks and Buses on Upgrades 23-10

Exhibit 23-10. Passenger-Car Equivalents for RVs on Upgrades 23-10

Exhibit 23-11. Passenger-Car Equivalents for Trucks and Buses
on Downgrades 23-11

Exhibit 23-12. Urban Freeway FFS and Interchange Spacing 23-12

Exhibit 23-13. Rural Freeway FFS 23-13

Exhibit 23-14. Freeway Speed-Flow and v/c Ratio 23-13

Exhibit 23-15. Urban Freeway Capacity and Interchange Spacing 23-14

Exhibit 23-16. Basic Freeway Segments Worksheet 23-16

Exhibit A23-1. Sample Solution for Composite Grade 23-29

Exhibit A23-2. Performance Curves for Trucks (120 kg/kW) 23-30

I. INTRODUCTION

The methodology in this chapter can be used to analyze the capacity, level of service (LOS), lane requirements, and effects of traffic and design features of basic freeway segments.

The methodology in this chapter is based on the results of an NCHRP study (1). The study used additional references to develop the methodology (2-11). Updates to the original methodology were subsequently developed (12).

BASE CONDITIONS FOR BASIC FREEWAY SEGMENTS

The base conditions under which the full capacity of a basic freeway segment is achieved are good weather, good visibility, and no incidents or accidents. For the analysis procedures in this chapter, these base conditions are assumed to exist. If any of these conditions fails to exist, the speed, LOS, and capacity of the freeway segment all tend to be reduced.

The specific speed-flow-density relationship of a basic freeway segment depends on prevailing traffic and roadway conditions. A set of base conditions for basic freeway segments has been established. These conditions serve as a starting point for the methodology in this chapter.

- Minimum lane widths of 3.6 m;
- Minimum right-shoulder lateral clearance between the edge of the travel lane and the nearest obstacle or object that influences traffic behavior of 1.8 m;
- Minimum median lateral clearance of 0.6 m;
- Traffic stream composed entirely of passenger cars;
- Five or more lanes for one direction (in urban areas only);
- Interchange spacing at 3 km or greater;
- Level terrain, with grades no greater than 2 percent; and
- A driver population composed principally of regular users of the facility.

These base conditions represent a high operating level, with a free-flow speed (FFS) of 110 km/h or greater.

LIMITATIONS OF THE METHODOLOGY

The methodology does not apply to or take into account (without modification by the analyst) the following:

- Special lanes reserved for a single vehicle type, such as high-occupancy vehicle (HOV) lanes, truck lanes, and climbing lanes;
- Extended bridge and tunnel segments;
- Segments near a toll plaza;
- Facilities with free-flow speeds below 90 km/h or in excess of 120 km/h;
- Demand conditions in excess of capacity (refer to Chapter 22 for further discussion);
- The influence of downstream blockages or queuing on a segment;
- Posted speed limit, the extent of police enforcement, or the presence of intelligent transportation systems features related to vehicle or driver guidance; or
- Capacity-enhancing effects of ramp metering.

The analyst would have to draw on other research information and develop special-purpose modifications of this methodology to incorporate the effects of the above conditions.

Background and concepts for this chapter are given in Chapter 13

Base conditions for freeway flow

II. METHODOLOGY

The methodology described in this chapter is for the analysis of basic freeway segments. A method for analysis of extended lengths of freeway that comprise a combination of basic segments, weaving segments, and ramp junctions is found in Chapter 22. Exhibit 23-1 illustrates input to and the basic computation order of the method for basic freeway segments. The primary output of the method is LOS.

EXHIBIT 23-1. BASIC FREEWAY SEGMENT METHODOLOGY

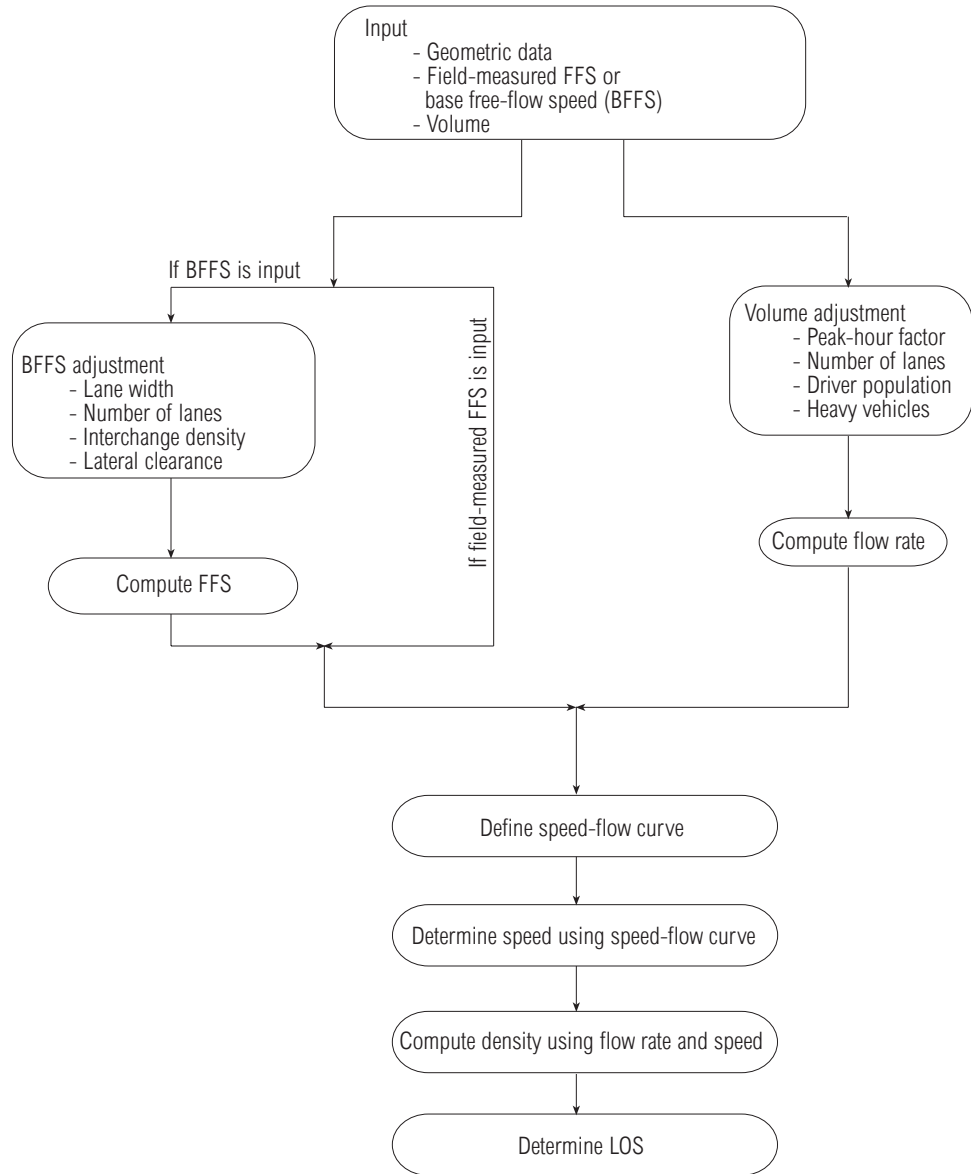

LOS

A basic freeway segment can be characterized by three performance measures: density in terms of passenger cars per kilometer per lane, speed in terms of mean passenger-car speed, and volume-to-capacity (v/c) ratio. Each of these measures is an indication of how well traffic flow is being accommodated by the freeway.

The measure used to provide an estimate of level of service is density. The three measures of speed, density, and flow or volume are interrelated. If values for two of these measures are known, the third can be computed.

Level-of-service thresholds for a basic freeway segment are summarized below.

LOS	Density Range (pc/km/ln)
A	0-7
B	> 7-11
C	> 11-16
D	> 16-22
E	> 22-28
F	> 28

Density is used to define LOS

For any given level of service, the maximum allowable density is somewhat lower than that for the corresponding level of service on multilane highways. This reflects the higher quality of service drivers expect when using freeways as compared with surface multilane facilities. This does not imply that an at-grade multilane highway will perform better than a freeway with the same number of lanes under similar conditions. For any given density, a freeway will carry higher flow rates at higher speeds than will a comparable multilane highway.

The specification of maximum densities for LOS A through D is based on the collective professional judgment of the members of the Committee on Highway Capacity and Quality of Service of the Transportation Research Board. The upper value shown for LOS E (28 pc/km/ln) is the maximum density at which sustained flows at capacity are expected to occur.

LOS criteria for basic freeway segments are given in Exhibit 23-2 for free-flow speeds of 120 km/h or greater, 110 km/h, 100 km/h, and 90 km/h. To be within a given LOS, the density criterion must be met. In effect, under base conditions, these are the speeds and flow rates expected to occur at the density shown for each LOS.

Density greater than 28 pc/km/ln (LOS F) indicates a queue that extends into the segment

EXHIBIT 23-2. LOS CRITERIA FOR BASIC FREEWAY SEGMENTS

Criteria	LOS				
	A	B	C	D	E
FFS = 120 km/h					
Maximum density (pc/km/ln)	7	11	16	22	28
Minimum speed (km/h)	120.0	120.0	114.6	99.6	85.7
Maximum v/c	0.35	0.55	0.77	0.92	1.00
Maximum service flow rate (pc/h/ln)	840	1320	1840	2200	2400
FFS = 110 km/h					
Maximum density (pc/km/ln)	7	11	16	22	28
Minimum speed (km/h)	110.0	110.0	108.5	97.2	83.9
Maximum v/c	0.33	0.51	0.74	0.91	1.00
Maximum service flow rate (pc/h/ln)	770	1210	1740	2135	2350
FFS = 100 km/h					
Maximum density (pc/km/ln)	7	11	16	22	28
Minimum speed (km/h)	100.0	100.0	100.0	93.8	82.1
Maximum v/c	0.30	0.48	0.70	0.90	1.00
Maximum service flow rate (pc/h/ln)	700	1100	1600	2065	2300
FFS = 90 km/h					
Maximum density (pc/km/ln)	7	11	16	22	28
Minimum speed (km/h)	90.0	90.0	90.0	89.1	80.4
Maximum v/c	0.28	0.44	0.64	0.87	1.00
Maximum service flow rate (pc/h/ln)	630	990	1440	1955	2250

Note:

The exact mathematical relationship between density and v/c has not always been maintained at LOS boundaries because of the use of rounded values. Density is the primary determinant of LOS. The speed criterion is the speed at maximum density for a given LOS.

Failure, breakdown, congestion, and LOS F occur when queues begin to form on the freeway. Density tends to increase sharply within the queue and may be considerably higher than the maximum value of 28 pc/km/ln for LOS E. Further guidance on analysis of basic freeway segments with densities greater than 28 pc/km/ln is provided in Chapter 22.

Exhibit 23-3 shows the relationship between speed, flow, and density for basic freeway segments. It also shows the definition of the various LOS on the basis of density boundary values.

EXHIBIT 23-3. SPEED-FLOW CURVES AND LOS FOR BASIC FREEWAY SEGMENTS

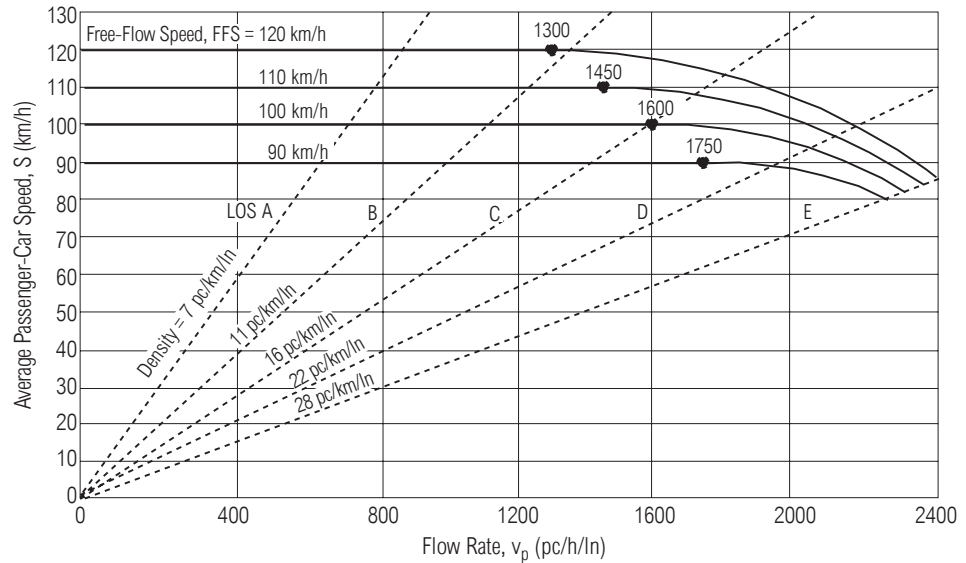

Note:
Capacity varies by free-flow speed. Capacity is 2400, 2350, 2300, and 2250 pc/h/ln at free-flow speeds of 120, 110, 100, and 90 km/h, respectively.

For $90 \leq \text{FFS} \leq 120$ and for flow rate (v_p)
 $(3100 - 15\text{FFS}) < v_p \leq (1800 + 5\text{FFS})$,

$$S = \text{FFS} - \left[\frac{1}{28} (23\text{FFS} - 1800) \left(\frac{v_p + 15\text{FFS} - 3100}{20\text{FFS} - 1300} \right)^{2.6} \right]$$

For $90 \leq \text{FFS} \leq 120$ and
 $v_p \leq (3100 - 15\text{FFS})$,
 $S = \text{FFS}$

DETERMINING FFS

FFS is the mean speed of passenger cars measured during low to moderate flows (up to 1,300 pc/h/ln). For a specific segment of freeway, speeds are virtually constant in this range of flow rates. Two methods can be used to determine the FFS of a basic freeway segment: field measurement and estimation with guidelines provided in this chapter. The field-measurement procedure is provided for users who prefer to gather these data directly. However, field measurements are not required for application of the method. If field-measured data are used, no adjustments are made to the free-flow speed.

The speed study should be conducted at a location that is representative of the segment when flows and densities are low (flow rates may be up to 1,300 pc/h/ln). Weekday off-peak hours are generally good times to observe low to moderate flow rates. The speed study should measure the speeds of all passenger cars or use a systematic sample (e.g., every 10th passenger car). The speed study should measure passenger-car speeds across all lanes. A sample of at least 100 passenger-car speeds should be obtained. Any speed measurement technique that has been found acceptable for other types of traffic engineering speed studies may be used. Further guidance on the conduct

Measure or estimate the FFS

Measurement of free-flow speed

of speed studies is found in standard traffic engineering publications, such as the *Manual of Traffic Engineering Studies* published by the Institute of Transportation Engineers.

The average of all passenger-car speeds measured in the field under low- to moderate-volume conditions can be used directly as the FFS of the freeway segment. This speed reflects the net effect of all conditions at the study site that influence speed, including those considered in this method (lane width, lateral clearance, interchange density, and number of lanes) as well as others such as speed limit and vertical and horizontal alignment. Speed data that include both passenger cars and heavy vehicles can be used for level terrain or moderate downgrades but should not be used for rolling or mountainous terrain.

If field measurement of FFS is not possible, FFS can be estimated indirectly on the basis of the physical characteristics of the freeway segment being studied. The physical characteristics include lane width, number of lanes, right-shoulder lateral clearance, and interchange density. Equation 23-1 is used to estimate the free-flow speed of a basic freeway segment:

$$FFS = BFFS - f_{LW} - f_{LC} - f_N - f_{ID} \quad (23-1)$$

where

- FFS = free-flow speed (km/h);
- $BFFS$ = base free-flow speed, 110 km/h (urban) or 120 km/h (rural);
- f_{LW} = adjustment for lane width from Exhibit 23-4 (km/h);
- f_{LC} = adjustment for right-shoulder lateral clearance from Exhibit 23-5 (km/h);
- f_N = adjustment for number of lanes from Exhibit 23-6 (km/h); and
- f_{ID} = adjustment for interchange density from Exhibit 23-7 (km/h).

BFFS

Estimation of FFS for an existing or future freeway segment is accomplished by adjusting a base free-flow speed downward to reflect the influence of four factors: lane width, lateral clearance, number of lanes, and interchange density. Thus, the analyst is required to select an appropriate BFFS as a starting point.

Adjustment for Lane Width

The base condition for lane width is 3.6 m or greater. When the average lane width across all lanes is less than 3.6 m, the base free-flow speed (e.g., 120 km/h) is reduced. Adjustments to reflect the effect of narrower average lane width are given in Exhibit 23-4.

EXHIBIT 23-4. ADJUSTMENTS FOR LANE WIDTH

Lane Width (m)	Reduction in Free-Flow Speed, f_{LW} (km/h)
3.6	0.0
3.5	1.0
3.4	2.1
3.3	3.1
3.2	5.6
3.1	8.1
3.0	10.6

Adjustment for Lateral Clearance

Base lateral clearance is 1.8 m or greater on the right side and 0.6 m or greater on the median or left side, measured from the edge of the paved shoulder to the nearest edge of

Estimate free-flow speed if measurement is not possible

Adjustment for lateral clearance reflects only the right-shoulder width

the traveled lane. When the right-shoulder lateral clearance is less than 1.8 m, the BFFS is reduced. Adjustments to reflect the effect of narrower right-shoulder lateral clearance are given in Exhibit 23-5. No adjustments are available to reflect the effect of median lateral clearance less than 0.6 m. Lateral clearance less than 0.6 m on either the right or left side of a freeway is considered rare. Considerable judgment must be used in determining whether objects or barriers along the right side of a freeway present a true obstruction. Such obstructions may be continuous, such as retaining walls, concrete barriers, or guardrails, or may be noncontinuous, such as light supports or bridge abutments. In some cases, drivers may become accustomed to certain types of obstructions, in which case their influence on traffic flow may be negligible.

EXHIBIT 23-5. ADJUSTMENTS FOR RIGHT-SHOULDER LATERAL CLEARANCE

Right-Shoulder Lateral Clearance (m)	Reduction in Free-Flow Speed, f_{LC} (km/h)			
	Lanes in One Direction			
	2	3	4	≥ 5
≥ 1.8	0.0	0.0	0.0	0.0
1.5	1.0	0.7	0.3	0.2
1.2	1.9	1.3	0.7	0.4
0.9	2.9	1.9	1.0	0.6
0.6	3.9	2.6	1.3	0.8
0.3	4.8	3.2	1.6	1.1
0.0	5.8	3.9	1.9	1.3

Adjustment for number of lanes (not applicable to rural freeway segments)

Adjustment for Number of Lanes

Freeway segments with five or more lanes (in one direction) are considered as having base conditions with respect to number of lanes. When fewer lanes are present, the BFFS is reduced. Exhibit 23-6 provides adjustments to reflect the effect of number of lanes on BFFS. In determining number of lanes, only mainline lanes, both basic and auxiliary, should be considered. HOV lanes should not be included.

EXHIBIT 23-6. ADJUSTMENTS FOR NUMBER OF LANES

Number of Lanes (One Direction)	Reduction in Free-Flow Speed, f_N (km/h)
≥ 5	0.0
4	2.4
3	4.8
2	7.3

Note: For all rural freeway segments, f_N is 0.0.

The adjustments in Exhibit 23-6 are based exclusively on data collected on urban and suburban freeways and do not reflect conditions on rural freeways, which typically carry two lanes in each direction. In using Equation 23-1 to estimate the FFS of a rural freeway segment, the value of the adjustment for number of lanes, f_N , should be 0.0.

Adjustment for Interchange Density

The base interchange density is 0.3 interchanges per kilometer, or 3.3-km interchange spacing. Base free-flow speed is reduced when interchange density becomes greater. Adjustments to reflect the effect of interchange density are provided in Exhibit 23-7. Interchange density is determined over a 10-km segment of freeway (5 km upstream and 5 km downstream) in which the freeway segment is located. An interchange is defined as having at least one on-ramp. Therefore, interchanges that have only off-ramps would not be considered in determining interchange density. Interchanges

A 10-km segment is used to determine interchange density

considered should include typical interchanges with arterials or highways and major freeway-to-freeway interchanges.

EXHIBIT 23-7. ADJUSTMENTS FOR INTERCHANGE DENSITY

Interchanges per Kilometer	Reduction in Free-Flow Speed, f_{ID} (km/h)
≤ 0.3	0.0
0.4	1.1
0.5	2.1
0.6	3.9
0.7	5.0
0.8	6.0
0.9	8.1
1.0	9.2
1.1	10.2
1.2	12.1

DETERMINING FLOW RATE

The hourly flow rate must reflect the influence of heavy vehicles, the temporal variation of traffic flow over an hour, and the characteristics of the driver population. These effects are reflected by adjusting hourly volumes or estimates, typically reported in vehicles per hour (veh/h), to arrive at an equivalent passenger-car flow rate in passenger cars per hour (pc/h). The equivalent passenger-car flow rate is calculated using the heavy-vehicle and peak-hour adjustment factors and is reported on a per lane basis (pc/h/ln). Equation 23-2 is used to calculate the equivalent passenger-car flow rate.

$$v_p = \frac{V}{PHF * N * f_{HV} * f_p} \quad (23-2)$$

where

- v_p = 15-min passenger-car equivalent flow rate (pc/h/ln),
- V = hourly volume (veh/h),
- PHF = peak-hour factor,
- N = number of lanes,
- f_{HV} = heavy-vehicle adjustment factor, and
- f_p = driver population factor.

Convert veh/h to pc/h using heavy-vehicle, peak-hour, and driver population factors

Peak-Hour Factor

The peak-hour factor (PHF) represents the variation in traffic flow within an hour. Observations of traffic flow consistently indicate that the flow rates found in the peak 15-min period within an hour are not sustained throughout the entire hour. The application of the peak-hour factor in Equation 23-2 accounts for this phenomenon.

On freeways, typical PHFs range from 0.80 to 0.95. Lower PHFs are characteristic of rural freeways or off-peak conditions. Higher factors are typical of urban and suburban peak-hour conditions. Field data should be used, if possible, to develop PHFs representative of local conditions.

Heavy-Vehicle Adjustments

Freeway traffic volumes that include a mix of vehicle types must be adjusted to an equivalent flow rate expressed in passenger cars per hour per lane. This adjustment is made using the factor f_{HV} . Once the values of E_T and E_R are found, the adjustment factor, f_{HV} , is determined by using Equation 23-3.

$$f_{HV} = \frac{1}{1 + P_T(E_T - 1) + P_R(E_R - 1)} \quad (23-3)$$

where

- E_T, E_R = passenger-car equivalents for trucks/buses and recreational vehicles (RVs) in the traffic stream, respectively;
- P_T, P_R = proportion of trucks/buses and RVs in the traffic stream, respectively; and
- f_{HV} = heavy-vehicle adjustment factor.

Adjustments for heavy vehicles in the traffic stream apply for three vehicle types: trucks, buses, and RVs. There is no evidence to indicate distinct differences in performance between trucks and buses on freeways, and therefore trucks and buses are treated identically.

In many cases, trucks will be the only heavy-vehicle type present in the traffic stream to a significant degree. Where the percentage of RVs is small compared with the percentage of trucks, it is sometimes convenient to consider all heavy vehicles to be trucks. It is generally acceptable to do this where the percentage of trucks and buses is at least five times the percentage of RVs.

The factor f_{HV} is found using a two-step process. First, the passenger-car equivalent for each truck/bus and RV is found for the traffic and roadway conditions under study. These equivalency values, E_T and E_R , represent the number of passenger cars that would use the same amount of freeway capacity as one truck/bus or RV, respectively, under prevailing roadway and traffic conditions. Second, using the values of E_T and E_R and the proportion of each type of vehicle in the traffic stream (P_T and P_R), the adjustment factor f_{HV} is computed.

The effect of heavy vehicles on traffic flow depends on grade conditions as well as traffic composition. Passenger-car equivalents can be selected for one of three conditions: extended freeway segments, upgrades, and downgrades.

Extended Freeway Segments

It is often appropriate to consider an extended length of freeway containing a number of upgrades, downgrades, and level segments as a single uniform segment. This is possible where no one grade is long enough or steep enough to have a significant effect on the operation of the overall segment. As a guideline, extended segment analysis can be used where no one grade of 3 percent or greater is longer than 0.5 km or where no one grade of less than 3 percent is longer than 1.0 km.

Specific Grades

Any grade less than 3 percent that is longer than 1.0 km or any grade of 3 percent or more that is longer than 0.5 km must be analyzed as a separate segment because of its significant effect on traffic flow.

Equivalents for Extended Freeway Segments

Whenever extended segment analysis is used, the terrain of the freeway must be classified as level, rolling, or mountainous.

Level Terrain

Level terrain is any combination of grades and horizontal or vertical alignment that permits heavy vehicles to maintain the same speed as passenger cars. This type of terrain includes short grades of no more than 2 percent.

Rolling Terrain

Rolling terrain is any combination of grades and horizontal or vertical alignment that causes heavy vehicles to reduce their speeds substantially below those of passenger cars

Extended segment—use when no one grade (3 percent or greater) is longer than 0.5 km. Use when no one grade (less than 3 percent) is longer than 1 km.

but that does not cause heavy vehicles to operate at crawl speeds for any significant length of time or at frequent intervals.

Crawl speed is the maximum sustained speed that trucks can maintain on an extended upgrade of a given percent. If any grade is long enough, trucks will be forced to decelerate to the crawl speed, which they will then be able to maintain for extended distances. Appendix A contains truck performance curves illustrating crawl speed and length of grade.

Appendix A shows truck performance curves

Mountainous Terrain

Mountainous terrain is any combination of grades and horizontal or vertical alignment that causes heavy vehicles to operate at crawl speeds for significant distances or at frequent intervals.

Exhibit 23-8 gives passenger-car equivalents for extended freeway segments. Note that it is extremely difficult to have mountainous terrain as defined herein without violating the guidelines for using the general terrain methodology (i.e., having no grade greater than 3 percent longer than 0.5 km). To a lesser extent, the same statement may be made with respect to rolling terrain. The equivalence values shown in Exhibit 23-8 are most useful in the planning stage of analysis, when specific alignments are not known but approximate capacity computations are still needed.

EXHIBIT 23-8. PASSENGER-CAR EQUIVALENTS ON EXTENDED FREEWAY SEGMENTS

Factor	Type of Terrain		
	Level	Rolling	Mountainous
E_T (trucks and buses)	1.5	2.5	4.5
E_R (RVs)	1.2	2.0	4.0

Equivalents for Specific Grades

Any freeway grade of more than 1.0 km for grades less than 3 percent or 0.5 km for grades of 3 percent or more should be considered as a separate segment. Analysis of such segments must consider the upgrade and downgrade conditions and whether the grade is a single and isolated grade of constant percentage or part of a series forming a composite grade.

Several studies have indicated that freeway truck populations have an average weight-to-power ratio of between 75 and 90 kg/kW. These procedures adopt passenger-car equivalents calibrated for a mix of trucks/buses in this range. RVs vary considerably in both type and characteristics. These vehicles include everything from cars with trailers to self-contained mobile campers. In addition to the variability of the vehicles, the drivers are not professionals, and their degree of skill in handling such vehicles varies. Typical weight-to-power ratios of RVs range from 20 to 40 kg/kW.

Equivalents for Specific Upgrades

Exhibits 23-9 and 23-10 give values of E_T and E_R for upgrade segments. These factors vary with the percent of grade, length of grade, and the proportion of heavy vehicles in the traffic stream. The maximum values of E_T and E_R occur when there are only a few heavy vehicles. The equivalents decrease as the number of heavy vehicles increases, because these vehicles tend to form platoons and have operating characteristics that are more uniform as a group than those of passenger cars.

The length of grade is generally taken from a profile of the highway in question and typically includes the straight portion of the grade plus some portion of the vertical curves at the beginning and end of the grade. It is recommended that 25 percent of the length of the vertical curves at the beginning and end of the grade be included in the length of the grade. Where two consecutive upgrades are present, 50 percent of the length of the vertical curve between them is assigned to the length of each upgrade.

Establishing length of grade

EXHIBIT 23-9. PASSENGER-CAR EQUIVALENTS FOR TRUCKS AND BUSES ON UPGRADES

Upgrade (%)	Length (km)	E_T								
		Percentage of Trucks and Buses								
		2	4	5	6	8	10	15	20	25
< 2	All	1.5	1.5	1.5	1.5	1.5	1.5	1.5	1.5	1.5
≥ 2-3	0.0-0.4	1.5	1.5	1.5	1.5	1.5	1.5	1.5	1.5	1.5
	> 0.4-0.8	1.5	1.5	1.5	1.5	1.5	1.5	1.5	1.5	1.5
	> 0.8-1.2	1.5	1.5	1.5	1.5	1.5	1.5	1.5	1.5	1.5
	> 1.2-1.6	2.0	2.0	2.0	2.0	1.5	1.5	1.5	1.5	1.5
	> 1.6-2.4	2.5	2.5	2.5	2.5	2.0	2.0	2.0	2.0	2.0
	> 2.4	3.0	3.0	2.5	2.5	2.0	2.0	2.0	2.0	2.0
> 3-4	0.0-0.4	1.5	1.5	1.5	1.5	1.5	1.5	1.5	1.5	1.5
	> 0.4-0.8	2.0	2.0	2.0	2.0	2.0	2.0	1.5	1.5	1.5
	> 0.8-1.2	2.5	2.5	2.0	2.0	2.0	2.0	2.0	2.0	2.0
	> 1.2-1.6	3.0	3.0	2.5	2.5	2.5	2.5	2.0	2.0	2.0
	> 1.6-2.4	3.5	3.5	3.0	3.0	3.0	3.0	2.5	2.5	2.5
	> 2.4	4.0	3.5	3.0	3.0	3.0	3.0	2.5	2.5	2.5
> 4-5	0.0-0.4	1.5	1.5	1.5	1.5	1.5	1.5	1.5	1.5	1.5
	> 0.4-0.8	3.0	2.5	2.5	2.5	2.0	2.0	2.0	2.0	2.0
	> 0.8-1.2	3.5	3.0	3.0	3.0	2.5	2.5	2.5	2.5	2.5
	> 1.2-1.6	4.0	3.5	3.5	3.5	3.0	3.0	3.0	3.0	3.0
	> 1.6	5.0	4.0	4.0	4.0	3.5	3.5	3.0	3.0	3.0
	> 1.6	5.0	4.0	4.0	4.0	3.5	3.5	3.0	3.0	3.0
> 5-6	0.0-0.4	2.0	2.0	1.5	1.5	1.5	1.5	1.5	1.5	1.5
	> 0.4-0.5	4.0	3.0	2.5	2.5	2.0	2.0	2.0	2.0	2.0
	> 0.5-0.8	4.5	4.0	3.5	3.0	2.5	2.5	2.5	2.5	2.5
	> 0.8-1.2	5.0	4.5	4.0	3.5	3.0	3.0	3.0	3.0	3.0
	> 1.2-1.6	5.5	5.0	4.5	4.0	3.0	3.0	3.0	3.0	3.0
	> 1.6	6.0	5.0	5.0	4.5	3.5	3.5	3.5	3.5	3.5
> 6	0.0-0.4	4.0	3.0	2.5	2.5	2.5	2.5	2.0	2.0	2.0
	> 0.4-0.5	4.5	4.0	3.5	3.5	3.5	3.0	2.5	2.5	2.5
	> 0.5-0.8	5.0	4.5	4.0	4.0	3.5	3.0	2.5	2.5	2.5
	> 0.8-1.2	5.5	5.0	4.5	4.5	4.0	3.5	3.0	3.0	3.0
	> 1.2-1.6	6.0	5.5	5.0	5.0	4.5	4.0	3.5	3.5	3.5
	> 1.6	7.0	6.0	5.5	5.5	5.0	4.5	4.0	4.0	4.0

EXHIBIT 23-10. PASSENGER-CAR EQUIVALENTS FOR RVs ON UPGRADES

Upgrade (%)	Length (km)	E_R								
		Percentage of RVs								
		2	4	5	6	8	10	15	20	25
≤ 2	All	1.2	1.2	1.2	1.2	1.2	1.2	1.2	1.2	1.2
> 2-3	0.0-0.8	1.2	1.2	1.2	1.2	1.2	1.2	1.2	1.2	1.2
	> 0.8	3.0	1.5	1.5	1.5	1.5	1.5	1.2	1.2	1.2
> 3-4	0.0-0.4	1.2	1.2	1.2	1.2	1.2	1.2	1.2	1.2	1.2
	> 0.4-0.8	2.5	2.5	2.0	2.0	2.0	2.0	1.5	1.5	1.5
	> 0.8	3.0	2.5	2.5	2.5	2.0	2.0	2.0	1.5	1.5
> 4-5	0.0-0.4	2.5	2.0	2.0	2.0	1.5	1.5	1.5	1.5	1.5
	> 0.4-0.8	4.0	3.0	3.0	3.0	2.5	2.5	2.0	2.0	2.0
	> 0.8	4.5	3.5	3.0	3.0	3.0	2.5	2.5	2.0	2.0
> 5	0.0-0.4	4.0	3.0	2.5	2.5	2.5	2.0	2.0	2.0	1.5
	> 0.4-0.8	6.0	4.0	4.0	3.5	3.0	3.0	2.5	2.5	2.0
	> 0.8	6.0	4.5	4.0	4.5	3.5	3.0	3.0	2.5	2.0

In analyzing upgrades, the point of interest is usually the end of the grade, where heavy vehicles presumably have the maximum effect on operations. This is not always the case, however. If a ramp junction is located midgrade, the point of the merge or diverge will also be a critical point for analysis. In the case of composite grades, the point at which heavy vehicles are traveling slowest is the critical point for analysis. If a 5 percent upgrade is followed by a 2 percent upgrade, it is reasonable to assume that the end of the 5 percent portion will be critical, since heavy vehicles would be expected to accelerate on the 2 percent portion of the grade.

Equivalents for Specific Downgrades

There are few specific data on the effect of heavy vehicles on traffic flow on downgrades. In general, if the downgrade does not cause trucks to shift into a low gear, they may be treated as if they were level terrain segments, and passenger-car equivalents are selected accordingly. Where more severe downgrades occur, trucks must often use low gears to avoid gaining too much speed and running out of control. In such cases, their effect is greater than it would be on level terrain. Exhibit 23-11 gives values of E_T . For RVs, downgrades may be treated as level terrain.

For RVs, downgrades may be treated as level terrain

EXHIBIT 23-11. PASSENGER-CAR EQUIVALENTS FOR TRUCKS AND BUSES ON DOWNGRADES

Downgrade (%)	Length (km)	E_T			
		Percentage of Trucks			
		5	10	15	20
< 4	All	1.5	1.5	1.5	1.5
4-5	≤ 6.4	1.5	1.5	1.5	1.5
4-5	> 6.4	2.0	2.0	2.0	1.5
> 5-6	≤ 6.4	1.5	1.5	1.5	1.5
> 5-6	> 6.4	5.5	4.0	4.0	3.0
> 6	≤ 6.4	1.5	1.5	1.5	1.5
> 6	> 6.4	7.5	6.0	5.5	4.5

Equivalents for Composite Grades

The vertical alignment of most freeways results in a continuous series of grades. It is often necessary to determine the effect of a series of significant grades in succession. The most straightforward technique is to compute the average grade to the point in question. The average grade is defined as the total rise from the beginning of the composite grade divided by the length of the grade.

The average grade technique is an acceptable approach for grades in which all subsections are less than 4 percent or the total length of the composite grade is less than 1,200 m. For more severe composite grades, a detailed technique is presented in Appendix A. This technique uses vehicle performance curves and equivalent speeds to determine the equivalent simple grade for analysis.

Appendix A gives a detailed composite grade technique

Driver Population Factor

The traffic stream characteristics that are the basis of this methodology are representative of regular drivers in a substantially commuter traffic stream or in a stream in which most drivers are familiar with the facility. It is generally accepted that traffic streams with different characteristics (i.e., recreational drivers) use freeways less efficiently. Whereas data are sparse and reported results vary substantially, significantly lower capacities have been reported on weekends, particularly in recreational areas. It may generally be assumed that the reduction in capacity (LOS E) extends to service volumes for other levels of service as well.

The adjustment factor f_p is used to reflect this effect. The values of f_p range from 0.85 to 1.00. In general, the analyst should select 1.00, which reflects commuter traffic (i.e., familiar users), unless there is sufficient evidence that a lower value should be applied. Where greater accuracy is needed, comparative field studies of commuter and recreational traffic flow and speeds are recommended.

DETERMINING LOS

The first step in determining LOS of a basic freeway segment is to define and segment the freeway facility as appropriate. Second, on the basis of estimated or field-measured FFS, an appropriate speed-flow curve of the same shape as the typical curves (Exhibit 23-3) is constructed. On the basis of the flow rate, v_p , and the constructed speed-flow curve, an average passenger-car speed is read on the y-axis of Exhibit 23-3. The next step is to calculate density using Equation 23-4.

$$D = \frac{v_p}{S} \tag{23-4}$$

where

- D = density (pc/km/ln),
- v_p = flow rate (pc/h/ln), and
- S = average passenger-car speed (km/h).

LOS of the basic freeway segment is then determined by comparing the calculated density with the density ranges in Exhibit 23-2.

SENSITIVITY OF RESULTS TO INPUT VARIABLES

Downstream conditions may cause backups that result in low speeds and low volumes. The basic freeway segment methodology cannot be applied in such circumstances.

Analysts will note that there is no direct way to calibrate the estimated capacity of the basic freeway segment with field conditions. The analyst must instead calibrate the estimated free-flow speed and demand adjustments with field conditions. Field measurements of density can be used to determine LOS directly.

The FFS for urban freeways is sensitive to the average interchange spacing and the number of lanes in one direction. The sensitivity increases with the number of lanes. Exhibit 23-12 can be used to determine the FFS given the number of lanes in one direction and the average distance between freeway interchanges.

EXHIBIT 23-12. URBAN FREEWAY FFS AND INTERCHANGE SPACING
(SEE FOOTNOTE FOR ASSUMED VALUES)

Number of Lanes	Free-Flow Speed (km/h)			
	Interchange Spacing (km)			
	1.00	1.25	2.00	3.00
2	94	97	101	103
3	96	99	103	105
4	98	102	106	108
5	99	104	108	110

Note:
Assumptions: BFFS = 110 km/h, lane width = 3.6 m, lateral clearance = 1.8 m.

The FFS for rural freeways is sensitive to the average interchange spacing for spacing under 1.0 km. Exhibit 23-13 can be used to determine the FFS for rural freeways given the average interchange spacing.

EXHIBIT 23-13. RURAL FREEWAY FFS
(SEE FOOTNOTE FOR ASSUMED VALUES)

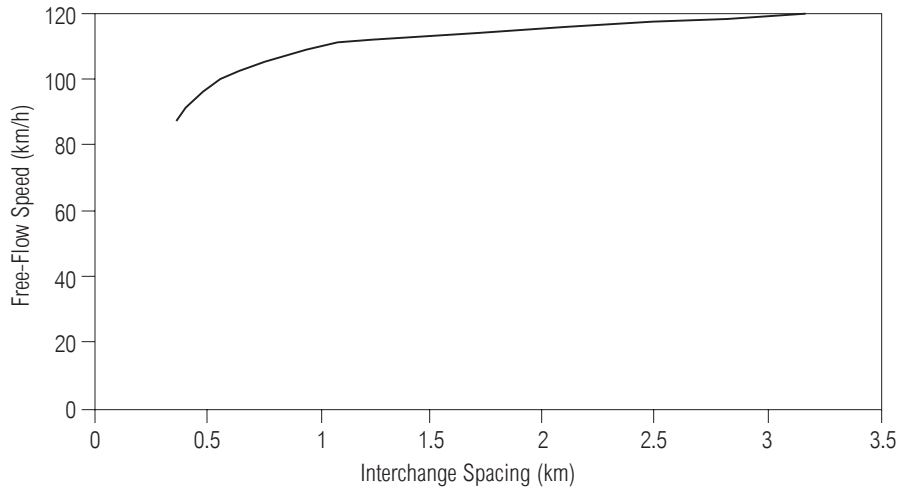

Note:
Assumptions: BFFS = 120 km/h, lane width = 3.6 m, lateral clearance = 1.8 m.

The v/c ratio has relatively little effect on speed until it exceeds 54 to 80 percent, depending on FFS. FFS (which is sensitive to lane width, shoulder width, number of lanes, and interchange spacing) has more effect on mean speed at low v/c ratios than the v/c ratio itself (see Exhibit 23-14).

EXHIBIT 23-14. FREEWAY SPEED-FLOW AND v/c RATIO

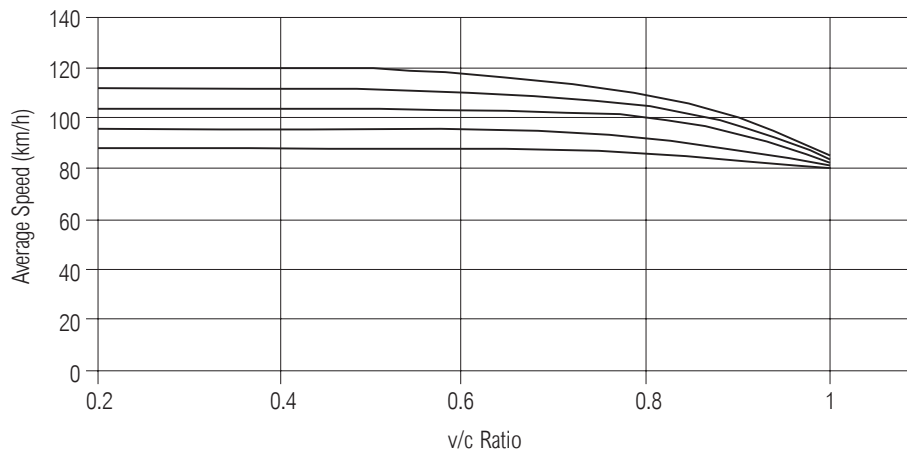

For a rural freeway, the capacity per lane is 2,400 pc/h/ln, based on the assumption that rural freeways have interchange spacing of greater than 3.0 km and two lanes in one direction. Exhibit 23-15 can be used to determine capacity for urban freeways with shorter interchange spacing or a different number of lanes.

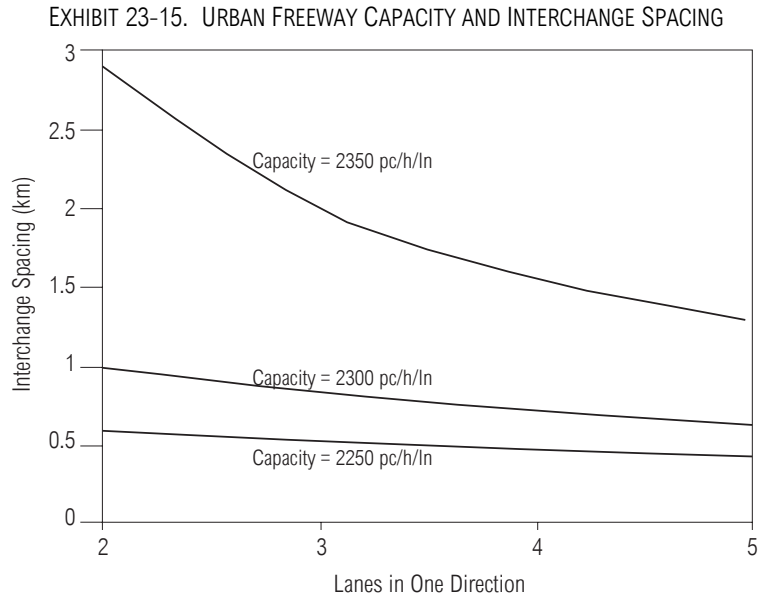

Guidelines on required inputs and estimated values are given in Chapter 13, "Freeway Concepts"

III. APPLICATIONS

The methodology of this chapter can be used to analyze the capacity and LOS of basic freeway segments. The analyst must address two fundamental questions. First, the primary output must be identified. Primary outputs typically solved for in a variety of applications include LOS, number of lanes required (N), and flow rate achievable (v_p). Performance measures related to density (D) and speed (S) are also achievable but are considered secondary outputs.

Second, the analyst must identify the default values or estimated values for use in the analysis. Basically, the analyst has three sources of input data:

1. Default values found in this manual,
2. Estimates and locally derived default values developed by the user, and
3. Values derived from field measurements and observation.

A value for each input variable must be supplied to calculate the outputs, both primary and secondary.

A common application of the method is to compute the LOS of an existing segment or a changed facility in the near term or distant future. This type of application is often termed operational, and its primary output is LOS, with secondary outputs for density and speed. Another application is to check the adequacy of or to recommend the number of lanes for a basic freeway segment given the volume or flow rate and LOS goal. This type of application is termed design, since its primary output is the number of lanes required to serve the assumed conditions. Other outputs from this application include speed and density. Finally, the achievable flow rate, v_p , can be calculated as a primary output. This analysis requires an LOS goal and a number of lanes as inputs and typically estimates the flow rate that will cause the highway to operate at an unacceptable LOS.

Another general type of analysis can be termed planning. This type of analysis uses estimates, HCM default values, and local default values as inputs in the calculation. LOS, number of lanes, or flow rate can be determined as outputs along with the secondary outputs of density and speed. The difference between planning analysis and operational or design analysis is that most or all of the input values in planning analysis come from estimates or default values, but the operational and design analyses tend to use field measurements or known values for most or all of the input variables. Note that for

each of the analyses, FFS, either measured or estimated, is required as an input in the computation.

SEGMENTING THE FREEWAY

Capacity or LOS analysis requires that the freeway segment have uniform traffic conditions and roadway characteristics. Thus, a point at which there is a change in either the traffic or roadway conditions typically represents an endpoint of the analysis segment.

A number of locations on a freeway form natural boundaries of uniform segments. Any on-ramp or off-ramp is such a boundary, since the volume of freeway traffic changes. The beginning and end of simple or composite grades also act as boundaries. Any point at which the traffic or roadway conditions change should be used as a boundary between uniform segments, each of which should be analyzed separately.

In addition to the natural boundaries created by on-ramps and off-ramps, the following conditions generally dictate that the freeway segment under analysis be segmented:

- Change in the number of lanes,
- Change in the right-shoulder lateral clearance,
- Grade change of 2 percent or more or constant upgrade longer than 1200 m, and
- Change in speed limit.

COMPUTATIONAL STEPS

The basic freeway segments worksheet for computations is shown in Exhibit 23-16. The analyst provides general information and site information for all applications.

For operational (LOS) analysis, all speed and flow data are entered as inputs. Equivalent flow is then computed with the aid of the exhibits for passenger-car equivalents. FFS is estimated by adjusting a base FFS. Finally, LOS is determined by entering (with v_p) the speed-flow graph at the top of the worksheet and intersecting the specific curve that has been selected or constructed for the freeway segment.

This point of intersection identifies the LOS and (on the vertical axis of the graph) the estimated speed, S . If the analyst requires a value for density (D), it is calculated as v_p/S .

The key to design analysis for number of lanes (N) is establishing an hourly volume. All information, with the exception of number of lanes, can be entered in the flow input and speed input portion of the worksheet (see Exhibit 23-16). An FFS, either computed or measured directly, is entered on the worksheet. The appropriate curve representing the FFS is established on the graph. The required or desired LOS is also entered. Then the analyst assumes N and computes flow, v_p , with the aid of the exhibits for passenger-car equivalents. LOS is determined by entering the speed-flow graph with v_p at the top of the worksheet. Then, the derived LOS is compared with the desired LOS. This process is then repeated, adding one lane to the previously assumed number of lanes, until the determined LOS matches or is better than the desired LOS. Density is calculated using v_p and S .

The objective of design analysis for flow rate, v_p , is to estimate the flow rate in passenger cars per hour per lane given a set of traffic, roadway, and FFS conditions. A desired LOS is entered on the worksheet. Then, the FFS of the segment is established using either the BFFS and the four adjustment factors or an FFS measured in the field. Once this facility speed-flow curve is established, the analyst can determine what flow rate is achievable with the given LOS. This would be considered the maximum flow rate achievable or allowable for the given level. The average passenger-car speed is also directly available from the graph. Finally, if required, a value for density can be directly calculated, using the flow rate and the average speed.

Operational (LOS)

Design (N)

Design (v_p)

EXHIBIT 23-16. BASIC FREEWAY SEGMENTS WORKSHEET

BASIC FREEWAY SEGMENTS WORKSHEET

Application	Input	Output
Operational (LOS)	FFS, N, v _p	LOS, S, D
Design (N)	FFS, LOS, v _p	N, S, D
Design (v _p)	FFS, LOS, N	v _p , S, D
Planning (LOS)	FFS, N, AADT	LOS, S, D
Planning (N)	FFS, LOS, AADT	N, S, D
Planning (v _p)	FFS, LOS, N	v _p , S, D

General Information		Site Information	
Analyst _____	_____	Highway/Direction of Travel _____	_____
Agency or Company _____	_____	From/To _____	_____
Date Performed _____	_____	Jurisdiction _____	_____
Analysis Time Period _____	_____	Analysis Year _____	_____
<input type="checkbox"/> Operational (LOS)	<input type="checkbox"/> Design (N)	<input type="checkbox"/> Design (v _p)	<input type="checkbox"/> Planning (LOS)
<input type="checkbox"/> Planning (N)	<input type="checkbox"/> Planning (v _p)		
Flow Inputs			
Volume, V _____ veh/h	_____	Peak-hour factor, PHF _____	_____
Annual avg. daily traffic, AADT _____ veh/day	_____	% Trucks and buses, P _T _____	_____
Peak-hour proportion of AADT, K _____	_____	% RVs, P _R _____	_____
Peak-hour direction proportion, D _____	_____	General terrain	
DDHV = AADT * K * D _____ veh/h	_____	<input type="checkbox"/> Level <input type="checkbox"/> Rolling <input type="checkbox"/> Mountainous	
Driver type <input type="checkbox"/> Commuter/Weekday <input type="checkbox"/> Recreational/Weekend		Grade Length _____ km Up/Down _____ %	
Calculate Flow Adjustments			
f _p _____	_____	E _R _____	_____
E _T _____	_____	f _{HV} = $\frac{1}{1 + P_T(E_T - 1) + P_R(E_R - 1)}$	_____
Speed Inputs		Calculate Speed Adjustments and FFS	
Lane width _____ m	_____	f _{LW} _____ km/h	_____
Rt-shoulder lateral clearance _____ m	_____	f _{LC} _____ km/h	_____
Interchange density _____ /km	_____	f _{ID} _____ km/h	_____
Number of lanes, N _____	_____	f _N _____ km/h	_____
FFS (measured) _____ km/h	_____	FFS = BFFS - f _{LW} - f _{LC} - f _{ID} - f _N	_____ km/h
Base free-flow speed, BFFS _____ km/h	_____		
LOS and Performance Measures			
<u>Operational (LOS) or Planning (LOS)</u>		<u>Design (N) or Planning (N) 1st Iteration</u>	
v _p = $\frac{V \text{ or DDHV}}{PHF * N * f_{HV} * f_p}$ _____ pc/h/ln	_____	N _____	assumed
S _____ km/h	_____	v _p = $\frac{V \text{ or DDHV}}{PHF * N * f_{HV} * f_p}$ _____ pc/h/ln	_____
D = v _p / S _____ pc/km/ln	_____	LOS _____	_____
LOS _____	_____		
<u>Design (v_p) or Planning (v_p)</u>		<u>Design (N) or Planning (N) 2nd Iteration</u>	
LOS _____	_____	N _____	assumed
v _p _____ pc/h/ln	_____	v _p = $\frac{V \text{ or DDHV}}{PHF * N * f_{HV} * f_p}$ _____ pc/h/ln	_____
V = v _p * PHF * N * f _{HV} * f _p _____ veh/h	_____	S _____ km/h	_____
S _____ km/h	_____	D = v _p / S _____ pc/km/ln	_____
D = v _p / S _____ pc/km/ln	_____	LOS _____	_____
Glossary		Factor Location	
N - Number of lanes	S - Speed	E _R - Exhibits 23-8, 23-10	f _{LW} - Exhibit 23-4
V - Hourly volume	D - Density	E _T - Exhibits 23-8, 23-9, 23-11	f _{LC} - Exhibit 23-5
v _p - Flow rate	FFS - Free-flow speed	f _p - Page 23-12	f _N - Exhibit 23-6
LOS - Level of service	BFFS - Base free-flow speed	LOS, S, FFS, v _p - Exhibits 23-2, 23-3	f _{ID} - Exhibit 23-7
DDHV - Directional design-hour volume			

PLANNING APPLICATIONS

Planning (LOS)
 Planning (v_p)
 Planning (N)

The three planning applications—planning for LOS, flow rate (v_p), and number of lanes (N)—correspond directly to the procedures described for operations and design. The primary criterion categorizing these as planning applications is the use of estimates, HCM default values, and local default values as inputs into the calculations. The use of annual average daily traffic (AADT) to estimate directional design-hour volume (DDHV)

also characterizes a planning application. (For guidelines on computing DDHV, refer to Chapter 8.)

To perform planning applications, the analyst typically has few, if any, of the required input values. Chapter 13 contains more information on the use of default values.

ANALYSIS TOOLS

The basic freeway segments worksheet shown in Exhibit 23-16 and provided in Appendix B can be used to perform all applications, including operational for LOS; design for flow rate, v_p , and number of lanes, N ; and planning for LOS, v_p , and N .

IV. EXAMPLE PROBLEMS

Problem No.	Description	Application
1	Find LOS for an existing four-lane freeway	Operational (LOS)
2	Find number of lanes for a suburban freeway	Design (N)
3	Find LOS for an existing six-lane urban freeway, and find LOS that occurs in 3 years. Also find when the freeway will exceed capacity	Operational (LOS), Planning (LOS), and Planning (N)
4	Find LOS for an upgrade and a downgrade on an existing four-lane freeway	Operational (LOS)
5	Find opening-day demand volumes and number of lanes for a new urban freeway facility	Planning (LOS) and Planning (v_p)

EXAMPLE PROBLEM 1

The Freeway Existing four-lane freeway, rural area, very restricted geometry, rolling terrain, 110-km/h speed limit.

The Question What is the LOS during the peak hour?

The Facts

- √ Two lanes in each direction,
- √ 3.3-m lane width,
- √ 0.6-m lateral clearance,
- √ Commuter traffic,
- √ 2,000-veh/h peak-hour volume (one direction),
- √ 5 percent trucks,
- √ 0.92 PHF,
- √ 0.6 interchanges per kilometer, and
- √ Rolling terrain.

Comments

- √ Assume 0 percent buses and RVs since none are indicated.
- √ Assume BFFS of 120 km/h for rural areas.
- √ Assume that the number of lanes does not affect free-flow speed, since the freeway is in a rural area.
- √ Assume $f_p = 1.00$ for commuter traffic.

Outline of Solution All input parameters are known. Demand is computed in terms of passenger cars per hour per lane, an FFS is estimated, and the LOS is determined from the speed-flow graph. An estimate of passenger-car speed is determined from the graph, and a value of density is calculated using speed and flow rate. The calculation of speed is based on the equation found in Exhibit 23-3.

Steps

1. Convert volume (veh/h) to flow rate (pc/h/ln) (use Equation 23-2).	$v_p = \frac{V}{(PHF)(N)(f_{HV})(f_p)}$ $v_p = \frac{2,000}{(0.92)(2)(f_{HV})(1.00)}$
2. Find f_{HV} (use Exhibit 23-8 and Equation 23-3).	$f_{HV} = \frac{1}{1 + P_T(E_T - 1) + P_R(E_R - 1)}$ $f_{HV} = \frac{1}{1 + 0.05(2.5 - 1) + 0}$ $f_{HV} = 0.930$
3. Find v_p (use Equation 23-2).	$v_p = \frac{2,000}{(0.92)(2)(0.930)(1.00)} = 1,169 \text{ pc/h/ln}$
4. Compute free-flow speed (use Exhibits 23-4, 23-5, 23-6, 23-7, and Equation 23-1).	$FFS = BFFS - f_{LW} - f_{LC} - f_N - f_{ID}$ $FFS = 120 - 3.1 - 3.9 - 0.0 - 3.9$ $FFS = 109.1 \text{ km/h}$
5. Determine level of service (use Exhibit 23-2).	LOS B

The Results

LOS = B,
 Speed = 109 km/h, and
 Density = 11 pc/km/ln.

Example Problem 1

BASIC FREEWAY SEGMENTS WORKSHEET																								
		<table border="1" style="width: 100%; border-collapse: collapse;"> <thead> <tr> <th>Application</th> <th>Input</th> <th>Output</th> </tr> </thead> <tbody> <tr> <td>Operational (LOS)</td> <td>FFS, N, v_p</td> <td>LOS, S, D</td> </tr> <tr> <td>Design (N)</td> <td>FFS, LOS, v_p</td> <td>N, S, D</td> </tr> <tr> <td>Design (v_p)</td> <td>FFS, LOS, N</td> <td>v_p, S, D</td> </tr> <tr> <td>Planning (LOS)</td> <td>FFS, N, AADT</td> <td>LOS, S, D</td> </tr> <tr> <td>Planning (N)</td> <td>FFS, LOS, AADT</td> <td>N, S, D</td> </tr> <tr> <td>Planning (v_p)</td> <td>FFS, LOS, N</td> <td>v_p, S, D</td> </tr> </tbody> </table>		Application	Input	Output	Operational (LOS)	FFS, N, v _p	LOS, S, D	Design (N)	FFS, LOS, v _p	N, S, D	Design (v _p)	FFS, LOS, N	v _p , S, D	Planning (LOS)	FFS, N, AADT	LOS, S, D	Planning (N)	FFS, LOS, AADT	N, S, D	Planning (v _p)	FFS, LOS, N	v _p , S, D
Application	Input	Output																						
Operational (LOS)	FFS, N, v _p	LOS, S, D																						
Design (N)	FFS, LOS, v _p	N, S, D																						
Design (v _p)	FFS, LOS, N	v _p , S, D																						
Planning (LOS)	FFS, N, AADT	LOS, S, D																						
Planning (N)	FFS, LOS, AADT	N, S, D																						
Planning (v _p)	FFS, LOS, N	v _p , S, D																						
General Information		Site Information																						
Analyst: <u>WLL</u>		Highway/Direction of Travel: _____																						
Agency or Company: <u>CEI</u>		From/To: _____																						
Date Performed: <u>4/12/99</u>		Jurisdiction: _____																						
Analysis Time Period: _____		Analysis Year: <u>1999</u>																						
<input checked="" type="checkbox"/> Operational (LOS) <input type="checkbox"/> Design (N) <input type="checkbox"/> Design (v _p) <input type="checkbox"/> Planning (LOS) <input type="checkbox"/> Planning (N) <input type="checkbox"/> Planning (v _p)																								
Flow Inputs																								
Volume, V: <u>2000</u> veh/h		Peak-hour factor, PHF: <u>0.92</u>																						
Annual avg. daily traffic, AADT: _____ veh/day		% Trucks and buses, P _T : <u>5</u>																						
Peak-hour proportion of AADT, K: _____		% RVs, P _R : <u>0</u>																						
Peak-hour direction proportion, D: _____		General terrain																						
DDHV = AADT * K * D: _____ veh/h		<input type="checkbox"/> Level <input checked="" type="checkbox"/> Rolling <input type="checkbox"/> Mountainous																						
Driver type: <input checked="" type="checkbox"/> Commuter/Weekday <input type="checkbox"/> Recreational/Weekend		Grade Length: _____ km Up/Down: _____ %																						
Calculate Flow Adjustments																								
f _p : <u>1.00</u>		E _R : <u>2.0</u>																						
E _T : <u>2.5</u>		$f_{HV} = \frac{1}{1 + P_T(E_T - 1) + P_R(E_R - 1)}$: <u>0.930</u>																						
Speed Inputs		Calculate Speed Adjustments and FFS																						
Lane width: <u>3.3</u> m		f _{LW} : <u>3.1</u> km/h																						
RL-shoulder lateral clearance: <u>0.6</u> m		f _{LC} : <u>3.9</u> km/h																						
Interchange density: <u>0.6</u> I/km		f _{ID} : <u>3.9</u> km/h																						
Number of lanes, N: <u>2</u>		f _N : <u>0.0</u> km/h																						
FFS (measured): _____ km/h		FFS = BFFS - f _{LW} - f _{LC} - f _{ID} - f _N : <u>109.1</u> km/h																						
Base free-flow speed, BFFS: <u>120</u> km/h																								
LOS and Performance Measures																								
Operational (LOS) or Planning (LOS)		Design (N) or Planning (N) 1st Iteration																						
$v_p = \frac{V \text{ or } DDHV}{PHF * N * f_{HV} * f_p}$: <u>1169</u> pc/h/ln		N: _____ assumed																						
S: <u>109.1</u> km/h		$v_p = \frac{V \text{ or } DDHV}{PHF * N * f_{HV} * f_p}$: _____ pc/h/ln																						
D = v _p /S: <u>10.7</u> pc/km/ln		LOS: _____																						
LOS: <u>B</u>																								
Design (v_p) or Planning (v_p)		Design (N) or Planning (N) 2nd Iteration																						
LOS: _____		N: _____ assumed																						
v _p : _____ pc/h/ln		$v_p = \frac{V \text{ or } DDHV}{PHF * N * f_{HV} * f_p}$: _____ pc/h/ln																						
V = v _p * PHF * N * f _{HV} * f _p : _____ veh/h		S: _____ km/h																						
S: _____ km/h		D = v _p /S: _____ pc/km/ln																						
D = v _p /S: _____ pc/km/ln		LOS: _____																						
Glossary		Factor Location																						
N - Number of lanes	S - Speed	E _R - Exhibits 23-8, 23-10	f _{LW} - Exhibit 23-4																					
V - Hourly volume	D - Density	E _T - Exhibits 23-8, 23-9, 23-11	f _{LC} - Exhibit 23-5																					
v _p - Flow rate	FFS - Free-flow speed	f _p - Page 23-12	f _N - Exhibit 23-6																					
LOS - Level of service	BFFS - Base free-flow speed	LOS, S, FFS, v _p - Exhibits 23-2, 23-3	f _{ID} - Exhibit 23-7																					
DDHV - Directional design-hour volume																								

EXAMPLE PROBLEM 2

The Freeway New suburban freeway is being designed.

The Question How many lanes are needed to provide LOS D during the peak hour?

The Facts

- √ 4,000 veh/h (one direction),
- √ Level terrain,
- √ 15 percent trucks,
- √ 3.6-m lane width,
- √ 0.85 PHF,
- √ 0.9 interchanges per kilometer,
- √ 3 percent RVs, and
- √ 1.8-m lateral clearance.

Comments

- √ Assume commuter traffic. Thus, $f_p = 1.00$.
- √ Assume BFFS of 120 km/h.
- √ Assume that the number of lanes affects free-flow speed, since the freeway is being designed in a suburban area.

Outline of Solution All input parameters are known. Flow rate, speed, density, and LOS are calculated starting with a four-lane freeway and then increasing the number of lanes to six, eight, and so forth until LOS D is achieved. The calculation of speed is based on the equation found in Exhibit 23-3.

Steps

1. Convert volume (veh/h) to flow rate (pc/h/ln) (use Equation 23-2).	$v_p = \frac{V}{(PHF)(N)(f_{HV})(f_p)}$
2. Find f_{HV} (use Exhibit 23-8 and Equation 23-3).	$f_{HV} = \frac{1}{1 + P_T(E_T - 1) + P_R(E_R - 1)}$ $f_{HV} = \frac{1}{1 + (0.15)(1.5 - 1) + 0.03(1.2 - 1)}$ $f_{HV} = 0.925$
3. For four-lane option (use Equation 23-2).	$v_p = \frac{4,000}{(0.85)(2)(0.925)(1.00)} = 2,544 \text{ pc/h/ln}$
4. The four-lane option is not acceptable since 2544 pc/h/ln exceeds capacity of 2400 pc/h/ln.	
5. For six-lane option (use Equation 23-2).	$v_p = \frac{4,000}{(0.85)(3)(0.925)(1.00)} = 1,696 \text{ pc/h/ln}$
6. Compute free-flow speed for a six-lane freeway (use Exhibits 23-4, 23-5, 23-6, 23-7, and Equation 23-1).	$FFS = BFFS - f_{LW} - f_{LC} - f_N - f_{ID}$ $FFS = 120 - 0.0 - 0.0 - 4.8 - 8.1$ $FFS = 107.1 \text{ km/h}$
7. Determine level of service (use Exhibit 23-2).	LOS C

The Results

Six lanes are needed,
 LOS = C,
 Speed = 107 km/h, and
 Density = 16 pc/km/ln.

Example Problem 2

BASIC FREEWAY SEGMENTS WORKSHEET																								
		<table border="1" style="width: 100%; border-collapse: collapse;"> <thead> <tr> <th>Application</th> <th>Input</th> <th>Output</th> </tr> </thead> <tbody> <tr> <td>Operational (LOS)</td> <td>FFS, N, v_p</td> <td>LOS, S, D</td> </tr> <tr> <td>Design (N)</td> <td>FFS, LOS, v_p</td> <td>N, S, D</td> </tr> <tr> <td>Design (v_p)</td> <td>FFS, LOS, N</td> <td>v_p, S, D</td> </tr> <tr> <td>Planning (LOS)</td> <td>FFS, N, AADT</td> <td>LOS, S, D</td> </tr> <tr> <td>Planning (N)</td> <td>FFS, LOS, AADT</td> <td>N, S, D</td> </tr> <tr> <td>Planning (v_p)</td> <td>FFS, LOS, N</td> <td>v_p, S, D</td> </tr> </tbody> </table>		Application	Input	Output	Operational (LOS)	FFS, N, v_p	LOS, S, D	Design (N)	FFS, LOS, v_p	N, S, D	Design (v_p)	FFS, LOS, N	v_p , S, D	Planning (LOS)	FFS, N, AADT	LOS, S, D	Planning (N)	FFS, LOS, AADT	N, S, D	Planning (v_p)	FFS, LOS, N	v_p , S, D
Application	Input	Output																						
Operational (LOS)	FFS, N, v_p	LOS, S, D																						
Design (N)	FFS, LOS, v_p	N, S, D																						
Design (v_p)	FFS, LOS, N	v_p , S, D																						
Planning (LOS)	FFS, N, AADT	LOS, S, D																						
Planning (N)	FFS, LOS, AADT	N, S, D																						
Planning (v_p)	FFS, LOS, N	v_p , S, D																						
General Information		Site Information																						
Analyst: <u>JMYE</u> Agency or Company: <u>CEI</u> Date Performed: <u>4/14/99</u> Analysis Time Period: _____		Highway/Direction of Travel: _____ From/To: _____ Jurisdiction: _____ Analysis Year: <u>1999</u>																						
<input type="checkbox"/> Operational (LOS) <input checked="" type="checkbox"/> Design (N) <input type="checkbox"/> Design (v_p) <input type="checkbox"/> Planning (LOS) <input type="checkbox"/> Planning (N) <input type="checkbox"/> Planning (v_p)																								
Flow Inputs																								
Volume, V: <u>4000</u> veh/h Annual avg. daily traffic, AADT: _____ veh/day Peak-hour proportion of AADT, K: _____ Peak-hour direction proportion, D: _____ DDHV = AADT * K * D: _____ veh/h Driver type: <input checked="" type="checkbox"/> Commuter/Weekday <input type="checkbox"/> Recreational/Weekend		Peak-hour factor, PHF: <u>0.85</u> % Trucks and buses, P_T : <u>15</u> % RVs, P_R : <u>3</u> General terrain: <input checked="" type="checkbox"/> Level <input type="checkbox"/> Rolling <input type="checkbox"/> Mountainous Grade Length: _____ km Up/Down: _____ %																						
Calculate Flow Adjustments																								
f_p : <u>1.00</u> E_T : <u>1.5</u>		E_R : <u>1.2</u> $f_{HV} = \frac{1}{1 + P_T(E_T - 1) + P_R(E_R - 1)}$: <u>0.925</u>																						
Speed Inputs		Calculate Speed Adjustments and FFS																						
Lane width: <u>3.6</u> m Rt.-shoulder lateral clearance: <u>1.8</u> m Interchange density: <u>0.9</u> I/km Number of lanes, N: <u>2/3</u> FFS (measured): _____ km/h Base free-flow speed, BFFS: <u>120</u> km/h		f_{LW} : <u>0.0</u> km/h f_{LC} : <u>0.0</u> km/h f_{ID} : <u>8.1</u> km/h f_N : <u>7.3/4.8</u> km/h $FFS = BFFS - f_{LW} - f_{LC} - f_{ID} - f_N$: <u>104.6/107.1</u> km/h																						
LOS and Performance Measures																								
Operational (LOS) or Planning (LOS) $v_p = \frac{V \text{ or DDHV}}{PHF * N * f_{HV} * f_p}$: _____ pc/h/ln S: _____ km/h D = v_p / S : _____ pc/km/ln LOS: _____		Design (N) or Planning (N) 1st Iteration N: <u>2</u> assumed $v_p = \frac{V \text{ or DDHV}}{PHF * N * f_{HV} * f_p}$: <u>2544</u> pc/h/ln LOS: <u>oversaturated</u>																						
Design (v_p) or Planning (v_p) LOS: _____ v_p : _____ pc/h/ln V = $v_p * PHF * N * f_{HV} * f_p$: _____ veh/h S: _____ km/h D = v_p / S : _____ pc/km/ln		Design (N) or Planning (N) 2nd Iteration N: <u>3</u> assumed $v_p = \frac{V \text{ or DDHV}}{PHF * N * f_{HV} * f_p}$: <u>1696</u> pc/h/ln S: <u>106.5</u> km/h D = v_p / S : <u>15.9</u> pc/km/ln LOS: <u>C</u>																						
Glossary		Factor Location																						
N - Number of lanes V - Hourly volume v_p - Flow rate LOS - Level of service DDHV - Directional design-hour volume		S - Speed D - Density FFS - Free-flow speed BFFS - Base free-flow speed E_R - Exhibits 23-8, 23-10 E_T - Exhibits 23-8, 23-9, 23-11 f_p - Page 23-12 LOS, S, FFS, v_p - Exhibits 23-2, 23-3 f_{LW} - Exhibit 23-4 f_{LC} - Exhibit 23-5 f_N - Exhibit 23-6 f_{ID} - Exhibit 23-7																						

EXAMPLE PROBLEM 3

The Freeway Existing six-lane freeway in a growing urban area.

The Question What is the current LOS during the peak hour? What LOS will occur in 3 years? When should a fourth lane be added in each direction to avoid an excess of demand over capacity?

The Facts

- √ 5,000 veh/h (one direction, existing);
- √ Level terrain;
- √ 5,600 veh/h (one direction, in 3 years);
- √ Beyond 3 years, traffic grows at 4 percent per year;
- √ 6 lanes;
- √ 10 percent trucks;
- √ 0.95 PHF; and
- √ FFS = 110 km/h (measured in field).

Comments

- √ Since no information is given on possible changes over time, assume that 10 percent trucks, PHF, and FFS remain constant.
- √ This problem deals with a variety of demand levels and can most easily be solved by computing the maximum volume that can be accommodated for each level of service.
- √ Assume 0 percent buses and RVs.
- √ Assume commuter traffic.

Outline of Solution The maximum volume (veh/h) for each LOS is computed, the demand volumes are compared, and a level of service is estimated.

Steps

1. Convert the maximum service flow rate (pc/h/ln) for each LOS to veh/h (use Equation 23-2).	$v_p = \frac{V}{(PHF)(N)(f_{HV})(f_p)}$ $V = v_p(PHF)(N)(f_{HV})(f_p)$
2. Find f_{HV} (use Equation 23-3 and Exhibit 23-8).	$f_{HV} = \frac{1}{1 + P_T(E_T - 1) + P_R(E_R - 1)}$ $f_{HV} = \frac{1}{1 + 0.10(1.5 - 1) + 0}$ $f_{HV} = 0.952$
3. Find maximum v_p for each LOS (use Exhibit 23-2).	LOS A, $v_p = 770$ pc/h/ln LOS B, $v_p = 1,210$ LOS C, $v_p = 1,740$ LOS D, $v_p = 2,135$ LOS E, $v_p = 2,350$
4. Compute V (veh/h) (use equation from Step 1 with $f_p = 1.00$).	LOS A, $V = 2,089$ veh/h LOS B, $V = 3,283$ LOS C, $V = 4,721$ LOS D, $V = 5,793$ LOS E, $V = 6,376$
5. Compare 5,000 veh/h and 5,600 veh/h with above, determine LOS.	
6. When traffic exceeds 6,376 veh/h, a fourth lane in each direction will be needed. A compounding equation is used.	$5,600(1.04^n) = 6,376$ $n = 3.3 \text{ years}$

The Results

LOS D (existing),
 LOS D (in 3 years), and
 A fourth lane will be needed in 3.3 years beyond the end of the first 3 years.

Example Problem 3

BASIC FREEWAY SEGMENTS WORKSHEET																																																		
<table border="1"> <thead> <tr> <th>Application</th> <th>Input</th> <th>Output</th> </tr> </thead> <tbody> <tr> <td>Operational (LOS)</td> <td>FFS, N, v_p</td> <td>LOS, S, D</td> </tr> <tr> <td>Design (N)</td> <td>FFS, LOS, v_p</td> <td>N, S, D</td> </tr> <tr> <td>Design (v_p)</td> <td>FFS, LOS, N</td> <td>v_p, S, D</td> </tr> <tr> <td>Planning (LOS)</td> <td>FFS, N, AADT</td> <td>LOS, S, D</td> </tr> <tr> <td>Planning (N)</td> <td>FFS, LOS, AADT</td> <td>N, S, D</td> </tr> <tr> <td>Planning (v_p)</td> <td>FFS, LOS, N</td> <td>v_p, S, D</td> </tr> </tbody> </table>		Application	Input	Output	Operational (LOS)	FFS, N, v _p	LOS, S, D	Design (N)	FFS, LOS, v _p	N, S, D	Design (v _p)	FFS, LOS, N	v _p , S, D	Planning (LOS)	FFS, N, AADT	LOS, S, D	Planning (N)	FFS, LOS, AADT	N, S, D	Planning (v _p)	FFS, LOS, N	v _p , S, D																												
Application	Input	Output																																																
Operational (LOS)	FFS, N, v _p	LOS, S, D																																																
Design (N)	FFS, LOS, v _p	N, S, D																																																
Design (v _p)	FFS, LOS, N	v _p , S, D																																																
Planning (LOS)	FFS, N, AADT	LOS, S, D																																																
Planning (N)	FFS, LOS, AADT	N, S, D																																																
Planning (v _p)	FFS, LOS, N	v _p , S, D																																																
<table border="1"> <thead> <tr> <th colspan="2">General Information</th> <th colspan="2">Site Information</th> </tr> </thead> <tbody> <tr> <td>Analyst</td> <td>JMYE</td> <td>Highway/Direction of Travel</td> <td></td> </tr> <tr> <td>Agency or Company</td> <td>CEI</td> <td>From/To</td> <td></td> </tr> <tr> <td>Date Performed</td> <td>4/15/99</td> <td>Jurisdiction</td> <td></td> </tr> <tr> <td>Analysis Time Period</td> <td></td> <td>Analysis Year</td> <td>1999/2002</td> </tr> </tbody> </table>			General Information		Site Information		Analyst	JMYE	Highway/Direction of Travel		Agency or Company	CEI	From/To		Date Performed	4/15/99	Jurisdiction		Analysis Time Period		Analysis Year	1999/2002																												
General Information		Site Information																																																
Analyst	JMYE	Highway/Direction of Travel																																																
Agency or Company	CEI	From/To																																																
Date Performed	4/15/99	Jurisdiction																																																
Analysis Time Period		Analysis Year	1999/2002																																															
<table border="1"> <thead> <tr> <th colspan="3">Flow Inputs</th> </tr> </thead> <tbody> <tr> <td>Volume, V</td> <td>5000/5600</td> <td>veh/h</td> </tr> <tr> <td>Annual avg. daily traffic, AADT</td> <td></td> <td>veh/day</td> </tr> <tr> <td>Peak-hour proportion of AADT, K</td> <td></td> <td></td> </tr> <tr> <td>Peak-hour direction proportion, D</td> <td></td> <td></td> </tr> <tr> <td>DDHV = AADT * K * D</td> <td></td> <td>veh/h</td> </tr> <tr> <td>Driver type</td> <td><input checked="" type="checkbox"/> Commuter/Weekday</td> <td><input type="checkbox"/> Recreational/Weekend</td> </tr> <tr> <td>Peak-hour factor, PHF</td> <td>0.95</td> <td></td> </tr> <tr> <td>% Trucks and buses, P_T</td> <td>10</td> <td></td> </tr> <tr> <td>% RVs, P_R</td> <td>0</td> <td></td> </tr> <tr> <td>General terrain</td> <td><input checked="" type="checkbox"/> Level</td> <td><input type="checkbox"/> Rolling <input type="checkbox"/> Mountainous</td> </tr> <tr> <td>Grade</td> <td>Length</td> <td>Up/Down</td> </tr> </tbody> </table>			Flow Inputs			Volume, V	5000/5600	veh/h	Annual avg. daily traffic, AADT		veh/day	Peak-hour proportion of AADT, K			Peak-hour direction proportion, D			DDHV = AADT * K * D		veh/h	Driver type	<input checked="" type="checkbox"/> Commuter/Weekday	<input type="checkbox"/> Recreational/Weekend	Peak-hour factor, PHF	0.95		% Trucks and buses, P _T	10		% RVs, P _R	0		General terrain	<input checked="" type="checkbox"/> Level	<input type="checkbox"/> Rolling <input type="checkbox"/> Mountainous	Grade	Length	Up/Down												
Flow Inputs																																																		
Volume, V	5000/5600	veh/h																																																
Annual avg. daily traffic, AADT		veh/day																																																
Peak-hour proportion of AADT, K																																																		
Peak-hour direction proportion, D																																																		
DDHV = AADT * K * D		veh/h																																																
Driver type	<input checked="" type="checkbox"/> Commuter/Weekday	<input type="checkbox"/> Recreational/Weekend																																																
Peak-hour factor, PHF	0.95																																																	
% Trucks and buses, P _T	10																																																	
% RVs, P _R	0																																																	
General terrain	<input checked="" type="checkbox"/> Level	<input type="checkbox"/> Rolling <input type="checkbox"/> Mountainous																																																
Grade	Length	Up/Down																																																
<table border="1"> <thead> <tr> <th colspan="3">Calculate Flow Adjustments</th> </tr> </thead> <tbody> <tr> <td>f_p</td> <td>1.00</td> <td></td> </tr> <tr> <td>E_T</td> <td>1.5</td> <td></td> </tr> <tr> <td>E_R</td> <td></td> <td></td> </tr> <tr> <td>f_{HV}</td> <td colspan="2"> $f_{HV} = \frac{1}{1 + P_T(E_T - 1) + P_R(E_R - 1)}$ </td> </tr> <tr> <td></td> <td></td> <td>0.952</td> </tr> </tbody> </table>			Calculate Flow Adjustments			f _p	1.00		E _T	1.5		E _R			f _{HV}	$f_{HV} = \frac{1}{1 + P_T(E_T - 1) + P_R(E_R - 1)}$				0.952																														
Calculate Flow Adjustments																																																		
f _p	1.00																																																	
E _T	1.5																																																	
E _R																																																		
f _{HV}	$f_{HV} = \frac{1}{1 + P_T(E_T - 1) + P_R(E_R - 1)}$																																																	
		0.952																																																
<table border="1"> <thead> <tr> <th colspan="2">Speed Inputs</th> <th colspan="2">Calculate Speed Adjustments and FFS</th> </tr> </thead> <tbody> <tr> <td>Lane width</td> <td></td> <td>f_{LW}</td> <td></td> </tr> <tr> <td>Rt-shoulder lateral clearance</td> <td></td> <td>f_{LC}</td> <td></td> </tr> <tr> <td>Interchange density</td> <td></td> <td>f_{ID}</td> <td></td> </tr> <tr> <td>Number of lanes, N</td> <td>3</td> <td>f_N</td> <td></td> </tr> <tr> <td>FFS (measured)</td> <td>110</td> <td>FFS = BFFS - f_{LW} - f_{LC} - f_{ID} - f_N</td> <td></td> </tr> <tr> <td>Base free-flow speed, BFFS</td> <td></td> <td></td> <td></td> </tr> </tbody> </table>			Speed Inputs		Calculate Speed Adjustments and FFS		Lane width		f _{LW}		Rt-shoulder lateral clearance		f _{LC}		Interchange density		f _{ID}		Number of lanes, N	3	f _N		FFS (measured)	110	FFS = BFFS - f _{LW} - f _{LC} - f _{ID} - f _N		Base free-flow speed, BFFS																							
Speed Inputs		Calculate Speed Adjustments and FFS																																																
Lane width		f _{LW}																																																
Rt-shoulder lateral clearance		f _{LC}																																																
Interchange density		f _{ID}																																																
Number of lanes, N	3	f _N																																																
FFS (measured)	110	FFS = BFFS - f _{LW} - f _{LC} - f _{ID} - f _N																																																
Base free-flow speed, BFFS																																																		
<table border="1"> <thead> <tr> <th colspan="4">LOS and Performance Measures</th> </tr> </thead> <tbody> <tr> <td colspan="2">Operational (LOS) or Planning (LOS)</td> <td colspan="2">Design (N) or Planning (N) 1st Iteration</td> </tr> <tr> <td>v_p = $\frac{V \text{ or DDHV}}{PHF * N * f_{HV} * f_p}$</td> <td></td> <td>N</td> <td>assumed</td> </tr> <tr> <td>S</td> <td></td> <td>v_p = $\frac{V \text{ or DDHV}}{PHF * N * f_{HV} * f_p}$</td> <td></td> </tr> <tr> <td>D = v_p/S</td> <td></td> <td>LOS</td> <td></td> </tr> <tr> <td>LOS</td> <td>D (existing)/D (in 3 years)</td> <td colspan="2">Design (N) or Planning (N) 2nd Iteration</td> </tr> <tr> <td>Design (v_p) or Planning (v_p)</td> <td></td> <td>N</td> <td>assumed</td> </tr> <tr> <td>LOS</td> <td>C/D/E</td> <td>v_p = $\frac{V \text{ or DDHV}}{PHF * N * f_{HV} * f_p}$</td> <td></td> </tr> <tr> <td>v_p</td> <td>1740/2135/2350</td> <td>S</td> <td></td> </tr> <tr> <td>V = v_p * PHF * N * f_{HV} * f_p</td> <td>4721/5793/6376</td> <td>D = v_p/S</td> <td></td> </tr> <tr> <td>S</td> <td></td> <td>LOS</td> <td></td> </tr> <tr> <td>D = v_p/S</td> <td></td> <td></td> <td></td> </tr> </tbody> </table>			LOS and Performance Measures				Operational (LOS) or Planning (LOS)		Design (N) or Planning (N) 1st Iteration		v _p = $\frac{V \text{ or DDHV}}{PHF * N * f_{HV} * f_p}$		N	assumed	S		v _p = $\frac{V \text{ or DDHV}}{PHF * N * f_{HV} * f_p}$		D = v _p /S		LOS		LOS	D (existing)/D (in 3 years)	Design (N) or Planning (N) 2nd Iteration		Design (v _p) or Planning (v _p)		N	assumed	LOS	C/D/E	v _p = $\frac{V \text{ or DDHV}}{PHF * N * f_{HV} * f_p}$		v _p	1740/2135/2350	S		V = v _p * PHF * N * f _{HV} * f _p	4721/5793/6376	D = v _p /S		S		LOS		D = v _p /S			
LOS and Performance Measures																																																		
Operational (LOS) or Planning (LOS)		Design (N) or Planning (N) 1st Iteration																																																
v _p = $\frac{V \text{ or DDHV}}{PHF * N * f_{HV} * f_p}$		N	assumed																																															
S		v _p = $\frac{V \text{ or DDHV}}{PHF * N * f_{HV} * f_p}$																																																
D = v _p /S		LOS																																																
LOS	D (existing)/D (in 3 years)	Design (N) or Planning (N) 2nd Iteration																																																
Design (v _p) or Planning (v _p)		N	assumed																																															
LOS	C/D/E	v _p = $\frac{V \text{ or DDHV}}{PHF * N * f_{HV} * f_p}$																																																
v _p	1740/2135/2350	S																																																
V = v _p * PHF * N * f _{HV} * f _p	4721/5793/6376	D = v _p /S																																																
S		LOS																																																
D = v _p /S																																																		
<table border="1"> <thead> <tr> <th colspan="2">Glossary</th> <th colspan="2">Factor Location</th> </tr> </thead> <tbody> <tr> <td>N - Number of lanes</td> <td>S - Speed</td> <td>E_R - Exhibits 23-8, 23-10</td> <td>f_{LW} - Exhibit 23-4</td> </tr> <tr> <td>V - Hourly volume</td> <td>D - Density</td> <td>E_T - Exhibits 23-8, 23-9, 23-11</td> <td>f_{LC} - Exhibit 23-5</td> </tr> <tr> <td>v_p - Flow rate</td> <td>FFS - Free-flow speed</td> <td>f_p - Page 23-12</td> <td>f_N - Exhibit 23-6</td> </tr> <tr> <td>LOS - Level of service</td> <td>BFFS - Base free-flow speed</td> <td>LOS, S, FFS, v_p - Exhibits 23-2, 23-3</td> <td>f_{ID} - Exhibit 23-7</td> </tr> <tr> <td>DDHV - Directional design-hour volume</td> <td></td> <td></td> <td></td> </tr> </tbody> </table>			Glossary		Factor Location		N - Number of lanes	S - Speed	E _R - Exhibits 23-8, 23-10	f _{LW} - Exhibit 23-4	V - Hourly volume	D - Density	E _T - Exhibits 23-8, 23-9, 23-11	f _{LC} - Exhibit 23-5	v _p - Flow rate	FFS - Free-flow speed	f _p - Page 23-12	f _N - Exhibit 23-6	LOS - Level of service	BFFS - Base free-flow speed	LOS, S, FFS, v _p - Exhibits 23-2, 23-3	f _{ID} - Exhibit 23-7	DDHV - Directional design-hour volume																											
Glossary		Factor Location																																																
N - Number of lanes	S - Speed	E _R - Exhibits 23-8, 23-10	f _{LW} - Exhibit 23-4																																															
V - Hourly volume	D - Density	E _T - Exhibits 23-8, 23-9, 23-11	f _{LC} - Exhibit 23-5																																															
v _p - Flow rate	FFS - Free-flow speed	f _p - Page 23-12	f _N - Exhibit 23-6																																															
LOS - Level of service	BFFS - Base free-flow speed	LOS, S, FFS, v _p - Exhibits 23-2, 23-3	f _{ID} - Exhibit 23-7																																															
DDHV - Directional design-hour volume																																																		

EXAMPLE PROBLEM 4

The Freeway Existing four-lane freeway in a rural area.

The Question What is the LOS for both the upgrade and the downgrade directions during the peak hour?

The Facts

- √ 2 lanes in each direction, √ 2,300 veh/h peak-hour volume (one direction),
- √ 15 percent trucks, √ Segment 1, 900 m at 3 percent grade, and
- √ 0.90 PHF, √ Segment 2, 800 m at 5 percent grade, and
- √ FFS = 115 km/h (measured in field, upgrade direction), √ FFS = 120 km/h (measured in field, downgrade direction).

Comments

- √ Assume 0 percent buses and RVs since none are indicated.
- √ The precise procedure for composite grades is used because there is a segment steeper than 4 percent and the total length is greater than 1200 m.
- √ Assume $f_p = 0.95$ because drivers are generally unfamiliar with the area.

Outline of Solution The truck performance curves in Appendix A are used to develop an equivalent grade (i.e., a constant grade that has the same effect on heavy vehicles as does the composite grade). Demand is computed in terms of passenger cars per hour per lane, and LOS is determined from the speed-flow graph. The calculation of speed is based on the equation found in Exhibit 23-3.

Steps

1. Determine equivalent constant grade (use Exhibit A23-2).	Using Appendix A, enter 900 m. Speed at top of 3 percent grade is 68 km/h. Intersection of horizontal at 68 km/h and 5 percent curve implies trucks have been on 5 percent for 375 m. A vertical is drawn at 1175 m to the 5 percent deceleration curve, and a horizontal shows a final truck speed of 42 km/h. A horizontal line at a speed of 42 km/h and a vertical line at 1700 m intersect at a composite grade of 5 percent. Similarly, the composite grade for the downgrade is computed as -1 percent.
2. Convert volume (veh/h) to flow rate (pc/h/ln) (use Equation 23-2).	$v_p = \frac{V}{(PHF)(N)(f_{HV})(f_p)}$
3. Find f_{HV} (upgrade) (Exhibit 23-9 and Equation 23-3).	$f_{HV} = \frac{1}{1 + P_T(E_T - 1) + P_R(E_R - 1)}$ $f_{HV} = \frac{1}{1 + 0.15(3.0 - 1) + 0} = 0.769$
4. Find f_{HV} (downgrade) (use Exhibit 23-11 and Equation 23-3).	$f_{HV} = \frac{1}{1 + 0.15(1.5 - 1) + 0} = 0.930$
5. Find v_p (upgrade) (use Equation 23-2).	$v_p = \frac{2,300}{(0.90)(2)(0.769)(0.95)} = 1,749 \text{ pc/h/ln}$
6. Find v_p (downgrade) (use Equation 23-2).	$v_p = \frac{2,300}{(0.90)(2)(0.930)(0.95)} = 1,446 \text{ pc/h/ln}$
7. Determine LOS (use Exhibit 23-2).	LOS C (upgrade and downgrade)

The Results

Upgrade
 LOS C,
 Speed = 113 km/h, and
 Density = 15 pc/km/ln.

Downgrade
 LOS C,
 Speed = 120 km/h, and
 Density = 12 pc/km/ln.

Example Problem 4

BASIC FREEWAY SEGMENTS WORKSHEET																								
		<table border="1"> <thead> <tr> <th>Application</th> <th>Input</th> <th>Output</th> </tr> </thead> <tbody> <tr> <td>Operational (LOS)</td> <td>FFS, N, v_p</td> <td>LOS, S, D</td> </tr> <tr> <td>Design (N)</td> <td>FFS, LOS, v_p</td> <td>N, S, D</td> </tr> <tr> <td>Design (v_p)</td> <td>FFS, LOS, N</td> <td>v_p, S, D</td> </tr> <tr> <td>Planning (LOS)</td> <td>FFS, N, AADT</td> <td>LOS, S, D</td> </tr> <tr> <td>Planning (N)</td> <td>FFS, LOS, AADT</td> <td>N, S, D</td> </tr> <tr> <td>Planning (v_p)</td> <td>FFS, LOS, N</td> <td>v_p, S, D</td> </tr> </tbody> </table>		Application	Input	Output	Operational (LOS)	FFS, N, v_p	LOS, S, D	Design (N)	FFS, LOS, v_p	N, S, D	Design (v_p)	FFS, LOS, N	v_p , S, D	Planning (LOS)	FFS, N, AADT	LOS, S, D	Planning (N)	FFS, LOS, AADT	N, S, D	Planning (v_p)	FFS, LOS, N	v_p , S, D
Application	Input	Output																						
Operational (LOS)	FFS, N, v_p	LOS, S, D																						
Design (N)	FFS, LOS, v_p	N, S, D																						
Design (v_p)	FFS, LOS, N	v_p , S, D																						
Planning (LOS)	FFS, N, AADT	LOS, S, D																						
Planning (N)	FFS, LOS, AADT	N, S, D																						
Planning (v_p)	FFS, LOS, N	v_p , S, D																						
General Information		Site Information																						
Analyst <u>JMYE</u> Agency or Company <u>CEI</u> Date Performed <u>5/16/99</u> Analysis Time Period _____		Highway/Direction of Travel _____ From/To _____ Jurisdiction _____ Analysis Year <u>1999</u>																						
<input checked="" type="checkbox"/> Operational (LOS) <input type="checkbox"/> Design (N) <input type="checkbox"/> Design (v_p) <input type="checkbox"/> Planning (LOS) <input type="checkbox"/> Planning (N) <input type="checkbox"/> Planning (v_p)																								
Flow Inputs																								
Volume, V <u>2300</u> veh/h Annual avg. daily traffic, AADT _____ veh/day Peak-hour proportion of AADT, K _____ Peak-hour direction proportion, D _____ DDHV = AADT * K * D _____ veh/h Driver type <input type="checkbox"/> Commuter/Weekday <input type="checkbox"/> Recreational/Weekend		Peak-hour factor, PHF <u>0.90</u> % Trucks and buses, P_T <u>15</u> % RVs, P_R <u>0</u> General terrain <input type="checkbox"/> Level <input type="checkbox"/> Rolling <input type="checkbox"/> Mountainous Grade Length <u>1.7</u> km Up/Down <u>5/-1</u> %																						
Calculate Flow Adjustments																								
f_p <u>0.95</u> E_T <u>3.0/1.5</u>		E_R _____ $f_{HV} = \frac{1}{1 + P_T(E_T - 1) + P_R(E_R - 1)}$ <u>0.769/0.930</u>																						
Speed Inputs		Calculate Speed Adjustments and FFS																						
Lane width _____ m Rt.-shoulder lateral clearance _____ m Interchange density _____ l/km Number of lanes, N <u>2</u> FFS (measured) <u>115/120</u> km/h Base free-flow speed, BFFS _____ km/h		f_{LW} _____ km/h f_{LC} _____ km/h f_{ID} _____ km/h f_N _____ km/h $FFS = BFFS - f_{LW} - f_{LC} - f_{ID} - f_N$ _____ km/h																						
LOS and Performance Measures																								
Operational (LOS) or Planning (LOS) $v_p = \frac{V \text{ or DDHV}}{PHF * N * f_{HV} * f_p}$ <u>1749/1446</u> pc/h/ln S <u>112.7/119.8</u> km/h $D = v_p / S$ <u>15.5/12.1</u> pc/km/ln LOS <u>C/C</u>		Design (N) or Planning (N) 1st Iteration N _____ assumed $v_p = \frac{V \text{ or DDHV}}{PHF * N * f_{HV} * f_p}$ _____ pc/h/ln LOS _____																						
Design (v_p) or Planning (v_p) LOS _____ v_p _____ pc/h/ln $V = v_p * PHF * N * f_{HV} * f_p$ _____ veh/h S _____ km/h $D = v_p / S$ _____ pc/km/ln		Design (N) or Planning (N) 2nd Iteration N _____ assumed $v_p = \frac{V \text{ or DDHV}}{PHF * N * f_{HV} * f_p}$ _____ pc/h/ln S _____ km/h $D = v_p / S$ _____ pc/km/ln LOS _____																						
Glossary		Factor Location																						
N - Number of lanes V - Hourly volume v_p - Flow rate LOS - Level of service DDHV - Directional design-hour volume		S - Speed D - Density FFS - Free-flow speed BFFS - Base free-flow speed E_R - Exhibits 23-8, 23-10 E_T - Exhibits 23-8, 23-9, 23-11 f_p - Page 23-12 LOS, S, FFS, v_p - Exhibits 23-2, 23-3																						
		f_{LW} - Exhibit 23-4 f_{LC} - Exhibit 23-5 f_N - Exhibit 23-6 f_{ID} - Exhibit 23-7																						

EXAMPLE PROBLEM 5

The Freeway New urban facility being planned with a forecast opening-day AADT of 75,000 veh/day.

The Question What is the minimum number of lanes needed to provide at least LOS D during the peak hour on opening day? What are the speed and density of traffic for the proposed number of lanes?

The Facts

- √ 75,000 veh/day,
- √ $K = 0.090$,
- √ Directional split = 55/45, and
- √ Rolling terrain.

Comments

- √ Several input variables (FFS, PHF, percent trucks) are not given. Reasonable default values are selected as FFS = 110 km/h (in lieu of field measurement), PHF = 0.90, 10 percent trucks, and 0 percent RVs.
- √ Assume commuter traffic ($f_p = 1.00$).

Outline of Solution Flow rate, speed, density, and LOS are calculated starting with a four-lane freeway and then increasing the number of lanes to six, eight, and so forth until LOS D is achieved. The calculation of speed is based on the equation found in Exhibit 23-3.

Steps

1. Convert AADT to design-hour volume.	$DDHV = AADT * K * D$ $DDHV = 75,000 * 0.090 * 0.55$ $DDHV = 3,713 \text{ veh/h}$
2. Find f_{HV} (use Exhibit 23-8 and Equation 23-3).	$f_{HV} = \frac{1}{1 + P_T(E_T - 1) + P_R(E_R - 1)}$ $f_{HV} = \frac{1}{1 + 0.10(2.5 - 1) + 0}$ $f_{HV} = 0.870$
3. For four-lane option (use Equation 23-2).	$v_p = \frac{3,713}{(0.90)(2)(0.870)(1.00)} = 2,371 \text{ pc/h/ln}$
4. Determine level of service (use Exhibit 23-2).	LOS F
5. For six-lane option (use Equation 23-2).	$v_p = \frac{3,713}{(0.90)(3)(0.870)(1.00)}$ $v_p = 1,581 \text{ pc/h/ln}$
6. Determine level of service (use Exhibit 23-2).	LOS C
7. Calculate speed and density	$S = 109.8 \text{ km/h}$ $D = 14.4 \text{ pc/km/ln}$

The Results

Six lanes are needed,
 LOS = C,
 Speed = 110 km/h, and
 Density = 14 pc/km/ln.

Example Problem 5

BASIC FREEWAY SEGMENTS WORKSHEET																								
		<table border="1" style="width:100%; border-collapse: collapse;"> <thead> <tr> <th>Application</th> <th>Input</th> <th>Output</th> </tr> </thead> <tbody> <tr> <td>Operational (LOS)</td> <td>FFS, N, v_p</td> <td>LOS, S, D</td> </tr> <tr> <td>Design (N)</td> <td>FFS, LOS, v_p</td> <td>N, S, D</td> </tr> <tr> <td>Design (v_p)</td> <td>FFS, LOS, N</td> <td>v_p, S, D</td> </tr> <tr> <td>Planning (LOS)</td> <td>FFS, N, AADT</td> <td>LOS, S, D</td> </tr> <tr> <td>Planning (N)</td> <td>FFS, LOS, AADT</td> <td>N, S, D</td> </tr> <tr> <td>Planning (v_p)</td> <td>FFS, LOS, N</td> <td>v_p, S, D</td> </tr> </tbody> </table>		Application	Input	Output	Operational (LOS)	FFS, N, v _p	LOS, S, D	Design (N)	FFS, LOS, v _p	N, S, D	Design (v _p)	FFS, LOS, N	v _p , S, D	Planning (LOS)	FFS, N, AADT	LOS, S, D	Planning (N)	FFS, LOS, AADT	N, S, D	Planning (v _p)	FFS, LOS, N	v _p , S, D
Application	Input	Output																						
Operational (LOS)	FFS, N, v _p	LOS, S, D																						
Design (N)	FFS, LOS, v _p	N, S, D																						
Design (v _p)	FFS, LOS, N	v _p , S, D																						
Planning (LOS)	FFS, N, AADT	LOS, S, D																						
Planning (N)	FFS, LOS, AADT	N, S, D																						
Planning (v _p)	FFS, LOS, N	v _p , S, D																						
General Information		Site Information																						
Analyst: <u>JMYE</u>		Highway/Direction of Travel: _____																						
Agency or Company: <u>CEI</u>		From/To: _____																						
Date Performed: <u>4/15/99</u>		Jurisdiction: _____																						
Analysis Time Period: _____		Analysis Year: <u>1999</u>																						
<input type="checkbox"/> Operational (LOS) <input type="checkbox"/> Design (N) <input type="checkbox"/> Design (v _p) <input type="checkbox"/> Planning (LOS) <input checked="" type="checkbox"/> Planning (N) <input type="checkbox"/> Planning (v _p)																								
Flow Inputs																								
Volume, V: _____ veh/h		Peak-hour factor, PHF: <u>0.90</u>																						
Annual avg. daily traffic, AADT: <u>75,000</u> veh/day		% Trucks and buses, P _T : <u>10</u>																						
Peak-hour proportion of AADT, K: <u>0.090</u>		% RVs, P _R : <u>0</u>																						
Peak-hour direction proportion, D: <u>0.55</u>		General terrain																						
DDHV = AADT * K * D: <u>3713</u> veh/h		<input type="checkbox"/> Level <input checked="" type="checkbox"/> Rolling <input type="checkbox"/> Mountainous																						
Driver type: <input checked="" type="checkbox"/> Commuter/Weekday <input type="checkbox"/> Recreational/Weekend		Grade Length: _____ km Up/Down: _____ %																						
Calculate Flow Adjustments																								
f _p : <u>1.00</u>		E _R : _____																						
E _T : <u>2.5</u>		$f_{HV} = \frac{1}{1 + P_T(E_T - 1) + P_R(E_R - 1)}$ _____ <u>0.870</u>																						
Speed Inputs		Calculate Speed Adjustments and FFS																						
Lane width: _____ m		f _{LW} : _____ km/h																						
RT-shoulder lateral clearance: _____ m		f _{LC} : _____ km/h																						
Interchange density: _____ I/km		f _{ID} : _____ km/h																						
Number of lanes, N: _____		f _N : _____ km/h																						
FFS (measured): <u>110</u> km/h		FFS = BFFS - f _{LW} - f _{LC} - f _{ID} - f _N																						
Base free-flow speed, BFFS: _____ km/h		_____ km/h																						
LOS and Performance Measures																								
Operational (LOS) or Planning (LOS)		Design (N) or Planning (N) 1st Iteration																						
v _p = $\frac{V \text{ or DDHV}}{PHF * N * f_{HV} * f_p}$ _____ pc/h/ln		N: <u>2</u> assumed																						
S: _____ km/h		v _p = $\frac{V \text{ or DDHV}}{PHF * N * f_{HV} * f_p}$ _____ <u>2371</u> pc/h/ln																						
D = v _p /S: _____ pc/km/ln		LOS: _____ <u>F</u>																						
LOS: _____		Design (N) or Planning (N) 2nd Iteration																						
Design (v_p) or Planning (v_p)		N: <u>3</u> assumed																						
LOS: _____		v _p = $\frac{V \text{ or DDHV}}{PHF * N * f_{HV} * f_p}$ _____ <u>1581</u> pc/h/ln																						
v _p : _____ pc/h/ln		S: _____ <u>109.8</u> km/h																						
V = v _p * PHF * N * f _{HV} * f _p : _____ veh/h		D = v _p /S: _____ <u>14.4</u> pc/km/ln																						
S: _____ km/h		LOS: _____ <u>C</u>																						
D = v _p /S: _____ pc/km/ln																								
Glossary		Factor Location																						
N - Number of lanes	S - Speed	E _R - Exhibits 23-8, 23-10	f _{LW} - Exhibit 23-4																					
V - Hourly volume	D - Density	E _T - Exhibits 23-8, 23-9, 23-11	f _{LC} - Exhibit 23-5																					
v _p - Flow rate	FFS - Free-flow speed	f _p - Page 23-12	f _N - Exhibit 23-6																					
LOS - Level of service	BFFS - Base free-flow speed	LOS, S, FFS, v _p - Exhibits 23-2, 23-3	f _{ID} - Exhibit 23-7																					
DDHV - Directional design-hour volume																								

V. REFERENCES

- Schoen, J., A. May, W. Reilly, and T. Urbanik. *Speed-Flow Relationships for Basic Freeway Sections*. Final Report, NCHRP Project 3-45. JHK & Associates, Tucson, Ariz., May 1995.
- Reilly, W., D. Harwood, J. Schoen, et al. *Capacity and Level of Service Procedures for Multilane Rural and Suburban Highways*. Final Report, NCHRP Project 3-33. JHK & Associates, Tucson, Ariz., 1988.

3. Basic Freeway Sections (Chapter 3). In *Special Report 209: Highway Capacity Manual* (third edition), TRB, National Research Council, Washington, D.C., 1994.
4. Hall, F. L., V. F. Hurdle, and J. H. Banks. Synthesis of Recent Work on the Nature of Speed-Flow and Flow-Occupancy (or Density) Relationships on Freeways. In *Transportation Research Record 1365*, TRB, National Research Council, Washington, D.C., 1992, pp. 12–18.
5. Urbanik, T., II, W. Hinshaw, and K. Barnes. Evaluation of High-Volume Urban Texas Freeways. In *Transportation Research Record 1320*, TRB, National Research Council, Washington, D.C., 1991, pp. 110–118.
6. Banks, J. H. Flow Processes at a Freeway Bottleneck. In *Transportation Research Record 1287*, TRB, National Research Council, Washington, D.C., 1990, pp. 20–28.
7. Hall, F. L., and L. M. Hall. Capacity and Speed-Flow Analysis of the Queen Elizabeth Way in Ontario. In *Transportation Research Record 1287*, TRB, National Research Council, Washington, D.C., 1990, pp. 108–118.
8. Hall, F. L., and K. Agyemang-Duah. Freeway Capacity Drop and the Definition of Capacity. In *Transportation Research Record 1320*, TRB, National Research Council, Washington, D.C., 1991, pp. 91–98.
9. Chin, H. C., and A. D. May. Examination of the Speed-Flow Relationship at the Caldecott Tunnel. In *Transportation Research Record 1320*, TRB, National Research Council, Washington, D.C., 1991, pp. 75–82.
10. Banks, J. *Evaluation of the Two-Capacity Phenomenon as a Basis for Ramp Metering*. Final Report, San Diego State University, San Diego, Calif., 1991.
11. *Manual of Traffic Engineering Studies*. Institute of Transportation Engineers, Arlington, Va., 1976.
12. Webster, N., and L. Elefteriadou. A Simulation Study of Truck Passenger Car Equivalents (PCE) on Basic Freeway Sections. *Transportation Research B*, Vol. 33, No. 5, 1999, pp. 323–336.

APPENDIX A. COMPOSITE GRADE

In a basic freeway segment analysis, an overall average grade can be substituted for a series of grades if no single portion of the grade is steeper than 4 percent or the total length of the grade is less than 1200 m. For grades outside these limits (i.e., grades having either a total length greater than 1200 m or portions steeper than 4 percent, or both), the composite grade procedure is recommended. The composite grade procedure is used to determine an equivalent grade that will result in the same final truck speed as would a series of varying grades.

As noted in the chapter, the acceleration/deceleration curves presented here are for vehicles with an average weight-to-power ratio of 120 kg/kW, heavier than typical trucks found on freeways. Typical trucks, which average between 80 and 90 kg/kW, are used to determine passenger-car equivalents.

An example is provided to illustrate the process involved in determining an equivalent grade on a freeway with two segments. Segment 1 is 1500 m long with a 2 percent upgrade, and Segment 2 is 1500 m long with a 6 percent upgrade. If the average grade procedure were used (not valid in this case), the result would be as follows:

$$\text{Total rise} = (1500 * 0.02) + (1500 * 0.06) = 120 \text{ m}$$

$$\text{Average grade} = 120/3000 = 0.04 \text{ or } 4 \text{ percent}$$

The solution for the same freeway conditions using the composite grade procedure is illustrated in Exhibit A23-1. A vertical line is drawn at 1500 m to intersect with the 2 percent deceleration curve, Point 1. The truck speed at this point is determined by

drawing a horizontal line to intersect with the vertical axis, Point 2. The speed is 75 km/h, which is the speed the truck exits Segment 1 and enters Segment 2.

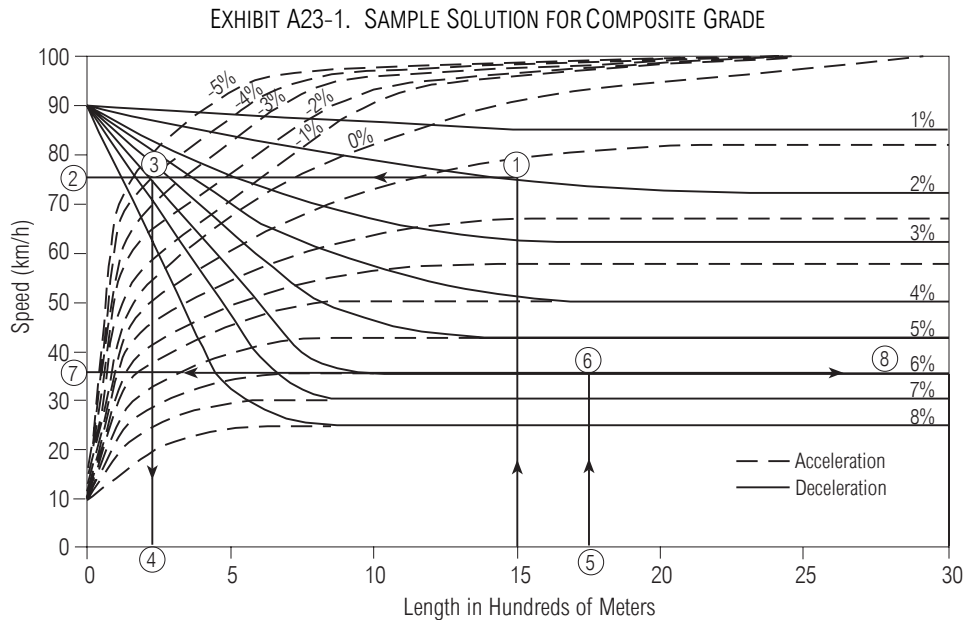

The intersection of the horizontal line with the 6 percent deceleration curve is Point 3. A vertical line is drawn at this point to intersect with the horizontal axis, Point 4. Point 4 indicates that 75 km/h is the speed as if the truck has traveled 225 m on a 6 percent upgrade from level terrain.

Because the truck travels another 1500 m on a 6 percent grade, 1500 m is added to 225 m, and Point 5 is found at 1725 m. A vertical line is drawn from Point 5 to intersect with the 6 percent deceleration curve, Point 6. A horizontal line is drawn at Point 6 to intersect with the vertical axis. The final truck speed is found to be 36 km/h, Point 7.

The equivalent grade can now be determined by intersecting a horizontal line drawn at 36 km/h with a vertical line drawn at 3000 m, Point 8. The equivalent grade is found to be 6 percent, instead of 4 percent as previously calculated by the average grade technique. The value of E_T can now be determined on the basis of a 6 percent grade and the length of 3000 m.

The general steps taken in solving the problem are summarized as follows.

1. Enter Exhibit A23-2 with an initial grade and length. Find the truck speed at the end of the first segment.
2. Find the length along the second grade that results in the same truck speed. This point is used as the starting point for the subsequent segment.
3. Add the length of Segment 2 to the length computed in Step 2. Then determine the final truck speed.
4. For each additional segment, repeat Steps 1 through 3.
5. Enter Exhibit A23-2 with the final truck speed and the total segment length to find the equivalent composite grade.

In the analysis, it is important to identify the point at which the truck speed is the lowest, because its effect on traffic flow is the most severe at that point. Thus, the appropriate point to evaluate truck speed may not always be the segment endpoint. For example, if a 4 percent upgrade of 2 km is followed by 1 km of 2 percent upgrade, the point of minimum truck speed will be the end of the first segment, not the end of the following segment.

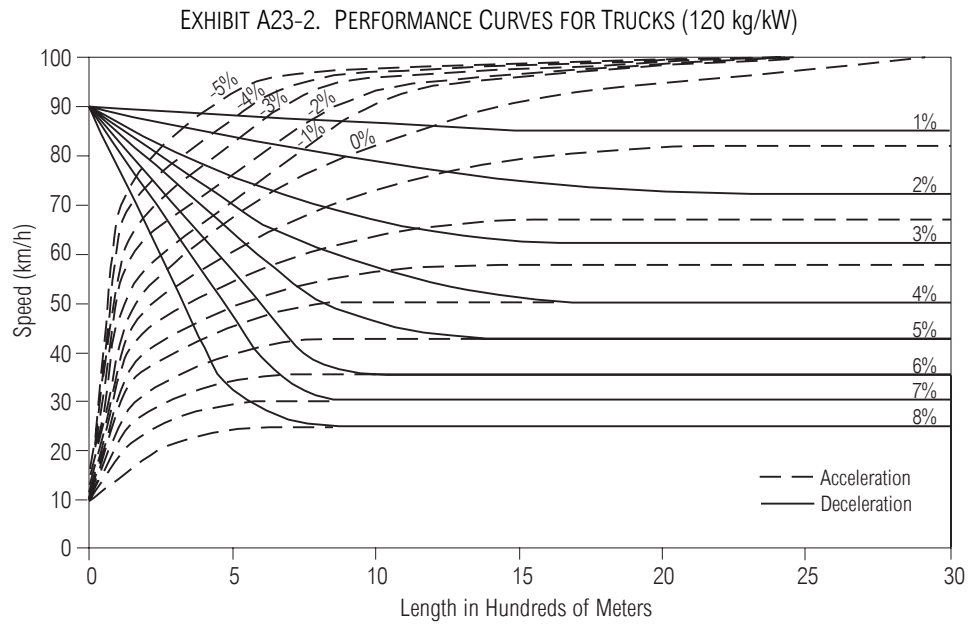

The composite grade procedure is not applicable in all cases, especially if the first segment is downgrade and the segment length is long, or the segments are too short. In using the performance curves, cases that cannot be solved with this procedure will become apparent to the analyst because lines will not intersect or points will fall outside the limits of the curves. In such cases, field measurement of speeds should be used as input to the selection of appropriate truck equivalency values.

APPENDIX B. WORKSHEET

BASIC FREEWAY SEGMENTS WORKSHEET

BASIC FREEWAY SEGMENTS WORKSHEET

Application	Input	Output
Operational (LOS)	FFS, N, v _p	LOS, S, D
Design (N)	FFS, LOS, v _p	N, S, D
Design (v _p)	FFS, LOS, N	v _p , S, D
Planning (LOS)	FFS, N, AADT	LOS, S, D
Planning (N)	FFS, LOS, AADT	N, S, D
Planning (v _p)	FFS, LOS, N	v _p , S, D

General Information

Analyst _____

Agency or Company _____

Date Performed _____

Analysis Time Period _____

Site Information

Highway/Direction of Travel _____

From/To _____

Jurisdiction _____

Analysis Year _____

Operational (LOS)

Design (N)

Design (v_p)

Planning (LOS)

Planning (N)

Planning (v_p)

Flow Inputs

Volume, V _____ veh/h	Peak-hour factor, PHF _____
Annual avg. daily traffic, AADT _____ veh/day	% Trucks and buses, P _T _____
Peak-hour proportion of AADT, K _____	% RVs, P _R _____
Peak-hour direction proportion, D _____	General terrain
DDHV = AADT * K * D _____ veh/h	<input type="checkbox"/> Level <input type="checkbox"/> Rolling <input type="checkbox"/> Mountainous
Driver type <input type="checkbox"/> Commuter/Weekday <input type="checkbox"/> Recreational/Weekend	Grade Length _____ km Up/Down _____ %

Calculate Flow Adjustments

f _p _____	E _R _____
E _T _____	f _{HV} = $\frac{1}{1 + P_T(E_T - 1) + P_R(E_R - 1)}$ _____

Speed Inputs

Lane width _____ m

Rt.-shoulder lateral clearance _____ m

Interchange density _____ I/km

Number of lanes, N _____

FFS (measured) _____ km/h

Base free-flow speed, BFFS _____ km/h

Calculate Speed Adjustments and FFS

f_{LW} _____ km/h

f_{LC} _____ km/h

f_{ID} _____ km/h

f_N _____ km/h

FFS = BFFS - f_{LW} - f_{LC} - f_{ID} - f_N _____ km/h

LOS and Performance Measures

<u>Operational (LOS) or Planning (LOS)</u>		<u>Design (N) or Planning (N) 1st Iteration</u>	
$v_p = \frac{V \text{ or DDHV}}{PHF * N * f_{HV} * f_p}$ _____ pc/h/ln	N _____ assumed	$v_p = \frac{V \text{ or DDHV}}{PHF * N * f_{HV} * f_p}$ _____ pc/h/ln	LOS _____
S _____ km/h			
D = v _p / S _____ pc/km/ln			
LOS _____			
<u>Design (v_p) or Planning (v_p)</u>		<u>Design (N) or Planning (N) 2nd Iteration</u>	
LOS _____	N _____ assumed	$v_p = \frac{V \text{ or DDHV}}{PHF * N * f_{HV} * f_p}$ _____ pc/h/ln	S _____ km/h
v _p _____ pc/h/ln		D = v _p / S _____ pc/km/ln	LOS _____
V = v _p * PHF * N * f _{HV} * f _p _____ veh/h			
S _____ km/h			
D = v _p / S _____ pc/km/ln			

Glossary

N - Number of lanes

V - Hourly volume

v_p - Flow rate

LOS - Level of service

DDHV - Directional design-hour volume

S - Speed

D - Density

FFS - Free-flow speed

BFFS - Base free-flow speed

Factor Location

E_R - Exhibits 23-8, 23-10

E_T - Exhibits 23-8, 23-9, 23-11

f_p - Page 23-12

LOS, S, FFS, v_p - Exhibits 23-2, 23-3

f_{LW} - Exhibit 23-4

f_{LC} - Exhibit 23-5

f_N - Exhibit 23-6

f_{ID} - Exhibit 23-7

CHAPTER 24

FREEWAY WEAVING

CONTENTS

I. INTRODUCTION24-1
 Scope of the Methodology24-1
 Limitations of the Methodology24-1
 II. METHODOLOGY24-1
 LOS24-2
 Weaving Segment Parameters24-3
 Determining Flow Rates24-3
 Weaving Segment Diagram24-3
 Weaving Segment Configuration24-5
 Determining Weaving and Nonweaving Speeds24-5
 Determining Weaving Intensity24-7
 Constants for Computing Weaving Intensity Factors24-7
 Determining Type of Operation24-7
 Determining Weaving Segment Speed24-8
 Determining Density24-9
 Determining Weaving Segment Capacity24-9
 Multiple Weaving Segments24-19
 Collector-Distributor Roadways24-19
 III. APPLICATIONS24-19
 Computational Steps24-20
 Planning Applications24-20
 Analysis Tools24-20
 IV. EXAMPLE PROBLEMS24-22
 Example Problem 124-23
 Example Problem 224-26
 Example Problem 324-29
 Example Problem 424-32
 Example Problem 524-37
 V. REFERENCES24-39
 APPENDIX A. WORKSHEET24-39
 Freeway Weaving Worksheet

EXHIBITS

Exhibit 24-1. Freeway Weaving Methodology24-2
 Exhibit 24-2. LOS Criteria for Weaving Segments24-3
 Exhibit 24-3. Parameters Affecting Weaving Segment Operation24-4
 Exhibit 24-4. Construction and Use of Weaving Diagrams24-4
 Exhibit 24-5. Determining Configuration Type24-5
 Exhibit 24-6. Constants for Computation of Weaving Intensity Factors24-6
 Exhibit 24-7. Criteria for Unconstrained Versus Constrained Operation of
 Weaving Segments24-8
 Exhibit 24-8. Capacity for Various Weaving Segments24-10
 Exhibit 24-9. Freeway Weaving Worksheet24-21

I. INTRODUCTION

SCOPE OF THE METHODOLOGY

Detailed procedures for the analysis of operations in freeway weaving segments are contained in this chapter. Guidelines are also given for the application of these procedures to weaving segments on multilane highways.

A discussion of basic concepts and definitions is given in Chapter 13, "Freeway Concepts." This section contains a complete discussion and definition of unconstrained and constrained operations in weaving segments and of the three types of weaving configuration: Type A, Type B, and Type C. An understanding of these concepts and definitions is critical to the correct application of the methodology of this chapter and to adequately interpret the results of analysis.

The procedures of this chapter have been assembled from a variety of sources and studies. The form of the speed prediction algorithm was developed as a result of a research project in the 1980s (1). Concepts of configuration type and type of operation were developed in an earlier study (2) in the 1970s and updated in another study of freeway capacity procedures published in 1979 (3). The final weaving procedures for the 1997 HCM are also documented (4). Several other documents describe the development of weaving segment analysis procedures (5–7).

LIMITATIONS OF THE METHODOLOGY

The methodology in this chapter does not specifically address the following subjects (without modifications by the analyst):

- Special lanes, such as high-occupancy vehicle lanes, in the weaving segment;
- Ramp metering on entrance ramps forming part of the weaving segment;
- Specific operating conditions when oversaturated conditions occur;
- Effects of speed limits or enforcement practices on weaving segment operations;
- Effects of intelligent transportation system technologies on weaving segment operations;
- Weaving segments on collector-distributor roadways;
- Weaving segments on urban streets; and
- Multiple weaving segments.

The last subject, which has been treated in previous editions of this manual, has been deleted. Multiple weaving segments must now be divided into appropriate merge, diverge, and simple weaving segments for analysis.

II. METHODOLOGY

The methodology presented in this chapter has five distinct components:

- Models predicting the space mean speed (average running speed) of weaving and nonweaving vehicles in the weaving segment (models are specified for each configuration type and for unconstrained and constrained operations);
 - Models describing the proportional use of lanes by weaving and nonweaving vehicles, used to determine whether operations are unconstrained or constrained;
 - An algorithm that converts predicted speeds to an average density within the weaving segment;
 - Definition of level-of-service (LOS) criteria based on density within the weaving segment; and
 - A model for the determination of the capacity of a weaving segment.
- Exhibit 24-1 summarizes the methodology for freeway weaving segments.

Background and concepts for this chapter are given in Chapter 13, "Freeway Concepts"

EXHIBIT 24-1. FREEWAY WEAVING METHODOLOGY

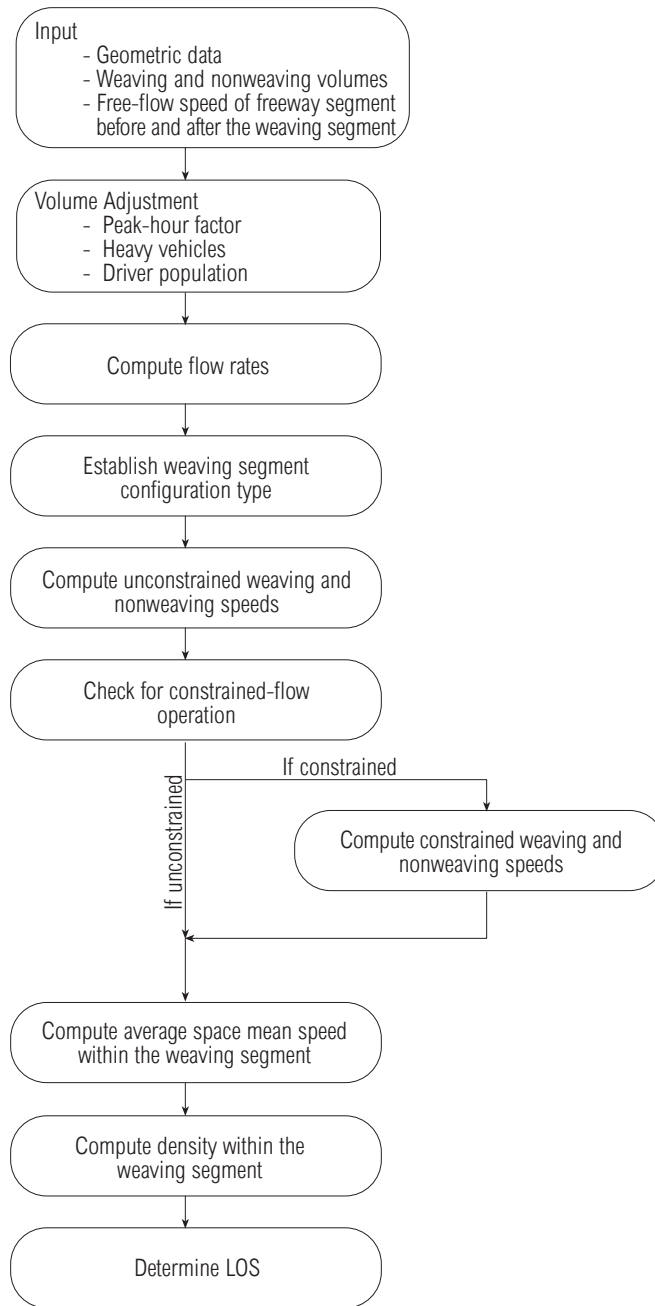

LOS

The LOS of the weaving segment is determined by comparing the computed density with the criteria of Exhibit 24-2. A single LOS is used to characterize total flow in the weaving segment, although it is recognized that in some situations (particularly in cases of constrained operations) nonweaving vehicles may achieve higher-quality operations than weaving vehicles.

EXHIBIT 24-2. LOS CRITERIA FOR WEAVING SEGMENTS

LOS	Density (pc/km/ln)	
	Freeway Weaving Segment	Multilane and Collector-Distributor Weaving Segments
A	≤ 6.0	≤ 8.0
B	> 6.0–12.0	> 8.0–15.0
C	> 12.0–17.0	> 15.0–20.0
D	> 17.0–22.0	> 20.0–23.0
E	> 22.0–27.0	> 23.0–25.0
F	> 27.0	> 25.0

In general, these criteria allow for slightly higher densities at any given level-of-service threshold than on a comparable basic freeway segment or multilane highway segment. This follows the philosophy that drivers expect and will accept higher densities on weaving segments than on basic freeway or multilane highway segments. The LOS E/F boundary does not follow this approach. Rather, it reflects densities that are somewhat less than those identified for basic freeway or multilane highway segments. Because of the additional turbulence on weaving segments, it is believed that breakdown occurs at somewhat lower densities than on basic freeway and multilane highway segments.

WEAVING SEGMENT PARAMETERS

Exhibit 24-3 illustrates and defines the variables that are used in the analysis of weaving segments. These variables are used in the algorithms that make up the methodology.

All existing or projected roadway and traffic conditions must be specified when applying the methodology. Roadway conditions include length of the segment, number of lanes, type of configuration under study, and type of terrain or grade conditions. If freeway free-flow speed (FFS) is not known, the characteristics of the basic freeway segment or multilane highway must be specified to allow its determination using the algorithms of Chapter 21 or 23.

DETERMINING FLOW RATES

All of the models and equations in this chapter are based on peak 15-min flow rates in equivalent passenger cars per hour. Thus, hourly volumes must be converted to this basis using Equation 24-1.

$$v = \frac{V}{PHF * f_{HV} * f_p} \tag{24-1}$$

where

- v = peak 15-min flow rate in an hour (pc/h),
- V = hourly volume (veh/h),
- f_{HV} = heavy-vehicle adjustment factor (from basic freeway segment or multilane highway methodology), and
- f_p = driver population factor (from basic freeway segment or multilane highway methodology).

WEAVING SEGMENT DIAGRAM

After volumes have been converted to flow rates, it is useful to construct a weaving diagram of the type shown in Exhibit 24-4. All flows are shown as flow rates in equivalent passenger cars per hour, and critical analysis variables are identified and placed on the diagram. The diagram may now be used as a reference for all input information required in applying the methodology.

If 15-min flow rates are specified initially, set the PHF to 1.00 before applying this conversion

EXHIBIT 24-3. PARAMETERS AFFECTING WEAVING SEGMENT OPERATION

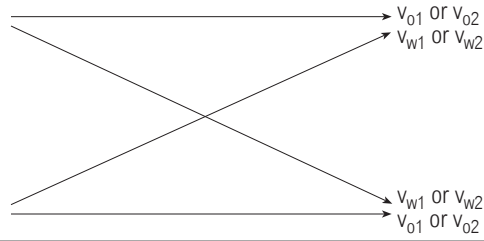

Symbol	Definition
L	Length of weaving segment (m)
N	Total number of lanes in the weaving segment
N_w	Number of lanes to be used by weaving vehicles if unconstrained operation is to be achieved
$N_w(max)$	Maximum number of lanes that can be used by weaving vehicles for a given configuration
N_{nw}	Number of lanes used by nonweaving vehicles
v	Total flow rate in the weaving segment (pc/h)
v_{o1}	Larger of the two outer, or nonweaving, flow rates in the weaving segment (pc/h)
v_{o2}	Smaller of the two outer, or nonweaving, flow rates in the weaving segment (pc/h)
v_{w1}	Larger of the two weaving flow rates in the weaving segment (pc/h)
v_{w2}	Smaller of the two weaving flow rates in the weaving segment (pc/h)
v_w	Total weaving flow rate in the weaving segment (pc/h) ($v_w = v_{w1} + v_{w2}$)
v_{nw}	Total nonweaving flow rate in the weaving segment (pc/h) ($v_{nw} = v_{o1} + v_{o2}$)
VR	Volume ratio; the ratio of weaving flow rate to total flow rate in the weaving segment ($VR = v_w/v$)
R	Weaving ratio; the ratio of the smaller weaving flow rate to total weaving flow rate ($R = v_{w2}/v_w$)
S_w	Speed of weaving vehicles in the weaving segment (km/h)
S_{nw}	Speed of nonweaving vehicles in the weaving segment (km/h)
S	Speed of all vehicles in the weaving segment (km/h)
D	Density of all vehicles in the weaving segment (pc/km/ln)
W_w	Weaving intensity factor for prediction of weaving speed
W_{nw}	Weaving intensity factor for prediction of nonweaving speed

EXHIBIT 24-4. CONSTRUCTION AND USE OF WEAVING DIAGRAMS

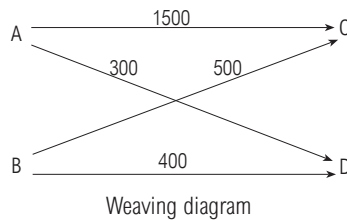
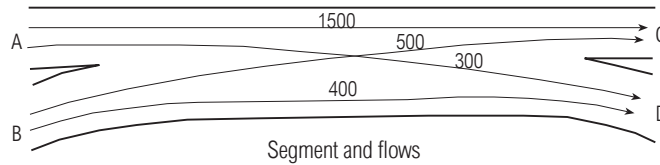

WEAVING SEGMENT CONFIGURATION

Weaving segment configuration is based on the number of lane changes required of each weaving movement. A complete discussion of this concept is found in Chapter 13. Exhibit 24-5 may be used to establish configuration type.

See Chapter 13 for diagrams and concepts of the three weaving segment configurations

EXHIBIT 24-5. DETERMINING CONFIGURATION TYPE

Number of Lane Changes Required by Movement v_{w1}	Number of Lane Changes Required by Movement v_{w2}		
	0	1	≥ 2
0	Type B	Type B	Type C
1	Type B	Type A	N/A
≥ 2	Type C	N/A	N/A

Note:
N/A = not applicable; configuration is not feasible.

The three types of geometric configurations are defined as follows:

- Type A—Weaving vehicles in both directions must make one lane change to successfully complete a weaving maneuver.
- Type B—Weaving vehicles in one direction may complete a weaving maneuver without making a lane change, whereas other vehicles in the weaving segment must make one lane change to successfully complete a weaving maneuver.
- Type C—Weaving vehicles in one direction may complete a weaving maneuver without making a lane change, whereas other vehicles in the weaving segment must make two or more lane changes to successfully complete a weaving maneuver.

DETERMINING WEAVING AND NONWEAVING SPEEDS

The heart of the weaving segment analysis procedure is the prediction of space mean speeds of weaving and nonweaving flows within the weaving segment. They are predicted separately because under some conditions they can be quite dissimilar, and the analyst must be aware of this.

The algorithm for prediction of average weaving and nonweaving speeds may be generally stated by Equation 24-2.

$$S_i = S_{min} + \frac{S_{max} - S_{min}}{1 + W_i} \quad (24-2)$$

where

- S_i = average speed of weaving ($i = w$) or nonweaving ($i = nw$) vehicles (km/h),
- S_{min} = minimum speed expected in a weaving segment (km/h),
- S_{max} = maximum speed expected in a weaving segment (km/h), and
- W_i = weaving intensity factor for weaving ($i = w$) and nonweaving ($i = nw$) flows.

For the purposes of these procedures, the minimum speed, S_{min} , is set at 24 km/h. The maximum speed, S_{max} , is taken to be the average free-flow speed of the freeway segments entering and leaving the weaving segment plus 8 km/h. The addition of 8 km/h to the free-flow speed adjusts for the tendency of the algorithm to underpredict high speeds. Setting the minimum and maximum speeds in this way constrains the algorithm to a reasonable prediction range. With these assumptions incorporated, the speed prediction is given by Equation 24-3.

$$S_i = 24 + \frac{S_{FF} - 16}{1 + W_i} \quad (24-3)$$

Attributes of weaving segments captured by the model

where S_{FF} is the average free-flow speed of the freeway segments entering and leaving the weaving segment (km/h).

Initial estimates of speed are always based on the assumption of unconstrained operation. This assumption is later tested, and speeds are recomputed if operations turn out to be constrained.

The combination of Equations 24-2 and 24-3 yields sensitivities that are consistent with observed operations of weaving segments.

- As the length of the weaving segment increases, speeds also increase, and the intensity of lane changing declines.
- As the proportion of weaving vehicles in total flow (VR) increases, speeds decrease, reflecting the increased turbulence caused by higher proportions of weaving vehicles in the traffic stream.
- As average total flow per lane (v/N) increases, speeds decrease, reflecting more intense demand.
- Constrained operations yield lower weaving speeds and higher nonweaving speeds than unconstrained operations. This reflects the fact that weaving vehicles are constrained to less space than equilibrium would require, whereas nonweaving vehicles have correspondingly more than their equilibrium share of space. In Exhibit 24-6, this is reflected by differences in the constant a.

EXHIBIT 24-6. CONSTANTS FOR COMPUTATION OF WEAVING INTENSITY FACTORS

General Form								
$W = \frac{a(1+VR)^b \left(\frac{v}{N}\right)^c}{(3.28L)^d}$								
	Constants for Weaving Speed, S_w				Constants for Nonweaving Speed, S_{nw}			
	a	b	c	d	a	b	c	d
Type A Configuration								
Unconstrained	0.15	2.2	0.97	0.80	0.0035	4.0	1.3	0.75
Constrained	0.35	2.2	0.97	0.80	0.0020	4.0	1.3	0.75
Type B Configuration								
Unconstrained	0.08	2.2	0.70	0.50	0.0020	6.0	1.0	0.50
Constrained	0.15	2.2	0.70	0.50	0.0010	6.0	1.0	0.50
Type C Configuration								
Unconstrained	0.08	2.3	0.80	0.60	0.0020	6.0	1.1	0.60
Constrained	0.14	2.3	0.80	0.60	0.0010	6.0	1.1	0.60

• Type B configurations are the most efficient for handling large weaving flows. Weaving speeds of such flows are higher than for Type A and C configurations of equal length and width.

• The sensitivity of speeds to length is greatest for Type A configurations, because weaving vehicles are often accelerating or decelerating as they traverse the weaving segment.

• The sensitivity of nonweaving speeds to the volume ratio (VR) is greatest for Type B and C configurations. Because these configurations can accommodate higher proportions of weaving vehicles and because each has a through lane for one weaving movement, nonweaving vehicles are more likely to share lanes with weaving vehicles than in Type A configurations, where the opportunity to segregate is greater.

The last point is important and serves to highlight the essential difference between Type A configurations (particularly ramp-weaves) and others (Types B and C). Because all weaving vehicles must cross a crown line in Type A segments, weaving vehicles tend

to concentrate in the two lanes adjacent to the crown line, whereas nonweaving vehicles gravitate to outer lanes. Thus there is substantially more segregation of weaving and nonweaving flows in Type A configurations.

This difference makes Type A segments behave somewhat differently from other configurations. Speeds tend to be higher in Type A segments than in Types B or C given the same length, width, and demand flows. However, this does not suggest that Type A segments always operate better than Types B or C for similar lengths, widths, and flows. Type A segments have more severe restrictions on the amount of weaving traffic that can be accommodated than do other configurations.

Determining Weaving Intensity

The weaving intensity factors (W_w and W_{nw}) are a measure of the influence of weaving activity on the average speeds of both weaving and nonweaving vehicles. These factors are computed by Equation 24-4.

$$W_i = \frac{a(1 + VR)^b \left(\frac{v}{N}\right)^c}{(3.28L)^d} \quad (24-4)$$

where

- W_i = weaving intensity factors for weaving ($i = w$) and nonweaving ($i = nw$) flows;
- VR = volume ratio;
- v = total flow rate in the weaving segment (pc/h);
- N = total number of lanes in the weaving segment;
- L = length of the weaving segment (m); and
- a, b, c, d = constants of calibration.

Constants for Computing Weaving Intensity Factors

Constants for computation of weaving intensity factors (a, b, c, d) are given in Exhibit 24-6. Values for these constants vary on the basis of three factors:

- Whether the average speed prediction is for weaving or nonweaving vehicles,
- Configuration type (A, B, or C), and
- Whether the operation is unconstrained or constrained.

DETERMINING TYPE OF OPERATION

The determination of whether a particular weaving segment is operating in an unconstrained or constrained state is based on the comparison of two variables that are defined in Chapter 13:

- N_w = number of lanes that must be used by weaving vehicles to achieve equilibrium or unconstrained operation, and
- $N_w(max)$ = maximum number of lanes that can be used by weaving vehicles for a given configuration.

Fractional values for lane use requirements of weaving vehicles may occur because weaving and nonweaving vehicles share some lanes. Cases for which $N_w < N_w(max)$ are unconstrained because there are no impediments to weaving vehicles using the number of lanes required for equilibrium. If $N_w \geq N_w(max)$, weaving vehicles are constrained to using $N_w(max)$ lanes and therefore cannot occupy as much of the roadway as would be needed to establish equilibrium operations. Exhibit 24-7 provides algorithms for the computation of N_w and shows the values of $N_w(max)$, which are discussed more fully in Chapter 13.

Definition of constrained weaving segment

EXHIBIT 24-7. CRITERIA FOR UNCONSTRAINED VERSUS CONSTRAINED OPERATION OF WEAVING SEGMENTS

Configuration	Number of Lanes Required for Unconstrained Operation, N_w	$N_w(\max)$
Type A	$1.21(N) VR^{0.571} L^{0.234} / S_w^{0.438}$	1.4
Type B	$N[0.085 + 0.703VR + (71.57/L) - 0.0112(S_{nw} - S_w)]$	3.5
Type C	$N[0.761 + 0.047VR - 0.00036L - 0.0031(S_{nw} - S_w)]$	3.0 ^a

Note:

a. For two-sided weaving segments, all freeway lanes may be used by weaving vehicles.

The equations of Exhibit 24-7 rely on the prediction of unconstrained weaving and nonweaving speeds. The equations take these results and predict the number of lanes weaving vehicles would have to occupy to achieve unconstrained speeds. If the result indicates that constrained operations exist, speeds must be recomputed using constrained equations.

The limit on maximum number of weaving lanes, $N_w(\max)$, is most restrictive for Type A segments and reflects the need for weaving vehicles to cluster in the two lanes adjacent to the crown line. The through weaving lane in Type B and C configurations provides for greater occupancy of lanes by weaving vehicles.

Type A segments have another unusual, but understandable, characteristic. As the length of a Type A segment increases, constrained operation is more likely to result. As the length increases, the speed of weaving vehicles is also able to increase. Thus, weaving vehicles use more space as length increases, and the likelihood of requiring more than the maximum of 1.4 lanes to achieve equilibrium also increases.

Types B and C show the opposite trend. Increasing length has less effect on weaving speed than in Type A configurations. First, acceleration and deceleration from low-speed ramps are less of an issue for Types B and C, which are, by definition, major weaving segments. Second, the substantial mixing of weaving and nonweaving vehicles in the same lanes makes the resulting speeds less sensitive to length. In Type B and C segments, the proportion of lanes needed by weaving vehicles to achieve unconstrained operation decreases as length increases.

The analyst should note that under extreme conditions (high VR, short length), the equation for Type B segments can predict values of $N_w > N$. While this is not practical and reflects portions of the research database with sparse field data, it may always be taken to indicate constrained operations.

DETERMINING WEAVING SEGMENT SPEED

Once speeds have been estimated and the type of operation determined (which may cause a recomputation of estimated speeds), the average space mean speed of all vehicles in the segment is computed according to Equation 24-5.

$$S = \frac{v}{\left(\frac{v_w}{S_w}\right) + \left(\frac{v_{nw}}{S_{nw}}\right)} \quad (24-5)$$

where

- S = space mean speed of all vehicles in the weaving segment (km/h),
- S_w = space mean speed of weaving vehicles in the weaving segment (km/h),
- S_{nw} = space mean speed of nonweaving vehicles in the weaving segment (km/h),
- v = total flow rate in the weaving segment (pc/h),
- v_w = weaving flow rate in the weaving segment (pc/h), and
- v_{nw} = nonweaving flow rate in the weaving segment (pc/h).

DETERMINING DENSITY

The average speed for all vehicles may be used to compute density for all vehicles in the weaving segment as shown in Equation 24-6.

$$D = \frac{\left(\frac{V}{N}\right)}{S} \quad (24-6)$$

where D is the average density for all vehicles in the weaving segment (pc/km/ln).

DETERMINING WEAVING SEGMENT CAPACITY

The capacity of a weaving segment is any combination of flows that causes the density to reach the LOS E/F boundary condition of 27.0 pc/km/ln for freeways or 25.0 pc/km/ln for multilane highways. Thus, capacity varies with a number of variables: configuration, number of lanes, free-flow speed of the freeway or multilane highway, length, and volume ratio. Because of the form of predictive algorithms, generation of a simple closed-form solution for capacity given the specification of the other variables is not possible. Rather, a trial-and-error process must be used.

Exhibit 24-8 shows tabulated values of weaving segment capacity for a number of situations. As a rough estimate, straight-line interpolation may be used for intermediate values. The tabulated capacities reflect some other limitations on weaving segment operations that reflect field observations:

- The capacity of a weaving segment may never exceed the capacity of a similar basic freeway or multilane highway segment.
- Field studies suggest that weaving flow rates should not exceed the following values: 2,800 pc/h for Type A, 4,000 pc/h for Type B, and 3,500 pc/h for Type C configurations. Even though higher weaving flows have been observed, they are likely to cause failure regardless of the results of analysis using the procedures in this manual.
- Field studies indicate that there are also limitations on the proportion of weaving flow (VR) that can be accommodated by various configurations: 1.00, 0.45, 0.35, or 0.20 for Type A with two, three, four, or five lanes, respectively; 0.80 for Type B; and 0.50 for Type C. At higher volume ratios, stable operations may still occur, but operations will be worse than those anticipated by the methodology, and failure could occur.
- For Type C segments, the weaving ratio, R , should not exceed 0.40, with the larger weaving flow being in the direction of the through weaving lane. At higher weaving ratios or where the dominant weaving flow is not in the direction of the through weaving lane, stable operations may still occur, but operations will be worse than those estimated by the methodology. Breakdown may occur in some cases.
- The maximum length for which weaving analysis is conducted is 750 m for all configuration types. Beyond these lengths, merge and diverge areas are considered separately using the methodology of Chapter 25, "Ramps and Ramp Junctions."

As noted previously, the capacity of a weaving segment is represented by any set of conditions that results in an average density of 27 pc/km/ln (for freeways) or 25 pc/km/ln (for multilane highways). Thus, capacity varies with the configuration, the length and width of the weaving segment, the proportion of total flow that weaves (VR), and the free-flow speed of the freeway. For any given set of conditions, the algorithms described herein must be solved iteratively to find capacity.

Capacity of a weaving segment defined

Capacity attributes of weaving segments

EXHIBIT 24-8. CAPACITY FOR VARIOUS WEAVING SEGMENTS

(A) Type A Weaving Segments—120-km/h Free-Flow Speed					
Volume Ratio, VR	Length of Weaving Segment (m)				
	150	300	450	600	750 ^a
Three-Lane Segments					
0.10	6050	6820	7200 ^b	7200 ^b	7200 ^b
0.20	5490	6260	6720	7050	7200 ^b
0.30	5040	5780	6240	6570	6830
0.40	4660	5380	5530	5800 ^c	6050 ^c
0.45 ^d	4430	5000 ^c	5270 ^c	5550 ^c	5800 ^c
Four-Lane Segments					
0.10	8060	9010	9600 ^b	9600 ^b	9600 ^b
0.20	7320	8340	8960	9400	9600 ^b
0.30	6710	7520 ^c	8090 ^c	8510 ^c	8840
0.35 ^e	6370 ^c	7160 ^c	7700 ^c	8000 ^f	8000 ^f
Five-Lane Segments					
0.10	10,080	11,380	12,000 ^b	12,000 ^b	12,000 ^b
0.20 ^g	9150	10,540 ^c	11,270 ^c	11,790 ^c	12,000 ^b
(B) Type A Weaving Segments—110-km/h Free-Flow Speed					
Volume Ratio, VR	Length of Weaving Segment (m)				
	150	300	450	600	750 ^a
Three-Lane Segments					
0.10	5770	6470	6880	7050 ^b	7050 ^b
0.20	5250	5960	6280	6680	6900
0.30	4830	5520	5940	6240	6480
0.40	4480	5150	5250 ^c	5530 ^c	5760 ^c
0.45 ^d	4190	4790 ^c	5020 ^c	5310 ^c	5530 ^c
Four-Lane Segments					
0.10	7690	8630	9180	9400 ^b	9400 ^b
0.20	7000	7940	8500	8900	9200
0.30	6440	7180 ^c	7710 ^c	8090 ^c	8390 ^c
0.35 ^e	6080 ^c	6830 ^c	7360 ^c	7730 ^c	8030 ^c
Five-Lane Segments					
0.10	9610	10,790	11,470	11,750 ^b	11,750 ^b
0.20 ^g	8750	10,030 ^c	10,690 ^c	11,160 ^c	11,520 ^c

Notes:
Refer to the last page of Exhibit 24-8.

EXHIBIT 24-8 (CONTINUED). CAPACITY FOR VARIOUS WEAVING SEGMENTS

(C) Type A Weaving Segments—100-km/h Free-Flow Speed					
Volume Ratio, VR	Length of Weaving Segment (m)				
	150	300	450	600	750 ^a
Three-Lane Segments					
0.10	5470	6110	6480	6730	6910
0.20	5000	5640	6020	6290	6490
0.30	4610	5240	5620	5900	6110
0.40	4290	4900	4990 ^c	5250 ^c	5460 ^c
0.45 ^d	4000	4520 ^c	4790 ^c	5040 ^c	5200 ^c
Four-Lane Segments					
0.10	7300	8150	8630	8970	9220
0.20	6660	7520	8030	8380	8650
0.30	6080 ^c	6830 ^c	7310 ^c	7650 ^c	7920 ^c
0.35 ^e	5780 ^c	6520 ^c	6990 ^c	7330 ^c	7600 ^c
Five-Lane Segments					
0.10	9120	10,180	10,790	11,210	11,500 ^b
0.20 ^g	8330	9500 ^c	10,080 ^c	10,510 ^c	10,830 ^c
(D) Type A Weaving Segments—90-km/h Free-Flow Speed					
Volume Ratio, VR	Length of Weaving Segment (m)				
	150	300	450	600	750 ^a
Three-Lane Segments					
0.10	5160	5730	6050	6270	6430
0.20	4730	5310	5650	5880	6060
0.30	4380	4850	5290	5540	5720
0.40	4090	4420 ^c	4730 ^c	4960 ^c	5140 ^c
0.45 ^d	3850	4240 ^c	4470 ^c	4780 ^c	4950 ^c
Four-Lane Segments					
0.10	6880	7460	8070	8350	8570
0.20	6310	7080	7530	7840	8080
0.30	5790 ^c	6360 ^c	6890 ^c	7190 ^c	7430 ^c
0.35 ^e	5520 ^c	6180 ^c	6590 ^c	6910 ^c	7140 ^c
Five-Lane Segments					
0.10	8600	9550	10,080	10,440	10,710
0.20 ^g	8060 ^c	8930 ^c	9460 ^c	9820 ^c	10,100 ^c

Notes:
Refer to the last page of Exhibit 24-8.

EXHIBIT 24-8 (CONTINUED). CAPACITY FOR VARIOUS WEAVING SEGMENTS

(E) Type B Weaving Segments—120-km/h Free-Flow Speed

Volume Ratio, VR	Length of Weaving Segment (m)				
	150	300	450	600	750 ^a
Three-Lane Segments					
0.10	7200 ^b	7200 ^b	7200 ^b	7200 ^b	7200 ^b
0.20	6830	7200 ^b	7200 ^b	7200 ^b	7200 ^b
0.30	6120	6690	7010	7200 ^b	7200 ^b
0.40	5550	6100	6430	6670	6850
0.50	5100	5630	5950	6180	6370
0.60	4750	5260	5570	5800	5980
0.70	4180	4990	5290	5520	5690
0.80 ^h	3900	4820	5000 ^f	5000 ^f	5000 ^f
Four-Lane Segments					
0.10	9600 ^b	9600 ^b	9600 ^b	9600 ^b	9600 ^b
0.20	9110	9600 ^b	9600 ^b	9600 ^b	9600 ^b
0.30	8170	8910	9350	9600 ^b	9600 ^b
0.40	7400	8140	8570	8890	9130
0.50	6670 ^c	7500	7930	8000 ^f	8000 ^f
0.60	6070 ^c	6670 ^f	6670 ^f	6670 ^f	6670 ^f
0.70	5580 ^c	5760 ^f	5760 ^f	5760 ^f	5760 ^f
0.80 ^h	5000 ^f	5000 ^f	5000 ^f	5000 ^f	5000 ^f
Five-Lane Segments					
0.10	12,000 ^b	12,000 ^b	12,000 ^b	12,000 ^b	12,000 ^b
0.20	11,390	12,000 ^b	12,000 ^b	12,000 ^b	12,000 ^b
0.30	10,210	11,140	11,690	12,000 ^b	12,000 ^b
0.40	9270 ^c	10,000 ^f	10,000 ^f	10,000 ^f	10,000 ^f
0.50	8000 ^f	8000 ^f	8000 ^f	8000 ^f	8000 ^f
0.60	6670 ^f	6670 ^f	6670 ^f	6670 ^f	6670 ^f
0.70	5760 ^f	5760 ^f	5760 ^f	5760 ^f	5760 ^f
0.80 ^h	5000 ^f	5000 ^f	5000 ^f	5000 ^f	5000 ^f

Notes:
Refer to the last page of Exhibit 24-8.

EXHIBIT 24-8 (CONTINUED). CAPACITY FOR VARIOUS WEAVING SEGMENTS

(F) Type B Weaving Segments—110-km/h Free-Flow Speed					
Volume Ratio, VR	Length of Weaving Segment (m)				
	150	300	450	600	750 ^a
Three-Lane Segments					
0.10	7050 ^b	7050 ^b	7050 ^b	7050 ^b	7050 ^b
0.20	6460	6950	7050 ^b	7050 ^b	7050 ^b
0.30	5810	6320	6620	6830	6980
0.40	5280	5790	6090	6300	6470
0.50	4860	5350	5650	5860	6030
0.60	4550	5010	5300	5510	5680
0.70	4320	4770	5050	5250	5410
0.80 ^h	3650	4600	4880	5000 ^f	5000 ^f
Four-Lane Segments					
0.10	9400 ^b	9400 ^b	9400 ^b	9400 ^b	9400 ^b
0.20	8610	9270	9400 ^b	9400 ^b	9400 ^b
0.30	7750	8430	8820	9100	9310
0.40	7040	7720	8120	8400	8620
0.50	6370 ^c	7140	7530	7820	8000 ^f
0.60	5810 ^c	6670 ^f	6670 ^f	6670 ^f	6670 ^f
0.70	5350 ^c	5760 ^f	5760 ^f	5760 ^f	5760 ^f
0.80 ^h	5000 ^f	5000 ^f	5000 ^f	5000 ^f	5000 ^f
Five-Lane Segments					
0.10	11,750 ^b	11,750 ^b	11,750 ^b	11,750 ^b	11,750 ^b
0.20	10,760	11,590	11,750 ^b	11,750 ^b	11,750 ^b
0.30	9690	10,540	11,030	11,370	11,640
0.40	8830 ^c	9650	10,000 ^f	10,000 ^f	10,000 ^f
0.50	7960 ^c	8000 ^f	8000 ^f	8000 ^f	8000 ^f
0.60	6670 ^f	6670 ^f	6670 ^f	6670 ^f	6670 ^f
0.70	5760 ^f	5760 ^f	5760 ^f	5760 ^f	5760 ^f
0.80 ^h	5000 ^f	5000 ^f	5000 ^f	5000 ^f	5000 ^f

Notes:

Refer to the last page of Exhibit 24-8.

EXHIBIT 24-8 (CONTINUED). CAPACITY FOR VARIOUS WEAVING SEGMENTS

(G) Type B Weaving Segments—100-km/h Free-Flow Speed					
Volume Ratio, VR	Length of Weaving Segment (m)				
	150	300	450	600	750 ^a
Three-Lane Segments					
0.10	6750	6900 ^b	6900 ^b	6900 ^b	6900 ^b
0.20	6070	6510	6750	6900 ^b	6900 ^b
0.30	5490	5950	6210	6400	6540
0.40	5010	5470	5740	5930	6070
0.50	4620	5070	5340	5530	5680
0.60	4330	4760	5020	5220	5360
0.70	4120	4530	4790	4970	5120
0.80 ^h	3600	4380	4630	4820	4960
Four-Lane Segments					
0.10	9000	9200 ^b	9200 ^b	9200 ^b	9200 ^b
0.20	8100	8680	9010	9200 ^b	9200 ^b
0.30	7320	7930	8280	8530	8710
0.40	6680	7290	7650	7900	8100
0.50	6060 ^c	6760	7120	7370	7580
0.60	5540 ^c	6340	6670 ^f	6670 ^f	6670 ^f
0.70	5130 ^c	5640 ^b	5760 ^f	5760 ^f	5760 ^f
0.80 ^h	4800 ^c	5000 ^f	5000 ^f	5000 ^f	5000 ^f
Five-Lane Segments					
0.10	11,250	11,500 ^b	11,500 ^b	11,500 ^b	11,500 ^b
0.20	10,120	10,850	11,260	11,500 ^b	11,500 ^b
0.30	9150	9910	10,350	10,660	10,890
0.40	8370 ^c	9110	9560	9880	10,000 ^f
0.50	7570 ^c	8000 ^f	8000 ^f	8000 ^f	8000 ^f
0.60	6670 ^f	6670 ^f	6670 ^f	6670 ^f	6670 ^f
0.70	5760 ^f	5760 ^f	5760 ^f	5760 ^f	5760 ^f
0.80 ^h	5000 ^f	5000 ^f	5000 ^f	5000 ^f	5000 ^f

Notes:
Refer to the last page of Exhibit 24-8.

EXHIBIT 24-8 (CONTINUED). CAPACITY FOR VARIOUS WEAVING SEGMENTS

(H) Type B Weaving Segments—90-km/h Free-Flow Speed					
Volume Ratio, VR	Length of Weaving Segment (m)				
	150	300	450	600	750 ^a
Three-Lane Segments					
0.10	6270	6600	6750 ^b	6750 ^b	6750 ^b
0.20	5670	6050	6270	6410	6520
0.30	5150	5560	5790	5950	6070
0.40	4720	5130	5370	5540	5670
0.50	4370	4770	5010	5190	5320
0.60	4110	4500	4730	4900	5030
0.70	3910	4290	4520	4690	4820
0.80 ^h	3440	4150	4380	4540	4670
Four-Lane Segments					
0.10	8350	8800	9000 ^b	9000 ^b	9000 ^b
0.20	7560	8070	8360	8550	8690
0.30	6870	7410	7720	7940	8100
0.40	6290	6840	7160	7390	7560
0.50	5740 ^c	6360	6680	6920	7090
0.60	5270 ^c	5990	6310	6530	6670 ^f
0.70	4890 ^c	5350 ^c	5760 ^f	5760 ^f	5760 ^f
0.80 ^h	4590 ^c	5000 ^f	5000 ^f	5000 ^f	5000 ^f
Five-Lane Segments					
0.10	10,440	10,990	11,250 ^b	11,250 ^b	11,250 ^b
0.20	9450	10,090	10,440	10,680	10,860
0.30	8580	9260	9650	9920	10,120
0.40	7890 ^c	8550	8950	9230	9450
0.50	7170 ^c	7960	8000 ^f	8000 ^f	8000 ^f
0.60	6580 ^c	6670 ^f	6670 ^f	6670 ^f	6670 ^f
0.70	5760 ^f	5760 ^f	5760 ^f	5760 ^f	5760 ^f
0.80 ^h	5000 ^f	5000 ^f	5000 ^f	5000 ^f	5000 ^f

Notes:

Refer to the last page of Exhibit 24-8.

EXHIBIT 24-8 (CONTINUED). CAPACITY FOR VARIOUS WEAVING SEGMENTS

(I) Type C Weaving Segments—120-km/h Free-Flow Speed					
Volume Ratio, VR	Length of Weaving Segment (m)				
	150	300	450	600	750 ^a
Three-Lane Segments					
0.10	7200 ^b	7200 ^b	7200 ^b	7200 ^b	7200 ^b
0.20	6590	7200 ^b	7200 ^b	7200 ^b	7200 ^b
0.30	5890	6540	6930	7200	7200 ^b
0.40	5530	5960	6350	6620	6840
0.50 ⁱ	4890	5500	5870	6140	6360
Four-Lane Segments					
0.10	9600 ^b	9600 ^b	9600 ^b	9600 ^b	9600 ^b
0.20	8780	9600 ^b	9600 ^b	9600 ^b	9600 ^b
0.30	7850	8720	9230	9590	9600 ^b
0.40	7110	7950	8470	8750 ^f	8750 ^f
0.50 ⁱ	6520	7000 ^f	7000 ^f	7000 ^f	7000 ^f
Five-Lane Segments					
0.10	12,000 ^b	12,000 ^b	12,000 ^b	12,000 ^b	12,000 ^b
0.20	11,520 ^c	12,000 ^b	12,000 ^b	12,000 ^b	12,000 ^b
0.30	10,140 ^c	11,170 ^c	11,670 ^f	11,670 ^f	11,670 ^f
0.40	8750 ^f	8750 ^f	8750 ^f	8750 ^f	8750 ^f
0.50 ⁱ	7000 ^f	7000 ^f	7000 ^f	7000 ^f	7000 ^f
(J) Type C Weaving Segments—110-km/h Free-Flow Speed					
Volume Ratio, VR	Length of Weaving Segment (m)				
	150	300	450	600	750 ^a
Three-Lane Segments					
0.10	7010	7050 ^b	7050 ^b	7050 ^b	7050 ^b
0.20	6240	6830	7050 ^b	7050 ^b	7050 ^b
0.30	5610	6200	6550	6790	6980
0.40	5090	5670	6020	6270	6470
0.50 ⁱ	4680	5240	5590	5840	6030
Four-Lane Segments					
0.10	9350	9400 ^b	9400 ^b	9400 ^b	9400 ^b
0.20	8320	9100	9400 ^b	9400 ^b	9400 ^b
0.30	7470	8270	8730	9060	9300
0.40	6240	7560	8030	8360	8620
0.50 ⁱ	5830	6990	7000 ^f	7000 ^f	7000 ^f
Five-Lane Segments					
0.10	11,750 ^b	11,750 ^b	11,750 ^b	11,750 ^b	11,750 ^b
0.20	10,900 ^c	11,750 ^b	11,750 ^b	11,750 ^b	11,750 ^b
0.30	9630 ^c	10,570 ^c	10,910	11,320	11,630
0.40	8590 ^c	8750 ^f	8750 ^f	8750 ^f	8750 ^f
0.50 ⁱ	7000 ^f	7000 ^f	7000 ^f	7000 ^f	7000 ^f

Notes:
Refer to the last page of Exhibit 24-8.

EXHIBIT 24-8 (CONTINUED). CAPACITY FOR VARIOUS WEAVING SEGMENTS

(K) Type C Weaving Segments—100-km/h Free-Flow Speed					
Volume Ratio, VR	Length of Weaving Segment (m)				
	150	300	450	600	750 ^a
Three-Lane Segments					
0.10	6570	6900 ^b	6900 ^b	6900 ^b	6900 ^b
0.20	5890	6410	6700	6900	6900 ^b
0.30	5310	5850	6160	6370	6540
0.40	4840	5370	5680	5910	6080
0.50 ⁱ	4460	4970	5290	5510	5690
Four-Lane Segments					
0.10	8760	9200 ^b	9200 ^b	9200 ^b	9200 ^b
0.20	7850	8540	8930	9200	9200 ^b
0.30	7080	7790	8210	8500	8720
0.40	6450	7150	7580	7880	8110
0.50 ⁱ	5950	6630	7000 ^f	7000 ^f	7000 ^f
Five-Lane Segments					
0.10	11,500 ^b	11,500 ^b	11,500 ^b	11,500 ^b	11,500 ^b
0.20	10,250 ^c	11,050 ^c	11,170	11,500	11,500 ^b
0.30	9110 ^c	9960 ^c	10,260	10,620	10,900
0.40	8170 ^c	8750 ^f	8750 ^f	8750 ^f	8750 ^f
0.50 ⁱ	7000 ^f	7000 ^f	7000 ^f	7000 ^f	7000 ^f

Notes:
Refer to the last page of Exhibit 24-8.

EXHIBIT 24-8 (CONTINUED). CAPACITY FOR VARIOUS WEAVING SEGMENTS

(L) Type C Weaving Segments—90-km/h Free-Flow Speed					
Volume Ratio, VR	Length of Weaving Segment (m)				
	150	300	450	600	750 ^a
Three-Lane Segments					
0.10	6120	6520	6730	6750 ^b	6750 ^b
0.20	5510	5970	6230	6400	6520
0.30	5000	5480	5750	5940	6090
0.40	4570	5050	5330	5530	5680
0.50 ⁱ	4230	4700	4980	5180	5330
Four-Lane Segments					
0.10	8150	8700	8980	9000 ^b	9000 ^b
0.20	7350	7960	8300	8530	8700
0.30	6660	7300	7670	7920	8110
0.40	5640	6730	7110	7370	7580
0.50 ⁱ	5300	6260	6640	6900	7000 ^f
Five-Lane Segments					
0.10	10,770 ^c	11,250 ^b	11,230	11,250 ^b	11,250 ^b
0.20	9580 ^c	10,270 ^c	10,380	10,660	10,870
0.30	8570 ^c	9310 ^c	9580	9900	10,140
0.40	7720 ^c	8470 ^c	8750 ^f	8750 ^f	8750 ^f
0.50 ⁱ	7000 ^f	7000 ^f	7000 ^f	7000 ^f	7000 ^f

Notes:

- a. Weaving segments longer than 750 m are treated as isolated merge and diverge areas using the procedures of Chapter 25, "Ramps and Ramp Junctions."
- b. Capacity constrained by basic freeway capacity.
- c. Capacity occurs under constrained operating conditions.
- d. Three-lane Type A segments do not operate well at volume ratios greater than 0.45. Poor operations and some local queuing are expected in such cases.
- e. Four-lane Type A segments do not operate well at volume ratios greater than 0.35. Poor operations and some local queuing are expected in such cases.
- f. Capacity constrained by maximum allowable weaving flow rate: 2,800 pc/h (Type A), 4,000 (Type B), 3,500 (Type C).
- g. Five-lane Type A segments do not operate well at volume ratios greater than 0.20. Poor operations and some local queuing are expected in such cases.
- h. Type B weaving segments do not operate well at volume ratios greater than 0.80. Poor operations and some local queuing are expected in such cases.
- i. Type C weaving segments do not operate well at volume ratios greater than 0.50. Poor operations and some local queuing are expected in such cases.

It is possible to do so using a spreadsheet properly programmed for such iteration. Capacities have been determined for freeway facilities and are shown in Exhibit 24-8. These capacities represent maximum 15-min flow rates under equivalent base conditions and are rounded to the nearest 10 pc/h. To find the capacity under a given set of prevailing conditions Equation 24-7 is used.

$$c = c_b * f_{HV} * f_p \tag{24-7}$$

where

- c = capacity under prevailing conditions stated as a flow rate for the peak 15 min of the hour (veh/h),
- c_b = capacity under base conditions stated as a flow rate for the peak 15 min of the hour in Exhibit 24-8 (pc/h),
- f_{HV} = heavy-vehicle adjustment factor (basic freeway segments or multilane highways), and
- f_p = driver population factor (basic freeway segments or multilane highways).

If a capacity in terms of an hourly volume is desired, it may be computed using Equation 24-8.

$$c_h = c * PHF \quad (24-8)$$

where

- c_h = capacity under prevailing conditions expressed as an hourly volume (veh/h), and
 PHF = peak-hour factor.

MULTIPLE WEAVING SEGMENTS

When a series of closely spaced merge and diverge areas creates several sets of weaving movements (between different merge-diverge pairs) that share the same segment of the roadway, a multiple weaving segment is created. In previous editions of this manual, a specific procedure for analysis of two-segment multiple weaving segments, involving two sets of overlapping weaving movements, was presented. Although it constituted a logical approach, it did not address cases where three or more sets of weaving movements overlapped, and it was not extensively supported by field data.

It is recommended that such cases be segregated into merge areas, diverge areas, and simple weaving segments, as appropriate, and that each segment be analyzed accordingly. Chapter 22 contains information on this procedure.

COLLECTOR-DISTRIBUTOR ROADWAYS

A common design practice often results in weaving segments that occur on collector-distributor roadways that are part of a freeway or multilane highway interchange. Although the procedures of this chapter could be applied to such cases (using appropriate free-flow speeds), whether the LOS criteria specified herein should apply is unclear. Because many such segments operate at low speeds and correspondingly high densities, stable operations may exist beyond the maximum densities specified herein, which are intended for freeway or multilane highway weaving.

III. APPLICATIONS

The methodology of this chapter can be used to analyze the capacity and LOS of freeway weaving segments. First, the analyst identifies the primary output. Primary outputs typically solved for in a variety of applications include LOS, number of lanes required (N), weaving segment length required (L), and weaving segment configuration type (Type). Performance measures related to density and speed are also achievable but are considered secondary outputs.

Second, the analyst must identify the default values or estimated values for use in the analysis. Basically, the analyst has three sources of input data:

1. Default values found in this manual,
2. Estimates and locally derived default values developed by the analyst, and
3. Values derived from field measurements and observation.

For each of the input variables, a value must be supplied to calculate the outputs, both primary and secondary.

A common application of the method is to compute the LOS of an existing or a changed segment in the near term or distant future. This type of application is termed operational, and its primary output is LOS, with secondary outputs for density and speed. Another application is to check the adequacy of or to recommend the required number of lanes, weaving segment length, or weaving configuration given the volume or flow rate and LOS goal. This application is termed design since its primary outputs are geometric

Guidelines for required inputs and estimated values are given in Chapter 13

attributes of the weaving segment. Other outputs from this application include speed and density.

Another general type of analysis is termed planning. These analyses use estimates, HCM default values, and local default values as inputs in the calculation. LOS or weaving segment attributes can be determined as outputs, along with the secondary outputs of density and speed. The difference between planning analysis and operational or design analysis is that most or all of the input values in planning come from estimates or default values, whereas the operational and design analyses use field measurements or known values for inputs. Note that for each of the analyses, FFS of the weaving segment, either measured or estimated, is required as an input for the computation.

COMPUTATIONAL STEPS

The worksheet for freeway weaving computations is shown in Exhibit 24-9. The worksheet is also included in Appendix A. For all applications, the analyst provides general information and site information.

Operational (LOS)

For operational (LOS) analysis, all required input data are entered as input. After converting volumes to flow rates, the unconstrained weaving intensity factor is used to estimate weaving and nonweaving speeds. The number of lanes weaving vehicles must occupy to achieve unconstrained operation is determined. If this value is less than the maximum number of lanes, then unconstrained flow exists, and previously computed speeds will apply to the analysis. If the number of lanes required for unconstrained operation is greater than or equal to the maximum number of lanes, then weaving and nonweaving speeds must be computed for constrained operation. Then the space mean speed for all vehicles in the weaving segment is computed followed by density. Finally, level of service is determined using the density value for the weaving segment.

Design (N, L, Type)

The objective of design (N, L, Type) analysis is to estimate the length of a weaving segment, the number of lanes, or weaving segment configuration type given volumes and free-flow speed. A desired level of service is stated and entered in the worksheet. Then a weaving segment length, number of lanes, and configuration type are assumed, and the procedure for operational (LOS) analysis is performed. The level-of-service result with the assumed parameters is then compared with the desired level of service. If the desired level of service is not met, a new combination of parameter values is assumed. These iterations are continued until the desired level of service is achieved.

PLANNING APPLICATIONS

Planning (LOS)

Planning (N, L, Type)

The two planning applications, planning (LOS) and planning (N, L, Type), directly correspond to procedures described for operational and design analysis.

The first criterion that categorizes these as planning applications is the use of estimates, HCM default values, or local default values on the input side of the calculation. Another factor that defines a given application as planning is the use of annual average daily traffic (AADT) to estimate directional design-hour volume (DDHV). Guidelines for calculating DDHV are given in Chapter 8. The analyst typically has few, if any, of the input values required to perform planning applications. More information on the use of default values is contained in Chapter 13.

ANALYSIS TOOLS

The worksheet shown in Exhibit 24-9 and provided in Appendix A can be used to perform operational (LOS), design (N, L, Type), planning (LOS), and planning (N, L, Type) analyses.

EXHIBIT 24-9. FREEWAY WEAVING WORKSHEET

FREEWAY WEAVING WORKSHEET									
General Information					Site Information				
Analyst _____					Freeway/Direction of Travel _____				
Agency or Company _____					Weaving Segment Location _____				
Date Performed _____					Jurisdiction _____				
Analysis Time Period _____					Analysis Year _____				
<input type="checkbox"/> Operational (LOS)		<input type="checkbox"/> Design (N, L, Type)			<input type="checkbox"/> Planning (LOS)			<input type="checkbox"/> Planning (N, L, Type)	
Inputs									
Sketch (show lanes, L, v ₀₁ , v ₀₂ , v _{w1} , v _{w2})					Freeway free-flow speed, S _{FF} = _____ km/h				
					Weaving number of lanes, N = _____				
					Weaving segment length, L _____ m				
					Terrain <input type="checkbox"/> Level <input type="checkbox"/> Rolling				
					Weaving type <input type="checkbox"/> Type A <input type="checkbox"/> Type B <input type="checkbox"/> Type C				
					Volume ratio, VR = $\frac{v_w}{v}$ _____				
					Weaving ratio, R = $\frac{v_{w2}}{v_w}$ _____				
Conversion to pc/h Under Base Conditions									
(pc/h)	AADT (veh/day)	K	D	V (veh/h)	PHF	% HV	f _{HV}	f _p	$v = \frac{V}{PHF * f_{HV} * f_p}$
v ₀₁									
v ₀₂									
v _{w1}									
v _{w2}									
v _w									
v _{nw}									
v									
Weaving and Nonweaving Speeds									
	Unconstrained				Constrained				
	Weaving (i = w)		Nonweaving (i = nw)		Weaving (i = w)		Nonweaving (i = nw)		
a (Exhibit 24-6)									
b (Exhibit 24-6)									
c (Exhibit 24-6)									
d (Exhibit 24-6)									
Weaving intensity factor, W _i $W_i = \frac{a(1+VR)^b (v/N)^c}{(3.28L)^d}$									
Weaving and nonweaving speeds, S _i (km/h) $S_i = 24 + \frac{S_{FF} - 16}{1 + W_i}$									
Number of lanes required for unconstrained operation, N _w (Exhibit 24-7) _____									
Maximum number of lanes, N _w (max) (Exhibit 24-7) _____									
<input type="checkbox"/> If N _w < N _w (max) unconstrained operation					<input type="checkbox"/> If N _w ≥ N _w (max) constrained operation				
Weaving Segment Speed, Density, Level of Service, and Capacity									
Weaving segment speed, S (km/h) $S = \left(\frac{v_w}{S_w}\right) \left(\frac{v_{nw}}{S_{nw}}\right)$									
Weaving segment density, D (pc/km/ln) $D = \frac{w_w}{S}$									
Level of service, LOS (Exhibit 24-2)									
Capacity for base condition, c _b (pc/h) (Exhibit 24-8)									
Capacity as a 15-min flow rate, c (veh/h) $c = c_b * f_{HV} * f_p$									
Capacity as a full-hour volume, c _h (veh/h) $c_h = c(PHF)$									

IV. EXAMPLE PROBLEMS

Problem No.	Description	Application
1	Determine level of service of a major weaving segment	Operational (LOS)
2	Determine level of service of a ramp-weaving segment	Operational (LOS)
3	Determine level of service of a ramp-weaving segment with constrained operation	Operational (LOS)
4	Design a major weaving segment for a desired level of service	Design (N, L, Type)
5	Design a weaving segment using sensitivity analysis	Planning (N, L, Type)

EXAMPLE PROBLEM 1

The Weaving Segment A major weaving segment on an urban freeway as shown on the worksheet.

The Question What are the level of service and capacity of the weaving segment?

The Facts

- √ Volume (A-C) = 1,815 veh/h,
- √ Volume (A-D) = 692 veh/h,
- √ Volume (B-C) = 1,037 veh/h,
- √ Volume (B-D) = 1,297 veh/h,
- √ 10 percent trucks,
- √ PHF = 0.91,
- √ Level terrain,
- √ Drivers are regular commuters,
- √ FFS = 110 km/h for freeway, and
- √ Weaving segment length = 450 m.

Comments

- √ Use Chapter 23, "Basic Freeway Segments," to identify f_{HV} and f_p .

Outline of Solution All input parameters are known, so no default values are required. Demand volumes are converted to flow rates, and weaving configuration type is determined. Weaving and nonweaving speeds are computed and used to determine weaving segment speed. The density in the weaving segment is calculated, and level of service is determined. Finally, capacity is determined.

Steps

1. Convert volume (veh/h) to flow rate (pc/h) (use Equation 24-1).	$v = \frac{V}{(PHF)(f_{HV})(f_p)}$ $v(A-C) = \frac{1,815}{(0.91)(0.952)(1.000)} = 2,095 \text{ pc/h}$ $v(A-D) = 799 \text{ pc/h}$ $v(B-C) = 1,197 \text{ pc/h}$ $v(B-D) = 1,497 \text{ pc/h}$
1a. Determine f_p (use Chapter 23).	$f_p = 1.000$
1b. Determine f_{HV} (use Chapter 23).	$f_{HV} = \frac{1}{1 + P_T(E_T - 1) + P_R(E_R - 1)}$ $f_{HV} = \frac{1}{1 + 0.10(1.5 - 1) + 0} = 0.952$
2. Determine weaving segment configuration type (use Exhibit 24-5).	Type B (Movement A-D requires one lane change; Movement B-C requires none)
3. Compute critical variables.	$v_w = 1,197 + 799 = 1,996 \text{ pc/h}$ $v_{nw} = 2,095 + 1,497 = 3,592 \text{ pc/h}$ $v = 1,996 + 3,592 = 5,588 \text{ pc/h}$ $VR = \frac{1,996}{5,588} = 0.357$ $R = \frac{799}{1,996} = 0.400$

4. Compute weaving and nonweaving speeds assuming unconstrained operation (use Exhibit 24-6 and Equations 24-3 and 24-4).	$W_i = \frac{a(1+VR)^b \left(\frac{v}{N}\right)^c}{(3.28L)^d} \quad S_i = 24 + \frac{S_{FF} - 16}{1 + W_i}$ $W_w = \frac{0.08(1+0.357)^{2.2} \left(\frac{5,588}{4}\right)^{0.70}}{(3.28 * 450)^{0.50}} = 0.648$ $W_{nw} = \frac{0.0020(1+0.357)^{6.0} \left(\frac{5,588}{4}\right)^{1.0}}{(3.28 * 450)^{0.50}} = 0.454$ $S_w = 24 + \frac{110 - 16}{1 + 0.648} = 81.0 \text{ km/h}$ $S_{nw} = 24 + \frac{110 - 16}{1 + 0.454} = 88.6 \text{ km/h}$
5. Check type of operation (use Exhibit 24-7).	$N_w = 4[0.085 + 0.703(0.357) + (71.57/450) - 0.0112(88.6 - 81.0)] = 1.64$ $N_w(\text{max}) = 3.5, \text{ therefore unconstrained operation}$
6. Compute weaving segment speed (use Equation 24-5).	$S = \frac{v}{\left(\frac{v_w}{S_w}\right) + \left(\frac{v_{nw}}{S_{nw}}\right)} = \frac{5,588}{\left(\frac{1,996}{81.0}\right) + \left(\frac{3,592}{88.6}\right)} = 85.7 \text{ km/h}$
7. Compute weaving segment density (use Equation 24-6).	$D = \frac{\left(\frac{v}{N}\right)}{S} = \frac{\left(\frac{5,588}{4}\right)}{85.7} = 16.3 \text{ pc/km/ln}$
8. Determine level of service (use Exhibit 24-2).	LOS C
9. Determine weaving segment capacity (use Exhibit 24-8 and Equations 24-7 and 24-8).	$c_b = 8,421 \text{ pc/h [Exhibit 24-8(F)]}$ $c = c_b * f_{HV} * f_p = 8,421 * 0.952 * 1.000 = 8,017 \text{ veh/h}$ $c_h = c * PHF = 8,017 * 0.91 = 7,295 \text{ veh/h}$

The Results This weaving segment will operate at LOS C during the peak hour. Weaving segment density is 16.3 pc/km/ln. The capacity of the weaving segment is estimated as 8,020 veh/h (for the 15-min volume), or 7,290 veh/h (for the full-hour volume).

Example Problem 1

FREEWAY WEAVING WORKSHEET									
General Information					Site Information				
Analyst	M.E.				Freeway/Direction of Travel	-			
Agency or Company	CEI				Weaving Segment Location	-			
Date Performed	8/3/99				Jurisdiction	-			
Analysis Time Period	AM-Peak				Analysis Year	1999			
<input checked="" type="checkbox"/> Operational (LOS)		<input type="checkbox"/> Design (N, L, Type)			<input type="checkbox"/> Planning (LOS)		<input type="checkbox"/> Planning (N, L, Type)		
Inputs									
					Freeway free-flow speed, $S_{FF} =$ <u>110</u> km/h Weaving number of lanes, $N =$ <u>4</u> Weaving segment length, $L =$ <u>450</u> m Terrain <input checked="" type="checkbox"/> Level <input type="checkbox"/> Rolling Weaving type <input type="checkbox"/> Type A <input checked="" type="checkbox"/> Type B <input type="checkbox"/> Type C Volume ratio, $VR = \frac{V_w}{V} =$ <u>0.357</u> Weaving ratio, $R = \frac{V_{w2}}{V_w} =$ <u>0.400</u>				
Sketch (show lanes, L, V_{01} , V_{02} , V_{w1} , V_{w2})									
Conversion to pc/h Under Base Conditions									
(pc/h)	AADT (veh/day)	K	D	V (veh/h)	PHF	% HV	f_{HV}	f_p	$v = \frac{V}{PHF * f_{HV} * f_p}$
V_{01}				1,815	0.91	10	0.952	1.000	2,095
V_{02}				1,297	0.91	10	0.952	1.000	1,497
V_{w1}				1,037	0.91	10	0.952	1.000	1,197
V_{w2}				692	0.91	10	0.952	1.000	799
V_w				1,729	0.91	10	0.952	1.000	1,996
V_{nw}				3,112	0.91	10	0.952	1.000	3,592
V				4,841	0.91	10	0.952	1.000	5,588
Weaving and Nonweaving Speeds									
				Unconstrained		Constrained			
				Weaving (i = w)	Nonweaving (i = nw)	Weaving (i = w)	Nonweaving (i = nw)		
a (Exhibit 24-6)				0.08	0.0020				
b (Exhibit 24-6)				2.2	6.0				
c (Exhibit 24-6)				0.70	1.0				
d (Exhibit 24-6)				0.50	0.50				
Weaving intensity factor, W_i $W_i = \frac{a(1+VR)^b (vN)^c}{(3.28L)^d}$				0.648	0.454				
Weaving and nonweaving speeds, S_i (km/h) $S_i = 24 + \frac{S_{FF} - 16}{1 + W_i}$				81.0	88.6				
Number of lanes required for unconstrained operation, N_w (Exhibit 24-7)				<u>1.64</u>					
Maximum number of lanes, $N_w(max)$ (Exhibit 24-7)				<u>3.5</u>					
<input checked="" type="checkbox"/> If $N_w < N_w(max)$ unconstrained operation				<input type="checkbox"/> If $N_w \geq N_w(max)$ constrained operation					
Weaving Segment Speed, Density, Level of Service, and Capacity									
Weaving segment speed, S (km/h) $S = \left(\frac{V_w}{S_w} \right) \left(\frac{V_{nw}}{S_{nw}} \right)$				85.7					
Weaving segment density, D (pc/km/ln) $D = \frac{VN}{S}$				16.3					
Level of service, LOS (Exhibit 24-2)				C					
Capacity for base condition, c_b (pc/h) (Exhibit 24-8)				8,421					
Capacity as a 15-min flow rate, c (veh/h) $c = c_b * f_{HV} * f_p$				8,017					
Capacity as a full-hour volume, c_n (veh/h) $c_n = c(PHF)$				7,295					

EXAMPLE PROBLEM 2

The Weaving Segment A ramp-weaving segment on a rural freeway as shown on the worksheet.

The Question What are the level of service and capacity of the weaving segment?

The Facts

- √ Flow rate (A-C) = 4,000 pc/h,
- √ Flow rate (B-C) = 600 pc/h,
- √ FFS = 120 km/h for freeway,
- √ Flow rate (A-D) = 300 pc/h,
- √ Flow rate (B-D) = 100 pc/h, and
- √ Weaving segment length = 300 m.

Outline of Solution All input parameters are known, so no default values are required. Demand flows are given as equivalent passenger cars per hour under base conditions. Thus, no conversion of flows is required. Weaving configuration type is determined. Weaving and nonweaving speeds are computed, followed by weaving segment speed. The density in the weaving segment is calculated, and level of service is determined. Capacity is then determined.

Steps

1. Determine weaving segment configuration type (use Exhibit 24-5).	Type A (Movements A-D and B-C require one lane change)
2. Compute critical variables.	$v_w = 600 + 300 = 900 \text{ pc/h}$ $v_{nw} = 4,000 + 100 = 4,100 \text{ pc/h}$ $v = 900 + 4,100 = 5,000 \text{ pc/h}$ $VR = \frac{900}{5,000} = 0.180$ $R = \frac{300}{900} = 0.333$
3. Compute weaving and nonweaving speeds assuming unconstrained operation (use Exhibit 24-6 and Equations 24-3 and 24-4).	$W_i = \frac{a(1+VR)^b \left(\frac{v}{N}\right)^c}{(3.28L)^d} \quad S_i = 24 + \frac{S_{FF} - 16}{1 + W_i}$ $W_w = \frac{0.15(1+0.180)^{2.2} \left(\frac{5,000}{4}\right)^{0.97}}{(3.28 * 300)^{0.80}} = 0.879$ $W_{nw} = \frac{0.0035(1+0.180)^{4.0} \left(\frac{5,000}{4}\right)^{1.3}}{(3.28 * 300)^{0.75}} = 0.410$ $S_w = 24 + \frac{120 - 16}{1 + 0.879} = 79.3 \text{ km/h}$ $S_{nw} = 24 + \frac{120 - 16}{1 + 0.410} = 97.8 \text{ km/h}$
4. Check type of operation (use Exhibit 24-7).	$N_w = 1.21(N)VR^{0.571}L^{0.234}/S_w^{0.438}$ $N_w = \frac{1.21(4)(0.180^{0.571})(300^{0.234})}{79.3^{0.438}} = 1.02$ <p>$N_w(\text{max}) = 1.4$, therefore unconstrained operation</p>
5. Compute weaving segment speed (use Equation 24-5).	$S = \frac{v}{\left(\frac{v_w}{S_w}\right) + \left(\frac{v_{nw}}{S_{nw}}\right)} = \frac{5,000}{\left(\frac{900}{79.3}\right) + \left(\frac{4,100}{97.8}\right)} = 93.9 \text{ km/h}$

6. Compute weaving segment density (use Equation 24-6).	$D = \frac{\left(\frac{v}{N}\right)}{S} = \frac{\left(\frac{5,000}{4}\right)}{93.9} = 13.3 \text{ pc/km/ln}$
7. Determine level of service (use Exhibit 24-2).	LOS C
8. Determine weaving segment capacity (use Exhibit 24-8).	$c_b = 8,474 \text{ pc/h}$ [Exhibit 24-8(A)]

The Results This weaving segment will operate at LOS C during the peak hour. The weaving segment density is 13.3 pc/km/ln, and the capacity is estimated to be 8,470 pc/h. Because neither the traffic composition nor the PHF is specified, capacities per full hour and for prevailing conditions cannot be determined.

Example Problem 2

FREeway WEAVING WORKSHEET									
General Information					Site Information				
Analyst	M.E.				Freeway/Direction of Travel	-			
Agency or Company	CEI				Weaving Segment Location	-			
Date Performed	8/3/99				Jurisdiction	-			
Analysis Time Period	AM-Peak				Analysis Year	1999			
<input checked="" type="checkbox"/> Operational (LOS)		<input type="checkbox"/> Design (N, L, Type)			<input type="checkbox"/> Planning (LOS)		<input type="checkbox"/> Planning (N, L, Type)		
Inputs									
<p style="text-align: center;">Sketch (show lanes, L, v₀₁, v₀₂, v_{w1}, v_{w2})</p>					Freeway free-flow speed, S _{FF} = <u>120</u> km/h Weaving number of lanes, N = <u>4</u> Weaving segment length, L = <u>300</u> m Terrain <input type="checkbox"/> Level <input type="checkbox"/> Rolling Weaving type <input checked="" type="checkbox"/> Type A <input type="checkbox"/> Type B <input type="checkbox"/> Type C Volume ratio, VR = $\frac{v_w}{v}$ = <u>0.180</u> Weaving ratio, R = $\frac{v_{w2}}{v_w}$ = <u>0.333</u>				
Conversion to pc/h Under Base Conditions									
(pc/h)	AADT (veh/day)	K	D	V (veh/h)	PHF	% HV	f _{HV}	f _p	$v = \frac{V}{PHF * f_{HV} * f_p}$
v ₀₁									4,000
v ₀₂									100
v _{w1}									600
v _{w2}									300
v _w									900
v _{nw}									4,100
v									5,000
Weaving and Nonweaving Speeds									
		Unconstrained			Constrained				
		Weaving (i = w)		Nonweaving (i = nw)		Weaving (i = w)		Nonweaving (i = nw)	
a (Exhibit 24-6)		0.15		0.0035					
b (Exhibit 24-6)		2.2		4.0					
c (Exhibit 24-6)		0.97		1.3					
d (Exhibit 24-6)		0.80		0.75					
Weaving intensity factor, W _i									
$W_i = \frac{a(1+VR)^b (v/N)^c}{(3.28L)^d}$		0.879		0.410					
Weaving and nonweaving speeds, S _i (km/h)									
$S_i = 24 + \frac{S_{FF} - 16}{1 + W_i}$		79.3		97.8					
Number of lanes required for unconstrained operation, N _w (Exhibit 24-7)		1.02							
Maximum number of lanes, N _w (max) (Exhibit 24-7)		1.4							
<input checked="" type="checkbox"/> If N _w < N _w (max) unconstrained operation		<input type="checkbox"/> If N _w ≥ N _w (max) constrained operation							
Weaving Segment Speed, Density, Level of Service, and Capacity									
Weaving segment speed, S (km/h)	$S = \left(\frac{v_w}{S_w}\right) \left(\frac{v_{nw}}{S_{nw}}\right)$								
	93.9								
Weaving segment density, D (pc/km/ln)	$D = \frac{v/N}{S}$								
	13.3								
Level of service, LOS (Exhibit 24-2)	C								
Capacity for base condition, c _b (pc/h) (Exhibit 24-8)	8,474								
Capacity as a 15-min flow rate, c (veh/h)	-								
$c = c_b * f_{HV} * f_p$	-								
Capacity as a full-hour volume, c _h (veh/h)	-								
$c_h = c(PHF)$	-								

EXAMPLE PROBLEM 3

The Weaving Segment A ramp-weaving segment on an urban freeway as shown on the worksheet.

The Question What are the level of service and capacity of the weaving segment?

The Facts

- √ Volume (A-C) = 975 veh/h,
- √ Volume (A-D) = 650 veh/h,
- √ Volume (B-C) = 520 veh/h,
- √ Volume (B-D) = 0 veh/h,
- √ 15 percent trucks,
- √ PHF = 0.85,
- √ Rolling terrain,
- √ Drivers are regular commuters,
- √ FFS = 110 km/h for freeway, and
- √ Weaving segment length = 300 m.

Comments

- √ Use Chapter 23, "Basic Freeway Segments," to identify f_{HV} and f_p .

Outline of Solution All input parameters are known, so no default values are required. Demand volumes are converted to flow rates, and weaving configuration type is determined. Weaving and nonweaving speeds are computed and used to determine weaving segment speed. The density in the weaving segment is calculated, and level of service is determined. Capacity is then determined.

Steps

<p>1. Convert volume (veh/h) to flow rate (pc/h) (use Equation 24-1).</p>	$v = \frac{V}{(PHF)(f_{HV})(f_p)}$ $v(A-C) = \frac{975}{(0.85)(0.816)(1.000)} = 1,406 \text{ pc/h}$ $v(A-D) = 937 \text{ pc/h}$ $v(B-C) = 750 \text{ pc/h}$
<p>1a. Determine f_p (use Chapter 23).</p>	$f_p = 1.000$
<p>1b. Determine f_{HV} (use Chapter 23).</p>	$f_{HV} = \frac{1}{1 + P_T(E_T - 1) + P_R(E_R - 1)}$ $f_{HV} = \frac{1}{1 + 0.15(2.5 - 1) + 0} = 0.816$
<p>2. Determine weaving segment configuration type (use Exhibit 24-5).</p>	<p>Type A (all weaving vehicles must make one lane change)</p>
<p>3. Compute critical variables.</p>	$v_w = 937 + 750 = 1,687 \text{ pc/h}$ $v_{nw} = 1,406 \text{ pc/h}$ $v = 1,406 + 1,687 = 3,093 \text{ pc/h}$ $VR = \frac{1,687}{3,093} = 0.545 \quad R = \frac{750}{1,687} = 0.445$

<p>4. Compute weaving and nonweaving speeds assuming unconstrained operation (use Exhibit 24-6 and Equations 24-3 and 24-4).</p>	$W_i = \frac{a(1+VR)^b \left(\frac{v}{N}\right)^c}{(3.28L)^d} \quad S_i = 24 + \frac{S_{FF} - 16}{1 + W_i}$ $W_w = \frac{0.15(1+0.545)^{2.2} \left(\frac{3,093}{3}\right)^{0.97}}{(3.28 * 300)^{0.80}} = 1.319$ $W_{nw} = \frac{0.0035(1+0.545)^{4.0} \left(\frac{3,093}{3}\right)^{1.3}}{(3.28 * 300)^{0.75}} = 0.938$ $S_w = 24 + \frac{110 - 16}{1 + 1.319} = 64.5 \text{ km/h}$ $S_{nw} = 24 + \frac{110 - 16}{1 + 0.938} = 72.5 \text{ km/h}$
<p>5. Check type of operation (use Exhibit 24-7).</p>	$N_w = 1.21(N)VR^{0.571}L^{0.234}/S_w^{0.438}$ $N_w = 1.21(3)(0.545^{0.571})(300^{0.234})/64.5^{0.438} = 1.57$ $N_w(\text{max}) = 1.4, \text{ therefore constrained operation}$
<p>6. Repeat Step 4 for constrained operation.</p>	$W_w = \frac{0.35(1+0.545)^{2.2} \left(\frac{3,093}{3}\right)^{0.97}}{(3.28 * 300)^{0.80}} = 3.077$ $W_{nw} = \frac{0.0020(1+0.545)^{4.0} \left(\frac{3,093}{3}\right)^{0.97}}{(3.28 * 300)^{0.75}} = 0.536$ $S_w = 24 + \frac{110 - 16}{1 + 3.077} = 47.1 \text{ km/h}$ $S_{nw} = 24 + \frac{110 - 16}{1 + 0.536} = 85.2 \text{ km/h}$
<p>7. Compute weaving segment speed (use Equation 24-5).</p>	$S = \frac{v}{\left(\frac{v_w}{S_w}\right) + \left(\frac{v_{nw}}{S_{nw}}\right)} = \frac{3,093}{\left(\frac{1,687}{47.1}\right) + \left(\frac{1,406}{85.2}\right)} = 59.1 \text{ km/h}$
<p>8. Compute weaving segment density (use Equation 24-6).</p>	$D = \frac{\left(\frac{v}{N}\right)}{S} = \frac{\left(\frac{3,093}{3}\right)}{59.1} = 17.4 \text{ pc/km/ln}$
<p>9. Determine level of service (use Exhibit 24-2).</p>	<p>LOS D</p>
<p>10. Determine weaving segment capacity (use Exhibit 24-8 and Equations 24-7 and 24-8).</p>	$c_b = 4,790 \text{ pc/h [Exhibit 24-8(B)]}$ $c = c_b * f_{HV} * f_p = 4,790 * 0.816 * 1.000 = 3,909 \text{ veh/h}$ $c_h = c * PHF = 3,909 * 0.85 = 3,323 \text{ veh/h}$

The Results The weaving segment will operate at LOS D during the peak hour. The weaving segment density is 17.4 pc/km/ln, and the capacity is estimated as 3,910 veh/h (for the 15-min flow rate), or 3,320 veh/h (for the full-hour volume). Note that the three-lane ramp-weave has a volume ratio of 0.545, which exceeds the maximum recommended for such segments (0.45). Thus, operations may actually be worse than predicted.

The capacity estimates must also be carefully considered. They reflect the maximum VR that is tabulated for Type A, three-lane weaving segments (0.45). The actual value for a VR of 0.545 would be expected to be lower than the values shown.

One approach to improving operations would be to change the configuration (Type A segments do not handle volume ratios of 0.545 efficiently) to Type B by adding a lane to the off-ramp on Leg D. This lane, not needed for general purposes, would have to be

dropped or designed into the ramp's other terminus. This calculation, in effect, emphasizes the importance of configuration. The Type A configuration is not appropriate for the balance of flows presented.

Example Problem 3

FREEWAY WEAVING WORKSHEET									
General Information					Site Information				
Analyst	M.E.				Freeway/Direction of Travel	-			
Agency or Company	CEI				Weaving Segment Location	-			
Date Performed	8/9/99				Jurisdiction	-			
Analysis Time Period	AM-Peak				Analysis Year	1999			
<input checked="" type="checkbox"/> Operational (LOS)		<input type="checkbox"/> Design (N, L, Type)			<input type="checkbox"/> Planning (LOS)			<input type="checkbox"/> Planning (N, L, Type)	
Inputs									
					Freeway free-flow speed, $S_{FF} = 110$ km/h Weaving number of lanes, $N = 3$ Weaving segment length, $L = 300$ m Terrain <input type="checkbox"/> Level <input checked="" type="checkbox"/> Rolling Weaving type <input checked="" type="checkbox"/> Type A <input type="checkbox"/> Type B <input type="checkbox"/> Type C Volume ratio, $VR = \frac{V_w}{v} = 0.545$ Weaving ratio, $R = \frac{V_{w2}}{V_w} = 0.444$				
Sketch (show lanes, L, v_{01} , v_{02} , v_{w1} , v_{w2})									
Conversion to pc/h Under Base Conditions									
(pc/h)	AADT (veh/day)	K	D	V (veh/h)	PHF	% HV	f_{HV}	f_p	$v = \frac{V}{PHF * f_{HV} * f_p}$
v_{01}				975	0.85	15	0.816	1.000	1,406
v_{02}				0	0.85	15	0.816	1.000	0
v_{w1}				650	0.85	15	0.816	1.000	937
v_{w2}				520	0.85	15	0.816	1.000	750
v_w									1,687
v_{nw}									1,406
v									3,093
Weaving and Nonweaving Speeds									
		Unconstrained			Constrained				
		Weaving (i = w)	Nonweaving (i = nw)	Weaving (i = w)	Nonweaving (i = nw)	Weaving (i = w)	Nonweaving (i = nw)		
a (Exhibit 24-6)		0.15	0.0035	0.35	0.0020				
b (Exhibit 24-6)		2.2	4.0	2.2	4.0				
c (Exhibit 24-6)		0.97	1.3	0.97	1.3				
d (Exhibit 24-6)		0.80	0.75	0.80	0.75				
Weaving intensity factor, W_i $W_i = \frac{a(1+VR)^b (v/N)^c}{(3.28L)^d}$		1.319	0.938	3.077	0.536				
Weaving and nonweaving speeds, S_i (km/h) $S_i = 24 + \frac{S_{FF} - 16}{1 + W_i}$		64.5	72.5	47.1	85.2				
Number of lanes required for unconstrained operation, N_w (Exhibit 24-7)		1.57							
Maximum number of lanes, $N_w(max)$ (Exhibit 24-7)		1.4							
<input type="checkbox"/> If $N_w < N_w(max)$ unconstrained operation		<input checked="" type="checkbox"/> If $N_w \geq N_w(max)$ constrained operation							
Weaving Segment Speed, Density, Level of Service, and Capacity									
Weaving segment speed, S (km/h) $S = \left(\frac{v_w}{S_w}\right) \left(\frac{v_{nw}}{S_{nw}}\right)$	59.1								
Weaving segment density, D (pc/km/ln) $D = \frac{vN}{S}$	17.4								
Level of service, LOS (Exhibit 24-2)	D								
Capacity for base condition, c_b (pc/h) (Exhibit 24-8)	4,790								
Capacity as a 15-min flow rate, c (veh/h) $c = c_b * f_{HV} * f_p$	3,909								
Capacity as a full-hour volume, c_h (veh/h) $c_h = c(PHF)$	3,323								

EXAMPLE PROBLEM 4

The Weaving Segment Alternative major weaving segments are being considered at a major junction between two urban freeways as shown on the worksheets. Several design constraints exist. Entry Leg A (left side) has two lanes; Entry Leg B (right side) has three lanes. Exit Leg C (left side) has three lanes; Exit Leg D (right side) has two lanes. The maximum length of the weaving segment is 300 m. The FFS of all entry and exit legs is 120 km/h.

The Question What are the required number of lanes and weaving segment configuration to achieve LOS C?

The Facts

- √ Flow rate (A-C) = 2,000 pc/h,
- √ Flow rate (A-D) = 1,450 pc/h,
- √ Flow rate (B-C) = 1,500 pc/h,
- √ Flow rate (B-D) = 2,000 pc/h,
- √ FFS = 120 km/h for both freeways, and
- √ Weaving segment length = 300 m.

Outline of Solution Demand flows are given in passenger cars per hour for equivalent base conditions. Therefore, no conversion of flows is required. Weaving number of lanes and configuration are assumed, and LOS is determined. If the LOS is below C, a better configuration is assumed until LOS C or better is achieved.

Steps

1. Assume lane configuration shown on the worksheet.	
2. Determine weaving segment configuration type (use Exhibit 24-5).	Type C (Movement B-C requires no lane change; Movement A-D requires two lane changes).
3. Compute critical variables.	$v_w = 1,500 + 1,450 = 2,950 \text{ pc/h}$ $v_{nw} = 2,000 + 2,000 = 4,000 \text{ pc/h}$ $v = 4,000 + 2,950 = 6,950 \text{ pc/h}$ $VR = \frac{2,950}{6,950} = 0.424$ $R = \frac{1,450}{2,950} = 0.492$
4. Compute weaving and nonweaving speeds assuming unconstrained operation (use Exhibit 24-6 and Equations 24-3 and 24-4).	$W_i = \frac{a(1+VR)^b \left(\frac{v}{N}\right)^c}{(3.28L)^d} \quad S_i = 24 + \frac{S_{FF} - 16}{1 + W_i}$ $W_w = \frac{0.08(1+0.424)^{2.3} \left(\frac{6,950}{5}\right)^{0.80}}{(3.28 * 300)^{0.60}} = 0.944$ $W_{nw} = \frac{0.0020(1+0.424)^{6.0} \left(\frac{6,950}{5}\right)^{1.1}}{(3.28 * 300)^{0.60}} = 0.765$ $S_w = 24 + \frac{120 - 16}{1 + 0.944} = 77.5 \text{ km/h}$ $S_{nw} = 24 + \frac{120 - 16}{1 + 0.765} = 82.9 \text{ km/h}$

5. Check type of operation (use Exhibit 24-7).	$N_w = N[0.761 + 0.047VR - 0.00036L - 0.0031(S_{nw} - S_w)]$ $N_w = 5[0.761 + (0.047 * 0.424) - (0.00036 * 300) - 0.0031(82.9 - 77.5)] = 3.28$ $N_w(\text{max}) = 3.0, \text{ constrained operation}$
6. Repeat Step 4 for constrained operation.	$W_w = \frac{0.14(1 + 0.424)^{2.3} \left(\frac{6,950}{5}\right)^{0.80}}{(3.28 * 300)^{0.60}} = 1.651$ $W_{nw} = \frac{0.0010(1 + 0.424)^{6.0} \left(\frac{6,950}{5}\right)^{1.1}}{(3.28 * 300)^{0.60}} = 0.382$ $S_w = 24 + \frac{120 - 16}{1 + 1.651} = 63.2 \text{ km/h}$ $S_{nw} = 24 + \frac{120 - 16}{1 + 0.382} = 99.3 \text{ km/h}$
7. Compute weaving segment speed (use Equation 24-5).	$S = \frac{v}{\left(\frac{v_w}{S_w}\right) + \left(\frac{v_{nw}}{S_{nw}}\right)} = \frac{6,950}{\left(\frac{2,950}{63.2}\right) + \left(\frac{4,000}{99.3}\right)} = 79.9 \text{ km/h}$
8. Compute weaving segment density (use Equation 24-6).	$D = \frac{\left(\frac{v}{N}\right)}{S} = \frac{\left(\frac{6,950}{5}\right)}{79.9} = 17.4 \text{ pc/km/ln}$
9. Determine level of service (use Exhibit 24-2).	LOS D

Example Problem 4

FREEWAY WEAVING WORKSHEET									
General Information					Site Information				
Analyst		<u>M.E.</u>			Freeway/Direction of Travel		<u>-</u>		
Agency or Company		<u>CEI</u>			Weaving Segment Location		<u>-</u>		
Date Performed		<u>8/9/99</u>			Jurisdiction		<u>-</u>		
Analysis Time Period		<u>AM-Peak</u>			Analysis Year		<u>1999</u>		
<input type="checkbox"/> Operational (LOS)		<input checked="" type="checkbox"/> Design (N, L, Type)			<input type="checkbox"/> Planning (LOS)		<input type="checkbox"/> Planning (N, L, Type)		
Inputs									
<p style="text-align: center;">L = 300 m</p> <p style="text-align: center;">Sketch (show lanes, L, v₀₁, v₀₂, v_{w1}, v_{w2})</p>					Freeway free-flow speed, S _{FF} = <u>120</u> km/h Weaving number of lanes, N = <u>5</u> Weaving segment length, L = <u>300</u> m Terrain <input type="checkbox"/> Level <input type="checkbox"/> Rolling Weaving type <input type="checkbox"/> Type A <input type="checkbox"/> Type B <input checked="" type="checkbox"/> Type C Volume ratio, VR = $\frac{v_w}{v}$ = <u>0.424</u> Weaving ratio, R = $\frac{v_{w2}}{v_w}$ = <u>0.492</u>				
Conversion to pc/h Under Base Conditions									
(pc/h)	AADT (veh/day)	K	D	V (veh/h)	PHF	% HV	f _{HV}	f _p	$v = \frac{V}{PHF * f_{HV} * f_p}$
v ₀₁									2,000
v ₀₂									2,000
v _{w1}									1,500
v _{w2}									1,450
v _w									2,950
v _{nw}									4,000
v									6,950
Weaving and Nonweaving Speeds									
		Unconstrained			Constrained				
		Weaving (i = w)		Nonweaving (i = nw)		Weaving (i = w)		Nonweaving (i = nw)	
a (Exhibit 24-6)		0.08		0.0020		0.14		0.0010	
b (Exhibit 24-6)		2.3		6.0		2.3		6.0	
c (Exhibit 24-6)		0.80		1.1		0.80		1.1	
d (Exhibit 24-6)		0.60		0.60		0.60		0.60	
Weaving intensity factor, W _i $W_i = \frac{a(1 + VR)^b (v/N)^c}{(3.28L)^d}$		0.944		0.765		1.651		0.382	
Weaving and nonweaving speeds, S _i (km/h) $S_i = 24 + \frac{S_{FF} - 16}{1 + W_i}$		77.5		82.9		63.2		99.3	
Number of lanes required for unconstrained operation, N _w (Exhibit 24-7)		<u>3.28</u>							
Maximum number of lanes, N _w (max) (Exhibit 24-7)		<u>3.0</u>							
<input type="checkbox"/> If N _w < N _w (max) unconstrained operation		<input checked="" type="checkbox"/> If N _w ≥ N _w (max) constrained operation							
Weaving Segment Speed, Density, Level of Service, and Capacity									
Weaving segment speed, S (km/h) $S = \left(\frac{v_w}{S_w}\right) \left(\frac{v_{nw}}{S_{nw}}\right)$		79.9							
Weaving segment density, D (pc/km/ln) $D = \frac{v/N}{S}$		17.4							
Level of service, LOS (Exhibit 24-2)		D							
Capacity for base condition, c _b (pc/h) (Exhibit 24-8)									
Capacity as a 15-min flow rate, c (veh/h) $c = c_b * f_{HV} * f_p$									
Capacity as a full-hour volume, c _h (veh/h) $c_h = c(PHF)$									

<p>The trial design just misses the design objective of LOS C. There are other troubling aspects of the results as well. The R value (0.492) exceeds the maximum recommended for Type C segments (0.40), and the segment might, therefore, operate worse than expected. The constrained operating condition produces a large difference in speed between weaving and nonweaving traffic streams. That is also undesirable.</p> <p>There is no additional length available, since the maximum of 300 m has already been used. The width cannot be made six lanes without adding lanes to entry and exit roadways as well, where they are apparently not needed. The only other potential change would be to alter the configuration to a Type B design. This is best accomplished by adding a lane to Leg D. The lane will make weaving more efficient and can be dropped further downstream on Leg D.</p>	
10. Assume lane configuration shown on the worksheet.	
11. Determine weaving segment configuration type (use Exhibit 24-5).	Type B (Movement B-C requires no lane change; Movement A-D requires one lane change).
12. Compute weaving and nonweaving speeds assuming unconstrained operation (use Exhibit 24-6 and Equations 24-3 and 24-4).	$W_i = \frac{a(1+VR)^b \left(\frac{v}{N}\right)^c}{(3.28L)^d} \quad S_i = 24 + \frac{S_{FF} - 16}{1 + W_i}$ $W_w = \frac{0.08(1+0.424)^{2.2} \left(\frac{6,950}{5}\right)^{0.70}}{(3.28 * 300)^{0.50}} = 0.880$ $W_{nw} = \frac{0.0020(1+0.424)^{6.0} \left(\frac{6,950}{5}\right)^{1.0}}{(3.28 * 300)^{0.50}} = 0.739$ $S_w = 24 + \frac{120 - 16}{1 + 0.880} = 79.3 \text{ km/h}$ $S_{nw} = 24 + \frac{120 - 16}{1 + 0.739} = 83.8 \text{ km/h}$
13. Check type of operation (use Exhibit 24-7).	$N_w = N[0.085 + 0.703VR + (71.57/L) - 0.0112(S_{nw} - S_w)]$ $N_w = 5[0.085 + (0.703 * 0.424) + (71.57/300) - 0.0112(83.8 - 79.3)] = 2.86$ $N_w(\text{max}) = 3.5, \text{ unconstrained operation}$
14. Compute weaving segment speed (use Equation 24-5).	$S = \frac{v}{\left(\frac{v_w}{S_w}\right) + \left(\frac{v_{nw}}{S_{nw}}\right)} = \frac{6,950}{\left(\frac{2,950}{79.3}\right) + \left(\frac{4,000}{83.8}\right)} = 81.8 \text{ km/h}$
15. Compute weaving segment density (use Equation 24-6).	$D = \frac{\left(\frac{v}{N}\right)}{S} = \frac{\left(\frac{6,950}{5}\right)}{81.8} = 17.0 \text{ pc/km/ln}$
16. Determine level of service (use Exhibit 24-2).	LOS C

The Results Whereas the level of service does improve to barely provide the desired LOS C, there are many other beneficial effects of providing the Type B configuration. Unconstrained operation prevails, and the difference in speed between the weaving and nonweaving streams is reduced substantially. This calculation illustrates the advantage of a Type B configuration in handling high proportions of weaving traffic.

Example Problem 4

FREeway WEAVING WORKSHEET									
General Information					Site Information				
Analyst	<u>M.E.</u>				Freeway/Direction of Travel	<u>-</u>			
Agency or Company	<u>CEI</u>				Weaving Segment Location	<u>-</u>			
Date Performed	<u>8/9/99</u>				Jurisdiction	<u>-</u>			
Analysis Time Period	<u>AM-Peak</u>				Analysis Year	<u>1999</u>			
<input type="checkbox"/> Operational (LOS)		<input checked="" type="checkbox"/> Design (N, L, Type)			<input type="checkbox"/> Planning (LOS)		<input type="checkbox"/> Planning (N, L, Type)		
Inputs									
<p style="text-align: center;">L = 300 m</p> <p style="text-align: center;">Sketch (show lanes, L, v₀₁, v₀₂, v_{w1}, v_{w2})</p>					Freeway free-flow speed, S _{FF} = <u>120</u> km/h Weaving number of lanes, N = <u>5</u> Weaving segment length, L = <u>300</u> m Terrain <input type="checkbox"/> Level <input type="checkbox"/> Rolling Weaving type <input type="checkbox"/> Type A <input checked="" type="checkbox"/> Type B <input type="checkbox"/> Type C Volume ratio, VR = $\frac{v_w}{v}$ = <u>0.424</u> Weaving ratio, R = $\frac{v_{w2}}{v_w}$ = <u>0.492</u>				
Conversion to pc/h Under Base Conditions									
(pc/h)	AADT (veh/day)	K	D	V (veh/h)	PHF	% HV	f _{HV}	f _p	$v = \frac{V}{PHF * f_{HV} * f_p}$
v ₀₁									2,000
v ₀₂									2,000
v _{w1}									1,500
v _{w2}									1,450
v _w									2,950
v _{nw}									4,000
v									6,950
Weaving and Nonweaving Speeds									
					Unconstrained		Constrained		
					Weaving (i = w)	Nonweaving (i = nw)	Weaving (i = w)	Nonweaving (i = nw)	
a (Exhibit 24-6)					0.08	0.0020			
b (Exhibit 24-6)					2.2	6.0			
c (Exhibit 24-6)					0.70	1.0			
d (Exhibit 24-6)					0.50	0.50			
Weaving intensity factor, W _i $W_i = \frac{a(1+VR)^b (v/N)^c}{(3.28L)^d}$					0.880	0.739			
Weaving and nonweaving speeds, S _i (km/h) $S_i = 24 + \frac{S_{FF} - 16}{1 + W_i}$					79.3	83.8			
Number of lanes required for unconstrained operation, N _w (Exhibit 24-7)					<u>2.86</u>				
Maximum number of lanes, N _w (max) (Exhibit 24-7)					<u>3.5</u>				
<input checked="" type="checkbox"/> If N _w < N _w (max) unconstrained operation					<input type="checkbox"/> If N _w ≥ N _w (max) constrained operation				
Weaving Segment Speed, Density, Level of Service, and Capacity									
Weaving segment speed, S (km/h) $S = \left(\frac{v_w}{S_w}\right) \left(\frac{v_{nw}}{S_{nw}}\right)$					81.8				
Weaving segment density, D (pc/km/ln) $D = \frac{vN}{S}$					17.0				
Level of service, LOS (Exhibit 24-2)					C				
Capacity for base condition, c _b (pc/h) (Exhibit 24-8)									
Capacity as a 15-min flow rate, c (veh/h) $c = c_b * f_{HV} * f_p$									
Capacity as a full-hour volume, c _h (veh/h) $c_h = c(PHF)$									

EXAMPLE PROBLEM 5

The Weaving Segment A major interchange is to be built to join two major freeways in a suburban area.

The Question What are the required number of lanes, length, and configuration of the weaving segment to achieve LOS C operation?

The Facts The flows analyzed are shown in the weaving diagram below. The flow rates are given in passenger cars per hour under base conditions. Since the interchange will join two future facilities, there is considerable flexibility in both the length and the width of the segment. The free-flow speed is 120 km/h.

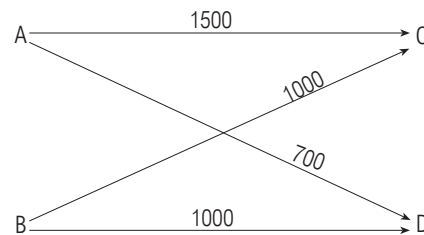

The Results Since the length, width, and configuration to be used are open to question, so is the issue of whether to have a weaving segment at all. Speed, density, and level of service will be determined from trial computations for a range of conditions covering three, four, and five lanes, with the length ranging from 150 m to 750 m. All three types of weaving configuration will also be evaluated. This is a time-consuming process, and the use of a programmable calculator or spreadsheet is recommended. The analysis results are shown in the table on the next page.

A number of points should be made concerning the results and the effect on the final design decision.

1. Before all the potential solutions are examined, the configuration of entry and exit legs should be considered. To provide for minimum LOS C, two lanes are needed on each entry and exit leg. The five-lane option is eliminated because the four-lane option is able to meet the criteria.

2. If the legs are simply connected, a four-lane Type A configuration will result, and LOS C is produced. The main drawback of this configuration is that the operation is constrained. This indicates serious imbalance between weaving and nonweaving flows. Also, the VR of 0.405 is higher than the maximum recommended for Type A, 0.35. Traffic operation may be worse than predicted here.

3. There is no easy way to produce a Type C configuration given the criteria for entry and exit legs.

4. A Type B configuration can be achieved by adding one lane to Leg C. The resulting four-lane Type B segment will operate within all recommended parameters and meet minimum required LOS C for all lengths evaluated. A three-lane Type B configuration will result if a lane is merged at the entrance to and diverged at the exit from the segment. LOS C can also be met with three lanes if the length is 300 m or longer.

The results do not yield a clear answer, but they provide the analyst with the information to make a judgment. Obviously, the best operation will result from a long Type B segment with four lanes. However, economic and environmental considerations will also affect the final decision.

No. of Lanes	L (m)	S (km/h)	D (pc/km/ln)	LOS	Cons Y/N
Type A Configurations					
3	150	59.3	23.6	E	N
	300	72.5	19.3	D	N
	450	80.6	17.4	D	N
	600	79.3	17.7	D	Y
	750	83.5	16.8	C	Y
4	150	61.9	17.0	C	Y
	300	73.7	14.2	C	Y
	450	81.2	12.9	C	Y
	600	86.5	12.1	C	Y
	750	90.5	11.6	B	Y
5	150	66.9	12.6	C	Y
	300	79.2	10.6	B	Y
	450	86.6	9.7	B	Y
	600	91.7	9.2	B	Y
	750	95.5	8.8	B	Y
Type B Configurations					
3	150	74.3	18.8	D	N
	300	83.3	16.8	C	N
	450	88.3	15.8	C	N
	600	91.8	15.3	C	N
	750	94.4	14.8	C	N
4	150	80.7	13.0	C	N
	300	89.4	11.7	B	N
	450	94.2	11.1	B	N
	600	97.4	10.8	B	N
	750	99.7	10.5	B	N
5	150	83.3	10.1	B	Y
	300	94.0	8.9	B	N
	450	98.4	8.5	B	N
	600	101.4	8.3	B	N
	750	103.5	8.1	B	N
Type C Configurations					
3	150	71.2	19.7	D	N
	300	82.0	17.1	D	N
	450	88.1	15.9	C	N
	600	92.2	15.2	C	N
	750	95.3	14.7	C	N
4	150	78.4	13.4	C	N
	300	88.9	11.8	B	N
	450	94.6	11.1	B	N
	600	98.4	10.7	B	N
	750	101.1	10.4	B	N
5	150	82.6	10.2	B	Y
	300	92.2	9.1	B	Y
	450	99.2	8.5	B	N
	600	102.7	8.2	B	N
	750	105.2	8.0	B	N

Note:
Cons—constrained flow; Y/N—yes/no.

V. REFERENCES

1. Reilly, W. R., J. H. Kell, and P. J. Johnson. *Weaving Analysis Procedures for the New Highway Capacity Manual*. Technical Report. JHK & Associates, Tucson, Ariz., 1984.
2. Pignataro, L. J., W. R. McShane, R. P. Roess, B. Lee, and K. W. Crowley. *NCHRP Report 159: Weaving Areas: Design and Analysis*. TRB, National Research Council, Washington, D.C., 1975.
3. Roess, R. P., et al. *Freeway Capacity Analysis Procedures*. Final Report, Project DOT-FH-11-9336. Polytechnic Institute of New York, Brooklyn, 1979.
4. McShane, W. R., R. P. Roess, and E. S. Prassas. *Traffic Engineering*, 2nd ed. Prentice-Hall, Upper Saddle River, N.J., 1998.
5. Jack E. Leisch & Associates. *Completion of Procedures for Analysis and Design of Traffic Weaving Sections*. Final Report. Federal Highway Administration, U.S. Department of Transportation, 1983.
6. Roess, R. P. Development of Weaving Area Analysis Procedures for the 1985 *Highway Capacity Manual*. In *Transportation Research Record 1112*, TRB, National Research Council, Washington, D.C., 1987, pp. 17–22.
7. Fazio, J. *Development and Testing of a Weaving Operational Analysis and Design Procedure*. Master's thesis. University of Illinois at Chicago, Aug. 1985.

APPENDIX A. WORKSHEET

FREEWAY WEAVING WORKSHEET

FREEWAY WEAVING WORKSHEET									
General Information					Site Information				
Analyst _____					Freeway/Direction of Travel _____				
Agency or Company _____					Weaving Segment Location _____				
Date Performed _____					Jurisdiction _____				
Analysis Time Period _____					Analysis Year _____				
<input type="checkbox"/> Operational (LOS)		<input type="checkbox"/> Design (N, L, Type)			<input type="checkbox"/> Planning (LOS)			<input type="checkbox"/> Planning (N, L, Type)	
Inputs									
Sketch (show lanes, L, v _{o1} , v _{o2} , v _{w1} , v _{w2})					Freeway free-flow speed, S _{FF} = _____ km/h				
					Weaving number of lanes, N = _____				
					Weaving segment length, L = _____ m				
					Terrain <input type="checkbox"/> Level <input type="checkbox"/> Rolling				
					Weaving type <input type="checkbox"/> Type A <input type="checkbox"/> Type B <input type="checkbox"/> Type C				
					Volume ratio, VR = $\frac{V_w}{V}$ _____				
					Weaving ratio, R = $\frac{V_{w2}}{V_w}$ _____				
Conversion to pc/h Under Base Conditions									
(pc/h)	AADT (veh/day)	K	D	V (veh/h)	PHF	% HV	f _{HV}	f _p	$v = \frac{V}{PHF * f_{HV} * f_p}$
v _{o1}									
v _{o2}									
v _{w1}									
v _{w2}									
v _w									
v _{nw}									
v									
Weaving and Nonweaving Speeds									
					Unconstrained		Constrained		
					Weaving (i = w)	Nonweaving (i = nw)	Weaving (i = w)	Nonweaving (i = nw)	
a (Exhibit 24-6)									
b (Exhibit 24-6)									
c (Exhibit 24-6)									
d (Exhibit 24-6)									
Weaving intensity factor, W _i	$W_i = \frac{a(1 + VR)^b (v/N)^c}{(3.28L)^d}$								
Weaving and nonweaving speeds, S _i (km/h)	$S_i = 24 + \frac{S_{FF} - 16}{1 + W_i}$								
Number of lanes required for unconstrained operation, N _w (Exhibit 24-7) _____									
Maximum number of lanes, N _{w(max)} (Exhibit 24-7) _____									
<input type="checkbox"/> If N _w < N _{w(max)} unconstrained operation					<input type="checkbox"/> If N _w ≥ N _{w(max)} constrained operation				
Weaving Segment Speed, Density, Level of Service, and Capacity									
Weaving segment speed, S (km/h)	$S = \left(\frac{V_w}{S_w} + \frac{V_{nw}}{S_{nw}} \right)$								
Weaving segment density, D (pc/km/ln)	$D = \frac{v/N}{S}$								
Level of service, LOS (Exhibit 24-2)									
Capacity for base condition, c _b (pc/h) (Exhibit 24-8)									
Capacity as a 15-min flow rate, c (veh/h)	$c = c_b * f_{HV} * f_p$								
Capacity as a full-hour volume, c _h (veh/h)	c _h = c(PHF)								

CHAPTER 25

RAMPS AND RAMP JUNCTIONS

CONTENTS

I.	INTRODUCTION	25-1
	Scope of the Methodology	25-1
	Limitations of the Methodology	25-1
II.	METHODOLOGY	25-1
	Ramp Roadways	25-3
	LOS	25-4
	Merge Influence Areas	25-5
	Predicting Flow Entering Lanes 1 and 2 (v_{12})	25-5
	Determining Capacity	25-7
	Determining LOS	25-8
	Special Cases	25-8
	Two-Lane On-Ramps	25-8
	Lane Additions	25-9
	Major Merge Areas	25-9
	On-Ramps on Ten-Lane Freeway (Five Lanes in Each Direction)	25-10
	Left-Hand On-Ramps	25-11
	Effects of Ramp Control at On-Ramps	25-11
	Diverge Influence Areas	25-11
	Predicting Flow Entering Lanes 1 and 2 (v_{12})	25-12
	Determining Capacity	25-14
	Determining LOS	25-14
	Special Cases	25-15
	Two-Lane Off-Ramps	25-15
	Lane Drops	25-16
	Major Diverge Areas	25-16
	Off-Ramps on Ten-Lane Freeways (Five Lanes in One Direction)	25-17
	Left-Hand Off-Ramps	25-17
	Overlapping Ramp Influence Areas	25-17
	Determining Speed at Ramp Influence Areas	25-18
III.	APPLICATIONS	25-19
	Computational Steps	25-20
	Planning Applications	25-20
	Analysis Tools	25-22
IV.	EXAMPLE PROBLEMS	25-23
	Example Problem 1	25-24
	Example Problem 2 (Part I)	25-26
	Example Problem 2 (Part II)	25-28
	Example Problem 3 (Part I)	25-30
	Example Problem 3 (Part II)	25-32
	Example Problem 4	25-34
	Example Problem 5	25-36
	Example Problem 6	25-38
V.	REFERENCES	25-40
	APPENDIX A. WORKSHEET	25-40
	Ramps and Ramp Junctions Worksheet	

EXHIBITS

Exhibit 25-1. Ramps and Ramp Junctions Methodology 25-2

Exhibit 25-2. Critical Ramp Junction Variables 25-2

Exhibit 25-3. Approximate Capacity of Ramp Roadways 25-4

Exhibit 25-4. LOS Criteria for Merge and Diverge Areas 25-5

Exhibit 25-5. Models for Predicting v_{12} at On-Ramps 25-6

Exhibit 25-6. Selecting Equations for P_{FM} for Six-Lane Freeways 25-6

Exhibit 25-7. Capacity Values for Merge Areas 25-8

Exhibit 25-8. Typical Two-Lane On-Ramp 25-9

Exhibit 25-9. Major Merge Area with One Fewer Lane Leaving Influence Area 25-10

Exhibit 25-10. Major Merge Area with Equal Number of Lanes Leaving
Influence Area 25-10

Exhibit 25-11. Flow in Lane 5 of Freeway Approaching Single-Lane, Right-Side
On-Ramp 25-11

Exhibit 25-12. Models for Predicting v_{12} at Off-Ramps 25-12

Exhibit 25-13. Selecting Equations for P_{FD} for Six-Lane Freeways 25-13

Exhibit 25-14. Capacity Values for Diverge Areas 25-14

Exhibit 25-15. Common Geometries for Two-Lane Off-Ramps 25-15

Exhibit 25-16. Major Diverge Area with Equal Number of Lanes Entering and
Leaving Influence Area 25-16

Exhibit 25-17. Major Diverge Area with More Lanes Leaving Than Entering
Influence Area 25-16

Exhibit 25-18. Flow in Lane 5 of Freeway Approaching Single-Lane, Right-Hand
Off-Ramp 25-17

Exhibit 25-19. Average Speeds in Vicinity of Freeway-Ramp Terminals 25-18

Exhibit 25-20. Ramps and Ramp Junctions Worksheet 25-21

I. INTRODUCTION

A ramp is a length of roadway providing an exclusive connection between two highway facilities. The facilities connected by a ramp may consist of freeways, multilane highways, two-lane highways, suburban streets, and urban streets.

A ramp may consist of up to three geometric elements of interest:

- Ramp-freeway junction,
- Ramp roadway, and
- Ramp-street junction.

SCOPE OF THE METHODOLOGY

This chapter focuses on the operation of ramp-freeway junctions and on the characteristics of ramp roadways themselves. These procedures may be applied, in an approximate manner, to completely uncontrolled ramp terminals on other types of facilities such as multilane and two-lane highways.

Procedures in this chapter allow for the identification of likely congestion at ramp-freeway terminals [level of service (LOS) F] and for the analysis of operations at ramp-freeway junctions and on ramp roadways at LOS A through E. Chapter 22, "Freeway Facilities," provides procedures for the analysis of oversaturated flow as well as special applications, including ramps on five-lane (one-direction) freeway segments, two-lane ramps, major merge areas, and major diverge areas.

For additional discussion of the general concepts and principles affecting ramp junction operation, consult Chapter 13, "Freeway Concepts."

This edition of ramp-freeway terminal analysis procedures results primarily from studies conducted under National Cooperative Highway Research Program Project 3-37 (1). Some special applications resulted from adaptations of procedures developed in the 1970s (2). AASHTO policies (3) contain additional material on the geometric design and geometric design criteria for ramps.

LIMITATIONS OF THE METHODOLOGY

The methodology in this chapter does not take into account nor is it applicable (without modifications by the analyst) to

- Special lanes, such as high-occupancy vehicle (HOV) lanes, as ramp entrance lanes;
- Ramp metering;
- Oversaturated conditions;
- Posted speed limit, and extent of police enforcement; and
- Presence of intelligent transportation system (ITS) features.

II. METHODOLOGY

Exhibit 25-1 illustrates input to and the basic computation order for the method for ramps and ramp junctions. The primary outputs of the method are LOS and capacity.

As shown in Exhibit 25-2, the basic approach to modeling merge and diverge areas focuses on an influence area of 450 m including the acceleration or deceleration lane and Lanes 1 and 2 of the freeway. Although other freeway lanes may be affected by merging or diverging operations and the impact of congestion in the vicinity of a ramp can extend beyond the 450-m influence area, this defined area experiences most of the operational impacts across all levels of service. Thus, the operation of vehicles within the ramp influence area, as defined in Exhibit 25-2, is the focus of the computational procedures.

Background and concepts for this chapter are in Chapter 13, "Freeway Concepts"

EXHIBIT 25-1. RAMPS AND RAMP JUNCTION METHODOLOGY

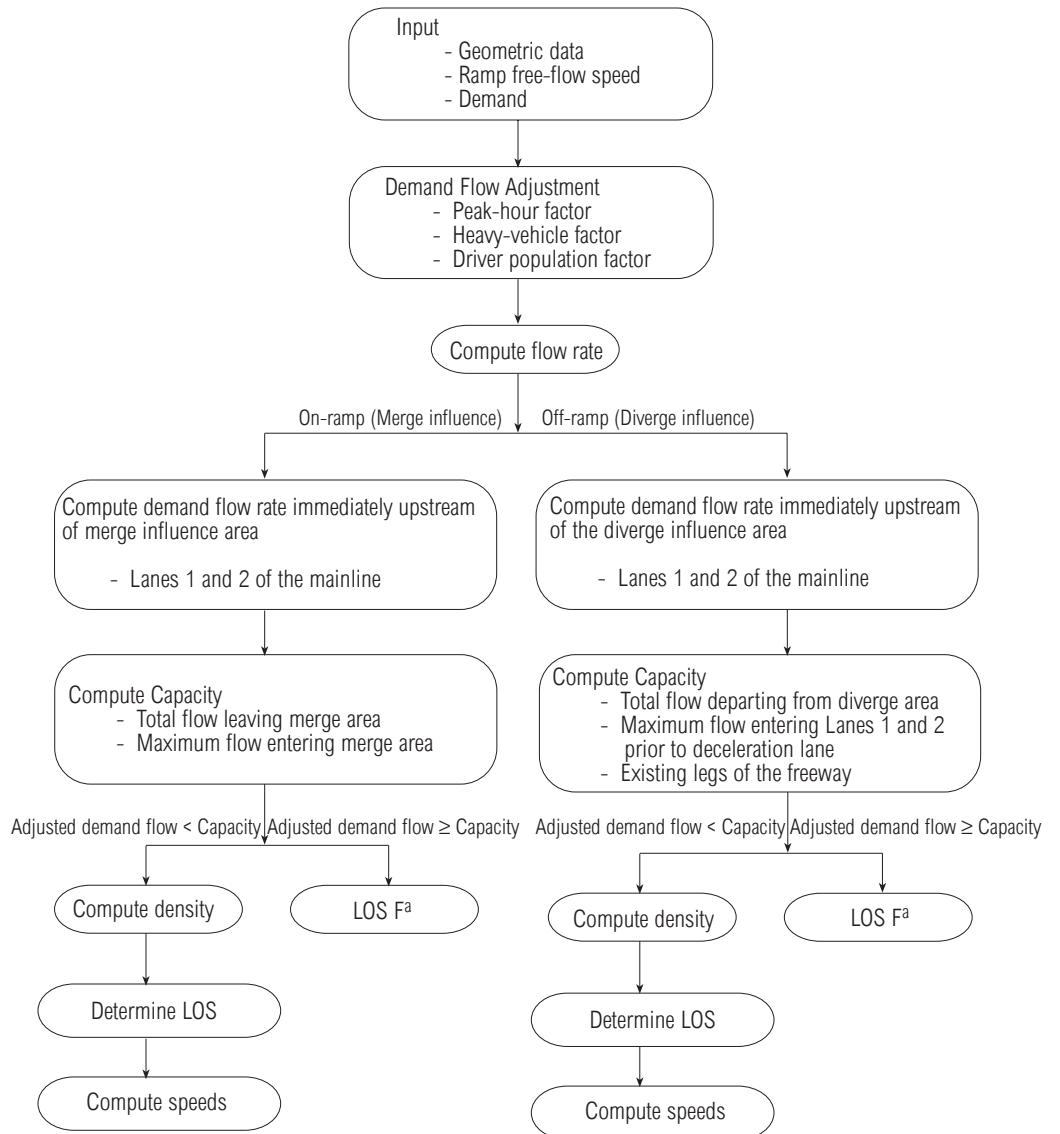

Note:
a. Refer to Chapter 22.

EXHIBIT 25-2. CRITICAL RAMP JUNCTION VARIABLES

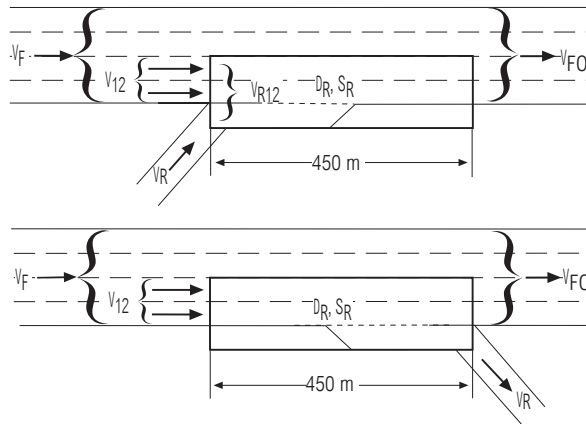

The methodology has three major steps. First, flow entering Lanes 1 and 2 immediately upstream of the merge influence area (v_{12}) or at the beginning of the deceleration lane at diverge is determined.

Second, capacity values are determined and compared with existing or forecast demand flows to determine the likelihood of congestion. Several capacity values are evaluated:

- Maximum total flow approaching a major diverge area on the freeway (v_F),
- Maximum total flow departing from a merge or diverge area on the freeway (v_{FO}),
- Maximum total flow entering the ramp influence area (v_{R12} for merge areas and v_{12} for diverge areas), and
- Maximum flow on a ramp (v_R).

The capacity of a merge or diverge area is always controlled by the capacity of its entering and exiting roadways, that is, the freeway segments upstream and downstream of the ramps, or by the capacity of the ramp itself. For diverge areas, failure most often occurs because of insufficient capacity on the off-ramp. Research has shown that the turbulence due to merging and diverging maneuvers does not affect the capacity of the roadways involved, although there may be local changes in lane distribution and use.

Finally, the density of flow within the ramp influence area (D_R) and the level of service based on this variable are determined. For some situations, the average speed of vehicles within the influence area (S_R) may also be estimated.

Exhibit 25-2 shows the ramp influence areas and key variables and their relationship to each other. A critical geometric parameter influencing operations at merge or diverge areas is the length of the acceleration lane (L_A) or deceleration lane (L_D). This length is measured from the point at which the left edge of the ramp lane or lanes and the right edge of the freeway lanes converge to the end of the taper segment connecting the ramp to the freeway. The point of convergence can be defined by painted markings or physical barriers or by some combination of the two. Note that both taper area and parallel ramps are measured in the same way.

All aspects of the model and LOS criteria are expressed in terms of equivalent maximum flow rates in passenger cars per hour (pc/h) under base conditions during the peak 15 min of the hour of interest. Therefore, before any of these procedures are applied, all relevant freeway and ramp flows must be converted to equivalent pc/h under base conditions during the peak 15 min of the hour, using Equation 25-1.

$$v_i = \frac{V_i}{PHF * f_{HV} * f_p} \quad (25-1)$$

where

- v_i = flow rate for movement i under base conditions during peak 15 min of hour (pc/h),
- V_i = hourly volume for movement i (veh/h),
- PHF = peak-hour factor,
- f_{HV} = adjustment factor for heavy vehicles, and
- f_p = adjustment factor for driver population.

Adjustment factors are the same as those used for analysis of basic freeway segments and can be found in Chapter 23.

RAMP ROADWAYS

Because most operational problems occur at ramp terminals (either the ramp-freeway terminal or the ramp-street terminal), little information exists regarding the operational characteristics of ramp roadways themselves. Some basic design standards exist in AASHTO policies (3), but these are not related to specific operational characteristics. In the 1970s, this material was adapted (2) to provide a broader set of

criteria, which were, again, unrelated to specific operational characteristics. Thus, information presented in this section is for general guidance only.

Ramp roadways differ from the freeway mainline in that

- They are roadways of limited length and width (often just one lane);
- Free-flow speed is frequently lower than that of the roadways connected, particularly the freeway;

particular;

- On single-lane ramps, where passing is not possible, the adverse impact of trucks and other slow-moving vehicles is more pronounced than on multilane roadways; and
- At ramp-street junctions, queuing may develop on the ramp, particularly if the ramp-street junction is signalized.

Exhibit 25-3 lists approximate criteria for the capacity of ramp roadways. These capacities are based on research studies (1) and previously noted work conducted in the 1970s (2).

EXHIBIT 25-3. APPROXIMATE CAPACITY OF RAMP ROADWAYS

Free-Flow Speed of Ramp, S_{FR} (km/h)	Capacity (pc/h)	
	Single-Lane Ramps	Two-Lane Ramps
> 80	2200	4400
> 65–80	2100	4100
> 50–65	2000	3800
≥ 30–50	1900	3500
< 30	1800	3200

The values in the exhibit are not capacities of freeway terminals, but rather of ramps themselves

Note that Exhibit 25-3 gives the capacity of the ramp roadway itself, not that of the ramp-freeway terminal. There is no evidence, for example, that a two-lane on-ramp freeway terminal can accommodate more vehicles than a one-lane ramp terminal.

It is unlikely that two-lane on-ramps can accommodate more than 2,250 to 2,400 pc/h through the merge area itself. The two-lane configuration will achieve a merge with less turbulence and a higher LOS but will not increase the capacity of the merge, which is controlled by the capacity of the downstream freeway segment. For higher on-ramp flows, a two-lane on-ramp must be used in conjunction with a lane addition and a major merge configuration.

Two-lane off-ramps can accommodate higher ramp flows through the diverge area than can single-lane off-ramps. A major diverge configuration can also be considered, which may more effectively balance the per-lane flows on each departing leg.

Where an off-ramp terminates at a signalized or unsignalized intersection, the capacity of the ramp system may be controlled by the capacity of the ramp approach to the intersection. Signalized intersections are analyzed using the techniques of Chapter 16, and procedures to analyze unsignalized intersections are provided in Chapter 17.

LOS

LOS in merge (and diverge) influence areas is determined by density for all cases of stable operation, represented by LOS A through E. LOS F exists when the total flow departing from the merge area (v) exceeds the capacity of the downstream freeway segment. No density will be predicted for such cases. Refer to Chapter 22 for procedures to analyze LOS F conditions.

LOS criteria for merge and diverge areas are listed in Exhibit 25-4. The density values shown for LOS A through E assume stable operation, with no breakdowns within the merge influence area.

EXHIBIT 25-4. LOS CRITERIA FOR MERGE AND DIVERGE AREAS

LOS	Density (pc/km/ln)
A	≤ 6
B	$> 6-12$
C	$> 12-17$
D	$> 17-22$
E	> 22
F	Demand exceeds capacity

MERGE INFLUENCE AREAS

The subsections below describe the three primary steps in the model for analysis of merge areas. The model applies to single-lane, right-hand on-ramp merge areas. Additional sections discuss the application of procedures to other geometric configurations.

Predicting Flow Entering Lanes 1 and 2 (v_{12})

The principal influences on flow remaining in Lanes 1 and 2 immediately upstream of the merge influence area are

- Total freeway flow approaching merge area (v_F) (pc/h),
- Total ramp flow (v_R) (pc/h),
- Total length of acceleration lane (L_A) (m), and
- Free-flow speed of ramp at point of merge area (S_{FR}) (km/h).

Ramps on four-lane, eight-lane, and ten-lane freeways are always analyzed as isolated merge or diverge areas. The nature of the procedure for predicting v_{12} makes the four-lane case trivial, and data are insufficient to determine the effects of adjacent ramps on eight-lane and ten-lane freeways.

For six-lane freeways, however, sufficient data are available to take into account the effect of adjacent ramps on lane distribution at a subject ramp. When nearby ramps inject vehicles into or remove them from Lane 1, the lane distribution may be seriously altered. Important variables determining this impact include the total flow on the upstream (v_U) or downstream (v_D) ramp (or both), in pc/h and the distance from the subject ramp to the adjacent upstream (L_{up}) or downstream (L_{down}) ramp (or both), in meters. For ramps on six-lane freeways, therefore, an additional analysis step is necessary to determine whether adjacent ramps are close enough to affect lane distribution at the subject ramp.

With all of these variables, the total approaching freeway flow has the most dominant influence on flow in Lanes 1 and 2. Models are structured to account for this phenomenon without distorting other relationships. Longer acceleration lanes encourage less turbulence as ramp vehicles enter the freeway traffic stream and therefore lead to lower densities in the influence area and higher flows in Lanes 1 and 2. When the ramp has a higher free-flow speed, vehicles tend to enter the freeway at higher speeds, and approaching freeway vehicles tend to move further left to avoid the possibility of high-speed turbulence.

Exhibit 25-5 lists equations used for predicting v_{12} immediately upstream of the ramp influence area. These equations apply to six- and eight-lane freeways (with three and four lanes in each direction, respectively). For four-lane freeways (two lanes in each direction), only Lanes 1 and 2 exist, and $v_{12} = v_F$ by definition.

v_F, v_R, v_{12} , and v_D are in pc/h; L_A, L_{up} , and L_{down} are in meters; S_{FR} is in km/h

EXHIBIT 25-5. MODELS FOR PREDICTING v_{12} AT ON-RAMPS

$v_{12} = v_F * P_{FM}$	
For 4-lane freeways (2 lanes each direction)	$P_{FM} = 1.000$
For 6-lane freeways (3 lanes each direction)	$P_{FM} = 0.5775 + 0.000092L_A$ (Equation 1)
	$P_{FM} = 0.7289 - 0.0000135 (v_F + v_R) - 0.002048S_{FR} + 0.0002L_{up}$ (Equation 2)
	$P_{FM} = 0.5487 + 0.0801 v_D/L_{down}$ (Equation 3)
For 8-lane freeways (4 lanes each direction)	$P_{FM} = 0.2178 - 0.000125v_R + 0.05887L_A/S_{FR}$ (Equation 4)

The variables used in Exhibit 25-5 are defined as follows:

- v_{12} = flow rate in Lanes 1 and 2 of freeway immediately upstream of merge (pc/h),
- v_F = freeway demand flow rate immediately upstream of merge (pc/h),
- v_R = on-ramp demand flow rate (pc/h),
- v_D = demand flow rate on adjacent downstream ramp (pc/h),
- P_{FM} = proportion of approaching freeway flow remaining in Lanes 1 and 2 immediately upstream of merge,
- L_A = length of acceleration lane (m),
- S_{FR} = free-flow speed of ramp (km/h),
- L_{up} = distance to adjacent upstream ramp (m), and
- L_{down} = distance to adjacent downstream ramp (m).

The general model specifies that v_{12} is a proportion of the approaching freeway flow, v_F . For four-lane freeways, this is a trivial relationship since all approaching flow is in Lanes 1 and 2. For eight-lane freeways, a single equation is used to determine this proportion without regard to conditions on adjacent upstream or downstream ramps, or both.

For six-lane freeways, the analysis is complicated by the fact that the effect of some types of adjacent ramps can be predicted. Exhibit 25-6 lists the various sequences of ramps that may occur on six-lane freeways and the appropriate equation from Exhibit 25-5 that should be applied in each case.

EXHIBIT 25-6. SELECTING EQUATIONS FOR P_{FM} FOR SIX-LANE FREEWAYS

Adjacent Upstream Ramp	Subject Ramp	Adjacent Downstream Ramp	Equation(s) Used
None	On	None	Equation 1
None	On	On	Equation 1
None	On	Off	Equation 3 or 1
On	On	None	Equation 1
Off	On	None	Equation 2 or 1
On	On	On	Equation 1
On	On	Off	Equation 3 or 1
Off	On	On	Equation 2 or 1
Off	On	Off	Equation 3, 2, or 1

Equation 2 from Exhibit 25-5 addresses cases with an adjacent upstream off-ramp, whereas Equation 3 addresses cases with an adjacent downstream off-ramp. Adjacent on-ramps do not affect subject ramp behavior, and the analysis proceeds using Equation 1.

Where an adjacent upstream or downstream off-ramp (or both) exists, the decision to use Equation 2 or 3 versus 1 is made by determining the equilibrium separation distance

(L_{EQ}) between ramps. If the distance between ramps is greater than or equal to L_{EQ} , Equation 1 is always used. If the distance between ramps is less than L_{EQ} , Equation 2 or 3 is used as appropriate.

L_{EQ} is that distance for which Equation 1 and Equation 2 or 3, as appropriate, yield the same value of P_{FM} . Thus, where an adjacent upstream off-ramp exists, Equation 2 must be considered. If Equation 2 is set equal to Equation 1, L_{EQ} is shown in Equation 25-2.

$$L_{EQ} = 0.0675 (v_F + v_R) + 0.46L_A + 10.24S_{FR} - 757 \quad (25-2)$$

where

L_{EQ} = equilibrium distance when Equation 1 is set equal to Equation 2 from Exhibit 25-5 (m).

If $L_{up} \geq L_{EQ}$, Equation 1 is used. If $L_{up} < L_{EQ}$, Equation 2 is used. Similarly, when a choice between Equation 3 and Equation 1 must be made, Equation 25-3 is used to compute L_{EQ} :

$$L_{EQ} = \frac{v_D}{0.3596 + 0.001149 L_A} \quad (25-3)$$

where

L_{EQ} = equilibrium distance when Equation 1 is set equal to Equation 3 from Exhibit 25-5 (m).

In this case, if the distance to the downstream off-ramp is greater than or equal to L_{EQ} ($L_{down} \geq L_{EQ}$), Equation 1 is used. If $L_{down} < L_{EQ}$, Equation 3 is used.

A special case exists when both a downstream and an upstream adjacent off-ramp exist. In such cases, two solutions for P_{FM} may arise, depending on whether the analysis considers the upstream or the downstream adjacent ramp, because they cannot be considered simultaneously. In such cases, the analysis resulting in the largest value of P_{FM} is used.

Determining Capacity

The capacity of a merge area is determined primarily by the capacity of the downstream freeway segment. Thus, the total flow arriving on the upstream freeway and the on-ramp cannot exceed the basic freeway capacity of the departing downstream freeway segment. There is no evidence that the turbulence of the merge area causes the downstream freeway capacity to be less than that of a basic freeway segment.

Studies have also shown that there is a practical limit to the total flow rate that can enter the ramp influence area. For an on-ramp, the flow entering the ramp influence area includes v_{12} and v_R . Thus, the total flow entering the ramp influence area is given according to Equation 25-4.

$$v_{R12} = v_{12} + v_R \quad (25-4)$$

Exhibit 25-7 lists capacity flow rates for the total downstream freeway flow ($v = v_F + v_R$) and maximum desirable values for the total flow entering the ramp influence area (v_{R12}). Two conditions may occur for a given analysis. First, the total departing freeway flow (v) may exceed the capacity of the downstream freeway segment. Failure (LOS F) is expected, and queues will form upstream from the merge segment. When the downstream freeway capacity is exceeded, LOS F exists regardless of whether the flow rate entering the ramp influence area exceeds its capacity.

Two capacities are to be checked:

- Total flow from merge, and
- Total flow into merge influence area

EXHIBIT 25-7. CAPACITY VALUES FOR MERGE AREAS

Freeway Free-Flow Speed (km/h)	Maximum Downstream Freeway Flow, v (pc/h)				Max Desirable Flow Entering Influence Area, v_{R12} (pc/h)
	Number of Lanes in One Direction				
	2	3	4	> 4	
120	4800	7200	9600	2400/ln	4600
110	4700	7050	9400	2350/ln	4600
100	4600	6900	9200	2300/ln	4600
90	4500	6750	9000	2250/ln	4600

The second condition occurs when the total flow entering the ramp influence area (v_{R12}) exceeds its maximum desirable level but the total freeway flow (v) does not exceed the capacity of the downstream freeway segment. In this case, locally high densities are expected, but no queuing is expected on the freeway. The actual lane distribution of entering vehicles is likely to consist of more vehicles in the outer lanes than is indicated by the models herein. Overall, operation will remain stable, and LOS F is not expected to occur.

When the total downstream flow exceeds the basic freeway capacity of the downstream segment, LOS F exists. In such cases, no further computations are needed, and LOS F is assigned. For all other cases, including cases in which v_{R12} exceeds its stated limit, LOS is determined by estimating the density in the ramp influence area.

Determining LOS

LOS criteria for merge areas are based on density in the merge influence area as shown in Exhibit 25-4. Studies (2,4) have shown that there is an overlap in density ranges in the area of capacity such that some breakdown operations may have lower densities than those achieved under stable operation. This situation is due to the wavelike motion of vehicles in a queue and the rather short length of the defined influence area, the result being that the determination of LOS F is based solely on the comparison of demand flows with capacity.

Equation 25-5 is used to estimate the density in the merge influence area. Note that the equation for density applies only to undersaturated flow conditions.

$$D_R = 3.402 + 0.00456v_R + 0.0048v_{12} - 0.01278L_A \tag{25-5}$$

where

- D_R = density of merge influence area (pc/km/ln),
- v_R = on-ramp peak 15-min flow rate (pc/h),
- v_{12} = flow rate entering ramp influence area (pc/h), and
- L_A = length of acceleration lane (m).

Special Cases

A number of merge configurations do not involve single-lane, right-side on-ramps. These are dealt with using modifications to the basic merge analysis procedure and adapting the results to the specific geometry being analyzed.

Two-Lane On-Ramps

Exhibit 25-8 illustrates a typical two-lane freeway on-ramp. It is characterized by two separate acceleration lanes, each successively forcing merging maneuvers to the left.

Two-lane on-ramps entail two modifications to the basic methodology: the flow remaining in Lanes 1 and 2 immediately upstream of the on-ramp is generally somewhat higher than that for one-lane on-ramps in similar situations, and densities in the merge area are lower than those for similar one-lane on-ramp situations. The lower density is primarily due to the existence of two acceleration lanes and the generally longer distance

Equation applicable only to undersaturated flow conditions

over which the two acceleration lanes extend. Thus, the effectiveness of two-lane on-ramps is that higher ramp flows are handled more smoothly and at better levels of service than if the same flows were carried on a one-lane ramp with conventional merge design.

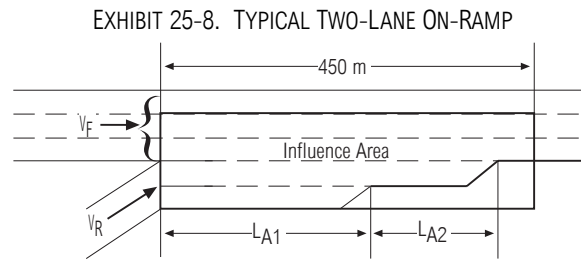

In computation of v_{12} for two-lane on-ramps, the standard expression in Exhibit 25-5 is used:

$$v_{12} = v_F * P_{FM}$$

For two-lane on-ramps, however, the following values of P_{FM} are used instead of the equations shown in Exhibit 25-5:

- Four-lane freeways, $P_{FM} = 1.000$;
- Six-lane freeways, $P_{FM} = 0.555$;
- Eight-lane freeways, $P_{FM} = 0.209$.

In computation of the expected density in the ramp influence area, Equation 25-5 is applied except that the length of the acceleration lane, L_A , is replaced by the effective length of the acceleration lane, L_{Aeff} , as computed by Equation 25-6.

$$L_{Aeff} = 2L_{A1} + L_{A2} \quad (25-6)$$

where L_{A1} and L_{A2} are as defined in Exhibit 25-8.

The values governing maximum flow rates for v and v_{R12} are not affected by the use of a two-lane on-ramp. The capacity of the downstream freeway segment continues to control the total output capacity of the merge, and the maximum desirable number of vehicles that may enter the influence area on Lanes 1 and 2 of the freeway is not enhanced by the existence of a two-lane on-ramp. The values of Exhibit 25-7 are applied without change.

Lane Additions

On-ramps are sometimes associated with the addition of a lane at the merge point. Where a single-lane on-ramp results in a lane addition, the capacity of the ramp is governed by the ramp geometry itself and not by the ramp-freeway junction. Where a two-lane on-ramp results in a lane addition, the junction should be classified as a major merge area.

Analysis of single-lane additions (and lane drops) is relatively straightforward. The downstream segment is simply considered to be a basic freeway segment with an additional lane. If, however, an added lane is dropped at a diverge point within 750 m of the point of addition, a weaving configuration will be formed, and the segment should be analyzed using the methodology of Chapter 24, "Freeway Weaving."

Major Merge Areas

A major merge area is one in which two primary roadways, each having multiple lanes, merge to form a single freeway segment. The merging roadways may originate in a freeway interchange or from an urban street or rural highway. Major merges are different from one- and two-lane on-ramps in that each of the merging roadways is

Capacities of two-lane ramps are the same as those for one-lane ramps

Major merge defined

generally at or near freeway design standards and no clear ramp or acceleration lane is involved in the merge.

Such major merge areas come in a variety of geometries, all of which fall into two general categories, as illustrated in Exhibits 25-9 and 25-10. In Exhibit 25-9, the number of lanes departing from the merge area is one fewer than the total number of approaching lanes. This geometry is accomplished by having the right lane of the left merging leg and the left lane of the right merging leg combine to form a single lane. In geometries of the type illustrated in Exhibit 25-10, the number of lanes departing from the merge is the same as the total number of lanes approaching it.

EXHIBIT 25-9. MAJOR MERGE AREA WITH ONE FEWER LANE LEAVING INFLUENCE AREA

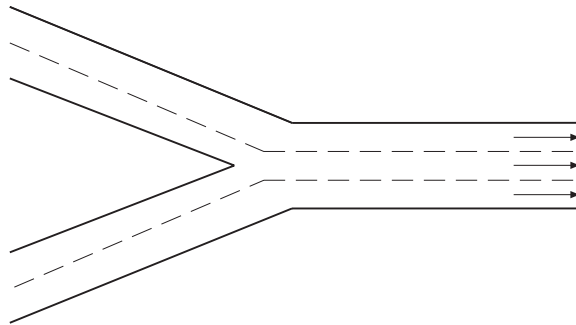
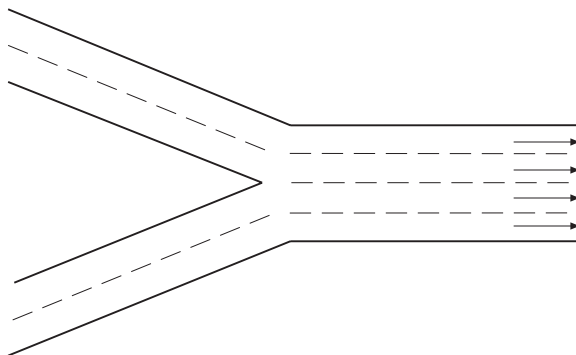

EXHIBIT 25-10. MAJOR MERGE AREA WITH EQUAL NUMBER OF LANES LEAVING INFLUENCE AREA



There are no effective models of performance for a major merge area. Therefore, the analysis is limited to checking capacities on approaching legs and the departing freeway. The capacity of each entering leg and the departing freeway is computed using the general values of Exhibit 25-7. The capacity of each entering leg is compared with the peak demand flow on each (converted to pc/h), whereas the capacity of the departing freeway is compared with the sum of the two peak entering demands (also converted to pc/h). Problems in major merge areas generally result from insufficient capacity of the downstream freeway segment.

On-Ramps on Ten-Lane Freeway (Five Lanes in Each Direction)

Although it is not common, there are freeway segments in North America where five lanes of traffic exist in each direction. A procedure is therefore needed to analyze a single-lane, right-hand on-ramp on such freeway segments. The flow rate in Lane 5 of the freeway is estimated and deducted from the approaching freeway flow. The remaining approaching freeway flow consists of flow that would be expected on a similar freeway of four lanes; thus standard procedures for analysis are used. The flow in Lane 5 of the freeway for on-ramps is estimated as shown in Exhibit 25-11.

EXHIBIT 25-11. FLOW IN LANE 5 OF FREEWAY APPROACHING SINGLE-LANE, RIGHT-SIDE ON-RAMP

Total Approaching Freeway Flow, v_F (pc/h)	Approaching Freeway Flow In Lane 5, v_5 (pc/h)
≥ 8500	2500
7500-8499	$0.285v_F$
6500-7499	$0.270v_F$
5500-6499	$0.240v_F$
< 5500	$0.220v_F$

Source: AASHTO (3).

Once the anticipated approaching flow in Lane 5 is determined, normal procedures are applied, assuming an eight-lane freeway (four lanes in one direction), with an effective approaching flow computed using Equation 25-7.

$$v_{F4eff} = v_F - v_5 \quad (25-7)$$

where

- v_{F4eff} = effective approaching freeway flow four-lane (one-direction) freeway segment (pc/h),
- v_F = total approaching freeway flow in five-lane (one-direction) freeway segment (pc/h), and
- v_5 = anticipated approach flow in Lane 5 of freeway, computed as in Exhibit 25-11 (pc/h).

Left-Hand On-Ramps

Although not normally recommended, left-hand ramps do exist on some freeways and occur quite frequently on collector-distributor roadways. The left-hand ramp influence area covers the same length as that for right-hand ramps but now encompasses the two left lanes plus an acceleration lane. For right-hand on-ramps, a critical computation is the estimation of v_{12} . For left-hand ramps, the two left lanes are of interest. For a four-lane freeway, this flow rate remains v_{12} and there is no difficulty. For a six-lane freeway, the entering flow of interest is v_{23} , and for eight-lane freeways, it is v_{34} . Although there is no direct method for the analysis of left-hand on-ramps, some rational modifications can be applied to right-hand on-ramp methodologies to produce reasonable results (2).

It is suggested that the analyst first compute v_{12} using procedures for a right-hand on-ramp and then multiply the v_{12} value by 1.00, 1.12, or 1.20 to obtain v_{12} , v_{23} , or v_{34} for a left-hand on-ramp on four-, six-, or eight-lane freeways, respectively.

Remaining computations for density, speed, or both may continue, replacing v_{12} with v_{23} or v_{34} as appropriate. All capacity values remain unchanged.

Effects of Ramp Control at On-Ramps

For the purposes of this chapter, procedures are not modified in any way to account for the local effect of ramp control, except for the limitation the ramp meter may have on v_R . Research (4) has found that breakdown of a merge area may be a probabilistic event based on the platoon characteristics of the arriving ramp vehicles. Ramp meters provide for uniform gaps between entering ramp vehicles and may therefore reduce the probability of a breakdown on the freeway mainline.

DIVERGE INFLUENCE AREAS

Analysis procedures for diverge areas follow the same general approach as that for merge areas. Standard procedures have been calibrated from a research study (2) that apply to single-lane, right-hand off-ramps. The same three fundamental steps are followed: determine the approaching freeway flow in Lanes 1 and 2 of the freeway (v_{12}),

determine the capacity for the segment (v_F and v_{12}), and determine the density of flow within the ramp influence area (D_R). These procedures are then modified and applied to other diverge configurations and geometries.

Predicting Flow Entering Lanes 1 and 2 (v_{12})

Models for predicting freeway flow entering the diverge area in Lanes 1 and 2 of the freeway are shown in Exhibit 25-12. The approach is similar to that for merge areas and is affected by the same variables.

There are two major differences between merge-area analysis and diverge-area analysis. First, approaching flow in Lanes 1 and 2 (v_{12}) is predicted for a point immediately upstream of the deceleration lane even if this point is upstream or downstream of the beginning of the ramp influence area. Second, at a diverge area, v_{12} includes v_R . Thus, the general model treats v_{12} as the sum of the off-ramp flow plus a proportion of the through freeway flow.

EXHIBIT 25-12. MODELS FOR PREDICTING v_{12} AT OFF-RAMPS

	$v_{12} = v_R + (v_F - v_R)P_{FD}$	
For 4-lane freeways (2 lanes each direction)	$P_{FD} = 1.00$	
For 6-lane freeways (3 lanes each direction)	$P_{FD} = 0.760 - 0.000025v_F - 0.000046v_R$	(Equation 5)
	$P_{FD} = 0.717 - 0.000039v_F + 0.184v_U/L_{up}$	(Equation 6)
	$P_{FD} = 0.616 - 0.000021v_F + 0.038v_D/L_{down}$	(Equation 7)
For 8-lane freeways (4 lanes each direction)	$P_{FD} = 0.436$	(Equation 8)

v_F, v_R, v_{12} , and v_D are in pc/h; L_D, L_{up} , and L_{down} are in meters
See Exhibit 25-2 for definition of terms

The variables used in Exhibit 25-12 are defined as follows:

- v_{12} = flow rate in lanes 1 and 2 of freeway immediately upstream of diverge (pc/h),
- v_F = freeway demand flow rate immediately upstream of diverge (pc/h),
- v_R = off-ramp demand flow rate (pc/h),
- v_U = demand flow rate on adjacent upstream ramp (pc/h),
- v_D = demand flow rate on adjacent downstream ramp (pc/h),
- P_{FD} = proportion of through freeway flow remaining in Lanes 1 and 2 immediately upstream of diverge,
- L_{up} = distance to adjacent upstream ramp (m), and
- L_{down} = distance to adjacent downstream ramp (m).

The general model specifies that v_{12} consists of the off-ramp flow (v_R) plus a proportion of the approaching freeway flow (v_F). For four-lane freeways, this is a trivial relationship since all approaching flow is in Lanes 1 and 2. For eight-lane freeways, a single value is used without regard to conditions on adjacent upstream or downstream ramps, or both.

For six-lane freeways, the analysis is complicated by the fact that the effect of some types of adjacent ramps can be accommodated. Exhibit 25-13 shows the various sequences of ramps that may occur on six-lane freeways and the appropriate equations from Exhibit 25-12 that should be applied in each case.

Equation 6 from Exhibit 25-13 addresses cases with an adjacent upstream on-ramp, and Equation 7 addresses cases with an adjacent downstream off-ramp. Adjacent upstream off-ramps and adjacent downstream on-ramps do not affect subject ramp behavior, and analysis proceeds using Equation 5.

EXHIBIT 25-13. SELECTING EQUATIONS FOR P_{FD} FOR SIX-LANE FREEWAYS

Adjacent Upstream Ramp	Subject Ramp	Adjacent Downstream Ramp	Equation(s) Used
None	Off	None	Equation 5
None	Off	On	Equation 5
None	Off	Off	Equation 7 or 5
On	Off	None	Equation 6 or 5
Off	Off	None	Equation 5
On	Off	On	Equation 6 or 5
On	Off	Off	Equation 7, 6, or 5
Off	Off	On	Equation 5
Off	Off	Off	Equation 7 or 5

Where an adjacent upstream on-ramp or downstream off-ramp exists, or where both exist, the decision to use Equation 6 or 7 versus 5 is made by determining the equilibrium separation distance (L_{EQ}) between ramps. If the distance between ramps is greater than or equal to L_{EQ} , Equation 5 is always used. If the distance between ramps is less than L_{EQ} , Equation 6 or 7 is used as appropriate.

L_{EQ} is that distance for which Equation 5 and Equation 6 or 7, as appropriate, yields the same value for P_{FD} . Thus, where an adjacent upstream on-ramp exists, Equation 6 must be considered. If Equation 6 is set equal to Equation 5, the following relationship is derived as Equation 25-8.

$$L_{EQ} = \frac{v_U}{0.2337 + 0.000076v_F - 0.00025v_R} \quad (25-8)$$

where

L_{EQ} = equilibrium distance when Equation 5 is set equal to Equation 6, from Exhibit 25-12 (m)

and where all variables are as previously defined. If $L_{up} \geq L_{EQ}$, Equation 5 is used. If $L_{up} < L_{EQ}$, Equation 6 is employed.

A similar analysis is conducted where an adjacent downstream off-ramp exists. Equation 25-9 is used for the analysis.

$$L_{EQ} = \frac{v_D}{3.79 - 0.00011v_F - 0.00121v_R} \quad (25-9)$$

where

L_{EQ} = equilibrium distance when Equation 5 is set equal to Equation 7, from Exhibit 25-12 (m).

In this case, if the distance to the downstream off-ramp is greater than or equal to L_{EQ} ($L_{down} \geq L_{EQ}$), Equation 5 is used. If $L_{down} < L_{EQ}$, Equation 7 is used.

A special case exists when both a downstream adjacent off-ramp and an upstream adjacent on-ramp exist. In such cases, two solutions for P_{FD} may arise, depending on whether the analysis considers the upstream or the downstream adjacent ramp since both cannot be considered simultaneously. In such cases, the analysis resulting in the largest value of P_{FD} is applied.

Three capacities are to be checked:

- Total flow that can depart,
- Maximum flow in Lanes 1 and 2 just prior to the deceleration lane, and
- Maximum flow on both downstream legs

Determining Capacity

The three limiting values that should be checked in a diverge area are the total flow that can depart from the diverge, the capacities of the departing freeway leg or legs or ramp, or both, and the maximum flow that can enter on Lanes 1 and 2 just prior to the deceleration lane.

In a diverge area, the total flow that can depart is generally limited by the capacity of freeway lanes approaching the diverge. In all appropriate diverge designs, the number of lanes leaving the diverge area is either equal to or one greater than the number entering. This flow (v_F) is as previously defined. Exhibit 25-14 lists capacity values for this flow.

EXHIBIT 25-14. CAPACITY VALUES FOR DIVERGE AREAS

Freeway Free-Flow Speed (km/h)	Maximum Upstream, v_{F1} or Downstream Freeway Flow, v (pc/h)				Max Flow Entering Influence Area, v_{12} (pc/h)
	Number of Lanes in One Direction				
	2	3	4	> 4	
120	4800	7200	9600	2400/ln	4400
110	4700	7050	9400	2350/ln	4400
100	4600	6900	9200	2300/ln	4400
90	4500	6750	9000	2250/ln	4400

Note:
For capacity of off-ramp roadways, see Exhibit 25-3.

The second limit is most important, since it is the primary reason that diverge areas fail. Failure at a diverge is often related to the capacity of one of the exit legs, most often the ramp. The capacity of each exit leg must be checked against the expected flow. For a downstream freeway leg (at a major diverge area there may be two of these), capacity values may be drawn from Exhibit 25-14 for the appropriate number of freeway lanes. For off-ramp roadways, capacity values are provided in Exhibit 25-3.

The flow entering Lanes 1 and 2 just upstream of the deceleration lane is simply the flow in Lanes 1 and 2 (v_{12}), estimated as indicated in Exhibit 25-12. This flow includes the off-ramp flow. Exhibit 25-14 lists maximum desirable values for v_{12} .

Failure of the diverge segment (LOS F) is expected if any one of the following conditions is found:

- Capacity of the upstream freeway segment is exceeded by total arriving demand flow,
- Capacity of the downstream freeway segment is exceeded by the demand flow proceeding on the downstream freeway, or
- Capacity of the off-ramp is exceeded by the off-ramp demand flow.

When the total flow approaching the diverge influence area (v_{12}) exceeds its maximum desirable level but total demand flows are within all other capacity values, some locally high densities would be expected, but stable flow is still maintained. In such cases, it is likely that more vehicles will use outer lanes than is indicated by this methodology. LOS is determined by estimating the density in the ramp influence area, as indicated herein.

Determining LOS

LOS criteria for diverge areas are based on density in the diverge influence area. The numeric criteria are the same as those for merge areas, as shown previously in Exhibit 25-4.

Equation 25-10 is used to estimate density within the diverge influence area.

$$D_R = 2.642 + 0.0053v_{12} - 0.0183L_D \tag{25-10}$$

where

$$D_R = \text{density of diverge influence area (pc/km/ln),}$$

$$v_{12} = \text{flow rate entering ramp influence area (pc/h), and}$$

$$L_D = \text{length of deceleration lane (m).}$$

As was the case for merge areas, the equation predicting density in the segment (Equation 25-10) applies only to undersaturated flow conditions. Density is not computed when capacity is exceeded. Thus, when demand flows exceed the capacity of the approaching freeway segment or either the departing freeway segment or segments or the ramp, LOS F is automatically applied. For all other cases, including those in which the maximum flow is entering the ramp influence area (v_{12}), the density is computed using Equation 25-10, and LOS is determined using the criteria of Exhibit 25-4.

Special Cases

As was the case for merge areas, there are a number of other diverge configurations and geometries that do not conform to the single-lane, right-hand off-ramp case. These are handled as special cases, with modifications or additions to the basic analysis procedure to more accurately address these configurations.

Two-Lane Off-Ramps

Two common types of diverge designs are in use with two-lane, right-hand off-ramps. These are shown in Exhibit 25-15. In the first, two successive deceleration lanes are introduced. In the second, a single deceleration lane is used. The left-hand ramp lane splits from Lane 1 of the freeway at the gore area, without a deceleration lane. The existence of a two-lane off-ramp affects the lane distribution of approaching vehicles and thus the computation of v_{12} .

EXHIBIT 25-15. COMMON GEOMETRIES FOR TWO-LANE OFF-RAMPS

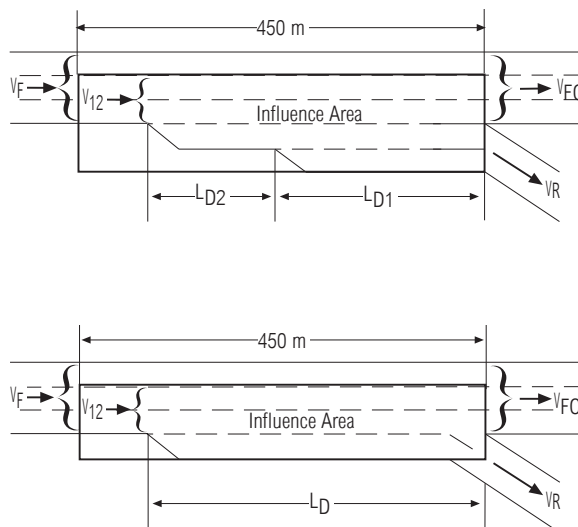

The general equation for computing v_{12} in a diverge area remains the same as that shown in Exhibit 25-12:

$$v_{12} = v_R + (v_F - v_R) P_{FD}$$

However, rather than using the standard equations of Exhibit 25-12, P_{FD} for two-lane off-ramps is found as follows:

- Four-lane freeways, $P_{FD} = 1.000$;
- Six-lane freeways, $P_{FD} = 0.450$; and
- Eight-lane freeways, $P_{FD} = 0.260$.

To estimate the density in the diverge influence area, Equation 25-10 is used. However, when the geometry of the two-lane off-ramp is similar to that shown in the top part of Exhibit 25-15, the length of the deceleration lane is replaced in the equation by the effective length, L_{Deff} (Equation 25-11).

$$L_{Deff} = 2L_{D1} + L_{D2} \tag{25-11}$$

When the geometry is similar to that shown in the bottom part of Exhibit 25-15, the length of the deceleration lane is used without modification.

The capacity values associated with a two-lane off-ramp are the same as those associated with a one-lane off-ramp. That is, the capacity for total flow through the diverge is unchanged. However, its distribution is more flexible, since the two-lane off-ramp can accommodate more ramp traffic than a single-lane off-ramp.

Lane Drops

When a single-lane off-ramp results in a lane drop, the capacity of the ramp is governed by its geometry, and it is analyzed as a ramp roadway. When a two-lane off-ramp results in a lane drop, it should be treated as a major diverge segment.

When a lane drop occurs 750 m or less from a merge point at which a lane was added, a weaving configuration is created and should be analyzed using the procedures of Chapter 24. In all other cases, the entering and departing freeway segments are analyzed as basic freeway segments having different numbers of lanes.

Major Diverge Areas

The two common geometries for major diverge areas are illustrated in Exhibits 25-16 and 25-17. In Exhibit 25-16, the number of lanes entering the diverge area is the same as the number of lanes leaving the diverge area. In Exhibit 25-17, the number of lanes leaving the diverge area is one more than the number entering the segment.

EXHIBIT 25-16. MAJOR DIVERGE AREA WITH EQUAL NUMBER OF LANES ENTERING AND LEAVING INFLUENCE AREA

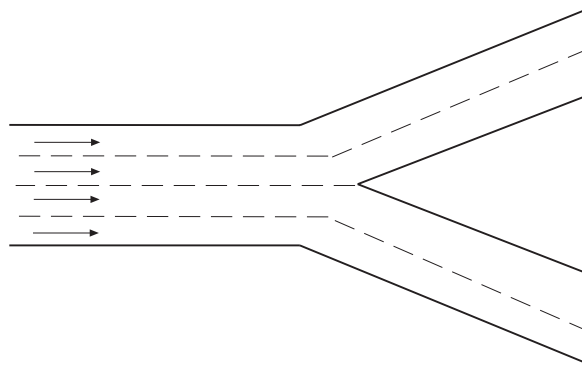
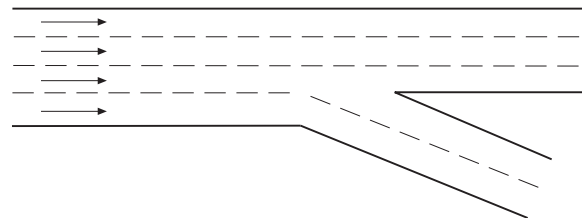

EXHIBIT 25-17. MAJOR DIVERGE AREA WITH MORE LANES LEAVING THAN ENTERING INFLUENCE AREA



The principal analysis of a major diverge area involves the capacity of entering and departing roadways, all of which are generally built to mainline standards. The entering demand and the departing demand on each exit leg must be checked against the capacity

of the appropriate entry or departure leg. Equation 25-12 allows the density across all freeway lanes to be estimated for a distance of 450 m upstream of the gore area.

$$D = 0.0109 \frac{V_F}{N} \tag{25-12}$$

where

- D = average density across all freeway lanes for a distance of 450 m upstream of diverge (pc/km/ln),
- V_F = freeway flow rate approaching diverge area (pc/h/ln), and
- N = number of lanes on freeway segment approaching diverge area.

This density can be compared with the LOS criteria in Exhibit 25-4 to determine the LOS in the diverge area.

Off-Ramps on Ten-Lane Freeways (Five Lanes in One Direction)

Segments of freeway exist in some urban areas in which there are five lanes in each direction. For off-ramps that must be analyzed on such sections, a special approach, similar to that for on-ramps, is employed. The flow in the fifth lane, v_5 , is estimated using the criteria of Exhibit 25-18. The remaining four lanes then have a flow equal to

$$V_{F4eff} = V_F - v_5$$

as was the case for on-ramps (see Equation 25-7) on five-lane segments. The ramp is then analyzed as if it were on an eight-lane freeway (four lanes in one direction), using standard procedures and v_{F4eff} as V_F .

This special procedure applies only to single-lane, right-hand off-ramps on five-lane segments.

EXHIBIT 25-18. FLOW IN LANE 5 OF FREEWAY APPROACHING SINGLE-LANE, RIGHT-HAND OFF-RAMP

Total Approaching Freeway Flow, v_F (pc/h)	Flow in Lane 5, v_5 (pc/h)
$\geq 7,000$	$0.200v_F$
5,500–6,999	$0.150v_F$
4,000–5,499	$0.100v_F$
$< 4,000$	0

Left-Hand Off-Ramps

Left-hand off-ramps do exist along some freeway segments. In this case, the ramp influence area involves the two leftmost lanes of the freeway, not Lanes 1 and 2, except in the case of a four-lane freeway, where Lanes 1 and 2 make up the rightmost and leftmost lanes of the freeway.

To analyze such situations, v_{12} is estimated using the standard procedures of Exhibit 25-12. The flow in the two leftmost lanes entering the diverge influence area is then estimated by multiplying the v_{12} value by 1.00, 1.05, or 1.10 for left-hand ramps on four-, six-, or eight-lane freeways, respectively.

Remaining computations for density, speed, or both may continue, replacing v_{12} with v_{23} or v_{34} as appropriate. All capacity values remain unchanged.

OVERLAPPING RAMP INFLUENCE AREAS

Whenever a series of ramps on a freeway is analyzed, it is possible that the 450-m ramp influence areas overlap. In such cases, the operation in the overlapping region is determined by the ramp having the highest density.

DETERMINING SPEED AT RAMP INFLUENCE AREAS

To address freeway and multifacility LOS, it is necessary to predict average speeds on long segments of a facility. Thus, it is useful to provide models for estimating average speeds within ramp influence areas and on lanes outside the influence area (Lanes 3 and 4, where they exist) within the length of the 450-m ramp influence area. From such estimates, a space mean speed can be estimated for all vehicles traveling within the 450-m length of the ramp influence area on all lanes of the freeway.

Note that this procedure reflects field observations that the average speeds of vehicles outside the ramp influence area are also affected by merge and diverge operations. Thus, it is not appropriate to assume that the speeds of vehicles in those outer lanes are the same as those on basic freeway segments for similar per-lane flow rates. In general, speeds in outer lanes in the vicinity of ramps will be somewhat reduced compared with speeds for similar flow levels on basic freeway segments, except when flow rates in those lanes are very low.

Exhibit 25-19 provides equations for estimating these speeds. Note that speeds can be estimated only for stable flow cases. Capacity analysis for freeway facilities operating with oversaturated flow conditions relies on deterministic queuing approaches, as presented in Chapter 22.

The equations for average speed in outer lanes reflect average per-lane flow rates of up to 2,988 veh/h/ln for merge areas and 2,350 veh/h/ln for diverge areas. In the case of merge lanes, this flow rate is well above the accepted average capacity of a freeway lane. Note, however, that freeway capacity per lane is always stated as an average across all lanes and that individual lanes will carry proportionally less or more flow. In merge and diverge areas, through vehicles tend to move left to avoid turbulence, resulting in cases where outer lanes are very heavily loaded compared with lanes within the ramp influence area (i.e., Lanes 1 and 2). Thus, even such high flow rates represent stable flow cases that have been observed in the field.

Speeds of vehicles outside the ramp influence area are affected by merge and diverge operations

EXHIBIT 25-19. AVERAGE SPEEDS IN VICINITY OF FREEWAY-RAMP TERMINALS

	Average Speed in Ramp Influence Area (km/h)	Average Speed in Outer Lanes of Ramp Influence Area (km/h)
Merge areas (on-ramps)	$S_R = S_{FF} - (S_{FF} - 67)M_s$ $M_s = 0.321 + 0.0039 e^{(v_{R12}/1000)} - 0.004(L_A S_{FR}/1000)$	$S_O = S_{FF}$ where $v_{OA} < 500$ pc/h $S_O = S_{FF} - 0.0058(v_{OA} - 500)$ where $v_{OA} = 500$ to 2300 pc/h $S_O = S_{FF} - 10.52 - 0.01(v_{OA} - 2300)$ where $v_{OA} > 2300$ pc/h
Diverge areas (off-ramps)	$S_R = S_{FF} - (S_{FF} - 67)D_s$ $D_s = 0.883 + 0.00009v_R - 0.008S_{FR}$	$S_O = 1.06S_{FF}$ where $v_{OA} < 1000$ pc/h $S_O = 1.06S_{FF} - 0.0062(v_{OA} - 1000)$ where $v_{OA} \geq 1000$ pc/h

The equations apply to undersaturated conditions but with per-lane flows well above accepted levels at merge

The variables used in Exhibit 25-19 are defined as follows:

- S_R = space mean speed of vehicles within ramp influence area (km/h); for merge areas, this includes all vehicles in v_{R12} ; for diverge areas, this includes all vehicles in v_{12} ;
- S_O = space mean speed of vehicles traveling in outer lanes (Lanes 3 and 4, where they exist) within 450-m length range of ramp influence area (km/h);
- S_{FF} = free-flow speed of freeway approaching merge or diverge area (km/h);
- S_{FR} = free-flow speed of ramp (km/h);
- L_A = length of acceleration lane (m);

- v_R = flow rate on ramp (pc/h);
 v_{R12} = sum of flow rates for ramp (v_R) and vehicles entering ramp influence area in Lanes 1 and 2 (v_{12}) at a merge area (pc/h);
 v_{OA} = average per-lane flow rate in outer lanes (Lanes 3 and 4, where they exist) at beginning of ramp influence area (pc/h/ln);
 M_s = intermediate speed determination variable for merge area; and
 D_s = intermediate speed determination variable for diverge area.

The average per-lane flow rate in outer lanes (v_{OA}) is found according to Equation 25-13.

$$v_{OA} = \frac{v_F - v_{12}}{N_O} \quad (25-13)$$

where

- v_{OA} = average per-lane demand flow in outer lanes (pc/h/ln),
 N_O = number of outside lanes in one direction (not including acceleration or deceleration lanes or Lanes 1 and 2),
 v_F = total approaching freeway flow rate (pc/h), and
 v_{12} = demand flow rate approaching ramp influence area (pc/h).

Once S_R and S_O are determined, the space mean speed for all vehicles within the 450-m length range of the ramp influence area may be computed as the harmonic mean of the two according to Equation 25-14 for merge areas or Equation 25-15 for diverge areas.

$$S = \frac{v_{R12} + v_{OA}N_O}{\left(\frac{v_{R12}}{S_R}\right) + \left(\frac{v_{OA}N_O}{S_O}\right)} \quad (25-14)$$

$$S = \frac{v_{12} + v_{OA}N_O}{\left(\frac{v_{12}}{S_R}\right) + \left(\frac{v_{OA}N_O}{S_O}\right)} \quad (25-15)$$

Note that for merge areas, the average speed in outer lanes never exceeds the free-flow speed of the freeway. For diverge areas, at low flow rates in the outer lanes, average speeds may marginally exceed free-flow speed. Again, free-flow speed reflects the average speed of freeway vehicles under conditions of low flow, and average speeds in individual lanes may exceed the average or be less than the average. However, in all cases, the maximum prediction of the average speed, S , should be limited to the free-flow speed of the freeway. Thus, the average speed on the freeway in the vicinity of a ramp will never be predicted to be higher than the free-flow speed of the facility.

III. APPLICATIONS

The methodology of this chapter can be used to analyze the capacity and LOS of ramps and ramp junctions. First, the analyst identifies primary output. Primary outputs typically solved for in a variety of applications include LOS, length of acceleration and deceleration lanes (L_A , L_D), and number of ramp lanes (N). Performance measures related to density (D) and speed (S) are also achievable but are considered secondary outputs.

Guidelines for required inputs and estimated values are in Chapter 13

Second, the analyst must identify the default values or estimated values for use in the analysis. The analyst has three basic sources of input data: (a) default values found in this manual, (b) estimates and locally derived default values developed by the analyst, and (c) values derived from field measurements and observation. For each of the input variables, a value must be supplied to calculate the outputs, both primary and secondary.

A common application of the method is to compute the LOS of an existing facility or of a changed facility in the near term or distant future. This type of application is termed operational, and its primary output is LOS, with secondary outputs for density and speed. Another application is to check the adequacy or to recommend the required number of ramp lanes or acceleration and deceleration lane length given the volume or flow rate and LOS goal. This application is termed design since its primary output is a geometric attribute. Other outputs from this application include speed and density.

Another general type of analysis is termed planning. These analyses use estimates, HCM default values, and local default values as inputs in the calculation. As outputs, LOS, number of lanes, and length of acceleration or deceleration lane can be determined, along with the secondary outputs of density and speed. The difference between planning analysis and operational or design analysis is that most or all of the input values in planning come from estimates or default values, whereas operational and design analyses tend to use field measurements or known values. Note that for each of the analyses, free-flow speed of the mainline and ramp, either measured or estimated, is required as an input for the computation.

COMPUTATIONAL STEPS

The worksheet for computations is shown in Exhibit 25-20. For all applications, the analyst provides general information and site information.

Operational (LOS)

For operational analysis (LOS), both the geometry and demand volumes must be fully specified. A sketch of the geometry of the ramp is entered into the upper portion of the worksheet. All demand volumes are specified in mixed vehicles per hour for the full hour under consideration and must be converted to flow rates (for the peak 15 min of the hour) in passenger cars per hour under equivalent base conditions. Then the flow rate of freeway vehicles remaining in Lanes 1 and 2 immediately upstream of the merge point or at the beginning of the deceleration lane is computed. Once v_{12} is estimated, this value can be combined with known values of v_F and v_R to find the checkpoint flow rates needed to compare with the capacity values. If the operations are undersaturated, the expected density in the ramp influence area is computed and LOS is determined by comparing the resultant density with LOS criteria of Exhibit 25-4. If speeds are desired as a secondary output or required for other analyses, they may be estimated.

Design (L_A , L_D , or N)

Design (L_A , L_D , or N) analysis is used to establish the required number of lanes or acceleration or deceleration lane length in a design application. The key to this application is the establishment of design hourly volumes and the desired LOS. All other input parameters are entered on the worksheet (see Exhibit 25-20) and assumed geometric features are noted. Then the analyst follows the same procedure described in the operational (LOS) application to determine LOS. The estimated LOS is compared with the desired LOS. This process is repeated by increasing or decreasing the attribute or attributes of a geometric feature until the estimated LOS matches or is better than the desired LOS.

PLANNING APPLICATIONS

Planning (LOS)
Planning (L_A , L_D , or N)

For the two planning applications, planning (LOS) and planning (L_A , L_D , or N), procedures correspond directly to procedures described for the operational (LOS) and design (L_A , L_D , or N) analyses in the previous section, respectively.

EXHIBIT 25-20. RAMPS AND RAMP JUNCTIONS WORKSHEET

RAMPS AND RAMP JUNCTIONS WORKSHEET									
General Information					Site Information				
Analyst _____					Freeway/Direction of Travel _____				
Agency or company _____					Junction _____				
Date Performed _____					Jurisdiction _____				
Analysis Time Period _____					Analysis Year _____				
<input type="checkbox"/> Operational (LOS)		<input type="checkbox"/> Design (L _A , L _D , or N)			<input type="checkbox"/> Planning (LOS)			<input type="checkbox"/> Planning (L _A , L _D , or N)	
Inputs									
Upstream Adjacent Ramp		Terrain _____				Downstream Adjacent Ramp			
<input type="checkbox"/> Yes <input type="checkbox"/> On						<input type="checkbox"/> Yes <input type="checkbox"/> On			
<input type="checkbox"/> No <input type="checkbox"/> Off						<input type="checkbox"/> No <input type="checkbox"/> Off			
L _{up} = _____ m						L _{down} = _____ m			
V _u = _____ veh/h						V _D = _____ veh/h			
		S _{FF} = _____ km/h		S _{FR} = _____ km/h					
Sketch (show lanes, L _A , L _D , V _R , V _F)									
Conversion to pc/h Under Base Conditions									
(pc/h)	AADT (veh/day)	K	D	V (veh/h)	PHF	% HV	f _{HV}	f _p	$v = \frac{V}{PHF f_{HV} f_p}$
V _F									
V _R									
V _u									
V _D									
Merge Areas					Diverge Areas				
Estimation of v ₁₂					Estimation of v ₁₂				
$v_{12} = V_F + P_{FM}$					$v_{12} = V_R + (V_F - V_R)P_{FD}$				
L _{EQ} = _____ (Equation 25-2 or 25-3)					L _{EQ} = _____ (Equation 25-8 or 25-9)				
P _{FM} = _____ using Equation _____ (Exhibit 25-5)					P _{FD} = _____ using Equation _____ (Exhibit 25-12)				
v ₁₂ = _____ pc/h					v ₁₂ = _____ pc/h				
Capacity Checks				Capacity Checks					
	Actual	Maximum	LOS F?		Actual	Maximum	LOS F?		
V _{F0}		See Exhibit 25-7		V _{F1} = V _F		See Exhibit 25-14			
				V ₁₂		4400: All			
V _{R12}		4600: All		V _{F0} = V _F - V _R		See Exhibit 25-14			
				V _R		See Exhibit 25-3			
Level-of-Service Determination (if not F)					Level-of-Service Determination (if not F)				
$D_R = 3.402 + 0.00456 v_R + 0.0048 v_{12} - 0.01278 L_A$					$D_R = 2.642 + 0.0053 v_{12} - 0.0183 L_D$				
D _R = _____ pc/km/ln					D _R = _____ pc/km/ln				
LOS = _____ (Exhibit 25-4)					LOS = _____ (Exhibit 25-4)				
Speed Estimation					Speed Estimation				
M _s = _____ (Exhibit 25-19)					D _s = _____ (Exhibit 25-19)				
S _R = _____ km/h (Exhibit 25-19)					S _R = _____ km/h (Exhibit 25-19)				
S ₀ = _____ km/h (Exhibit 25-19)					S ₀ = _____ km/h (Exhibit 25-19)				
S = _____ km/h (Equation 25-14)					S = _____ km/h (Equation 25-15)				

The first criterion that categorizes these as planning applications is the use of estimates, HCM default values, or local default values on the input side of the calculation. Another factor that defines a given application as planning is the use of annual average daily traffic (AADT) to estimate directional design-hour volume (DDHV). DDHV is calculated using a known or forecast value of K (proportion of AADT occurring during the peak hour) and D. Further guidelines for computing DDHV are given in Chapter 8.

In order to perform planning applications, the analyst typically has few, if any, of the required input values. Chapter 13 contains more on the use of default values.

ANALYSIS TOOLS

The worksheet shown in Exhibit 25-20 and provided in Appendix A can be used to perform operational (LOS), planning (LOS), design (L_A , L_D , or N,) and planning (L_A , L_D , or N) analyses.

IV. EXAMPLE PROBLEMS

Problem No.	Description	Application
1	Determine LOS, density, and expected speed of an isolated on-ramp	Operational (LOS)
2	Determine LOS, density, and expected speed of two consecutive off-ramps	Operational (LOS)
3	Determine LOS, density, and expected speed of on-ramp, off-ramp pair	Operational (LOS)
4	Determine LOS, density, and expected speed of a two-lane on-ramp	Operational (LOS)
5	Determine LOS, density, and expected speed of an off-ramp	Operational (LOS)
6	Determine LOS, density, and expected speed of a left-side on-ramp	Operational (LOS)

EXAMPLE PROBLEM 1

The Ramp An isolated on-ramp (single lane) to a four-lane freeway.

The Question What is the LOS during the peak hour?

The Facts

- √ Isolated location,
- √ Two-lane (in one direction) freeway segment,
- √ 3.6-m lane width on freeway,
- √ 0 percent RVs,
- √ Ramp volume = 550 veh/h,
- √ 10 percent trucks on freeway,
- √ Acceleration lane length = 225 m,
- √ FFS = 70 km/h for ramp,
- √ One-lane ramp,
- √ Level terrain,
- √ Adequate lateral clearances,
- √ FFS = 100 km/h for freeway,
- √ 5 percent trucks on ramp,
- √ Freeway volume = 2,500 veh/h,
- √ PHF = 0.90, and
- √ Drivers are regular commuters.

Comments

- √ Use Chapter 23, "Basic Freeway Segments," to identify f_{HV} and f_p .

Outline of Solution All input parameters are known; thus no default values are required. Demand volumes will be converted to flow rates. Capacity will then be checked. The density in the merge influence area will be calculated and LOS determined.

Steps

1. Convert volume (veh/h) to flow rate (pc/h) (use Equation 25-1).	$v = \frac{V}{(PHF)(f_{HV})(f_p)}$ $v_F = \frac{2,500}{(0.90)(0.952)(1.000)} = 2,918 \text{ pc/h}$ $v_R = \frac{550}{(0.90)(0.976)(1.000)} = 626 \text{ pc/h}$
1a. Determine f_p (use Chapter 23).	For both ramp and freeway, $f_p = 1.000$
1b. Determine f_{HV} (use Chapter 23).	$f_{HV} = \frac{1}{1 + P_T(E_T - 1) + P_R(E_R - 1)}$ $f_{HV} \text{ (fwy)} = \frac{1}{1 + 0.10(1.5 - 1)} = 0.952$ $f_{HV} \text{ (ramp)} = \frac{1}{1 + 0.05(1.5 - 1)} = 0.976$
2. Compute v_{12} (use Exhibit 25-5, $P_{FM} = 1.000$).	$v_{12} = v_F * P_{FM} = 2,918 * 1.000 = 2,918 \text{ pc/h}$
3. Check capacity of downstream segment (Exhibit 25-7 shows 4,600 pc/h).	$v_{FO} = v_F + v_R$ $v_{FO} = 2,918 + 626 = 3,544 \text{ pc/h}$
4. Check maximum flow entering influence area (Exhibit 25-7 shows 4,600 pc/h).	$v_{R12} = 3,544 \text{ pc/h}$
5. Compute density (use Equation 25-5).	$D_R = 3.402 + 0.00456v_R + 0.0048v_{12} - 0.01278L_A$ $D_R = 3.402 + 0.00456(626) + 0.0048(2918) - 0.01278(225)$ $= 17.4 \text{ pc/km/ln}$
6. Compute merge area speed as supplemental information (use Exhibit 25-19).	$S_R = S_{FF} - (S_{FF} - 67)M_s$ $M_s = 0.321 + 0.0039e^{(3544/1000)} - 0.004(225 * 70/1000) = 0.393$ $S_R = 100 - (100 - 67)(0.393) = 87.0 \text{ km/h}$ $S = S_R = 87.0 \text{ km/h}$
7. Determine LOS (use Exhibit 25-4).	LOS D

The Results This on-ramp merge influence area will provide LOS D during the peak hour. The merge area density will be 17.4 pc/km/ln, and the speed in the merge area is estimated as 87 km/h.

Example Problem 1

RAMPS AND RAMP JUNCTIONS WORKSHEET									
General Information					Site Information				
Analyst		RPR			Freeway/Direction of Travel		I-1		
Agency or company		Poly			Junction		Ramp #1		
Date Performed					Jurisdiction				
Analysis Time Period		PM Peak			Analysis Year		1999		
<input checked="" type="checkbox"/> Operational (LOS)		<input type="checkbox"/> Design (L _A , L _D , or N)			<input type="checkbox"/> Planning (LOS)		<input type="checkbox"/> Planning (L _A , L _D , or N)		
Inputs									
Upstream Adjacent Ramp		<div style="text-align: center;"> Terrain <u>Level</u> </div>					Downstream Adjacent Ramp		
<input type="checkbox"/> Yes <input type="checkbox"/> On <input checked="" type="checkbox"/> No <input type="checkbox"/> Off L _{up} = _____ m V _u = _____ veh/h							<input type="checkbox"/> Yes <input type="checkbox"/> On <input checked="" type="checkbox"/> No <input type="checkbox"/> Off L _{down} = _____ m V _D = _____ veh/h		
		S _{FF} = <u>100</u> km/h		S _{FR} = <u>70</u> km/h		Sketch (show lanes, L _A , L _D , V _R , V _F)			
Conversion to pc/h Under Base Conditions									
(pc/h)	AADT (veh/day)	K	D	V (veh/h)	PHF	% HV	f _{HV}	f _p	v = $\frac{V}{PHF f_{HV} f_p}$
V _F				2500	0.90	10	0.952	1.000	2918
V _R				550	0.90	5	0.976	1.000	626
V _U									
V _D									
Merge Areas					Diverge Areas				
Estimation of v ₁₂					Estimation of v ₁₂				
$v_{12} = V_F * P_{FM}$ L _{EQ} = _____ (Equation 25-2 or 25-3) P _{FM} = <u>1.000</u> using Equation _____ (Exhibit 25-5) v ₁₂ = <u>2918</u> pc/h					$v_{12} = V_R + (V_F - V_R)P_{FD}$ L _{EQ} = _____ (Equation 25-8 or 25-9) P _{FD} = _____ using Equation _____ (Exhibit 25-12) v ₁₂ = _____ pc/h				
Capacity Checks					Capacity Checks				
	Actual	Maximum	LOS F?		Actual	Maximum	LOS F?		
V _{F0}	3544	See Exhibit 25-7	No	V _{F1} = V _F		See Exhibit 25-14			
				V ₁₂		4400: All			
V _{R12}	3544	4600: All	No	V _{F0} = V _F - V _R		See Exhibit 25-14			
				V _R		See Exhibit 25-3			
Level-of-Service Determination (if not F)					Level-of-Service Determination (if not F)				
$D_R = 3.402 + 0.00456 V_R + 0.0048 v_{12} - 0.01278 L_A$ D _R = <u>17.4</u> pc/km/ln LOS = <u>D</u> (Exhibit 25-4)					$D_R = 2.642 + 0.0053 v_{12} - 0.0183 L_D$ D _R = _____ pc/km/ln LOS = _____ (Exhibit 25-4)				
Speed Estimation					Speed Estimation				
M _s = <u>0.393</u> (Exhibit 25-19) S _R = <u>87.0</u> km/h (Exhibit 25-19) S ₀ = _____ km/h (Exhibit 25-19) S = <u>87.0</u> km/h (Equation 25-14)					D _s = _____ (Exhibit 25-19) S _R = _____ km/h (Exhibit 25-19) S ₀ = _____ km/h (Exhibit 25-19) S = _____ km/h (Equation 25-15)				

EXAMPLE PROBLEM 2 (PART I)

The Ramp An off-ramp (single-lane) pair, 225 m apart, from a six-lane freeway. The length of the first deceleration lane is 150 m and that of the second deceleration lane is 90 m.

The Question What is the LOS during the peak hour for the first off-ramp?

The Facts

- √ One-lane off-ramps,
- √ FFS = 100 km/h for freeway,
- √ Rolling terrain,
- √ PHF = 0.95,
- √ 0 percent RVs,
- √ Drivers are regular commuters,
- √ FFS = 60 km/h for first off-ramp,
- √ Three-lane (in one direction) freeway segment,
- √ 5 percent trucks on freeway and off-ramps,
- √ Freeway volume = 4,500 veh/h, and
- √ First off-ramp volume = 300 veh/h.

Comments

- √ Use Chapter 23, "Basic Freeway Segments," to identify f_{HV} and f_p .

Outline of Solution All input parameters are known; thus no default values are required. Demand volumes will be converted to flow rates. Capacity will then be checked. The density in the diverge influence area will be calculated and LOS determined. Computations for the first ramp are shown below.

Steps

1. Convert volume (veh/h) to flow rate (pc/h) (use Equation 25-1).	$v = \frac{V}{(PHF)(f_{HV})(f_p)}$ $v_F = \frac{4,500}{(0.95)(0.930)(1.000)} = 5,093 \text{ pc/h}$ $v_{R1} = \frac{300}{(0.95)(0.930)(1.000)} = 340 \text{ pc/h}$
1a. Determine f_p (use Chapter 23).	For ramps and freeway, $f_p = 1.000$
1b. Determine f_{HV} (use Chapter 23).	$f_{HV} = \frac{1}{1 + P_T(E_T - 1) + P_R(E_R - 1)}$ $f_{HV} \text{ (fwy and ramps)} = \frac{1}{1 + 0.05(2.5 - 1)} = 0.930$
2. Compute v_{12} (use Exhibit 25-12).	$v_{12} = v_R + (v_F - v_R)P_{FD}$ $v_{12} = 340 + (5,093 - 340)(0.617) = 3,273 \text{ pc/h}$
2a. Decide on which equation to use, Equation 5 or 7 (use Equation 25-9).	$L_{EQ} = \frac{566}{3.79 - 0.00011(5093) - 0.00121(340)} = 201 \text{ m}$ <p>225 m > 201 m ($L_{down} > L_{EQ}$); use Equation 5</p>
2b. Compute P_{FD} (use Exhibit 25-12).	$P_{FD} = 0.760 - 0.000025v_F - 0.000046v_R$ $P_{FD} = 0.760 - 0.000025(5,093) - 0.000046(340) = 0.617$
3. Check capacity of upstream segment (Exhibit 25-14 shows 6,900 pc/h).	$v_F = 5,093 \text{ pc/h}$
4. Check maximum flow entering diverge influence area (Exhibit 25-14 shows 4,400 pc/h).	$v_{12} = 3,273 \text{ pc/h}$
5. Check capacity of downstream segment (Exhibit 25-14 shows 6,900 pc/h).	$v_{FO} = v_F - v_R$ $v_{FO} = 5,093 - 340 = 4,753 \text{ pc/h}$
6. Check capacity of off-ramp (use Exhibit 25-3, 2,000 pc/h).	$v_R = 340 \text{ pc/h}$
7. Compute density (use Equation 25-10).	$D_R = 2.642 + 0.0053v_{12} - 0.0183L_D$ $D_R = 2.642 + 0.0053(3273) - 0.0183(150) = 17.2 \text{ pc/km/n}$
8. Compute speeds as supplemental information (use Exhibit 25-19 and Equations 25-13 and 25-15).	$S_R = S_{FF} - (S_{FF} - 67)D_s$ $D_s = 0.883 + 0.00009(340) - 0.008(60) = 0.434$ $S_R = 100 - (100 - 67)(0.434) = 85.7 \text{ km/h}$ $v_{OA} = (v_F - v_{12})/N_O = (5,093 - 3,273)/1 = 1,820 \text{ pc/h}$

8. (continued)	$S_O = 1.06S_{FF} - 0.0062(v_{OA} - 1000)$ $S_O = 1.06(100) - 0.0062(1820 - 1000) = 100.9 \text{ km/h}$ $S = \frac{3273 + (1820)(1)}{\left(\frac{3273}{85.7}\right) + \left(\frac{1820(1)}{100.9}\right)} = 90.6 \text{ km/h}$
9. Determine LOS (use Exhibit 25-4).	LOS D

The Results The first off-ramp diverge influence area will provide LOS D with a diverge influence area speed of 86 km/h, system speed of 91 km/h, and density of 17.2 pc/km/ln.

Example Problem 2 (Part I)

RAMPS AND RAMP JUNCTIONS WORKSHEET									
General Information					Site Information				
Analyst		JMU			Freeway/Direction of Travel		I-2		
Agency or company		Poly			Junction		Ramp #1		
Date Performed					Jurisdiction				
Analysis Time Period		AM Peak			Analysis Year		1999		
<input checked="" type="checkbox"/> Operational (LOS)		<input type="checkbox"/> Design (L _A , L _D , or N)			<input type="checkbox"/> Planning (LOS)		<input type="checkbox"/> Planning (L _A , L _D , or N)		
Inputs									
Upstream Adjacent Ramp		Terrain <u>Rolling</u>				Downstream Adjacent Ramp			
<input type="checkbox"/> Yes <input type="checkbox"/> On						<input checked="" type="checkbox"/> Yes <input type="checkbox"/> On			
<input checked="" type="checkbox"/> No <input type="checkbox"/> Off						<input type="checkbox"/> No <input checked="" type="checkbox"/> Off			
L _{up} = _____ m		S _{FF} = <u>100</u> km/h S _{FR} = <u>60</u> km/h				L _{down} = <u>225</u> m			
V _u = _____ veh/h		Sketch (show lanes, L _A , L _D , V _R , V _F)				V _D = <u>500</u> veh/h			
Conversion to pc/h Under Base Conditions									
(pc/h)	AADT (veh/day)	K	D	V (veh/h)	PHF	% HV	f _{HV}	f _p	v = $\frac{V}{PHF f_{HV} f_p}$
V _F				4500	0.95	5	0.930	1.000	5093
V _R				300	0.95	5	0.930	1.000	340
V _U				-	-	-	-	-	-
V _D				500	0.95	5	0.930	1.000	566
Merge Areas					Diverge Areas				
Estimation of v ₁₂					Estimation of v ₁₂				
v ₁₂ = V _F * P _{FM}					v ₁₂ = V _R + (V _F - V _R)P _{FD}				
L _{EQ} = _____ (Equation 25-2 or 25-3)					L _{EQ} = <u>201</u> (Equation 25-8 or 25-9)				
P _{FM} = _____ using Equation _____ (Exhibit 25-5)					P _{FD} = <u>0.617</u> using Equation <u>5</u> (Exhibit 25-12)				
v ₁₂ = _____ pc/h					v ₁₂ = <u>3273</u> pc/h				
Capacity Checks				Capacity Checks					
	Actual	Maximum	LOS F?		Actual	Maximum	LOS F?		
V _{F0}		See Exhibit 25-7		V _{F1} = V _F	5093	See Exhibit 25-14	No		
				V ₁₂	3273	4400: All	No		
V _{R12}		4600: All		V _{F0} = V _F - V _R	4753	See Exhibit 25-14	No		
				V _R	340	See Exhibit 25-3	No		
Level-of-Service Determination (if not F)				Level-of-Service Determination (if not F)					
D _R = 3.402 + 0.00456 v _R + 0.0048 v ₁₂ - 0.01278 L _A				D _R = 2.642 + 0.0053 v ₁₂ - 0.0183 L _D					
D _R = _____ pc/km/ln				D _R = <u>17.2</u> pc/km/ln					
LOS = _____ (Exhibit 25-4)				LOS = <u>D</u> (Exhibit 25-4)					
Speed Estimation				Speed Estimation					
M _s = _____ (Exhibit 25-19)				D _s = <u>0.434</u> (Exhibit 25-19)					
S _R = _____ km/h (Exhibit 25-19)				S _R = <u>85.7</u> km/h (Exhibit 25-19)					
S _O = _____ km/h (Exhibit 25-19)				S _O = <u>100.9</u> km/h (Exhibit 25-19)					
S = _____ km/h (Equation 25-14)				S = <u>90.6</u> km/h (Equation 25-15)					

EXAMPLE PROBLEM 2 (PART II)

The Ramp An off-ramp (single-lane) pair, 225 m apart, from a six-lane freeway. The length of the first deceleration lane is 150 m and that of the second deceleration lane is 90 m.

The Question What is the LOS during the peak hour for the second off-ramp?

Additional Facts

- ✓ Second off-ramp volume = 500 veh/h, and
- ✓ FFS = 40 km/h for second off-ramp.

Comments

- ✓ Use Chapter 23, "Basic Freeway Segments," to identify f_{HV} and f_p .

Outline of Solution All input parameters are known; thus no default values are required. Demand volumes will be converted to flow rates. Capacity will then be checked. The density in the diverge area will be calculated and LOS determined. Computations for the second ramp are summarized below.

Steps

1. Convert volume (veh/h) to flow rate (pc/h) (use Equation 25-1).	$v = \frac{V}{(PHF)(f_{HV})(f_p)}$ $v_F = 5,093 - 340 = 4,753 \text{ pc/h}$ $v_{R2} = \frac{500}{(0.95)(0.930)(1.000)} = 566 \text{ pc/h}$
2. Compute v_{12} (use Exhibit 25-12).	$v_{12} = v_R + (v_F - v_R)P_{FD}$ $v_{12} = 566 + (4,753 - 566)(0.615) = 3,141 \text{ pc/h}$
2a. Compute P_{FD} (use Exhibit 25-12).	$P_{FD} = 0.760 - 0.000025v_F - 0.000046v_R$ $P_{FD} = 0.760 - 0.000025(4,753) - 0.000046(566) = 0.615$
3. Check capacity of upstream segment (Exhibit 25-14 shows 6,900 pc/h).	$v_F = 4,753 \text{ pc/h}$
4. Check maximum flow entering diverge influence area (Exhibit 25-14 shows 4,400 pc/h).	$v_{12} = 3,141 \text{ pc/h}$
5. Check capacity of downstream segment (Exhibit 25-14 shows 6,900 pc/h).	$v_{FO} = v_F - v_R$ $v_{FO} = 4,753 - 566 = 4,187 \text{ pc/h}$
6. Check capacity of off-ramp (use Exhibit 25-3, 1,900 pc/h).	$v_R = 566 \text{ pc/h}$
7. Compute density (use Equation 25-10).	$D_R = 2.642 + 0.0053v_{12} - 0.0183L_D$ $D_R = 2.642 + 0.0053(3141) - 0.0183(90) = 17.6 \text{ pc/km/ln}$
8. Compute speeds as supplemental information (use Exhibit 25-19 and Equations 25-13 and 25-15).	$S_R = S_{FF} - (S_{FF} - 67)D_s$ $D_s = 0.883 + 0.00009(566) - 0.008(40) = 0.614$ $S_R = 100 - (100 - 67)(0.614) = 79.7 \text{ km/h}$ $v_{OA} = (v_F - v_{12})/N_O = (4,753 - 3,141)/1 = 1,612 \text{ pc/h}$ $S_O = 1.06S_{FF} - 0.0062(v_{OA} - 1000)$ $S_O = 1.06(100) - 0.0062(1612 - 1000) = 102.2 \text{ km/h}$ $S = \frac{3141 + 1612(1)}{\left(\frac{3141}{79.7}\right) + \left(\frac{1612(1)}{102.2}\right)} = 86.1 \text{ km/h}$
9. Determine LOS (use Exhibit 25-4).	LOS D

The Results The second off-ramp diverge influence area will provide LOS D with a diverge influence area speed of 80 km/h, system speed of 86 km/h, and density of 17.6 pc/km/ln.

Example Problem 2 (Part II)

RAMPS AND RAMP JUNCTIONS WORKSHEET									
General Information					Site Information				
Analyst		JMU			Freeway/Direction of Travel		I-2		
Agency or company		Poly			Junction		Ramp #2		
Date Performed					Jurisdiction				
Analysis Time Period		AM Peak			Analysis Year		1999		
<input checked="" type="checkbox"/> Operational (LOS)		<input type="checkbox"/> Design (L _A , L _D , or N)			<input type="checkbox"/> Planning (LOS)		<input type="checkbox"/> Planning (L _A , L _D , or N)		
Inputs									
Upstream Adjacent Ramp		Terrain <u>Rolling</u>				Downstream Adjacent Ramp			
<input checked="" type="checkbox"/> Yes <input type="checkbox"/> On						<input type="checkbox"/> Yes <input type="checkbox"/> On			
<input type="checkbox"/> No <input checked="" type="checkbox"/> Off						<input checked="" type="checkbox"/> No <input type="checkbox"/> Off			
L _{up} = <u>225</u> m		S _{FF} = <u>100</u> km/h		S _{FR} = <u>40</u> km/h		L _{down} = _____ m		V _D = _____ veh/h	
V _u = <u>300</u> veh/h		Sketch (show lanes, L _A , L _D , V _R , V _F)							
Conversion to pc/h Under Base Conditions									
(pc/h)	AADT (veh/day)	K	D	V (veh/h)	PHF	% HV	f _{HV}	f _p	v = $\frac{V}{PHF f_{HV} f_p}$
V _F									4753
V _R				500	0.95	5	0.930	1.000	566
V _U				300	0.95	5	0.930	1.000	340
V _D				-	-	-	-	-	-
Merge Areas					Diverge Areas				
Estimation of v₁₂					Estimation of v₁₂				
v ₁₂ = V _F * P _{FM}					v ₁₂ = V _R + (V _F - V _R)P _{FD}				
L _{EQ} = _____ (Equation 25-2 or 25-3)					L _{EQ} = _____ (Equation 25-8 or 25-9)				
P _{FM} = _____ using Equation _____ (Exhibit 25-5)					P _{FD} = <u>0.615</u> using Equation <u>5</u> (Exhibit 25-12)				
v ₁₂ = _____ pc/h					v ₁₂ = <u>3141</u> pc/h				
Capacity Checks					Capacity Checks				
	Actual	Maximum	LOS F?		Actual	Maximum	LOS F?		
V _{F0}		See Exhibit 25-7		V _{F1} = V _F	4753	See Exhibit 25-14	No		
				V ₁₂	3141	4400: All	No		
V _{R12}		4600: All		V _{F0} = V _F - V _R	4187	See Exhibit 25-14	No		
				V _R	566	See Exhibit 25-3	No		
Level-of-Service Determination (if not F)					Level-of-Service Determination (if not F)				
D _R = 3.402 + 0.00456 V _R + 0.0048 V ₁₂ - 0.01278 L _A					D _R = 2.642 + 0.0053 V ₁₂ - 0.0183 L _D				
D _R = _____ pc/km/ln					D _R = <u>17.6</u> pc/km/ln				
LOS = _____ (Exhibit 25-4)					LOS = <u>D</u> (Exhibit 25-4)				
Speed Estimation					Speed Estimation				
M _s = _____ (Exhibit 25-19)					D _s = <u>0.614</u> (Exhibit 25-19)				
S _R = _____ km/h (Exhibit 25-19)					S _R = <u>79.7</u> km/h (Exhibit 25-19)				
S ₀ = _____ km/h (Exhibit 25-19)					S ₀ = <u>102.2</u> km/h (Exhibit 25-19)				
S = _____ km/h (Equation 25-14)					S = <u>86.1</u> km/h (Equation 25-15)				

EXAMPLE PROBLEM 3 (PART I)

The Ramp An on-ramp and off-ramp (single-lane) pair, 400 m apart, to an eight-lane freeway. The length of both the acceleration and deceleration lanes is 80 m.

The Question What is the LOS during the peak hour for the on-ramp merge influence area?

The Facts

- √ One-lane on- and off-ramps,
- √ Level terrain,
- √ 3.6-m lane width on freeway,
- √ PHF = 0.90,
- √ Freeway volume = 5,500 veh/h,
- √ FFS = 50 km/h for on-ramp,
- √ FFS = 100 km/h for freeway,
- √ Four-lane (in one direction) freeway segment,
- √ 10 percent trucks on freeway,
- √ 5 percent trucks on on-ramp,
- √ 0 percent RVs,
- √ On-ramp volume = 400 veh/h, and
- √ Drivers are regular commuters.

Comments

- √ Use Chapter 23, "Basic Freeway Segments," to identify f_{HV} and f_p .

Outline of Solution All input parameters are known; thus no default values are required. Demand volumes will be converted to flow rates. Capacity will then be checked. The density in the merge influence area will be calculated and LOS determined.

Steps

1. Convert volume (veh/h) to flow rate (pc/h) (use Equation 25-1).	$v = \frac{V}{(PHF)(f_{HV})(f_p)}$ $v_F = \frac{5,500}{(0.90)(0.952)(1.000)} = 6,419 \text{ pc/h}$ $v_{R1} = \frac{400}{(0.90)(0.976)(1.000)} = 455 \text{ pc/h}$
1a. Determine f_{HV} (use Chapter 23).	$f_{HV} = \frac{1}{1 + P_T(E_T - 1) + P_R(E_R - 1)}$ $f_{HV} \text{ (fwy)} = \frac{1}{1 + 0.10(1.5 - 1)} = 0.952$ $f_{HV} \text{ (on-ramp)} = \frac{1}{1 + 0.05(1.5 - 1)} = 0.976$
2. Compute v_{12} (use Exhibit 25-5).	$v_{12} = v_F * P_{FM} = 6,419 * 0.255 = 1,637 \text{ pc/h}$
2a. Compute P_{FM} (use Exhibit 25-5).	$P_{FM} = 0.2178 - 0.000125v_R + 0.05887 L_A/S_{FR}$ $P_{FM} = 0.2178 - 0.000125(455) + 0.05887(80/50) = 0.255$
3. Check capacity of downstream segment (Exhibit 25-7 shows 9,200 pc/h).	$v_{FO} = 6,419 + 455 = 6,874 \text{ pc/h}$
4. Check maximum flow entering merge influence area (Exhibit 25-7 shows 4,600 pc/h).	$v_{R12} = 1,637 + 455 = 2,092 \text{ pc/h}$
5. Compute density (use Equation 25-5).	$D_R = 3.402 + 0.00456v_R + 0.0048v_{12} - 0.01278L_A$ $D_R = 3.402 + 0.00456(455) + 0.0048(1637) - 0.01278(80) = 12.3 \text{ pc/km/ln}$
6. Compute speeds as supplemental information (use Exhibit 25-19 and Equations 25-13 and 25-14).	$S_R = S_{FF} - (S_{FF} - 67)M_s$ $M_s = 0.321 + 0.0039e^{(2092/1000)} - 0.004(80 * 50/1000) = 0.337$ $S_R = 100 - (100 - 67)(0.337) = 88.9 \text{ km/h}$ $v_{OA} = (v_F - v_{12})/N_O = (6,419 - 1,637)/2 = 2,391 \text{ pc/h}$ $S_O = S_{FF} - 10.52 - 0.01(v_{OA} - 2300)$ $S_O = 100 - 10.52 - 0.01(2391 - 2300) = 88.6 \text{ km/h}$ $S = \frac{2092 + 2391(2)}{\left(\frac{2092}{88.9}\right) + \left(\frac{2391 * 2}{88.6}\right)} = 88.7 \text{ km/h}$
7. Determine LOS (use Exhibit 25-4).	LOS C

The Results This on-ramp merge influence area will provide LOS C with a merge influence area speed of 89 km/h, system speed of 89 km/h, and density of 12.3 pc/km/ln.

Example Problem 3 (Part I)

RAMPS AND RAMP JUNCTIONS WORKSHEET									
General Information					Site Information				
Analyst		MMU			Freeway/Direction of Travel		I-3		
Agency or company		UNC			Junction		Ramp #1		
Date Performed					Jurisdiction				
Analysis Time Period		PM Peak			Analysis Year		1999		
<input checked="" type="checkbox"/> Operational (LOS)		<input type="checkbox"/> Design (L _A , L _D , or N)			<input type="checkbox"/> Planning (LOS)		<input type="checkbox"/> Planning (L _A , L _D , or N)		
Inputs									
Upstream Adjacent Ramp		Terrain <u>Level</u>				Downstream Adjacent Ramp			
<input type="checkbox"/> Yes <input type="checkbox"/> On						<input checked="" type="checkbox"/> Yes <input type="checkbox"/> On			
<input checked="" type="checkbox"/> No <input type="checkbox"/> Off						<input type="checkbox"/> No <input checked="" type="checkbox"/> Off			
L _{up} = _____ m		S _{FF} = <u>100</u> km/h S _{FR} = <u>50</u> km/h				L _{down} = <u>400</u> m			
V _u = _____ veh/h		Sketch (show lanes, L _A , L _D , V _R , V _F)				V _D = <u>600</u> veh/h			
Conversion to pc/h Under Base Conditions									
(pc/h)	AADT (veh/day)	K	D	V (veh/h)	PHF	% HV	f _{HV}	f _p	v = $\frac{V}{PHF f_{HV} f_p}$
V _F				5500	0.90	10	0.952	1.000	6419
V _R				400	0.90	5	0.976	1.000	455
V _U				-	-	-	-	-	-
V _D				600	0.90	10	0.952	1.000	700
Merge Areas					Diverge Areas				
Estimation of v ₁₂					Estimation of v ₁₂				
v ₁₂ = v _F * P _{FM}					v ₁₂ = v _R + (v _F - v _R)P _{FD}				
L _{EQ} = _____ (Equation 25-2 or 25-3)					L _{EQ} = _____ (Equation 25-8 or 25-9)				
P _{FM} = <u>0.255</u> using Equation <u>4</u> (Exhibit 25-5)					P _{FD} = _____ using Equation _____ (Exhibit 25-12)				
v ₁₂ = <u>1637</u> pc/h					v ₁₂ = _____ pc/h				
Capacity Checks				Capacity Checks					
	Actual	Maximum	LOS F?		Actual	Maximum	LOS F?		
V _{F0}	<u>6874</u>	See Exhibit 25-7	No	V _{F1} = v _F		See Exhibit 25-14			
				V ₁₂		4400: All			
V _{R12}	<u>2092</u>	4600: All	No	V _{F0} = v _F - v _R		See Exhibit 25-14			
				V _R		See Exhibit 25-3			
Level-of-Service Determination (if not F)				Level-of-Service Determination (if not F)					
D _R = 3.402 + 0.00456 v _R + 0.0048 v ₁₂ - 0.01278 L _A				D _R = 2.642 + 0.0053 v ₁₂ - 0.0183 L _D					
D _R = <u>12.3</u> pc/km/ln				D _R = _____ pc/km/ln					
LOS = <u>C</u> (Exhibit 25-4)				LOS = _____ (Exhibit 25-4)					
Speed Estimation				Speed Estimation					
M _s = <u>0.337</u> (Exhibit 25-19)				D _s = _____ (Exhibit 25-19)					
S _R = <u>88.9</u> km/h (Exhibit 25-19)				S _R = _____ km/h (Exhibit 25-19)					
S _D = <u>88.6</u> km/h (Exhibit 25-19)				S _D = _____ km/h (Exhibit 25-19)					
S = <u>88.7</u> km/h (Equation 25-14)				S = _____ km/h (Equation 25-15)					

EXAMPLE PROBLEM 3 (PART II)

The Ramp An on-ramp and off-ramp (single-lane) pair, 400 m apart, to an eight-lane freeway. The length of acceleration and deceleration lanes is 80 m.

The Question What is the LOS of the off-ramp diverge influence area during the peak hour?

Additional Facts

- √ 10 percent trucks on off-ramp, √ Off-ramp volume = 600 veh/h.
- √ FFS = 40 km/h for off-ramp, and

Comments

- √ Use Chapter 23, "Basic Freeway Segments," to identify f_{HV} and f_p .
- √ Volume for freeway = 5,500 + 400 = 5,900 veh/h
- √ % trucks on freeway = $\frac{5,500(10) + 400(5)}{5,900} = 9.7\%$

Outline of Solution All input parameters are known; thus no default values are required. Demand volumes will be converted to flow rates. Capacity will then be checked. The density in the diverge influence area will be calculated and LOS determined.

Steps

1. Convert volume (veh/h) to flow rate (pc/h) (use Equation 25-1).	$v = \frac{V}{(PHF)(f_{HV})(f_p)}$ $v_F = \frac{5,900}{(0.90)(0.954)(1.000)} = 6,872 \text{ pc/h}$ $v_{R2} = \frac{600}{(0.90)(0.952)(1.000)} = 700 \text{ pc/h}$
1a. Determine f_{HV} (use Chapter 23).	$f_{HV} \text{ (fwy)} = \frac{1}{1 + 0.097(1.5 - 1)} = 0.954$ $f_{HV} \text{ (off-ramp)} = \frac{1}{1 + 0.10(1.5 - 1)} = 0.952$
2. Compute v_{12} (use Exhibit 25-12, $P_{FD} = 0.436$).	$v_{12} = v_R + (v_F - v_R)P_{FD}$ $v_{12} = 700 + (6,872 - 700)(0.436) = 3,391 \text{ pc/h}$
3. Check capacity of upstream segment (Exhibit 25-14 shows 9,200 pc/h).	$v_F = 6,872 \text{ pc/h}$
4. Check maximum flow entering diverge influence area (Exhibit 25-14 shows 4,400 pc/h).	$v_{12} = 3,391 \text{ pc/h}$
5. Check capacity of downstream segment (Exhibit 25-14 shows 9,200 pc/h).	$v_{FO} = 6,872 - 700 = 6,172 \text{ pc/h}$
6. Check capacity of off-ramp (use Exhibit 25-3, 1,900 pc/h).	$v_{R2} = 700 \text{ pc/h}$
7. Compute density (use Equation 25-10).	$D_R = 2.642 + 0.0053v_{12} - 0.0183L_D$ $D_R = 2.642 + 0.0053(3391) - 0.0183(80)$ $D_R = 19.2 \text{ pc/km/ln}$
8. Compute speeds as supplemental information (use Exhibit 25-19 and Equations 25-13 and 25-15).	$S_R = S_{FF} - (S_{FF} - 67)D_s$ $D_s = 0.883 + 0.00009(700) - 0.008(40) = 0.626$ $S_R = 100 - (100 - 67)(0.626) = 79.3 \text{ km/h}$ $v_{OA} = (v_F - v_{12})/N_O = (6,872 - 3,391)/2 = 1,741 \text{ pc/h}$ $S_O = 1.06S_{FF} - 0.0062(v_{OA} - 1000)$ $S_O = 1.06(100) - 0.0062(1741 - 1000) = 101.4 \text{ km/h}$ $S = \frac{3391 + 1741(2)}{\left(\frac{3391}{79.3}\right) + \left(\frac{1741 \cdot 2}{101.4}\right)} = 89.1 \text{ km/h}$
9. Determine LOS (use Exhibit 25-4).	LOS D

The Results The off-ramp diverge influence area will provide LOS D with a diverge influence area speed of 79 km/h, system speed of 89 km/h, and density of 19.2 pc/km/ln.

Example Problem 3 (Part II)

RAMPS AND RAMP JUNCTIONS WORKSHEET									
General Information					Site Information				
Analyst		MMU			Freeway/Direction of Travel		I-3		
Agency or company		UNC			Junction		Ramp #2		
Date Performed					Jurisdiction				
Analysis Time Period		PM Peak			Analysis Year		1999		
<input checked="" type="checkbox"/> Operational (LOS)		<input type="checkbox"/> Design (L _A , L _D , or N)			<input type="checkbox"/> Planning (LOS)		<input type="checkbox"/> Planning (L _A , L _D , or N)		
Inputs									
Upstream Adjacent Ramp		Terrain <u>Level</u>				Downstream Adjacent Ramp			
<input checked="" type="checkbox"/> Yes <input checked="" type="checkbox"/> On						<input type="checkbox"/> Yes <input type="checkbox"/> On			
<input type="checkbox"/> No <input type="checkbox"/> Off						<input checked="" type="checkbox"/> No <input type="checkbox"/> Off			
L _{up} = <u>400</u> m		S _{FF} = <u>100</u> km/h S _{FR} = <u>40</u> km/h				L _{down} = _____ m			
V _u = <u>400</u> veh/h		Sketch (show lanes, L _A , L _D , V _R , V _F)				V _D = _____ veh/h			
Conversion to pc/h Under Base Conditions									
(pc/h)	AADT (veh/day)	K	D	V (veh/h)	PHF	% HV	f _{HV}	f _p	v = $\frac{V}{PHF f_{HV} f_p}$
V _F				5900	0.90	9.7	0.954	1.000	6872
V _R				600	0.90	10	0.952	1.000	700
V _U				400	0.90	5	0.976	1.000	455
V _D				-	-	-	-	-	-
Merge Areas					Diverge Areas				
Estimation of v ₁₂					Estimation of v ₁₂				
v ₁₂ = v _F * P _{FM}					v ₁₂ = v _R + (v _F - v _R)P _{FD}				
L _{EQ} = _____ (Equation 25-2 or 25-3)					L _{EQ} = _____ (Equation 25-8 or 25-9)				
P _{FM} = _____ using Equation _____ (Exhibit 25-5)					P _{FD} = <u>0.436</u> using Equation <u>8</u> (Exhibit 25-12)				
v ₁₂ = _____ pc/h					v ₁₂ = <u>3391</u> pc/h				
Capacity Checks				Capacity Checks					
	Actual	Maximum	LOS F?		Actual	Maximum	LOS F?		
V _{F0}		See Exhibit 25-7		V _{F1} = v _F	6872	See Exhibit 25-14	No		
				V ₁₂	3391	4400: All	No		
V _{R12}		4600: All		V _{F0} = v _F - v _R	6172	See Exhibit 25-14	No		
				V _R	700	See Exhibit 25-3	No		
Level-of-Service Determination (if not F)					Level-of-Service Determination (if not F)				
D _R = 3.402 + 0.00456 v _R + 0.0048 v ₁₂ - 0.01278 L _A					D _R = 2.642 + 0.0053 v ₁₂ - 0.0183 L _D				
D _R = _____ pc/km/ln					D _R = <u>19.2</u> pc/km/ln				
LOS = _____ (Exhibit 25-4)					LOS = <u>D</u> (Exhibit 25-4)				
Speed Estimation					Speed Estimation				
M _s = _____ (Exhibit 25-19)					D _s = <u>0.626</u> (Exhibit 25-19)				
S _R = _____ km/h (Exhibit 25-19)					S _R = <u>79.3</u> km/h (Exhibit 25-19)				
S _D = _____ km/h (Exhibit 25-19)					S _D = <u>101.4</u> km/h (Exhibit 25-19)				
S = _____ km/h (Equation 25-14)					S = <u>89.1</u> km/h (Equation 25-15)				

EXAMPLE PROBLEM 4

The Ramp A two-lane on-ramp to a six-lane freeway. The length of the outer acceleration lane is 150 m and that of the inner acceleration lane is 270 m.

The Question What is the LOS of this ramp during the peak hour?

The Facts

- √ Two-lane on-ramp,
- √ Level terrain,
- √ 5 percent trucks on freeway and ramp,
- √ 0 percent RVs,
- √ FFS = 80 km/h for ramp,
- √ PHF = 0.95,
- √ Three-lane (in one direction) freeway segment,
- √ Freeway volume = 3,000 veh/h,
- √ On-ramp volume = 1,800 veh/h,
- √ Drivers are regular commuters, and
- √ FFS = 110 km/h for freeway.

Comments

- √ Use Chapter 23, "Basic Freeway Segments," to identify f_{HV} and f_p .

Outline of Solution All input parameters are known; thus no default values are required. Demand volumes will be converted to flow rates. Capacity will then be checked. The density in the merge influence area will be calculated and LOS determined.

Steps

1. Convert volume (veh/h) to flow rate (pc/h) (use Equation 25-1).	$v = \frac{V}{(PHF)(f_{HV})(f_p)}$ $v_F = \frac{3,000}{(0.95)(0.976)(1.000)} = 3,236 \text{ pc/h}$ $v_R = \frac{1,800}{(0.95)(0.976)(1.000)} = 1,941 \text{ pc/h}$
1a. Determine f_{HV} (use Chapter 23).	$f_{HV} = \frac{1}{1 + P_T(E_T - 1) + P_R(E_R - 1)}$ $f_{HV} \text{ (fwy and ramps)} = \frac{1}{1 + 0.05(1.5 - 1)}$ $f_{HV} \text{ (fwy and ramps)} = 0.976$
2. Compute v_{12} ($P_{FM} = 0.555$ for 2-lane ramp on 6-lane fwy).	$v_{12} = v_F * P_{FM}$ $v_{12} = 3,236 * 0.555 = 1,796 \text{ pc/h}$
3. Check capacity of downstream segment (Exhibit 25-7 shows 7,050 pc/h).	$v_{FO} = 3,236 + 1,941 = 5,177 \text{ pc/h}$
4. Check maximum flow entering merge influence area (Exhibit 25-7 shows 4,600 pc/h).	$v_{R12} = 1,796 + 1,941 = 3,737 \text{ pc/h}$
5. Compute density (use Equation 25-5).	$D_R = 3.402 + 0.00456v_R + 0.0048v_{12} - 0.01278L_{Aeff}$ $D_R = 3.402 + 0.00456(1941) + 0.0048(1796) - 0.01278(420) = 15.5 \text{ pc/km/ln}$
5a. Compute L_{Aeff} (use Equation 25-6).	$L_{Aeff} = 2L_{A1} + L_{A2}$ $L_{Aeff} = 2(150) + 120 = 420 \text{ m}$
6. Compute system speed as supplemental information (use Exhibit 25-19 and Equations 25-13 and 25-14).	$S_R = S_{FF} - (S_{FF} - 67)M_s$ $M_s = 0.321 + 0.0039e^{(3737/1000)} - 0.004(420 * 80/1000) = 0.350$ $S_R = 110 - (110 - 67)(0.350) = 95.0 \text{ km/h}$ $v_{OA} = (v_F - v_{12})/N_O = (3,236 - 1,796)/1 = 1,440 \text{ pc/h}$

6. (continued)	$S_O = S_{FF} - 0.0058(V_{OA} - 500)$ $S_O = 110 - 0.0058(1440 - 500) = 104.5 \text{ km/h}$ $S = \frac{3737 + 1440(1)}{\left(\frac{3737}{95.0}\right) + \left(\frac{1440 * 1}{104.5}\right)} = 97.5 \text{ km/h}$
7. Determine LOS (use Exhibit 25-4).	LOS C

The Results The on-ramp merge influence area will provide LOS C with a merge influence area speed of 95 km/h, system speed of 98 km/h, and density of 15.5 pc/km/ln.

Example Problem 4

RAMPS AND RAMP JUNCTIONS WORKSHEET									
General Information					Site Information				
Analyst		CMU			Freeway/Direction of Travel		Route 4		
Agency or company		Poly			Junction		Ramp #1		
Date Performed					Jurisdiction				
Analysis Time Period		PM Peak			Analysis Year		1999		
<input checked="" type="checkbox"/> Operational (LOS)		<input type="checkbox"/> Design (L _A , L _D , or N)			<input type="checkbox"/> Planning (LOS)		<input type="checkbox"/> Planning (L _A , L _D , or N)		
Inputs									
Upstream Adjacent Ramp		Terrain <u>Level</u>					Downstream Adjacent Ramp		
<input type="checkbox"/> Yes <input type="checkbox"/> On							<input type="checkbox"/> Yes <input type="checkbox"/> On		
<input checked="" type="checkbox"/> No <input type="checkbox"/> Off							<input checked="" type="checkbox"/> No <input type="checkbox"/> Off		
L _{up} = _____ m		S _{FF} = <u>110</u> km/h S _{FR} = <u>80</u> km/h					L _{down} = _____ m		
V _u = _____ veh/h		Sketch (show lanes, L _A , L _D , V _R , V _F)					V _D = _____ veh/h		
Conversion to pc/h Under Base Conditions									
(pc/h)	AADT (veh/day)	K	D	V (veh/h)	PHF	% HV	f _{HV}	f _p	v = $\frac{V}{PHF f_{HV} f_p}$
V _F				3000	0.95	5	0.976	1.000	3236
V _R				1800	0.95	5	0.976	1.000	1941
V _U									
V _D									
Merge Areas					Diverge Areas				
Estimation of v ₁₂					Estimation of v ₁₂				
v ₁₂ = V _F * P _{FM}					v ₁₂ = V _R + (V _F - V _R)P _{FD}				
L _{EQ} = _____ (Equation 25-2 or 25-3)					L _{EQ} = _____ (Equation 25-8 or 25-9)				
P _{FM} = <u>0.555</u> using Equation <i>special case</i> (Exhibit 25-5)					P _{FD} = _____ using Equation _____ (Exhibit 25-12)				
v ₁₂ = <u>1796</u> pc/h					v ₁₂ = _____ pc/h				
Capacity Checks					Capacity Checks				
	Actual	Maximum	LOS F?		Actual	Maximum	LOS F?		
V _{F0}	5177	See Exhibit 25-7	No	V _{F1} = V _F		See Exhibit 25-14			
				V ₁₂		4400: All			
V _{R12}	3737	4600: All	No	V _{F0} = V _F - V _R		See Exhibit 25-14			
				V _R		See Exhibit 25-3			
Level-of-Service Determination (if not F)					Level-of-Service Determination (if not F)				
D _R = 3.402 + 0.00456 V _R + 0.0048 v ₁₂ - 0.01278 L _A					D _R = 2.642 + 0.0053 v ₁₂ - 0.0183 L _D				
D _R = <u>15.5</u> pc/km/ln					D _R = _____ pc/km/ln				
LOS = <u>C</u> (Exhibit 25-4)					LOS = _____ (Exhibit 25-4)				
Speed Estimation					Speed Estimation				
M _S = <u>0.350</u> (Exhibit 25-19)					D _S = _____ (Exhibit 25-19)				
S _R = <u>95.0</u> km/h (Exhibit 25-19)					S _R = _____ km/h (Exhibit 25-19)				
S _O = <u>104.5</u> km/h (Exhibit 25-19)					S _O = _____ km/h (Exhibit 25-19)				
S = <u>97.5</u> km/h (Equation 25-14)					S = _____ km/h (Equation 25-15)				

EXAMPLE PROBLEM 5

The Ramp An off-ramp (single-lane) from a 10-lane freeway. The length of the deceleration lane is 220 m.

The Question What is the LOS during the peak hour for current conditions?

The Facts

- √ One-lane off-ramp,
- √ Rolling terrain,
- √ 10 percent trucks on freeway and ramp,
- √ 0 percent RVs,
- √ Off-ramp volume = 400 veh/h,
- √ Commuter traffic,
- √ Five-lane (in one direction) freeway segment,
- √ PHF = 0.95,
- √ One-way peak-hour freeway volume = 7,200 veh/h,
- √ FFS = 70 km/h for off-ramp, and
- √ FFS = 100 km/h for freeway.

Comments

- √ Use Chapter 23, "Basic Freeway Segments," to identify f_{HV} and f_p .
- √ Estimate eight-lane equivalent freeway segment flow rate assuming v_5 is 20 percent of v_F .

Outline of Solution Demand volumes will be converted to flow rates. An eight-lane equivalent freeway segment flow rate will be established. Capacity will then be checked. Density will be calculated and LOS determined.

Steps

1. Convert volume (veh/h) to flow rate (pc/h) (use Equation 25-1).	$v = \frac{V}{(PHF)(f_{HV})(f_p)}$ $v_F = \frac{7,200}{(0.95)(0.870)(1.000)} = 8,711 \text{ pc/h}$ $v_R = \frac{400}{(0.95)(0.870)(1.000)} = 484 \text{ pc/h}$
1a. Determine f_{HV} (use Chapter 23).	$f_{HV} = \frac{1}{1 + P_T(E_T - 1) + P_R(E_R - 1)}$ $f_{HV} \text{ (fwy and ramps)} = \frac{1}{1 + 0.10(2.5 - 1)} = 0.870$
2. Estimate eight-lane equivalent freeway flow rate (Exhibit 25-18).	$v_{F4eff} = v_F - v_5$ $v_5 = 0.20v_F = 0.20(8,711) = 1,742 \text{ pc/h}$ $v_{F4eff} = 8,711 - 1,742 = 6,969 \text{ pc/h}$
3. Compute v_{12} (use Exhibit 25-12, $P_{FD} = 0.436$).	$v_{12} = v_R + (v_F - v_R)P_{FD}$ $v_{12} = 484 + (6,969 - 484)(0.436) = 3,311 \text{ pc/h}$
4. Check capacity of upstream segment (Exhibit 25-14 shows 9,200 pc/h).	$v_F = 6,969 \text{ pc/h}$
5. Check maximum flow entering diverge influence area (Exhibit 25-14 shows 4,400 pc/h).	$v_{12} = 3,311 \text{ pc/h}$
6. Check capacity of downstream segment (Exhibit 25-14 shows 9,200 pc/h).	$v_{FO} = 6,969 - 484 = 6,485 \text{ pc/h}$
7. Check capacity of off-ramp (use Exhibit 25-3, 2,100 pc/h).	$v_R = 484 \text{ pc/h}$
8. Compute density (use Equation 25-10).	$D_R = 2.642 + 0.0053v_{12} - 0.0183 L_D$ $D_R = 2.642 + 0.0053(3311) - 0.0183(220) = 16.2 \text{ pc/km/ln}$
9. Compute speeds as supplemental information (use Exhibit 25-19 and Equations 25-13 and 25-15).	$S_R = S_{FF} - (S_{FF} - 67)D_s$ $D_s = 0.883 + 0.00009(484) - 0.008(70) = 0.367$ $S_R = 100 - (100 - 67)(0.367) = 87.9 \text{ km/h}$ $v_{OA} = (v_F - v_{12})/N_O = (6969 - 3,311)/2 = 1,829 \text{ pc/h}$

9. (continued)	$S_O = 1.06S_{FF} - 0.0062(v_{OA} - 1000)$ $S_O = 1.06(100) - 0.0062(1829 - 1000) = 100.9 \text{ km/h}$ $S = \frac{3311 + 1829(2)}{\left(\frac{3311}{87.9}\right) + \left(\frac{1829(2)}{100.9}\right)} = 94.3 \text{ km/h}$
10. Determine LOS (use Exhibit 25-4).	LOS C

The Results The off-ramp diverge influence area will provide LOS C with a diverge influence area speed of 88 km/h, system speed of 94 km/h, and density of 16.2 pc/km/ln.

Example Problem 5

RAMPS AND RAMP JUNCTIONS WORKSHEET									
General Information					Site Information				
Analyst		RPR			Freeway/Direction of Travel		I-5		
Agency or company		Poly			Junction		Ramp #1		
Date Performed					Jurisdiction				
Analysis Time Period		AM Peak			Analysis Year		1999		
<input checked="" type="checkbox"/> Operational (LOS)		<input type="checkbox"/> Design (L _A , L _D , or N)			<input type="checkbox"/> Planning (LOS)		<input type="checkbox"/> Planning (L _A , L _D , or N)		
Inputs									
Upstream Adjacent Ramp		Terrain <u>Rolling</u>				Downstream Adjacent Ramp			
<input type="checkbox"/> Yes <input type="checkbox"/> On						<input type="checkbox"/> Yes <input type="checkbox"/> On			
<input checked="" type="checkbox"/> No <input type="checkbox"/> Off						<input checked="" type="checkbox"/> No <input type="checkbox"/> Off			
L _{up} = _____ m		S _{FF} = <u>100</u> km/h		S _{FR} = <u>70</u> km/h		L _{down} = _____ m		V _D = _____ veh/h	
V _u = _____ veh/h		Sketch (show lanes, L _A , L _D , V _R , V _F)							
Conversion to pc/h Under Base Conditions									
(pc/h)	AADT (veh/day)	K	D	V (veh/h)	PHF	% HV	f _{HV}	f _p	v = $\frac{V}{PHF f_{HV} f_p}$
V _F				7200	0.95	10	0.870	1.000	8711
V _R				400	0.95	10	0.870	1.000	484
V _U									
V _D									
Merge Areas					Diverge Areas				
Estimation of v ₁₂					Estimation of v ₁₂				
v ₁₂ = v _F * P _{FM}					v ₁₂ = v _R + (v _F - v _R)P _{FD}				
L _{EQ} = _____ (Equation 25-2 or 25-3)					L _{EQ} = _____ (Equation 25-8 or 25-9)				
P _{FM} = _____ using Equation _____ (Exhibit 25-5)					P _{FD} = <u>0.436</u> using Equation <u>8</u> (Exhibit 25-12)				
v ₁₂ = _____ pc/h					v ₁₂ = <u>3311</u> pc/h				
Capacity Checks				Capacity Checks					
	Actual	Maximum	LOS F?		Actual	Maximum	LOS F?		
V _{F0}		See Exhibit 25-7		v _{F1} = v _F	6969	See Exhibit 25-14	No		
				v ₁₂	3311	4400: All	No		
V _{R12}		4600: All		v _{F0} = v _F - v _R	6485	See Exhibit 25-14	No		
				v _R	484	See Exhibit 25-3	No		
Level-of-Service Determination (if not F)					Level-of-Service Determination (if not F)				
D _R = 3.402 + 0.00456 v _R + 0.0048 v ₁₂ - 0.01278 L _A					D _R = 2.642 + 0.0053 v ₁₂ - 0.0183 L _D				
D _R = _____ pc/km/ln					D _R = <u>16.2</u> pc/km/ln				
LOS = _____ (Exhibit 25-4)					LOS = <u>C</u> (Exhibit 25-4)				
Speed Estimation					Speed Estimation				
M _S = _____ (Exhibit 25-19)					D _S = <u>0.367</u> (Exhibit 25-19)				
S _R = _____ km/h (Exhibit 25-19)					S _R = <u>87.9</u> km/h (Exhibit 25-19)				
S _O = _____ km/h (Exhibit 25-19)					S _O = <u>100.9</u> km/h (Exhibit 25-19)				
S = _____ km/h (Equation 25-14)					S = <u>94.3</u> km/h (Equation 25-15)				

EXAMPLE PROBLEM 6

The Ramp An on-ramp (single lane on the left-hand side of freeway) to a six-lane freeway. The length of the acceleration lane is 250 m.

The Question What is the LOS during the peak hour?

The Facts

- √ Left-side one-lane on-ramp,
- √ Level terrain,
- √ 5 percent trucks on ramp,
- √ Freeway volume = 4,000 veh/h,
- √ FFS = 50 km/h for on-ramp,
- √ FFS = 110 km/h for freeway,
- √ Three lanes in one direction,
- √ 15 percent trucks on freeway,
- √ PHF = 0.90,
- √ On-ramp volume = 500 veh/h,
- √ Commuter traffic, and
- √ 0 percent RVs.

Comments

- √ Use Chapter 23, "Basic Freeway Segments," to identify f_{HV} and f_p .
- √ On a six-lane freeway, the flow in the left two lanes is 1.12 times the flow in Lanes 1 and 2 if the ramp is on the left side.

Outline to Solution Demand volumes will be converted to flow rates. v_{12} is computed as if the ramp were on the right-hand side, then adjusted by a factor to account for the left-hand ramp. Two capacity values will then be checked (freeway departing and total flow entering the influence area). Density will be calculated and LOS determined.

Steps

1. Convert volume (veh/h) to flow rate (pc/h) (use Equation 25-1).	$v = \frac{V}{(PHF)(f_{HV})(f_p)}$ $v_F = \frac{4,000}{(0.90)(0.930)(1.000)} = 4,779 \text{ pc/h}$ $v_R = \frac{500}{(0.90)(0.976)(1.000)} = 569 \text{ pc/h}$
1a. Determine f_{HV} (use Chapter 23).	$f_{HV} = \frac{1}{1 + P_T(E_T - 1) + P_R(E_R - 1)}$ $f_{HV} (\text{fwy}) = \frac{1}{1 + 0.15(1.5 - 1)} = 0.930$ $f_{HV} (\text{ramp}) = \frac{1}{1 + 0.05(1.5 - 1)} = 0.976$
2. Compute v_{12} (use Exhibit 25-5).	$v_{12} = v_F * P_{FM} = 4,779 * 0.601 = 2,872 \text{ pc/h}$
2a. Compute P_{FM} (use Exhibit 25-5).	$P_{FM} = 0.5775 + 0.000092(250) = 0.601$
3. Compute v_{23} .	$v_{23} = 2,872(1.12) = 3,217 \text{ pc/h}$
4. Check capacity of downstream segment (Exhibit 25-7 shows 7,050 pc/h).	$v_{FO} = v_F + v_R = 4,779 + 569 = 5,348 \text{ pc/h}$
5. Check v_{R23} (Exhibit 25-7 shows 4,600 pc/h).	$v_{R23} = v_{23} + v_R = 3,217 + 569 = 3,786 \text{ pc/h}$
6. Compute density (use Equation 25-5).	$D_R = 3.402 + 0.00456v_R + 0.0048v_{23} - 0.01278L_A$ $D_R = 3.402 + 0.00456(569) + 0.0048(3217) - 0.01278(250) = 18.2 \text{ pc/km/ln}$
7. Compute speeds as supplemental information (use Exhibit 25-19 and Equations 25-13 and 25-14).	$S_R = S_{FF} - (S_{FF} - 67)M_s$ $M_s = 0.321 + 0.0039e^{(3786/1000)} - 0.004(250 * 50/1,000) = 0.443$ $S_R = 110 - (110 - 67)(0.443) = 91.0 \text{ km/h}$ $v_{OA} = (v_F - v_{23})/N_O = (4,779 - 3,217)/1 = 1,562 \text{ pc/h}$ $S_O = S_{FF} - 0.0058(v_{OA} - 500) = 103.8 \text{ km/h}$ $S = \frac{3786 + 1562(1)}{\left(\frac{3786}{91.0}\right) + \left(\frac{1562(1)}{103.8}\right)} = 94.4 \text{ km/h}$
8. Determine LOS (use Exhibit 25-4).	LOS D

The Results This on-ramp merge influence area will provide LOS D with a merge influence area speed of 91 km/h, system speed of 94 km/h, and density of 18.2 pc/km/ln.

Example Problem 6

RAMPS AND RAMP JUNCTIONS WORKSHEET									
General Information					Site Information				
Analyst		XU			Freeway/Direction of Travel		Route 6		
Agency or company		Poly			Junction		Ramp #1		
Date Performed					Jurisdiction				
Analysis Time Period		PM Peak			Analysis Year		1999		
<input checked="" type="checkbox"/> Operational (LOS)		<input type="checkbox"/> Design (L _A , L _D , or N)			<input type="checkbox"/> Planning (LOS)		<input type="checkbox"/> Planning (L _A , L _D , or N)		
Inputs									
Upstream Adjacent Ramp		Terrain <u>Level</u>				Downstream Adjacent Ramp			
<input type="checkbox"/> Yes <input type="checkbox"/> On		<p style="font-size: small;">Sketch (show lanes, L_A, L_D, V_R, V_F)</p>				<input type="checkbox"/> Yes <input type="checkbox"/> On			
<input checked="" type="checkbox"/> No <input type="checkbox"/> Off						<input checked="" type="checkbox"/> No <input type="checkbox"/> Off			
L _{up} = _____ m						L _{down} = _____ m			
V _u = _____ veh/h						V _D = _____ veh/h			
		S _{FF} = <u>110</u> km/h		S _{FR} = <u>50</u> km/h					
Conversion to pc/h Under Base Conditions									
(pc/h)	AADT (veh/day)	K	D	V (veh/h)	PHF	% HV	f _{HV}	f _p	v = $\frac{V}{PHF f_{HV} f_p}$
V _F				4000	0.90	15	0.930	1.000	4779
V _R				500	0.90	5	0.976	1.000	569
V _U									
V _D									
Merge Areas					Diverge Areas				
Estimation of v₁₂					Estimation of v₁₂				
$v_{12} = V_F + P_{FM}$					$v_{12} = V_R + (V_F - V_R)P_{FD}$				
L _{EQ} = _____ (Equation 25-2 or 25-3)					L _{EQ} = _____ (Equation 25-8 or 25-9)				
P _{FM} = <u>0.601</u> using Equation <u>1</u> (Exhibit 25-5)					P _{FD} = _____ using Equation _____ (Exhibit 25-12)				
v ₁₂ = <u>2872</u> pc/h v ₂₃ = v ₁₂ × 1.12 = 3217					v ₁₂ = _____ pc/h				
Capacity Checks					Capacity Checks				
	Actual	Maximum	LOS F?		Actual	Maximum	LOS F?		
V _{F0}	5348	See Exhibit 25-7	No	V _{F1} = V _F		See Exhibit 25-14			
				V ₁₂		4400: All			
V _{R12}	3786	4600: All	No	V _{F0} = V _F - V _R		See Exhibit 25-14			
				V _R		See Exhibit 25-3			
Level-of-Service Determination (if not F)					Level-of-Service Determination (if not F)				
$D_R = 3.402 + 0.00456 v_R + 0.0048 v_{12} - 0.01278 L_A$					$D_R = 2.642 + 0.0053 v_{12} - 0.0183 L_D$				
D _R = <u>18.2</u> pc/km/ln					D _R = _____ pc/km/ln				
LOS = <u>D</u> (Exhibit 25-4)					LOS = _____ (Exhibit 25-4)				
Speed Estimation					Speed Estimation				
M _s = <u>0.443</u> (Exhibit 25-19)					D _s = _____ (Exhibit 25-19)				
S _R = <u>91.0</u> km/h (Exhibit 25-19)					S _R = _____ km/h (Exhibit 25-19)				
S ₀ = <u>103.8</u> km/h (Exhibit 25-19)					S ₀ = _____ km/h (Exhibit 25-19)				
S = <u>94.4</u> km/h (Equation 25-14)					S = _____ km/h (Equation 25-15)				

V. REFERENCES

1. Roess, R., and J. Ulerio. *Capacity of Ramp-Freeway Junctions, Final Report*. NCHRP Project 3-37. Polytechnic University, Brooklyn, N.Y., Nov. 1993.
2. Leisch, J. *Capacity Analysis Techniques for Design and Operation of Freeway Facilities*. FHWA, U.S. Department of Transportation, 1974.
3. *A Policy on Geometric Design of Highways and Streets*. American Association of State Highway and Transportation Officials, Washington, D.C., 1990.
4. Elefteriadou, L. *A Probabilistic Model of Breakdown at Freeway-Merge Junctions*. Doctoral dissertation. Polytechnic University, Brooklyn, N.Y., June 1994.

APPENDIX A. WORKSHEET

RAMPS AND RAMP JUNCTIONS WORKSHEET

RAMPS AND RAMP JUNCTIONS WORKSHEET									
General Information					Site Information				
Analyst _____					Freeway/Direction of Travel _____				
Agency or company _____					Junction _____				
Date Performed _____					Jurisdiction _____				
Analysis Time Period _____					Analysis Year _____				
<input type="checkbox"/> Operational (LOS)		<input type="checkbox"/> Design (L _A , L _D , or N)			<input type="checkbox"/> Planning (LOS)			<input type="checkbox"/> Planning (L _A , L _D , or N)	
Inputs									
Upstream Adjacent Ramp		Terrain _____				Downstream Adjacent Ramp			
<input type="checkbox"/> Yes <input type="checkbox"/> On						<input type="checkbox"/> Yes <input type="checkbox"/> On			
<input type="checkbox"/> No <input type="checkbox"/> Off						<input type="checkbox"/> No <input type="checkbox"/> Off			
L _{up} = _____ m						L _{down} = _____ m			
V _u = _____ veh/h						V _D = _____ veh/h			
		S _{FF} = _____ km/h		S _{FR} = _____ km/h					
Sketch (show lanes, L _A , L _D , V _R , V _F)									
Conversion to pc/h Under Base Conditions									
(pc/h)	AADT (veh/day)	K	D	V (veh/h)	PHF	% HV	f _{HV}	f _p	$v = \frac{V}{PHF f_{HV} f_p}$
V _F									
V _R									
V _U									
V _D									
Merge Areas					Diverge Areas				
Estimation of v₁₂					Estimation of v₁₂				
$v_{12} = v_F * P_{FM}$					$v_{12} = v_R + (v_F - v_R)P_{FD}$				
L _{EQ} = _____ (Equation 25-2 or 25-3)					L _{EQ} = _____ (Equation 25-8 or 25-9)				
P _{FM} = _____ using Equation _____ (Exhibit 25-5)					P _{FD} = _____ using Equation _____ (Exhibit 25-12)				
v ₁₂ = _____ pc/h					v ₁₂ = _____ pc/h				
Capacity Checks					Capacity Checks				
	Actual	Maximum		LOS F?		Actual	Maximum		LOS F?
V _{F0}		See Exhibit 25-7			V _{F1} = v _F		See Exhibit 25-14		
					V ₁₂		4400: All		
V _{R12}		4600: All			V _{F0} = v _F - v _R		See Exhibit 25-14		
					V _R		See Exhibit 25-3		
Level-of-Service Determination (if not F)					Level-of-Service Determination (if not F)				
$D_R = 3.402 + 0.00456 v_R + 0.0048 v_{12} - 0.01278 L_A$					$D_R = 2.642 + 0.0053 v_{12} - 0.0183 L_D$				
D _R = _____ pc/km/ln					D _R = _____ pc/km/ln				
LOS = _____ (Exhibit 25-4)					LOS = _____ (Exhibit 25-4)				
Speed Estimation					Speed Estimation				
M _s = _____ (Exhibit 25-19)					D _s = _____ (Exhibit 25-19)				
S _R = _____ km/h (Exhibit 25-19)					S _R = _____ km/h (Exhibit 25-19)				
S ₀ = _____ km/h (Exhibit 25-19)					S ₀ = _____ km/h (Exhibit 25-19)				
S = _____ km/h (Equation 25-14)					S = _____ km/h (Equation 25-15)				

CHAPTER 26

INTERCHANGE RAMP TERMINALS

CONTENTS

I. INTRODUCTION26-1
 Types of Interchanges26-1
 Diamond Interchanges26-1
 Partial Cloverleaf Interchanges26-1
 Influence of Interchange Type on Turning Movements26-3
 Unique Operations at Signalized Diamond Interchanges26-4
 Queuing Characteristics26-5
 Lane Change Movements26-6
 Lane Utilization26-6
 Platoon Behavior26-6
 Demand Starvation26-7
 Signal Phasing and Timing Strategies26-7
 II. METHODOLOGY26-7
 LOS Framework26-7
 Saturation Flow Rates for Interchange Lane Groups26-9
 III. APPLICATIONS26-10
 IV. EXAMPLE PROBLEMS26-11
 V. REFERENCES26-11
 APPENDIX A. TIMING CONSIDERATIONS FOR SIGNALIZED
 DIAMOND INTERCHANGES26-11
 Phasing Options26-12
 Establishing Offsets26-13
 APPENDIX B. ASSESSMENT OF ALTERNATIVE
 INTERCHANGE CONFIGURATIONS26-14

EXHIBITS

Exhibit 26-1. Types of Diamond Interchanges26-2
 Exhibit 26-2. Types of Cloverleaf Interchanges26-3
 Exhibit 26-3. Effects of Interchange Type on Turning Movements26-4
 Exhibit 26-4. Typical Signalized Diamond Interchange26-5
 Exhibit 26-5. Lane Change Movements at a Diamond Interchange26-6
 Exhibit 26-6. Movements in a Diamond Interchange26-8
 Exhibit 26-7. Components of Interchange Delay26-8
 Exhibit 26-8. LOS Criteria for Interchanges26-9
 Exhibit 26-9. Framework for Comprehensive Interchange Ramp
 Terminal Analysis26-10
 Exhibit A26-1. Common Signalization Schemes for Diamond Interchanges26-12
 Exhibit A26-2. Four-Phase Plan with Overlap26-13

I. INTRODUCTION

This chapter presents general material for analyzing interchange ramp terminals involving freeways, major highways, and urban streets. Although the chapter presents ideas and concepts relating to most types of interchanges that include two intersections, it focuses primarily on signalized, two-intersection diamond interchanges. The close proximity of the two signalized intersections forming the diamond creates interactive effects that complicate the analysis. A complete methodology for predicting the impact of these effects is not yet available; this chapter therefore is primarily conceptual in content.

TYPES OF INTERCHANGES

Several interchange types are recognized in the literature. The common types that may result in two closely spaced surface intersections are illustrated and discussed here. The single-point diamond interchange, with only one signalized intersection, also is illustrated. The term freeway is used here to denote a freeway, expressway, or a major through highway.

Diamond Interchanges

Most forms of diamond interchanges result in two or more closely spaced surface intersections, as illustrated in Exhibit 26-1. On a diamond interchange, only one connection is made for each freeway entry and exit, with one connection per quadrant. Left- and right-turning movements are used for entry to or exit from the two directions of the surface facility; diamond interchanges require left-turn movements. In rural areas, the junction of diamond interchange ramps with the surface facility is often controlled by stop or yield signs. If traffic demand is high, signalization becomes necessary.

There are many variations on the diamond interchange. The typical diamond has three subcategories defined by the spacing of the intersections formed by the ramp-street connections. Conventional diamond interchanges provide a separation of 240 m or more between the two intersections. Compressed diamond interchanges have intersections spaced between 120 m and 240 m, and tight urban diamond interchanges feature spacing of less than 120 m.

Split diamond interchanges have freeway entry and exit ramps separated at the street level, creating four intersections. Diamond configurations also can be combined with continuous one-way frontage roads. The frontage roads become one-way arterials, and turning movements at the intersections created by the diamond interchange become even more complex, due to the additional need to serve movements to and from the frontage road. Separated U-turn lanes also may be added, removing U-turns from the signal scheme, if there is a signal. A partial diamond interchange has fewer than four ramps, so that not all of the freeway-street or street-freeway movements are served. A three-level diamond interchange features two divided levels, so that ramps are necessary on both facilities to allow continuous through movements. Two interlocking split diamonds are created.

A single-point diamond interchange combines all the ramp movements into a single signalized intersection and has the advantage of operating as such. The design eliminates the critical issue of coordinating the operation of two closely spaced intersections.

All of these forms of diamond interchanges are depicted in Exhibit 26-1.

Partial Cloverleaf Interchanges

Partial cloverleaf interchanges—or parclos—are depicted in Exhibit 26-2. A variety of partial cloverleaf interchanges can be created with one or two loop ramps. In such cases, one or two of the outer ramps take the form of a diamond ramp, allowing a movement to take place by making a left turn. In some partial cloverleaf configurations, left turns also may be made onto or off of a loop ramp.

EXHIBIT 26-1. TYPES OF DIAMOND INTERCHANGES

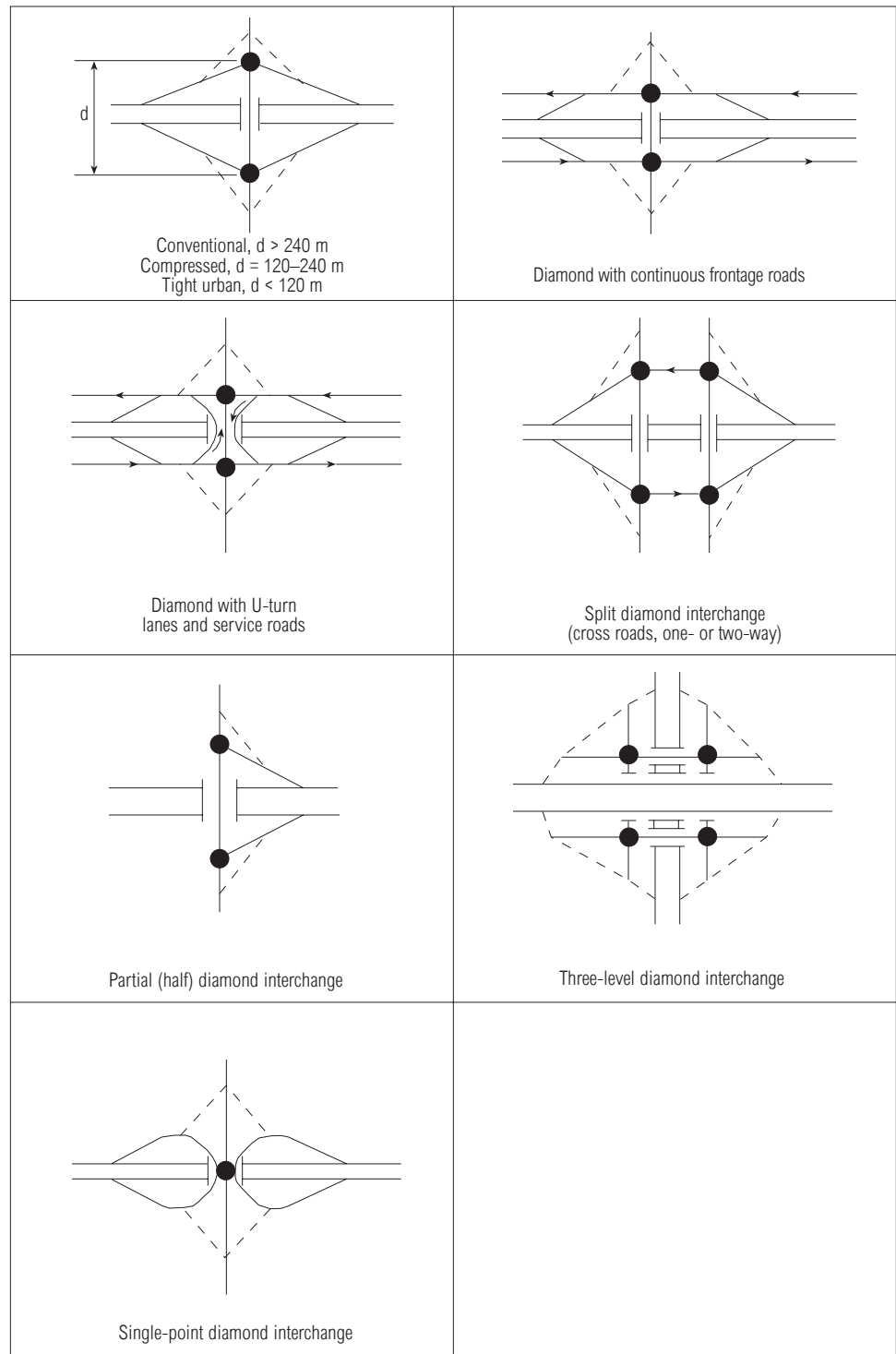

Note:
Schematic, not to scale.
- - - - Possible configuration of signal bypasses operating as unsignalized movements

EXHIBIT 26-2. TYPES OF CLOVERLEAF INTERCHANGES

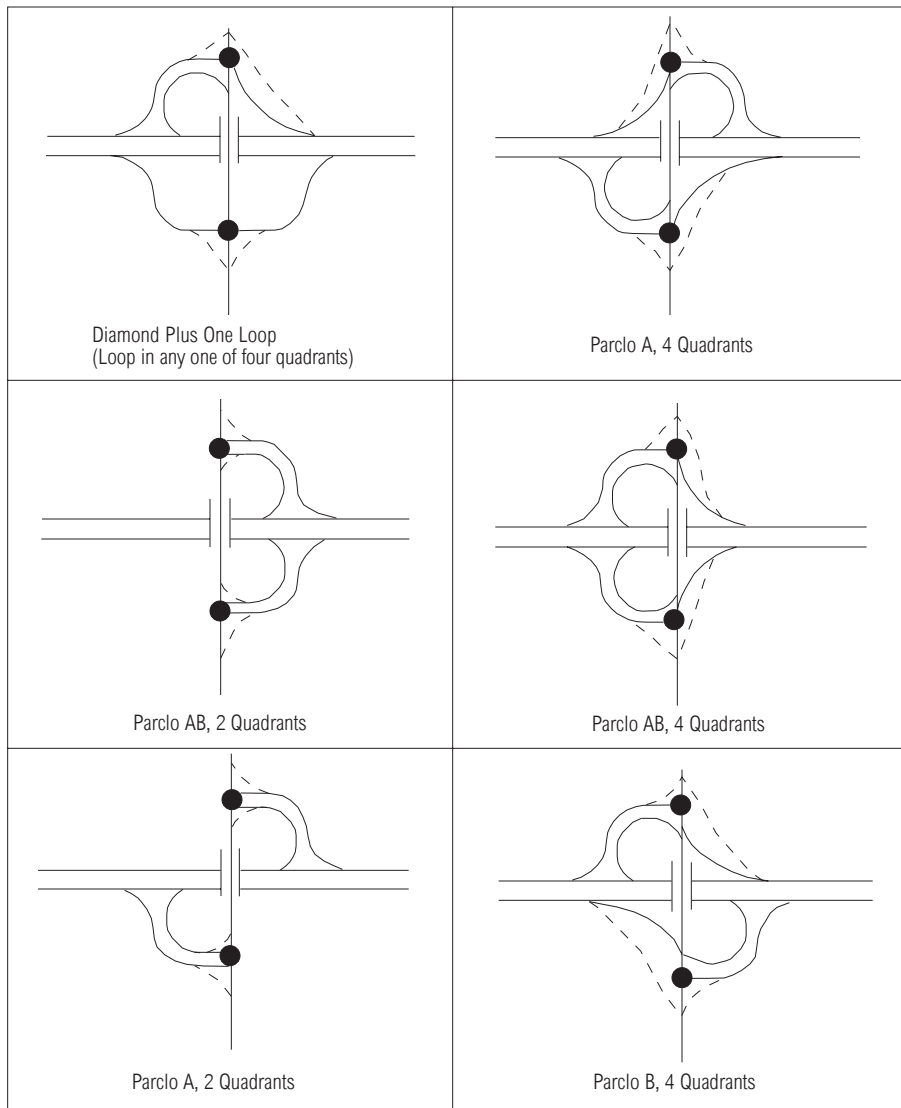

----- Possible configuration of signal bypasses operating as unsignalized movements

Influence of Interchange Type on Turning Movements

The type of interchange has a major influence on turning movements. Movements that involve a right-side merge in one configuration become left turns in another. Movements approaching the interchange on the surface facility are also affected by the interchange type, depending on whether the ramp movements involve left or right turns. Lane-changing and weaving movements also are affected.

Exhibit 26-3 shows the impact of interchange type on turning movements. The eight basic movements between the freeway or major highway and the surface facility are listed. The exhibit indicates whether the movement is a merge (M), diverge (D), or turning (T) movement at the surface facility terminal, and whether the movement involves a right-side (R) or left-side (L) maneuver.

EXHIBIT 26-3. EFFECTS OF INTERCHANGE TYPE ON TURNING MOVEMENTS

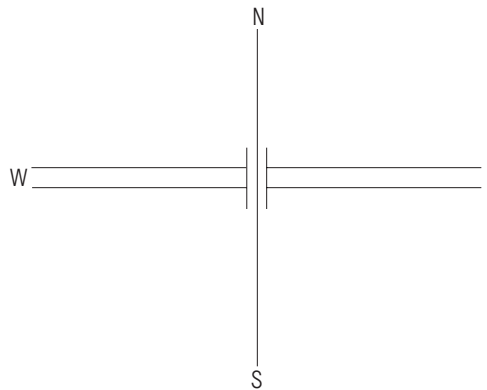

Type of Movement Required for:

Type of Interchange	From Surface Street				From Freeway/Highway			
	S-E	S-W	N-W	N-E	E-N	E-S	W-N	W-S
Diamond	TR ^a	TL	TR ^a	TL	TR ^b	TL	TL	TR ^b
Split Diamond	TR ^a	TL	TR ^a	TL	TR ^b	TL	TL	TR ^b
Parclo A - 4 Quad	DR	DR	DR	DR	TR ^b	TL	TL	TR ^b
Parclo A - 2 Quad	TL	TR ^a	TL	TR ^a	TR ^b	TL	TL	TR ^b
Parclo B - 4 Quad	TR ^a	TL	TR ^a	TL	MR	MR	MR	MR
Parclo B - 2 Quad	TR ^a	TL	TR ^a	TL	TL	TR ^b	TR ^b	TL
Parclo AB - 4 Quad ^c	DR	TL	TR	DR	MR	MR	TL	TR ^b
Parclo AB - 2 Quad ^c	TR ^a	DR	TL	TL	TR ^b	TL	MR	TL

Notes:

Assumes freeway movements are eastbound and westbound. Movement types are with respect to surface street. Merges and diverges may be with or without conflicting flows.

T = turn against conflicting flow R = right-side movement
 M = merge with traffic L = left-side movement

D = diverge from traffic

a. Could be diverge.

b. Could be merge.

c. Movements are correct only if loop ramps are on east side.

In selecting an appropriate type of interchange, the impacts on the turning movements should be considered. Left-turning movements are always the most difficult in terms of efficiency of operation, and high-volume left-turning movements should be avoided, if possible. By selecting a type of interchange that requires left turns only of minor movements, the overall operation can be enhanced considerably. However, it is not always possible to accomplish this. Right-of-way limitations may preclude the use of loop ramps, and economic and environmental constraints may make multilevel structures undesirable. In the final analysis, a diamond configuration may be required even though it generates heavy left-turn volumes.

UNIQUE OPERATIONS AT SIGNALIZED DIAMOND INTERCHANGES

The signalized diamond interchange presents several unique situations for analysis. In effect, the diamond interchange configuration—except for that of the single-point diamond—places two signalized intersections in proximity, with heavier-than-usual left-turning and right-turning movements as vehicles enter and exit the freeway or major highway. The two intersections do not operate in isolation—each affects the other in ways that are unique to the configuration. Some of these effects, however, also may occur at other signalized intersections that are closely spaced and that have a large amount of left-turn movements. Two-quadrant parclo, for example, typically encounter the same types of problems because their three-phase signalization is similar to that of diamond interchanges. These concepts, therefore, also can apply to similar

noninterchange situations in which closely spaced signalized intersections—including closely spaced intersections adjacent to interchange ramp terminals—interact.

Exhibit 26-4 shows a typical signalized diamond interchange. For simplicity, the drawing focuses on one direction of the surface street. Similar impacts occur in the other direction.

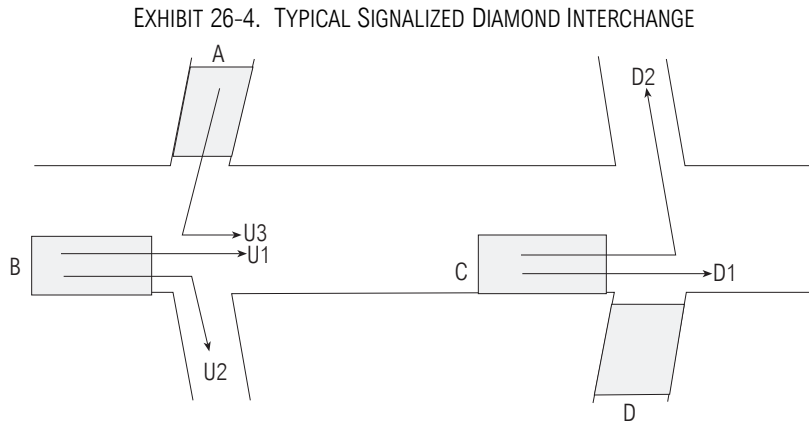

Each of the signalized intersections of the diamond interchange (in the subject direction) consists of two approaches, labeled A and B for the upstream intersection, and C and D for the downstream intersection. The downstream intersection is fed by movements U1 and U3 of the upstream intersection. Exiting freeway traffic forms a stream that is movement U3 at the upstream intersection and part of movement D1 at the downstream intersection. Entering freeway traffic is part of movement U1 at the upstream intersection, and all of movement D2 at the downstream intersection. The interaction of these movements creates special problems at signalized diamond interchanges.

Queuing Characteristics

The most critical features of a signalized diamond interchange, therefore, are the interdependency of movements and the distance between intersections, both of which influence queuing. The distance separating the intersections limits the amount of queuing that can occur downstream without blocking the upstream intersection. The extent of queuing at the downstream intersection depends on several factors, including the timing at the upstream and downstream signals, the number and use of the lanes at both intersections, and the flow rates in the movements (U1 and U3) that feed the downstream intersection.

Queuing from the downstream intersection can have one of the following three impacts on the discharge from the upstream intersection:

1. Conditions at the downstream intersection are not severe enough to affect the upstream intersection.
2. Queuing from the downstream intersection does not completely block the upstream discharge but reduces its rate due to the proximity of the back of the queue.
3. Queuing from the downstream intersection effectively blocks the discharge from the upstream signal during portions of its green period.

Queued vehicles within a short segment (or link) limit the effective length of the link. Vehicles can travel freely only from the upstream stop line to the back of the downstream queue. Because this distance may be small, the impact on upstream discharge rate is significant.

Complicating the situation is that this process is iterative. Downstream queues affect upstream discharges; upstream discharges affect downstream queues by metering the

Impacts from downstream queuing

Internal links

number of vehicles that can enter the short link between the diamond intersections. This complex relationship has not been fully studied and documented; therefore, the material in this chapter is conceptual and is not based on a definitive model for signalized diamond interchange operations.

Lane Change Movements

Because of the turning movements at diamond interchanges, the internal link of the surface street (the link between the two signalized diamond intersections) is subject to abnormally high numbers of lane-changing maneuvers. Exhibit 26-5 depicts this phenomenon.

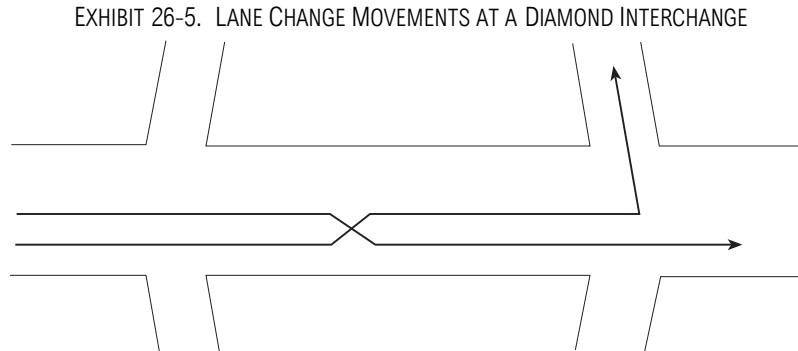

The lane changes occur because of origin-destination patterns. The turbulence of the lane changing can decrease the normal link speed. In addition, if there is queuing on the link, it reduces the effective weaving or lane-changing distance, increasing the turbulence and its potential effects on the traffic. In many cases, drivers try to pre-position themselves in the appropriate upstream lane, and left turns from the surface street can enter a turn bay at the entry point on the internal link. This tends to minimize lane-changing turbulence.

Lane Utilization

Because of the potential for heavy turning flows at signalized diamond interchanges, lane utilization may differ from that at other signalized intersections. At the downstream intersection, heavy left-turning and through flows normally will segregate, and lane-use regulations generally encourage maximum segregation. While this might occur at any signalized intersection with turning flows, the difference is in the impact on the upstream intersection. Because the internal link generally is short, segregation may occur at the upstream intersection by driver selection or by designated signing and striping. Thus, the upstream approach flow can be segregated substantially into two flows, both of which are through flows at the upstream intersection: one will turn left at the downstream intersection, and one will continue through it. This can create lane-use imbalances that exceed those at normal intersections but that must be taken into account by creating separate lane groups for through vehicles at the upstream intersection.

Platoon Behavior

Because of the high volume of turns at a diamond interchange, it is difficult to maintain platoons as vehicles pass through the two intersections. It is also difficult to maintain the signal progression through the interchange. Platooned arrivals at the downstream intersection come from two sources: left turns from an interchange ramp, and through movements from the surface street. The ramp may contribute a higher volume than the surface street and therefore would be the primary candidate for progressed movement. In any case, the two sources arrive from two different signal

phases. No matter what signalization is adopted, one of the movements will be disadvantaged. Some portion of the lesser movement will arrive at the downstream intersection during a red period, and the queued vehicles then will alter the platoon structure that proceeds down the surface link.

Although heavy turning movements from the interchange ramps add vehicles to platoons on the surface link, heavy left-turning movements of vehicles onto the freeway or major highway remove significant numbers of vehicles, creating gaps in the platoons.

Demand Starvation

Demand starvation occurs when portions of the green at the downstream intersection are not used because conditions prevent vehicles at the upstream intersection from reaching the downstream stop line. These conditions at the upstream intersection can include delays or blockage due to queue overflow from another lane group. Demand starvation occurs in one of two ways:

1. Queues from the downstream intersection effectively block departures from the upstream intersection during part or all of the upstream green. This reduces the effective green time for flow at the upstream location during the green time at the downstream intersection.
2. Signal coordination between the two intersections is suboptimal even without downstream queuing. As a result, sometimes the upstream signal is red while unsaturated flow conditions prevail during the green at the downstream signal.

Signal Phasing and Timing Strategies

Because of the unique operational characteristics of signalized diamond interchanges, special signal phase plans and timing often are appropriate. Appendix A covers the signalization of diamond interchanges in greater detail. *Capacity of Interchange Ramp Terminals (I)* describes a range of interchange signalization practices. The key point is that interchange performance is closely linked to signal timing, due to the interdependence of flows, queuing, and timing.

Appendix A provides more information about the signalization of diamond interchanges

II. METHODOLOGY

Because this chapter outlines only a conceptual approach for analyzing signalized diamond interchanges, it does not present a detailed analytic methodology with applications. The conceptual methodology has two primary components:

- A level-of-service (LOS) framework, and
- A framework for estimating saturation flow rates.

LOS FRAMEWORK

The recommended framework for LOS is to treat the diamond interchange as a point rather than as a segment or system, and to focus on the total control delay experienced by drivers as they move through the interchange.

Exhibit 26-6 shows the various movements at the diamond interchange. In the exhibit, movements are labeled as coming from the west intersection (W) or the east intersection (E). An r designation indicates that the movement originates from one of the ramps. The next two letters indicate whether the movement is a left turn (L), a right turn (R), or a through movement (T) first at the upstream intersection and then at the downstream intersection, if both intersections are traversed. For example, the designation WrLT means a left turn from the west intersection ramp proceeding straight through the east intersection.

EXHIBIT 26-6. MOVEMENTS IN A DIAMOND INTERCHANGE

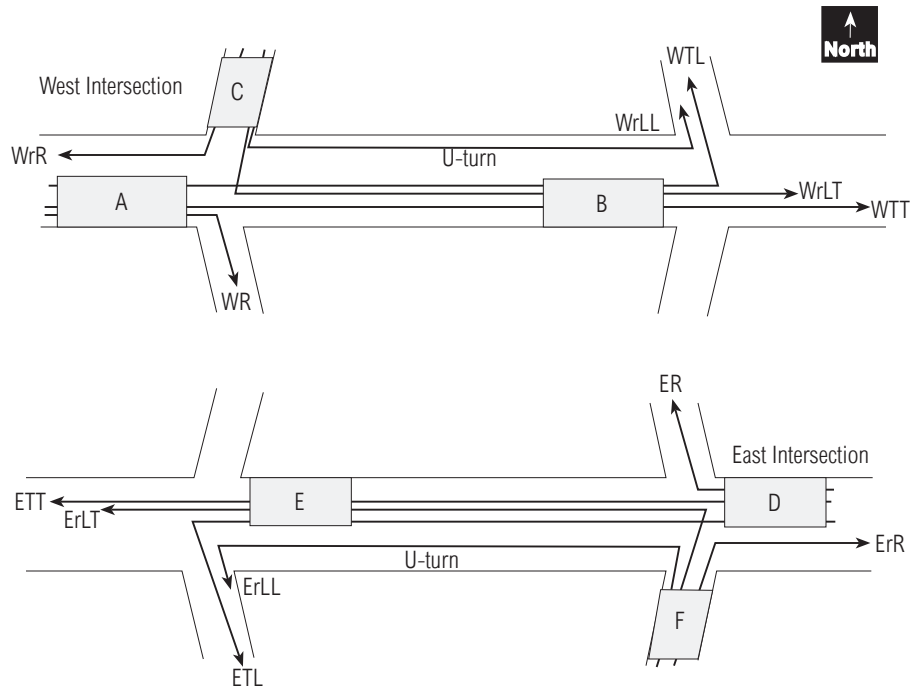

Exhibit 26-7 indicates the components of delay that must be included in the LOS analysis of each movement. Each movement experiences the delay of each lane group it uses while passing through the interchange. Since the diamond interchange is being considered as a point, the recommended LOS framework does not account for the travel time between the two diamond intersections.

EXHIBIT 26-7. COMPONENTS OF INTERCHANGE DELAY

Movement	Control Delay from Lane Groups of Approach ^a
WTL	A and B
WTT	A and B
WR	A only
WrR	C only
WrLT	C and B
WrLL	C and B
ETL	D and E
ETT	D and E
ER	D only
ErR	F only
ErLT	F and E
ErLL	F and E

Note:
 a. See Exhibit 26-6 for approach designations.

The control delay for each of the approach lane groups can be estimated using the signalized and unsignalized intersection methodologies of Chapters 16 and 17, taking into account progressive flows by estimating an appropriate arrival type. Unsignalized yield and free-flow movements are to be included in the analysis, because performance differences between alternate interchange forms can be seen only by considering all ramp terminal movements. For instance, the benefits of free-flow movements may be hidden

unless delays and volumes of all movements are incorporated, as shown in the example in Appendix B.

LOS for the individual groups is then determined from Exhibit 26-8, which uses LOS criteria for signalized intersections described in Chapter 16. If any lane group performs poorly—that is, if it falls in the LOS E or F range—the impact on the rest of the interchange likely will not be identified unless queuing is analyzed in greater detail. If there is severe queuing or upstream blockage, timing or design changes should be considered, regardless of the LOS. In all cases, spillback onto the mainline freeway should be avoided because of the potential for high-speed rear-end accidents. To reduce ramp queuing, the timing may be adjusted so that the surface street approaches, rather than the exit ramp approaches, perform at LOS F.

EXHIBIT 26-8. LOS CRITERIA FOR INTERCHANGES

Level of Service	Delay (s/veh)
A	≤ 10
B	> 10–20
C	> 20–35
D	> 35–55
E	> 55–80
F	> 80

A comprehensive analysis would consider the interaction of flows, queues, and signal timing. The LOS analysis could be based on complete movements through the interchange, as defined in Exhibits 26-6 and 26-7. Such a procedure may be presented in future editions of this manual.

Finally, a combined average control delay per vehicle for the interchange is computed:

$$d_{INT} = \frac{\sum(d_i v_i)_{A-F}}{\sum(v_i)_{A-F}} \quad (26-1)$$

where

- d_{INT} = average control delay per vehicle for the interchange (s/veh),
- d_i = average control delay for Lane Group i on Approaches A–F (s/veh),
- and
- v_i = demand flow rate for Lane Group i (veh/h).

The equation includes the delays and the flow rates from all lane groups in A through F. The computed delay therefore is the weighted average intersection delay of the two ramp terminal intersections. LOS is determined using the criteria in Exhibit 26-8.

SATURATION FLOW RATES FOR INTERCHANGE LANE GROUPS

The estimation of saturation flow rates at signalized intersections within a diamond or other interchange generally follows the procedures of Chapter 16. However, there are necessary modifications for the unique interactions that occur in closely spaced, signalized intersections with high turning volumes. Currently, there are no fully developed and evaluated methodologies for making these modifications, although some have been proposed and are under study.

III. APPLICATIONS

Without a complete methodology, specific applications cannot be discussed or illustrated. However, the methodologies of Chapters 16 and 17 can be applied as a rough approximation, as presented above, and the LOS criteria listed in Exhibit 26-8 then can be used to estimate LOS.

Nonetheless, such an application does not take into account all of the unique operating conditions that affect operations at interchanges. Exhibit 26-9 lists the principal components of the framework for a complete interchange analysis.

EXHIBIT 26-9. FRAMEWORK FOR COMPREHENSIVE INTERCHANGE RAMP TERMINAL ANALYSIS

Inputs
<ul style="list-style-type: none"> • Traffic characteristics, • Geometrics, and • Control characteristics.
Signalized Movement Analysis
<ul style="list-style-type: none"> • Generally follow Chapter 16; • Modify to include <ul style="list-style-type: none"> - Appropriate lane group definition, including pre-positioning, - Blockage by downstream queues, - Proximity to downstream queues (reduced speed), - Traffic pressure and interchange site effects, - Left- and right-turn radius effects, and - Demand starvation, and • Analyze resulting capacity, queuing, delay, and LOS.
Weaving and Merge Movements
<ul style="list-style-type: none"> • Consider operational effects (no procedure defined in HCM) and • Analyze capacity, queuing, delay, and LOS.
Unsignalized Movements
<ul style="list-style-type: none"> • Apply Chapter 17 methodology and • Analyze resulting capacity, queuing, delay, and LOS.
Evaluation
<ul style="list-style-type: none"> • Measure performance (including queuing effects) of approach lane groups and movements through the interchange; • Perform an iterative analysis, to account for queue interactions; • Determine average performance of interchange; • Determine overall LOS of interchange; and • Analyze short interchange area segments comprising three to four closely spaced intersections.

When determining the LOS for diamond interchanges, the analyst should identify several components integral to operational analysis, including, but not limited to

- Interchange geometry, including the number of lanes and storage;
- Lane use and utilization;
- Peak-hour turning volumes; and
- Anticipated signal phasing and cycle lengths.

The first step is to determine the current or projected queuing by lane group and by traffic signal phase. If the queuing between traffic signals is due to the signal phasing and if this is causing backups that cannot be stored, then alternative signal phasing should be identified so that the interchange may operate more efficiently within its geometric limitations. However, the ramifications of this new signal phasing must be explored to determine its impact on the operational efficiency of the interchange.

An example of analyzing phasing would be to determine if the traffic queuing and storage for three-phase operation at a diamond interchange will function without causing queue spillback and additional traffic delays. If three-phase operation causes queue spillback and is inefficient, then changing to four-phase operation may be necessary. Four-phase signal timing basically allows each of the four approaches to the interchange to operate on a separate phase. There are many different ways to achieve four-phase operation, by changing phase order and by sequencing signal overlaps. Three-phase operation allows two directions of travel to move concurrently most of the time, but four-phase operation requires that three phases wait while one is served. Changing from three-phase to four-phase operation at a diamond interchange normally creates a significant adverse impact on delays and LOS.

There are many other phasing sequences and offset relationships to consider. Variations on the basic sequence should stem from the interchange configuration, the ability to store queues, system coordination elements, and the location of queue storage. The selection of leading or lagging (or both) left-turn arrows and overlap phasing may be necessary, as well as choice of protected, permissive, or protected-and-permissive left-turn phasing. Actuated operation is another factor. Appendix A presents signal timing considerations for signalized diamond interchanges; more discussion on this complex topic can be found in other references (1, 2).

IV. EXAMPLE PROBLEMS

Example problems are omitted from this chapter because a complete methodology is not specified. However, Appendix B presents a numerical exercise illustrating the simplified approach described earlier.

V. REFERENCES

- 1 Messer, C. J., and J. A. Bonneson. *Capacity of Interchange Ramp Terminals*. Final Report NCHRP Project 3-47. Texas A&M Research Foundations, College Station, April 1997.
- 2 Akcelik, R. *Interchange Capacity and Performance Model for HCM 2000*. Technical Note, ARRB Transport Research Ltd., Vermont South, Australia, October 1998.

APPENDIX A. TIMING CONSIDERATIONS FOR SIGNALIZED DIAMOND INTERCHANGES

The signalization of two closely spaced intersections with heavy turning movements, as in a signalized diamond interchange, presents several major challenges. Most of these involve the queuing of vehicles between the two intersections on the inside link, affecting operations as described in this chapter. In addition, virtually every signalized diamond interchange involves heavy left-turning movements, necessitating multiphase signalization at both intersections and making progression and platoon cohesion along the surface street difficult to maintain.

PHASING OPTIONS

Signalized diamond interchanges usually employ integrated phasing—that is, they use a single, often semiactuated controller for both intersections. Although there are several subalternates, the basic decision is whether to use a three-phase or a four-phase system. The three-phase system provides a more efficient use of time, but can lead to queuing problems on the inside link. The four-phase system is less efficient in use of time but avoids most queuing problems. Both are illustrated in Exhibit A26-1.

EXHIBIT A26-1. COMMON SIGNALIZATION SCHEMES FOR DIAMOND INTERCHANGES

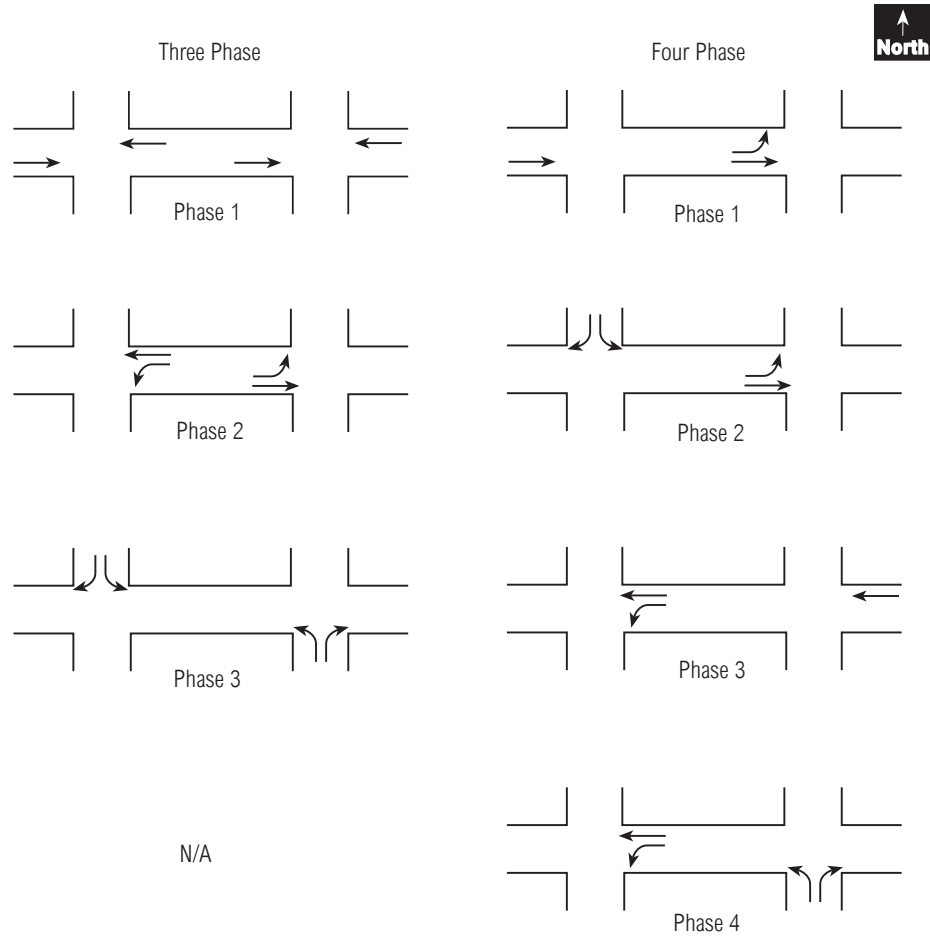

The basic three-phase scheme features a phase for through movements on the surface street, a phase for movements from all inside links, and a phase for ramp movements. As an alternative, Phases 2 and 3 can be switched.

The primary problem occurs in Phase 3. Left-turning vehicles from both ramps are entering the inside link and begin to queue at the downstream signal during the phase, which is now red. If queuing can cause a problem, this scheme should be avoided. The number of vehicles that will accumulate on the inside link can be estimated by taking the effective green time for Phase 3 and applying an estimated discharge rate for left-turning vehicles for each ramp. Given the number of lanes and the length of the inside link, the general impact of queued vehicles (in each direction) can be assessed.

Note that in the three-phase sequence of Exhibit A26-1, Phase 1 follows Phase 3 and introduces another set of vehicles into the inside link. If Phases 2 and 3 are switched, a phase discharging the inside link would follow and should help to reduce the impact of the queues.

If it is clear that queuing on the inside link will be a regularly occurring problem in the three-phase configuration, the four-phase option is a better choice. Each of the four approaches from which interchange traffic originates is given a clear phase through both intersections. Queuing is minimized because vehicles are stopped from entering the inside link at the same time that vehicles are stopped from leaving it. Although it constrains the negative impacts of queuing, a four-phase plan generally decreases the effective green time per cycle (g/C) ratio for major movements, so that expected delays are higher than for a three-phase plan—assuming in both cases that there are no flow breakdowns due to queuing.

Exhibit A26-2 shows a four-phase plan with overlaps that is more efficient than the simple four-phase plan. In Overlap Phases 1 and 4 of this plan, an opposing through vehicle is allowed to enter the inside link during a phase in which it cannot exit the link. The timing of these overlap phases is critical to proper operation and is related to the ideal offset between the two diamond intersections. The initiation of Phase 2 with respect to Phase 1 should be the ideal offset on the inside link in the eastbound direction, while the initiation of Phase 5 with respect to Phase 4 should be the ideal offset on the inside link in the westbound direction.

EXHIBIT A26-2. FOUR-PHASE PLAN WITH OVERLAP

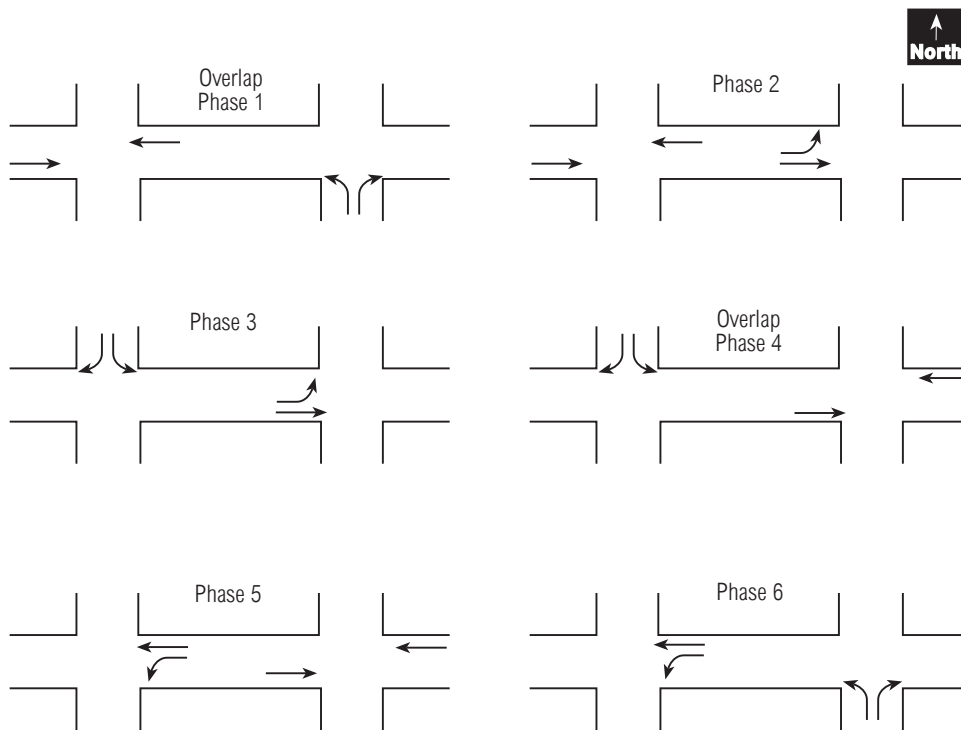

ESTABLISHING OFFSETS

An offset is the difference, in seconds, between the start of green time at the two signalized intersections of a diamond interchange; it is used to coordinate the through traffic passing through the internal link. Both intersections in either the basic three-phase or four-phase signalization are commonly timed from a single controller. The signal phases and overlaps installed in the timing pattern can be established to allow traffic to move through the interchange, reducing the probability of stopping. The two intersections sometimes are timed by separate controllers and linked together; the offsets then should be established to minimize unnecessary stopping.

Optimizing offsets

When the through traffic on the surface street is a dominant feature and the ramp flows are no larger than the normal turning volumes at other intersections, the standard ideal offset may be used; this offset is equal to the travel time from the upstream to the downstream stop line at the average running speed of traffic.

$$\theta_{ij} = \frac{L}{S} \tag{A26-1}$$

where

- θ_{ij} = offset for through movements at Intersections i and j, between the start of the downstream through green and the upstream green (s);
- L = length of the link (i-j) from the upstream stop line to the downstream stop line (m); and
- S = average running speed on the surface street (m/s).

Normally, however, ramp movements are significant enough to create queuing on the inside link. In such cases, the ideal offset should be based on clearing the queue at the downstream intersection:

$$\theta_{ij} = \frac{L}{S} - \frac{(1-P) * v * C}{s} \tag{A26-2}$$

where

- P = proportion of vehicles arriving on green,
- v = arrival flow rate at the downstream intersection (veh/h),
- C = cycle length (s), and
- s = saturation flow rate at the downstream intersection (veh/h).

A third guideline for optimizing offsets is also available (1). This criterion is based on minimizing demand starvation and is related to the maximum storage on the inside link. To minimize demand starvation, the offset should be greater than or equal to the computation produced by Equation A26-3.

$$\theta_{ij} = \frac{L}{S} - \frac{3,600 * N * L}{s * l} \tag{A26-3}$$

where

- N = number of lanes on link i-j, and
- l = queue storage length per vehicle (m).

In general, the selection of an offset must consider many factors, including the flow level, the traffic pattern, and the degree of saturation at the downstream signal. However, to enhance the throughput efficiency during high-volume conditions, the offset should be greater than or equal to the larger value produced by Equations A26-2 and A26-3.

Ideal offsets often can be provided only in a single direction. Once an ideal offset is established in one direction, the offset in the other is often already determined. Although multiphase operation at most interchange signals can provide some flexibility, other signal timing requirements can dictate the opposing offset. In such cases, it is necessary to consider both offsets and to determine a plan that is most effective for the overall operation of the interchange, even though neither offset may be ideal.

APPENDIX B. ASSESSMENT OF ALTERNATIVE INTERCHANGE CONFIGURATIONS

Assessment Three alternative configurations are presented for an interchange. Volumes (veh/h) and control delay (s/veh) are given for each movement. Control delay

and overall LOS are determined to compare the alternatives and to illustrate the effect of including all interchange movements in the calculations.

Alternative 1. Diamond, no free-flow movements or right turn on red (RTOR)

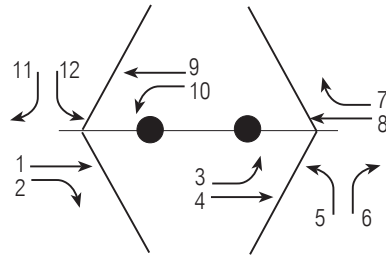

Movement No.	Volume (veh/h)	Delay (s/veh)
1	800	30
2	300	30
3	300	20
4	800	35
5	200	50
6	400	50
7	400	40
8	900	40
9	700	45
10	400	25
11	300	45
12	300	45

Calculations

- Total interchange delay (all 12 movements), 217,500 veh-s;
- Total interchange volume (all 12 movements), 5,800 veh/h; and
- Average interchange control delay = $\frac{217,500}{5,800} = 37.5$ s/veh (LOS D).

Alternative 2. Diamond with free-flow right turns to and from ramps

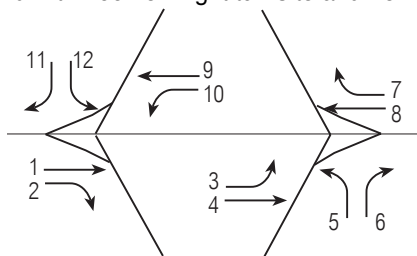

Movement No.	Volume (veh/h)	Delay (s/veh)
1	800	30
2	300	0
3	300	20
4	800	35
5	200	50
6	400	0
7	400	0
8	900	40
9	700	45
10	400	25
11	300	0
12	300	45

Calculations

- Total interchange delay (all 12 movements), 159,000 veh-s;
- Total interchange volume (all 12 movements), 5,800 veh/h;
- Total volume (excluding free-flow movements), 4,400 veh/h;
- Average interchange control delay (all volumes) = $\frac{159,000}{5,800} = 27.4$ s/veh (LOS C),
and
- Average interchange control delay (excluding free-flow volumes) = $\frac{159,000}{4,400} = 36.1$ s/veh (LOS D).

Alternative 3. Two-quadrant Parclo A with free-flow right-turn exit ramps

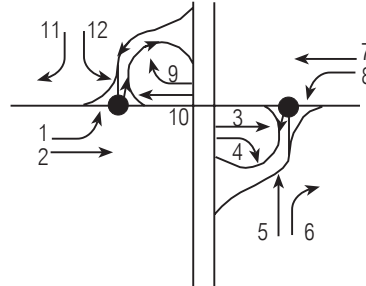

Movement No.	Volume (veh/h)	Delay (s/veh)
1	300	30
2	800	30
3	800	35
4	300	0
5	200	50
6	400	0
7	900	40
8	400	40
9	400	0
10	700	45
11	300	0
12	300	45

Calculations

- Total interchange delay, 168,000 veh-s;
- Total interchange volume, 5,800 veh/h;
- Total volume (excluding free-flow movements), 4,400 veh/h;
- Average interchange control delay (all volumes) = $\frac{168,000}{5,800} = 29.0$ s/veh (LOS C); and
- Average interchange control delay (excluding free-flow volumes) = $\frac{168,000}{4,400} = 38.2$ s/veh (LOS D).

Results The summary of results follows.

Alternative	Delay/LOS	
	Using all Volumes	Excluding Free-Flow Volumes
Diamond, no free-flow movements or RTOR	37.5/D	37.5/D (no change)
Diamond, with free-flow right turns to/from ramps	27.4/C	36.1/D
Two-quadrant Parclo A, with free-flow right-turn exit ramps	29.0/C	38.2/D

Considering all interchange volumes, the last two alternatives, which include free-flow movements, outperform Alternative 1 by one service level. They perform about the same for the given conditions. If free-flow volumes had been excluded, however, the benefits of this design feature would have been masked—the average delay and LOS of all three alternatives would be the same, as shown on the right side of the results summary.

CHAPTER 27

TRANSIT

CONTENTS

I.	INTRODUCTION	27-1
	Relationship to Other Analytical Procedures	27-1
	Limitations of the Methodology	27-2
II.	METHODOLOGY	27-2
	Quality of Service	27-2
	Availability Measures	27-2
	Service Frequency at Transit Stops	27-2
	Urban Scheduled Transit Service	27-3
	Paratransit Service	27-3
	Intercity Scheduled Transit Service	27-4
	Accessibility at Transit Stops	27-4
	Passenger Loads at Transit Stops	27-5
	Route Segment Hours of Service	27-5
	Route Segment Accessibility	27-5
	Comfort and Convenience Measures	27-6
	Passenger Loads at Transit Stops	27-6
	Amenities at Transit Stops	27-6
	Route Segment Reliability	27-7
	Route Segment Travel Speed	27-8
	Parameters of Bus Facilities	27-9
	Dwell Time	27-9
	Peak Passenger Volumes	27-9
	Boarding and Alighting Times	27-9
	Wheelchair Accessibility Adjustment	27-10
	Bicycle Adjustment	27-10
	Coefficient of Variation of Dwell Times	27-11
	Clearance Time	27-11
	Failure Rate	27-11
	Passenger Loads	27-12
	Skip-Stop Operation	27-12
	Determining Loading Area Capacity	27-13
	Determining Bus Stop Capacity	27-13
	Bus Facilities on Freeway HOV Lanes and Busways	27-14
	Exclusive Urban Street Bus Facilities	27-16
	Vehicle Capacity	27-16
	Adjustment for Right Turns	27-17
	Adjustment for Skip-Stop Operation	27-17
	Bus Effects on Adjacent-Lane Capacity	27-19
	Person Capacity	27-20
	Speed	27-20
	Bus Travel Time Rates	27-21
	Adjustment for Skip-Stop Operation	27-22
	Adjustment for Bus-Bus Interference	27-23
	Mixed-Traffic Bus Facilities	27-24
	Bus Lane Types	27-24
	Vehicle and Person Capacity	27-25

Speed	27-26
Sizing Station Areas	27-26
Parameters of Light Rail and Streetcar Facilities	27-26
Dwell Time	27-26
Peak Passenger Volumes	27-27
Number of Doors Available	27-27
Passenger Flow at Controlling Door	27-27
Operating Margins	27-28
Adjustment for Wheelchair Accessibility	27-28
Minimum Headways	27-28
On-Street Operation	27-29
Block Signaling	27-30
Single-Track Sections	27-30
Light Rail and Streetcar Capacity	27-31
Vehicle Capacity	27-31
Person Capacity	27-31
Speed	27-31
III. APPLICATIONS	27-32
Computational Steps	27-33
Planning Applications	27-33
Quality of Service	27-33
IV. EXAMPLE PROBLEMS	27-35
Example Problem 1	27-36
Example Problem 2	27-38
Example Problem 3	27-40
Example Problem 4	27-41
Example Problem 5	27-42
Example Problem 6	27-43
Example Problem 7	27-44
V. REFERENCES	27-45

EXHIBITS

Exhibit 27-1. Service Frequency LOS for Urban Scheduled Transit Service	27-3
Exhibit 27-2. Service Frequency LOS for Paratransit Service	27-4
Exhibit 27-3. Service Frequency LOS for Intercity Scheduled Transit Service	27-4
Exhibit 27-4. Hours-of-Service LOS	27-6
Exhibit 27-5. Passenger Load LOS	27-6
Exhibit 27-6. Typical Transit Stop Amenities	27-7
Exhibit 27-7. Reliability LOS for On-Time Performance	27-8
Exhibit 27-8. Reliability LOS for Headway Adherence	27-8
Exhibit 27-9. Typical Bus Passenger Boarding and Alighting Service Times for Selected Bus Types and Door Configurations	27-10
Exhibit 27-10. Average Bus Reentry Delay into Adjacent Traffic Stream (Random Vehicle Arrivals).....	27-11
Exhibit 27-11. Values of Percent Failure Associated with Z_a	27-12
Exhibit 27-12. Efficiency of Multiple Linear Loading Areas at Bus Stops	27-14
Exhibit 27-13. Typical Busway Line-Haul Passenger Volumes	27-15
Exhibit 27-14. Estimated Average Speeds of Buses Operating in Freeway HOV Lanes	27-15
Exhibit 27-15. Bus Stop Location Factors	27-17
Exhibit 27-16. Typical Values of Adjustment Factor, f_k , for Availability of Adjacent Lanes.....	27-19

Exhibit 27-17. Values of Adjustment Factor, f_k , for Type 2 Bus Lanes with
Alternating Two-Block Skip Stops27-19

Exhibit 27-18. Estimated Base Bus Running Time, $t_{r,0}$27-21

Exhibit 27-19. Estimated Bus Running Time Losses, $t_{r,1}$ 27-21

Exhibit 27-20. Skip-Stop Speed Adjustment Factor, f_s 27-23

Exhibit 27-21. Bus-Bus Interference Factor, f_b 27-23

Exhibit 27-22. Bus Lane Volumes and Speeds27-24

Exhibit 27-23. Rail Transit Average Passenger Flow Times (Single Streams)27-27

Exhibit 27-24. Factors Influencing Transit Capacity and Speed27-34

I. INTRODUCTION

This chapter presents methodologies for calculating the vehicle and person capacities of transit modes that operate on street, namely, buses, streetcars, and light rail. Procedures are presented for bus loading areas, bus stops, busways and freeway high-occupancy-vehicle (HOV) lanes, exclusive arterial street bus lanes, mixed-traffic lanes used by buses, and rail lines. Furthermore, this chapter presents procedures for calculating bus and rail travel speeds and gives guidance on sizing passenger waiting areas at transit stations.

In addition, procedures for calculating transit quality-of-service measures for transit service from the passenger's point of view are presented for transit stops and route segments. Unlike the highway-oriented chapters in the HCM, which address individual roadway facilities and generally present a single service measure for determining level of service (LOS), this chapter addresses all on-street transit facilities and operations and as a result presents four service measures.

This chapter should be used in conjunction with Chapter 14, Transit Concepts, which describes basic concepts and definitions, not repeated in this chapter. Transit capacity and quality-of-service procedures and applications related to multimodal corridor and system analysis are presented in Chapters 29 and 30, "Corridor Analysis" and "Areawide Analysis." Capacity and speed estimation methods for off-street transit modes as well as more detailed information about transit capacity and quality-of-service procedures may be found in the *Transit Capacity and Quality of Service Manual* published by the Transportation Research Board (1).

RELATIONSHIP TO OTHER ANALYTICAL PROCEDURES

Capacity estimation methods and concepts provided in other HCM chapters are required in some of the methods given in this chapter for estimating the capacity of on-street transit operations. Methodologies in Chapters 15, 16, and 17, "Urban Streets," "Signalized Intersections," and "Unsignalized Intersections," in particular, should be reviewed when on-street transit operations are analyzed. Methodology in Chapter 23, "Basic Freeway Segments," is also useful in evaluating busway and HOV-lane capacity.

The effect of transit on roadway operations is addressed in many of the other chapters in Part III of this manual, usually in the form of a passenger vehicle equivalence factor for buses. The method in Chapter 16, "Signalized Intersections," also accounts for the number of buses stopping at an intersection.

Transit passengers are usually also pedestrians, bicyclists, or motorists at one or both ends of their transit trip. Chapters 18, "Pedestrians," and 19, "Bicycles," should be consulted regarding the availability of pedestrian and bicycle facilities and the LOS provided. Methodologies in Chapter 18 can also be used in sizing passenger waiting areas at bus stops and transit stations.

The interactions of automobiles, transit, and other modes and their joint role in moving people as part of a transportation system are addressed in Part IV of this manual, where methods for assessing multimodal facilities, corridors, and larger areas may be found. Finally, comparisons of the capacity, speed, and quality of service offered by on-street transit modes with those offered by off-street modes may be found in the *Transit Capacity and Quality of Service Manual* (1).

The methods presented in this chapter are reflective of North American transit capacity and quality-of-service experience and are not necessarily reflective of conditions in other parts of the world. Experience in Europe and Asia, in particular, indicates that greater maximum person capacities are possible than those presented in this chapter. These greater capacities create greater levels of crowding and a lower quality of service for passenger loads.

For background and concepts, see Chapter 14

For guidelines on multimodal analyses of a system, see Part IV

LIMITATIONS OF THE METHODOLOGY

This chapter presents methodologies for bus and light rail operations within the limits of highway rights-of-way and for off-street operations only to the extent that off-street capacity constrains on-street capacity. It does not address transit operations that have their own exclusive dedicated facilities. The chapter also does not provide procedures for the analysis of oversaturated conditions.

II. METHODOLOGY

The methodology in this chapter is for the analysis of capacities of transit modes like buses, streetcars, and light rail in on-street operation.

QUALITY OF SERVICE

This section presents transit quality-of-service measures for transit availability and comfort and convenience of transit stops and route segments, as well as other performance measures that analysts may want to consider for specific applications. These measures are presented to give all users of the HCM an understanding of the overall magnitude of and interrelationships within transit quality of service (*I*).

The four service measures related to transit facilities (transit stops and route segments) per the transit quality-of-service framework presented in Chapter 14 are service frequency, hours of service, passenger loads, and reliability. Two other performance measures relating to transit systems, service coverage, and transit or automobile travel time and their application to corridor and areawide analysis are discussed in Chapters 29 and 30 of this manual.

Each quality-of-service measure has been divided into six LOS, each representing a range of values defined by the characteristics of a particular service measure. Where appropriate, descriptions of the changes in conditions that occur at LOS thresholds are provided with each service measure.

Availability Measures

Transit service availability can be used as a measure of quality of service. Availability measures for transit stops and route segments are described in the following sections.

Service Frequency at Transit Stops

From the transit user's perspective, transit service frequency determines the number of times an hour a user has access to the transit mode, assuming that transit service is provided within acceptable walking distance (measured by service coverage) and at the times the user wishes to travel (measured by hours of service). Service frequency also is a measure of the convenience of transit service to choice riders and is one component of overall transit trip time (helping to determine how long one waits for a transit vehicle).

Because of the different characteristics of urban scheduled transit service, paratransit service, and intercity scheduled transit service, these characteristics are used to define the LOS for each. Frequency LOS can vary by time of day or week: for example, a service may operate at LOS B during peak hours, LOS D at midday, and LOS F at night. Similarly, paratransit service may operate at LOS D on weekdays but at LOS F on weekends if no service is offered.

Urban Scheduled Transit Service

Urban scheduled transit service includes all scheduled service within a city as well as service between cities within a larger metropolitan area. Deviated-route bus service is included in this category because the basic service is scheduled, even if specific stops are not. For the purpose of determining service frequency LOS, commuter rail is treated as intercity service.

The service frequency LOS measure for urban scheduled transit service is headway; however, for convenience, Exhibit 27-1 shows LOS both by headway and by the corresponding number of vehicles per hour. It should be emphasized that although headways are given as continuous ranges for the purposes of determining LOS, passengers find it easier to understand schedules when clock headways are used (headways that are evenly divisible into 60). When clock headways are used, transit vehicles arrive at the same times each hour. The threshold between LOS E and F is service once an hour; this service corresponds to the typical analysis period and to the minimum service frequency applied when hours-of-service LOS is determined.

EXHIBIT 27-1. SERVICE FREQUENCY LOS FOR URBAN SCHEDULED TRANSIT SERVICE

LOS	Headway (min)	Veh/h	Comments
A	< 10	> 6	Passengers don't need schedules
B	≥ 10–14	5–6	Frequent service; passengers consult schedules
C	> 14–20	3–4	Maximum desirable time to wait if bus/train missed
D	> 20–30	2	Service unattractive to choice riders
E	> 30–60	1	Service available during hour
F	> 60	< 1	Service unattractive to all riders

Service frequency LOS is determined by destination from a given transit stop, since several routes may serve a given stop but not all may serve a particular destination. Some judgment must be applied for bus stops located near timed transfer centers. There is a considerable difference in service from a passenger's perspective between a bus that arrives every 10 min and three buses that arrive in sequence from a nearby transfer center every 30 min, even though both scenarios result in six buses per hour serving the stop. In general, buses on separate routes serving the same destination that arrive at a stop within 3 min of each other should be counted as one bus for the purposes of determining service frequency LOS. Exhibit 27-1 gives LOS ranges for scheduled service.

Paratransit Service

Paratransit includes all unscheduled transit service obtained by notifying the service provider that a pickup is desired. However, as noted above, deviated fixed-route service, which is scheduled, is evaluated using the urban scheduled transit service procedures.

The measure of service frequency for paratransit service is access time, the minimum amount of time from when a passenger requests service to the time a pickup can be guaranteed to occur. Standing reservations, where a passenger is picked up every day at a given time unless the service provider is notified otherwise, are convenient for the passenger and potentially require less work on the part of the service provider; however, random reservations are assumed in calculating access time. Exhibit 27-2 summarizes LOS thresholds for service frequency of paratransit service. The threshold between LOS E and F is one day's advance notice for obtaining a ride. At a higher LOS, service can be provided the day it is requested.

Urban scheduled transit service includes deviated fixed-route bus service

Headway determines service frequency LOS for urban scheduled transit service

Service frequency LOS is measured by access time for paratransit operation

EXHIBIT 27-2. SERVICE FREQUENCY LOS FOR PARATRANSIT SERVICE

LOS	Access Time (h)	Comments
A	0.0–0.5	Fairly prompt response
B	> 0.5–1.0	Acceptable response
C	> 1.0–2.0	Tolerable response
D	> 2.0–4.0	Poor response, may require advance planning
E	> 4.0–24.0	Requires advance planning
F	> 24.0	Service not offered every weekday or at all

Intercity Scheduled Transit Service

Intercity transportation services help fill the mobility needs of smaller communities

Transportation services between communities can be just as important as services within communities, especially for rural areas where medical, educational, and other services may not be readily available. Intercity transportation services, whether bus, train, or ferry, help to fill these mobility needs by linking smaller communities to larger communities and to other transportation modes.

The number of transit vehicles per day between one community and another establishes the LOS for intercity service. Exhibit 27-3 summarizes LOS thresholds for service frequency of intercity scheduled transit service. The threshold between LOS E and F is a minimum of two round trips per day, allowing a return to one's origin the same day with sufficient time in the destination city for the trip to be useful. With just one round trip a day, a transit vehicle would likely return to its origin soon after arriving, not allowing time for a passenger to do anything useful in the destination community and still return home that day.

EXHIBIT 27-3. SERVICE FREQUENCY LOS FOR INTERCITY SCHEDULED TRANSIT SERVICE

LOS	Veh/Day	Comments
A	> 15	Numerous trips throughout the day
B	12–15	Midday and frequent peak-hour service
C	8–11	Midday or frequent peak-hour service
D	4–7	Minimum service to provide choice of travel times
E	2–3	Round trip in one day is possible
F	0–1	Round trip in one day is not possible ^a

Note:

a. Technically, a round trip might be possible, but the transit vehicle would likely return to its origin soon after arriving at its destination, not allowing any time for errands.

Accessibility at Transit Stops

Pedestrian, bicycle, automobile, and ADA (Americans with Disabilities Act of 1990) accessibility to transit stops is difficult to quantify. An evaluation of pedestrian accessibility should consider whether sidewalks are provided, the condition of the sidewalks, terrain, traffic volumes on streets that pedestrians must cross to access a transit stop and the kind of traffic control provided on those streets, and whether out-of-direction travel is required. Sidewalks are usually needed on arterial or collector routes used by buses, especially at the bus stop. Sidewalks are less critical on low-volume local streets with bus service. One possible measure could be pedestrian travel time to a stop from a certain point, with different walking times assigned to different walking environments and with delays involved in waiting for a Walk indication at signalized intersections and waiting for a sufficiently large gap in traffic in order to cross a street at an unsignalized intersection accounted for. *The Manual on Uniform Traffic Control Devices (2)* and the

ITE *Manual of Transportation Engineering Studies* (3) provide guidance on pedestrian travel speeds and assessing gaps in traffic.

Research has provided a method for assessing the ADA accessibility of bus stops and the routes leading to bus stops (4). (Since the ADA regulations may change in the future, this method should be used for guidance in developing accessible routes for bus stops, but the current version of the regulations should be relied on for determining legal compliance with ADA.)

Assessment of bicycle access should consider the availability and condition of bicycle facilities on the roadways leading to a transit stop, traffic volumes on the roadways leading to transit stops, the provision of bicycle racks on buses and whether demand exceeds rack capacity, the provision of bicycle storage lockers at high-volume boarding locations, and the ability to load bicycles onto rail vehicles during peak periods.

Assessment of automobile access should consider the capacity of park-and-ride or transit station parking lots relative to demand and the pedestrian environment within parking lots and between lots and the transit stop. For transit systems that use a zone-based fare system, consideration should be given to the parking requirements of transit stops located near a zone boundary where a drop in fare occurs.

Passenger Loads at Transit Stops

Although passenger loads are generally more of a comfort and convenience factor than a transit availability factor, when a transit vehicle is full as it arrives at a stop, passengers waiting at the stop are unable to board and transit service is not available to those passengers at that time. Transit vehicle scheduling should provide sufficient frequency along routes to accommodate peak passenger demand volumes and avoid passing up waiting passengers. Special consideration should be given to providing sufficient transit vehicles to locations with strong peaking characteristics (such as airports, sports stadiums, or concert venues), when many people will want to board transit vehicles at the same time. Unusual weather conditions, such as snow and ice in some areas, can cause people who normally drive to use transit instead, resulting in overcrowded conditions.

Route Segment Hours of Service

Hours of service, also known as service span, is simply the number of hours during the day when transit service is provided along a route, a segment of a route, or between two locations. It plays as important a role as frequency and service coverage in determining the availability of transit service to potential users.

Exhibit 27-4 summarizes hours-of-service LOS thresholds for a transit route. Hours-of-service LOS is measured similarly for fixed-route and paratransit services. For fixed-route service, LOS is based on the number of hours per day when transit service is provided at least once an hour (corresponding to a minimum LOS E for service frequency and compatible with a typical 1-h analysis period). For paratransit service, LOS is based on the number of hours per day when service is offered. As with frequency, hours-of-service LOS can vary by day. Hours-of-service LOS is intended only for transit service provided within cities; intercity service should use only the frequency LOS measure, which is based on the number of trips provided per day.

Route Segment Accessibility

The same accessibility considerations that apply to transit stops also apply to route segments. A potential measure of pedestrian, bicycle, and ADA accessibility for a route segment could include the percentage of transit stops along the segment that meet certain accessibility criteria. Assessment of automobile access should also consider the frequency of park-and-ride lots along a route, to minimize the number of vehicle-kilometers traveled on the area's roadway system by motorists traveling to transit.

ADA accessibility to transit

Bicycle accessibility

Automobile accessibility

Passenger loads can be a transit availability concern when too few vehicles are scheduled or at locations with strong passenger peaking characteristics

EXHIBIT 27-4. HOURS-OF-SERVICE LOS

LOS	Hours per Day	Comments
A	> 18–24	Night or owl service provided
B	> 16–18	Late evening service provided
C	> 13–16	Early evening service provided
D	> 11–13	Daytime service provided
E	> 3–11	Peak-hour service/limited midday service
F	0–3	Very limited or no service

Notes:

Fixed route: number of hours per day when service is provided at least once an hour.

Paratransit: number of hours per day when service is offered.

Comfort and Convenience Measures

Comfort and convenience measures of transit service quality are described in the following sections.

Passenger Loads at Transit Stops

From the passenger’s perspective, passenger loads reflect the comfort level of the on-board vehicle portion of a transit trip both in terms of being able to find a seat and in terms of overall crowding levels within the vehicle. From a transit operator’s perspective, a poor LOS may indicate the need to increase service frequency or vehicle size in order to reduce crowding and to provide a more comfortable ride for passengers. A poor passenger load LOS indicates that dwell times will be longer for a given passenger boarding and alighting demand at a transit stop and, as a result, travel times and service reliability will be negatively affected.

Passenger load LOS for bus and rail uses the same measure—square meters per passenger—but the ranges used to determine the LOS differ between the two modes because of differences in the level of crowding that passengers will tolerate and because most rail modes (with the notable exception of commuter rail) provide more standing area than do buses. Passenger load LOS can be measured by time of day (e.g., LOS D peak, LOS B off peak) or by the amount of time a certain condition occurs (e.g., some passengers must stand for up to 10 min).

The *Transit Capacity and Quality of Service Manual (1)* can be used to estimate the passenger area provided within different kinds of transit vehicles. Alternatively, the load factors (passengers per seat) shown in Exhibit 27-5 can be used to estimate LOS.

EXHIBIT 27-5. PASSENGER LOAD LOS

LOS	Bus		Rail		Comments
	m ² /p	p/seat ^a	m ² /p	p/seat ^a	
A	> 1.20	0.00–0.50	> 1.85	0.00–0.50	No passenger need sit next to another
B	0.80–1.20	0.51–0.75	1.30–1.85	0.51–0.75	Passengers can choose where to sit
C	0.60–0.79	0.76–1.00	0.95–1.29	0.76–1.00	All passengers can sit
D	0.50–0.59	1.01–1.25	0.50–0.94	1.01–2.00	Comfortable loading for standees
E	0.40–0.49	1.26–1.50	0.30–0.49	2.01–3.00	Maximum schedule load
F	< 0.40	> 1.50	< 0.30	> 3.00	Crush loads

Note:

a. Approximate values for comparison. LOS is based on area per passenger.

Amenities at Transit Stops

The amenities provided at transit stops are usually a matter of agency policy, based on the number of boarding riders that would benefit from a particular amenity as well as

Passenger loads are measured as space per person

other factors. Exhibit 27-6 lists typical amenities, daily boarding volumes, and other factors to consider.

EXHIBIT 27-6. TYPICAL TRANSIT STOP AMENITIES

Amenity	Typical Daily Boarding Volumes at Stop	Other Factors to Consider
Shelter	10 (rural) 25 (suburban) 50–100 (urban)	Number of transfers at a stop Available space to place shelter ADA requirements Availability of alternative shelter Average passenger waiting time
Bench	Somewhat lower than shelter thresholds	Insufficient space for shelter Walls, stairs, etc., that attract passengers onto adjacent property Stops used by elderly/disabled
Landing pad	--	Wheelchair deployments at stop Muddy waiting areas Waiting areas damaging adjacent property
Information signs	100	Major trip generators and transfer points Number of routes using a stop Room to install display
Trash receptacles	--	Evidence of litter problem at a stop Availability of sponsor for maintenance Room to install adjacent to the bus stop

Source: References 5–7.

Route Segment Reliability

Several different measures of reliability are used by transit systems. The most common of these are

- On-time performance,
- Headway adherence (the consistency or evenness of the interval between transit vehicles),
- Missed trips, and
- Distance traveled between mechanical breakdowns.

On-time performance is the most widely used measure in the transit industry. It is a measure to which users can relate and encompasses several of the factors listed earlier that influence transit reliability. However, when vehicles run at frequent intervals, headway adherence becomes important to passengers, especially when vehicles arrive in bunches, causing overcrowding on the lead vehicle and longer waits than expected.

Most transit systems define a fixed-route transit vehicle as late when it is more than 5 min behind schedule (8, 9). Some systems consider transit vehicles to be on time when they depart 1 to 3 min early, but the majority of systems consider an early departure as not being on time. From the perspective of a passenger waiting for a transit vehicle, an early departure is often equivalent to a vehicle's being late by the amount of one headway. Reliability LOS considers on-time performance for fixed-route service as a departure from a published time point 0 to 5 min after the scheduled time or an arrival at the end of the route no more than 5 min after the scheduled time. Early departures are not considered on time.

In the case of deviated fixed-route service, in which a bus travels to the rider rather than the riders traveling to meet a bus, early arrivals and departures are not as critical. Also, maintaining a consistent schedule from day to day is more difficult. Therefore, reliability LOS considers on-time performance for deviated fixed-route service as a pickup within 10 min of the scheduled time. The only paratransit on-time performance

Headway adherence is important for frequent service, since bunched vehicles lead to overcrowding and longer waits than expected

measure identified in the literature (8) defines a pickup within 20 min of the scheduled time as on time, and this is the criterion used for the reliability LOS for paratransit service.

Exhibit 27-7 lists reliability LOS grades for transit service operating with frequencies of fewer than six buses/h scheduled. The LOS thresholds are based on the systemwide on-time performance reported by 83 transit properties (8).

EXHIBIT 27-7. RELIABILITY LOS FOR ON-TIME PERFORMANCE

LOS	On-Time Percentage	Comments ^a
A	97.5–100.0	1 late bus per month
B	95.0–97.4	2 late buses per month
C	90.0–94.9	1 late bus per week
D	85.0–89.9	
E	80.0–84.9	1 late bus per direction per week
F	< 80.0	

Notes:

Applies to routes with frequencies of fewer than 6 buses/h scheduled.

a. User perspective, based on 5 round trips/week of their travel on a particular transit route with no transfers.

On-time = 0-5 min late departing published time point (fixed route)

arrival within 10 min of scheduled pickup time (deviated fixed route)

arrival within 20 min of scheduled pickup time (paratransit)

For transit service operating at frequencies of six buses/h scheduled or more, headway adherence is used to determine reliability. The measure is based on the coefficient of variation of headways of transit vehicles serving a particular route arriving at a stop, c_v , which is calculated by Equation 27-1.

$$c_v = \frac{\text{standard deviation of headways}}{\text{scheduled headway}} \quad (27-1)$$

Exhibit 27-8 summarizes headway adherence LOS thresholds by coefficient of variation.

EXHIBIT 27-8. RELIABILITY LOS FOR HEADWAY ADHERENCE

LOS	Coefficient of Variation
A	0.00–0.10
B	0.11–0.20
C	0.21–0.30
D	0.31–0.40
E	0.41–0.50
F	> 0.50

Note:

Applies to routes with frequencies greater than or equal to 6 buses/h scheduled.

Route Segment Travel Speed

Travel speed is a useful route segment performance measure because it reflects how long a trip may take without depending on how long a route segment might be. Transit priority measures, improvements to fare collection procedures, use of low-floor buses, and other similar actions implemented along a route segment will be reflected as improvements in travel speed. The methods presented later in this chapter can be used to estimate transit travel speeds along a route segment. Research has provided suggested LOS ranges based on bus speeds for buses operating on arterial bus lanes (10).

Travel speed is a measure useful for analyzing systems

PARAMETERS OF BUS FACILITIES

Regardless of the kind of bus facility—loading area, bus stop, or bus lane—being analyzed, there are some fundamental components common to each that are required to calculate the facility's vehicle and person capacity. Dwell time is the most important of these, but all have some effect on capacity. This section presents procedures for calculating each of these components.

Dwell Time

Dwell time is the amount of time a bus spends while stopped to serve passengers. When buses operate in mixed traffic and stop in a travel lane, the reduction in the roadway capacity is directly related to the amount of time the buses stop. It is the time required to serve passengers at the busiest door plus the time required to open and close the doors. A value of 2 to 5 s for door opening and closing is reasonable for normal operations.

Dwell time, t_d , can be measured in the field. Field measurement of dwell time is best suited for determining the capacity and LOS of an existing transit line. In the absence of other information, dwell time can be assumed to be 60 s for central business district (CBD), transit center, major on-line transfer point, or major park-and-ride stops; 30 s for major outlying stops; and 15 s for typical outlying stops (11).

Equation 27-2 can be used to compute dwell time.

$$t_d = P_a t_a + P_b t_b + t_{oc} \quad (27-2)$$

where

- t_d = dwell time (s),
- P_a = alighting passengers per bus through busiest door during peak 15 min (p),
- t_a = passenger alighting time (s/p),
- P_b = boarding passengers per bus through busiest door during peak 15 min (p),
- t_b = passenger boarding time (s/p), and
- t_{oc} = door opening and closing time (s).

Peak Passenger Volumes

Estimates of hourly passenger volume are required for the highest-volume stops. The peak-hour factor is used to adjust hourly passenger volumes to reflect 15-min conditions (see Equations 27-3 and 27-4).

$$PHF = \frac{P}{4P_{15}} \quad (27-3)$$

$$P_{15} = \frac{P}{4(PHF)} \quad (27-4)$$

where

- PHF = peak-hour factor,
- P = passenger volume during peak hour (p), and
- P_{15} = passenger volume during peak 15 min (p).

If buses operate at frequencies longer than four buses/h scheduled, the denominator of Equations 27-3 and 27-4 should be adjusted accordingly. Typical PHFs range from 0.60 to 0.95 for transit service (12, 13), with a value close to 1.0 indicating possible underservice of the route.

Boarding and Alighting Times

Boarding and alighting times for base conditions are determined using the values in Exhibit 27-9. Note that if standees are present, 0.5 s should be added to the boarding

times shown. For certain special conditions, the base values are multiplied by 1.2 (12), 0.6 (14,15), and 0.9 (16) for heavy two-way flow through a single door or double-stream door and for a low-floor bus, respectively.

EXHIBIT 27-9. TYPICAL BUS PASSENGER BOARDING AND ALIGHTING SERVICE TIMES FOR SELECTED BUS TYPES AND DOOR CONFIGURATIONS

Bus Type	Available Doors or Channels		Typical Boarding Service Times ^a (s/p)		Typical Alighting Service Times (s/p)
	Number	Location	Prepayment ^b	Single Coin Fare	
Conventional (rigid body)	1	Front	2.0	2.6 to 3.0	1.7 to 2.0
	1	Rear	2.0	NA	1.7 to 2.0
	2	Front	1.2	1.8 to 2.0	1.0 to 1.2
	2	Rear	1.2	NA	1.0 to 1.2
	2	Front, rear ^c	1.2	NA	0.9
	4	Front, rear ^d	0.7	NA	0.6
Articulated	3	Front, rear, center	0.9 ^d	NA	0.8
	2	Rear	1.2 ^e	NA	-----
	2	Front, center ^c	-----	-----	0.6
Special single unit	6	Front, rear, center ^c	0.5	NA	0.4
	6	3 double doors ^f	0.5	NA	0.4

Notes:

NA: data not available.

a. Typical interval in seconds between successive boarding and alighting passengers. Does not allow for clearance times between successive buses or dead time at stop. If standees are present, 0.5 s should be added to the boarding times.

b. Also applies to pay-on-leave or free transfer situation.

c. One each.

d. Less use of separated doors for simultaneous loading and unloading.

e. Double-door rear loading with single exits, typical European design. Provides one-way flow within vehicle, reducing internal congestion. Desirable for line-haul, especially if two-person operation is feasible. May not be best configuration for busway operation.

f. Examples: Denver 16th Street Mall shuttle; airport buses used to shuttle passengers to planes. Typically low-floor buses with few seats serving short, high-volume passenger trips.

Source: Cuntill and Watts (17).

Wheelchair Accessibility Adjustment

All new transit buses in the United States are equipped with wheelchair lifts or ramps. When a lift is in use, the door is blocked from use by other passengers. Typical wheelchair lift cycle times are 60 to 200 s, and the ramps used in low-floor buses reduce the cycle times to 30 to 60 s (including the time required to secure the wheelchair inside the bus). The higher cycle times relate to a minority of inexperienced or severely disadvantaged users. When wheelchair users regularly use a bus stop to board or alight, the wheelchair lift time should be added to the dwell time.

Bicycle Adjustment

Some transit systems provide folding bicycle racks on buses. When no bicycles are loaded, the racks typically fold upright against the front of the bus. (Some systems also use rear-mounted racks, and a very few allow bikes on board on certain long-distance routes.) When bicycles are loaded, passengers deploy the bicycle rack and load their bicycles into one of the available loading positions (typically two are provided). The process takes approximately 20 to 30 s. When bicycle rack usage at a stop is frequent enough to warrant special treatment, the dwell time of a bus is determined using the greater of the passenger boarding and alighting time or the bicycle loading and unloading time.

Coefficient of Variation of Dwell Times

The effect of variability in bus dwell times is reflected by the coefficient of variation of dwell times, which is the standard deviation of dwell time observations divided by the mean. On the basis of reported field observations of bus dwell times in several U.S. cities, the coefficient of variation of dwell times typically ranges from 40 to 80 percent, with 60 percent suggested as an appropriate value in the absence of field data (10).

The coefficient of variation of dwell times is the standard deviation of dwell times divided by the mean dwell time

Clearance Time

Clearance time includes two components, the time for a bus to start up and travel its own length while exiting a bus stop and (for off-line stops only) the reentry delay associated with the wait for a sufficient gap in traffic to allow a bus to pull back into the travel lane. Various studies have looked at these factors, either singly or together. Research has found that bus start-up times range from 2 to 5 s (5). The time for a bus to travel its own length after stopping is approximately 5 to 10 s, depending on acceleration and traffic conditions. Other research recommends a range of 10 to 15 s for clearance time (10).

Clearance time defined

Start-up and exiting time may be assumed to be 10 s. Reentry delay can be measured in the field or, at locations where buses reenter a traffic stream, may be estimated from Exhibit 27-10 on the basis of traffic volumes in the adjacent travel lane. If buses must wait for a queue from a signal or for traffic to clear before they can reenter the street or if traffic arrives randomly, values from Exhibit 27-10 should not be used; instead, reentry delay should be estimated using the average queue length (in vehicles), the saturation flow rate, and the start-up lost time (see Chapter 16).

EXHIBIT 27-10. AVERAGE BUS REENTRY DELAY INTO ADJACENT TRAFFIC STREAM (RANDOM VEHICLE ARRIVALS)

Adjacent-Lane Mixed-Traffic Volume (veh/h)	Average Reentry Delay (s)
100	0
200	1
300	2
400	3
500	4
600	5
700	7
800	9
900	11
1000	14

Exhibit 27-10 applies only to off-line stops and only where buses must yield to other traffic when they reenter a street, traffic arrives randomly, and the stop is located away from the influence of a queue

Some states have passed laws requiring that other traffic yield to transit vehicles that are signaling to exit a stop. In these locations, the reentry delay can be reduced or even eliminated, depending on how well motorists comply with the law. Transit priority measures, such as queue jumps at signals, can also eliminate reentry delay.

Reentry delay can be reduced or eliminated by using on-line stops, queue jumps at signals, or laws requiring traffic to yield to buses

Failure Rate

The probability that a queue of buses will not form behind a bus stop, or failure rate, can be derived from basic statistics. Z_a represents the area under one tail of the normal curve beyond the acceptable levels of probability that a queue will form at a bus stop. Typical values of Z_a for various failure rates are listed in Exhibit 27-11. A design failure rate should be chosen for use in calculating a loading area capacity. Higher design failure rates increase bus stop capacity at the expense of schedule reliability. Capacity occurs under normal conditions at a 25 percent failure rate (18,19).

One-tail normal variate, Z_a

EXHIBIT 27-11. VALUES OF PERCENT FAILURE ASSOCIATED WITH Z_a

Failure Rate (%)	Z_a
1.0	2.330
2.5	1.960
5.0	1.645
7.5	1.440
10.0	1.280
15.0	1.040
20.0	0.840
25.0	0.675
30.0	0.525
50.0	0.000

Suggested values of Z_a are the following (12):

- CBD stops: Z_a values of 1.440 down to 1.040 should be used. They result in probabilities of 7.5 to 15 percent, respectively, that queues will develop.
- Outlying stops: A Z_a value of 1.960 should be provided wherever possible, especially when buses must pull into stops from the travel lane. This value results in queues beyond bus stops only 2.5 percent of the time. Z_a values down to 1.440 are acceptable, however.

Passenger Loads

Load factor defined

Passenger loads are the number of passengers in a single transit vehicle. The occupancy of the vehicle is typically related to the number of seats, expressed as a load factor. A factor of 1.0 means that all of the seats are occupied. The importance of vehicle loading varies by the type of transit service. In general, bus transit provides a load factor at or below 1.0 for long-distance commute trips and high-speed, mixed-traffic operations. Inner-city service can approach a load factor of 1.5 to 2.0.

Maximum schedule loads defined

Maximum schedule load is synonymous with capacity, assuming a reasonable number of standees. It represents the upper limit for scheduling purposes. Maximum scheduled loads are typically 125 to 150 percent of seating capacity (e.g., 54 to 64 passengers on a typical 14-m bus).

Crush loads defined

Crush loads, typically loads above 150 percent of seating capacity, subject standees and other passengers to unreasonable discomfort. Such loads are unacceptable to passengers. Crush loads prevent circulation of passengers at intermediate stops, induce delay, and reduce vehicle capacity. Although crush loading represents the theoretically offered capacity, it cannot be sustained on every bus for any given period, and it exceeds the maximum utilized capacity. Therefore, crush loads should not be used for transit capacity calculations. Note, however, that when maximum schedule loads are used, some buses will experience crush loading because of the peaking characteristics of passenger demand.

Minimum passenger space requirements

Design guidelines for seats and passenger areas in transit vehicles are based on human factors. For buses, comfortable loading for design should provide at least 0.50 m²/passenger and maximum schedule loads should provide a minimum of 0.40 m²/p where relatively short trips allow standees (20). High-speed express bus service should not allow standees, and scheduling should be guided by the number of seats provided.

Skip-Stop Operation

Capacity adjustment for availability of adjacent lane

When buses stop at every curbside bus stop in an on-line loading area arrangement, use of the adjacent lane becomes necessary only to pass obstructions in the curb lane. The ability to spread out stops, alternating route stop patterns along an urban street, can substantially improve bus speeds and capacities.

Many large transit systems have instituted two- or three-block stop patterns for bus stops along urban streets. This block-skipping pattern allows for a faster trip through the section and reduces the number of buses stopping at each bus stop.

These alternating block stopping patterns enable the bus lane capacity to nearly equal the sum of the capacities of the stops involved. Thus, an urban street with an alternating two-block stopping pattern would ideally have a capacity equal to the sum of the two stops, assuming unimpeded use of the adjacent lane. In reality, this capacity may not always be achievable because of the irregularity of bus arrivals and traffic signal delays.

DETERMINING LOADING AREA CAPACITY

The maximum number of buses per loading area per hour, B_{bb} , is given by Equation 27-5.

$$B_{bb} = \frac{3,600 \left(\frac{g}{C} \right)}{t_c + \left(\frac{g}{C} \right) t_d + Z_a c_v t_d} \tag{27-5}$$

where

- B_{bb} = maximum number of buses per berth per hour (buses/h),
- g/C = effective green time per signal cycle (1.0 for a stop not at a signalized intersection),
- t_c = clearance time between successive buses (s),
- t_d = average dwell time (s),
- Z_a = one-tail normal variate corresponding to probability that queues will form behind bus stop, and
- c_v = coefficient of variation of dwell times.

These maximum capacities assume adequate loading area and bus stop geometry. Guidelines for the spacing, location, and geometric design of bus stops are given in TCRP Report 19 (6).

DETERMINING BUS STOP CAPACITY

As shown in Exhibit 27-12, increasing the number of linear loading areas at a bus stop has an ever-decreasing effect on capacity as the number of loading areas increases. Doubling the number of linear loading areas at a bus stop does not double capacity because the linear loading areas of multiple-berth stops typically are not used equally. When more than three loading areas are required, sawtooth, pull-through, or other nonlinear designs should be considered.

The values suggest that four or five on-line linear loading areas have the equivalent effectiveness of three loading areas. Note that to provide two effective on-line loading areas, three physical loading areas would have to be provided, since partial loading areas are never built. All other types of multiple loading areas are 100 percent efficient: the number of effective loading areas equals the number of physical loading areas.

The vehicle capacity of a bus stop in buses per hour is given by Equation 27-6.

$$B_s = N_{eb} B_{bb} = N_{eb} \frac{3,600 \left(\frac{g}{C} \right)}{t_c + \left(\frac{g}{C} \right) t_d + Z_a c_v t_d} \tag{27-6}$$

where

- B_s = maximum number of buses per bus stop per hour, and
- N_{eb} = number of effective loading areas, from Exhibit 27-12.

Sawtooth and other nonlinear designs are more effective than linear loading areas when four or five loading areas are required

Person capacity of a bus stop is related to number of people boarding and alighting

EXHIBIT 27-12. EFFICIENCY OF MULTIPLE LINEAR LOADING AREAS AT BUS STOPS

Loading Area No.	On-Line Loading Areas		Off-Line Loading Areas	
	Efficiency, %	No. of Cumulative Effective Loading Areas	Efficiency, %	No. of Cumulative Effective Loading Areas
1	100	1.00	100	1.00
2	85	1.85	85	1.85
3	60	2.45	75	2.60
4	20	2.65	65	3.25
5	5	2.70	50	3.75

Note: On-line values assume that buses do not overtake each other.
 Source: References 19, 21, and 22.

BUS FACILITIES ON FREEWAY HOV LANES AND BUSWAYS

Freeway HOV lanes are designed to increase the person capacity of a freeway by reserving one or more lanes, either part time or full time, for the use of vehicles with a multiple number of occupants. When the regular freeway lanes experience congestion, vehicles in the HOV lane should still travel freely. As a result, persons in the HOV lane are provided a time-savings benefit compared with those in general traffic.

Exclusive busway vehicle capacity can be computed using appropriate assumptions regarding the type of bus used, maximum allowable bus loading, the distribution of ridership among stops, the peak-hour factor, and the type of loading area. Chapter 14 presents typical busway vehicle capacities in CBD areas.

The person capacity of a busway or HOV lane at its maximum load point may be computed by multiplying the product of number per hour of each type of vehicle and the number of seats available per vehicle by a peak-hour factor. However, the vehicle capacity and therefore the person capacity will be constrained by bus stop capacity. High-speed bus service on busways and HOV lanes should not allow standees, so capacity calculations should assume that every passenger is seated. Chapter 14 provides illustrative busway person capacities at the maximum load point.

Exhibit 27-13 shows how the number of channels, or doors, and number of loading areas increase the maximum load point capacity. This exhibit can be used to estimate the number of passengers per hour that can be accommodated by various numbers and types of loading areas. The exhibit assumes that passenger loading is concentrated in the CBD area as opposed to being dispersed along the busway. Note that increasing the number of doors available for boarding (e.g., by using prepaid fares at busway stations or through use of smart card technology) greatly increases the person capacity of a busway.

The average speed of a bus operating on a busway or freeway HOV lane depends on three factors: the running speed of the bus in the lane, bus stop spacing, and dwell time at bus stops.

Chapter 23, "Basic Freeway Segments," may be used to estimate the running speed of a bus in a busway or freeway HOV lane given the free-flow speed of the lane, the traffic volume in the lane, and the mix of passenger vehicles and buses using the lane. The time required to travel through a given length of busway or HOV lane without stopping can be calculated from this running speed.

Bus stop spacing affects the number of times a bus must dwell as well as the number of times the bus experiences added delay due to acceleration and deceleration. A rate of 1.2 m/s² may be assumed for acceleration and deceleration in the absence of local data (10). Exhibit 27-14 lists average travel speeds in kilometers per hour for a selection of running speeds, dwell times, and off-line bus stop spacings. As would be expected, average bus speeds decrease as the stop spacing increases or as the average dwell time per stop increases.

Capacity of a busway depends on the capacity of major stops

Average bus speed is determined by

- running speed,
- stop spacing, and
- dwell time.

EXHIBIT 27-13. TYPICAL BUSWAY LINE-HAUL PASSENGER VOLUMES

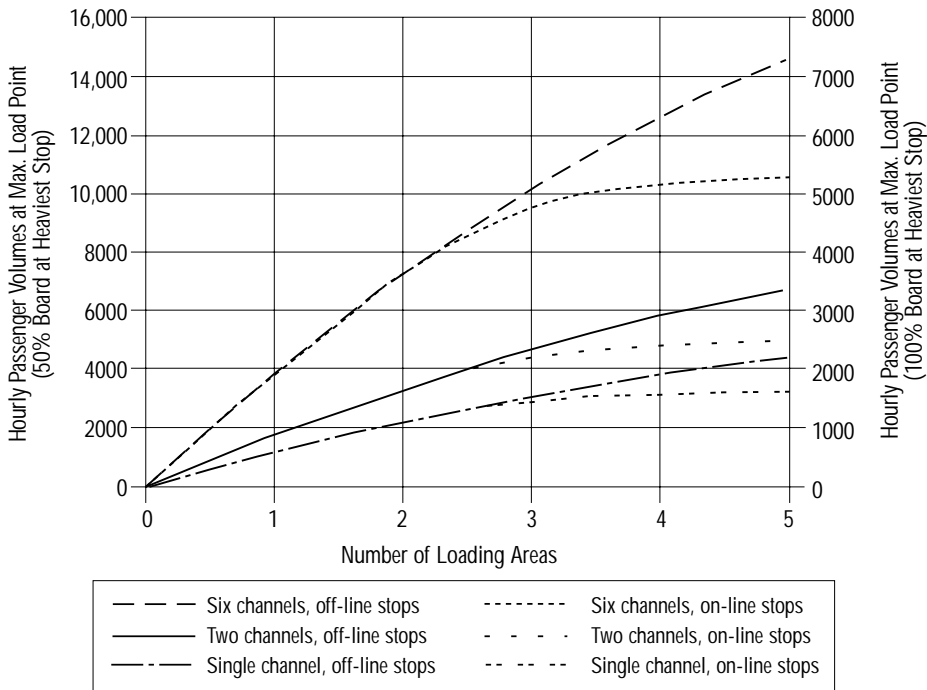

Note: Six-channel configurations assume 60-passenger (seated) articulated buses.

EXHIBIT 27-14. ESTIMATED AVERAGE SPEEDS OF BUSES OPERATING IN FREEWAY HOV LANES

Stop Spacing (km)	Dwell Time (s)			
	15	30	45	60
80-km/h Running Speed				
1.5	53.4	46.6	41.2	37.0
2.5	61.6	55.9	51.1	47.1
3.0	64.1	58.9	54.4	50.6
4.0	67.4	63.0	59.1	55.7
5.0	69.6	65.8	62.4	59.3
90-km/h Running Speed				
1.5	56.4	48.7	42.9	38.4
2.5	66.3	59.7	54.3	49.8
3.0	69.3	63.2	58.1	53.8
4.0	73.5	68.3	63.8	59.8
5.0	76.3	71.8	67.7	64.1
100-km/h Running Speed				
1.5	58.6	50.4	44.2	39.4
2.5	70.3	62.8	56.9	52.0
3.0	73.9	67.0	61.3	56.5
4.0	79.1	73.0	67.9	63.4
5.0	82.5	77.2	72.5	68.4

Note:
 Values are in kilometers per hour.
 Assumes constant 1.2-m/s² acceleration-deceleration rate as buses enter and exit the freeway from off-line stops.

EXCLUSIVE URBAN STREET BUS FACILITIES

Exclusive urban street bus facility capacity and speed determination processes are given in the following sections. The procedure applies for three lane types, namely, Type 1, bus lanes with no adjacent lane; Type 2, bus lanes with partial use of an adjacent lane; and Type 3, bus lanes with two lanes for the exclusive use of buses. These types of bus lane treatments are described in Chapter 14. Illustrations 27-1 through 27-3 depict Types 1, 2, and 3 exclusive bus lanes, respectively.



Denver, Colorado



Los Angeles, California

Illustration 27-1. Examples of Type 1 exclusive bus lane.



Portland, Oregon



Montreal, Canada

Illustration 27-2. Examples of Type 2 exclusive bus lane.



New York, New York



Miami, Florida (single lane with off-line stops)

Illustration 27-3. Examples of Type 3 exclusive bus lane.

Vehicle Capacity

The vehicle capacity of an exclusive bus lane depends on several factors:

- Bus lane type,
- Whether skip-stop operation is used,

- Whether buses using the lane are organized into platoons,
- Volume to capacity ratio of the adjacent lane for Type 2 bus lanes, and
- Bus stop location and right-turning volumes from the bus lane.

If no special bus operational procedures, such as skip-stop, are used and if right turns by nontransit vehicles are prohibited, the bus lane vehicle capacity is simply the vehicle capacity of the critical bus stop along the bus lane. However, when skip-stop operation is used or when right turns are allowed, adjustments must be made to this base vehicle capacity.

Adjustment for Right Turns

Right-turning traffic physically competes with buses in the bus lane for space at an intersection. The traffic generally turns from the bus lane, although in some cases right turns are made from the adjacent lane. Vehicles may queue behind buses at a near-side bus stop to make a right turn. Conversely, right-turning traffic may block buses or preempt green signal time. The interference of right-turning traffic on bus operations can be further magnified by significant pedestrian crossing volumes blocking right-turn movements. The placement of the bus stop at the intersection, whether near-side, far-side, or midblock, can also influence the amount of delay induced by, and to, the right-turning traffic.

The effects of right turns on bus lane vehicle capacity can be estimated by multiplying the bus lane vehicle capacity without right turns by an adjustment factor. The values of this adjustment factor, f_r , may be estimated using Equation 27-7.

$$f_r = 1 - f_l \left(\frac{v_r}{c_r} \right) \tag{27-7}$$

where

- f_r = right-turn adjustment factor;
- f_l = bus stop location factor, from Exhibit 27-15;
- v_r = volume of right turns at specific intersection (veh/h); and
- c_r = capacity of right turns at specific intersection (veh/h).

Suggested factors for the bus stop location factor, f_l , are listed in Exhibit 27-15. Where right turns are allowed, the factors range from 0.5 for a far-side stop with the adjacent lane available for buses to 1.0 for a near-side stop with all buses restricted to a single lane. A factor of 0.0 is used for Type 3 lanes, since right turns by nontransit vehicles are not allowed from this type of bus lane. These factors reflect the likely ability of buses to move around right-turn queues.

EXHIBIT 27-15. BUS STOP LOCATION FACTORS

Bus Stop Location	Bus Lane Type		
	Type 1	Type 2	Type 3
Near-side	1.0	0.9	0.0
Midblock	0.9	0.7	0.0
Far-side	0.8	0.5	0.0

Note:

$f_l = 0.0$ for contraflow bus lanes and median bus lanes regardless of bus stop location or bus lane type, since right turns are either prohibited or do not interfere with bus operations.

Source: St. Jacques and Levinson (10).

Adjustment for Skip-Stop Operation

The total number of buses per hour that can be accommodated by a series of skip stops represents the sum of the capacities of bus routes using each stop multiplied by an impedance factor, f_k , reflecting nonplatooned arrivals and the effects of high volumes of

Capacity adjustment for effects of right-turning traffic

vehicular traffic in the adjacent lane. Equation 27-8 represents the factors that impede buses from fully utilizing the added capacity provided by skip-stop operations (10).

$$f_k = \frac{1 + Ka(N_s - 1)}{N_s} \quad (27-8)$$

where

- f_k = capacity adjustment factor for skip-stop operations;
- K = adjustment factor for ability to fully utilize bus stops in a skip-stop operation: 0.50 for random arrivals, 0.75 for typical arrivals, and 1.00 for platooned arrivals;
- a = adjacent-lane impedance factor, from Equation 27-9; and
- N_s = number of alternating skip stops in sequence.

$$a = 1 - 0.8 \left(\frac{v}{c} \right)^3 \quad (27-9)$$

where

- v = traffic volumes in adjacent lane (veh/h), and
- c = capacity of adjacent lane (veh/h).

These values result in added capacity with skip stops, even when the adjacent lane is fully utilized by passenger vehicles, since nonstopping buses have zero dwell time at the stop. When there is no spreading of stops, no increase in capacity is rendered by the adjacent lane.

Exhibit 27-16 gives representative values for the impedance factor, f_k , for various types of bus lanes and stopping patterns. As indicated previously, these factors are applied to the sum of the capacities in the sequence of bus stops. Thus, they reflect the actual dwell times at each stop. Exhibit 27-17 gives adjustment factors for a Type 2 bus lane with alternating two-block stops. In general, the traffic impacts of the adjacent lane only become significant when that lane operates above 75 percent of its capacity.

The set of adjustment factors for skip-stop operations and the impact of right turns define the following equations for estimating exclusive urban street bus lane vehicle capacity:

Exclusive urban street bus lane vehicle capacity

$$\text{Non-skip-stop operation: } B = B_1 = B_{bb} N_{eb} f_r \quad (27-10)$$

$$\text{Skip-stop operation: } B = f_k (B_1 + B_2 + \dots + B_n) \quad (27-11)$$

where

- B = bus lane vehicle capacity (buses/h),
- B_{bb} = bus loading area vehicle capacity at critical bus stop (buses/h),
- N_{eb} = number of effective loading areas at critical bus stop,
- f_r = capacity adjustment factor for right turns at critical bus stop,
- f_k = capacity adjustment factor for skip-stop operations, and
- B_1, \dots, B_n = vehicle capacities of each set of routes at their respective critical bus stops that use the same alternating skip-stop pattern (buses/h).

The capacities B_1, B_2, B_n used in Equation 27-11 are calculated separately for each set of routes using Equation 27-10. When the critical stop or stops are determined, several bus stops may have to be tested to determine which one controls the bus lane vehicle capacity, because one stop may have high dwell times but another may have severe right-turning traffic interference.

Several bus stops may have to be tested to determine the critical bus stop, because either dwell times or right-turning volume may control

EXHIBIT 27-16. TYPICAL VALUES OF ADJUSTMENT FACTOR, f_k , FOR AVAILABILITY OF ADJACENT LANES

Condition	Arrivals	Adjacent Lane v/c	a	$N_s - 1$	K	f_k
Type 1 Bus Lane						
Stops every block	-	0 to 1	0 to 1	0	0	1.00
Type 2 Bus Lane						
Stops every block	-	0 to 1	0 to 1	0	0	1.00
Alternating 2-block stops	Random	0	1	1	0.50	0.75
		1	0.2 ^a	1	0.50	0.55
Alternating 2-block stops	Typical	0	1	1	0.75	0.88
		1	0.2 ^a	1	0.75	0.58
Alternating 2-block stops	Platooned	0	1	1	1.00	1.00
		1	0.2 ^a	1	1.00	0.60
Type 3 Bus Lane						
Alternating 2-block stops	Random	0	1	1	0.50	0.75
Alternating 2-block stops	Random	0	1	1	0.75	0.88
Alternating 2-block stops	Random	0	1	1	1.00	1.00
Alternating 3-block stops	Random	0	1	2	0.50	0.67
Alternating 3-block stops	Random	0	1	2	0.75	0.83
Alternating 3-block stops	Random	0	1	2	1.00	1.00

Note:

a. Approximate.

Source: St. Jacques and Levinson (10).

EXHIBIT 27-17. VALUES OF ADJUSTMENT FACTOR, f_k , FOR TYPE 2 BUS LANES WITH ALTERNATING TWO-BLOCK SKIP STOPS

Adjacent Lane v/c	Arrival Pattern		
	Random	Typical	Platooned
0.0	0.75	0.88	1.00
0.5	0.72	0.84	0.95
0.6	0.71	0.81	0.92
0.7	0.68	0.77	0.87
0.8	0.65	0.71	0.80
0.9	0.60	0.65	0.71
1.0	0.55	0.58	0.60

Source: St. Jacques and Levinson (10).

Bus Effects on Adjacent-Lane Capacity

The introduction of single or dual bus lanes reduces vehicle capacity for other traffic. The extent of this reduction is determined by the bus lane type, the number of buses using the bus lane, and whether the bus lane replaces a curb parking lane.

The effects of bus lane operations on the adjacent general travel lane can be expressed by multiplying the adjacent-lane vehicle capacity by the adjustment factor given in Equation 27-12. The factor is applied to saturation flow similar to the other saturation flow adjustments, including the factor for bus blockage.

$$f_p = 1 - \left(4 \frac{N_p}{3,600} \right) \quad (27-12)$$

where

- f_p = bus-passing activity factor, and
- N_p = number of buses making maneuver from curb lane to adjacent lane, from Equation 27-13.

Saturation flow adjustment factor for bus use of adjacent lane

The delay to through traffic in the adjacent lane is minimal unless buses leave the bus lane. Therefore, an adjustment is needed to determine the actual number of buses, N_p , that would pass other buses using the curb lane. Simulations and field observations (10) indicate that when buses operate at less than one-half the vehicle capacity of the bus lane, they have little need to pass each other even in a skip-stop operation because of the low arrival headways relative to capacity. Bus use of the adjacent lane increases at an increasing rate as bus activity approaches capacity. Thus, N_p may be approximated using Equation 27-13.

$$N_p = \frac{N_s - 1}{N_s} v_b \left(\frac{v_b}{c_b} \right)^3 \quad (27-13)$$

where

- N_s = number of stops skipped,
- v_b = volume of buses in bus lane (buses/h), and
- c_b = bus vehicle capacity of bus lane (buses/h).

As expressed in Equation 27-13, the number of buses in the adjacent lane would be half the total bus flow when an alternating two-block skip-stop operation approaches capacity. Two-thirds of the buses would use the adjacent lane for a three-block pattern. However, these impacts would not take full effect until the bus volumes approached capacity.

Person Capacity

The person capacity at the maximum load point of an urban street bus lane can be determined by multiplying the product of bus lane vehicle capacity given by Equation 27-10 or Equation 27-11, as appropriate, and the allowed passenger loads on board an individual bus by a peak-hour factor.

Speed

The best way to determine bus travel speeds on urban street bus lanes is to measure them directly. When this is not possible (for example, in planning future service), speeds can be estimated by driving the route and making an average number of stops with simulated dwells, with two or three runs during both peak and off-peak times, or by scheduling buses on similar routes and adjusting running times as needed on the basis of operating experience. Alternatively, the analytical method described below can be used to estimate speeds.

Bus speeds on exclusive urban street bus lanes are influenced by bus stop spacing, dwell times, delays due to traffic signals and right-turning traffic, skip-stop operations, and interference caused by other buses. These factors are reflected in Equation 27-14, which can be used to estimate bus travel speed, S_t , on urban streets. Bus running time is determined from Exhibits 27-18 and 27-19, accounting for the effects of stop spacing, dwell times, and traffic and signal delays. This running time is then converted into a speed and adjusted to account for the effects of skip-stop operations and the interference of other buses operating in the lane.

$$S_t = \left(\frac{60}{t_{r,0} + t_{r,1}} \right) f_s f_b \quad (27-14)$$

where

- S_t = bus travel speed (km/h),
- $t_{r,0}$ = base bus running time (min/km),
- $t_{r,1}$ = bus running time losses (min/km),
- f_s = skip-stop speed adjustment factor, and
- f_b = bus-bus interference adjustment factor.

- Bus lane person capacity at the maximum load point is the product of
- bus lane vehicle capacity,
 - allowed passenger loads, and
 - peak-hour factor.

EXHIBIT 27-18. ESTIMATED BASE BUS RUNNING TIME, $t_{r,0}$

Dwell Time (s)	Stops per km							
	1	2	3	4	5	6	7	8
10	1.39	1.82	2.29	2.83	3.46	4.18	5.04	5.91
20	1.55	2.15	2.79	3.49	4.29	5.19	6.20	7.24
30	1.72	2.49	3.29	4.16	5.12	6.18	7.37	8.58
40	1.89	2.82	3.78	4.82	5.96	7.18	8.54	9.91
50	2.06	3.15	4.28	5.49	6.80	8.18	9.70	11.24
60	2.22	3.48	4.77	6.15	7.63	9.18	10.87	12.58

Notes:
 Values are in minutes per kilometer.
 Data based on field measurements.
 Interpolation between shown values of dwell time is done on a straight-line basis.
 Source: St. Jacques and Levinson (23).

EXHIBIT 27-19. ESTIMATED BUS RUNNING TIME LOSSES, $t_{r,1}$

Condition	Bus Lane	Bus Lane No Right Turns	Bus Lane with Right-Turn Delays	Bus Lanes Blocked by Traffic	Mixed-Traffic Flow
Central Business District					
Typical		0.7	1.2	1.5-1.8	1.8
Signals set for buses		0.4	0.8		
Signals more frequent than bus stops		0.9-1.2	1.5-1.8	1.8-2.1	2.1-2.4
Streets Outside the CBD					
Typical	0.4				0.6
Range	0.3-0.6				0.4-0.9

Notes:
 Values are in minutes per kilometer.
 Data based on field measurements. Traffic delays shown reflect peak conditions.
 Source: St. Jacques and Levinson (23).

Bus Travel Time Rates

Exhibits 27-18 and 27-19 together provide an estimate of bus running times as a function of stop spacing, average dwell time per stop, and operating environment. These values were derived from field observations (23). First, a base bus running time is determined from Exhibit 27-18. This running time reflects the speed buses would travel without signal or traffic delays. Next, running time losses are determined from Exhibit 27-19, accounting for the effects of signals and other traffic sharing the bus lane. If actual observed delays are available, they could be used in lieu of the estimates given in Exhibit 27-19. The two running times are added and divided into 60 to determine a base bus speed for use in Equation 27-14.

Average speeds can be calculated for any distance and series of stop patterns. When a corridor is examined, the length of the study area, the number of bus stops, and the dwell times at each stop will affect the speed results. The capacity calculation should be made at the critical point along the urban street, where the combination of dwell time and dwell variation results in the lowest calculated capacity. Sections chosen for analysis should have generally homogeneous characteristics in terms of street geometry, bus lane features, stop frequency, and dwell times. The average dwell times and v/c ratios in each section should be used in estimating speeds. Ideally, each section should be at least 400 m long.

In applying Exhibit 27-19, the additional running time loss selected from a possible range of losses should consider both signal timing and enforcement efforts (or the lack thereof) to keep nonauthorized vehicles out of an exclusive bus lane.

Adjustment for Skip-Stop Operation

Skip-stop operations spread buses out among a series of bus stops, allowing for an increase in speeds. The analytical method accounts for skip-stop operations by considering only the bus stops in the skip-stop pattern. For example, if bus stops are located 125 m apart at each intersection, a two-block skip-stop pattern provides 250 m between stops for a bus using that pattern. A bus with a two-block pattern would be able to proceed at about twice the speed of a bus with a one-block stop pattern and a bus with a three-block stop pattern at about three times the speed, assuming uniform block distances and dwell times. The ability of buses to leave the curb bus lane to pass stopped buses becomes a factor in the ability to attain the two- or threefold increase in speed. This ability depends on the availability of the adjacent lane or the provision of an off-line bus stop. Where dual bus lanes or off-line bus stops are provided, the anticipated bus speed can be calculated using the distance between the bus stops served. Where congestion in the adjacent lane results in essentially no passing-lane availability, the buses will progress as if they were stopping at each stop with a zero dwell time at the intermediate stops. When partial use of the adjacent lane is available, the bus speed will be somewhere in between.

Equation 27-15 expresses the speed adjustment factor for skip-stop operation, f_s , as a function of both the traffic in the adjacent lane and the buses in the curb lane (10). This factor reduces the faster base running time that results from the longer distance between stops used in the skip-stop pattern. If skip stops are not used, $f_s = 1.0$, and the base running speed is based on the actual stop spacing.

$$f_s = 1 - \left(\frac{L_1}{L_2} \right) \left(\frac{v}{c} \right)^2 \left(\frac{v_b}{c_b} \right) \quad (27-15)$$

where

- f_s = skip stop speed adjustment factor,
- L_1 = distance for one-block stop pattern (m),
- L_2 = distance for multiple-block stop pattern (m),
- v = volume in adjacent lane (veh/h),
- c = vehicular capacity of adjacent lane (veh/h),
- v_b = volume of buses in bus lane (buses/h), and
- c_b = bus vehicle capacity of a single bus lane (buses/h).

Exhibit 27-20 illustrates the effects of increasing bus v/c ratio and general traffic v/c ratio in the adjacent lane on the skip-stop speed adjustment factor. The exhibit assumes a two-block skip-stop pattern. It can be seen that until the volume of the adjacent lane becomes more than about 50 percent of the bus lane capacity, the ability to achieve the twofold increases in speed is not reduced, regardless of the bus lane v/c ratio. At higher v/c ratios, both the bus lane volumes and the adjacent-lane volumes play an important role in determining bus speeds. When skip-stop operations are used, speeds should be calculated separately for each skip-stop pattern used.

EXHIBIT 27-20. SKIP-STOP SPEED ADJUSTMENT FACTOR, f_s

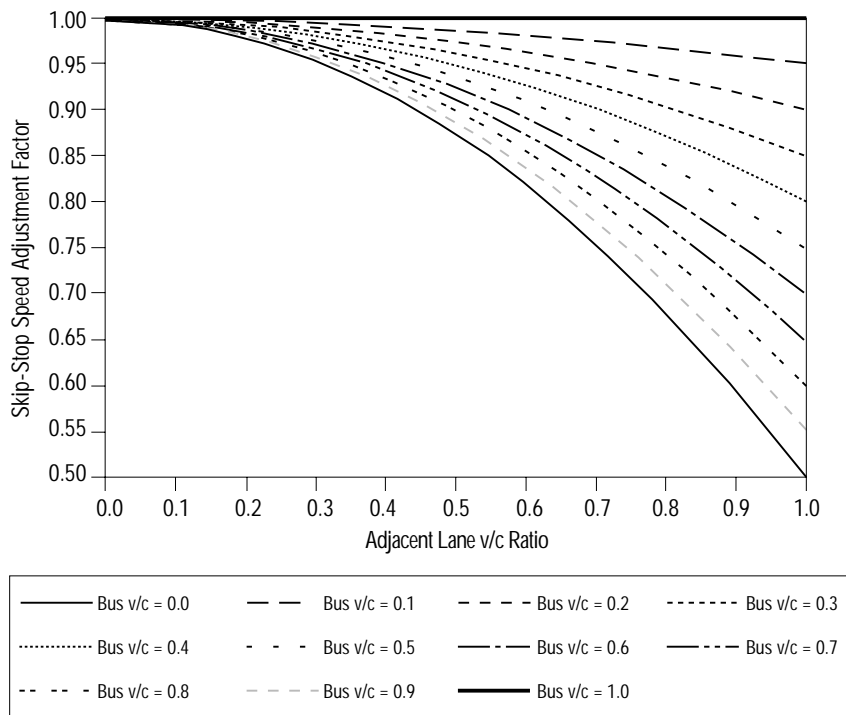

Note: Assumes two-block skip-stop pattern.

Adjustment for Bus-Bus Interference

Bus speeds within a bus lane along an urban street decline as the lane becomes saturated with buses because as the number of buses using the lane increases, there is a greater probability that one bus will delay another bus, either by using available loading areas or by requiring passing and weaving maneuvers. Research (22) and field observations have shown a sharp drop in bus speeds as bus volumes approach capacity (10). Exhibit 27-21 lists values of the speed adjustment factor for bus-bus interference.

Exhibit 27-22 shows the effects of increasing bus lane volumes on bus speeds. There is little effect on bus speeds until approximately 70 percent of the bus lane capacity is being used.

EXHIBIT 27-21. BUS-BUS INTERFERENCE FACTOR, f_b

Bus Lane v_b/c_b Ratio	Bus-Bus Interference Factor
< 0.5	1.00
0.5	0.97
0.6	0.94
0.7	0.89
0.8	0.81
0.9	0.69
1.0	0.52
1.1	0.35

Source: St. Jacques and Levinson (10).

EXHIBIT 27-22. BUS LANE VOLUMES AND SPEEDS

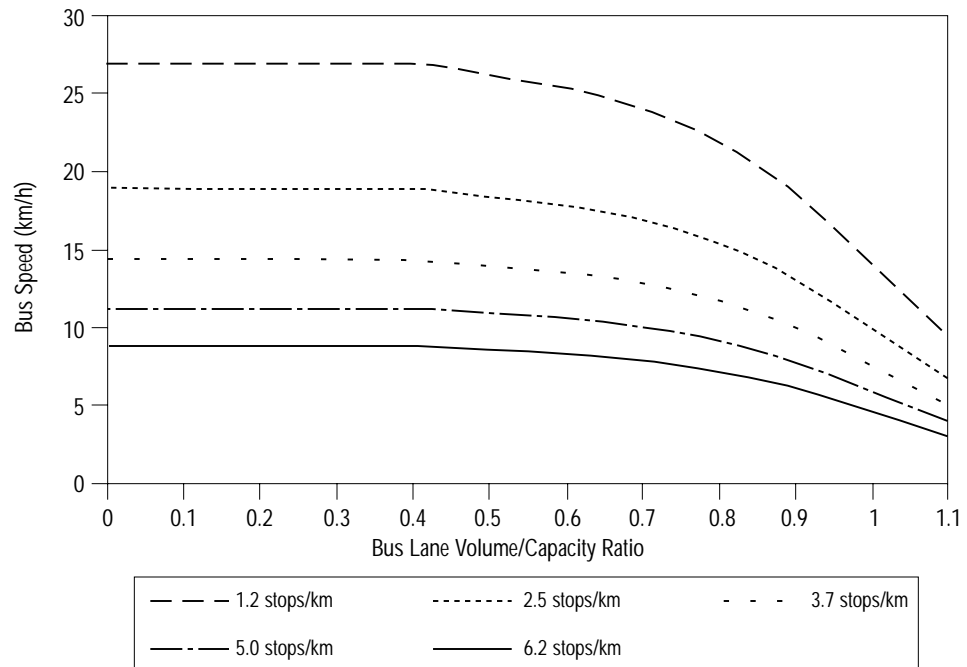

Note: Assumes suburban conditions, 30-s dwell times, and a single bus lane.

MIXED-TRAFFIC BUS FACILITIES

Buses in mixed-traffic situations represent the most common operating scenario in North American cities and rural areas for small and large buses, both standard and articulated, and for both fixed-route and demand-responsive services. The unusual exceptions occur in larger cities with very high capacity routes, which may lend themselves to busways or downtown bus lanes.

Because a bus operates much like other vehicles in a traffic lane, its impact on the overall vehicle capacity of the lane may be calculated as if it were another vehicle, using methods given in other chapters in this manual. Bus vehicle capacity is calculated in a similar manner as that for exclusive urban street bus lanes, except that the interference of other traffic on bus operations must be accounted for. This traffic interference is greatest when off-line stops are used and buses must wait for a gap in traffic to merge back into the street.

Bus Lane Types

Type 1 mixed-traffic lanes have one traffic lane in the direction the bus operates, shared by buses and other vehicles. Type 2 mixed-traffic lanes have two or more traffic lanes in the direction the bus operates. Traffic can use any lane, but buses typically operate in the curb lane. There are no Type 3 mixed-traffic bus lanes. Illustration 27-4 depicts Type 1 and Type 2 mixed-traffic bus lanes.

Mixed-traffic bus capacity is calculated in a similar manner as that for exclusive urban street bus lanes, except that the interference of other traffic sharing a lane with buses must be accounted for



Type 1 (Portland, OR)



Type 2 (Portland, OR)

ILLUSTRATION 27-4. Mixed-traffic bus lane types.

Vehicle and Person Capacity

The volume of mixed traffic sharing the curb lane with buses affects bus vehicle capacity in two ways: (a) the interference caused by other traffic in the lane, particularly at intersections, may block buses from reaching a stop or may delay a bus blocked behind a queue of automobiles, and (b) for off-line stops, the additional reentry delay encountered when buses leave a stop and reenter traffic may affect capacity. The latter source of delay is incorporated into the clearance time used to calculate bus stop capacity. The former is accounted for by the mixed-traffic adjustment factor, f_m , calculated using Equation 27-16.

$$f_m = 1 - f_l \left(\frac{v}{c} \right) \quad (27-16)$$

where

- f_m = mixed-traffic adjustment factor,
- f_l = bus stop location factor,
- v = curb-lane volume at critical bus stop, and
- c = curb-lane capacity at critical bus stop.

The mixed-traffic adjustment factor is essentially the same as the right-turn adjustment factor presented in Equation 27-7 for exclusive urban street bus lanes. The difference is that in a mixed-traffic situation, the nontransit traffic will be greater and it may not just be turning right; it could also be going straight or even left, and thus bus vehicle capacity will be lower in a mixed-traffic situation than in an exclusive bus lane. Chapters 15 and 16 should be used to determine the vehicle capacity of the curb lane. Equation 27-17 is used to calculate the bus vehicle capacity of a mixed-traffic lane in which buses operate.

$$B = B_{bb} N_{eb} f_m \quad (27-17)$$

where

- B = mixed-traffic bus lane capacity (buses/h),
- B_{bb} = maximum number of buses at critical bus stop (buses/h),
- N_{eb} = number of effective loading areas at critical bus stop, and
- f_m = mixed-traffic adjustment factor at critical bus stop.

The person capacity of buses operating in mixed traffic at the lane's maximum load point may be calculated by multiplying the product of vehicle capacity and the maximum passenger load allowed by policy by a peak-hour factor. The mixed-traffic bus capacity procedures are an extension of the exclusive bus lane capacity procedures developed by the TCRP A-7A project. A theoretical basis exists for the mixed-traffic procedure, but the procedure has not yet been validated in the field.

Delay to buses from other vehicles that slow entry into, or departure from, a bus stop is accounted for in the estimate of clearance time

The mixed-traffic bus capacity procedures are an extension of the exclusive bus lane capacity procedures developed by Project TCRP A7-A. A theoretical basis exists for the mixed-traffic procedure, but it has not yet been validated in the field.

Measure bus speeds directly whenever possible

Speed

The best way to determine bus travel speeds is to measure them directly. If this is not possible (for example, in planning future service), speeds can be estimated by driving the route or by using Equation 27-14 to estimate bus speeds. The bus-bus interference adjustment factor, f_b , should be set to 1.0 in mixed-traffic situations because the additional running time losses obtained from Exhibit 27-19 already account for the interference of other traffic sharing the lane with buses. The value selected from the range of values presented in Exhibit 27-19 should consider signal timing and the volume of traffic using the bus lane relative to its capacity.

SIZING STATION AREAS

The methodologies in Chapter 18, "Pedestrians," can be used to size passenger waiting areas at transit stops and stations. Given a desired LOS for the waiting area, based on the amount of space provided per passenger, and estimates of maximum boarding passenger volumes per vehicle per route at the stop, Equation 27-18 can be used to estimate the required size of the passenger waiting area, A . Greater detail on sizing station areas can be found in the *Transit Capacity and Quality of Service Manual (1)*.

$$A = (P_{b1} + P_{b2} + \dots + P_{bn})a_p \quad (27-18)$$

where

- A = passenger waiting area size (m^2),
- P_{b1}, \dots, P_{bn} = boarding passenger volume per transit vehicle for each route served by waiting area during peak 15 min (p), and
- a_p = design pedestrian area occupancy (m^2/p).

PARAMETERS OF LIGHT RAIL AND STREETCAR FACILITIES

Of the many varieties of rail transit—streetcars, light rail, rail rapid transit, commuter rail, and automated guideway—only streetcars and light rail can operate on urban streets. Streetcars often operate in mixed traffic and have characteristics similar to those of buses under these circumstances. Modern light rail systems running on street usually operate in reserved lanes and have significantly different characteristics from buses.

This section presents methods and procedures for estimating the vehicle and person capacity of streetcars and light rail vehicles operating on street. The *Transit Capacity and Quality of Service Manual* should be consulted for similar procedures for off-street rail modes. Determining on-street rail transit capacity is a three-step process: determining the dwell time at the stop with the highest passenger volumes, determining the track section providing the minimum headway, and calculating capacity based on the minimum headway.

Dwell Time

The dwell time, t_d , is the time required to serve passengers at the busiest door divided by the number of available doors, or channels (most light rail doors are dual stream, having two channels) plus the time required to open and close the doors (typically 5 s for modern light rail vehicles, 10 s if folding or sliding steps are involved) (24). Time spent waiting at a station with the doors closed is incorporated into the operating margin. Equation 27-19 is used to calculate dwell time.

$$t_d = \frac{P_d t_{pf}}{N_{cd}} + t_{oc} \quad (27-19)$$

where

- t_d = dwell time (s),
- N_{cd} = number of channels per door for moving passengers,
- t_{oc} = door opening and closing time (s),

P_d = alighting passengers per rail through busiest door (p), and
 t_{pf} = passenger flow time (s/p), from Exhibit 27-23.

EXHIBIT 27-23. RAIL TRANSIT AVERAGE PASSENGER FLOW TIMES (SINGLE STREAMS)

Car Entry	Passenger Flow Time t_{pf} for Flow Type (s/p)		
	Mainly Boarding	Mainly Alighting	Mixed Flow
Level	2.0	1.5	2.5
Steps	3.2	3.7	5.2

Note:
 Add 1 s to mixed flow and either boarding or alighting times if fares are collected on board.
 Source: Parkinson and Fisher (24).

Peak Passenger Volumes

Some regional transportation models produce a.m. or p.m. peak flows for a 2-h period. In this case, either the model's peak-hour conversion factor or a typical value of 60 percent is used to arrive at a peak-hour passenger volume. Next, the station with the highest passenger volume, either into or out of the station, is selected and the flow is classified as mainly boarding (70 percent or more of the passengers boarding), mainly alighting (70 percent or more of the passengers alighting), or mixed (all other situations). If the maximum load point station is downtown, it is likely that the flow will be primarily alighting in the morning and primarily boarding in the afternoon. If the station is also an interchange with another rail transit line, flows could be mixed.

Unless station flows are also available for the afternoon peak period, this process assumes that the morning peak period defines the controlling headway and thus maximum capacity. Morning peaks tend to be sharper, whereas afternoon peaks are more dispersed as some passengers pursue other activities between work and the trip home.

The hourly passenger flows are adjusted for peak 15-min passenger flows. Unless there is sufficient similarity with an existing operation (see Equation 27-4), the recommended PHF for light rail is 0.75 (24).

Number of Doors Available

The number of doors available, D , is given by Equation 27-20 and is related to the number of trains scheduled per hour, the average number of cars per train, and the number of doors per car. The number of cars per train is limited by the station length (typically one city block in CBD areas).

$$D = \frac{3,600D_c N_c}{h_s} \quad (27-20)$$

where

- D = number of doors available in peak hour,
- D_c = number of doors per car,
- N_c = number of cars per train, and
- h_s = scheduled headway (s).

Passenger Flow at Controlling Door

Except on heavily loaded rail lines operating close to capacity (a situation in which this method is not appropriate), passengers do not tend to spread evenly along a station platform, and uneven doorway utilization results. A value of 1.5 is recommended for light rail for the ratio of busiest door usage to average door usage. Equation 27-21 calculates passenger volume at the busiest door.

Morning peak usually defines controlling headway

Deduct any door not available for passengers, such as a door blocked by wheelchair lifts

$$P_d = \frac{R_d P}{D(\text{PHF})} = \frac{R_d P h_s}{3,600 D_c N_c (\text{PHF})} \quad (27-21)$$

where

- P_d = passenger volume through busiest door during peak 15 min (p), and
- R_d = ratio of busiest door usage to average door usage.

Operating Margins

When dwell times are calculated, it is not possible to account for every variable that may affect dwell times. Passenger volumes may vary within the 15-min peak, especially at transfer stations where passengers may arrive in surges following the arrival of connecting buses or trains. Trains may run faster or slower than scheduled, because of either equipment problems or differences among train operators. A late train has additional passenger movement, because more passengers have accumulated at each station since the previous train. Consequently, a late train has a longer station dwell time and becomes progressively later until it interferes with the schedule of the following train. Similarly, a train running early results in longer dwell times for the following train, because more passengers than normal have accumulated in the time between the two trains.

Operating margin defined

An operating margin is the extra time added to a transit line's headway to allow for irregular operation and ensure that one train does not delay the following train. It is suggested that a range be considered for the operating margin. When capacity is not an issue, 25 s or more is recommended. If necessary to provide sufficient service to meet the estimated demand, the operating margin can be reduced to 20 or even 15 s (24).

Adjustment for Wheelchair Accessibility

The accessibility of light rail transit to wheelchairs and other mobility devices (considered together with wheelchairs in this section) is a major issue for such systems. Boarding and alighting times with nonlevel loading of wheelchairs tend to be highly variable, depending on the skill of the passenger. There are five primary ways to provide wheelchair accessibility: car-mounted lifts, platform-mounted lifts, mini-high platforms, high platforms, and low-floor cars. Those are described in greater detail in TCRP Report 13 (24).

To adjust for wheelchair accessibility, doors blocked by wheelchair lifts should be deducted from the total when Equation 27-19 is used to calculate dwell time.

Minimum Headways

An important element in calculating on-street light rail and streetcar vehicle and passenger capacity is determining the minimum headway possible between trains on an off-street block-signalized section, h_{\min} . This calculation is complicated by the variety of rights-of-way that can be employed. Most light rail transit lines use a combination of right-of-way types, which can include on-street operation (often in reserved lanes) and private right-of-way with grade crossings. The line capacity is determined by the weakest link; this link could be a traffic signal with a long cycle length but is more commonly the minimum headway possible on an off-street block-signalized section. Although this chapter focuses on on-street rail operations, the capacity of an on-street section may be constrained by a block-signalized or single-track section elsewhere on the line rather than by conditions in the section being analyzed (24).

The train headway used for calculating capacities is the largest of the three potential controlling headways: on-street, block-signalized, and single-track headways. Equation 27-22 defines this relationship.

$$h_{\min} = \max \begin{Bmatrix} h_{os} \\ h_{bs} \\ h_{st} \end{Bmatrix} \quad (27-22)$$

where

- h_{\min} = minimum train headway (s),
- h_{os} = minimum on-street section train headway (s),
- h_{bs} = minimum block-signaled section train headway (s), and
- h_{st} = minimum single-track section train headway (s).

On-Street Operation

It is difficult to encompass all the variables that affect on-street light rail and streetcar operation in a single formula. However, the capacity of on-street light rail may be greater in certain circumstances than on grade-separated, signalized rights-of-way, where higher speeds force the separation between trains to be increased. Variability due to traffic congestion has been reduced as a factor, since almost all recently built on-street light rail lines operate on reserved lanes. A number of older streetcar systems still operate extensively in mixed traffic and are subjected to the variability in train throughput caused by traffic queuing, left turns, and parallel parking (24).

The minimum headway between trains operating on street, h_{os} , can be determined from Equation 27-23. For typical streetcar operations, where more than one streetcar can be present in a city block, or for light rail operations where the dwell time at the critical stop is long in comparison with the cycle length, dwell times and the effective green time control the minimum headway. For light rail operation where the length of two trains exceeds one city block, the closest sustainable headway should be at least twice the longest traffic signal cycle on the on-street portions of the line. This headway minimizes the chance that two adjacent trains can block an intersection (25).

$$h_{os} = \max \left\{ \frac{t_c + \left(\frac{g}{C}\right)t_d + Z_a c_v t_d}{\left(\frac{g}{C}\right)} \right\} \quad (27-23)$$

where

- h_{os} = minimum on-street section train headway (s),
- g = effective green time, reflecting reductive effects of on-street parking and pedestrian movements (mixed-traffic operation only) as well as any impacts of traffic signal preemption (s),
- C = cycle length at stop with highest dwell time (s),
- C_{\max} = maximum cycle length in line's on-street section (s),
- t_d = dwell time at critical stop (s),
- t_c = clearance time between successive trains, defined as sum of minimum clear spacing between trains (typically 15 to 20 s or signal cycle time) and time for cars of a train to clear a station (typically 5 s per car) (s);
- Z_a = one-tail normal variate corresponding to probability that queues of trains will form, from Exhibit 27-11; and
- c_v = coefficient of variation of dwell times (typically 40 percent for light rail operation in an exclusive lane and 60 percent for streetcar operation in mixed traffic).

The closest possible headway for multiple-car light rail trains in on-street operation is often taken to be twice the longest traffic signal cycle

Some transit agencies use the signal cycle time (C) as the minimum clearance time

Block-signalized sections, rather than an on-street section, may constrain a light rail or streetcar line's capacity

Single-track sections used for two-way operation (as opposed to single tracks operating in one-way couplets) can constrain light rail and streetcar capacity

Jerk-limiting time is an allowance for equipment features that taper the braking rate at the beginning and end of brake application to provide a smooth stop

Block Signaling

Many light rail lines operate predominantly in private right-of-way with grade crossings or grade separations. These lines can take the form of routes that do not follow existing streets or that run in the medians of roads. Trains are physically separated from other traffic except at crossings, operate with full signal preemption of cross-street traffic, and run at higher speeds than in on-street sections. To ensure safe separations between trains, track sections are divided into blocks, with signals used to control train entry into each block. Many light rail lines are not signaled with the minimum possible headway in mind but more economically for the minimum planned headway. This operation can easily make signaled sections the dominant capacity constraint on a light rail line (24).

Single-Track Sections

Single-track sections greater than 400 to 500 m used for two-way operations are potentially the most restrictive capacity constraint for light rail. Single-track sections are used primarily as a cost-saving measure, both in areas where the right-of-way will permit double tracking at a future date and in areas where widening the right-of-way or a structure is cost-prohibitive.

Equation 27-24 computes the time to cover a single-track section, t_{st} . This computation includes the time required to traverse the single-track section plus one train length at the maximum track section speed; time losses during acceleration, deceleration, and station stops; a speed margin to adjust for equipment not operating to performance specifications and train operators who do not push to the edge of the operating envelope (i.e., do not operate at the maximum permitted speed); and an operating margin to allow for off-schedule trains (24).

$$t_{st} = SM \left[\frac{(N_s + 1)}{2} \left(\frac{3S_{max}}{d_s} + t_{jl} + t_{br} \right) + \frac{L_{st} + L}{S_{max}} \right] + N_s t_d + t_{om} \quad (27-24)$$

where

- t_{st} = time to cover single-track section (s);
- L_{st} = length of single-track section (m);
- L = train length (m);
- N_s = number of stations on single-track section;
- t_d = station dwell time (s);
- S_{max} = maximum speed reached (m/s);
- d_s = deceleration rate (m/s²) also used as a surrogate for twice average acceleration from 0 to v_{max} ;
- t_{jl} = jerk-limiting time (s);
- t_{br} = operator and braking system reaction time (s);
- SM = speed margin (constant); and
- t_{om} = operating margin time (s).

The minimum headway on a single-track section is twice the time required for a train to cover the single-track section and is given by Equation 27-25.

$$h_{st} = 2t_{st} \quad (27-25)$$

where

- h_{st} = minimum single-track section train headway (s).

Light Rail and Streetcar Capacity

Vehicle Capacity

The maximum capacity of a light rail or streetcar line, in terms of the number of trains, T , is determined from the minimum headway by Equation 27-26.

$$T = \frac{3,600}{h_{\min}} \quad (27-26)$$

where

T = maximum number of trains per hour.

Person Capacity

The maximum person capacity, P , of light rail and streetcar lines is the number of trains multiplied by their length, the number of passengers per meter of length set by policy, and a peak-hour factor. Alternatively, maximum person capacity can be determined by Equations 27-27 and 27-28 using the number of trains multiplied by the number of cars per train, the maximum allowed passenger load per car, and a peak-hour factor.

$$P = TLP_m(\text{PHF}) = \frac{3,600LP_m(\text{PHF})}{h_{\min}} \quad (27-27)$$

where

P = maximum single-track capacity in passengers per peak-hour direction (p),
 L = train length (m),
 P_m = loading level (p/m), and
 PHF = peak-hour factor.

$$P = TN_cP_c(\text{PHF}) = \frac{3,600N_cP_c(\text{PHF})}{h_{\min}} \quad (27-28)$$

where

N_c = number of cars per train, and
 P_c = maximum allowed passenger load per car (p).

Speed

Light rail and streetcar travel time is influenced by the following factors.

- Running time required to travel the analysis section if no stops are made. For off-street sections, the maximum operating speed should be used. For on-street streetcar operations (where streetcars share a lane with other traffic), the procedures in Chapter 15, "Urban Streets," should be used. For on-street rail operations in an exclusive lane, either the posted speed for the street or the speed dictated by signal progression should be used, whichever is lower. If rail vehicles do not benefit from either traffic signal progression or traffic signal priority, traffic signal delays should be accounted for when running times are calculated.

- Dwell time at stops.
- Acceleration and deceleration time at stops for boarding and alighting passengers.

For existing light rail and streetcar operations, travel time can be determined either through a series of travel time measurements or by using the scheduled time between points. For the purposes of planning future transit service, travel time can be estimated by the procedures defined in Equations 27-29 through 27-32.

Running time, t_r , is related to distance traveled and the average free-flow speed (FFS) for the section being analyzed. FFS is taken to be the posted speed limit for on-

Trains operating on street should be no more than one block long to avoid blocking intersections when trains stop. Consequently, this length constrains maximum person capacity.

A light rail loading level of 5 passengers per meter of train length is recommended for calculating maximum person capacity of new systems. It provides 0.4 m² per standing passenger.

street operations and the maximum section operating speed for off-street operations. When these values vary over the transit route section being analyzed, a weighted average FFS can be calculated by multiplying the FFS for each section by the length of that section, summing these values, and dividing the result by the total length. A speed margin is used to adjust the running time to account for variations in transit equipment and the fact that drivers may not drive consistently at the FFS.

$$t_r = 3,600SM \frac{L}{S_f} \quad (27-29)$$

where

- t_r = running time (s);
- SM = speed margin, assumed to be 1.1;
- L = analysis section length (km); and
- S_f = free-flow speed of train (km/h).

The acceleration and deceleration time, t_a , is given by Equation 27-30 (24).

$$t_a = \frac{3S_f}{d_s} + t_{jl} + t_{br} \quad (27-30)$$

where

- d_s = deceleration rate (m/s²) also used as a surrogate for twice the average acceleration from 0 to v_f ;
- t_{jl} = jerk-limiting time (s); and
- t_{br} = operator and braking system reaction time (s).

Total travel time, t_t , is computed by Equation 27-31.

$$t_t = t_r + (N - 1)(t_d + t_a) \quad (27-31)$$

where

- t_t = total travel times (s), and
- N = number of stops or stations in analysis section.

Finally, average travel speed, S_t , is computed by Equation 27-32.

$$S_t = \frac{L}{t_t} \quad (27-32)$$

III. APPLICATIONS

The methodology in this chapter is used for analyzing the capacity of transit modes that operate on street, namely, buses, streetcars, and light rail trains. To apply the methodology, the analyst must address two fundamental questions. First, the primary output must be identified. The outputs that are typically produced are capacity and speed.

Second, the analyst must identify the default values or estimated values for use in the analysis. The analyst has three main sources of input data: (a) default values found in this manual, (b) estimates and locally derived default values developed by the analyst, and (c) values derived from field measurements and observation. For each of the input variables, a value must be supplied to calculate the outputs, both primary and secondary.

Specific and commonly used applications are computations of capacity and speed of an existing facility or of a changed facility in the near term or distant future. This type of application is termed operational. Another general type of analysis can be termed planning. This type uses estimates, HCM default values, and local default values for

inputs. As outputs, LOS or capacity can be determined. The difference between a planning analysis and an operational analysis is that for planning, most or all of the input values come from estimates or default values, whereas operational analyses tend to utilize field-measured values or known values.

COMPUTATIONAL STEPS

For operational analysis, all input data are collected or computed. Depending on the type of transit facility, different capacities and speeds are computed.

Exhibit 27-24 summarizes the input factors that are used in the capacity and speed procedures, the results of the various procedures, and the measures that can be taken to improve both the input factors and the results.

PLANNING APPLICATIONS

Procedures for planning applications directly correspond to those described for operational analysis. The criterion that characterizes these as planning applications is the use of estimates and HCM default values or local default values, or both, for inputs.

QUALITY OF SERVICE

There are several measures of quality of service for transit as discussed in this chapter. The availability measures are policy-based, but a low LOS grade should indicate the need to review service to determine whether the amount of service provided to an area is consistent with the area population and job density.

EXHIBIT 27-24. FACTORS INFLUENCING TRANSIT CAPACITY AND SPEED

Factor	Ways To Improve Each Factor or Result
Input Factors	
Dwell time	<ul style="list-style-type: none"> • Make greater use of prepaid fares • Use low-floor vehicles • Encourage one-way door flows on two-door buses • Provide multiple-stream doors for boarding and alighting • Increase bus frequency to reduce the number of standees
Clearance time	<ul style="list-style-type: none"> • Implement proof-of-payment fare collection • Use on-line stops rather than off-line stops^a • Enact and enforce laws requiring vehicles to yield to buses reentering a street • Implement queue jumps at traffic signals
Coefficient of variation	<ul style="list-style-type: none"> • Keep generally constant for a given area
Failure rate	<ul style="list-style-type: none"> • Increase the number of loading areas per stop • Schedule fewer buses per hour using the stop^b
Operating margin	<ul style="list-style-type: none"> • Use policy basis^a
Calculated Results	
Loading area capacity	<ul style="list-style-type: none"> • Reduce dwell time • Implement transit priority treatments • Increase the accepted failure rate^a
Bus stop capacity	<ul style="list-style-type: none"> • Increase loading area capacity • Use off-line loading areas^a • Use sawtooth or pull-through loading areas
Bus lane capacity	<ul style="list-style-type: none"> • Increase the number of loading areas • Increase the capacity of the critical stop • Reserve lanes for buses • Platoon buses
Rail capacity	<ul style="list-style-type: none"> • Implement skip-stop operation • Prohibit right turns by automobiles • Reduce dwell time • Reduce the operating margin^a • Eliminate single-track sections
Bus speeds	<ul style="list-style-type: none"> • Increase the number of cars per train • Reduce dwell time • Implement transit priority treatments
Rail speeds	<ul style="list-style-type: none"> • Balance the number of stops with passenger convenience and demand • Implement skip-stop operation • Reduce dwell time • Balance the number of stops with passenger convenience and demand

Notes:

- a. Measure that may negatively affect other items on the list if implemented.
- b. Measure that improves the failure rate but decreases capacity.

IV. EXAMPLE PROBLEMS

No.	Description
1	Bus dwell time calculation
2	Bus vehicle capacity in mixed traffic (near-side stops)
3	Bus vehicle capacity in mixed traffic (far-side stops)
4	Bus vehicle capacity in mixed traffic (skip-stop operation)
5	Person capacity
6	Bus speeds
7	Light rail capacity on street

Bus dwell time calculation

EXAMPLE PROBLEM 1

The Situation An express route is planned along an arterial from a suburb to the CBD with 10 stops, including one at a transit center midway (Stop 5). The route will operate in mixed traffic in the CBD (Stops 7 to 10).

The Question What will the average dwell times be at the 10 stops and how might they affect how the route is developed?

The Facts

- √ The route will use 42-seat buses,
- √ Exact fare is required on boarding,
- √ The door opening and closing time is 4 s,
- √ All passengers board through the front door and alight through the back door, and
- √ The transit agency has estimated potential ridership for the route and predicts the following average number of boarding and alighting passengers per stop.

Stop number	1	2	3	4	5	6	7	8	9	10
Alighting passengers	0	0	3	2	14	6	16	19	15	11
Boarding passengers	20	16	11	12	16	8	2	1	0	0

Comments

- √ Assume 3.0-s boarding time per passenger (3.5 s with standees), and
- √ Assume 2.0-s alighting time per passenger.

Outline of Solution All input parameters are known. Since there are two doors, one used by boarding passengers and the other by alighting passengers, boarding and alighting times will be calculated separately for each stop to determine which governs dwell time. The total number of passengers on board the bus will be tracked to determine the stops where standees will be present on the bus.

Steps

1. Determine the stops where the bus arrives with standees.	There will be more than 42 passengers on the bus when it arrives at Stops 4 to 7. The last passenger to board at Stop 3 will encounter a single standee, but this can be neglected.
2. Calculate the boarding time.	The boarding time is the number of boarding passengers times 3.0 or 3.5 s, depending on whether standees are present.
3. Calculate the alighting time.	The alighting time is the number of alighting passengers times 2.0 s.
4. Determine the dwell time.	The dwell time is the larger of the boarding and alighting times at each stop plus the 4-s door opening and closing time.

The Results Estimated dwell times are shown below for each stop:

Stop number	1	2	3	4	5	6	7	8	9	10
Dwell time (s)	64	52	37	46	60	32	36	42	34	26

Boarding times govern at Stops 1 to 7, and alighting times govern at Stops 8 to 10. Stop 8 is the critical bus stop for this route within the CBD area.

Because of the long dwell times at Stops 1 to 5 in the suburban portion of the corridor, off-line stops (pullouts) should be considered at these locations to avoid substantial traffic delays to other vehicles in the curb lane. At the same time, to minimize delays to the express buses reentering the arterial, transit priority treatments such as queue jumps should also be considered at these locations.

The dwell time at Stop 5 required to serve passenger movements is 60 s. However, since this stop is located at a transfer center, buses will likely need to occupy the berth for longer periods of time to allow for connections between routes. This extra berth occupancy time needs to be accounted for in sizing the transfer center.

Having standees on board a long-distance express bus is not desirable for quality of service; thus, increasing service frequency so that all riders may have a seat should be considered.

Mixed-traffic-lane bus vehicle capacity with near-side stops

EXAMPLE PROBLEM 2

The Situation A transit operator wants to consolidate its outbound downtown bus routes, which currently use several streets, onto a single three-lane one-way street with four signalized intersections.

The Question How will the street operate with the added buses?

The Facts

- √ Four signalized intersections;
- √ $g/C = 0.45$ on the one-way street at each of the four signalized intersections;
- √ Cycle length = 90.0 s at each signalized intersection;
- √ 40 buses per hour will use the street; all 40 are assumed to stop at each bus stop;
- √ Bus stops are located at each signal, none are located between signals;
- √ 1,200 automobiles per hour will also use the street, plus 40 buses;
- √ To reduce walking distances for passengers from the shelter to the bus door and thus minimize dwell times, the transit operator desires to limit the number of loading areas to two per stop;
- √ Near-side, on-line stops located at the four signalized intersections;
- √ No on-street parking, no grades, 3.6-m travel lanes; and
- √ Dwell times, curb lane automobile right-turn and through volumes, and conflicting pedestrian movements as follows.

Stop No.	Dwell Time (s)	Curb Lane Right-Turn Auto Volume (veh/h)	Curb Lane Through Auto Volume (veh/h)	Conflicting Ped Volume (p/h)
1	30	350	50	100
2	35	200	100	300
3	40	100	100	500
4	20	300	50	200

Comments

- √ Assume base saturation flow rate, s_0 , is 1,900 pc/h/ln (from Chapter 10);
- √ The computed bus blockage factor, f_{bb} , is 0.840 (from Exhibit 16-7 for a lane group with one lane and 40 buses per hour stopping);
- √ The heavy-vehicle factor, f_{HV} , is given in the summary table below (from Exhibit 16-7 and 40 buses, no trucks, per hour, and $E_T = 2.0$);
- √ The area factor is 0.90 for a CBD (from Exhibit 16-7);
- √ The bus stop location factor, f_l , is 0.9 (Type 2 lane, near-side stop), from Exhibit 27-15;
- √ For on-line stops, assume a 10-s clearance time (from Clearance Time section, Chapter 27);
- √ $Z_a = 1.440$ for 7.5 percent failure rate, from Exhibit 27-11;
- √ Assume 60 percent coefficient of variation of dwell times (from Coefficient of Variation of Dwell Times section, Chapter 27); and
- √ For two linear on-line loading areas, the number of effective loading areas, berths, N_{EB} , is 1.85, from Exhibit 27-12.

Outline of Solution All input parameters are known. The critical bus stop will determine the bus lane capacity. Because of the variety of dwell times, right-turn volumes, and conflicting pedestrian volumes, the critical stop is not immediately obvious. The vehicle capacity of each stop is found and then modified by the number of effective loading areas at each stop and the mixed-traffic interference factor. Note that the solution is based on operations in the rightmost (curb) lane. The adjustment factors related to bus blockage and heavy vehicles are computed solely on the basis of the curb lane.

Steps

<p>1. Calculate the right-turn saturation adjustment factor, f_{RT}, and the pedestrian adjustment factor for right-turn movements, f_{Rpb}, for each stop, using the procedures from Chapter 16, "Signalized Intersections."</p>	<p>For Stop 1: $f_{RT} = 1.0 - 0.15P_{RT}$ $f_{RT} = 1.0 - 0.15\left(\frac{350}{440}\right) = 0.881$ $f_{Rpb} = 0.948$ (from Chapter 16, Appendix D)</p>
<p>2. Calculate the right-turn lane capacity, c.</p>	<p>For Stop 1: $c = S_0(g/C)f_{bb} f_{HV} f_a f_{RT} f_{Rpb}$ $c = (1,900)(0.45)(0.840)(0.917)(0.90)(0.881)(0.948)$ $c = 495$ veh/h</p>
<p>3. Calculate the mixed-traffic interference factor (use Equation 27-16).</p>	<p>For Stop 1: $f_m = 1 - f_l\left(\frac{v}{c}\right)$ $f_m = 1 - 0.9\left(\frac{440}{495}\right)$ $f_m = 0.200$</p>
<p>4. Calculate the loading area capacity (use Equation 27-5).</p>	<p>For Stop 1: $B_{bb} = \frac{3,600\left(\frac{g}{C}\right)}{t_c + \left(\frac{g}{C}\right)t_d + Z_a c_v t_d}$ $B_{bb} = \frac{3,600(0.45)}{10 + (0.45)(30) + (1.44)(0.60)(30)}$ $B_{bb} = 33$ buses/h</p>
<p>5. Calculate the curb lane bus capacity at this bus stop (use Equation 27-17).</p>	<p>For Stop 1: $B = B_{bb} N_{eb} f_m$ $B = (33)(1.85)(0.200)$ $B = 12$ buses/h</p>

Summary table for all stops:

Stop No.	P_{RT}	f_{RT}	f_{Rpb}	f_{HV}	c	v	f_m	B_{bb}	B
1	0.795	0.881	0.948	0.917	495	440	0.200	33	12
2	0.588	0.912	0.898	0.894	473	340	0.353	29	19
3	0.417	0.938	0.883	0.857	459	240	0.529	26	25
4	0.769	0.885	0.908	0.907	471	390	0.255	45	21

The Results Although bus Stop 3 has the highest dwell time and the lowest individual loading area vehicle capacity, the curb lane bus capacity is actually greatest at this stop because right-turn interferences are greater at the other stops. The critical bus stop for determining the vehicle capacity is Stop 1. The capacity at Stop 1 is 12 buses per hour, which is insufficient to accommodate the proposed number of buses.

The simplest way, if space permits, to add capacity to a one- or two-berth bus stop is to add another berth. However, in this case, the transit operator desires to minimize pedestrian walking distances by limiting the number of loading areas to two. Another option is to increase the allowed failure rate; however, this option decreases schedule and headway reliability and should be avoided. Therefore, the analyst will need to evaluate other potential solutions. These solutions are the subject of subsequent example problems.

Mixed-traffic-lane bus vehicle capacity with far-side stops

EXAMPLE PROBLEM 3

The Situation The CBD street from Example Problem 2 is used. Having determined that a mixed-traffic lane with near-side stops will not provide sufficient capacity, the transit operator would like to try using far-side stops to avoid some of the right-turn interferences.

The Question How will the street operate under this scenario?

The Facts

√ Same assumptions as in Example Problem 2 except that stops are now far-side.

Outline of Solution As in Example Problem 2, all input parameters are known and the critical bus stop will determine the bus lane capacity. The only factor that changes is the location factor, f_l , which is 0.5 for a Type 2 mixed-traffic-lane with far-side stops as shown in Exhibit 27-15.

Summary table for all stops:

Stop No.	P_{RT}	f_{RT}	f_{Rpb}	f_{HV}	c	v	f_m	B_{bb}	B
1	0.795	0.881	0.948	0.917	495	440	0.556	33	34
2	0.588	0.912	0.898	0.894	473	340	0.641	29	34
3	0.417	0.938	0.883	0.857	459	240	0.739	26	36
4	0.769	0.885	0.908	0.907	471	390	0.586	45	49

The Results Bus lane vehicle capacity improves substantially as a result of using far-side stops but is still below the required value of 40 buses per hour. If only one stop was the constraint on capacity, a right-turn prohibition at that intersection might be considered, but in this case three of the four stops have insufficient vehicle capacity.

EXAMPLE PROBLEM 4

The Situation The CBD street from Example Problems 2 and 3 is used. The transit operator would next like to try a skip-stop operation to improve capacity.

Mixed-traffic-lane bus vehicle capacity with skip-stop operation

The Question How will the street operate under this scenario?

The Facts

- √ Same assumptions as in Example Problem 2; and
- √ Half of the buses will use A-pattern stops, which are the same ones used in Example Problem 3. The other half will use B-pattern stops in the alternate blocks. For this example, the critical B stop has the same characteristics as the critical A stop, Stop 1.

Comments

- √ Random bus arrivals are assumed,
- √ Automobile volumes in the left two lanes are assumed to be evenly distributed, and
- √ Adjustment factor K for random arrivals, from Exhibit 27-16, is 0.50.

Outline of Solution As in Example Problems 2 and 3, all input parameters are known. The critical A and B bus stops will determine the bus lane capacity. The v/c ratio of the adjacent lane is calculated to determine how well buses can use that lane to skip stops. The bus lane capacity will be the sum of the capacities of the A and B stop patterns times an adjustment factor for the effect of random bus arrivals and the impedance of other traffic in the adjacent lane. Note that there are no heavy vehicles other than buses skipping stops in two adjacent lanes. Thus, f_{HV} is 1.000.

Steps

1. Calculate the adjacent-lane capacity.	At Stop 1: $v = \left(\frac{1,200 - 350 - 50}{2} \right) = 400 \text{ veh/h/ln}$ $c = s_0(g/C)f_{HV} f_a$ $c = (1,900)(0.45)(1.000)(0.90) = 770 \text{ veh/h}$
2. Calculate the adjacent-lane impedance factor (use Equation 27-9).	At Stop 1: $a = 1 - 0.8 \left(\frac{v}{c} \right)^3$ $a = 1 - 0.8 \left(\frac{400}{770} \right)^3$ $a = 0.888$
3. Calculate the skip-stop adjustment factor (use Equation 27-8).	$f_k = \frac{1 + Ka(N_s - 1)}{N_s}$ $f_k = \frac{1 + (0.50)(0.888)(2 - 1)}{2}$ $f_k = 0.722$
4. The A-pattern bus lane capacity, from Example Problem 3, is 34 buses per hour. The B-pattern capacity is assumed to be the same. Calculate the total bus vehicle capacity of the street (use Equation 27-11).	$B = f_k(B_1 + B_2 + \dots + B_n)$ $B = 0.710 \text{ (at Stop 2)}(34 + 34)$ $B = 48 \text{ buses/h}$

The Results If skip stops are implemented and bus stops are placed on the far sides of intersections, there will be sufficient capacity for the proposed 40 buses per hour, with some excess capacity to accommodate more buses in the future.

EXAMPLE PROBLEM 5

Bus person capacity

The Situation The CBD street from Example Problems 2, 3, and 4 is used.

The Question How many persons can be carried at the maximum load point?

The Facts

- √ Same assumptions as in Example Problem 3;
- √ All buses are 43-passenger buses;
- √ Ten buses are express buses operating on freeways; the operator's policy is to not allow standees on these buses; and
- √ The remaining local buses allow standees.

Comments

- √ Assume maximum schedule loads for the local buses; a load factor of 1.50 is also assumed; and
- √ The peak-hour factor is 0.75.

Outline of Solution The person capacity at the maximum load point is equal to the bus vehicle capacity times the allowed passenger load per bus times the peak-hour factor. From Example Problem 4, the bus vehicle capacity is 48 buses per hour.

Steps

1. Calculate the bus person capacity at its maximum load point under the proposed operation.	$P = [(10 * 43) + (30 * 43 * 1.50)] * 0.75$ $P = 1,774 \text{ persons}$
2. Calculate the maximum bus person capacity at its maximum load point.	$P = [(10 * 43) + (48 * 43 * 1.50)] * 0.75$ $P = 2,645 \text{ persons}$

The Results Under the proposed operation, the street can carry 1,774 persons per hour in buses at its maximum load point. If the street's bus vehicle capacity of 48 buses per hour were to be scheduled, the person capacity would be 2,645 at the maximum load point.

EXAMPLE PROBLEM 6

The Situation The CBD street from Example Problems 2, 3, 4, and 5 is used.

The Question What will the average speed of buses be under the skip-stop scenario?

The Facts

- √ Same assumptions as in Example Problem 4, and
- √ Blocks are 125 m long.

Comments

- √ Since buses stop every two blocks, the stop frequency is $\frac{1}{2(0.125)} = 4.0$ stops/km.

Outline of Solution Buses operate in mixed traffic. The speed estimation procedure involves identifying the base bus running time using Exhibit 27-18 and additional running time losses for mixed-traffic operations using Exhibit 27-19. The estimated speed is adjusted to account for the inability of buses to fully utilize the additional potential speed gained from the skip-stop operations. Normally, speeds would be calculated for each skip-stop pattern. However, because both skip-stop patterns have the same capacity and the same volume, both patterns will operate at the same speed.

Steps

1. Identify the base bus running time (use Exhibit 27-18). The average dwell time for the four stops is 31.25 s, so interpolate between the 30-s and 40-s values.	$t_{r,0} = 4.24 \text{ min/km}$
2. Identify additional running time losses (use Exhibit 27-19). Because the v/c ratio of the bus lane is relatively high (0.833, from Example Problem 3), a value toward the higher end of the range is selected.	$t_{r,1} = 2.3 \text{ min/km}$
3. Calculate the skip-stop adjustment factor (use Equation 27-15). Average values for the v/c ratios of the bus lane and the adjacent lane are obtained from Example Problem 4.	$f_s = 1 - \left(\frac{L_1}{L_2} \right) \left(\frac{v}{c} \right)^2 \left(\frac{v_b}{c_b} \right)$ $f_s = 1 - \left(\frac{125}{250} \right) (0.406)^2 \left(\frac{40}{48} \right) = 0.931$
4. Calculate the bus travel speed (use Equation 27-14). Because the bus running speed accounts for time losses due to vehicle and bus interferences, f_b is set to 1.0.	$S_t = \left(\frac{60}{t_{r,0} + t_{r,1}} \right) f_s f_b$ $S_t = \left(\frac{60}{4.24 + 2.3} \right) (0.931)(1.0) = 8.5 \text{ km/h}$

The Results The average travel speed of buses operating in mixed traffic on this street will be 8.5 km/h. Speeds and capacity could be increased by implementing an exclusive bus lane and prohibiting right turns from the bus lane.

Maximum light rail capacity for on-street operation with signalized intersections and one- or three-car trains

EXAMPLE PROBLEM 7

The Situation A light rail line operates within a city street median through signalized intersections.

The Question What is the maximum passenger carrying capacity without limits on the total number of light rail cars in service?

The Facts

- √ Service is provided by single cars or by three-car trains, with each car 28 m long,
- √ Initial acceleration is 1.0 m/s²,
- √ Blocks are 135 m long,
- √ The g/C ratio is 0.50,
- √ The maximum cycle time at any one intersection is 90 s,
- √ The passenger dwell times are 35 s,
- √ The transit authority maintains a peak-hour loading service standard of five passengers per meter of car, and
- √ The peak-hour factor is 0.75.

Comments

- √ It is assumed that there are no single-track sections on the line and no limitations imposed by any signaled sections of the line,
- √ The coefficient of variation of dwell times is typically 0.40 for light rail operations, and
- √ Capacity typically occurs at 25 percent failure rate, $Z_a = 0.675$.

Outline of Solution The single-car and three-car train situations require different approaches. Each approach determines the maximum number of trains per hour, which is then multiplied by the train capacity.

Steps

(a) Single-car trains	
<p>1. Determine the total train clearance time including minimum separation between trains and the time for a train to clear the stop. The minimum spacing between trains is estimated at 20 s. The time for the train to clear a stop equals the train length divided by the average speed.</p>	$\sqrt{\frac{2(\text{train length})}{(\text{acceleration})}}$ $\sqrt{\frac{2(28 \text{ m})}{(1.0 \text{ m/s}^2)}} = 7.5 \text{ s}$ <p>Total train clearance time = 7.5 s + 20 s = 27.5 s</p>
<p>2. Determine the maximum number of trains per hour (use Equation 27-23). Because more than one one-car train can occupy a block or stop at the same time without blocking other vehicles, the traffic signal cycle time component of the equation is not considered. In transit operations, headways should be rounded up to an even interval of 1 h, in this case to 120 s or 2 min, equivalent to 30 trains per hour.</p>	$h_{os} = \frac{t_c + \left(\frac{g}{C}\right)t_d + Z_a C_v t_d}{\left(\frac{g}{C}\right)}$ $h_{os} = \frac{(27.5) + (0.5)(35) + (0.675)(0.4)(35)}{(0.5)}$ <p>$h_{os} = 108.9 \text{ s}$, round to 120 s $3,600/120 = 30 \text{ trains/h}$</p>

(b) Three-car trains	
3. Since a three-car train is 84 m long, only one train can fit in the 135-m block length. In this case the closest headway is twice the longest intersection cycle time of 90 s. This results in a 3-min headway, or 20 trains per hour.	$h_{os} = 2(90) = 180 \text{ s}$ $\frac{3,600}{180} = 20 \text{ trains/h}$
4. The final step is to multiply the number of trains per hour by their person capacity and the peak-hour factor.	$28 \frac{\text{m}}{\text{car}} * 5 \frac{\text{passengers}}{\text{m}} = \frac{140 \text{ passengers}}{\text{car}}$ <p>Single-car operation maximum person capacity:</p> $= \left(30 \frac{\text{trains}}{\text{h}} \right) \left(1 \frac{\text{car}}{\text{train}} \right) \left(140 \frac{\text{passengers}}{\text{car}} \right) (0.75)$ $= 3,150 \text{ passengers}$ <p>Three-car operation maximum person capacity:</p> $= \left(20 \frac{\text{trains}}{\text{h}} \right) \left(3 \frac{\text{car}}{\text{train}} \right) \left(140 \frac{\text{passengers}}{\text{car}} \right) (0.75)$ $= 6,300 \text{ passengers}$

The Results The one-car operation has a maximum capacity of 3,150 passengers, the three-car operation twice as much. The maximum capacity of three-car trains is effectively restricted to ensure that, in irregular operation, two bunched trains do not cause a backup that blocks an intersection.

V. REFERENCES

1. *Transit Capacity and Quality of Service Manual*. Transit Cooperative Research Program Web Document No. 6. TRB, National Research Council, Washington, D.C., 1999.
2. *Manual on Uniform Traffic Control Devices for Streets and Highways*. FHWA, U.S. Department of Transportation, 1988.
3. Robertson, H. D. (ed.). *Manual of Transportation Engineering Studies*. Institute of Transportation Engineers, Washington, D.C., 1994.
4. Garrity, R., and L. L. Eads. Bus Stop Accessibility: A Guide for Virginia Transit Systems and Public Entities for Complying with the Americans with Disabilities Act of 1990. In *Transportation Research Record 1390*, TRB, National Research Council, Washington, D.C., 1993.
5. Scheel, W., and J. E. Foote. *Bus Operation in Single Lane Platoons and Their Ventilation Needs for Operation in Tunnels*. Research Publication GMR-808. General Motors Research Laboratories, Warren, Mich., 1962.
6. Fitzpatrick, K., K. Hall, D. Perdinson, and L. Nowlin. *Guidelines for the Location and Design of Bus Stops*. Transit Cooperative Research Program Report 19. TRB, National Research Council, Washington, D.C., 1996.
7. Tri-County Metropolitan Transportation District of Oregon (Tri-Met). *Bus Stop and Passenger Amenities Guidelines*. Portland, Oreg., 1994.
8. Benn, H. P. *TCRP Synthesis 10: Bus Route Evaluation Standards*. TRB, National Research Council, Washington, D.C., 1995.

9. Danaher, A., T. Parkinson, P. Ryus, and L. Nowlin. Appendix to Interim Report: Literature Review. TCRP Project A-15: Development of Transit Capacity and Quality of Service Principles, Practices, and Procedures. Available on loan from Transit Cooperative Research Program, TRB, National Research Council, Washington, D.C., 1997.
10. St. Jacques, K., and H. S. Levinson. *TCRP Report 26: Operational Analysis of Bus Lanes on Arterials*. TRB, National Research Council, Washington, D.C., 1997.
11. Levinson, H. S. *INET Transit Travel Times Analysis*. UMTA, U.S. Department of Transportation, April 1982.
12. *Special Report 209: Highway Capacity Manual*. TRB, National Research Council, Washington, D.C., 1985.
13. Homburger, W. S. (ed.). *Transportation and Traffic Engineering Handbook*, 2nd ed. Prentice-Hall, Inc., Englewood Cliffs, N.J., 1982.
14. Kraft, W. H. *An Analysis of the Passenger Vehicle Interface of Street Transit Systems with Applications to Design Optimization*. Ph.D. dissertation. New Jersey Institute of Technology, Newark, 1975.
15. Kraft, W. H., and P. Eng-Wong. Passenger Service Time Characteristics of Street Transit Systems. In *Compendium of Technical Papers*, Institute of Transportation Engineers, 47th Annual Meeting, Mexico City, Mexico, 1977.
16. King, R. D. *Synthesis of Transit Practice 2: Low-Floor Transit Buses*. TRB, National Research Council, Washington, D.C., 1994.
17. Cuntill, M. A., and P. F. Watts. *Bus Boarding and Alighting Times*. Report LR 521. U.K. Transport and Road Research Laboratory, Crowthorne, England, 1973.
18. Atkinson, W. G. (ed.). *Canadian Transit Handbook*, 3rd ed. Canadian Urban Transit Association, Toronto, 1993.
19. Levinson, H. S., and K. R. St. Jacques. Bus Capacity Revisited. In *Transportation Research Record 1618*, TRB, National Research Council, Washington, D.C., 1998.
20. Pushkarev, B. S., J. M. Zupan, and R. Cumella. *Urban Rail in America: A Regional Plan Association Book*. Indiana University Press, Bloomington, Ind., 1982.
21. Kohler, V. Capacity of Transit Lanes. In *Proceedings of the International Symposium on Highway Capacity*, Karlsruhe, Germany, 1991.
22. Papacostas, C.S. Capacity Characteristics of Downtown Bus Streets. *Transportation Quarterly*, Vol. 36, No. 4, Oct. 1982, pp. 617–630.
23. St. Jacques, K. R., and H. S. Levinson. *Operational Analysis of Bus Lanes on Arterials: Extended Field Investigations*. TCRP Project A-7A Draft Final Report. TRB, National Research Council, Washington, D.C., 1999.
24. Parkinson, T., and I. Fisher. *TCRP Report 13: Rail Transit Capacity*. TRB, National Research Council, Washington, D.C., 1996.
25. Levinson, H. S. Capacity Concepts for Street-Running Light Rail Transit. In *Proceedings of the Second International Symposium on Highway Capacity*, Australian Road Research Board, Ltd., Sydney, Australia, 1994.

CHAPTER 28

ASSESSMENT OF MULTIPLE FACILITIES

CONTENTS

I. INTRODUCTION28-1
 Purpose28-1
 Organization28-1
 Scope28-1
 Terminology.....28-1
 II. SYSTEM PERFORMANCE MEASURES28-1
 Performance-Based Planning28-2
 System Performance Measurement28-2
 Quantity of Service28-3
 Intensity of Congestion28-3
 Duration of Congestion28-3
 Extent of Congestion28-3
 Variability28-3
 Accessibility28-3
 System Performance Report Card28-3
 III. REFERENCES28-4
 APPENDIX A. MEASUREMENTS OF TRAVELER PERCEPTIONS28-4
 Utility Equations28-4
 System LOS28-5

EXHIBITS

Exhibit 28-1. Example System Performance Report Card28-4

I. INTRODUCTION

This chapter presents a framework for analyzing areawide and corridor transportation systems with multiple facility types and multiple modes. Chapters 29 and 30 provide specific procedures for the analyses.

PURPOSE

The methodological framework for analyzing the performance of transportation systems is intended for application in major investment studies, air quality conformity studies, and in the development of congestion management programs and long-range transportation plans (LRTP).

ORGANIZATION

The chapter defines a structure for analyzing ground transportation systems in an area or a corridor and then develops performance measurements for transportation systems. Appendix A provides appropriate measures of traveler satisfaction and level-of-service (LOS) for systems.

SCOPE

This chapter is applicable to the analysis of multiple facilities of a multimodal ground transportation system in a defined area. The framework is limited to performance measures of mobility, computed through extensions of the procedures in earlier chapters. Other performance measures also may be valid but are not discussed, because the *Highway Capacity Manual* does not provide the basis for estimating them.

Methods for measuring traveler satisfaction are discussed, but the chapter does not recommend a letter-grade scale for characterizing the results. Because traveler satisfaction is strongly influenced by expectation, local agencies must determine their own standards.

TERMINOLOGY

Performance measures apply to system outcomes—for example, travel time or delay. They often are measures of traveler perception or satisfaction but are not limited to that.

Quality-of-service measures apply to the traveler's perceived satisfaction with their trip. They are a subset of the set of all performance measures.

Service measures are quality-of-service measures used by the *Highway Capacity Manual* and assigned a letter grade of A through F. LOS measures are a subset of quality-of-service measures.

Utility is an ordinal measure of how a traveler values trip choice. A higher value of utility for one option over another indicates the traveler's preference.

Traveler satisfaction, however, differs from utility. Satisfaction means that the quality of the trip has met the needs and desires of the traveler.

A corridor is characterized by a set of generally parallel transportation facilities designed to move people between two points; this distinguishes it from a general analysis area. For example, a freeway corridor may consist of a freeway and one or more parallel arterial streets; there also may be rail or bus transit service on either or both the freeway and the arterial, or on a separate right-of-way.

Traveler satisfaction

Corridors

II. SYSTEM PERFORMANCE MEASURES

Performance measures for areawide and corridor analysis of transportation systems typically are selected as part of the performance-based planning process.

PERFORMANCE-BASED PLANNING

Performance-based planning relates agency planning and project implementation to public benefits. Its intent is to go beyond the simple measurement of agency output—such as number of kilometers of road constructed—to measure agency performance in terms of outcomes—such as improvements in travel time. One difficulty is that outcomes usually depend on factors external to the agency’s actions. However, the ability to relate agency activities to the accomplishment of public goals has made performance-based planning a valuable tool for communicating agency accomplishments to public policy makers.

Basic public goals adopted by policy makers and planning agencies fall into three categories: efficiency, effectiveness, and externalities (1). Efficiency relates to the utilization of system capacity; a typical performance measure is the ratio of demand to capacity. Effectiveness relates to user perception of the value of the trip; typical performance measures include the proportion of the population served and the cost per trip or ton moved. Externalities relate to the environmental impacts of the system; typical performance measures are vehicle emissions, noise, and accident rates.

The estimation and application of performance measures to the agency’s goals of efficiency and effectiveness are described here. Some procedures in this manual, however, also may provide inputs for calculating performance measures related to externalities.

Analysis of a transportation system starts with estimates of travel times and delays at the segment and point levels, using the methods described in Part III. Segment and point delays and travel times then are converted to total person-hours of delay or travel time and added together to obtain facility estimates. The sum of the facility estimates yields subsystem estimates. Mean delays or trip times for each subsystem are then computed by dividing the total person-hours by the total number of trips on the subsystem. Subsystem estimates of travel time and delay can be combined into total system estimates, but typically the results for each subsystem are reported separately. Equation 28-1 shows the aggregation of point and segment results to obtain an estimate of mean subsystem delay.

$$D_m = \frac{\sum_{x,p} (D_x T_x + D_p T_p)}{\sum_{x,p} (T_x + T_p)} \quad (28-1)$$

where

- D_m = delay per person-trip for the modal subsystem,
- D_x = delay per person-trip for Segment x,
- D_p = delay per person-trip for Point p,
- T_x = number of person-trips using Segment x, and
- T_p = number of person-trips using Point p.

The delay, speed, and travel time for segments and points are estimated using the appropriate methods described in Part III of this manual.

SYSTEM PERFORMANCE MEASUREMENT

System performance must be measured in more than one dimension. When analyzing a single intersection, it may suffice to compute only the peak-period delay; however, when analyzing a system, one also must deal with the geographic extent, the duration of delay, and any shifts in demand among facilities and modes (2).

System performance should be measured in the following dimensions:

- Quantity of service—the number of person-kilometers and person-hours produced by the system;
- Intensity of congestion—the maximum amount of congestion expressed in terms of total delay;
- Extent of congestion—the physical length of the congested system;

Results of analyses of segments and points are converted to person-hours of delay or travel time and aggregated to system levels

Dimensions of system performance

- Duration of congestion—the number of hours that congestion persists;
- Variability—the day-to-day variation in the measures; and
- Accessibility—the percentage of the populace able to complete a selected trip within a specified time.

Quantity of Service

Quantity of service measures the utilization of the transportation system, in terms of both the number of people and the distance they are conveyed (person-kilometers of travel, PkmT), and the amount of time required to convey them (person-hours of travel, PHT). Dividing the PkmT by the PHT gives the mean trip speed for the system.

Intensity of Congestion

The intensity of congestion is measured using the total number of person-hours of delay and mean trip speed. Other indices, such as mean delay per person-trip, can be used to measure the intensity of congestion.

Duration of Congestion

The duration of congestion is measured in terms of the maximum amount of time that congestion occurs anywhere in the system. A segment is congested if the demand exceeds the segment's discharge capacity. Transit subsystem congestion can occur either when the passenger demand exceeds the capacity of the transit vehicles or when the need to move transit vehicles exceeds the vehicular capacity of the transit facility.

Extent of Congestion

The extent of congestion is measured in terms of the maximum physical extent of congestion on the system at any one time. It may be expressed in terms of the number of directional kilometers of facilities congested or—more meaningfully for the general public—in terms of the maximum percentage of system kilometers congested at any one time.

Variability

Variability ideally should be measured in terms of the probability of occurrence or as a confidence interval for the other measures of congestion (intensity, duration, and extent). However, the state of the art does not yet facilitate such a calculation. Instead, a measure of the sensitivity of the results to changes in the demand can be substituted, until better methods for estimating variability become available. Various levels of demand are tested (such as a 5 percent increase or a 5 percent decrease) and the resulting effects on the intensity, duration, and extent of congestion are noted in terms of a percentage increase or decrease in their values. The sensitivity can be expressed in terms of an elasticity, by dividing the percentage change in output by the percentage change in demand. An elasticity greater than 1.0 means the estimated congestion measure is highly sensitive to changes in demand.

Accessibility

Accessibility examines the effectiveness of the system from a perspective other than intensity. Accessibility is expressed in terms of the percentage of trips (or persons) able to accomplish a certain goal—such as going from home to work—within a targeted travel time. Accessibility is particularly useful for assessing the quality of service for transit subsystems (3).

SYSTEM PERFORMANCE REPORT CARD

Exhibit 28-1 shows the setup of a typical report card for reporting system performance.

EXHIBIT 28-1. EXAMPLE SYSTEM PERFORMANCE REPORT CARD

Subsystem	Freeway	Urban Street	Rural Highway	Transit	Pedestrian	Bicycle
Quantity						
Distance (PkmT)						
Time (PHT)						
Intensity						
Delay (p-h)						
Speed (km/h)						
Duration (h)						
Extent (km)						
Variability						
Delay						
Duration						
Extent						
Accessibility						

III. REFERENCES

1. *Multimodal Transportation: Development of a Performance-Based Planning Process*. NCHRP Research Results Digest No. 226, TRB, National Research Council, Washington, D.C., July 1998.
2. Lomax, T., S. Turner, G. Shunk, H. S. Levinson, R. H. Pratt, P. N. Bay, and G. B. Douglas. *NCHRP Report 398: Quantifying Congestion*. TRB, National Research Council, Washington, D.C., 1997.
3. *Transit Capacity and Quality of Service Manual*. Transit Cooperative Research Program Project A-15, TCRP Web Document No. 6, TRB, National Research Council, Washington, D.C., 1999.

APPENDIX A. MEASUREMENTS OF TRAVELER PERCEPTIONS

Quality-of-service measures, which indicate the degree of traveler satisfaction with system performance, are a subset of the set of performance measures described in this chapter (I).

Part III of this manual identifies various measures for traveler perceptions of performance, designed for individual points, segments, or single facilities. The measures compare traveler satisfaction for various levels of service when there are no other alternative routes. For example, a driver committed to a particular freeway will tend to prefer less dense conditions to more dense conditions. However, this is no longer true if the driver might choose a parallel frontage road instead. Generally, the driver will choose the facility that allows the highest speed of travel, even if the freeway has more dense traffic conditions than the parallel, lightly used frontage road. The driver's choice of route indicates a preference for—and a higher degree of satisfaction with—the conditions. A freeway operating at LOS B will be preferred over a lower-speed frontage road operating at LOS A.

UTILITY EQUATIONS

However, a more comprehensive measure of traveler satisfaction is needed for evaluating transportation systems. Utility models derived from microeconomic consumer

behavior theory provide a tested and comprehensive multimodal method for evaluating traveler preferences and satisfaction with different travel choices (2). Utility equations have been used in most metropolitan areas of the United States to predict traveler preferences for different modes of travel. The utility equations identify which combinations of travel times and costs on different modes provide the most value or utility to the traveler.

Utility equations are mathematical functions whose numerical values depend on the attributes of the options and on the characteristics of the traveler. The utility function with the greater numerical value indicates the individual's preference.

Equation A28-1 is a utility function that can be used as a default if there is no locally developed and calibrated utility function (3, 4).

$$Utility = -0.025 * IVT - 0.050 * OVT - 0.005 * Cost \quad (A28-1)$$

where

- Utility* = measure of the traveler's perceived value of an alternative,
- IVT* = in-vehicle time (min),
- OVT* = out-of-vehicle travel time (min), and
- Cost* = out-of-pocket cost for trip (cents).

As indicated by this utility equation, travel time and cost are the two factors that explain the majority of traveler behavior (5). This particular equation, however, does not include other factors also known to influence traveler behavior—such as reliability, security, comfort, and scenery. These other factors can be included in a locally calibrated utility equation. More elaborate utility equations designed for the analysis of transit benefits and intermodal passenger transfer facilities also are available (6, 7).

Nonetheless, there is no intrinsic meaning to the value generated by the utility function. Utility is an index of customer satisfaction, not a measure of the absolute amount of satisfaction. From a comparison of utility indices, it can be determined which option the traveler prefers, but not that the traveler is actually satisfied.

The proportion of travelers preferring one transportation alternative over another is computed according to Equation A28-2.

$$P_a = \frac{e^{U_a}}{\sum_j e^{U_j}} \quad (A28-2)$$

where

- P_a = proportion of travelers preferring Option a,
- U_a = utility function valued for Option a, and
- U_j = utility function valued for Option j.

This proportion P_a also can be thought of as the probability that Alternative a will be preferred over all other Alternatives j.

SYSTEM LOS

LOS grades convey to the public the general quality of service provided by the transportation system. Numerical results—such as the number of seconds of delay—are translated into a letter grade of A through F to indicate whether or not the traveler would consider the quality of service satisfactory.

Assigning LOS grades to system operations requires an absolute measure of traveler satisfaction. However, consumer behavior theory is based on the concept that traveler satisfaction is relative, not absolute.

The degree to which travelers are satisfied with a particular travel experience depends on the options they think are available and on their perception of their own experience. For example, residents in rural areas frequently are dissatisfied with travel conditions acceptable to an urban resident. Travelers also are known to build up

Utility equations

Utility is useful for comparing alternatives but not for reflecting absolute levels of satisfaction

tolerances for congestion. A certain level of congestion still may result in a satisfactory travel experience, if it was better than on the day before. Transit riders tolerate delays better than automobile drivers.

No fixed set of values of travel time, speed, delay, or any other measure can ensure a certain percentage of traveler satisfaction with system operations. It can be said only that travelers will prefer one option over another. No single set of quality-of-service threshold values for transportation systems can be expected to apply equally to all geographic regions for all times. Each region's tolerance for congestion must be measured locally. For these reasons, no recommendations are made here for any specific thresholds of travel time, speed, or delay for determining systemwide quality of service. Local agencies should develop their own goals and quality-of-service targets.

REFERENCES

1. Meyer, M. *Alternative Performance Measures for Transportation Planning: Evolution Toward Multi-Modal Planning*. Report #FTA-GA-26-7000-95-1, Federal Transit Administration, Washington, D.C., 1995.
2. Henderson, J. M., and R. E. Quandt. *Microeconomic Theory: A Mathematical Approach*. McGraw-Hill Book Company, New York, N.Y., 1971.
3. Sosslau, A. B., A. B. Hassam, M. M. Carter, and G. V. Wickstrom. *NCHRP Report 187: Quick-Response Urban Travel Estimation Techniques and Transferable Parameters: User's Guide*. TRB, National Research Council, Washington, D.C., 1978.
4. Martin, W. A., and N. A. McGuckin. *Travel Estimation Techniques for Urban Planning*. Barton Aschman Associates, Washington, D.C., January 1996.
5. Ortuzar, J. D., and L. G. Willumsen. *Modeling Transport*, 2nd ed. John Wiley & Sons, New York, N.Y., 1994.
6. Beimborn, E. *Measurement of Transit Benefits*. FTA-WI-11-0013-93-1, Federal Transit Administration, Washington, D.C., 1993.
7. Horowitz, A. J., and A. Thompson. *Evaluation of Intermodal Passenger Transfer Facilities*. Final Report, DOT-T-95-02, Federal Highway Administration, Washington, D.C., 1995.

CHAPTER 29

CORRIDOR ANALYSIS

CONTENTS

I. INTRODUCTION29-1

 Purpose 29-1

 Organization 29-1

 Scope 29-1

 Limitations 29-1

 Terminology 29-2

II. METHODOLOGY 29-2

 Highway Corridor Facilities 29-3

 Assembling Input Data 29-3

 Determining Segment Capacity 29-4

 Adjustment for Excess Demand 29-5

 Gate-Tree-Building Algorithm 29-5

 Demand-Adjustment Algorithm 29-5

 Determining Segment Free-Flow Traversal Times 29-6

 Determining Segment Traversal Times 29-6

 Determining Queue Delay 29-6

 Subperiod Analysis 29-7

 Determining Performance Measures 29-7

 Intensity 29-7

 Duration 29-8

 Extent 29-9

 Variability 29-9

 Accessibility 29-9

 Transit and Highway Corridors 29-10

 Assembling Input Data 29-10

 Determining Bus-Stop Capacity 29-10

 Determining Transit Segment Capacity 29-10

 Bus 29-10

 Rail 29-11

 Determining Transit Speeds 29-11

 Bus 29-11

 Rail 29-11

 Estimating Transit Travel Time and Delay 29-11

 Evaluating Transit Priority Treatments 29-12

III. EXAMPLE PROBLEM 29-12

 Corridor with Freeway, Parallel Arterial, and Bus 29-12

 Outline of Solution 29-12

 Assembling Input Data 29-13

 Determining Segment Capacity 29-14

 Adjusting for Excess Demand 29-14

 Determining Segment FFS Traversal Times 29-18

 Determining Segment Traversal Times 29-18

 Determining Queue Delay 29-18

 Determining Performance Measures 29-20

 Transit Subsystem Analysis 29-20

 Corridor Performance Report Card 29-24

 Interpretation of Results 29-26

IV. REFERENCES	29-26
APPENDIX A. O-D MATRIX ESTIMATION	29-26
Introduction	29-26
Assembling Input Data	29-27
Estimating Freeway O-D Matrix	29-27
Identifying Gates and Internal Zones	29-28
Estimating Internal Trip Generation	29-28
Estimating Origins and Destinations	29-28
Estimating the Corridor O-D Matrix	29-28
Applying the O-D Procedure	29-29
Longer Corridors	29-31

EXHIBITS

Exhibit 29-1. Typical Corridor Components	29-2
Exhibit 29-2. Definitions of Facility Types	29-3
Exhibit 29-3. Sample Division of Corridor into Segments and Points	29-4
Exhibit 29-4. Chapter References for Capacity, Speed, and Delay Analyses	29-4
Exhibit 29-5. Queue Polygon for Time Period T	29-7
Exhibit 29-6. Queue Density Defaults	29-9
Exhibit 29-7. Default Values for Estimating Bus-Stop Capacity	29-10
Exhibit A29-1. O-D Synthesis Example Corridor	29-27
Exhibit A29-2. Example One-Direction Freeway O-D Table Setup	29-28
Exhibit A29-3. Traffic Counts (veh/h)	29-29
Exhibit A29-4. Internal Zone Trip Generation	29-29
Exhibit A29-5. Trip Rates	29-29
Exhibit A29-6. Gate and Zone Totals	29-30
Exhibit A29-7. Freeway Trips by Ramp Counts	29-30
Exhibit A29-8. Corridor Trip Table	29-31
Exhibit A29-9. First Iteration (Balance Columns)	29-31
Exhibit A29-10. Second Iteration (Balance Rows)	29-31

I. INTRODUCTION

This chapter provides guidance for analyzing multimodal transportation corridors using the point, segment, and facility methodologies described in the Part III chapters.

PURPOSE

Procedures for combining individual facility, segment, and point analyses into estimates of overall corridor performance measures of travel time, speed, and delay for each mode of travel are described in this section. These procedures are useful for major investment studies and other planning studies of alternatives for multimodal corridor improvements.

ORGANIZATION

First, an overview of the methodology is provided. Procedures are then presented for the highway subsystems (freeway, rural or two-lane highway, and arterial or urban street), and for transit. An origin-destination (O-D) matrix, or trip table, estimation procedure is provided in the appendix.

SCOPE

This chapter is applicable to the analysis of multifacility and multimodal corridors, accounting for the interaction between parallel facilities that compete in serving trips between a pair of locations.

LIMITATIONS

The operations analyses described here are presumed to be part of a larger demand forecasting procedure that will reevaluate the demands for each parallel facility in response to the predicted operating conditions. These procedures assume that the demand is temporarily fixed, allowing the computation of facility operations. The operations results then are used in the demand forecasting process and the facility demands are reestimated.

The procedures are designed for detailed analyses of corridors. Their input data requirements tend to become intractable for large study areas involving thousands of segments and points. Chapter 30, "Areawide Analysis," presents less data-intensive procedures for analyzing large study areas.

To maintain a tractable procedure for analyzing multiple facilities and their interface, the recommended procedure for the analysis of a freeway facility within a corridor deviates from the Chapter 22 freeway facility analysis as follows.

1. A 1-h analysis period is used instead of 15 min and the analysis period is not shortened to 1-min periods in the presence of congestion.
2. Short freeway segments with a distance of less than 900 m between an on-ramp and off-ramp that do not qualify as a weaving segment are split in halves—one merge and one diverge segment—rather than analyzing each segment twice—once as a merge and a second time as a diverge segment—and adopting the most conservative result.
3. Queues are not propagated upstream from a bottleneck and are not used to reduce upstream capacities. The queues are assumed to be stored entirely on the bottleneck segment and all delay associated with them is assigned to the segment. Consequently, the corridor analysis procedure produces less reliable performance results for the freeway facility than the Chapter 22 analysis procedure. However, this is appropriate for a planning application.

The corridor analysis procedure should be used only if congestion is considered likely on one or more of the corridor facilities. The procedure then can track some of the interfacility effects of the congestion. If traffic queues are likely to affect upstream facility operation significantly, then microsimulation analysis should be considered, rather than the procedures described here.

Demand is assumed to be fixed

Differences from Chapter 22 in analyzing a freeway facility as part of a corridor

Queues are assumed to be stored entirely within the bottleneck segment

The methods in this chapter are appropriate only for planning that anticipates moderate levels of congestion

Corridor, segment, and point

In the absence of congestion in a corridor, each facility operates essentially independently and can best be analyzed separately using the facility-specific procedures described in Part III.

TERMINOLOGY

A corridor is a set of essentially parallel and competing facilities and modes with cross-connectors that serve trips between two designated points (see Exhibit 29-1). A corridor contains several subsystems of facilities—freeway, rural highway (also called two-lane highway), arterial (also called urban street), transit, pedestrian, and bicycle. Each subsystem is composed of one or more facilities that in turn are composed of segments and points. The procedure requires the division of the facilities within each corridor into subsections, or segments, with points at the end of each segment. Traffic demand and capacity conditions are relatively constant over the length of a segment. Points are places where traffic enters, leaves, or crosses the facility, such as intersections or ramp merges.

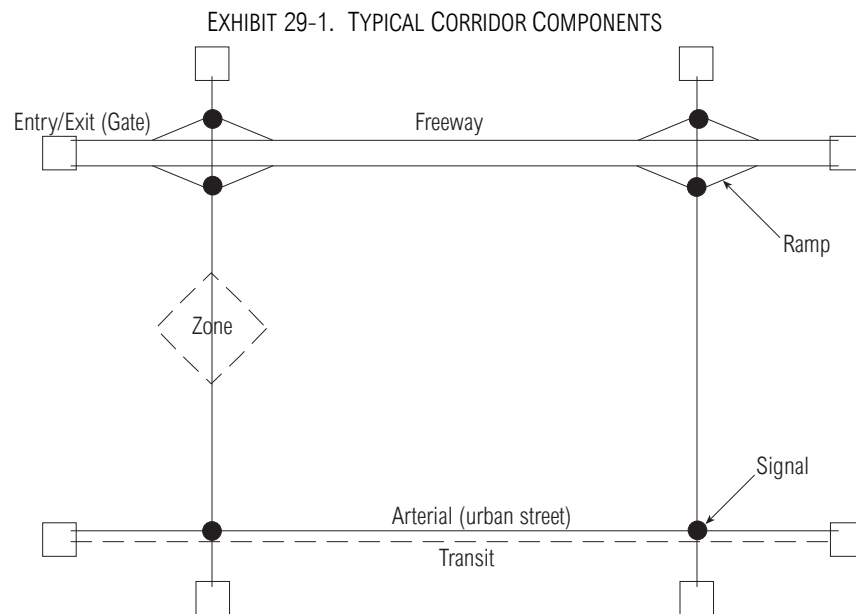

The physical features used to define segments and points vary by facility type. Each segment has one point downstream and one upstream.

Points are treated as having zero length, for the purpose of calculating segment speeds. However, even though an intersection or ramp junction can influence flow conditions for some distance upstream and downstream of the intersection or junction, all delay associated with a point is treated as happening at the point for computational purposes.

Gates and zones

The points at which major facilities cross the boundary of the corridor are called gates. Land uses that generate trips within the corridor may be geographically aggregated into internal zones to simplify the forecasting of traffic demands.

II. METHODOLOGY

The recommended procedures for evaluating a corridor involve the evaluation of facility segments and points in each direction over several subperiods of the analysis

period. The directional segment and point results for each subperiod are added together to obtain the corridor performance statistics.

The procedures rely on the methodologies presented in Part III of this manual. The segment analysis procedures are first used to estimate segment capacities. These segment capacities are compared with the forecast demand. Excess demand must be stored on the segment and carried over to later time periods. The stored demand also is used to reduce predicted downstream demands. Queues that overflow the storage capacity of the segment are not propagated to upstream segments. A queue delay is calculated for each queue identified. The adjusted segment demands are then used to estimate segment free-flow speeds, congested speeds, and intersection delays. The queue delays, intersection delays, and segment speeds are then combined to yield overall estimates of corridor travel time, speed, and delay.

The procedures assume that the demand is already known and has been assigned to the appropriate segments within the corridor, based on the relative travel times via each segment. In a corridor, it is normal for the demand to change routes based on changes in the travel times on parallel facilities. An O-D matrix estimation procedure is provided in Appendix A to assist in recomputing the segment demands—usually by reassigning the O-D matrix to the transportation network—based on the results of the corridor analysis. The O-D matrix is also useful in computing some corridor performance measures that require data on total trips and mean trip length.

See Appendix A for a method to re-allocate O-Ds among facilities in the corridor based on results of the analysis

HIGHWAY CORRIDOR FACILITIES

This section presents the recommended procedures for estimating speed, travel time, and delay (*I*) on the automobile and truck facilities in the corridor (freeway, rural highways, and arterials).

Assembling Input Data

Demand data are required for each segment in each time subperiod to be analyzed. The total analysis period is usually the peak period spanning the time from just before the start of congestion (or oversaturation) in the corridor to the time just after the clearance of all queues in the corridor. The total analysis period may be only 1 h or may span 3 or 4 h or more on a typical weekday. The peak period is divided into convenient subperiods, usually 15 min or 60 min.

Analysis should cover all periods of congestion

As in each of the Part III methods, signal timing and road geometry data also are required. Each facility in the corridor must be identified and divided into segments and points. Exhibit 29-2 identifies facility types. Segments are stretches of a facility in which the traffic demand and capacity conditions are relatively constant. Points are locations at the beginning and end of each segment, at which traffic enters, leaves, or crosses the facility. The physical definitions of segments and points vary by facility type. Exhibit 29-3 shows a typical division of corridor facilities into segments and points. Although no analysis is performed at the freeway ramp merge and diverge points, they also are numbered to facilitate identification of freeway segments.

EXHIBIT 29-2. DEFINITIONS OF FACILITY TYPES

Facility Type	Definition
Freeway	A completely access-controlled facility. See Chapter 22, "Freeway Facilities," for guidance on identifying basic, ramp merge and diverge, and weaving segments.
Ramp	Access roads to freeways; normally, each ramp is a single segment. See Chapter 25, "Ramps and Ramp Junctions."
Multilane Highway	A road with two or more lanes in one direction and traffic signals spaced no closer than 3.0 km. See Chapter 21, "Multilane Highways."
Two-Lane Highway	A road with only one lane in each direction and traffic signals spaced no closer than 3.0 km. See Chapter 20, "Two-Lane Highways."
Urban Street	Roads with traffic signals spaced no farther than 3.0 km apart. See Chapter 15, "Urban Streets."

EXHIBIT 29-3. SAMPLE DIVISION OF CORRIDOR INTO SEGMENTS AND POINTS

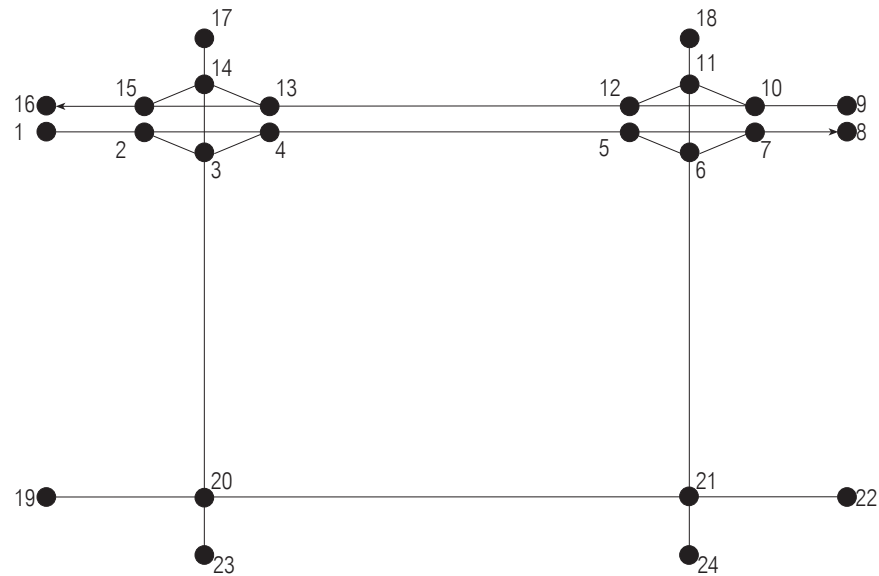

Determining Segment Capacity

The directional capacity of each segment of each facility in the corridor is computed for each hour of the analysis period. It is best if capacity can be measured in the field. In the absence of field data, the hourly capacities of each segment can be computed according to the methodologies described in Part III (see Exhibit 29-4).

EXHIBIT 29-4. CHAPTER REFERENCES FOR CAPACITY, SPEED, AND DELAY ANALYSES

Facility Type	Chapter Reference
Freeway segments	Chapter 22, "Freeway Facilities" Chapter 23, "Basic Freeway Segments" Chapter 24, "Freeway Weaving"
Rural highway segments	Chapter 25, "Ramps and Ramp Junctions"
Freeway on-ramp segments	Chapter 21, "Multilane Highways," and 20, "Two-Lane Highways"
Freeway off-ramp segments	Chapter 25, "Ramps and Ramp Junctions"
Urban streets with signalized intersections	Chapter 16, "Signalized Intersections," and Chapter 15, "Urban Streets"
For arterials with unsignalized intersections with stop or roundabout controls that affect arterial speeds	Chapter 17, "Unsignalized Intersections"

Capacity in terms of passenger cars must be converted to mixed vehicle capacity to yield actual demands rather than adjusted demands

Capacities specified in terms of passenger cars must be converted to actual mixed-vehicle capacities, because the procedure shifts demand between segments and time periods; passenger-car equivalents can take on different values in different time periods or segments, so shifting them should be avoided. Capacities are converted to mixed vehicle capacities by applying the inverse of the demand adjustment factors recommended in Part III to the base capacity. For example, the flow rate for basic freeway segments divided by the heavy-vehicle factor yields a passenger-car equivalent flow rate. The mixed-vehicle capacity, however, is determined by multiplying the capacity by the heavy-vehicle factor.

Adjustment for Excess Demand

Adjusting for excess demand is necessary only if working with forecasted or estimated demands rather than counted traffic volumes (the volume counted at any given point is by definition equal to or less than the discharge capacity at that point).

In this step, the demand is compared with the discharge capacity for each subperiod (usually 1 h) within the peak period and for each segment within the corridor. If the demand exceeds the capacity at any point in time or space, then the excess demand must be stored on the segment and carried over to the following hour. The downstream demands are reduced by the amount of excess demand stored on the segment.

The algorithm starts with the entry gate segments on the periphery of the corridor and works inward until all segment demands have been checked against their capacity. Before applying the demand adjustment algorithm it is necessary to develop organized lists of segments to be checked in the corridor. This is called building a gate tree.

Gate-Tree-Building Algorithm

A gate tree is a list of segments connected to the entry gate. Each segment in the list is ranked by the number of segments separating it from the entry segment. For example, the entry gate segment is given a rank of 1. The list is called a tree because it often looks like one when mapped onto the corridor.

The gate-tree-building algorithm is a variation of the commonly used shortest-path-finding algorithm (2). A tree of connected segments is built up from a starting segment. The steps used in this process are listed below (refer to Exhibit 29-3).

1. Start with a gateway segment entering the study area (for example, segment 1, 2 on the eastbound freeway). This segment is assigned a rank, $r = 1$.
2. Identify connecting downstream segment(s). These segments are assigned the rank, $r = \text{upstream segment rank} + 1$.
3. Add to the tree the segment that has highest volume to capacity (v/c) ratio among the unused connecting segments. U-turns at points (also termed nodes) are not allowed.
4. Repeat Steps 2 through 3 until there are no unused connecting segments.
5. Repeat Steps 1 through 4 for all entering gateway segments.
6. Save the tree list for each entry gate.

Demand-Adjustment Algorithm

The following steps are used to adjust demand when excess demand occurs in a time period.

1. Select the entry gate segment (of rank $r = 1$) with the highest v/c ratio.
2. Select the first time period.
3. If demand \leq capacity and the initial queue, $Queue(0) = 0$, go to Step 7.
4. If demand $>$ capacity or $Queue(0) > 0$, then use Equation 29-1.

$$Queue(l, h) = Queue(0) + demand - capacity \quad (29-1)$$

where

- l = segment index,
- h = time period index, and
- $Queue(0)$ = queue remaining from the preceding time period.

5. Reduce downstream segment demand by the amount that the demand exceeds the capacity. Propagate this reduction to all connecting downstream segments in proportion to the ratio of each downstream segment demand to all segments exiting from the subject segment. Continue the process downstream until the reduction is less than 5 percent of capacity.

6. Add the excess demand—the amount by which the demand exceeds the capacity—to the next time period demand for the subject segment.

Gate tree

7. Apply the increment to the next time period. Repeat Steps 3 through 6 until the processes for all the time periods are finished.
8. Go to next gate tree with unanalyzed segments in current Rank r. Repeat Steps 2 through 7 until all segments of current rank r have been analyzed.
9. Apply the increment to current Rank r + 1. Go to the segment with the highest v/c ratio among those of the new rank. Repeat Steps 2 through 8 until all segments are analyzed.

Determining Segment Free-Flow Traversal Times

The segment free-flow traversal times are obtained by dividing the length of the segment by the estimated free-flow speed (FFS), as shown in Equation 29-2. The FFS is computed according to the Part III methods using the adjusted demands determined in the previous step. The computation is repeated for each direction of each segment for each time subperiod.

$$R_f(d,l,h) = \frac{L(l)}{S_f(d,l,h)} \tag{29-2}$$

where

- $R_f(d,l,h)$ = segment free-flow traversal time for Direction d of Segment l and Time Period h (h),
- $L(l)$ = length of segment (km), and
- $S_f(d,l,h)$ = segment free-flow speed computed per Part III (km/h).

Determining Segment Traversal Times

The segment traversal times are obtained by dividing the length of the segment by the estimated mean speed (Equation 29-3). The mean speed is computed according to the Part III methods using the adjusted demands determined from the algorithm.

$$R(d,l,h) = \frac{L(l)}{S(d,l,h)} \tag{29-3}$$

where

- $R(d,l,h)$ = segment traversal time for Direction d of Segment l and Time Period h (h),
- $L(l)$ = length of segment (km), and
- $S(d,l,h)$ = mean segment speed computed per Part III (km/h).

The Part III signalized and unsignalized intersection delay estimation procedures take into account delays caused by demand both less than and greater than capacity, but since all demands have been adjusted to be less than capacity in an earlier step, in this step it is only necessary to compute the portion of the queue delay due to demand exceeding capacity.

Determining Queue Delay

The queuing delay—only the amount due to demand exceeding capacity—is computed for all segments. The queuing delay is computed for each direction (d) of each segment (l) and time period (h), using Equation 29-4 only when demand is greater than capacity.

$$DQ(d,l,h) = \frac{T}{2} * Q(d,l,h - 1) + [v(d,l,h) - c(d,l,h)] * \frac{T^2}{2} \tag{29-4}$$

where

- $DQ(d,l,h)$ = total delay due to excess demand (veh-h) for direction (d), segment (l), and time period (h);
- T = duration of time subperiod (h);

Segment traversal time plus queue delay equals segment travel time

Previous demand adjustments result in all demands ≤ capacity. Queue delay is handled separately.

$Q(d,l,h-1)$ = queue left over at end of previous time period (veh);
 $v(d,l,h)$ = demand rate for current time period (veh/h); and
 $c(d,l,h)$ = capacity of segment in subject direction (veh/h).

This equation assumes that the demand rate (v) is constant within the time period, as shown in Exhibit 29-5.

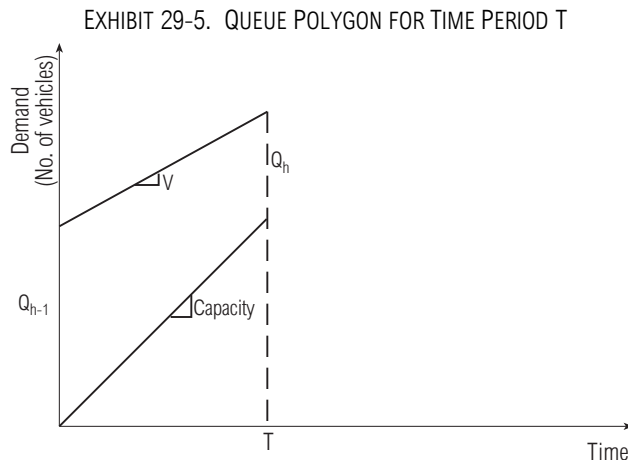

Subperiod Analysis

The steps are repeated for any additional time periods to be analyzed. For example, if the peak period lasts for 4 hours, it might be divided into four 1-h periods (or 16 quarter-hour periods), with each time period analyzed in sequence. The first and the last analysis periods must be uncongested for all delay to be included in the performance measures. Once all time periods have been analyzed, the performance measures are computed.

Determining Performance Measures

This step describes how to compute performance measures of congestion intensity, duration, extent, variability, and accessibility for the corridor.

Intensity

The possible performance measures for the intensity of congestion on the highway subsystems (freeway, two-lane highway, and arterial) in the corridor are computed from one or more of the following: person-hours of travel, person-hours of delay, mean trip speed, and mean trip delay. If average vehicle occupancy (AVO) data are not available, then the performance measures are computed in terms of vehicle-hours rather than person-hours.

The total person-hours of travel (PHT) are computed with Equation 29-5. The delays and traversal time for each segment and time period are summed and factored by the AVO to obtain the overall corridor total person-hours of travel.

$$PHT = AVO * \sum_{d,l,h} [v(d,l,h) * R(d,l,h) + DQ(d,l,h)] \quad (29-5)$$

where

PHT = person-hours of travel in corridor,
 AVO = average vehicle occupancy,
 $v(d,l,h)$ = vehicle demand in Direction d on Link l during Time Period h (veh),
 $R(d,l,h)$ = segment traversal time (h/km), and
 $DQ(d,l,h)$ = queuing delay (veh-h).

Segment demands cannot be used to calculate person-based measures

The mean trip time is computed with Equation 29-6 by dividing the total person-hours of travel by the number of person trips. An O-D table (or at least trip generation data) is required to estimate the number of trips. Segment demands cannot be used, since a single person-trip will show up on several segments.

$$t = 60 * \frac{PHT}{P} \tag{29-6}$$

where

- t = mean trip time (min/person),
- PHT = person-hours of travel, and
- P = total number of person trips.

The mean trip speed is computed with Equation 29-7 by dividing the total number of person-kilometers by the total person-hours of travel.

$$S = \frac{PkmT}{PHT} = \frac{AVO * \sum_{d,l,h} v(d,l,h) * L(l)}{PHT} \tag{29-7}$$

where

- S = mean corridor trip speed (km/h),
- $PkmT$ = person-kilometers of travel,
- PHT = person-hours of travel,
- AVO = average vehicle occupancy,
- $v(d,l,h)$ = vehicle demand in Direction d on Segment l for Period h (veh), and
- $L(l)$ = length of segment (km).

The mean trip delay is computed by subtracting the PHT under free-flow conditions from the PHT under congested conditions and dividing the result by the number of person-trips. The person-hours of travel under free-flow conditions is computed like PHT for congested conditions, but using free-flow traversal times and zero queuing delay.

If delays due to route diversion are desired, then a new demand assignment should be performed that uses the FFS to assign all trips to the shortest path regardless of the v/c ratio. These new unconstrained demands (without any adjustment for queuing) are then used in the regular PHT equation to compute free-flow PHT using Equation 29-8.

$$d = 3,600 \left(\frac{PHT - PHT_f}{P} \right) \tag{29-8}$$

where

- d = mean trip delay (s/person),
- PHT = person-hours of travel,
- PHT_f = person-hours of travel under free-flow conditions, and
- P = total number of person trips.

The analyst should recognize that these computations assume that all delay occurs within the overall analysis period selected by the analyst. The impact of analysis period congestion on the demand after the analysis period is not considered. If the analyst suspects that the impacts on later time periods will be significant, then the analysis period should be extended to include the times affected.

Duration

Performance measurements of duration can be computed from the number of hours of congestion observed on any segment. The duration of congestion is the sum of the length of each analysis subperiod for which the demand exceeds capacity. The duration of congestion (i.e., oversaturation) for any link is computed using Equation 29-9.

$$H_i = N_i * T \tag{29-9}$$

Estimating delays due to route diversion

where

- H_i = duration of congestion for Link i (h),
- N_i = number of analysis subperiods for which $v/c > 1.00$ on Link i , and
- T = duration of analysis subperiod (h).

The maximum duration on any link indicates the amount of time before congestion is completely cleared from the corridor.

Extent

Performance measures of the extent of congestion can be computed from the sum of the length of queuing on each segment. One can also identify segments in which the queue overflows the storage capacity; this is particularly useful for ramp metering analyses.

To compute the queue length, an assumption must be made about the average density of vehicles in a queue. Default values are suggested in Exhibit 29-6.

EXHIBIT 29-6. QUEUE DENSITY DEFAULTS

Subsystem	Storage Density (veh/km/ln)	Vehicle Spacing (m)
Freeway	75	13.3
Two-Lane Highway	130	7.5
Urban Street	130	7.5

To compute queue length, Equation 29-10 is used.

$$QL(d,l,h) = \frac{T [v(d,l,h) - c(d,l,h)]}{N(d,l) * d_s} \tag{29-10}$$

where

- $QL(d,l,h)$ = queue length (km) for Direction d , of Segment l , for Time Subperiod h ;
- $v(d,l,h)$ = segment demand (veh/h);
- $c(d,l,h)$ = segment capacity (veh/h);
- $N(d,l)$ = number of lanes;
- d_s = storage density (veh/km/ln); and
- T = duration of analysis period (h).

Note that if $v(d,l,h) < c(d,l,h)$, then $QL(d,l,h) = 0$, and if $QL(d,l,h) > L(l)$, then the queue overflows the storage capacity.

The queue lengths for all segments then can be added up to obtain the length of queuing in kilometers in the subsystem during the analysis period. The number of segments in which the queue exceeds the storage capacity also might be reported. This statistic is particularly useful for identifying queue overflows that result from ramp metering.

Variability

The variability or sensitivity of the results can be determined by substituting higher and lower demand estimates—for example, substituting 110 percent of the original demand estimates for all segments—and repeating the calculations.

Variability is a sensitivity measure

Accessibility

Accessibility can be measured in terms of the number of trip destinations reachable within a selected travel time for a designated set of origin locations—such as a residential zone. The results for each origin zone are tabulated and reported as X percent of the homes in the study area can reach Y percent of the jobs within Z minutes. A mean access (or mean trip) time for 100 percent of the origins and destinations also might be reported.

For transit, accessibility is computed by finding the shortest travel-time paths from the origin zone or gate to all destination zones and gates in the corridor. Destinations accessible within the desired travel time are identified and the number of trips to them is tallied to obtain the accessibility performance measures.

TRANSIT AND HIGHWAY CORRIDORS

This section summarizes the recommended speed and capacity estimation procedures for transit operating in a corridor. The actual calculation methodology is described in Chapter 27, "Transit." The calculations for all transit facilities are performed in five steps, similar to those for highway facilities, but in a different order.

Assembling Input Data

This first step involves assembling the required data, identifying the transit links, and, for buses, identifying the bus lane type.

The required data consist of

- Demand data —peak-hour transit volumes and peak-hour vehicle volumes;
- Data for estimating transit capacity—dwell times, signal data, bus-stop type (on line vs. off line), and link vehicle capacity; and
- Data for estimating transit speeds—urban street class, stop spacing, bus lane type, rail-line running speed, and freeway or expressway running speeds.

If transit operates on-street, the same segments and points used for the highway subsystems should be used in these calculations. If transit operates off-street, the transit facility should be divided into segments between stations. Points or nodes are assigned to the station locations at the endpoints of each segment.

Determining Bus-Stop Capacity

If a bus facility is being analyzed, the capacities of bus stops must be determined using equations found in Chapter 27. In the absence of field data, default values in Exhibit 29-7 may be used as inputs. There are no default values for the number of loading areas at a bus stop; these values must be determined by the analyst.

EXHIBIT 29-7. DEFAULT VALUES FOR ESTIMATING BUS-STOP CAPACITY

Factor	Urban Street Class			
	I	II	III	IV
g/C ratio	0.45	0.45	0.45	0.45
On-line/off-line stops	Off line	Off line	On line	On line
Clearance time, t_c (s)	15	15	10	10
Dwell time, t_d (s)	30–60	15	30	30–60
Coefficient of variation, c_v	0.60	0.60	0.60	0.60
Failure rate, Z_a	2.5% (1.960)	2.5% (1.960)	7.5% (1.440)	10.0% (1.280)

Determining Transit Segment Capacity

Bus

Segment capacity is determined by multiplying the capacity of the critical bus stop by an adjustment for the interference of other traffic sharing the lane with buses. The mixed-traffic operations equation or the exclusive bus lane equation in Chapter 27 is used to determine capacity. These equations require knowledge of the passenger vehicle volume and the capacity of the curb lane, the bus lane type (1, 2, or 3), and the bus-stop locations (nearside, farside, or midblock). If there are no stops in the segment, the segment capacity is computed using a dwell time of 0 s and a clearance time of 4 s representing the portion of clearance time not associated with stopping.

Rail

Rail segment capacity depends on the right-of-way: on-street, block signaled, or single track. For on-street streetcar operations, the bus procedures apply. For on-street light-rail operations, use twice the maximum traffic signal cycle length in the line's on-street section to determine the minimum headway; then use Chapter 27 to calculate the segment capacity. For block-signalized sections, use the minimum signaled headway and Chapter 27 to determine capacity. For two-way single-track operations, use the equations and exhibits in Chapter 27 to identify the minimum headway to determine capacity.

Determining Transit Speeds

Bus

Base bus speed is given in Chapter 27 and depends on average dwell times, average bus-stop spacing in the segment, and the bus lane type. The bus-bus interference factor is also found in Chapter 27, using bus volumes and the calculated bus segment capacity.

Rail

Rail speeds may be estimated from Chapter 27. Required inputs are the length of the segment and the running speed. The running speed for on-street streetcars is the segment running time calculated in Chapter 15, "Urban Streets." For on-street light rail, the posted speed limit of the street can be used for running time. For off-street light rail and streetcars, the maximum section operating speed can be used. Default values for other factors can be obtained from material found in Chapter 27.

Estimating Transit Travel Time and Delay

The total person-hours expended by transit passengers is computed using Equation 29-11.

$$PHT_T = P * H \left(\frac{L}{S_T} \right) \quad (29-11)$$

where

- PHT_T = person-hours traveled on transit (h),
- P = number of transit passengers on board (p),
- H = number of hours in analysis period,
- L = distance traveled by transit passengers (km), and
- S_T = actual speed of transit on facility including all delays (km/h).

The delay to transit riders is the difference between the theoretical travel time at FFS—with no delays due to transit stops, traffic congestion, or intersection control—and the actual travel time including all delays. The delay is expressed in terms of passenger-hours, which is the sum of the hours of delay experienced by each transit passenger. Delay to transit passengers is computed using Equation 29-12.

$$d_T = P_d * H \left(\frac{L}{S_{FT}} - \frac{L}{S_T} \right) \quad (29-12)$$

where

- d_T = delay for transit passengers (h),
- P_d = number of transit passengers experiencing the delay (p),
- H = number of hours in analysis period,
- L = distance traveled by transit passengers (km),
- S_{FT} = FFS of transit on the facility (km/h), and
- S_T = actual speed of transit on the facility, including all delays (km/h).

Transit treatments should be evaluated in terms of person-based measures

The free-flow travel time for transit riders is computed from the distance traveled and the FFS for the street or transit facility, assuming no transit stops and no delays due to traffic controls or traffic congestion. If transit shares the right-of-way with general traffic, the FFS for transit is the same as for general traffic. The actual travel time is computed according to the procedures described in Chapter 27, “Transit.”

Evaluating Transit Priority Treatments

Chapter 14 presented bus and rail priority measures that can reduce the traffic delays experienced by transit vehicles operating on-street. However, if implemented, these measures also may result in increased delay to motorists, bicyclists, and pedestrians, and possibly even other transit passengers. One consideration when evaluating whether to implement a transit priority measure—particularly if it involves instituting transit signal priority or converting a lane to exclusive transit use—is the net change in person delay that would result. Of course, other factors, such as cost, change in transit quality of service, and local policies encouraging greater transit use, also should be considered.

The delay estimation procedures in this manual are based on vehicle delay. Although the number of transit vehicles operating on a given street is usually small relative to the number of passenger vehicles, the number of passengers carried per transit vehicle is much greater than the number of passengers carried per passenger vehicle. To compare the effects of a transit priority measure meaningfully, vehicle delay should be multiplied by the number of vehicles and the average passenger occupancy per vehicle to obtain a measure of person-seconds (or minutes) of delay. If the time savings for transit on a corridor level is sufficient to cause some people to change travel modes, that can be considered as well.

III. EXAMPLE PROBLEM

CORRIDOR WITH FREEWAY, PARALLEL ARTERIAL, AND BUS

This problem comprises a 3.5-km-long freeway-and-arterial corridor with one parallel arterial and two diamond interchanges as shown in the freeway corridor exhibit. Pretimed traffic signals are located at points 14, 3, 20, 11, 6, and 21. There is a freeway bus service with bus stops at the foot of each off-ramp. A local bus service operates on San Pablo Avenue, an arterial parallel to the freeway.

The objective is to estimate the highway and transit performance measures for the corridor for the peak hour. The pedestrian and bicycle subsystems are not included in this example. The geographic scale of this example is such that walking is not feasible, and the lack of exclusive bicycle facilities in the corridor negates the need for a separate analysis of bicycle facility operations. The analysis period typically would be extended to 2 h or more to cover the entire congested period. However, this example will analyze only the peak-hour operation to illustrate the procedures that also would be applicable to the other hours in the peak period.

OUTLINE OF SOLUTION

The analysis starts with the highway subsystems. The freeway and arterial or urban street subsystems are analyzed simultaneously. Segment capacities are computed, and the demand is adjusted to account for the effects of any identified bottlenecks. The segment traversal times then are computed for both free-flow and actual conditions. The queue delay due to the deferral of excess demand to later time periods is computed. Finally the highway subsystems performance measures are computed.

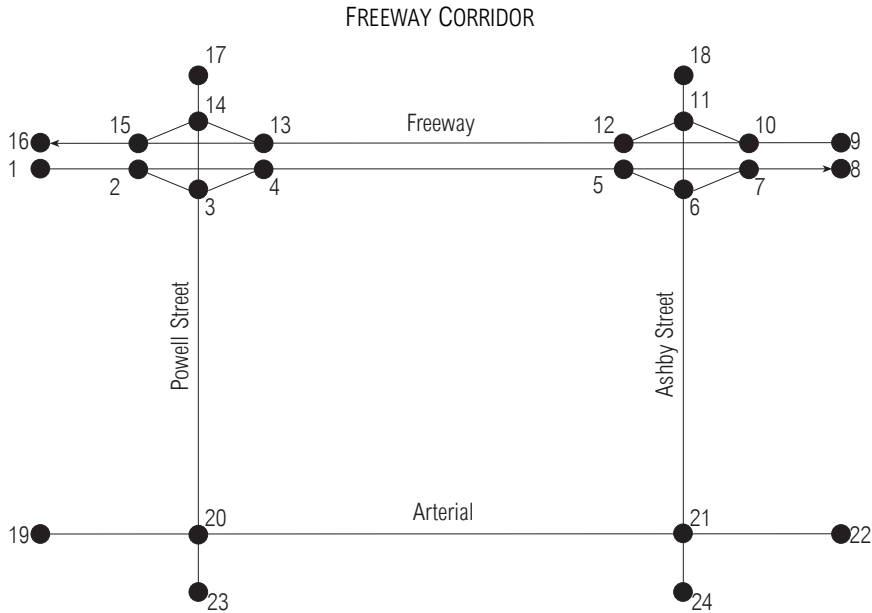

The analysis then proceeds to the transit subsystem. The bus-stop dwell times are computed and used to compute mean speed for the buses. Next, the transit subsystem performance measures are computed. The results of the freeway, arterial, and transit subsystems analyses finally are displayed in a report card format.

The highway segment and transit demands are assumed to be fixed in this analysis. The performance measures are fed back into a travel demand forecasting model, and new demands that are consistent with the estimated performance of the transportation system are computed.

Field data collection should be considered as an alternative way to estimate travel time, delay, and other performance measures. Field estimates tend to be reliable and also account for local conditions that may not be fully represented in the procedures described here.

Assembling Input Data

The corridor is divided into segments and points as shown. The following input data are obtained:

- The length and number of lanes on each segment;
- The turning and through lanes at each signalized intersection;
- The cycle length, phasing, and green times for each signal;
- The FFS for the arterial segments;
- Turning movement counts at each signalized intersection;
- Freeway mainline demand counts or estimates at entry gates to the corridor (only inbound are required); and
- Any other data (such as percentage of heavy vehicles) required by the Part III methods; defaults will not be used. The demand input data are given in the Demand Input Data table.

The freeway has four lanes in each direction west of the Powell Street interchange, but only three lanes in each direction elsewhere. The ramps are all one lane. The arterials are all two lanes in each direction, with a median. There are four signalized intersections at the freeway interchanges and two signalized intersections on the arterial parallel to the freeway. Each signal has exclusive left-turn lanes and protected left-turn phases. Intersections 3 and 14 have double left-turn lanes feeding the on-ramps. The signal cycle length is 82 s for all intersections. The phase green times and lost times are shown in the Signal Timing Data table.

DEMAND INPUT DATA (veh/h)

Count Location	Northbound			Southbound			Eastbound			Westbound		
	Left	Thru	Right	Left	Thru	Right	Left	Thru	Right	Left	Thru	Right
1								8000				
9											3000	
14	882	630			726	136				123	0	151
3		893	363	303	546		619	8	435			
20	53	268	34	378	536	176	163	963	55	110	779	110
11	700	431			697	500				110	0	130
6		631	316	100	707		500	0	400			
21	43	684	109	144	810	153	113	1065	81	126	945	145

SIGNAL TIMING DATA (s)

Signal	NB LT	NB TH	SB LT	SB TH	EB LT	EB TH	WB LT	WB TH	Lost Time
14	25	25	0	25	0	0	0	20	12
3	0	30	20	50	0	20	0	0	12
20	10	23	10	23	10	23	10	23	16
11	30	20	0	20	0	0	0	20	12
6	0	25	20	45	0	25	0	0	12
21	10	23	10	23	10	23	10	23	16

Notes:

NB = northbound; SB = southbound; LT = left turn; TH = through; EB = eastbound; WB = westbound.

Determining Segment Capacity

The capacity of each segment is computed using the appropriate Part III methodology. The Segment Capacities table on the facing page identifies the facility type, segment type, and length of each segment, along with the appropriate Part III chapter reference for computing the capacity. The resulting capacity estimates are shown in the right-hand column of the segment capacities table.

Adjusting for Excess Demand

In the Spreadsheet Setup diagram each numbered point is represented by a boxed cell. Each arrow indicates a directional segment connection between the points.

SPREADSHEET SETUP

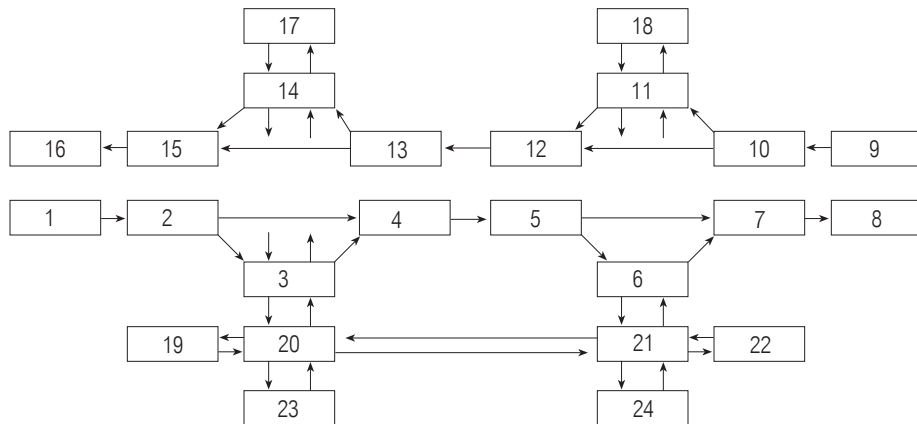

SEGMENT CAPACITIES

Segments		Facility Type	Segment Type	Chapter Reference	Length (km)	Through Lanes	Capacity (veh/h)
A-Node	B-Node						
1	2	Freeway	Diverge	25	0.61	4	8800
2	3	Off-ramp	Interchange	26	0.42	1	1500
2	4	Freeway	Basic	23	0.76	3	6600
3	4	On-ramp	[see notes]	25	0.33	1	1800
4	5	Freeway	Merge/Diverge	25	0.76	3	6600
5	6	Off-ramp	Interchange	26	0.61	1	1800
5	7	Freeway	Basic	23	1.21	3	6600
6	7	On-ramp	[see notes]	25	0.61	1	1800
7	8	Freeway	Merge	25	0.61	3	6600
9	10	Freeway	Diverge	25	0.61	3	6600
10	11	Off-ramp	Interchange	26	0.61	1	1000
10	12	Freeway	Basic	23	1.21	3	6600
11	12	On-ramp	[see notes]	25	0.61	1	1800
12	13	Freeway	Merge/Diverge	25	0.76	3	6600
13	14	Off-ramp	Interchange	26	0.33	1	1000
13	15	Freeway	Basic	23	0.76	3	6600
14	15	On-ramp	[see notes]	25	0.42	1	1800
15	16	Freeway	Merge	25	0.61	4	8800
14	17	Arterial	Class III	15	0.15	2	3400
17	14	Arterial	Class III	15	0.15	2	1200
14	3	Arterial	Class III	15	0.09	2	3600
3	14	Arterial	Class III	15	0.09	2	3600
3	20	Arterial	Class III	15	1.21	2	1700
20	3	Arterial	Class III	15	1.21	2	1400
20	23	Arterial	Class III	15	0.09	2	3400
23	20	Arterial	Class III	15	0.09	2	1400
18	11	Arterial	Class III	15	0.15	2	1200
11	18	Arterial	Class III	15	0.15	2	3400
11	6	Arterial	Class III	15	0.09	2	2700
6	11	Arterial	Class III	15	0.09	2	3000
6	21	Arterial	Class III	15	1.21	2	1400
21	6	Arterial	Class III	15	1.21	2	1200
21	24	Arterial	Class III	15	0.09	2	3400
24	21	Arterial	Class III	15	0.09	2	1400
19	20	Arterial	Class III	15	1.06	2	1400
20	19	Arterial	Class III	15	1.06	2	3400
20	21	Arterial	Class III	15	1.67	2	1400
21	20	Arterial	Class III	15	1.67	2	1400
21	22	Arterial	Class III	15	0.76	2	3400
22	21	Arterial	Class III	15	0.76	2	1400

Notes on capacity computations:

- None of the freeway segments was less than 750 m, so none qualified as a weaving segment. All other freeway segments are split into a basic subsegment and a 450-m ramp influence subsegment. Segments 4–5 and 12–13 are less than 900 m, and have both merge and diverge subsegments. In this case, the ramp merge and diverge influence areas were shortened to one-half the segment length.
- Capacities in pc/h/ln, used for the freeway segments, were converted to vehicle capacities by dividing the demand adjustment factors into the capacity.
- Arterial capacity is computed by multiplying the adjusted saturation flow rate for the through movement by the g/C ratio for the through movement.
- There is no capacity estimation procedure for on-ramps, so a nominal value of 1,800 veh/h was used (see Chapter 25).

DOWNSTREAM DEMAND REDUCTIONS FOR SEGMENT 2-4 CONGESTION

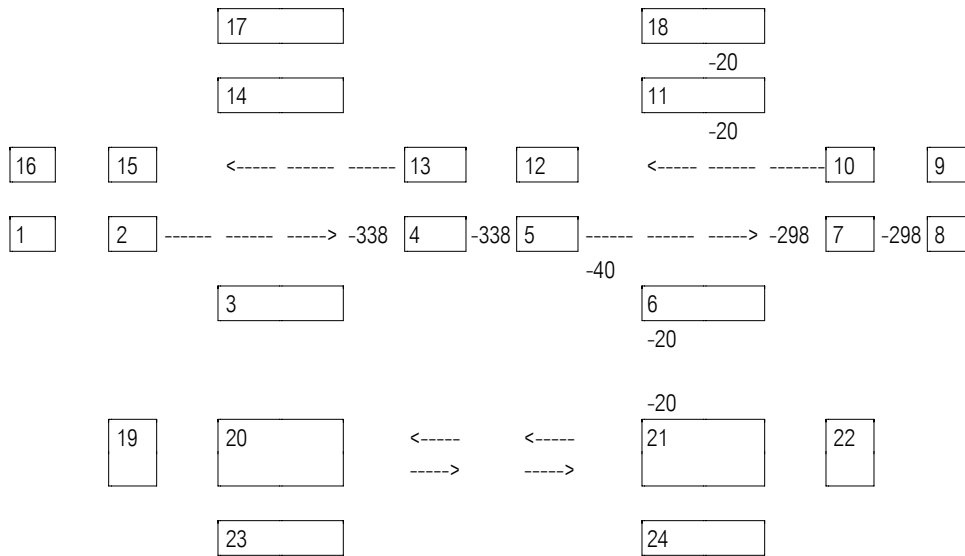

The v/c ratios are recomputed with the new demands, as shown below.

REVISED DEMAND TO CAPACITY RATIOS

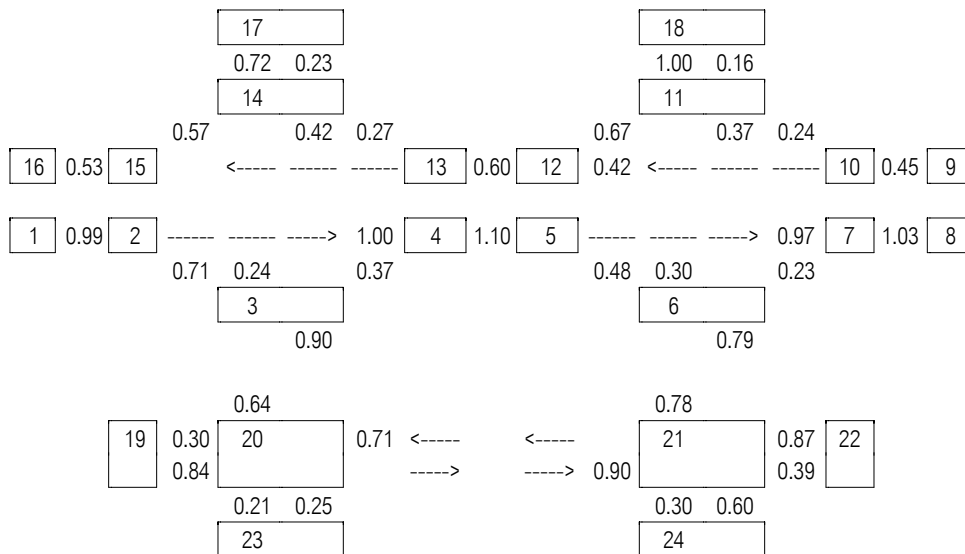

The segments with excess demand now are 4-5 and 7-8. The demand adjustment process is repeated for Segment 4-5 and all downstream segments. The results are the turning movement and segment demands shown in the table and spreadsheet on the following page; none exceeds the peak-hour capacities of the segments.

SIGNAL-ADJUSTED TURNING MOVEMENTS (veh/h)

Count Location	Northbound			Southbound			Eastbound			Westbound		
	Left	Thru	Right	Left	Thru	Right	Left	Thru	Right	Left	Thru	Right
1								8000				
9											3000	
14	882	630			726	136				123	0	151
3		893	363	303	546		619	8	435			
20	53	268	34	378	536	176	163	963	55	110	779	110
11	663	408			697	500				110	0	130
6		631	316	100	707		433	0	347			
21	43	684	109	136	767	145	113	1065	81	126	945	145

FINAL ADJUSTED SEGMENT DEMANDS

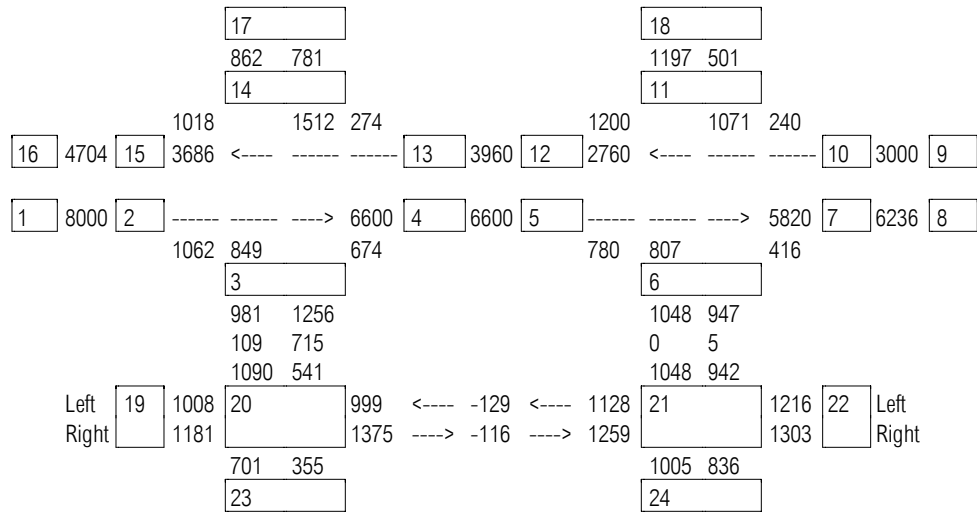

Queue storage calculations indicate that the eastbound freeway queue would extend from just before Segment 4–5 back through the entry gate for the freeway. The blocking effect of this queue on the demand exiting the freeway on ramp Segment 2–3 has been neglected.

Determining Segment FFS Traversal Times

The appropriate Part III methods are used to estimate the freeway and arterial segment FFS. FFS is converted to traversal times by dividing the FFS of a segment into its length. The results are shown in the Freeway-and-Arterial Subsystem Analysis: Computation of PHT and Delay table.

Determining Segment Traversal Times

The appropriate Part III methods are used to estimate the freeway and arterial segment mean speeds. On-ramp speeds are estimated using Chapter 15, "Urban Streets." On-ramp speeds are assumed to be unaffected by volume. The results are shown in the Freeway-and-Arterial Subsystem Analysis: Computation of PHT and Delay table.

Determining Queue Delay

The total demand deferred to a later time period is computed from the demand adjustment step and multiplied by the length of the peak hour (1 h) to obtain the total vehicle-hours of queue delay.

FREWAY-AND-ARTERIAL SUBSYSTEM ANALYSIS: COMPUTATION OF PHT AND DELAY

Segment		Type	Length (m)	Adjusted Demand (veh/h)	Free Speed (km/h)	Actual Speed (km/h)	Free VHT (h)	Queue Delay (veh-h)	Actual VHT (h)	Free PHT (h)	Actual PHT (h)	Delay PHT (h)
A	B											
Freeway Eastbound												
1	2	Basic	160	8000	106	89	12.1		14.4	14.5	17.2	2.7
1	2	Diverge	450	8000	106	85	34.1		42.5	40.9	50.9	10.0
2	4	Basic	760	6600	103	70	48.6	169.0	240.6	58.3	288.7	230.4
4	5	Merge	380	6600	103	71	24.3	337.0	372.4	29.2	446.9	417.7
4	5	Diverge	380	6600	103	85	24.3		29.6	29.2	35.5	6.3
5	7	Basic	760	5820	103	91	42.9		48.7	51.4	58.4	7.0
7	8	Merge	450	6236	103	80	27.2		35.3	32.6	42.3	9.7
7	8	Basic	160	6236	103	82	9.7		12.2	11.6	14.6	3.0
Freeway Westbound												
9	10	Basic	160	3000	103	103	4.7		4.7	5.6	5.6	0.0
9	10	Diverge	450	3000	103	86	13.1		15.6	15.7	18.8	3.1
10	12	Basic	760	2760	103	103	20.3		20.3	24.4	24.4	0.0
12	13	Merge	380	3960	103	85	14.6		17.7	17.5	21.2	3.7
12	13	Diverge	380	3960	103	86	14.6		17.4	17.5	20.9	3.4
13	15	Basic	760	3686	103	103	27.1		27.3	32.6	32.7	0.2
15	16	Merge	450	4704	106	83	20.0		25.4	24.1	30.5	6.5
15	16	Basic	160	4704	106	101	7.1		7.4	8.6	8.9	0.4
Arterial - ABC Southbound												
17	14	Class III	150	862	56	17	2.3		7.8	2.8	9.4	6.6
14	3	Class III	90	849	56	19	1.4		4.0	1.6	4.8	3.2
3	20	Class III	1210	1036	56	26	22.4		48.3	26.8	58.0	31.1
20	23	Class III	90	701	56	40	1.1		1.6	1.4	1.9	0.5
Arterial - ABC Northbound												
23	20	Class III	90	355	56	12	0.6		2.6	0.7	3.1	2.4
20	3	Class III	1210	899	56	43	19.4		25.5	23.3	30.6	7.3
3	14	Class III	90	1512	56	15	2.4		9.2	2.9	11.0	8.1
14	17	Class III	150	781	56	44	2.1		2.6	2.5	3.2	0.7
Arterial - DEF Southbound												
18	11	Class III	150	1197	56	3	3.2		60.3	3.8	72.3	68.5
11	6	Class III	90	807	56	22	1.3		3.4	1.6	4.0	2.5
6	21	Class III	1210	1048	56	43	22.6		29.8	27.2	35.8	8.6
21	24	Class III	90	1005	56	40	1.6		2.3	1.9	2.7	0.8
Arterial - DEF Northbound												
24	21	Class III	90	836	56	11	1.3		6.9	1.6	8.2	6.6
21	6	Class III	1210	945	56	43	20.4		26.5	24.5	31.8	7.3
6	11	Class III	90	1071	56	12	1.7		8.3	2.1	10.0	7.9
11	18	Class III	150	501	56	44	1.3		1.7	1.6	2.0	0.4
Arterial - CF Eastbound												
19	20	Class III	1060	1181	56	40	22.4		31.4	26.8	37.7	10.9
20	21	Class III	1670	1317	56	41	39.3		53.8	47.1	64.6	17.5
21	22	Class III	760	1303	56	56	17.7		17.7	21.2	21.2	0.0
Arterial - CF Westbound												
22	21	Class III	760	1216	56	33	16.5		27.8	19.8	33.4	13.6
21	20	Class III	1670	1064	56	46	31.7		38.7	38.1	46.4	8.3
20	19	Class III	1060	1008	56	56	19.1		19.1	22.9	22.9	0.0
Ramps												
2	3	Class III	400	1062	56	7	7.6		62.6	9.1	75.1	66.0
3	4	Class III	400	674	56	56	4.8		4.8	5.8	5.8	0.0
5	6	Class III	400	780	56	31	5.6		10.1	6.7	12.1	5.4
6	7	Class III	400	416	56	56	3.0		3.0	3.6	3.6	0.0
10	11	Class III	400	240	56	33	1.7		3.0	2.1	3.5	1.5
11	12	Class III	400	1200	56	56	8.6		8.6	10.3	10.3	0.0
13	14	Class III	400	274	56	32	2.0		3.4	2.3	4.1	1.7
14	15	Class III	400	1018	56	56	7.3		7.3	8.7	8.7	0.0
		Sum	23 340				637.1	506.0	1463.6	764.4	1756.0	991.6

The demand adjustment step deferred 338 vehicles from segment 2–4. Another 674 vehicles were deferred from segment 4–5. Thus, a total of 1,012 vehicles would be delayed by an average of 0.5 h (one-half of the analysis period), resulting in a total delay of 506 veh-h. The use of one-half of the analysis period is based on the assumption that the first vehicle in queue has essentially zero delay in the analysis hour, and the last vehicle has 1 h of delay; therefore the average vehicle is delayed 30 min. The results are shown in the Freeway-and-Arterial Subsystems Analysis: Computation of Queue, Extent, and Duration table on the facing page.

Determining Performance Measures

The following table shows the computation of the mean person-hours of travel (PHT) and the mean person-hours of delay. Note that an average vehicle occupancy of 1.2 has been applied to the vehicle-hour travel times to compute person-hour travel times.

PERFORMANCE RESULTS: FREEWAY-AND-ARTERIAL SUBSYSTEMS

	Length (km)	PkmT (pers-km)	PHT (pers-h)	PHD (pers-h)	Speed (km/h)
Freeway Subsystem	7.00	42 896	1118	704	38.4
Arterial Subsystem	16.34	19 644	638	288	30.8
Total	23.34	62 540	1756	992	35.6

Transit Subsystem Analysis

The first step in analyzing a transit subsystem is to compute the actual mean speed for buses on each segment of the corridor, taking all delays into account. This is done using the parameters given in the Transit Subsystem Analysis: Bus Speed Parameters table and computation of bus speeds shown in the Transit Subsystem Analysis: Bus Speed Computation table.

The bus frequency, boarding passengers, and alighting passengers per hour for each street segment are the input data. The passengers per hour on board the buses are input for the first segment in which each bus route enters the corridor study area—for example, for all bus routes entering the corridor on Link 1–2, the total of onboard passengers per hour is 270.

The number of passengers on board for all other segments in the corridor is estimated by adding the upstream segment’s boarding passengers and then subtracting from the total the upstream segment’s alighting passengers. Even though there are often several bus stops on a segment, it is convenient to compute the number of on-board passengers for each segment as if all boarding and alighting takes place at the end of the segment.

If the number of stops on a link is not known or is in planning, it can be determined by dividing the link length by the bus-stop density. The bus-stop density in a segment is assumed to be three stops per kilometer for the urban street links; a minimum of one stop for all urban street segments with bus service; and one stop for each freeway off-ramp. The freeway on-ramps, the freeway segments, and the short urban street segments under the freeway interchanges are assumed to have no bus stops. The number of boarding and alighting passengers for each street segment is divided by the bus frequency and the number of bus stops on the link to obtain the average number of boarding and alighting passengers per bus stop.

The bus-stop dwell time is computed using Equation 27-2. The transit property operates two-door buses exclusively in this corridor. Since door counts are unavailable, it is assumed that 100 percent of boarding passengers use the front door and 10 percent of alighting passengers use the front door. Dwell time is the time required to serve the busiest door, so it is the maximum time required to board and alight passengers at the front door at each stop.

FREEWAY-AND-ARTERIAL SUBSYSTEM ANALYSIS: COMPUTATION OF QUEUE, EXTENT, AND DURATION

Segment		Type	Length (m)	Demand	Adjusted	Capacity	PkmT	Queue	Extent	Duration	Adjusted
A	B			(veh/h)	Demand (veh/h)	(veh/h)	Traveled (pers-km)	(veh)	(km)	(r = 0.7) (h)	D/C (%)
Freeway Eastbound											
1	2	Basic	160	8000	8000	8800	1536	0	2.07	0.0	90.9
1	2	Diverge	450	8000	8000	8800	4320	0	0.45	0.0	90.9
2	4	Basic	760	6938	6600	6600	6019	338	0.76	1.00 ^a	100.0
4	5	Merge	380	7612	6600	6600	3010	674	0.38	1.00 ^a	100.0
4	5	Diverge	380	7612	6600	6600	3010	0	0.00	0.0	100.0
5	7	Basic	760	6712	5820	6600	5308	0	0.00	0.0	88.2
7	8	Merge	450	7128	6236	6600	3367	0	0.00	0.0	94.5
7	8	Basic	160	7128	6236	6600	1197	0	0.00	0.0	94.5
Freeway Westbound											
9	10	Basic	160	3000	3000	6600	576	0	0.00	0.0	45.5
9	10	Diverge	450	3000	3000	6600	1620	0	0.00	0.0	45.5
10	12	Basic	760	2760	2760	6600	2517	0	0.00	0.0	41.8
12	13	Merge	380	3960	3960	6600	1806	0	0.00	0.0	60.0
12	13	Diverge	380	3960	3960	6600	1806	0	0.00	0.0	60.0
13	15	Basic	760	3686	3686	6600	3362	0	0.00	0.0	55.8
15	16	Merge	450	4704	4704	8800	2540	0	0.00	0.0	53.5
15	16	Basic	160	4704	4704	8800	903	0	0.00	0.0	53.5
Arterial - ABC Southbound											
17	14	Class III	150	862	862	1200	155	0	0.00	0.0	71.8
14	3	Class III	90	849	849	3600	92	0	0.00	0.0	23.6
3	20	Class III	1210	1036	1036	1700	1504	0	0.00	0.0	60.9
20	23	Class III	90	701	701	3400	76	0	0.00	0.0	20.6
Arterial - ABC Northbound											
23	20	Class III	90	355	355	1400	38	0	0.00	0.0	25.4
20	3	Class III	1210	899	899	1400	1305	0	0.00	0.0	64.2
3	14	Class III	90	1512	1512	3600	163	0	0.00	0.0	42.0
14	17	Class III	150	781	781	3400	141	0	0.00	0.0	23.0
Arterial - DEF Southbound											
18	11	Class III	150	1197	1197	1200	215	0	0.00	0.0	99.8
11	6	Class III	90	807	807	2700	87	0	0.00	0.0	29.9
6	21	Class III	1210	1107	1048	1400	1521	0	0.00	0.0	74.8
21	24	Class III	90	1017	1005	3400	109	0	0.00	0.0	29.6
Arterial - DEF Northbound											
24	21	Class III	90	836	836	1400	90	0	0.00	0.0	59.7
21	6	Class III	1210	944	945	1200	1371	0	0.00	0.0	78.7
6	11	Class III	90	1131	1071	3000	116	0	0.00	0.0	35.7
11	18	Class III	150	561	501	3400	90	0	0.00	0.0	14.7
Arterial - CF Eastbound											
19	20	Class III	1060	1181	1181	1400	1502	0	0.00	0.0	84.4
20	21	Class III	1670	1317	1317	1400	2639	0	0.00	0.0	94.1
21	22	Class III	760	1318	1303	3400	1188	0	0.00	0.0	38.3
Arterial - CF Westbound											
22	21	Class III	760	1216	1216	1400	1109	0	0.00	0.0	86.9
21	20	Class III	1670	1070	1064	1400	2131	0	0.00	0.0	76.0
20	19	Class III	1060	1008	1008	3400	1282	0	0.00	0.0	29.6
Ramps											
2	3	Class III	400	1062	1062	1500	510	0	0.00	0.0	70.8
3	4	Class III	400	674	674	1800	324	0	0.00	0.0	37.4
5	6	Class III	400	900	780	1800	375	0	0.00	0.0	43.4
6	7	Class III	400	416	416	1800	200	0	0.00	0.0	23.1
10	11	Class III	400	240	240	1000	115	0	0.00	0.0	24.0
11	12	Class III	400	1200	1200	1800	576	0	0.00	0.0	66.7
13	14	Class III	400	274	274	1000	132	0	0.00	0.0	27.4
14	15	Class III	400	1018	1018	1800	489	0	0.00	0.0	56.6

Note:

a. Congestion will extend beyond the single 1-h analysis period shown in the example. The analysis should be continued for subsequent time periods to tally congestion-related delay completely.

TRANSIT SUBSYSTEM ANALYSIS: BUS SPEED PARAMETERS

Link		Type	Frequency Bus (bus/h)	On Board (p/h)	Boarding Pass. (p/h)	Alighting Pass. (p/h)	Bus Stops (#)	Boarding Pass./Stop (p/bus/stop)	Alighting Pass./Stop (p/bus/stop)	Dwell Time/ Stop (s/bus)
A	B									
Freeway Eastbound										
1	2	Basic	6.00	270	0	0	0	0	0	0
1	2	Diverge	6.00	270	0	0	0	0	0	0
2	4	Basic								
4	5	Merge	6.00	210	0	0	0	0	0	0
4	5	Diverge	6.00	210	0	0	0	0	0	0
5	7	Basic								
7	8	Merge	6.00	150	0	0	0	0	0	0
7	8	Basic	6.00	150	0	0	0	0	0	0
Freeway Westbound										
9	10	Basic	6.00	135	0	0	0	0	0	0
9	10	Diverge	6.00	135	0	0	0	0	0	0
10	12	Basic								
12	13	Merge	6.00	175	0	0	0	0	0	0
12	13	Diverge	6.00	175	0	0	0	0	0	0
13	15	Basic								
15	16	Merge	6.00	195	0	0	0	0	0	0
15	16	Basic	6.00	195	0	0	0	0	0	0
Arterial - ABC Southbound										
17	14	Class III	12.00	270	210	110	1	17.50	9.17	54
14	3	Class III	12.00	370	0	0	0	0.00	0.00	0
3	20	Class III	12.00	370	160	170	4	3.33	3.54	13
20	23	Class III	12.00	360	20	190	1	1.67	15.83	29
Arterial - ABC Northbound										
23	20	Class III	12.00	270	150	110	1	12.50	9.17	40
20	3	Class III	12.00	310	260	70	4	5.42	1.46	18
3	14	Class III	12.00	500	0	0	0	0.00	0.00	0
14	17	Class III	12.00	500	110	180	1	9.17	15.00	31
Arterial - DEF Southbound										
18	11	Class III	12.00	270	130	80	1	10.83	6.67	35
11	6	Class III	12.00	320	0	0	0	0.00	0.00	0
6	21	Class III	12.00	320	220	100	4	4.58	2.08	16
21	24	Class III	12.00	440	10	120	1	0.83	10.00	19
Arterial - DEF Northbound										
24	21	Class III	12.00	270	180	140	1	15.00	11.67	47
21	6	Class III	12.00	310	270	130	4	5.63	2.71	19
6	11	Class III	12.00	450	0	0	0	0.00	0.00	0
11	18	Class III	12.00	450	150	130	1	12.50	10.83	40
Arterial - CF Eastbound										
19	20	Class III	12.00	270	180	90	3	5.00	2.50	17
20	21	Class III	12.00	360	30	70	5	0.50	1.17	5
21	22	Class III	12.00	320	170	140	2	7.08	5.83	24
Arterial - CF Westbound										
22	21	Class III	12.00	270	110	20	2	4.58	0.83	16
21	20	Class III	12.00	360	190	120	5	3.17	2.00	12
20	19	Class III	12.00	430	120	50	3	3.33	1.39	13
Ramps										
2	3	Class III	6.00	270	0	60	1	0.00	10.00	19
3	4	Class III	6.00	210	0	0	0	0	0	0
5	6	Class III	6.00	210	0	60	1	0.00	10.00	19
6	7	Class III	6.00	150	0	0	0	0	0	0
10	11	Class III	6.00	135	40	0	1	6.67	0.00	22
11	12	Class III	6.00	175	0	0	0	0	0	0
13	14	Class III	6.00	175	20	0	1	3.33	0.00	12
14	15	Class III	6.00	195	0	0	0	0	0	0
Sum						2730	2140			

Note:
Pass. = passengers.

TRANSIT SUBSYSTEM ANALYSIS: BUS SPEED COMPUTATION

Link		Type	Base Run Time (min/km)	Run Time Losses (min/km)	Traffic v/c	Bus-Bus Interference	Bus Speed (km/h)
A	B						
Freeway Eastbound							
1	2	Basic	N/A	N/A	N/A	N/A	89.1
1	2	Diverge	N/A	N/A	N/A	N/A	84.8
2	4	Basic	N/A	N/A	N/A	N/A	70.9
4	5	Merge	N/A	N/A	N/A	N/A	84.8
4	5	Diverge	N/A	N/A	N/A	N/A	84.8
5	7	Basic	N/A	N/A	N/A	N/A	79.5
7	8	Merge	N/A	N/A	N/A	N/A	81.9
7	8	Basic	N/A	N/A	N/A	N/A	81.9
Freeway Westbound							
9	10	Basic	N/A	N/A	N/A	N/A	103.0
9	10	Diverge	N/A	N/A	N/A	N/A	86.4
10	12	Basic	N/A	N/A	N/A	N/A	85.1
12	13	Merge	N/A	N/A	N/A	N/A	86.4
12	13	Diverge	N/A	N/A	N/A	N/A	86.4
13	15	Basic	N/A	N/A	N/A	N/A	83.2
15	16	Merge	N/A	N/A	N/A	N/A	101.3
15	16	Basic	N/A	N/A	N/A	N/A	101.3
Arterial - ABC Southbound							
17	14	Class III	4.47	1.6	0.72	0.89	8.8
14	3	Class III	N/A	N/A	N/A	N/A	18.9
3	20	Class III	2.44	1.6	0.64	0.94	14.0
20	23	Class III	3.22	1.6	0.21	1.00	12.4
Arterial - ABC Northbound							
23	20	Class III	3.77	1.6	0.25	1.00	11.2
20	3	Class III	2.71	1.6	0.90	0.81	11.3
3	14	Class III	N/A	N/A	N/A	N/A	14.8
14	17	Class III	3.36	1.6	0.23	1.00	12.1
Arterial - DEF Southbound							
18	11	Class III	3.52	1.6	1.00	0.69	8.1
11	6	Class III	N/A	N/A	N/A	N/A	21.6
6	21	Class III	2.60	1.6	0.75	0.89	12.7
21	24	Class III	2.75	1.6	0.30	1.00	13.8
Arterial - DEF Northbound							
24	21	Class III	4.15	1.6	0.60	0.97	10.1
21	6	Class III	2.75	1.6	0.79	0.89	12.3
6	11	Class III	N/A	N/A	N/A	N/A	11.6
11	18	Class III	3.79	1.6	0.15	1.00	11.1
Arterial - CF Eastbound							
19	20	Class III	2.66	1.6	0.84	0.81	11.4
20	21	Class III	2.03	1.6	0.90	0.81	13.4
21	22	Class III	2.98	1.6	0.38	1.00	13.1
Arterial - CF Westbound							
22	21	Class III	2.59	1.6	0.87	0.81	11.6
21	20	Class III	2.40	1.6	0.71	0.89	13.3
20	19	Class III	2.42	1.6	0.30	1.00	14.9
Ramps							
2	3	Class III	2.75	0.0	0.71	0.89	19.4
3	4	Class III	N/A	N/A	N/A	N/A	56.0
5	6	Class III	2.75	0.0	0.43	1.00	21.8
6	7	Class III	N/A	N/A	N/A	N/A	56.0
10	11	Class III	2.87	0.0	0.24	1.00	20.9
11	12	Class III	N/A	N/A	N/A	N/A	56.0
13	14	Class III	2.41	0.0	0.27	1.00	24.9
14	15	Class III	N/A	N/A	N/A	N/A	56.0

Note:
N/A = not applicable.

An alighting time of 1.8 s per passenger, a boarding time of 2.8 s per passenger, and a door open-and-close time of 3 s per stop are used to estimate dwell time. These values were selected from Exhibit 27-9 and from the text explaining Equation 27-2. The estimated bus running time loss was selected from Exhibit 27-19, for a typical arterial outside the central business district for mixed-flow traffic. The on-ramps were assumed to have no running time loss.

The base bus running time per kilometer was obtained from Exhibit 27-18 based on an assumed stop density of three stops per kilometer and the previously computed dwell time per bus stop. Values were interpolated for dwell times that fell between the dwell time values shown in the table.

The bus speed was computed using Equation 27-14 for mixed-flow transit facilities. The skipped-stop operation adjustment factor is set to 1.00 since there is no skipped-stop service. The bus-bus interference adjustment factor is computed using the v/c ratios for the mixed traffic since all transit facilities in this example share with the general traffic.

Equation 27-14 is not appropriate for mixed-flow operations when there are no transit stops. In these situations, the bus is able to travel at the same speed as general traffic. The general traffic speed was used for the bus speed on all freeway segments, on-ramps, and the short urban street segments under the freeway interchanges since each of these has no bus stops.

The transit delay and the total person-hours expected by transit passengers are computed in the Bus Subsystem Performance Calculations table on the facing page. The transit delay is computed using Equation 29-12. The total person-hours traveled for transit (PHT) was computed using Equation 29-11. The analysis period is 1 h. The computations are performed for each segment or link and summed for the corridor.

The passenger-kilometers traveled (PkmT) by transit passengers is computed by multiplying the number of on-board passengers by the segment length for each segment and adding these up for the corridor. The mean transit speed is computed by dividing the transit PkmT by the transit PHT.

CORRIDOR PERFORMANCE REPORT CARD

The Corridor Performance Report Card table is presented below. The freeway ramps are included in the arterial subsystem.

CORRIDOR PERFORMANCE REPORT CARD

Subsystem	Freeway	Arterial	Rural Highway	Transit	Bicycle	Pedestrian
Quantity						
Distance (PkmT)	42 896	19 644	N/A	5828	N/A	N/A
Time (PHT)	1118	638	N/A	379	N/A	N/A
Congestion Intensity						
Total Delay (p-h)	704	288	N/A	281	N/A	N/A
% PHT Delay	63%	45%	N/A	74%	N/A	N/A
Speed (km/h)	38.4	30.8	N/A	15.4	N/A	N/A
Congestion Duration						
Maximum Hours	1.8	0	N/A	see fwy	N/A	N/A
Congestion Extent						
Maximum km	3.7	0	N/A	see fwy	N/A	N/A
Variability						
Delay	6.60	5.00	N/A	0.80	N/A	N/A
Duration	6.60	inf.	N/A	see fwy	N/A	N/A
Extent	1.60	inf.	N/A	see fwy	N/A	N/A
Accessibility	n.c.	n.c.	n.c.	n.c.	n.c.	n.c.

Notes:
N/A = not applicable; n.c. = not computed; fwy = freeway.

BUS SUBSYSTEM PERFORMANCE CALCULATIONS

Link		Type	Length (m)	Free-Flow Speed (km/h)	Actual Bus Speed (km/h)	On-Board Pass. (p)	Transit PHT (p-h)	Transit Delay (p-h)
A	B							
Freeway Eastbound								
1	2	Basic	160	106	89	270	0.5	0.1
1	2	Diverge	450	106	85	270	1.4	0.3
2	4	Basic	760	103	N/A	N/A	N/A	N/A
4	5	Merge	380	103	71	210	1.1	0.4
4	5	Diverge	380	103	85	210	0.9	0.2
5	7	Basic	760	103	N/A	N/A	N/A	N/A
7	8	Merge	450	103	80	150	0.8	0.2
7	8	Basic	160	103	82	150	0.3	0.1
Freeway Westbound								
9	10	Basic	160	103	103	135	0.2	0.0
9	10	Diverge	450	103	86	135	0.7	0.1
10	12	Basic	760	103	N/A	N/A	N/A	N/A
12	13	Merge	380	103	85	175	0.8	0.1
12	13	Diverge	380	103	86	175	0.8	0.1
13	15	Basic	760	103	N/A	N/A	N/A	N/A
15	16	Merge	450	106	83	195	1.1	0.2
15	16	Basic	160	106	101	195	0.3	0.0
Arterial - ABC Southbound								
17	14	Class III	150	56	9	270	4.6	3.9
14	3	Class III	90	56	19	370	1.8	1.2
3	20	Class III	1210	56	14	370	32.1	24.1
20	23	Class III	90	56	12	360	2.6	2.0
Arterial - ABC Northbound								
23	20	Class III	90	56	11	270	2.2	1.7
20	3	Class III	1210	56	11	310	33.3	26.6
3	14	Class III	90	56	15	500	3.0	2.2
14	17	Class III	150	56	12	500	6.2	4.9
Arterial - DEF Southbound								
18	11	Class III	150	56	8	270	5.0	4.3
11	6	Class III	90	56	22	320	1.3	0.8
6	21	Class III	1210	56	13	320	30.5	23.5
21	24	Class III	90	56	14	440	2.9	2.2
Arterial - DEF Northbound								
24	21	Class III	90	56	10	270	2.4	2.0
21	6	Class III	1210	56	12	310	30.6	23.9
6	11	Class III	90	56	12	450	3.5	2.8
11	18	Class III	150	56	11	450	6.1	4.9
Arterial - CF Eastbound								
19	20	Class III	1060	56	11	270	25.1	20.0
20	21	Class III	1670	56	13	360	45.0	34.2
21	22	Class III	760	56	13	320	18.6	14.2
Arterial - CF Westbound								
22	21	Class III	760	56	12	270	17.7	14.0
21	20	Class III	1670	56	13	360	45.0	34.3
20	19	Class III	1060	56	15	430	30.5	22.4
Ramps								
2	3	Class III	400	56	19	270	5.6	3.6
3	4	Class III	400	56	56	210	1.5	0.0
5	6	Class III	400	56	22	210	3.9	2.4
6	7	Class III	400	56	56	150	1.1	0.0
10	11	Class III	400	56	21	135	2.6	1.6
11	12	Class III	400	56	56	175	1.3	0.0
13	14	Class III	400	56	25	175	2.8	1.6
14	15	Class III	400	56	56	195	1.4	0.0
Sum			23 340				378.8	280.9
PkmT = 5827.7				Mean speed = 15.4 km/h				

Notes:
 Pass. = passengers; N/A = not applicable (no service).

INTERPRETATION OF RESULTS

The greatest quantity of person travel in terms of both distance and time occurs on the freeway. Delay due to traffic congestion accounts for a significant portion (63 percent) of the total person-hours of travel time on the freeway subsystem. Traffic congestion is less significant for the arterial and transit subsystems. The largest component of delay for the transit system is the bus-stop delay due to picking up and dropping off passengers and reentering the traffic stream. Bus-stop and traffic delay together are a significant part (74 percent) of total transit travel time.

The mean speed of traffic on the freeway is higher than on the arterial subsystem. Transit travel speeds include both freeway and arterial service. The transit travel speed is less than half that on the freeway subsystem, but somewhat higher than half the speed on the arterial subsystem. There is no congestion (i.e., oversaturation) on the arterial subsystem. Congestion on the freeway extends for 3.7 km and lasts for slightly under 2 h.

A test of the sensitivity of congestion to changes in traffic demands (with no change in the bus patronage) found that a 5 percent increase in demand would increase the intensity of congestion on the freeway and arterial subsystems by 33 percent and 30 percent, respectively. This indicates that both freeway and arterial congestion are highly sensitive to minor variations in demand.

Bus service delays are affected much less in terms of a percentage change, due to the greater importance of bus-stop delays for bus subsystem travel times. The elasticity for bus delay is less than one, which indicates that bus delay is relatively insensitive—in this example—to changes in traffic demands.

There are no rural highway facilities in the example corridor, and there are no bicycle lanes, bicycle routes, or pedestrian facilities, so these subsystems do not appear in the analysis. Accessibility also was not analyzed, because only part of the total trip occurs within the corridor; accessibility therefore is a less meaningful measure for corridor analyses than for areawide analyses.

IV. REFERENCES

1. Dowling, R. G., W. Kittelson, J. Zegeer, and A. Skabardonis. *NCHRP Report 387: Planning Techniques to Estimate Speeds and Service Volumes for Planning Applications*. TRB, National Research Council, Washington, D.C., 1997.
2. Moore, M. H. On the Fastest Route for Convoy-Type Traffic in Flow-Rate Constrained Networks. *Transportation Science*, Vol. 10, No. 2, May 1976, pp. 113–124.

APPENDIX A. O-D MATRIX ESTIMATION

INTRODUCTION

The O-D matrix procedure estimates a corridor vehicle-trip table from traffic counts. A trip table is needed to reassign traffic to facilities within the corridor in response to forecasted traffic congestion. It is also needed to estimate the corridor performance measures. The required input data are turning-movement counts at selected intersections, freeway mainline entry counts, and the approximate density and type of corridor development.

This particular procedure can be implemented on a spreadsheet. It is appropriate for corridors under 10 km, on which distance is not a significant factor in the choice of destination. Under these conditions, we can assume that the number of trips between two points in the corridor will be proportional to the total number of trips generated by each point. Thus, two major traffic generators are likely to have more trips between them than two small traffic generators.

An alternative procedure is summarized at the end of this appendix for estimates involving larger corridors, on which distance affects trip distribution and for which a spreadsheet procedure is no longer practical.

This procedure generally should be applied to corridors under 10 km

ASSEMBLING INPUT DATA

A peak-period turning movement count is required for each signalized intersection on the arterials to be analyzed. Turning-movement counts are also required at the foot of each freeway ramp. In addition an estimate or count is required for the freeway mainline traffic entering the corridor. Exhibit A29-1 shows the corridor.

ESTIMATING FREEWAY O-D MATRIX

The freeway is divided into two directions of travel and a separate O-D matrix is computed for each direction. The row and column totals for the matrices are obtained from the ramp and mainline counts. Zeros are inserted in each matrix for all illogical movements, such as U-turns or reverse direction travel. Exhibit A29-2 shows the matrix for one direction of freeway travel.

The values for the remaining cells of each matrix are estimated using Equation A29-1.

$$T_{ij} = \left(\frac{T_i * T_j}{\sum_j T_j} \right) T \tag{A29-1}$$

where

- T_{ij} = number of trips from Point i to Point j,
- T_i = number of trips originating at Point i, and
- T_j = number of trips arriving at Point j.

EXHIBIT A29-1. O-D SYNTHESIS EXAMPLE CORRIDOR

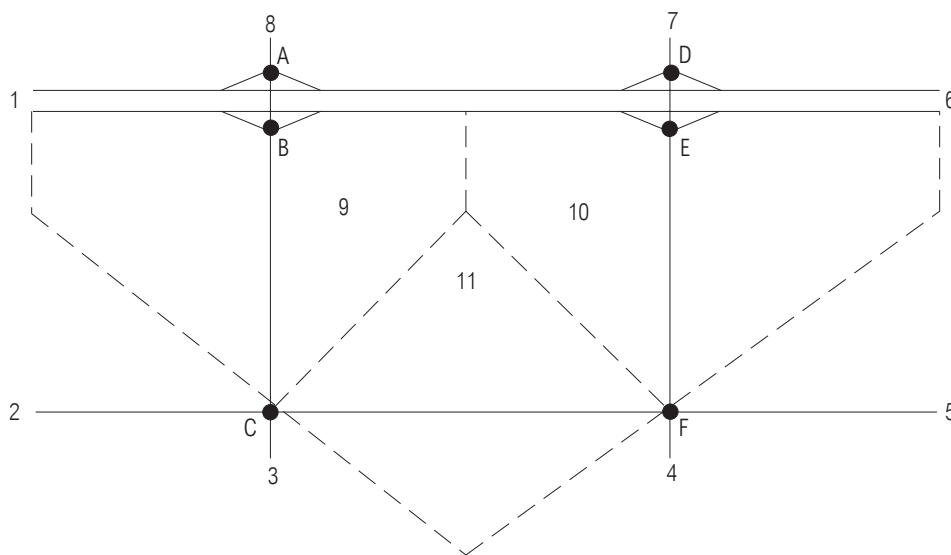

EXHIBIT A29-2. EXAMPLE ONE-DIRECTION FREEWAY O-D TABLE SETUP

Origins/Destinations	First St. Off	Second St. Off	Mainline Off	Total Origins
Mainline On				6000
First Street On	0			400
Second Street On	0	0		500
Total Destinations	600	700	5800	6900

Internal zones

IDENTIFYING GATES AND INTERNAL ZONES

A gate is located at every point that an arterial or a freeway enters or leaves the corridor study area (see Exhibit A29-1). An internal zone is identified for each arterial street segment that lies between analysis intersections. These zones generally represent the geographic area likely to generate trips to each segment.

ESTIMATING INTERNAL TRIP GENERATION

The peak-period vehicle trip generation is estimated for each internal zone based on its land area, general development type and intensity, and standard trip rates, such as those published by the Institute of Transportation Engineers (*I*).

ESTIMATING ORIGINS AND DESTINATIONS

The total number of peak-period trips originating at each corridor gateway and internal zone is estimated and then balanced, so that the total origins for the corridor are equal to the total destinations. Gateway origins and destinations are taken directly from the freeway mainline and intersection turning-movement counts.

The trip-generation estimates for the internal zones initially are split into 50 percent origins and 50 percent destinations. These estimates then are adjusted so that the total origins and destinations for the corridor are equal. One adjustment method is to determine the net increase or decrease in trips between the two intersections bordering the zone and to make the difference between the estimated origins and destinations equal to that.

ESTIMATING THE CORRIDOR O-D MATRIX

The O-D matrix is set up by inserting all the known information. This includes the row and column totals plus zeros for unlikely movements. In addition, certain turning movement counts at the corners of the study area can be assumed to represent 100 percent of the trips between specific gate pairs on the peripheral corners. The previously computed trips between freeway mainline gates also are known. The previously computed mainline-to-ramp O-Ds are discarded. All the information is entered into the O-D matrix. Equation A29-2 is used to estimate the remaining cells of the matrix.

$$T_{ij} = \frac{(T_i - k_i)(T_j - k_j)}{\sum_j (T_j - k_j)} \tag{A29-2}$$

where

- T_{ij} = number of trips from Point i to Point j,
- T_i = number of trips originating at Point i,
- T_j = number of trips arriving at Point j,
- k_i = sum of the known trips originating at Point i, and
- k_j = sum of the known trips destined to Point j.

Guidelines for balancing O-D

APPLYING THE O-D PROCEDURE

Exhibits A29-3 through A29-10 show the application of the O-D estimation procedure in a spreadsheet for a short portion of a freeway corridor with a single parallel arterial. The corridor spans two freeway interchanges and two signalized intersections on the arterial. There are a total of eight gates for which an O-D matrix is desired.

Exhibit A29-3 shows the available peak-hour turning-movement traffic counts at six intersections in the corridor as well as two mainline freeway entry counts.

EXHIBIT A29-3. TRAFFIC COUNTS (veh/h)

Count Location	Eastbound			Westbound			Northbound			Southbound		
	Left	Through	Right	Left	Through	Right	Left	Through	Right	Left	Through	Right
1		6000										
6					3000							
A				123	0	151	882	630			336	526
B	619	8	435					893	363	103	356	
C	163	963	55	110	779	110	53	268	34	378	536	176
D				110	0	130	700	431			697	500
E	500	0	400					631	316	100	707	
F	113	1065	81	126	945	145	43	684	109	144	810	153

Exhibit A29-4 shows the computation of the trip generation for the internal zones. Three internal zones are identified, one for each internal segment of the parallel and crossing arterials in the corridor.

EXHIBIT A29-4. INTERNAL ZONE TRIP GENERATION

Zone	Area (km ²)	Type	Trips/100 m ²	FAR	Trips
9	1.92	com/res	2	0.25	10,600
10	1.92	com/res	2	0.25	10,501
11	1.28	com/res	2	0.25	7,000

Note:
com = commercial; res = residential; FAR = floor area ratio.

Exhibit A29-5 shows how the zonal trip generation is split between origins (trips leaving the zone) and destinations (trips arriving at the zone).

EXHIBIT A29-5. TRIP RATES

Occupancy Types	Units	Daily	A.M. Peak Hour	P.M. Peak Hour
Residential	du	10	0.8	1
Apartment	du	7	0.5	0.6
Commercial	100 m ²	43	1	3.7
Office	100 m ²	11	1.6	1.5
Industrial	100 m ²	7	0.9	1

Note:
du = dwelling unit

Exhibit A29-6 tallies up the traffic count and zonal generation information into O-D totals for each gate and zone. The difference between the origins and destinations for each zone is equal and opposite to the observed differences in the intersection counts at each end of the segment straddled by the zone.

EXHIBIT A29-6. GATE AND ZONE TOTALS

Gate/Zone	Out of Gate	Into Gate	Source
1	6000	5094	Count
2	1181	1008	Count
3	355	701	Count
4	836	1017	Count
5	1216	1318	Count
6	3000	4928	Count
7	1197	561	Count
8	862	781	Count
9	5757	4743	Estimate
10	5253	5248	Estimate
11	3371	3629	Estimate
Sum	29,028	29,028	

Exhibit A29-7 shows the freeway gate-to-gate and gate-to-ramp O-D matrices. These preliminary matrices are used only to estimate the number of through trips (Gate 1 to Gate 6 and vice versa). The ramp-to-gate information is discarded.

EXHIBIT A29-7. FREEWAY TRIPS BY RAMP COUNTS

Eastbound Freeway				
Orig/Dest	B	E	6	Count
1	1062	784	4154	6000
B	0	116	358	474
E	0	0	416	416
Count	1062	900	4928	6890
Westbound Freeway				
Orig/Dest	D	A	1	Count
6	240	147	2613	3000
D	0	127	1073	1200
A	0	0	1408	1408
Count	240	274	5094	5608

Exhibit A29-8 shows the initial overall estimates of the corridor trip table. Zeros are entered into all cells that imply U-turns. In addition, the trips between certain pairs of gates on the corners of the study area can be estimated directly from the turning-movement counts because there are no rational alternative routes between the corner gates.

Exhibit A29-9 shows the first iteration of the balancing process that adjusts the estimated O-D matrix to match the column totals more closely. Exhibit A29-10 shows the second iteration of the balancing process, adjusting the matrix to match the row total more closely. The row and column totals in the estimated matrix are now close enough to the original counts to be a reliable estimate of the origins and destinations.

O-D estimation is a mathematically underconstrained problem. Even if counts were available for 100 percent of the segments in the corridor, there would still be an infinite number of O-D matrices that could predict the observed counts. This is because there are always more cells in the O-D table than there are segments in the network. The goal of O-D estimation is not to find the true O-D matrix, but one that is close enough and yet consistent with the available count information.

The resulting matrix should be recognized as an approximation

EXHIBIT A29-8. CORRIDOR TRIP TABLE

Gate/ Zone	1	2	3	4	5	6	7	8	9	10	11	Count	Sum	Known
1	0	0	47.2	65.1	88.3	4154	31.5	619	346.3	383.2	265	6000	6000	4773
2	0	0	55	58.7	79.7	51	28.4	10.7	312.6	345.8	239.2	1181	1181	55
3	40.1	53	0	0	19.5	12.5	7	2.6	76.7	84.9	58.7	355	355	53
4	97.9	37.7	0	0	109	30.5	17	6.4	187.2	207.1	143.2	836	836	109
5	147.8	56.9	38.5	126	0	0	25.7	9	282.6	312.7	216.2	1216	1215	126
6	2613	15.1	10.2	14.1	0	0	130	2.6	74.9	82.9	57.3	3000	3000	2743
7	144.3	55.6	37.6	51.8	70.3	45	0	0	275.9	305.3	211.1	1197	1197	0
8	103.9	40	27.1	37.3	50.7	32.4	0	0	198.7	219.9	152	862	862	0
9	674.7	59.7	75.7	242.3	328.8	210.4	117.2	44.1	1289.9	1427.2	986.9	5757	5757	0
10	615.7	237	160.3	221.1	300	192	107	40.2	1177	1302.3	900.5	5253	5253	0
11	395.1	152.1	102.9	141.9	192.5	123.2	68.6	25.8	755.3	835.7	577.9	3371	3371	0
Count	5094	1008	701	1017	1318	4928	561	781	4743	5248	3629	29,028	29,028	7859
Sum	4833	907	655	958	1239	4851	532	760	4977	5507	3808			
Known	2613	53	55	126	109	4154	130	619	0	0	0			

EXHIBIT A29-9. FIRST ITERATION (BALANCE COLUMNS)

Gate/ Zone	1	2	3	4	5	6	7	8	9	10	11	Count	Sum	Ratio
1	0.0	0.0	50.6	69.1	93.9	4219.9	33.2	635.8	330.0	365.2	252.5	6000	6050	0.99
2	0.0	0.0	58.9	62.3	84.8	51.8	29.9	11.0	297.9	329.5	228.0	1181	1154	1.02
3	42.3	58.9	0.0	0.0	20.7	12.7	7.4	2.7	73.1	80.9	55.9	355	355	1.00
4	103.2	41.9	0.0	0.0	116.0	31.0	17.9	6.6	178.4	197.4	136.5	836	829	1.01
5	155.8	63.2	41.2	133.7	0.0	0.0	27.1	9.2	269.3	298.0	206.0	1216	1204	1.01
6	2754.4	16.8	10.9	15.0	0.0	0.0	137.0	2.7	71.4	79.0	54.6	3000	3142	0.95
7	152.1	61.8	40.3	55.0	74.8	45.7	0.0	0.0	262.9	290.9	201.2	1197	1185	1.01
8	109.5	44.4	29.0	39.6	53.9	32.9	0.0	0.0	189.4	209.6	144.9	862	853	1.01
9	711.2	288.6	188.2	257.1	349.8	213.7	123.5	45.3	1229.2	1360.1	940.5	5757	5707	1.01
10	649.0	263.4	171.7	234.6	319.2	195.0	112.7	41.3	1121.6	1241.1	858.2	5253	5208	1.01
11	416.5	169.0	110.2	150.6	204.8	125.2	72.3	26.5	719.8	796.4	550.7	3371	3342	1.01
Count	5094	1008	701	1017	1318	4928	561	781	4743	5248	3629	29,028	29,028	1.00
Factor	1.05	1.11	1.07	1.06	1.06	1.02	1.05	1.03	0.95	0.95	0.95			
Sum	5094	1008	701	1017	1318	4928	561	781	4743	5248	3629			

EXHIBIT A29-10. SECOND ITERATION (BALANCE ROWS)

Gate/ Zone	1	2	3	4	5	6	7	8	9	10	11	Count	Factor	Sum
1	0.0	0.0	50.1	68.5	93.2	4184.9	32.9	630.5	327.3	362.1	250.4	6000	0.99	6000
2	0.0	0.0	60.3	63.7	86.8	53.0	30.6	11.2	304.8	337.2	233.3	1181	1.02	1181
3	42.3	59.0	0.0	0.0	20.8	12.7	7.4	2.7	73.2	81.0	56.0	355	1.00	355
4	104.1	42.3	0.0	0.0	117.0	31.3	18.1	6.6	180.0	199.1	137.7	836	1.01	836
5	157.4	63.9	41.7	135.1	0.0	0.0	27.4	9.3	272.1	301.1	208.2	1216	1.01	1216
6	2630.2	16.0	10.4	14.3	0.0	0.0	130.8	2.5	68.2	75.4	52.1	3000	0.95	3000
7	153.7	62.4	40.7	55.5	75.6	46.2	0.0	0.0	265.7	294.0	203.3	1197	1.01	1197
8	110.7	44.9	29.3	40.0	54.5	33.3	0.0	0.0	191.3	211.7	146.3	862	1.01	862
9	717.4	291.1	189.8	259.4	352.9	215.6	124.6	45.7	1239.9	1371.9	948.7	5757	1.01	5757
10	654.6	265.6	173.2	236.7	321.9	196.7	113.7	41.6	1131.4	1251.8	865.6	5253	1.01	5253
11	420.1	170.5	111.2	151.9	206.6	126.2	72.9	26.7	726.0	803.3	555.5	3371	1.01	3371
Count	5094	1008	701	1017	1318	4928	561	781	4743	5248	3629	29,028	1.00	29,028
Sum	4990	1016	707	1025	1329	4900	558	777	4780	5289	3657			
Ratio	1.02	0.99	0.99	0.99	0.99	1.01	1.00	1.01	0.99	0.99	0.99			

LONGER CORRIDORS

The following algorithm (2) can be used for longer corridors for which it is not accurate to assume that distance has no impact on trip distribution. The initial estimate of the O-D matrix is produced by a gravity-type model that includes a weighting factor for the distance between zones and gates. The maximum gradient method then is used to adjust this initial matrix, so that when it is assigned to the corridor it reproduces traffic counts at selected segments in the corridor more accurately.

Step 1. Make the first estimate of the O-D matrix $T'(i, j)$. $T'(i, j)$ is the estimated number of trips between origin Zone i and destination Zone j .

Step 2. Assign the initial O-D matrix $T'(i, j)$ to the network to get initial estimates of segment volumes $v'(a)$ for counted Segments a .

Step 3. Compute gradient $g(a)$ for each segment of network with a count. The gradient is the difference between the desired segment volume or the count, $v(a)$, and the assigned matrix volume $v'(a)$.

$$g(a) = v'(a) - v(a) \tag{A29-3}$$

where

- $g(a)$ = segment gradient,
- $v'(a)$ = estimated segment volume, and
- $v(a)$ = counted segment volume.

Step 4. Compute the objective Function z , which is the sum of the squares of all the segment gradients $g(a)$.

$$z = \sum_a g(a)^2 \tag{A29-4}$$

The target for the objective Function z depends on the desired accuracy of the estimated volumes and the number of segments for which counts are available. For example, if the desired accuracy is a root-mean-square difference of 100 vehicles per hour for 10 counted segments, then the maximum desired value for z is 100,000.

Step 5. If z is small, or the iteration limit is reached, then estimating the O-D matrix is complete.

Step 6. Construct the gradient matrix G . Initialize the gradient matrix with zeros. For each segment with count $v(a)$ identify the O-D pair(s) (i, j) that traverse Segment a and add the segment gradient $g(a)$ to that cell of the gradient matrix. The result is $G(i, j)$.

$$G(i, j) = \sum_a p(a, i, j) * g(a) \tag{A29-5}$$

where

- $G(i, j)$ = the gradient matrix, and
- $p(a, i, j)$ = 1.0 if trips from i to j use Link a , but
- = 0 otherwise.

Step 7. Find the maximum gradient G_{max} . The maximum gradient is the largest absolute ratio of the gradient $G(i, j)$ to the estimated number of trips $T'(i, j)$, computed only for those cells (i, j) in which $T'(i, j) \neq 0$.

$$G_{max} = \max \left[\left| \frac{G(i, j)}{T'(i, j)} \right| \right]_{T'(i, j) \neq 0} \tag{A29-6}$$

where

- $G(i, j)$ = the gradient matrix, and
- $T'(i, j)$ = the estimated trips from i to j from Step 1.

Step 8. Compute the sum of all gradients $G(i, j)$ for cells (i, j) of trips that traverse segments with counts.

$$B(a) = \sum_{i, j} p(i, j, a) * G(i, j) \tag{A29-7}$$

$$C(a) = \sum_{i, j} [p(i, j, a) * G(i, j)]^2 \tag{A29-8}$$

where

- $B(a)$ = sum of gradients for counted segments, and
 $C(a)$ = sum of square of gradients for counted segments.

Step 9. Compute the matrix Adjustment Factor A over all segments with counts.

$$A = G_{\max} * \sum_a [v'(a) - v(a)] * \frac{B(a)}{C(a)} \quad (\text{A29-9})$$

where

- $v'(a)$ = estimated volume on Segments a , and
 $v(a)$ = counted volume on Segments a .

Step 10. Adjust the initial O-D matrix $T'(i, j)$ to get the new O-D matrix $T''(i, j)$.

$$T''(i, j) = T'(i, j) + \min(1, A) * \frac{G_{ij}}{G_{\max}} \Big|_{T(i, j) \neq 0} \quad (\text{A29-10})$$

Step 11. Return to Step 2.

REFERENCES

1. *Trip Generation*, 6th ed. Institute of Transportation Engineers, Washington, D.C., 1997.
2. Spiess, H. *A Gradient Approach for the O-D Matrix Adjustment Problem*. Publication 693, CRT, University of Montreal, Canada, 1990.

CHAPTER 30

AREAWIDE ANALYSIS

CONTENTS

I.	INTRODUCTION	30-1
	Purpose	30-1
	Organization	30-1
	Scope	30-1
	Limitations of Methodology	30-1
	Terminology.....	30-2
II.	METHODOLOGY	30-2
	Highway Facilities	30-3
	Assembling Input.....	30-3
	Determining FFS	30-3
	Freeway Subsystem	30-4
	Rural Highway Subsystem	30-4
	Arterial Subsystem	30-4
	Default FFS Table	30-4
	Determining Link Capacity	30-4
	Freeway Subsystem	30-4
	Rural Highway Subsystem (Multilane Highways)	30-5
	Rural Highway Subsystem (Two-Lane Highways)	30-5
	Arterials	30-5
	Capacity Tables	30-6
	Determining Link Speed.....	30-6
	Determining Performance Measures	30-8
	Intensity	30-8
	Duration	30-9
	Extent	30-10
	Variability	30-11
	Accessibility	30-11
	Transit Facilities	30-11
	Assembling Input Data	30-11
	Determining Bus-Stop Capacity	30-12
	Determining Link Capacity	30-12
	Determining Transit Speeds	30-12
	Determining Performance Measures	30-13
	Intensity	30-13
	Duration	30-13
	Extent	30-13
	Variability	30-13
	Accessibility	30-13
	Transit Analysis Using GIS.....	30-14
	Transit Analysis Using Manual Technique	30-16
III.	EXAMPLE PROBLEMS	30-17
	Example Problem 1. Tri-Valley Subarea Model	30-17
	Example Problem 2. Determine Transit-Supportive Area of a Transit System	30-23
	Example Problem 3. Example Problem 2 Using GIS Software	30-24
	Example Problem 4. Compare Existing Travel Time of Transit and Automobiles	30-25

IV. REFERENCES	30-26
APPENDIX A. NODE DELAY ESTIMATION PROCEDURES	30-27
Adaptive Node Control Procedure	30-27
Purpose, Input, Assumptions	30-27
Determining Likelihood of Signal Control	30-28
Determining Likelihood of All-Way Stop Control	30-29
Signal Node Delay Estimation	30-29
Assembling Input Data	30-29
Developing a Phasing Plan	30-29
Dividing Approach into Lane Groups	30-31
Computing Saturation Flows	30-31
Critical Phase Pairs and Computing Critical Sum	30-31
Estimating Lost Time per Cycle	30-31
Estimating Cycle Length	30-32
Estimating Effective Green Time	30-32
Estimating Control Delay	30-33
Estimating Delay for Two-Way Stop Control	30-34
Assembling Input Data	30-34
Estimating Major-Street Left-Turn Lane Capacity	30-34
Estimating Minor-Street Stop Capacity	30-35
Estimating Minor-Street Delay	30-35
Estimating Delay for All-Way Stop Control	30-35
Assembling Input Data	30-36
Computing Delay by Approach	30-36
APPENDIX B. MULTIPERIOD CONGESTION ANALYSIS	30-36
Determining When Queue First Occurs	30-37
Determining When Queue Clears	30-38
Computing Performance Measures	30-38
APPENDIX C. ALTERNATIVE TRAVEL TIME EQUATION FOR OLDER SOFTWARE	30-39

EXHIBITS

Exhibit 30-1. Example Functional Class–Facility Type Correspondence	30-3
Exhibit 30-2. PCE Capacity for Basic Freeway Segments	30-5
Exhibit 30-3. PCE Capacity for Multilane Highways	30-5
Exhibit 30-4. Recommended Parameters for Traversal Time J	30-8
Exhibit 30-5. Assumption for Duration of Congestion	30-10
Exhibit 30-6. Default Values for Storage Density and Vehicle Spacing	30-10
Exhibit 30-7. Default Values for Estimating Bus-Stop Capacity	30-12
Exhibit 30-8. Example of Transit System Coverage Area	30-14
Exhibit 30-9. Example of Transit-Supportive Area	30-15
Exhibit 30-10. Comparative Area and Population of Example Analysis Areas	30-15
Exhibit A30-1. Minimum Demand Criteria for Signals and All-Way Stops	30-28
Exhibit A30-2. Permitted Phasing Plan (No. 1)	30-30
Exhibit A30-3. Protected Phasing Plan (No. 3)	30-30
Exhibit A30-4. Critical Phase Pair	30-31
Exhibit A30-5. Lost Time per Cycle	30-32
Exhibit A30-6. Example Approach Volume Versus Delay	30-36
Exhibit B30-1. Required Inputs	30-37
Exhibit B30-2. Demand Checks	30-37
Exhibit B30-3. Queue Clearing Cases	30-38
Exhibit B30-4. Values for Parameters K and R	30-38

Exhibit C30-1. Recommended BPR Parameters: Freeways and
Multilane Highways30-39

Exhibit C30-2. Recommended BPR Parameters: Arterials30-39

I. INTRODUCTION

Recommended procedures for computing and predicting performance measures for areawide analyses are presented. Since areawide analysis can involve the evaluation of hundreds of kilometers of facilities and the iterative estimation of demand, these procedures are necessarily simplifications of more elaborate procedures provided in earlier chapters of this manual. The areawide procedures described here are not designed to produce as reliable and accurate estimates of performance measures as do the methodologies designed for the evaluation of a single point, segment, or facility. The procedures described in this chapter are developed on the basis of several research projects (1–7).

PURPOSE

The purpose of this chapter is to provide guidance to analysts wishing to adopt the *Highway Capacity Manual* (HCM) analysis procedures for areawide analyses. These analyses involve regional travel demand forecasting models and long-range transportation plans. The chapter includes procedures for estimating speed, delay, travel time, and other performance measures for areawide analyses that are adapted from more detailed methodologies presented in Part III.

The motivation for replacing the current procedures used to estimate speed and capacity in regional travel demand forecasting models with HCM procedures is to improve the accuracy of the capacity and speed estimates used in air-quality analysis and demand forecasting. Replacement of the standard Bureau of Public Roads (BPR) speed-flow curve with the recommended HCM curves will increase the accuracy of forecast speeds, particularly for congested (oversaturated) conditions. The use of the point (node) delay procedures described in the appendices can further increase the accuracy of the forecast speeds.

ORGANIZATION

The first three paragraphs under Methodology present an overview of the general methodology used in areawide analysis. In the next two major sections, procedures for analyzing highway subsystems (freeways, two-lane highways, and arterials) and transit subsystems are presented, followed by a section of example problems. Three appendices are provided, one describing point (node) delay estimation procedures, another describing a procedure for the analysis of multiple time periods, and a third on an alternative method for older software.

SCOPE

The discussion in this chapter applies to the analysis of multiple facilities in one or more ground transportation subsystems, all located in a designated study area.

LIMITATIONS OF METHODOLOGY

The procedures in this chapter are, in many cases, approximations and simplifications of procedures described in Part III and as such are appropriate only when applied to the analysis of large numbers of facilities over a large area. For analyses of individual facilities, segments, and points the more detailed procedures described in Part III of this manual should be used. Corridor analyses should be based on the procedures described in Chapter 29.

Procedures are provided for the analysis of highway and transit subsystems, but no procedure is recommended at this time for the analysis of bicycle or pedestrian subsystems. Analysts should refer to Chapters 18 and 19 for methodologies for analyzing individual pedestrian and bicycle segments and points.

The procedures do not include analysis of pedestrian and bicycle facilities

TERMINOLOGY

The analytical procedures provided in this chapter require that the ground transportation system in the study area be divided into freeway, rural highway (two-lane highway), arterial (urban street), transit, pedestrian, and bicycle subsystems. Each subsystem is then divided into segments.

The material in this chapter is typically used in metropolitan areas for planning purposes. To retain terms that have traditionally been used by planning agencies, the following terms are interchangeable:

- Segment and link;
- Point and node.

Link and node defined

In this chapter the segments are called links, a term of identical meaning that is more commonly used in transportation demand modeling practice. A link is a stretch of a facility where the demand and the capacity do not vary by more than 10 percent. Each link has two nodes, one at each end. Nodes typically represent a major intersection, a ramp merge point, a ramp diverge point, or other point where the demand or the capacity of the facility changes significantly. The term node is commonly used in demand modeling practice and is equivalent to the term point used elsewhere in this manual.

Key terms defined

Mean speed is defined as the length of the link divided by the mean travel time over the link. This term is sometimes also called the space mean speed or the harmonic mean of spot speed measurements to distinguish it from a simple averaging of spot speed measurements. The free-flow speed (FFS) is the mean speed of vehicles at low traffic flows and excluding all control delay due to signals, stop signs, and other traffic control devices.

The capacity of a link is defined like that of a pipeline. The link capacity is the capacity of the most restricted point on the link. If the link includes signalized intersections, the link capacity is usually the capacity of the most restrictive intersection along or at the end of the link.

The reader should distinguish in the following text among references to subsystem types, facility types, and functional class. Functional class, typically used in planning, includes freeways, expressways, arterials, collectors, and local roads. Functional classes are not used in the HCM, in which the following facility types are defined: freeway, multilane highway, two-lane rural highway, and urban street (arterial). The facility types are combined into the following subsystem types: freeway, rural highway, arterial, transit, pedestrian, and bicycle.

II. METHODOLOGY

These areawide highway analysis procedures are designed for use on the freeway, arterial, and rural highway subsystems of the area transportation system. The procedures are used to estimate highway segment performance measures, which include the effects of any delay-causing elements (such as traffic signals) within or at the end of the link. The link (segment) results are then summed in an automated procedure to determine overall subsystem performance.

The analysis estimates space mean speed for vehicles on the links. The analyst may also optionally estimate the mean vehicle delay for each link approach to a node intersection. The node delays are added to the estimated link traversal times (computed excluding the node delay) to obtain the total link travel time. The link travel times are summed over all links of that facility subsystem to obtain total travel time for the subsystem. The subsystem travel time and other data are then used to compute the subsystem performance measures.

These transit analysis procedures are designed for estimating the performance measures for the transit subsystem, which is represented by links and nodes. Each link is a segment where transit service capacity is relatively constant. A segment may traverse several transit stops as long as all stops have the same transit service. Nodes are the beginning and end points of each link. Nodes may be major transit stops, points where there is a significant increase or decrease in service, transfer points, or intersections of more than two transit links.

HIGHWAY FACILITIES

This procedure is performed for all highway subsystems in five steps. The necessary input data are assembled and the FFS of each link is computed. The capacity of each link and the mean link speeds are computed. Finally, the travel time and other performance measures are computed for all links and summed for each subsystem.

Tables with capacity and FFS default values can be used to reduce the effort required for two of the steps (Steps 2 and 3), but poor choices of capacity and FFS can significantly reduce the accuracy of the estimated speeds.

Assembling Input

The first step involves assembling the required data, identifying the links and nodes for the highway subsystems, and identifying the facility type for each link. The required data vary by facility type but generally consist of demand data (daily traffic, peak-hour volume, turning movements), data for estimating FFS (facility type, speed limit, signal data), and data for estimating capacity (number of lanes, percent trucks, terrain). Each facility is divided into links within which demand and capacity do not vary by more than 10 percent. Links are also terminated at all major intersections on an arterial or at ramp merge or diverge points on a freeway. Nodes are assigned to each endpoint of each link.

Since most agencies use a functional class system for identifying their facilities, Exhibit 30-1 provides a suggested correspondence between functional classes and the facility types used in this manual. Analysts are encouraged to develop their own correspondence table based on local conditions.

EXHIBIT 30-1. EXAMPLE FUNCTIONAL CLASS–FACILITY TYPE CORRESPONDENCE

Functional Class	Subsystem	Facility Type
Freeway	Freeway	Basic
On-ramp	Arterial	Class III ^c
Off-ramp	Arterial	Class III
Expressway ^a	Arterial	Class I
Divided arterial ^a	Arterial	Class I, II, III
Undivided arterial ^a	Arterial	Class II, III
Collector ^a	Arterial	Class III
Local ^a	Arterial	Class IV
Centroid connector	None ^b	None ^b

Notes:

- a. Analyze as rural highway subsystem (multilane or two-lane facility, as appropriate) if there are no signals or signals are spaced more than 3 km apart.
- b. Centroid connectors typically have near-infinite capacity and a fixed travel speed. They do not fit any HCM facility type.
- c. Treat on-ramp as arterial with 100-percent green time.

Determining FFS

The FFS of a facility is defined as the mean speed of passenger cars under low to moderate flow rates and prevailing roadway and traffic conditions. The best technique for estimating FFS is to measure it in the field under light traffic conditions, but this is not a feasible option when a large number of links must be analyzed. The next best technique is to use the procedures defined in Part III of this manual.

Computations for the analysis of highway facilities

- Input Data,
- FFS,
- Capacity,
- Mean speed, and
- Performance measures

Freeway Subsystem

The FFS for freeway subsystem links (weaving, merge, diverge, and basic segments) can be estimated using the procedures described in Chapter 23, “Basic Freeway Segments.” The procedures require information on lane widths, lateral clearances, number of lanes, and interchange spacing. Default values are given in Chapter 13, “Freeway Concepts.”

Rural Highway Subsystem

The FFS for two-lane and multilane highway links can be estimated using the procedures in Chapter 20, “Two-Lane Highways,” and Chapter 21, “Multilane Highways.” The procedures require information on lane widths, lateral clearances, number of lanes, median type, and access point density. Default values are given in Chapter 12, “Highway Concepts.”

Arterial Subsystem

The FFS for arterials can be measured in the field or estimated on the basis of the urban street (arterial) class as described in Chapter 15, “Urban Streets.” Default value FFS are listed in Chapter 15. Note that the FFS excludes any control delay.

Default FFS Table

The analyst may wish to develop an FFS table based on the functional class and the area type in which a link is located in order to simplify the estimation of FFS. Depending on local conditions, the analyst may wish to classify links by area type (downtown, urban-suburban, rural), terrain type (level, rolling, mountainous), and frontage development type (commercial, residential, undeveloped).

The accuracy of the speed estimation procedure is highly dependent on the accuracy of the FFS and capacity used in the computations. Care should be taken in creating local tables so that they accurately reflect the FFS observed in the local area.

Determining Link Capacity

The best technique for estimating capacity is to use the methodologies in Part III of this manual. The capacities, computed in terms of passenger cars per hour, however, must be converted to mixed-vehicle capacities. This conversion is done to allow the use of actual vehicular demand values in the queuing and delay calculation steps rather than passenger-car equivalents (PCE). The conversion to vehicle capacity is accomplished by applying the demand adjustment factors recommended in Part III to the capacity in PCE. The following equations for freeways, multilane highways, two-lane highways, and arterials illustrate the application of the demand adjustment factors to the PCE capacity.

Freeway Subsystem

Equation 30-1 is used to compute the mixed-vehicle capacity of a freeway link at its critical point, the point on the link with the lowest capacity.

$$c = Q * N * f_{HV} * f_p * PHF \tag{30-1}$$

where

- c = capacity (veh/h),
- Q = PCE capacity from Chapter 23 (pc/h/ln),
- N = number of through lanes (ignoring auxiliary and exit-only lanes),
- f_{HV} = heavy-vehicle adjustment factor,
- f_p = driver population adjustment factor, and
- PHF = peak-hour factor.

For freeways, the PCE capacities are shown in Exhibit 30-2. If a significant amount of weaving traffic is expected on a segment of the freeway (as might occur when a major

An FFS table may be developed to reflect local conditions

Source: Equation 23-2, adapted to yield capacity adjustment rather than volume adjustment

on-ramp is closely followed within 600 m by a major off-ramp), the analyst might reduce the PCE capacity for that segment by 10 percent.

EXHIBIT 30-2. PCE CAPACITY FOR BASIC FREEWAY SEGMENTS

Free-Flow Speed (km/h)	PCE Capacity (pc/h/ln)
120	2400
110	2350
100	2300
90	2250

See Chapter 23, “Basic Freeway Segments,” for procedures for determining the adjustment factors. See Chapter 13, “Freeway Concepts,” for default values and approximation procedures for adjustment factors.

Rural Highway Subsystem (Multilane Highways)

Equation 30-1 is also used to compute the mixed-vehicle capacity of a multilane highway. PCE capacities used for multilane highways are listed in Exhibit 30-3.

EXHIBIT 30-3. PCE CAPACITY FOR MULTILANE HIGHWAYS

Free-Flow Speed (km/h)	PCE Capacity (pc/h/ln)
100	2200
90	2100
80	2000
70	1900

See Chapter 21, “Multilane Highways,” for the adjustment factor values. See Chapter 12, “Highway Concepts,” for suggested default values and procedures for approximating adjustment factors.

Rural Highway Subsystem (Two-Lane Highways)

Equation 30-2 is used to compute the mixed-vehicle capacity (in one direction) for a two-lane highway (one lane in each direction) with signals (if any) more than 3 km apart:

$$c = Q * f_{HV} \tag{30-2}$$

where

- c = capacity (veh/h),
- Q = 1700 (pc/h/ln), and
- f_{HV} = heavy-vehicle adjustment factor.

See Chapter 20, “Two-Lane Highways,” for the adjustment factor values. See Chapter 12, “Highway Concepts,” for suggested default values and approximation procedures for the heavy-vehicle adjustment factor.

Arterials

The capacity of an arterial is determined by examining the through movement capacity at each signal-controlled intersection on the arterial link. The intersection with the lowest through capacity determines the overall capacity of the arterial link. Note that the number of lanes (N) is not counted midblock; it is counted at the approach.

Equation 30-3 is used to compute the one-direction through capacity at each signal.

$$c = s_o * N * f_w * f_{HV} * f_g * f_p * f_{bb} * f_a * f_{LU} * f_{LT} * f_{RT} * f_{Lpb} * f_{Rpb} * PHF * g/C \tag{30-3}$$

Source: Equation 16-4, adapted to include PHF and g/C

where

- c = capacity (veh/h),
- PHF = peak-hour factor, and
- g/C = effective green time per cycle.

Refer to Equation 16-4 for definitions of all other factors.

See Chapter 16, "Signalized Intersections," for the adjustment factor values. See Chapter 10, "Urban Street Concepts," for default values and approximation procedures for adjustment factors.

For arterials with all-way stops controlling the link capacity, procedures in Chapter 17, "Unsignalized Intersections," should be used to estimate the through movement capacity at each intersection.

Capacity Tables

The accuracy of the speed estimates are highly dependent on the accuracy of the estimated capacity for the facility. Consequently, it is recommended that each analyst use capacities that are specific to each link whenever possible. However, it is recognized that this procedure is not always feasible. The analyst may select sets of default values for the various capacity adjustment factors that vary by functional class (freeway, highway, arterial, collector, local), area type (downtown, urban, suburban, rural), terrain type (level, rolling, mountainous), and other conditions. These default values may be substituted into the above capacity equations to develop tables of link capacity values that vary by functional class, area type, general terrain, and number of lanes.

Determining Link Speed

The vehicle speed for the link is computed using Equation 30-4.

$$S = \frac{L}{R + \frac{D}{3600}} \quad (30-4)$$

where

- S = link speed (km/h),
- L = link length (km),
- R = link traversal time (h), and
- D = node delay for link (s).

Node delay is computed only for signal- or stop-sign-controlled intersections at the end of the link. All other intersection-related delays that occur in the middle of the link are incorporated into the link traversal time calculation. The node delay estimation procedure is described in Appendix A. The calculation requires information on all of the intersection approaches at the node in order to compute the delay on each link feeding the intersection.

If the available travel demand model software package is unable to compute node delay, it can be approximated by using the node approach capacity rather than the link capacity in the computation of traversal time. In this situation the node delay is set to zero in Equation 30-4.

The link traversal time, R , is computed using Equation 30-5.

$$R = R_o + D_o + 0.25T \left[(X - 1) + \sqrt{(X - 1)^2 + \frac{16J * X * L^2}{T^2}} \right] \quad (30-5)$$

where

- R = link traversal time (h),
- R_o = link traversal time at link FFS (h),
- D_o = zero-flow control delay at signalized intersection (h),

Traversal time plus node delay equals segment travel time

See Appendix A for methods to estimate node delay

- T = expected duration of demand (typically 1 h) (h),
 X = link demand to capacity ratio,
 J = calibration parameter, and
 L = link length (km).

The link traversal time for free-flow conditions (R_o) is computed from the FFS, using Equation 30-6.

$$R_o = \frac{L}{S_o} \quad (30-6)$$

where

- R_o = FFS link traversal time (h),
 L = link length (km), and
 S_o = link FFS (km/h).

The zero-flow control delay for signalized intersections (if any) on the link is computed using Equation 30-7.

$$D_o = \frac{N}{3600} * DF * \frac{C}{2} \left(1 - \frac{g}{C}\right)^2 \quad (30-7)$$

where

- D_o = zero-flow control delay at signal (h),
 N = number of signals on link,
 3600 = conversion from seconds to hours,
 g/C = average effective green time per cycle for signals on link (see Exhibit 10-12 for default values) (s),
 C = average cycle length for all signals on link (see Exhibit 10-12 for default values) (s), and
 DF = adjustment factor to compute zero-flow control delay (0.9 for uncoordinated traffic-actuated signals, 1.0 for uncoordinated fixed-time signals, 1.2 for coordinated signals with unfavorable progression, 0.90 for coordinated signals with favorable progression, and 0.60 for coordinated signals with highly favorable progression).

The calibration parameter J is selected so that the traversal time equation will predict the mean speed of traffic when demand is equal to capacity. Substituting $x = 1.00$ in the traversal time equation and solving for J yields Equation 30-8:

$$J = \frac{(R_c - R_o)^2}{L^2} \quad (30-8)$$

where

- J = calibration parameter,
 R_c = link traversal time when demand equals capacity (h),
 R_o = FFS link traversal time (h), and
 L = link length (km).

Exhibit 30-4 shows values for J that were selected to reproduce the traversal times at capacity predicted by the analysis procedures in Part III of this manual. Some older software may not be able to implement Equation 30-8, so the formula and recommended parameters for the more traditional BPR curve are provided in Appendix C as an alternative method for estimating link traversal times.

Calibration parameter J is used to arrive at a predicted mean speed when demand equals capacity

See Appendix C for alternative approach using BPR curve

EXHIBIT 30-4. RECOMMENDED PARAMETERS FOR TRAVERSAL TIME J

Facility Type	Signals per km	Free-Flow Speed (km/h)	Speed at Capacity (km/h)	J (h ² /km ²)
Freeway	N/A	120	86	10.9 x 10 ⁻⁶
Freeway	N/A	110	84	7.9 x 10 ⁻⁶
Freeway	N/A	100	82	4.8 x 10 ⁻⁶
Freeway	N/A	90	80	1.9 x 10 ⁻⁶
Multilane Highway	N/A	100	88	1.9 x 10 ⁻⁶
Multilane Highway	N/A	90	81	1.5 x 10 ⁻⁶
Multilane Highway	N/A	80	74	1.0 x 10 ⁻⁶
Multilane Highway	N/A	70	68	0.2 x 10 ⁻⁶
Two-Lane Highway	N/A	100	60	44.4 x 10 ⁻⁶
Two-Lane Highway	N/A	90	50	79 x 10 ⁻⁶
Two-Lane Highway	N/A	80	40	156 x 10 ⁻⁶
Two-Lane Highway	N/A	70	30	362 x 10 ⁻⁶
Arterial Class I	0.33	80	53	22 x 10 ⁻⁶
Arterial Class I	1.00	80	31	200 x 10 ⁻⁶
Arterial Class I	2.50	80	15	1248 x 10 ⁻⁶
Arterial Class II	0.50	65	40	50 x 10 ⁻⁶
Arterial Class II	1.00	65	28	200 x 10 ⁻⁶
Arterial Class II	2.00	65	18	799 x 10 ⁻⁶
Arterial Class III	2.00	55	17	799 x 10 ⁻⁶
Arterial Class III	3.00	55	13	1797 x 10 ⁻⁶
Arterial Class III	4.00	55	10	3195 x 10 ⁻⁶
Arterial Class IV	4.00	45	10	3195 x 10 ⁻⁶
Arterial Class IV	5.00	45	8	4991 x 10 ⁻⁶
Arterial Class IV	6.00	45	7	7188 x 10 ⁻⁶

Note:
N/A = not applicable.

Determining Performance Measures

Computation of performance measures for intensity, duration, extent, variability, and accessibility is described.

Intensity

The possible performance measures for measuring the intensity of congestion on one of the highway subsystems (freeway, rural highway, and arterial) are computed from one or more of the following: person-hours of travel, person-hours of delay, mean trip speed, and mean trip delay. If average vehicle occupancy (AVO) data are not available, the performance measures are computed in terms of vehicle-hours rather than person-hours. Equation 30-9 is used to compute person-hours of travel.

$$PHT = AVO_i * v_i * \frac{L_i}{S_i} \quad (30-9)$$

where

- PHT = total person-hours of travel,
- v_i = vehicle demand on Link i,
- AVO_i = average vehicle occupancy on Link i,
- L_i = length of Link i (km), and
- S_i = mean speed of Link i (km/h).

The total person-hours of delay caused by both traffic congestion and intersection controls is computed using Equation 30-10.

$$PHD = PHT - AVO_i * v_i * \frac{L_i}{S_{oi}} \quad (30-10)$$

where

PHD = total person-hours of delay, and
 S_{oi} = FFS on Link i (km/h).

The analyst should recognize that Equation 30-10 computes the total delay only for demand occurring within the analysis period (T) selected by the analyst. The impact of congestion in one time period on the delays occurring in following time periods is not considered. If the analyst suspects that the impacts on following time periods will be significant, a procedure included in Appendix B for the analysis of multiperiod congestion can be used.

The mean trip speed (S) is computed by Equation 30-11 from the total person-kilometers of travel (PkmT) divided by the total person-hours of travel (PHT):

$$S = \frac{PkmT}{PHT} = \frac{AVO_i * v_i * L_i}{PHT} \quad (30-11)$$

The mean trip time (t) is computed using Equation 30-12 by dividing the total person-hours of travel by the total number of person trips:

$$t = \frac{PHT}{\text{Person trips}} \quad (30-12)$$

Duration

Performance measurements of duration can be computed from the number of hours of congestion observed on any link.

For each link (i);

if $v_i/c_i \leq 1.00$, the link is not congested;

if $v_i/c_i > 1.00$, the link is congested for the number of hours computed by

Equation 30-13.

$$H_i = \frac{T * \frac{v_i}{c_i} * (1 - r)}{1 - r * \frac{v_i}{c_i}} \quad (30-13)$$

where

H_i = duration of congestion for Link i (h),
 r = ratio of off-peak demand to peak demand rate,
 v_i = vehicle demand on Link i (veh/h),
 c_i = capacity of Link i (veh/h), and
 T = duration of analysis period (h).

Note that the duration of congestion has been defined to include the analysis period plus the time it takes to serve the queue. The assumption in Equation 30-13 is that the demand is constant over the analysis period (T) and that the demand drops to a lower level beyond the analysis period (see Exhibit 30-5).

Note that r must be less than 1.00 and that r times the peak v/c ratio must also be less than 1.00. These requirements mean that if the analyst assumes that the off-peak demand rate is the peak demand rate, none of the link v/c ratios for the peak period can equal or exceed 1.00.

Alternatively, the analyst may use the multiperiod congestion analysis procedure provided in Appendix B to get an even more realistic estimate of congestion duration, but this procedure requires more information (or assumptions) about the peaking of demand.

The estimate of delay does not account for the effect of one period on the next. Appendix B provides a procedure to overcome this deficiency.

EXHIBIT 30-5. ASSUMPTION FOR DURATION OF CONGESTION

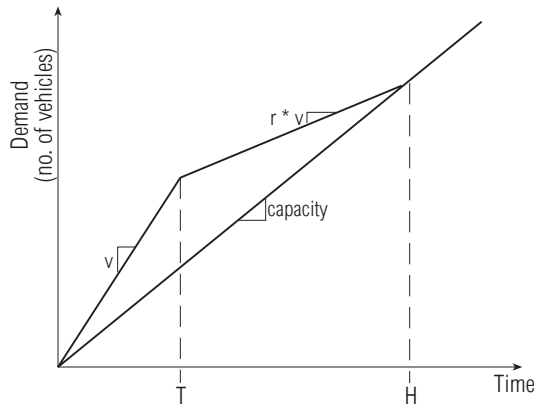

Once the duration of congestion (H) for each link is known, the issue is how to aggregate the data into a meaningful statistic for an entire subsystem. The mean duration per link could be computed or the maximum duration of congestion on any link could be identified. The mean duration will usually be quite low because of the large numbers of uncongested links typically present in any subsystem.

Extent

Performance measures of the extent of congestion can be computed from the sum of the length of queuing on each link. One can also identify those links where the queue overflows the storage capacity of the link (particularly useful for ramp metering analyses). To estimate the queue length the analyst needs to make an assumption for the average storage density of vehicles in a queue. Exhibit 30-6 lists appropriate default values.

EXHIBIT 30-6. DEFAULT VALUES FOR STORAGE DENSITY AND VEHICLE SPACING

Subsystem	Storage Density (veh/km/ln)	Vehicle Spacing (m)
Freeway	75	13.3
Rural highway	130	7.5
Arterial	130	7.5

$$QL_i = \frac{T(v_i - c_i)}{N_i * d_s} \tag{30-14}$$

where

- QL_i = queue length for Link i (km),
- v_i = vehicle demand on Link i (veh/h),
- c_i = capacity of Link i (veh/h),
- N_i = number of lanes,
- d_s = storage density (veh/km/ln), and
- T = duration of analysis period (h).

Note that $QL_i = 0$ if $v_i < c_i$. If $QL_i > L_i$ the queue overflows the link storage capacity.

The queue lengths for each link are summed to obtain the total extent of queuing in the subsystem during the analysis period. The number of links where the queue exceeds the storage capacity can also be reported.

Variability

The first derivative (Equation 30-15) of the traversal time equation provides the sensitivity of the predicted travel time estimates to variances in the estimated v/c ratios.

$$\frac{\delta t}{\delta x} = 0.25T + \frac{0.25T \left[(X-1) + \frac{8J}{T^2} \right]}{\sqrt{(X-1)^2 + 2X * \frac{8J}{T^2}}} \quad (30-15)$$

where

- $\frac{\delta t}{\delta x}$ = first derivative of travel time with respect to v/c ratio,
- X = volume to capacity ratio,
- T = duration of analysis period (h), and
- J = calibration parameter (from Equation 30-8).

Equation 30-15 shows that travel time sensitivity ranges from a value close to zero for low v/c ratios to a high of $T/2$ at very high v/c ratios. At v/c ratios equal to 1.00, the derivative is equal to about $T/4$.

A change in the v/c ratio from 1.0 to 1.1 will increase the estimated travel time by 1.0 min for a typical 60-min analysis period (T). For a kilometer-long freeway link, this is equivalent to more than doubling the typical link travel time.

Accessibility

Accessibility can be measured in terms of the number of trip destinations that can be reached within a selected travel time for a designated set of origin locations (such as a residential zone). The results for each origin zone are tabulated and reported in terms such as the following: X percent of the homes in the study area can reach Y percent of the jobs within Z minutes.

A mean access time (trip time) for 100 percent of the origins and destinations might also be reported. Accessibility is computed by finding the shortest travel time paths from the origin zone to all destination zones in the region. Destination zones that are accessible within the desired travel time are identified and the number of trip destinations represented by these destination zones is tallied to obtain the accessibility performance measure.

TRANSIT FACILITIES

The system analysis procedure is performed for transit facilities in five steps. These steps are similar to the steps for highway facilities but are performed in a different order. First, the necessary input data are assembled. Next, for buses only, bus-stop capacity is computed for the critical bus stop on a link. Third, for all transit modes, the link capacity is calculated. Fourth, link transit travel speeds are computed. Finally, transit travel time and other performance measures are computed for all links and summed for each subsystem.

Assembling Input Data

The first step involves assembling the required data, identifying the links on which transit operates, and (for buses only) identifying the bus lane type. The required input consists of demand data (peak-hour transit volumes, peak-hour vehicular volumes), data for estimating transit capacity (dwell times, signal data, bus-stop type, and link vehicle capacity), and data for estimating transit speeds (arterial class, stop spacing, bus lane type, rail line running speed, and freeway or expressway running speeds).

Where transit operates on-street, the analyst uses the same links and nodes that are used for the highway subsystems. Where transit operates off-street, the transit facility

should be divided into links between transit stations. Nodes are assigned to the station locations at the endpoints of each link.

Determining Bus-Stop Capacity

When the transit facility being analyzed serves buses, the capacities of the bus stops along the facility must be determined. Equations from Chapter 27 should be used to determine these capacities. In the absence of field data, the default values summarized in Exhibit 30-7 may be used as inputs to the equation. No default values are given for the number of loading areas provided at a bus stop since these values must be determined directly by the analyst.

EXHIBIT 30-7. DEFAULT VALUES FOR ESTIMATING BUS-STOP CAPACITY

Factor	Urban Street Class			
	I	II	III	IV
g/C ratio	0.45	0.45	0.45	0.45
On-line/off-line stops	Off line	Off line	On line	On line
Clearance time, t_c (s)	15 ^a	15 ^a	10	10
Dwell time, t_d (s)	30–60	15	30	30–60
Coefficient of variation, c_v	0.60	0.60	0.60	0.60
Failure rate (Z_a)	2.5% (1.960)	2.5% (1.960)	7.5% (1.440)	10.0% (1.280)

Note:

a. Alternatively, use values from Chapter 27 to calculate bus reentry delay based on curb lane traffic volumes.

Determining Link Capacity

Link capacity is determined by multiplying the capacity of the critical bus stop in the link by an adjustment for the interference of other traffic sharing the lane with buses. Equations in Chapter 27 for mixed-traffic operations or exclusive bus lanes should be used as appropriate to determine link capacity. These equations require knowing the passenger-car volume and capacity of the curb lane, the bus lane type (1, 2, or 3), and the bus-stop locations (nearside, farside, or midblock). If there are no stops in the link, the link capacity is computed using a dwell time of 0 s and a clearance time of 4 s (representing the time between the back of one bus and the front of the next bus).

Rail link capacity is dependent on the right-of-way type for the link: on-street, block signaled, or single track. For on-street streetcar operations, bus procedures should be used. For on-street light-rail operations, twice the maximum traffic signal cycle length in the line's on-street section should be used to determine the minimum headway, then equations from Chapter 27 to calculate the link capacity. For block-signaled sections, the minimum signaled headway and the link capacity equation from Chapter 27 should be used. For two-way, single-track operations, refer to Chapter 27.

Determining Transit Speeds

Bus speeds for exclusive bus lanes can be estimated using the method in Chapter 27. Bus speed is defined in Chapter 27 and requires knowing bus-stop spacing, dwell times, delays due to traffic signals and right-turning traffic, skip-stop operations, and interference caused by other buses.

Rail speeds may be estimated from equations given in Chapter 27. Required inputs are the length of the link and the link running speed. For on-street streetcars, the link running time is calculated in the procedure for highway facilities; for on-street light rail, it is the posted speed limit of the street; and for off-street light rail and streetcars, link running speed is the maximum section operating speed. Default values for factors are given in Chapter 27.

Determining Performance Measures

Intensity

The transit automobile travel time difference measure requires calculations of both automobile and transit in-vehicle travel times as well as any additional travel times required for a door-to-door trip. For transit, the out-of-vehicle travel time includes the walk time from one's origin to transit (assumed to be 3 min to a bus stop or 8 min to a busway or rail station), wait time for transit (assumed to be 5 min), walk time from transit to one's destination (3 or 8 min, as applicable), and any required transfer time (variable depending on the system's schedule coordination). For the automobile, out-of-vehicle time consists of the time to park and walk to a destination (0 to 5 min, depending on the location).

Two methods may be used to compute the transit automobile travel time difference. One requires the use of a transportation planning model; the other is a manual method that samples 10 to 15 locations within the study area. These methods are discussed in detail in the *Transit Capacity and Quality of Service Manual (8)*.

Duration

Hours of service is calculated using the procedures in Chapter 27.

Extent

Route kilometers of service is calculated by summing the lengths of all links on which transit service is provided.

Variability

On-time performance is calculated using the procedures in Chapter 27.

Accessibility

The calculation of service coverage can be simplified through the use of a geographic information system (GIS). However, this section also provides a calculation method that does not require a GIS.

The actual area covered by transit will be smaller than a transit system's service area, depending on land use patterns and the financial resources to provide service. Transit routes do not run to areas where there are no passengers to serve, even though those areas might lie within the transit agency service area. However, routes might run through undeveloped areas to connect two developed areas.

The area covered by a particular route can be defined as that area within walking distance of a transit stop. The majority of transit riders arrive from a location within 0.4 km of a bus stop or 0.8 km of a rail station. For the purposes of determining service coverage LOS, walking distance is defined as 0.4 km from a bus stop or 0.8 km from a busway or rail station. Any location within 0.4 km of the area served by deviated fixed-route bus service is also considered to be covered. Exhibit 30-8 compares one system's service coverage area with its district boundary.

The calculation of the transit service coverage area can be performed relatively easily with a GIS. However, if a GIS or accurate bus stop data are not available, this area can be approximated by outlining on a map all of the area within 0.4 km of a bus route. This approximation assumes reasonable bus stop spacings (at least four stops per kilometer). Sections of a route where pedestrian access from the area adjacent to the route is not possible (because of a barrier such as a wall, waterway, roadway, or railroad) should not be included.

By itself, the service coverage area is not the best performance measure, since it does not lend itself easily to comparisons between systems and because it does not address how well the areas that can support transit service (by having sufficient population, employment density, or both) are served.

Transit Capacity and Quality of Service Manual (TCQSM) provides level of service for intensity

TCQSM provides LOS for accessibility

In lieu of other data, one can assume a 0.4-km band on either side of a route to be the service area

EXHIBIT 30-8. EXAMPLE OF TRANSIT SYSTEM COVERAGE AREA

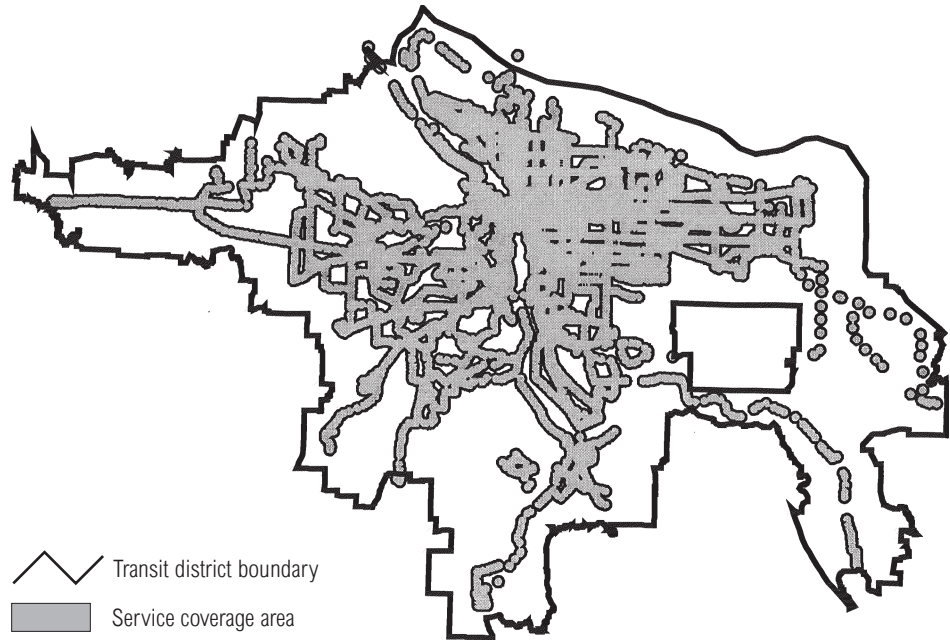

Guidelines on service feasibility

Research (9) suggests that a household density of 11 units per net hectare is the minimum density for hourly transit service to be feasible. This density equates to approximately 7.5 units per gross hectare when the land occupied by streets and parks is accounted for. Hourly service corresponds to the minimum LOS E value for transit service frequency as well as the minimum frequency used for determining hours-of-service LOS for transit.

A Tri-Met long-range service planning study found that an employment density of approximately 10 jobs per gross hectare produced the same level of ridership as a household density of 7.5 units per gross hectare (10). These density values are used below as the minimum densities that could support hourly transit service.

To equalize comparisons between systems and to assess how well a transit system serves the areas most likely to produce transit trips, the concept of a transit-supportive area is used. The transit-supportive area is the portion of a transit service area that provides sufficient population or employment density (or an equivalent mix) to require service at least once per hour. For policy reasons, or simply to provide a route connecting two high-density areas, an agency may choose to cover a larger area.

Exhibit 30-9 compares one system's transit-supportive area (shaded) with its early 1998 service coverage area. The transit-supportive area is considerably smaller than the total area covered by transit, but most of the transit-supportive area is covered by transit. Exhibit 30-10 presents comparative statistics for each of the area types discussed above.

TRANSIT ANALYSIS USING GIS

Step 1: Gather data. The following GIS themes or layers will be required:

- Bus stop locations (or, alternatively, bus routes).
- Areas served by paratransit or deviated fixed-route bus service available to the general public.
- Residential unit and job data for relatively small areas. This information is often available at the transportation analysis zone (TAZ) level from the transportation planning model maintained by metropolitan planning organizations (MPOs) or planning departments. Household data are also available from the Bureau of the Census at various

levels of aggregation. Job data may be available from jurisdictions that administer business licenses or collect payroll taxes.

EXHIBIT 30-9. EXAMPLE OF TRANSIT-SUPPORTIVE AREA

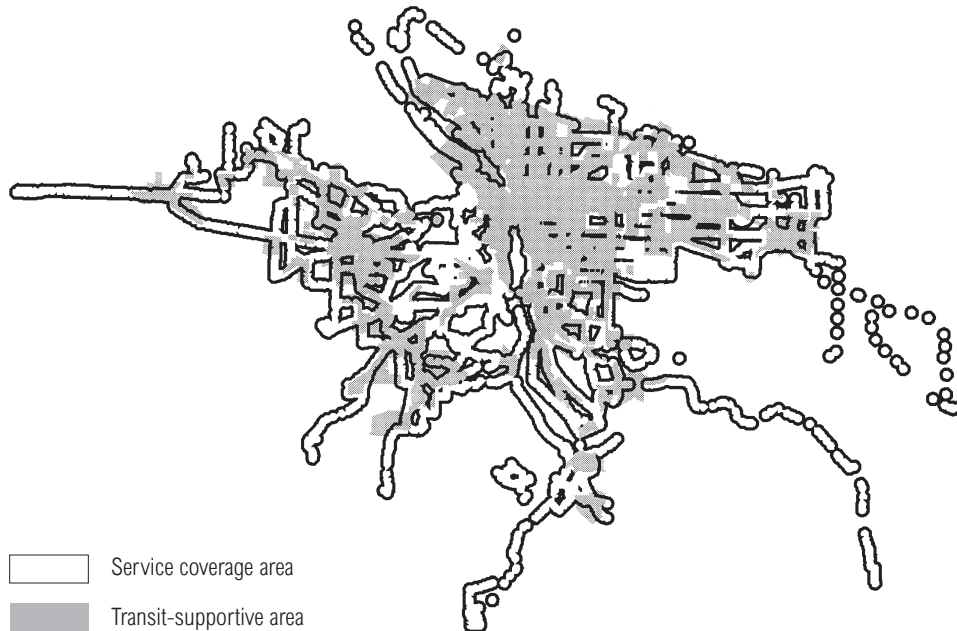

EXHIBIT 30-10. COMPARATIVE AREA AND POPULATION OF EXAMPLE ANALYSIS AREAS

Analysis Area Type	Area (km ²)	Population
District area	1563.1	1,066,118
Coverage area	600.9	779,011
Transit-supportive area	316.0	574,791
Transit-supportive area covered	270.0	522,580

Source: Tri-Met, Portland, OR.

The smaller the areas used to aggregate household and job data, the more accurate the results and the easier it will be to identify transit-supportive areas. For the purposes of this example, TAZ-level data are assumed to be available.

Step 2: Identify the coverage area. Outline, as buffers, the areas within 0.4 km of a bus stop (or bus route), within 0.4 km of the area served by paratransit or deviated fixed-route bus service available to the general public, and within 0.8 km of busway and rail stations. Merge all of the buffer areas together. Next, subtract from this combined area any areas that do not have transit access because of a barrier that blocks pedestrian access, such as a freeway, railroad track, waterway, or wall.

Step 3: Intersect the coverage theme with the TAZ theme. Each TAZ will be subdivided into one or more sub-TAZs that either entirely have or do not have transit coverage. For ease of analysis, the GIS software should be set to proportion data attributes (e.g., population) among the sub-TAZs on the basis of the size of each sub-TAZ relative to the original TAZ. However, if a more detailed analysis is desired, expert GIS users can use other data that may be available (for example, land use types or zoning) to more accurately distribute households and jobs among the sub-TAZs.

Step 4: Calculate household and job densities. Create new fields within the TAZ scheme for household and job densities. Calculate the values for these new fields by dividing the number of households and jobs in each sub-TAZ by the sub-TAZ area.

Step 5: Query the TAZ theme's database to select all sub-TAZs where either the employment density is at least 10 jobs/gross hectare or the household density is at least 7.5 units/gross hectare. Calculate the total combined area of the selected sub-TAZs.

Step 6: Identify the portion of the transit-supportive area covered by transit. Query the sub-TAZs selected in Step 5 to determine which ones lie within the transit coverage area. Calculate the total combined area of the selected sub-TAZs.

Step 7: Calculate the performance measure. Divide the area calculated in Step 6 by the area calculated in Step 5 to determine the percentage of the transit-supportive area covered by transit.

TRANSIT ANALYSIS USING MANUAL TECHNIQUE

Step 1: Gather data. Again, it is assumed for this example that household and job data are available at the TAZ level. The items listed below will be required.

- A printed map (to scale) of the TAZs (or other area type for which household and job data are available) that covers the area being analyzed.
- Data on the number of households and jobs within each TAZ, in either printed or spreadsheet form.
- A map showing transit routes, busways, and rail stations and any areas served by paratransit or deviated fixed-route bus service.

Step 2: Estimate the area of each TAZ. A transparent overlay with a printed grid assists with this task. Alternatively, if the TAZ map is available in electronic form, CAD or other drawing software used to develop the map may be able to calculate the area of each TAZ polygon.

Step 3: Calculate household and job densities. Using a computer spreadsheet, or by hand, calculate household and job densities by dividing the number of households and jobs in each TAZ by the TAZ areas estimated in Step 2.

Step 4: Identify the transit-supportive area. On the basis of the results of Step 3, identify all TAZs where the household density is at least 7.5 units/gross hectare or the employment density is at least 10 jobs/gross hectare. Mark these TAZs on the map.

Step 5: Identify the portion of the transit-supportive area covered by transit. On the printed map, outline the areas within 0.4 km of bus routes that serve or pass near the transit-supportive TAZs, the areas within 0.8 km of busway or rail stations within or near the transit-supportive TAZs, and any portion of the transit-supportive TAZs within 0.4 km of paratransit or deviated fixed-route bus service available to the general public. Estimate the percentage of each transit-supportive TAZ that is covered by transit. Do not include any areas that do not have transit access because of a barrier that blocks pedestrian access, such as a freeway, railroad track, waterway, or wall.

Step 6: Calculate areas. Add up the areas of the transit-supportive TAZs, using the information developed in Step 2. This sum is the total area of the transit-supportive area. Next, for each transit-supportive TAZ, multiply its area (from Step 2) by the percentage of its area covered by transit (from Step 5). The product is the total transit-supportive area covered by transit.

Step 7: Calculate the performance measure. Divide the areas calculated in Step 6 by the area calculated in Step 5 to determine the percentage of the transit-supportive area covered by transit.

III. EXAMPLE PROBLEMS

EXAMPLE PROBLEM 1. TRI-VALLEY SUBAREA MODEL

The Situation The purpose of this example is to illustrate the process of incorporating the procedures for highway analysis into a long-range travel demand model. The model used in this example was the Tri-Valley Subarea Model. The Tri-Valley is a subarea of the San Francisco Bay region, encompassing parts of two counties, Alameda and Contra Costa, with an area of about 380 km².

Assembling Input Data There is a total of 734 zones, 5,761 nodes, and 16,643 links in the highway network. The highway links are divided into about 30 link types classified by functional class, such as freeways, expressways, major and minor arterials, and collectors. These links are further subclassified by area type [core, central business district (CBD), urban, suburban and rural].

The Tri-Valley highway links were matched to the HCM facility types on the basis of the area in which the link is located, the original facility type, the original FFS, and the original capacity per lane. Tables of values were developed for FFS and capacity, since study resources did not permit collection of link-specific data.

The following table shows the input data for six sample links.

LINK DATA FROM MODEL

Link	Model Functional Class	Length (km)	Lanes	Demand (veh/h)
1	Suburban freeway	2.18	3	6790
2	Suburban freeway	1.86	3	5170
3	Freeway on-ramp	0.45	1	1490
4	Freeway off-ramp	0.42	1	970
5	Major arterial	0.30	2	1330
6	Major arterial	0.40	3	2160

The first step is to determine the HCM facility type for each model functional class. In this example, the suburban freeway links are both classified as freeway facility types. The remaining four links are classified as HCM urban street facility types.

The specific arterial (urban street) class for each link is determined using Chapter 15, "Urban Streets." The appropriate urban street class is selected on the basis of the original FFS and local knowledge of the model study area. The following table shows the resulting selections.

HCM FACILITY TYPE CORRESPONDENCE

Link	Model Functional Class	HCM Facility Type
1	Suburban freeway	Freeway (basic segment)
2	Suburban freeway	Freeway (basic segment)
3	Freeway on-ramp	Urban street Class III
4	Freeway off-ramp	Urban street Class III
5	Major arterial	Urban street Class II
6	Major arterial	Urban street Class II

Estimating FFS for Freeway Links The FFS for the two freeway links are computed using Equation 23-1 from Chapter 23, "Basic Freeway Segments," and the default values for some of the required input data are found in Chapter 13, "Freeway Concepts."

Example Problem 1

A base FFS of 110 km/h is selected as being appropriate for an urban area freeway. The adjustments are shown in the following table, and the computed FFS is 102.7 km/h, which is rounded to 103 km/h.

FREEWAY FFS ADJUSTMENTS

Datum	Value	Adjustment
Lane width	3.6 m	0.0 km/h
Lateral clearance	3.0 m	0.0 km/h
Number of lanes	3	-4.8 km/h
Interchange density	0.63 int/km	-2.5 km/h
Sum		-7.3 km/h

Estimating FFS for Ramp and Arterial Links There is no procedure to estimate FFS for ramp and arterial links in this manual. Default values by street class, shown in Chapter 15, are used for the link FFS.

Estimating Capacities for Freeway Links The link capacities for the freeway links (basic segments) are estimated using Equation 30-1. The adjustment factors are computed according to the procedures described in Chapter 23, "Basic Freeway Segments." Default values for some of the required input data are obtained from Chapter 13, "Freeway Concepts." The following table shows the values used to calculate capacity.

COMPUTATION OF FREEWAY LINK CAPACITY

Datum	Value	Capacity Adjustment	Notes
PCE capacity	2350 pc/h/ln	2350	From Exhibit 23-2, LOS Criteria for Basic Freeway Segments
Lanes	3		Input
Heavy vehicles	5%, level terrain	0.976	Equation 23-3, Exhibit 13-5
Population	Commuter	1.000	Exhibit 13-5
Peak-hour factor	0.95	0.950	Input
Capacity (veh/h)		6537 veh/h	2179 veh/h/ln

Estimating Capacity for Freeway On-Ramp Links The link capacity for the freeway on-ramp is estimated using Equation 30-3. The adjustment factors are computed according to the procedures described in Chapter 16, "Signalized Intersections." Default values for some of the required input data are obtained from Chapter 10, "Urban Street Concepts." The on-ramp link capacity table shows the values used.

Estimating Capacity for Freeway Off-Ramp Links The link capacity for the freeway off-ramp links is estimated using Equation 30-3. The adjustment factors are computed according to the procedures described in Chapter 16, "Signalized Intersections." Default values for some of the required input data are obtained from Chapter 10, "Urban Street Concepts." Note that the off-ramp will have a signal at the foot of the ramp, so g/C is applied to the capacity of the off-ramp link. The off-ramp capacity table shows the values.

Estimating Capacities for Arterial Links The capacity for the arterial links is estimated using Equation 30-3. The adjustment factors are computed according to the procedures described in Chapter 16, "Signalized Intersections." Default values for some of the required input data are obtained from Chapter 10, "Urban Street Concepts."

COMPUTATION OF FREEWAY ON-RAMP LINK CAPACITY

Data	Value	Capacity Adjustment	Notes
Base saturation flow rate	1900 pc/h/ln	1900	Chapter 16, "Signalized Intersections"
Lanes	1	1	Input
Lane width	3.6 m	1.000	Exhibit 10-12 default
Heavy vehicles	2%	0.980	Exhibit 10-12 default
Grade	0%	1.000	Exhibit 10-12 default
Parking	None	1.000	Input
Bus blockage	None	1.000	Input
Area type	Non-CBD	1.000	Input
Lane utilization	100%	1.000	Single-lane ramp
Left turns	None	1.000	Input
Right turns	None	1.000	Input
Left pedestrian blockage	None	1.000	Input
Right pedestrian blockage	None	1.000	Input
g/C	None	1.000	Input
Peak-hour factor	0.95	0.950	Input
Capacity (veh/h)		1769 veh/h	

COMPUTATION OF FREEWAY OFF-RAMP LINK CAPACITY

Data	Value	Capacity Adjustment	Notes
Base saturation flow rate	1900 pc/h/ln	1900	Chapter 16, "Signalized Intersections"
Lanes	1	1	Input
Lane width	3.6 m	1.000	Exhibit 10-12 default
Heavy vehicles	2%	0.980	Exhibit 10-12 default
Grade	0%	1.000	Exhibit 10-12 default
Parking	None	1.000	Input
Bus blockage	None	1.000	Input
Area type	Non-CBD	1.000	Input
Lane utilization	100%	1.000	Single-lane ramp
Left turns	None	1.000	Input
Right turns	None	1.000	Input
Left pedestrian blockage	None	1.000	Input
Right pedestrian blockage	None	1.000	Input
g/C	0.45	0.450	Exhibit 10-12 default
Peak-hour factor	0.95	0.950	Input
Capacity (veh/h)		796 veh/h	

Note that some of the adjustment factors vary by number of lanes on the link, so the link capacities are computed twice, first for the two-lane link, then for the three-lane link. The two-lane and three-lane arterial capacity values are summarized in the following tables. Note that arterial capacity is independent of the arterial class in this example. The analyst may wish to adopt different default g/C values for each arterial class to better reflect local signal timing plans.

Example Problem 1

COMPUTATION OF TWO-LANE ARTERIAL LINK CAPACITY

Datum	Value	Capacity Adjustment	Notes
Base saturation flow rate	1900 pc/h/ln	1900	Chapter 16, "Signalized Intersections"
Lanes	2	2	Input
Lane width	3.6 m	1.000	Exhibit 10-12 default
Heavy vehicles	2%	0.980	Exhibit 10-12 default
Grade	0%	1.000	Exhibit 10-12 default
Parking	8/h	0.950	Exhibits 10-12 and 16-7
Bus blockage	2/h	0.996	Exhibits 10-12 and 16-7
Area type	Non-CBD	1.000	Input
Lane utilization	N/A	0.950	Exhibit 10-12
Left turns	None	1.000	Left-turn bays present
Right turns	None	0.985	Exhibit 16-7, shared lane
Left pedestrian blockage	None	1.000	Left-turn bays present, no left turns from through lanes
Right pedestrian blockage	Negligible	1.000	Input
g/C	0.45	0.450	Exhibit 10-12 default
Peak-hour factor	0.95	0.950	Input
Capacity (veh/h)		1409 veh/h	(705 veh/h/ln)

N/A = not available.

COMPUTATION OF THREE-LANE ARTERIAL LINK CAPACITY

Datum	Value	Capacity Adjustment	Notes
Base saturation flow rate	1900 pc/h/ln	1900	Chapter 16, "Signalized Intersections"
Lanes	3	3	Input
Lane width	3.6 m	1.000	Exhibit 10-12 default
Heavy vehicles	2%	0.980	Exhibit 10-12 default
Grade	0%	1.000	Exhibit 10-12 default
Parking	8/h	0.970	Exhibits 10-12 and 16-7
Bus blockage	2/h	0.997	Exhibits 10-12 and 16-7
Area type	Non-CBD	1.000	Input
Lane utilization	N/A	0.910	Exhibit 10-12
Left turns	None	1.000	Left-turn bays present
Right turns	None	0.985	Exhibit 16-7, shared lane
Left pedestrian blockage	None	1.000	Left-turn bays present, no left turns from through lanes
Right pedestrian blockage	Negligible	1.000	Input
g/C	0.45	0.450	Exhibit 10-12 default
Peak-hour factor	0.95	0.950	Input
Capacity (veh/h)		2070 veh/h	(690 veh/h/ln)

N/A = not available.

Computing Link Speeds The mean speed for each link is computed using Equation 30-4. Node delay will not be computed, so the equation for link speed simplifies to the link length (L) divided by the link traversal time (R); R is computed using Equation 30-5. The needed input values for this equation (R_o and D_o) are computed first. The free-flow link traversal time (R_o) is computed using Equation 30-6, with computed values shown in the following table.

Example Problem 1

COMPUTATION OF LINK FREE-FLOW TIME (R_0)

Link	HCM Class	Length (L) (km)	Free-Flow Speed, S_0 (km/h)	Free-Flow Time, R_0 (h)
1	Freeway	2.18	103	0.0212
2	Freeway	1.86	103	0.0181
3	Class III	0.45	55	0.0082
4	Class III	0.42	55	0.0076
5	Class II	0.30	65	0.0046
6	Class II	0.40	65	0.0062

The zero-flow control delay (D_0) is computed for the links with signals using Equation 30-7 and the default values of g/C and C provided in Exhibit 10-12. The delay adjustment factor is estimated assuming fixed-time signals, no progression for the off-ramp, and modest progression for the arterial links. The number of signals present on each link is estimated on the basis of the link length and the local knowledge of typical signal density. The exception is the off-ramp, which has only one signal at its endpoint. The following table lists the computed values.

COMPUTATION OF ZERO-FLOW CONTROL DELAY (D_0)

Link	Signals (N)	Delay Adjust (DF)	g/C	Cycle (s)	Zero-Flow Delay, D_0 (h)
1	None	N/A	N/A	N/A	0
2	None	N/A	N/A	N/A	0
3	None	N/A	N/A	N/A	0
4	1	1.00	0.44	120	0.0052
5	1	0.90	0.44	120	0.0047
6	1	0.90	0.44	120	0.0047

Note:
N/A = not applicable.

The volume to capacity ratio is computed for each link, with results listed in the following table.

LINK VOLUME TO CAPACITY RATIOS

Link	Model Functional Class	Demand (veh/h)	Capacity (veh/h)	Volume/Capacity
1	Suburban freeway	6792	6537	1.04
2	Suburban freeway	5173	6537	0.79
3	Freeway on-ramp	1492	1769	0.84
4	Freeway off-ramp	966	796	1.21
5	Major arterial	1330	1409	0.94
6	Major arterial	2157	2070	1.04

The values of J are selected from Exhibit 30-4. The mean link speed is computed as shown in the Computation of Mean Link Speed table.

Performance Measures The Computation of Performance Measures table illustrates the input data requirements, assumptions, and results for the computation of the performance measures for the six example links. The top part lists the input data (most of it computed in prior steps). The bottom part shows the results.

Example Problem 1

COMPUTATION OF MEAN LINK SPEED

Link	R ₀ (h)	D ₀ (h)	J	v/c	R (h)	L (km)	Speed (km/h)
1	0.0212	0	0.000006	1.04	0.0425	2.18	51
2	0.0181	0	0.000006	0.79	0.0183	1.86	102
3	0.0082	0	0.000200	0.84	0.0102	0.45	44
4	0.0076	0.0052	0.000200	1.21	0.1201	0.42	3
5	0.0046	0.0047	0.000200	0.94	0.0146	0.30	21
6	0.0062	0.0047	0.000200	1.04	0.0384	0.40	10

Notes:

- R₀ = free-flow traversal time
- D₀ = zero-flow control delay
- J = calibration parameter
- v/c = volume to capacity ratio
- R = traversal time
- L = length of link

COMPUTATION OF PERFORMANCE MEASURES

Link	1	2	3	4	5	6	Total
Type	Fwy	Fwy	On-ramp	Off-ramp	Arterial	Arterial	
Length (km)	2.18	1.86	0.45	0.42	0.30	0.40	5.61
Lanes	3	3	1	1	2	3	
Average vehicle occ.	1.2	1.2	1.2	1.2	1.2	1.2	
Demand (veh/h)	6792	5173	1492	966	1330	2157	
Capacity (veh/h)	6537	6537	1769	796	1409	2070	
Demand/capacity	1.04	0.79	0.84	1.21	0.94	1.04	
Speed (km/h)	51	102	44	3	21	10	
FFS (km/h)	103	103	55	55	65	65	
T (analysis period) (h)	1	1	1	1	1	1	
r (peak ratio)	0.7	0.7	0.7	0.7	0.7	0.7	
J parameter	0.000006	0.000006	0.000200	0.000200	0.000200	0.000200	
Storage (veh/km/ln)	75	75	130	130	130	130	
PkmT (km)	17 768	11 546	806	487	479	1035	32 121
PHT (h)	346	114	18	139	23	100	740
PHT free-flow (h)	173	112	15	9	7	16	332
Delay (person-h)	173	2	3	130	16	84	408
Speed (km/h)	51	102	44	3	21	10	43
Duration (h)	1.15	0.00	0.00	2.42	0.00	1.16	
Extent (km)	1.13	0.00	0.00	1.31	0.00	0.22	
Extent (% of link)	52%	0%	0%	311%	0%	56%	
Sensitivity	49%	0%	2%	49%	8%	40%	

The mean speed over all six links is 43.4 km/h. Significant amounts of delay are accumulated on those links with demand to capacity ratios greater than 1.00. The off-ramp has the highest demand to capacity ratio, highest delay, and the longest duration of delay (2.42 h). The queue will overflow the off-ramp and extend back onto the freeway. The extent of queue is 311 percent of the storage capacity of the ramp. The sensitivity results indicate that a 1 percent increase in the demand to capacity ratio on Links 1, 4, and 6 will cause a 40 to 49 percent increase in travel time on those links. All other links are comparatively insensitive to demand changes.

EXAMPLE PROBLEM 2. DETERMINE TRANSIT-SUPPORTIVE AREA OF A TRANSIT SYSTEM

The Situation As part of an overall review of its service, a transit operator wants to determine the accessibility of its system to its potential customers.

The Question Where are the city's transit-supportive areas and how well are they currently being served?

The Facts

- √ The transit operator provides fixed-route bus service to a population of 125,000. Two universities, a community college, and numerous government offices are scattered about the city.
- √ The city's transportation model contains population and employment figures at the transportation analysis zone (TAZ) level.
- √ The transit operator does not have access to GIS software, so the manual calculation method will be used for this example.

Comments

- √ The TAZ map is available in an electronic form that allows the areas of each TAZ to be calculated.
- √ Census data for the area indicate an average household size of 2.5 persons.

Outline of Solution Using the manual calculation method, the transit-supportive area is identified first. Next, the coverage area of the routes serving the transit-supportive TAZs is identified. Third, the approximate percentage of each transit-supportive TAZ served by transit is identified. Finally, the percentage of the total transit-supportive area served by transit is calculated to determine LOS.

Steps

1. Develop a spreadsheet from the data used for the transportation model, listing population, jobs, and area for each TAZ. Convert population to households by dividing by 2.5. Calculate household density for each TAZ by dividing the number of households by the TAZ area; calculate job density similarly. A TAZ is transit supportive if the household density is at least 7.5 households/gross hectare or the employment density is at least 10 jobs/gross hectare. This process is illustrated for two TAZs.

TAZ	Pop.	Jobs	Area (m ²)	Households	Area (hectares)	HH Density	Job Density
255	1134	308	1 017 046	453.6	101.7	4.46	3.03
399	345	852	497 767	138.0	49.8	2.77	17.1

In this example, TAZ 255 is not transit supportive, but TAZ 399 is. There are 174 transit-supportive TAZs in the system area.

2. For the transit-supportive TAZs identified in Step 1, draw the location of the bus routes serving those TAZs and draw 0.4-km buffers around each route, excluding any areas known not to have pedestrian access.

3. Twenty-four of the 174 transit-supportive TAZs are only partially served by transit. Estimate the percentage of the area of each of these TAZs served by transit. For example, TAZ 432 is about 50 percent served by transit.

4. Divide the transit-supportive area served by transit by the total transit-supportive area to determine the percentage of the transit-supportive area served, or LOS.

Example Problem 2

The Results The total transit-supportive area is 34 km², and 29 km² of it is covered by transit. As a result, 85 percent of this system's transit-supportive area is covered. Areas of the city that can support at least hourly bus service for the most part receive at least some service during the day. For policy reasons, or simply to connect two higher-density areas, most operators will serve a considerably larger area than the transit-supportive area.

EXAMPLE PROBLEM 3. EXAMPLE PROBLEM 2 USING GIS SOFTWARE

The Situation The same as in Example Problem 2 except that GIS software is used.

The Question Where are the city's transit-supportive areas and how well are they currently being served?

The Facts

- √ Same assumptions as in Example Problem 2.

Comments

- √ The transit agency contacts the local MPO, which has GIS software in house. Themes are obtained or created for streets (used as a base map), bus stops (used to identify the area served by transit), and TAZs (containing population and employment information).
- √ Census data for the area indicate an average household size of 2.5 persons.

Outline of Solution The area served by transit is identified by creating 0.4-km walk-distance buffers around each bus stop. This area is then intersected with the TAZ theme to create a new sub-TAZ theme that contains sub-TAZs that are entirely with or without transit service. Next, the GIS calculates the area of each sub-TAZ and the resulting household and employment density. Next, all sub-TAZs meeting the transit-supportive area criteria are identified and their areas summed. Finally, the sub-TAZs served by transit are identified and their areas summed. LOS is calculated by dividing the second area into the first.

Steps

1. Create 0.4-km buffers around each bus stop. Remove any areas where pedestrian access is not possible.
2. Update map using bus stop buffers.
3. Create a new service coverage theme from this buffer area. Intersect this theme with the TAZ theme, resulting in the new sub-TAZ theme.
4. Calculate the area, household, and employment density for each sub-TAZ.
5. Determine which sub-TAZs are transit-supportive and which are not.
6. Determine which transit-supportive TAZs are served by transit and which are not.
7. Sum the areas of the transit-supportive sub-TAZs served by transit and divide by the sum of the areas of all the transit-supportive sub-TAZs to obtain the service coverage LOS.

The Results The total transit-supportive area is 33.8 km², and 29.1 km² of it is covered by transit. As a result, 86 percent of this system's transit-supportive area is covered.

Example Problem 4

Comments

- √ Walk time to and from transit is assumed to average 3 min at each end of a trip.
- √ Wait time for transit is assumed to be 5 min at the start of a trip.
- √ Each transfer is assumed to add 10 min to a trip.
- √ Automobile trips to Anytown add 5 min for parking in garages and 3 min average walk time from parking garages to offices.
- √ Plentiful free parking is available at all work locations outside Anytown.
- √ Congestion in central Nutria adds 5 min to access the freeway system by car.

Outline of Solution Calculate the travel time between each pair of locations by automobile and by transit. Adjust these times by the criteria listed above to obtain door-to-door travel times. Subtract the adjusted automobile time from the adjusted transit time to obtain the travel time difference for each pair of locations and the resulting LOS.

Steps

1. Determine the automobile travel times (not including parking and off-highway congestion mentioned in the comments) between each pair of locations. For example, travel time between Juniper and Anytown is 48 min on the basis of the map.
2. Determine the transit travel times (including transfers but not including walk and wait time) between each pair of locations. For example, transit travel time between Juniper and Anytown is 63 min (from the map), plus a 10-min wait to transfer between routes in Chipville, for a total transit travel time of 73 min.
3. Adjust the travel times on the basis of the comments to obtain door-to-door travel times and calculate the travel time difference for each pair of locations. For example, the door-to-door automobile time from Juniper to Anytown is 56 min, including the 8 min required to park and walk. The door-to-door transit time is 84 min, including the 11 min required to walk and wait. The difference between automobile and transit travel times is 28 min.

The Results The radial route pattern serving Anytown provides reasonable transit-automobile travel time differences from everywhere within the metro area except Fish Valley. Service between suburbs is generally poor, as is often the case with a radial pattern, although some suburbs (e.g., Nutria) have relatively good service. Because of the number of transfers involved, transit travel times from Fish Valley are very high compared with those of the automobile, making transit an unattractive option for riders.

Possible improvements to service include the following:

1. Express service from distant suburbs to Anytown to reduce travel times.
2. Express crosstown routes between suburbs where demand warrants.
3. Decreasing the number of transfers required or improving timed transfers to reduce the average wait time in transferring between routes.
4. Transit priority measures on high-volume routes serving Anytown to make travel times even more competitive with those of the automobile.

IV. REFERENCES

1. Dowling, R. G., R. Singh, and W. W. K. Cheng. The Accuracy and Performance of Improved Speed-Flow Curves. *Road and Transport Research*, Vol. 7, No. 2, June 1998, pp. 36–51.
2. Dowling, R. G., W. Kittelson, J. Zegeer, and A. Skabardonis. *NCHRP Report 387: Planning Techniques to Estimate Speeds and Service Volumes for Planning Applications*. TRB, National Research Council, Washington, D.C., 1997.

3. Danaher, A., T. Parkinson, P. Ryus, and L. Nowlin. *TCRP A-15 Development of Transit Capacity and Quality of Service Principles, Practices, and Procedures*. Interim Report. Available on loan from Transit Cooperative Research Program, TRB, Washington, D.C., 1997.
4. O'Sullivan, S., and J. Morrall. Walking Distances to and from Light-Rail Transit Stations. In *Transportation Research Record 1538*, TRB, National Research Council, Washington, D.C., 1996.
5. Horowitz, A. J. Intersection Delay in Regionwide Traffic Assignment. In *Transportation Research Record 1572*, TRB, National Research Council, Washington, D.C., 1997.
6. Horowitz, A. J. *Delay Volume Relations for Travel Forecasting, Based on the 1985 Highway Capacity Manual*. FHWA, U.S. Department of Transportation, 1991.
7. Dowling, R. G. *Travel Model Speed Estimation and Post Processing Methods for Air Quality Analysis*. Final Report, Travel Model Improvement Program. DOT-T-98-5. U.S. Department of Transportation, 1997.
8. *Transit Capacity and Quality of Service Manual*. Transit Cooperative Research Program Web Document No. 6. TRB, National Research Council, Washington, D.C., 1999. Available online. <http://www4.nationalacademies.org/trb/crp.nsf/all+projects/tcrp+a-15>.
9. Pushkarev, B., and J. M. Zupan. *Public Transportation and Land Use Policy*. Indiana University Press, Bloomington, Ind., 1977.
10. Nelson\Nygaard Consulting Associates. *Tri-Met Primary Transit Network Phase II Report*. Portland, Oreg., 1997.

APPENDIX A. NODE DELAY ESTIMATION PROCEDURES

The following procedures describe how to estimate the most likely type of intersection control and the delay created by the intersection control under forecast traffic demands. These procedures require that the analyst have forecast demand and lane geometry for the subject approach, the opposing approach, and the cross-street approaches.

These node (i.e., intersection) delay procedures can be used either as a postprocessor to improve speed and delay estimates for air quality analysis or in a traffic assignment algorithm to improve the traffic forecasts themselves. The analyst should be warned that several steps in the procedure (identified below) will introduce discontinuities in the delay estimate, which can make it difficult, if not impossible, to reach closure in an equilibrium assignment process. It is also necessary to control for extreme inputs in the process.

ADAPTIVE NODE CONTROL PROCEDURE

Purpose, Input, Assumptions

This procedure determines if an intersection (node) that is currently unsignalized (or for which the current control is unknown) is likely to be an all-way stop and signalized in the future under forecast travel demand. Intersections failing to meet the criteria for signalization or all-way stop control (AWSC) are assumed to be two-way stop-controlled with stop signs on the minor-street approaches.

Analysts seeking to use this node control procedure in traffic assignment processes should recognize that changing control type might introduce discontinuities in the delay estimates. Analysts might wish to use the node control procedure to identify the node

The procedures will produce discontinuities in the delay estimate

Procedure uses MUTCD warrants for AWSC and peak-hour warrants for signal control

control types before entering the traffic assignment process. Other restrictions might be placed on the node control procedure as well. For example, once it is determined that a node is signalized, it might be kept that way, even if the forecast volumes in a subsequent iteration drop below the minimum required for a signal.

The required input is the average daily traffic (or peak-hour) forecasts for each approach to the intersection. The procedure is based on the presumption that as traffic demand increases at an uncontrolled or two-way stop intersection, AWSC or a traffic signal will be installed once the intersection volumes meet the *Manual of Uniform Traffic Control Devices (MUTCD)* 8-h warrants for all-way stops or peak-hour volume warrants for a signal. This procedure neglects all other possible warrants or considerations (such as accident history and delay) that go into the decision to install AWSC or a traffic signal. Exhibit A30-1 shows the volume regimes for several control types.

EXHIBIT A30-1. MINIMUM DEMAND CRITERIA FOR SIGNALS AND ALL-WAY STOPS

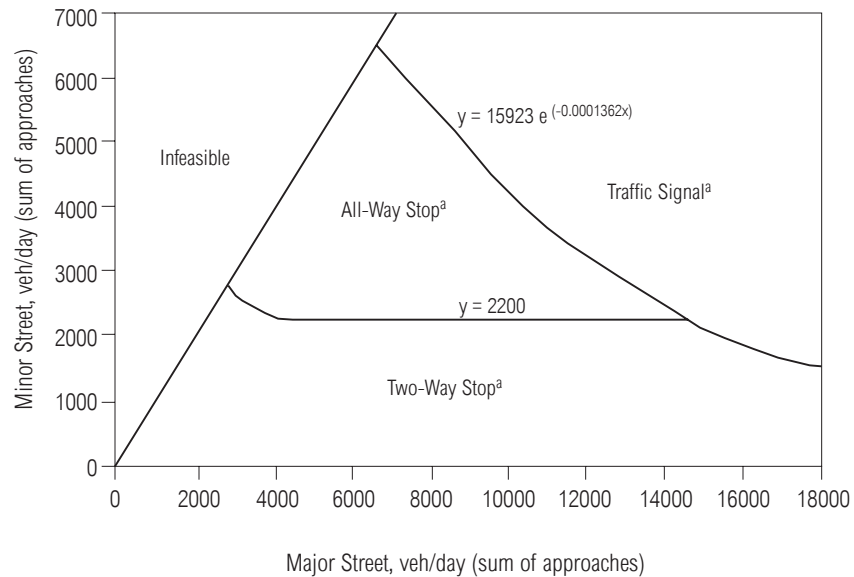

Note:

a. Roundabouts may be appropriate in some portions of these regimes.

Determining Likelihood of Signal Control

Equation A30-1 is adapted from MUTCD peak-hour volume warrants for signals assuming that the peak-hour volume is 10 percent of the daily volume for a two-or-more-lane approach major street intersecting a one-lane approach minor street.

First, identify the street (the two opposing approaches) with the highest combined approach volumes. This street becomes the major street. The other approaches are considered the minor street. If the sum of the minor-street approach volumes exceeds the value computed in Equation A30-1, the intersection will probably be signalized.

$$\text{Minor} \geq 15,923 * e^{\left(\frac{-1.362 * \text{Major}}{10,000}\right)} \tag{A30-1}$$

where

- Minor* = sum of minor-street approach volumes (veh/day), and
- Major* = sum of major-street approach volumes (veh/day).

If only peak-hour volumes are known, the daily traffic demand can be estimated by multiplying the peak-hour volumes by the inverse of the peak-to-daily ratio (typically 1/0.10, or 10).

Determining Likelihood of All-Way Stop Control

The minimum value of 2,200 veh/day is estimated from MUTCD peak 8-h volume warrants for AWSC assuming that daily traffic is twice the 8-h volume and that the major street has approach speeds of 64 km/h or greater. Pedestrian and delay warrants are not considered in this procedure.

If the sum of the minor-street approach volumes equals or exceeds 2,200 veh/day and the intersection fails the previous test for signal control, the analyst can conclude that the intersection is likely to be AWSC.

Consider a minor street with a forecast afternoon peak-hour demand of 100 veh/h on its eastbound approach and 200 veh/h on its westbound approach to the intersection. The major street has a forecast afternoon peak-hour demand of 500 veh/h on its northbound approach and 700 veh/h on its southbound approach. The afternoon peak hour has the highest total hourly demand at this intersection. Summing the approach volumes and multiplying by 10 (to convert peak-hour demand to daily traffic volumes) results in a minor-street volume of 3,000 veh/day and a major-street volume of 12,000 veh/day.

If the highest total hourly demand for the intersection comes close to but fails to meet the volume criteria for signalization, the analyst might check other hours when the minor-street demand is higher (but the major-street demand is lower) to see if the volume criteria are met under those conditions.

Entering the signal control equation with a major-street volume of 12,000 veh/day results in a computed minimum minor-street volume of 3,106. The intersection fails to meet the minimum volume criteria for signalization. However, the forecast 3,000 veh/day on the minor street does exceed the minimum volume criteria identified above for AWSC. The analyst concludes that the subject intersection is likely to have AWSC under the forecast demand.

SIGNAL NODE DELAY ESTIMATION

This procedure is used to estimate the average node delay (s/veh) for traffic on a single link approaching a signalized intersection at the end of the link. The procedure requires demand and geometric data for all approaches (the subject approach, the opposing approach, and the cross-street approaches) to the signalized node. These data include intersection (node) turning movements for all approaches (veh/h), intersection lane geometry (number of through lanes and exclusive turn lanes), and adjusted saturation flow rate (veh/h/ln) for through lanes.

The procedure is based on the proposition that the signal timing will respond to changes in demand at the intersection either through the installation of appropriate equipment (such as a traffic-actuated controller) or through routine maintenance (where signal timings are reviewed and recomputed on a regular basis).

The procedure also presumes that minor changes of intersection geometry, like designation of exclusive turn lanes, will also respond to changes in demand. Major improvements, such as the addition of more through lanes, are excluded from this assumption.

Assembling Input Data

Demand and geometric data are required for all approaches. The analyst should provide the demand rates in terms of vehicles per hour for each turning movement. Defaults for any other required geometric data can be obtained from Chapter 10, "Urban Street Concepts." If the turning lanes and control type are known, the procedures outlined in Chapter 10 are used to estimate node delay.

Developing a Phasing Plan

The following procedure can be used to identify a reasonable phasing plan for the intersection if the actual phasing plan is not known. This procedure can also be used to

Procedure assumes optimum signal timing

Procedure does not consider split phasing and protected-plus-permitted operation

forecast how the current phasing plan might change in response to changing traffic demands.

The phasing plan identifies the need for special phasing to protect left turns. It is assumed that if left-turn protection is provided on one approach, left turns will also be protected on the opposite approach.

Operational refinements, such as split phasing and protected-plus-permitted left-turn phasing, are not dealt with in this procedure. The analyst should select protected left-turn phasing in the case of protected-plus-permitted left-turn phasing. This selection will result in a modest underestimate of the actual intersection capacity. Two phasing plans are allowed in this method for each pair of opposing approaches at an intersection. The permitted phasing plan provides no protected phases for left turns. Exhibit A30-2 shows the operation of this phasing plan for a pair of opposing approaches. All movements on the street are allowed to move at the same time. Left turns must wait for gaps to appear in the opposing through traffic.

EXHIBIT A30-2. PERMITTED PHASING PLAN (NO. 1)

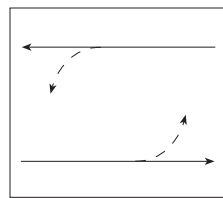

The protected phasing plan provides a green arrow for each left turn. Depending on the left-turn demand, one of the left-turn phases will finish early. The opposing through movement will then be allowed to move in parallel with the left turn that still has unserved demand. Eventually all of the left-turn demand is served. Then the remaining through movement is allowed to move in parallel with the opposite through movement. Exhibit A30-3 represents a possible stage in the signal cycle during which certain movements are allowed. The signal controller proceeds from left to right in the diagram as it decides which moves to serve next.

EXHIBIT A30-3. PROTECTED PHASING PLAN (NO. 3)

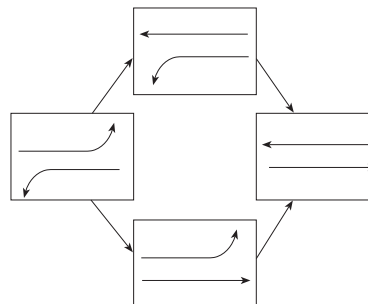

This procedure simplifies current tests in HCM, which are 50,000 for single lane, 90,000 for two lane, and 110,000 for three or more opposing lanes. Also, this procedure drops the left-turn sneaker check, which is usually less restrictive than the product check.

If the left-turn demand is less than 60 veh/h, there probably will be no left-turn protection. If the left-turn demand exceeds 240 veh/h, assume that there will be left-turn phases. For left-turn demands in between these two extremes, there probably will be left-turn protection if the product of the left and opposing through volumes equals or exceeds 40,000, as shown by Equation A30-2.

$$\text{if } V_L * V_o \geq 40,000, \text{ then left-turn protection is assumed} \quad (A30-2)$$

where

- V_L = left-turn demand (veh/h), and
- V_o = opposing through demand (veh/h).

If the left turns on one of the approaches meet the above conditions for protection, the opposite approach is also assumed to have protected left turns.

Dividing Approach into Lane Groups

An approach without left-turn protection is assumed to have no exclusive turn lanes. It is analyzed as one lane group consisting of all of the turn movement demand and lanes on the approach. If left turns are protected, assume that an exclusive left-turn lane is present. The left-turn demand and the left-turn lane become their own lane group. The remaining demand and lanes become part of the through-lane group. The remaining steps treat the turn volumes and saturation flows within each lane group as a single volume and a single saturation flow.

If no protected-phase operation occurs, it is assumed that no exclusive left-turn lanes exist

Computing Saturation Flows

The analyst should use the defaults suggested in Chapter 10, "Urban Street Concepts," and the procedure provided in Chapter 16, "Signalized Intersections," to estimate the saturation flow rate for each lane group.

Critical Phase Pairs and Computing Critical Sum

Exhibit A30-4 illustrates the rules for an east-west street. The same rules apply for the north-south street by substituting north and south for east and west in the table. The critical pair of phases (for each pair of opposing approaches) or the critical phase (if permitted phasing is present) is identified according to the rules shown in the exhibit. The critical phase pair volume to saturation ratio for each street is computed by summing the v/s ratios for the identified critical phase pair (no summing is required for permitted phasing).

EXHIBIT A30-4. CRITICAL PHASE PAIR

Phase Plan	Critical Phase Pair
Protected	Max(EL + WT, WL + ET)
Permitted	Max(EL, ET, WL, WT)

v/s ratio is the measure used

Note:

- EL = eastbound left-turn v/s ratio
- ET = eastbound through v/s ratio, or maximum of either eastbound through or eastbound right-turn v/s ratios if exclusive right-turn lane is present.
- WL, WT = same as above but for westbound approach.

The sum of critical v/s ratios (CVS) for the intersection is computed using Equation A30-3 by summing the v/s ratios for the critical phase pairs for each street.

$$CVS = EW + NS \tag{A30-3}$$

where

- CVS = sum of critical v/s ratios,
- EW = sum of v/s ratios for critical phase pair for east-west street, and
- NS = sum of v/s ratios for critical phase pair for north-south street.

Estimating Lost Time per Cycle

The total lost time per cycle is estimated on the basis of the phasing plan for each street according to Exhibit A30-5.

EXHIBIT A30-5. LOST TIME PER CYCLE

Major Street	Cross Street	Total Lost Time (s)
Protected	Protected	16
Protected	Permitted	12
Permitted	Protected	12
Permitted	Permitted	8

Note:
This table assumes 4 s lost time per phase change.

Estimating Cycle Length

Target v/c = 0.90

The signal cycle length is estimated using Equation A30-4, which assumes that the goal of the signal timing plan is to maintain an overall 90 percent volume to capacity ratio for the intersection within the acceptable limits for cycle length. The computed cycle length should not be allowed to go below the minimum cycle length required to serve pedestrians at the intersection (60 s has been selected here, but it can be much higher or slightly lower depending on the street widths). The computed cycle length using Equation A30-4 should also not be allowed to exceed the local agency acceptable maximum cycle length (150 s has been selected here).

$$C = \frac{TL}{[1.0 - \text{Min}(1.0, 0.90 * CVS)]} \tag{A30-4}$$

Subject to $60 \leq C \leq 150$ s

where

- C = estimated signal cycle length (s),
- TL = total intersection lost time (s),
- 0.90 = target volume to capacity ratio for intersection, and
- CVS = sum of critical v/s ratios for intersection.

Estimating Effective Green Time

Green time estimation results in balance of v/c for critical movements

The procedure for estimating the effective g/C ratio for each movement on the subject approach at the intersection varies according to the phasing plan for the approach. For permitted phasing, use Equation A30-5.

$$g/C = \frac{\text{Max}(EL, ET, WL, WT)}{\left(CVS + \frac{TL}{C}\right)} \tag{A30-5}$$

where

- g/C = effective green time per cycle for subject approach;
- EL, WL = v/s ratios for eastbound and westbound left-turn movements, respectively;
- ET, WT = v/s ratios for the eastbound and westbound through movements, respectively (if separate right-turn lane is present, these become maximum of through or right-turn v/s ratios for each compass direction);
- CVS = sum of critical v/s ratios;
- TL = total intersection lost time (s); and
- C = signal cycle length (s).

The green time estimation procedures equalize the volume to capacity ratios for each critical phase but do not necessarily optimize the green times to minimize overall delay at the intersection. Also, there is no check to ensure that the green times are sufficient to serve pedestrians. Analysts using this procedure in a traffic assignment algorithm may need to set limits on the maximum and minimum estimated g/C to facilitate reaching equilibrium.

The procedure for a protected phasing plan requires the estimation of g/C ratios for the critical phase pair for the subject street and then the estimation of the g/C ratios for the noncritical phases of the subject street. Equations A30-6 through A30-9 are for the case in which the eastbound left and the westbound through are the critical phase pair for the east-west street. These equations can be generalized to other cases by substituting the appropriate directions and turn movements.

Critical Phase Pair:

$$\frac{g}{C_{(EL)}} = \frac{EL}{\left(CVS + \frac{TL}{C}\right)} \quad (A30-6)$$

$$\frac{g}{C_{(WT)}} = \frac{WT}{\left(CVS + \frac{TL}{C}\right)} \quad (A30-7)$$

Noncritical Phases:

$$\frac{g}{C_{(ET)}} = \frac{ET}{(ET + WL) \left[\frac{g}{C_{(EL)}} + \frac{g}{C_{(WT)}} \right]} \quad (A30-8)$$

$$\frac{g}{C_{(WL)}} = \frac{g}{C_{(EL)}} + \frac{g}{C_{(WT)}} + \frac{g}{C_{(ET)}} \quad (A30-9)$$

where

- $\frac{g}{C^{**}}$ = effective green time per cycle for designated direction (eastbound, westbound) and turn movement (left and through);
- EL, ET, WL, WT = v/s ratios for eastbound left-turn phase, eastbound through phase, westbound left-turn phase, and westbound through phase, respectively;
- CVS = sum of critical v/s ratios;
- TL = total intersection lost time (s); and
- C = signal cycle length (s).

If there is an exclusive right-turn lane group on an approach, the maximum of the through or right-turn v/s ratio is substituted for the through v/s ratio in the above equations. The right-turn g/C for the subject approach is then set equal to the computed g/C ratio for the subject approach through movement.

Estimating Control Delay

The delay for all vehicles using a single approach of the intersection is computed using Equations A30-10 and A30-11.

$$D_a = \frac{(D_l * V_l) + (D_t * V_t) + (D_r * V_r)}{V_l + V_t + V_r} \quad (A30-10)$$

where

- D_a = mean delay for subject approach (s/veh);
- D_l, D_t, D_r = estimated delay for left turns, through vehicles, and right turns, respectively (s/veh); and
- V_l, V_t, V_r = volumes (demand) for left-turn lane group (if present), through lane group, and right-turn lane group (if present), respectively (veh/h).

The delay for each lane group is computed using Equation A30-11.

$$D = \frac{0.5C\left(1 - \frac{g}{C}\right)}{1 - \text{Min}(1.0, X) * \frac{g}{C}} + 900T \left[(X - 1) + \sqrt{(X - 1)^2 + \frac{4X}{T * s * \frac{g}{C}}} \right] \quad (\text{A30-11})$$

where

- D = mean delay for subject lane group (s/veh);
- C = signal cycle length (s);
- g = effective green time including yellow time (s);
- X = $(v/s)/(g/C)$, the volume to capacity ratio,
- T = duration of analysis period (h);
- s = saturation flow for subject lane group (veh/h); and
- v = demand for subject lane group (veh/h).

ESTIMATING DELAY FOR TWO-WAY STOP CONTROL

This procedure is used to estimate the mean delay (s/veh) to vehicles on a stop-controlled approach where not all of the other legs of the intersection are stop controlled (for example, two-way stops). The required input comprises turning movements (veh/h) and lane configuration for all approaches.

The procedure neglects the impacts of grade, heavy vehicles, wide medians, upstream signals, and flared approaches on the capacity of a stop-controlled intersection. To simplify the calculations, it is assumed that left-turn lanes are always present on the major street. Right-turn islands on the major street (which would allow right turns to be neglected for certain minor-street movements) are also neglected in this analysis.

Assembling Input Data

Hourly demand (veh/h) is required for each possible turning movement at the intersection. The presence or absence of exclusive right-turn lanes on the major (uncontrolled) street and on the minor (stop-controlled) street approaches must be known. The presence or absence of multiple through lanes on the major- and minor-street approaches does not affect the capacity and delay calculations for the minor-street stop-controlled approach, so these data are not required.

This procedure groups minor-street lefts with the through movement (to simplify the analysis), so the presence or absence of left-turn lanes on the minor street need not be known. The opposing approaches with the highest total approach volume are designated the uncontrolled approaches to the intersection and are assumed to have zero delay.

Estimating Major-Street Left-Turn Lane Capacity

The capacity of each left-turn lane on the major street (the uncontrolled street) is determined using Equation A30-12.

$$c_L = V_o \frac{e^{\left(-V_o \frac{4.1}{3600}\right)}}{\left[1 - e^{\left(-V_o \frac{2.2}{3600}\right)}\right]} \quad (\text{A30-12})$$

where

- c_L = capacity of major-street left-turn lane (veh/h),
- V_o = through-plus-right-turn volume opposing the left turns (veh/h),
- 4.1 = critical gap (t_c) (s), and
- 2.2 = follow-up time (t_f) (s).

Also refer to Equation 17-1

Estimating Minor-Street Stop Capacity

The capacity of the minor-street approach (one of the stop-controlled approaches) is computed using Equation A30-13.

$$c_s = \frac{V_c * e^{\left(\frac{-V_c * 6.5}{3600}\right)}}{\left[1 - e^{\left(\frac{-V_c * 4.0}{3600}\right)}\right] \left(1 - \frac{V_{EBLT}}{C_{EBLT}}\right) \left(1 - \frac{V_{WBLT}}{C_{WBLT}}\right)} \quad (\text{A 30-13})$$

where

- C_S = capacity of stop-controlled approach (veh/h);
- V_c = conflicting volume (veh/h);
- 6.5 = critical gap (t_c) (s);
- 4.0 = follow-up time (t_f) (s);
- V_{EBLT}, C_{EBLT} = left-turn volume and left-turn capacity for one direction of travel on major street, respectively; and
- V_{WBLT}, C_{WBLT} = left-turn volume and left-turn capacity for other direction of travel on major street, respectively.

The conflicting volume is computed using Equation A30-14, which assumes that the subject approach is northbound and the major street is an east-west street.

$$V_c = 2 * V_{EBLT} + V_{EBTH} + 0.5 * V_{EBRT} + 2 * V_{WBLT} + V_{WBTH} + V_{WBRT} \quad (\text{A30-14})$$

where

- V_{EBLT}, V_{WBLT} = left-turn volumes (eastbound and westbound) on major street (veh/h);
- V_{EBTH}, V_{WBTH} = through volumes (eastbound and westbound) on major street (veh/h);
- V_{EBRT} = eastbound right-turn volume (veh/h), set to zero if there is an exclusive right-turn lane; and
- V_{WBRT} = westbound right-turn volume (veh/h).

Estimating Minor-Street Delay

The mean vehicular delay for the subject stop-controlled approach is computed according to Equation A30-15, which gives the same result as Equation 17-38.

$$D = 5 + \frac{3600X}{v} + 900T(X - 1) + \sqrt{(X - 1)^2 + \frac{8X^2}{Tv}} \quad (\text{A30-15})$$

where

- D = mean delay per vehicle (s/veh),
- X = ratio of demand (v) to capacity of stop-controlled approach (veh/h),
- T = duration of analysis period (h), and
- v = total volume on subject approach (veh/h).

ESTIMATING DELAY FOR ALL-WAY STOP CONTROL

This procedure is used to estimate the vehicle delay for an intersection with AWSC. The method requires the hourly demand rate and the number of lanes on each approach to the intersection.

The procedure assumes that 10 percent of each approach volume is left turns and 10 percent is right turns. It also assumes 5 percent trucks, a peak-hour factor of 1.00, and an analysis period of 1-h duration. The procedure assumes that the peak-direction flow on each street is twice the reverse-direction flow. The procedure neglects the impacts of exclusive turn lanes, upstream signals, and two-stage gap acceptance (when a median is present) on intersection capacity and delay.

Assembling Input Data

The total hourly approach volume and the number of lanes (including exclusive turn lanes) are required for the subject approach. The sum of the approach volumes on the other approaches to the intersection is also required.

Computing Delay by Approach

The delay on the subject approach is estimated from Exhibit A30-6 on the basis of the subject approach volume (v_a). The sum of the approach volumes for the other approaches (v_o) is used to select the appropriate curve for single-lane approaches. Exhibit A30-6 was obtained by statistically fitting curves to the results of several computations of AWSC delay for different levels of demand. These curves are not considered to be as accurate as actual computations made using Chapter 17 methodology.

The curves are inappropriate for $V_o < 400$ veh/h or $V_o > 1,600$ veh/h

EXHIBIT A30-6. EXAMPLE APPROACH VOLUME VERSUS DELAY

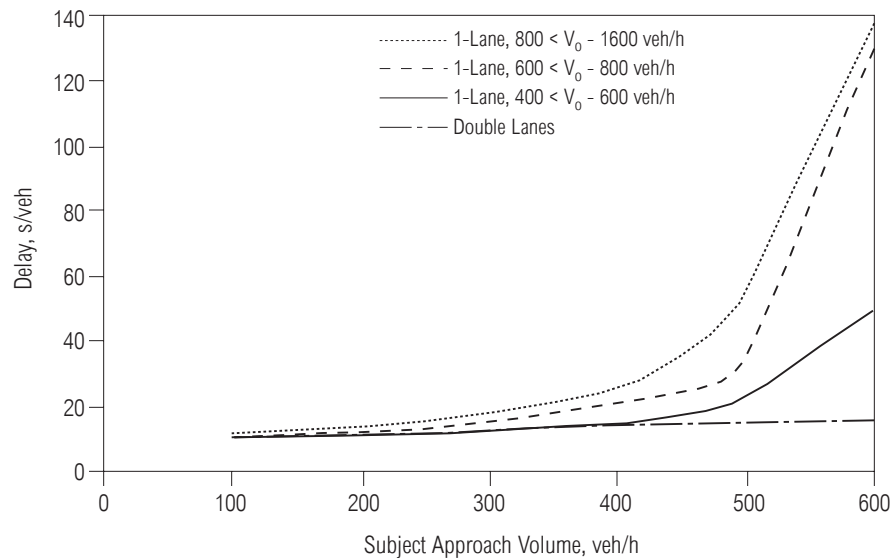

Notes:

a. The following equations may be used to model the curves in the exhibit. If v_o is between 400 and 600 veh/h:

$$D = 2967.4z^4 - 3159.3z^3 + 1203.5z^2 - 172.77z + 17$$

If v_o is between 601 and 800 veh/h:

$$D = 49114z^5 - 69818z^4 + 37486z^3 - 9292.8z^2 + 1069.2z - 35$$

If v_o is between 801 and 1600 veh/h:

$$D = 6358.4z^4 - 5918.4z^3 + 2019.7z^2 - 261.49z + 22$$

where

v_o = sum of approach volumes on nonsubject approaches (veh/h),

D = mean delay on subject approach (s), and

z = subject approach volume divided by 1000 (veh/h/1000).

Delay for double lanes is computed by the following equation:

$$D = 185.48z^4 - 307.22z^3 + 184.37z^2 - 34.719z + 12$$

b. These curves are not reliable if $V_o < 400$ veh/h or $V_o > 1600$ veh/h.

APPENDIX B. MULTIPERIOD CONGESTION ANALYSIS

This procedure is designed for analyzing the carryover effects of congestion from one subperiod within the peak to the following subperiod. The peak period is divided into four analysis subperiods. The demand for each subperiod is compared with capacity,

Procedure allows for analyzing carryover of congestion between subperiods

and any resulting queues are carried over to the following subperiod. The demand rate within each subperiod is assumed to be constant. Exhibit B30-1 shows required inputs. Queue polygons are then constructed to estimate total delay, mean delay, and the total duration of queuing (see Exhibit B30-2).

If none of the demand rates exceeds the capacity, there is no congestion and no need to continue with this procedure. The demand rate for the last time subperiod must be less than the capacity, or the queue will never clear, as shown in Exhibit B30-2.

EXHIBIT B30-1. REQUIRED INPUTS

Subperiod Number	Length of Subperiod (h)	Demand Rate (veh/h)
1	P_1	V_1
2	P_2	V_2
3	P_3	V_3
4	P_4	V_4

EXHIBIT B30-2. DEMAND CHECKS

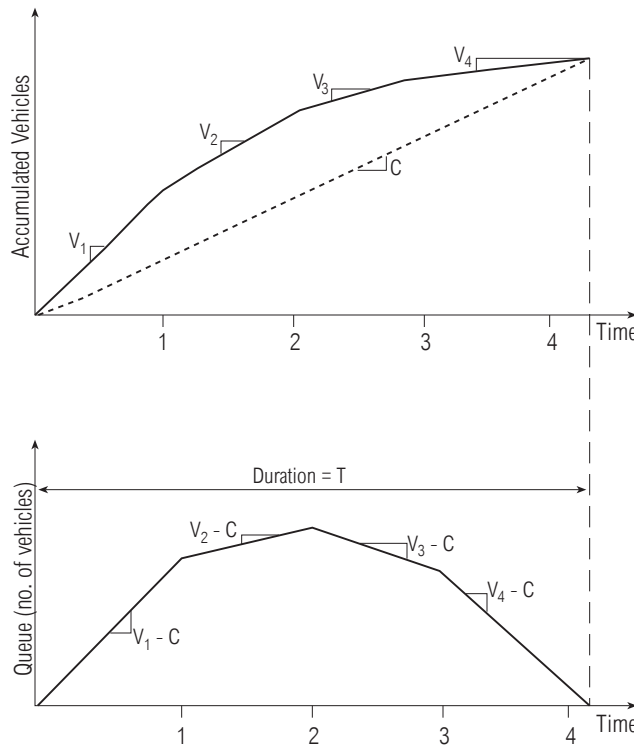

DETERMINING WHEN QUEUE FIRST OCCURS

- If $V_1 > c$, then queue starts in Subperiod 1;
- Else if $V_2 > c$, then queue starts in Subperiod 2;
- Else if $V_3 > c$, then queue starts in Subperiod 3;
- Else if $V_4 > c$, then queue starts in Subperiod 4 and there is a fatal error.

If none of the above is true, there is no queuing. Renumber the subperiods to start with Subperiod 1 for the first subperiod where queuing occurs.

First subperiod with queue is redesignated as Subperiod 1

DETERMINING WHEN QUEUE CLEARS

For Case A, the queue builds in Subperiod 1. It completely clears in Subperiod 2. It builds again in Subperiod 3. It clears in Subperiod 4 as shown in Exhibit B30-3. The analyst should perform the remainder of the queuing analysis procedure twice, once for Subperiods 1 and 2 and a second time for Subperiods 3 and 4.

EXHIBIT B30-3. QUEUE CLEARING CASES

Case A	If $P_1(V_1 - C) \leq P_2(C - V_2)$	Queue clears Subperiod 2
Case B	Else if $P_1(V_1 - C) + P_2(V_2 - C) \leq P_3(C - V_3)$	Queue clears Subperiod 3
Case C	Else queue clears in Subperiod 4	Subperiod 4 is extended in length as necessary to clear the queue

COMPUTING PERFORMANCE MEASURES

Vehicle-hours of travel, delay, and duration of queuing are computed using Equations B30-1, B30-2, and B30-3.

$$VHT = \frac{1}{2} \left\{ \sum_i^k (V_i - C) \left[P_i^2 + P_i \frac{\sum_j^k P_j (V_j - C)}{C - V_{k+1}} \right] \right\} + R \tag{B30-1}$$

where

- P = length of subperiod (h),
- V = demand (veh/h),
- C = capacity (veh/h),
- i, j = subperiod indices,
- K = parameter (see Exhibit B30-4), and
- R = parameter (see Exhibit B30-4).

EXHIBIT B30-4. VALUES FOR PARAMETERS K AND R

Case	K	R
A	1	0
B	2	$(V_1 - C_1) * P_1 * P_2$
C	3	$(V_1 - C_1) * P_1 * (P_2 + P_3) + (V_2 - C_2) * P_2 * P_3$

$$\text{MeanDelay (min)} = \frac{60(VHT)}{V_1 + V_2 + V_3 + V_4} \tag{B30-2}$$

$$T = \sum_i^k P_i + \frac{\sum_j^k P_j (V_j - C)}{C - V_{k+1}} \tag{B30-3}$$

If the duration of the queuing is greater than the length of the peak-period input, the analyst may wish to rerun the analysis using a longer peak period.

APPENDIX C. ALTERNATIVE TRAVEL TIME EQUATION FOR OLDER SOFTWARE

Some older software may not be able to implement the above travel time equation, so a formula (Equation C30-1) and recommended parameters for the more traditional Bureau of Public Roads (BPR) curve are provided here as an alternative method for estimating link traversal times. Exhibits C30-1 and C30-2 show the recommended BPR parameters for freeways, multilane highways, and arterials, respectively.

$$R = R_o \left[1 + a \left(\frac{v}{c} \right)^b \right] \tag{C30-1}$$

where

- R = link travel time (h),
- R_o = link travel time at free-flow link speed (h), and
- a and b = BPR parameters (Exhibit C30-1 and C30-2).

EXHIBIT C30-1. RECOMMENDED BPR PARAMETERS: FREEWAYS AND MULTILANE HIGHWAYS

Facility Type	Free-Flow Speed (km/h)	Speed at Capacity (km/h)	a	b
Freeway	120	86	0.39	6.3
	112	85	0.32	7.0
	104	83	0.25	9.0
	96	82	0.18	8.5
	88	80	0.10	10.0
Multilane highway	96	88	0.09	6.0
	88	82	0.08	6.0
	80	75	0.07	6.0
	72	67	0.07	6.0

Notes:
These parameters (a and b) are for BPR equations using capacity rather than practical capacity. LOS C service volumes.

EXHIBIT C30-2. RECOMMENDED BPR PARAMETERS: ARTERIALS

Arterial Class	Free-Flow Speed (km/h)	Signal Spacing (signals/km)	Speed at Capacity (km/h)	a	b
Class I	80	0.33	53	0.34	4.0
	80	1.0	31	0.74	5.0
	80	2.5	15	1.16	6.0
Class II	65	0.50	40	0.38	5.0
	65	1.0	28	0.70	5.0
	65	2.0	18	1.00	5.0
Class III	55	2.0	17	0.96	5.0
	55	3.0	13	1.00	5.0
	55	4.0	10	1.40	5.0
Class IV	50	4.0	10	1.11	5.0
	50	5.0	8	1.20	5.0
	50	6.0	7	1.50	5.0

Notes:
These parameters (a and b) are for BPR equations using capacity rather than practical capacity. LOS C service volumes.

CHAPTER 31

SIMULATION AND OTHER MODELS

CONTENTS

I. INTRODUCTION31-1

II. TRAFFIC SIMULATION MODELS31-2

III. SIMULATION MODEL DESCRIPTORS31-3

 Stochastic and Deterministic Models31-4

 Event-Based and Time-Based Models31-4

 Micro-, Macro-, and Mesoscopic Models.....31-4

 Static Flow and Time-Varying Flow Models31-5

 Descriptive and Normative Models.....31-5

 Off-Line and Real-Time Models31-6

IV. ILLUSTRATIVE SIMULATION MODEL NUMERICAL EXERCISES31-6

 Gap-Acceptance Model31-7

 Pretimed Signal Operation31-10

 Single Toll Booth31-12

 Car Following31-14

V. TYPICAL APPLICATIONS OF MODELS31-16

 Performance Measures31-17

 Applying a Model.....31-18

 Determining Project Scope31-18

 Assessing HCM Methodologies31-19

 Selecting a Model31-19

 Model Capabilities31-19

 Data Availability31-20

 Ease of Use31-21

 Required Resources31-21

 Model Applications and Past Performance31-22

 Validation and Calibration31-22

 Assembling Data31-22

 Inputting Data31-22

 Calibrating and Validating Models31-22

 Analyzing Output31-23

 Analyzing Alternatives31-24

VI. EXAMPLE PROBLEMS31-25

 Example Problem 131-26

 Example Problem 231-28

 Example Problem 331-30

VII. REFERENCES31-32

EXHIBITS

Exhibit 31-1. Continuum of Traffic Models31-1

Exhibit 31-2. Simulation Model Strengths.....31-2

Exhibit 31-3. Simulation Model Shortcomings31-2

Exhibit 31-4. Typical Input and Output Parameters for Traffic
Simulation Models31-3

Exhibit 31-5. Ramp Terminal31-7

Exhibit 31-6. Distribution of Eastbound Headways31-8

Exhibit 31-7.	Gap-Acceptance Model Numerical Exercise	31-9
Exhibit 31-8.	Vehicles Incurring Delay	31-10
Exhibit 31-9.	Simple Two-Phase Signal	31-11
Exhibit 31-10.	System State Versus Time During Pretimed Signal Operation	31-12
Exhibit 31-11.	System State Versus Time During Toll Booth Operations	31-13
Exhibit 31-12.	Stochastic Toll Booth Model	31-13
Exhibit 31-13.	State Trends: Stochastic Model	31-14
Exhibit 31-14.	Summary of Typical Model Applications	31-16
Exhibit 31-15.	Performance Measures for Interrupted-Flow HCM Methodologies	31-17
Exhibit 31-16.	Performance Measures for Uninterrupted-Flow HCM Methodologies	31-17
Exhibit 31-17.	Model Selection and Application	31-18

I. INTRODUCTION

This chapter focuses on simulation and other models that are useful for highway capacity analysis. It provides an overview of models relating to highway capacity and gives guidance regarding the selection of models other than those in the HCM. Clearly, readers should use the material presented here in conjunction with other documents that also address traffic operations modeling. An extensive reference list of such documents is provided (I-108).

It is well recognized that the HCM models are part of a continuum available to the analyst. For example, planners and engineers have different needs in scope and level of detail. Planners focus on network performance in broad, general terms to understand supply-demand interactions between network capacity and flows. Their main interest is at the level of land use impacts and transportation planning. Engineers, on the other hand, need to know how changes to the design of a specific facility or in the way it operates will affect how it performs in terms of capacity, delays, queuing characteristics, and other measures. The classic observation is that for planners, capacity is an input; for engineers, it is an output.

Exhibit 31-1 depicts the differences among these perspectives and the models used to address the issues involved. Planning models tend to focus on large geographic areas, encompassing hundreds of links and nodes. Their objective is to provide insights regarding network performance based on projections of future traffic patterns and strategies for network expansion, improvement, and capacity enhancement. These models represent traffic at a macroscopic (flow-variable) level of detail and rely on equations to capture the relationships between capacity and flow.

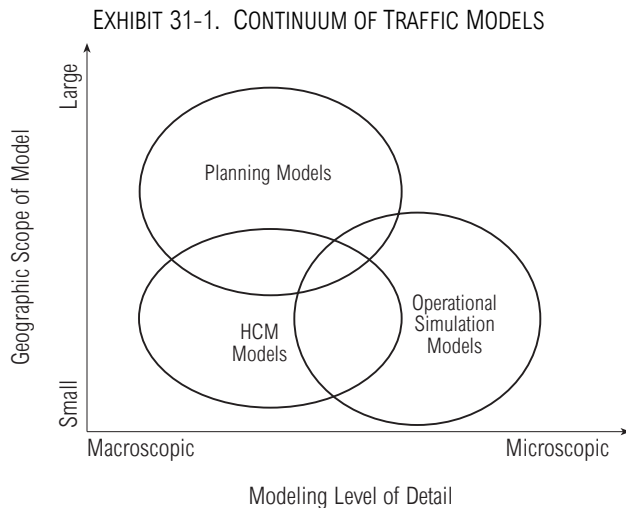

Traffic demands are variable and time dependent, and the paths used by vehicles to traverse the network typically are sensitive to the capacity provided. This sensitivity is created by the changes in travel time that capacity additions afford. HCM methodologies tend to focus on individual network elements: specific facilities or collections of facilities. Their intent is to assess the level of service (LOS) provided by a particular facility with a given configuration and operational plan in response to the traffic flows being accommodated. As a result, the geographic area being represented ranges from a single point to a small region. The HCM methods represent traffic flows with variables that reflect the flow dynamics. These methods stop short of representing the movements of individual vehicles. The intent is to employ calculations that can be done by hand, using a set of worksheets, or by computer, using a series of spreadsheets (iterative or noniterative).

Different perspectives or objectives may require use of different models for the same area

Planning models focus on large geographic areas

Simulation, empirical, and analytical models defined

II. TRAFFIC SIMULATION MODELS

Traffic simulation models use numerical techniques on a digital computer to create a description of how traffic behaves over extended periods of time for a given transportation facility or system. As compared with empirical and analytical models, simulation models predict performance by stepping through time and across space, tracking events as the system state unfolds. Time can be continuous or discrete, and system state is a technical term that effectively describes the status or current condition of the system. Empirical models predict system performance on the basis of relationships developed through statistical analysis of field data, whereas analytical models express relationships among system components on the basis of theoretical considerations as tempered, validated, and calibrated by field data.

There are several strengths and shortcomings of simulation models. Exhibits 31-2 and 31-3 summarize these attributes.

EXHIBIT 31-2. SIMULATION MODEL STRENGTHS

- Other analytical approaches may not be appropriate
- Can experiment off-line without using on-line trial-and-error approach
- Can experiment with new situations that do not exist today
- Can yield insight into what variables are important and how they interrelate
- Can provide time and space sequence information as well as means and variances
- Can study system in real time, compressed time, or expanded time
- Can conduct potentially unsafe experiments without risk to system users
- Can replicate base conditions for equitable comparison of improvement alternatives
- Can study the effects of changes on the operation of a system
- Can handle interacting queuing processes
- Can transfer unserved queued traffic from one time period to the next
- Can vary demand over time and space
- Can model unusual arrival and service patterns that do not follow more traditional mathematical distributions

EXHIBIT 31-3. SIMULATION MODEL SHORTCOMINGS

- There may be easier ways to solve the problem
- Simulation models require considerable input characteristics and data, which may be difficult or impossible to obtain
- Simulation models may require verification, calibration, and validation, which, if overlooked, make such models useless or not dependable
- Development of simulation models requires knowledge in a variety of disciplines, including traffic flow theory, computer programming and operation, probability, decision making, and statistical analysis
- The simulation model may be difficult for analysts to use because of lack of documentation or need for unique computer facilities
- Some users may apply simulation models and not understand what they represent
- Some users may apply simulation models and not know or appreciate model limitations and assumptions
- Results may vary slightly each time a model is run

Traffic simulation models focus on the dynamic of traffic flow. They can represent a range of situations from a single facility to an entire network. Some implicit assumptions include interdependencies between the traffic objects (vehicle headways, origin-destination flow patterns), processing capabilities of the physical places (saturation flow rates, capacities, delay relationships), and processing logic (signal timing controls). Exhibit 31-4 summarizes typical input and output parameters that are associated with traffic simulation models.

EXHIBIT 31-4. TYPICAL INPUT AND OUTPUT PARAMETERS FOR TRAFFIC SIMULATION MODELS

Parameters	Descriptions
Input	
Traffic Objects	Object vehicles pass through the facility or system
Physical Places	Locations where vehicles can be in the system
Processing Logic	Includes capacity relationships, driver behavior rules, path choice rules, and signal control rules
Other Resources	Include traffic control devices used to control vehicle flow and vehicular conflicts like permissive left turns
Output	
Flow of Traffic	Includes travel times, paths chosen, delay, time spent in queues
Use of Physical Places	v/c ratios and use of facilities by vehicle types
Use of Other Resources	Includes percent of green time used

A related family of models, vehicle simulation models, predict how vehicles behave as they interact with the highway environment. The focus of these models is often the vehicle’s propulsion, braking, suspension, and other systems. Car-following models, when they exist on a stand-alone basis, fall into this category. Their main purpose is to predict how the vehicle accelerates, decelerates, and changes lanes as it responds to the highway geometry and the actions of other vehicles. Car-following models are often part of more detailed traffic simulation models.

III. SIMULATION MODEL DESCRIPTORS

Four fundamental descriptors are commonly used in highway capacity-related simulation models: state variables, events that are possible, time-step logic, and processing logic. To describe a complete model, all four attributes must be specified, and in combination, they must represent a unified and consistent model. In most situations, many model options are available. The choice depends on the level of detail desired, the computer platform available, the data required (and acquirable), and the inherent capabilities of the model language used if the model does not contain its own inherent logic.

State variables can be either discrete or continuous, and some models may involve a combination of both. In any case, the state variables must be sufficient to represent the state of the system at all points in time.

The events attribute captures all changes in system state. For the pretimed signal operation numerical exercise in Section IV of this chapter, six events occur during each cycle, one for each change in signal indications. For the car-following numerical exercise, continuous variables and the system state change each time step as the car positions and speeds change. For such models, a major issue is what the duration of the time steps should be without jeopardizing the model predictions of how the state will change value over time.

The processing logic determines how the state variables change with time. There are two common forms of processing logic: if-then rules and predictive equations. In the first case, the logic is that if the state of the system is x at time t , then it will be y at time $t + 1$. For example, if the signal is currently in interval n , the system will transition to state (interval) $n + 1$ when that interval n has terminated.

If predictive equations are involved, the logic states that variable x is predicted to have a rate of change $\delta x(t)$ during the time step commencing at t and thus it is expected to change by $\Delta x = \delta x(t) * \Delta t$ between time steps t and $t + \Delta t$. Technically, $\delta x(t)$ is the first term in the Taylor series expansion of the dynamic equation for the variable x

Fundamental descriptors

State variables

Events

Processing logic

Time-step logic

evaluated at t . In the case where the motion of a vehicle is being tracked, $\delta v(t)$ might be the vehicle's expected acceleration during the next time step following t and Δv would be the amount by which its speed would change in the interval Δt . Thus, at time $t + \Delta t$, its new speed would be $v(t) + \Delta v$.

Specification of these fundamental descriptors is complete when the system state at all points in time can be predicted from its state at any other point in time, and in particular if the state at $t + 1$ can be predicted from the state at t to within tolerable error limits. Any piece of information not needed to predict that future state is extraneous, and if that future state is ambiguous or uncertain, more information is needed.

It is important to know if some attribute of the model is stochastic instead of deterministic and if the time-step logic is event based or time based. These simulation model descriptors are described in detail for various simulation models. Also, Section IV of this chapter gives four numerical exercises that explain these simulation model descriptors using assumed traffic scenarios.

STOCHASTIC AND DETERMINISTIC MODELS

A deterministic model is not subject to randomness. Each application of the model will produce the same outcome. If these statements are not true and some attribute of the model is not known with certainty, the model is stochastic. Random variables will be used during an analysis using simulation models to determine either specific variables or the actions that should be taken. Descriptions of how these random numbers are selected to obtain sample values of the parameter of interest (i.e., from its cumulative distribution function) can be found in various texts (e.g., 53, 61, 71, 86). Different random number sequences will produce different model results; therefore, the outcome from a simulation model based on a stochastic model cannot be predicted with certainty before analysis begins.

EVENT-BASED AND TIME-BASED MODELS

A model is event based if time advances from one event to the next, skipping over intervening points in time. It is not that skipped points in time are unimportant but rather that no event occurs during the skipped time such that no change in outcome would occur even if the skipped time were considered explicitly. A model is time based if time progresses explicitly from one point in time to the next. In traffic models this is typically from 0.1 s to the next or 1.0 s to the next, depending on the level of detail at which events need to be modeled.

Time always advances in accordance with a time-step logic. In event-based simulation models, these steps vary in length and correspond to the intervals between events. In time-based simulation models, the time steps are usually all the same or they may vary in response to how active the system is, with smaller steps for more activity. The numerical exercises in Section IV illustrate the differences between event-based and time-based models.

MICRO-, MACRO-, AND MESOSCOPIC MODELS

Modelers often try to describe simulation models as being microscopic, mesoscopic, or macroscopic. The difference pertains mainly to the level at which the traffic flow phenomena are being represented.

Microscopic models capture the movement of every vehicle. Individual vehicles can be traced through the network, and their time-space trajectories can be plotted. The model contains processing logic that describes how the vehicles behave. This behavior includes acceleration, deceleration, lane changes, passing maneuvers, turning movement execution, and gap acceptance.

Macroscopic models are at the other end of the spectrum. They tend to employ flow rate variables and other general descriptors of how the traffic is moving. Simulation models based on the equations used to describe shock wave phenomena are typical of

There is a time-step logic in both types of models

these types of models. The flow rate within one segment of the freeway is related to upstream and downstream flow rates through conservation-of-flow equations and other equations that ensure that boundary conditions are met at the interface between system segments.

Mesosopic models fall between microscopic and macroscopic models. They typically model the movement of clusters or platoons of vehicles and incorporate equations that indicate how these clusters of vehicles interact. Simulation models of signalized networks are often designed this way, since the vehicles tend to move in platoons that interact with other platoons and exhibit predictable changes in character over time and distance, as with platoon dispersion.

STATIC FLOW AND TIME-VARYING FLOW MODELS

The terms static flow and time-varying flow relate to the temporal characteristics of the traffic flows in the simulation model. Basically, the terms differentiate between a model that uses constant traffic flow rates from one time period to another and a model that does not. This differentiation is not to be confused with whether the model can represent time-varying flows internally that occur because of simulated events [e.g., incidents, signal cycling, ramp metering, high-occupancy vehicle (HOV) lane closures]. The issue is only the type of input flows that can be specified.

In the static flow case, the traffic flows are provided just once, as a set of constants. The model may allow the headways to vary, but the overall flow rates are fixed. Put another way, the origin-destination (OD) matrix is fixed and does not change throughout the duration of the analysis.

In the time-varying case, the flow rates can change with time. More than one set of flow rates must be specified so that the OD matrix can vary over time. Most models allow the flows to change once an hour. Some allow changes every 15 min. A few make provision for changes every 5 min, but provision for changes on a minute-by-minute basis is rare. This flexibility of specifying more than one set of flow rates is particularly useful when major surges in traffic need to be examined, such as the ending of a sports event or concert or some other condition, including peak periods when a pronounced variation in traffic flows exists.

DESCRIPTIVE AND NORMATIVE MODELS

The terms descriptive and normative refer to the objective of performing the analysis using simulation models. If the objective of the model is to describe how traffic will behave in a given situation, the model is most likely to be descriptive. It will not try to identify a given set of parameters that provide the best system performance but rather will show how events will unfold given a logic that describes how the objects involved will behave. For example, a simulation model could predict how drivers will behave in response to traffic flow conditions. A model attempting to shape that behavior in some fashion is not a descriptive model (e.g., if the model tried to force the drivers to maintain specific headways).

Normative models try to identify a set of parameters that provide the best system performance. An external influence (most often referred to as an objective function) tries to get the system to behave in some optimal way. A good example is a model that tries to optimize signal timings. Another illustration is a freeway network model that has drivers alter their path choices to optimize some measure of system performance. In both cases, the behavior of the system is modified through an external influence, probably on an iterative basis, to create a sequence of realizations in which the objective function value is improved, as in minimizing total travel time or total system delay.

The distinction can be restated this way. If the model has an objective and it seeks to optimize that objective, it is a normative model. Conversely, if it does have an objective but does not seek to optimize that objective, it is a descriptive model.

This section refers to traffic inputs to the models

Descriptive models use inputs to provide resulting operational outputs

Normative models seek to optimize performance

The important point is that the analyst needs to know which type of model is being used and how that type influences the model's predictions. For example, assume that the analyst has created a model in which the signal timing is fixed and drivers can alter their path choices in response to those signal timings (in a way that replicates how they would actually behave). This is a descriptive model. Even though the analyst can change the signal timings and see how the drivers respond (and how the system performance changes), the model is still describing how the system would behave for a given set of conditions.

If the analyst alters the model so that it seeks a better set of signal timings, a normative model has been created. Further, if the analyst changes the rules by which drivers behave (without an empirical basis for such a change), as in altering the rules by which they select alternative paths, another step has been taken in the direction of making the model normative.

A descriptive model is implied if the analyst introduces a new demand-supply paradigm, like congestion pricing, based on a field study. A new demand-side routine could be developed to predict how drivers alter path choices in response to congestion prices and a supply-side routine that seeks to set those prices in some responsive and responsible way in an effort to produce a desirable flow pattern. Even though two competing optimization schemes are at work, each describes how a portion of the system is behaving in response to inputs received. There is no explicit intent to optimize the system performance in a specific manner.

OFF-LINE AND REAL-TIME MODELS

Most simulation models are intended to be run in an off-line mode. This is likely to be true of all models of interest to HCM users. One sets up the model, specifies the inputs, conducts an analysis, and reviews the results. Other than the fact that a shorter run time is almost always better, no concern exists as to how simulated time relates to real time. Simple off-line models can often simulate system behavior at rates faster than real time, although more complex ones may run at rates slower than real time.

Real-time models, on the other hand, keep pace with the rate at which time actually advances. A second of simulated time must be a second of real time. Thus, if conditions in the network are quiet, and the model could go much faster, it cannot. Conversely, if conditions are hectic and a large number of computations must be done to carry out the analysis, the model must be fast enough to keep up with the passage of real time. Real-time simulation models are used if the computer model is attached to a physical traffic control device. One application of the simulation model is to analyze vehicles for an actuated traffic signal controller. The controller believes that the vehicles are actual on-the-street vehicles.

Off-line models are most often used for investigating what-if scenarios or testing various options, especially if they run faster than real time. Real-time models are used for training exercises and other situations in which a representation of how the system will perform in real time is of great importance.

IV. ILLUSTRATIVE SIMULATION MODEL NUMERICAL EXERCISES

The numerical exercises in this section are presented to show how inputs are used and how outputs are generated with simulation models. The exercises represent four scenarios that can be assessed through use of simulation models based on the general concepts described previously.

The exercises do not imply that the Highway Capacity and Quality of Service (HCQS) Committee or TRB endorses any specific formulas, procedures, or simulation models. The examples are intended for illustrative purposes only.

GAP-ACCEPTANCE MODEL

A single-lane exit ramp terminates in a two-lane street at a stop sign as shown in Exhibit 31-5. The two integer variables that reflect the state of the system are the presence or absence of a vehicle at Point B (the vehicles going westbound are irrelevant) and the number of vehicles in queue at Point D on the northbound approach.

EXHIBIT 31-5. RAMP TERMINAL

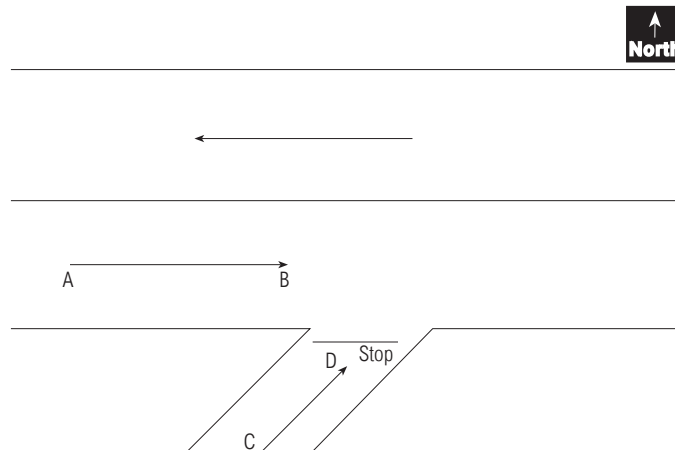

The three possible events are as follows: an eastbound vehicle arrives at B, a northbound vehicle arrives at D, and a northbound vehicle accepts or rejects a gap between vehicles arriving at B and executes (or does not execute) a right-turn maneuver. The time-step logic can be discrete steps of variable size with the simulation model stepping from one event to the next (event-based) since no modeling of the vehicle dynamics (i.e., vehicle accelerations and decelerations) is involved. Three elements of the processing logic are setting the gaps between arriving vehicles at B, setting similar gaps for arriving vehicles at D, and having the vehicles at D determine whether gaps between successive vehicles at B are large enough for them to execute their turning maneuver (i.e., if the gap is large enough, to turn, otherwise to wait).

To set the gaps between vehicle arrivals and the minimum gap that the vehicles at D will accept, three probability distributions are needed. Assume that the following probability distributions pertain (this means that the model is stochastic):

- Eastbound arrivals: 2 to 12 s apart, uniformly distributed;
- Northbound arrivals: 4 to 20 s apart, uniformly distributed; and
- Minimum acceptable gaps for the northbound vehicles: 3 to 5 s, uniformly distributed.

The first distribution implies that the gaps between vehicles moving eastbound are between 2 and 12 s long, with an equal likelihood that a particular gap will take on a given value between those two limits. Exhibit 31-6 shows this probability density function. For the northbound gaps and the minimum acceptable gaps, similar distributions pertain. The differences are in the lower and upper limits, (4, 20) and (3, 5), respectively, and in the height of the density functions, 0.0675 in the first case and 0.5 in the second, since the area within the distribution must be 1.0.

Stochastic event-based exercise

Gap is the spacing of a line perpendicular to the position of vehicle at D to the front bumper of vehicle at B

EXHIBIT 31-6. DISTRIBUTION OF EASTBOUND HEADWAYS

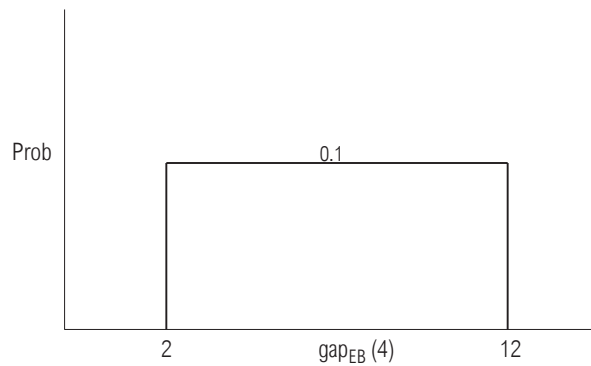

If this situation is simulated using the model, an identification will be made of one of the possible event sequences that can occur as depicted in Exhibit 31-7. The columns in Exhibit 31-7 are described as follows:

1. Random Variable 1&2 shows the random numbers drawn during the analysis to determine each headway between the eastbound and northbound vehicles.
2. Random Variable 3 lists the random numbers used to determine the minimum acceptable gaps for northbound vehicles.
3. Approach indicates the direction of arrival for each vehicle, either eastbound or northbound.
4. Arrive shows the vehicle arrival times in seconds.
5. Minimum Gap indicates the minimum gap that northbound vehicles will accept.
6. Time for Conflicting Time shows the earliest time at which a conflicting event can occur (i.e., the arrival of the next eastbound vehicle) for a gap of the duration in Column 5 to exist.
7. Go indicates whether a gap can be accepted.

The analyst can see how this works by tracing the sequence of events shown in Exhibit 31-7.

- The first row shows the arrival of the first eastbound vehicle. A random number (0.6844) yields a gap (from $t = 0$) of 8.8 s [$2 + 0.6844 * (12 - 2)$] based on the formula for the distribution: $\text{MinGap} + \text{RanNum} * (\text{MaxGap} - \text{MinGap})$. This formula produces an arrival time for this vehicle of 8.8 s.
- The second row shows the first northbound vehicle. As with the first eastbound vehicle, a random number (0.3238) yields a gap (from $t = 0$) of 9.2 s [$4 + 0.3238 * (20 - 4)$] and thus an arrival time of $t = 9.2$ s. Then a second random number (0.9253) produces an acceptable gap of 4.9 s.
- The minimum gap of 4.9 s implies that this vehicle needs a window extending until 14.1 s to make its right turn and enter the eastbound traffic stream.
- Since no eastbound vehicle arrives until $t = 20.6$ s (which is greater than 14.1 s), the northbound vehicle can execute its turning maneuver.
- The next vehicle to arrive is traveling northbound. Its headway from the previous northbound vehicle is $4 + 0.1400 * (20 - 4) = 6.2$ s, which means it arrives at $t = 15.4$ s.
- The minimum acceptable gap for this northbound vehicle is $3 + 0.5453 * (5 - 3) = 4.1$ s, which means that no conflicting event can occur until after $t = 19.5$ s if this vehicle is to make its right turn.
- Since the next eastbound vehicle does not arrive until 20.6 s, there is time for the right turn to take place.
- The gap between the second eastbound vehicle and the first is $2 + 0.9755 * (12 - 2) = 11.8$ s, implying that the second vehicle has an arrival time of $8.8 + 11.8 = 20.6$ s.

EXHIBIT 31-7. GAP-ACCEPTANCE MODEL NUMERICAL EXERCISE

Random Variable 1&2	Random Variable 3	Approach	Arrive	Minimum Gap	Time for Conflicting Time	Go
0.6844		East	8.8	-		
0.3238	0.9253	North	9.2	4.9	14.1	OK
0.1400	0.5453	North	15.4	4.1	19.5	OK
0.9755		East	20.6	-		
0.1028	0.6718	North	21.1	4.3	25.4	No
0.0773		East	23.4	-	27.7	OK
0.4027		East	29.4	-		
0.0110		East	31.5	-		
0.4813		East	38.3	-		
0.8687	0.5618	North	39.0	4.1	43.1	OK
0.3687	0.7407	North	48.9	4.5	53.3	No
0.9844		East	50.2	-	54.6	OK
0.8469		East	60.6	-		
0.9038	0.8543	North	67.3	4.7	72.0	No
0.6495		East	69.1	-	73.8	OK
0.5121		East	76.3	-		
0.1136		East	79.4	-		
0.1808		East	83.2	-		
0.9786	0.3722	North	87.0	3.7	90.7	No
0.3895		East	89.1	-	92.8	OK
0.3467		East	94.6	-		
0.4034	0.8461	North	97.4	4.7	102.1	No
0.5256		East	101.8	-	106.5	OK
0.1016	0.7629	North	103.1	4.5	107.8	OK
0.0507	0.8176	North	107.9	4.6	112.5	No
0.4375		East	108.2	-	112.8	OK
0.4505		East	114.7	-		
0.4501	0.0540	North	119.1	3.1	122.2	OK
0.6647		East	123.3	-		
0.1675		East	127.0	-		
0.6371	0.6753	North	133.3	4.4	137.7	No
0.6438		East	135.5	-	139.9	No
0.1032		East	138.5	-	142.9	OK
0.5542		East	146.0	-		

- The fifth row shows a third northbound vehicle, whose gap from the second is $4 + 0.1028 * (20 - 4) = 5.7$ s, resulting in an arrival at $15.4 + 5.7 = 21.1$ s.
- With a minimum acceptable gap of $3 + 0.6718 * (5 - 3) = 4.3$ s, this vehicle needs to see no conflict until at least $t = 25.4$ s to make its right turn.
- However, at 23.4 s the third eastbound vehicle arrives. Its gap from the second eastbound vehicle is only $2 + 0.0773 * (12 - 2) = 2.8$ s, which means an arrival time of $20.6 + 2.8 = 23.4$ s, so the northbound vehicle has to wait.
- The gap until the next eastbound vehicle is $2 + 0.4027 * (12 - 2) = 6.0$ s, so its arrival time is not until $23.4 + 6.0 = 29.4$ s.
- Therefore, the third northbound vehicle, which needs a gap until at least $23.4 + 4.3 = 27.7$ s, but sees a gap that lasts until 29.4 s, can make its right turn.

Exhibit 31-7 contains more event sequences that the reader can trace in a similar fashion. It is interesting to note that only three northbound vehicles can accept the first gap that appears: the vehicles that arrive at 39.0 s, 103.1 s, and 119.1 s. Moreover, the northbound vehicle that arrives at 133.3 s has to wait for a pair of eastbound vehicles to

pass before it can execute its turning maneuver. The others have to wait for a single vehicle to pass before a gap large enough to execute a right turn appears.

All discrete event simulation models function in a manner similar to that shown in the gap acceptance numerical exercise. They use random numbers (or some similar mechanism) to determine when events will occur or how long they will last. They use these values to play out the sequence of events, resolving conflicts as they arise and postponing events until the necessary logical conditions are met for the event to occur (it is possible that it may never occur).

This model is stochastic, meaning that randomness is involved in the events. Random numbers are used to determine when specific events will occur. The outcomes, like the delays that result, are sensitive to the random numbers chosen, which means that different analyses can produce different outcomes. In the case of the data presented in Exhibit 31-7, 12 northbound vehicles are involved, 7 of which experience delay. Exhibit 31-8 shows that these are the vehicles departing at $t = 23.4, 50.2, 69.1, 89.1, 101.8, 108.2,$ and 138.5 s. They accumulate a total of 17.4 s of delay, which, when averaged across the 12 northbound vehicles, implies a delay of 1.45 s per vehicle.

EXHIBIT 31-8. VEHICLES INCURRING DELAY

Depart Time (s)	Delay (s)	Calculation Basis
23.4	2.3	23.4–21.1
50.2	1.3	50.2–48.9
69.1	1.8	69.1–67.3
89.1	2.1	89.1–87.0
101.8	4.4	101.8–97.4
108.2	0.3	108.2–107.9
138.5	5.2	138.5–133.3

Other models are deterministic. In the current example, a deterministic model could be created if all of the gaps were assumed to be equal to the means of the distributions (7 s for the eastbound vehicles and 12 s for the northbound ones) and the minimum acceptable gaps were always equal to the mean (4 s). An example like this, based on pretimed traffic signal operation, is given next.

PRETIMED SIGNAL OPERATION

In deterministic models there is no randomness, and the outcome is the same (for identical input values) from one analysis run to the next. A simulation model based on a two-phase pretimed traffic signal illustrates how a deterministic simulation model operates.

The state variable in this model is the signal’s current interval. It can take on one of six values (1 = main-street green; 2 = main-street yellow; 3 = main-street all red; 4 = side-street green; 5 = side-street yellow; and 6 = side-street all red). Knowledge of this value completely defines the state of the system. Moreover, each possible advance from one state to the next is an event. The time-step logic involves steps of constant size from one second to the next, which means that the model is time based instead of event based. The processing logic specifies which state occurs next and how long each state lasts.

A graphical portrayal of this model is shown in Exhibit 31-9. A hexagon is used to represent the processing logic from main-street green to side-street green and return. The circle at the top of the hexagon represents main-street green (State 1). At the bottom is side-street green (State 4). Connecting them are state sequences (2, 3) and (5, 6). The boxes following each state show how long the state lasts (for State 1 it is 30 s, followed by 4, 2, 18, 4, and 2 s for States 2 through 6).

Deterministic time-based exercise

EXHIBIT 31-9. SIMPLE TWO-PHASE SIGNAL

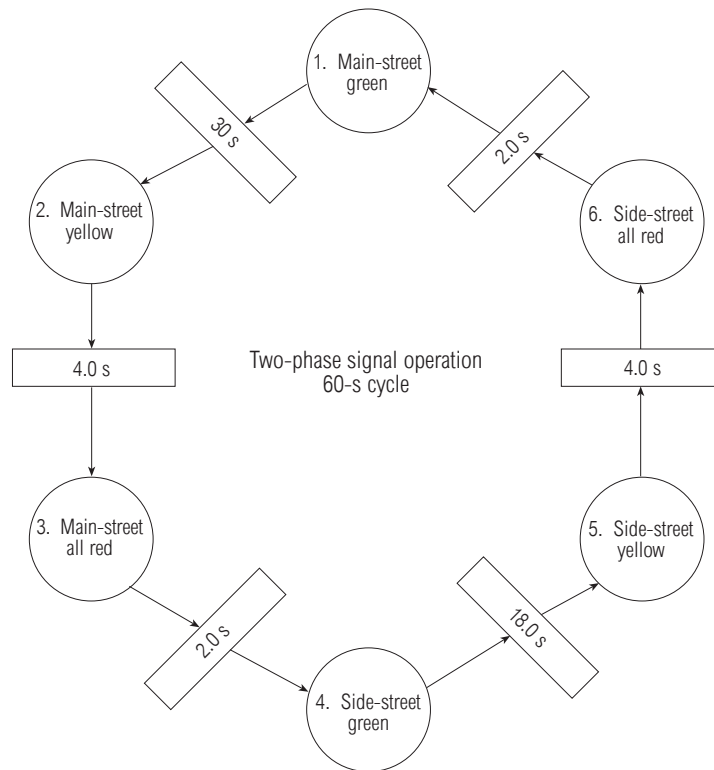

When time reaches the end of each transition, a change in system state occurs. The processing logic indicates that the system state will progress around the six-state ring indefinitely.

Exhibit 31-10 shows the resulting time trace of the system state during one cycle. Time is displayed along the horizontal axis, and the system state is displayed on the vertical axis. Since time advances from one second to the next, an event occurs each second, but some events involve maintaining the current system state whereas others involve changing that state. The system is in State 1 from $t = 0$ to $t = 30$. Then it is in State 2 for 4 s and State 3 for 2 s followed by State 4 for 18 s, State 5 for 4 s, and State 6 for 2 s. If the graph continued, the 60-s cycle would repeat.

Although there is not much more to say about this example as it stands, the model might easily become more complex. Note that a single state variable has been defined and it takes on discrete values, one for each condition of the traffic signal. But more complex representations of the system state could be created. For example, a vector of six 0-1 state variables, one state for each bulb showing the signal indication (i.e., green, yellow, and red for each direction), might be specified. This vector would then define the state of the system. An even more complex model could specify the value of the interval timer being used to control the length of these intervals. In this case, a continuous variable would be needed to reflect the current value of the interval timer.

As this discussion indicates, many different simulation models can be created for the same system. The analyst has to decide how the system should be represented or how the model should specify those states. The definitions used hinge on the purpose of the model and the level of detail desired. In modeling the dynamics of a queue, for instance, the length of queue can be the state variable. Then the system state changes when vehicles either join the queue or depart. On the other hand, if the analyst wants to account for the motion of the vehicles in the queue (i.e., acceleration, deceleration), continuous variables must be employed. One would be needed for the position and speed

of each vehicle. The numerical example on car following illustrates the use of continuous variables.

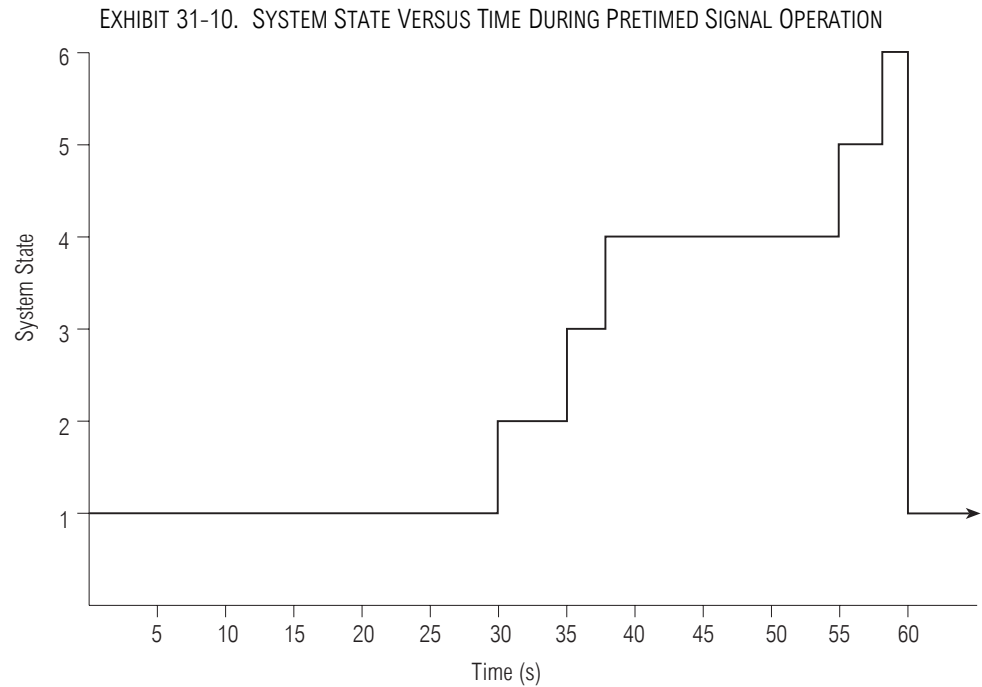

Stochastic and deterministic event-based exercise

SINGLE TOLL BOOTH

This exercise considers a toll booth operation. The state variable is the number of vehicles in the system (i.e., at the toll booth or waiting in line). The events include vehicle arrivals, entry of a vehicle into the toll booth, and departure of a vehicle from the toll booth. The time-step logic is event based, involving discrete steps of variable length. The three processing logics are joining the back of queue, waiting for the toll booth to be empty before moving forward, and paying a toll before departing.

First, assume that a vehicle arrives every 10 s and the service time at the toll booth is 5 s. Exhibit 31-11 shows the changes in system state that occur. This is a deterministic model; no randomness is allowed. Either a vehicle is present (1) or it is not present (0). At $t = 0$ the first vehicle arrives. It requires 5 s to be processed and then leaves. At $t = 10$ s, the next vehicle arrives, and the process repeats. Note that the delay for each of the nine vehicles is zero, and the state of the system is always either 1 or 0 depending on whether a vehicle is being served at the toll booth or not.

The exercise could be altered slightly by introducing a stochastic element. Assume that the average interval between arrivals is 10 s but the interarrival times can range from 4 to 16 s (Exhibit 31-6 shows how this looks). Further, assume that the average service time is 5 s but the actual service times can range from 3 to 7 s. Then for the same nine vehicles, a realization of how the events might unfold is shown in Exhibit 31-12.

The information in the columns of Exhibit 31-12 is as follows:

- Vehicle Number shows a numerical index for the vehicles (i.e., 1 to 9),
- Random Variable Headway lists the random number that determines the interarrival time (headway),
- Headway gives the headway from the previous vehicle [$4 + \text{Random Variable Headway} * (16 - 4)$],
- Arrive gives arrival time based on the headway,

EXHIBIT 31-11. SYSTEM STATE VERSUS TIME DURING TOLL BOOTH OPERATIONS

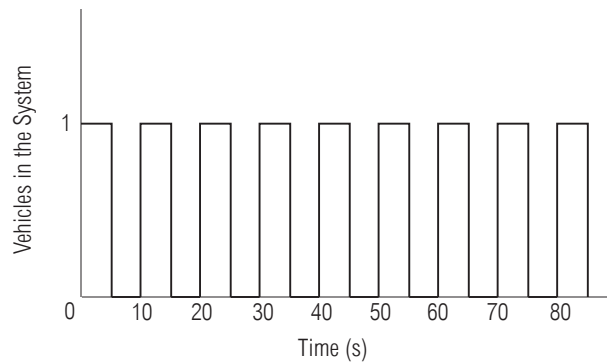

EXHIBIT 31-12. STOCHASTIC TOLL BOOTH MODEL

Vehicle Number	Random Variable Headway	Headway	Arrive	Random Variable Service Time	Service Time	Start of Service	End of Service	Delay (s)
1	0.8672	14.4	14.4	0.8871	6.5	14.4	20.9	0.0
2	0.8598	14.3	28.7	0.9447	6.8	28.7	35.5	0.0
3	0.0204	4.2	33.0	0.7159	5.9	35.5	41.4	2.5
4	0.0642	4.8	37.7	0.1672	3.7	41.4	45.1	3.7
5	0.0012	4.0	41.8	0.8501	6.4	45.1	51.5	3.3
6	0.4421	9.3	51.1	0.6317	5.5	51.5	57.0	0.4
7	0.0469	4.6	55.6	0.5022	5.0	57.0	62.0	1.4
8	0.4436	9.3	64.9	0.6696	5.7	64.9	70.6	0.0
9	0.8326	14.0	78.9	0.3274	4.3	78.9	83.2	0.0

- Random Variable Service Time shows the random number for determining the service time,
- Service Time is $3 + \text{Random Variable Service Time} * (7 - 3)$,
- Start of Service is the time when service starts (vehicle enters toll booth),
- End of Service is time when service ends (vehicle leaves toll booth), and
- Delay gives delay in seconds.

The entries in Exhibit 31-12 depict the following system realization. The first vehicle enters the system at $t = 14.4$ s based on a headway of $4 + 0.8672 * (16 - 4) = 14.4$ s, which is based on the random number (0.8672). It also has a service time of $3 + 0.8871 * (7 - 3) = 6.5$ s based on a second random number (0.8871). The same logic pertains to Vehicles 2 through 4.

For Vehicle 5, the headway is $4 + 0.0012 * (16 - 4) = 4.0$ s, so its arrival time is 41.8 s. But at $t = 41.8$ s, the toll booth is already occupied. Thus, Vehicle 5 must wait until the toll booth is free at $t = 45.0$ s before it can begin its service time. This wait produces a delay of 3.3 s. Then at $t = 45.1$ s, Vehicle 5 begins service and emerges $3 + 0.8501 * (7 - 3) = 6.4$ s later when its service is complete. Vehicle 5 leaves the toll booth at $t = 51.5$ s, which allows Vehicle 6 to enter. Vehicle 6 has, in turn, been waiting, having arrived at $t = 51.1$ s.

The resulting trend in system state is shown in Exhibit 31-13. Note that the number of vehicles in the system now reaches two, not just one, and that the length of time when vehicles are present varies, illustrating the effect of adding randomness (i.e., stochasticity). In fact, because of the randomness, the third, fourth, fifth, sixth, and seventh vehicles experience delays of 2.5, 3.7, 3.3, 0.4, and 1.4 s, respectively. These are not large values, but they are nonzero values, in contrast to those in the deterministic solution considered earlier. The total delay is 11.3 s, or an average delay of 1.25 s per vehicle. Hence a situation in which there is delay exists in the stochastic case, although

there was none in the deterministic case, even though the same average values were used for both.

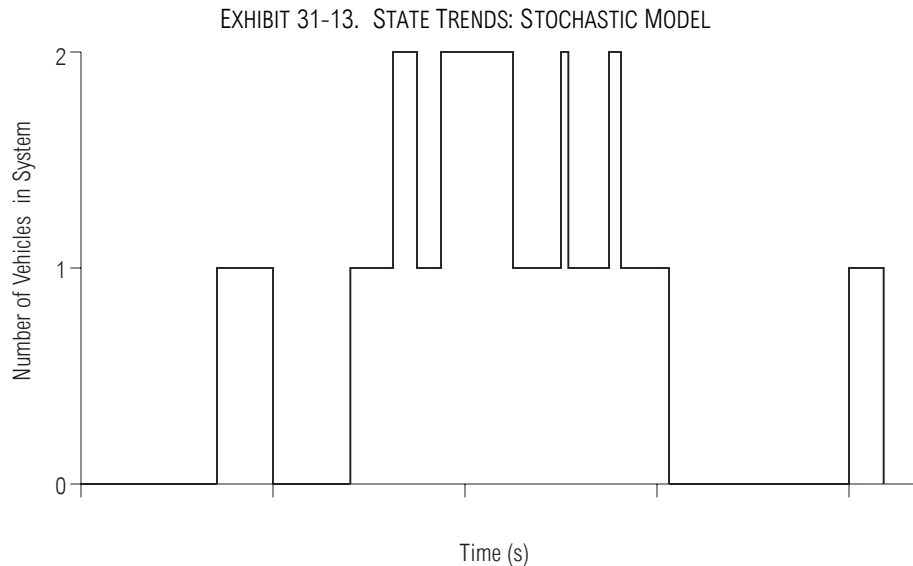

As discussed earlier in the pretimed signal exercise, a more complicated simulation model could be developed in which the model accounts for the acceleration and deceleration behavior of each vehicle. Also, the vehicle acceleration and deceleration trajectories could be treated as being stochastic instead of deterministic. Note that as the model becomes more stochastic, the randomness will increase and, all else being equal, the delays will increase, as found in this exercise. In such a model, the state variables would become the location and speed of each vehicle, and these variables would be continuous rather than discrete.

Many of today's traffic simulation models include subroutines that are intended to account for these aspects of system behavior, and continuous variables must be used to represent the state of the system.

CAR FOLLOWING

This car-following exercise uses a model that is both stochastic and time based. The model is stochastic in that the behavior of the vehicles is subject to randomness and time based in that the time-step logic involves advancing from one 0.1-s interval to the next, at each point checking to see if the system state needs to be updated in response to unfolding events.

Assume that a line of cars is moving single file in a single lane. Each vehicle has its own randomly determined entry time, initial speed (also the target speed), initial acceleration, maximum acceleration rate, and maximum deceleration rate. The initial acceleration is zero. Driver type is also random, determined by the initial speed (faster implies more aggressive). An influence zone determines the range over which cars are sensitive to the presence of cars ahead of them. Following cars slow down if they get too close to the car ahead, and they accelerate if the car spacing allows them to do so.

At every time step, the model reevaluates the state of each vehicle, determines if it should be accelerating or decelerating, and updates its speed and location accordingly. Therefore there are $2 * n$ state variables, where n is the number of vehicles in the system. The state variables are the speeds and positions of all vehicles. The events include all updates to vehicle position and speed, which occur every time step. The processing logic indicates how the car is to respond to the situations it encounters.

Continuous and stochastic time-based exercise

Some parts of the processing logic are simple. Equations 31-1 and 31-2 are used to update the n th vehicle's position and time from time step t to time step $t + \Delta t$:

$$x_n(t + \Delta t) = x_n(t) + v_n(t) * \Delta t \quad (31-1)$$

$$v_n(t + \Delta t) = v_n(t) + a_n(t) * \Delta t \quad (31-2)$$

where

- $x_n(t)$ = position of n th vehicle at time t ,
- $v_n(t)$ = speed of n th vehicle at time t ,
- $a_n(t)$ = acceleration of n th vehicle at time t , and
- Δt = duration of one time step (0.1 s in this example).

The complex part of the processing logic relates to determining appropriate values for $a_n(t)$. For this example, it is assumed that the lead vehicle is behaving erratically and is following a sinusoidal acceleration pattern. Equation 31-3 is used for the calculation.

$$a_1(t) = -\sin(2\pi t / 50) \quad (31-3)$$

For subsequent vehicles, the acceleration rules are as follows. These rules should not be construed as ideal, correct, or comprehensive but rather are used here for illustration.

If the vehicle ahead (i.e., vehicle $n - 1$) is beyond the influence zone, Equation 31-4 is used:

$$a_n(t + \Delta t) = \begin{cases} \max[0, a_n(t) + 0.1 * \text{RanVar}] & \text{if } v_n(t) \leq V_n \\ \min[0, a_n(t) - 0.1 * \text{RanVar}] & \text{if } v_n(t) > V_n \end{cases} \quad (31-4)$$

where RanVar is a random variable uniformly distributed between 0 and 1 and V_n is the desired speed for Vehicle n . Effectively, if the car needs to accelerate toward its desired speed, it does.

If the vehicle ahead is within the influence zone, the following vehicle takes action to avoid a collision. The calculation begins by computing the relative speed and distance from the subject vehicle (n) to the vehicle ahead ($n - 1$) using Equations 31-5 and 31-6.

$$\Delta v_n(t) = v_{n-1}(t) - v_n(t) \quad (31-5)$$

$$\Delta d_n(t) = d_{n-1}(t) - d_n(t) \quad (31-6)$$

If $\Delta v_n(t)$ is negative (Vehicle n is closing on Vehicle $n - 1$), Equation 31-7 is used:

$$a_n(t + \Delta t) = \min\left\{0, a_n(t) + k \left[\frac{\Delta v_n(t)}{\Delta d_n(t)} \right] \right\} \quad (31-7)$$

Note that the term inside the square brackets is negative, so $a_n(t + \Delta t)$ is zero or negative, and k is a constant.

If $\Delta v_n(t)$ is positive (the subject vehicle has slowed down too much), Equations 31-8 and 31-9 are used:

$$a_n(t + \Delta t) = \begin{cases} \max[0, a_n(t) + \Theta * \Delta v_n(t) * \Delta d_n(t)] & \text{if } v_n(t) \leq V_n \\ \min[0, a_n(t) - 0.1 * \text{RanVar}] & \text{if } v_n(t) > V_n \end{cases} \quad (31-8)$$

always subject to the requirement that

$$a_n^{\min} \leq a_n(t) \leq a_n^{\max} \quad (31-9)$$

a_n^{\min} and a_n^{\max} are the maximum deceleration and acceleration rates possible, and Θ is a constant.

Physically, this means that if the vehicle ahead is further away than the influence zone, the subject vehicle simply hovers about its target speed. However, if the subject vehicle encounters the vehicle ahead, it then decelerates to avoid overtaking that vehicle, and does so more quickly the greater the relative speed between the two vehicles and the

smaller the relative spacing. If the vehicle ahead is moving faster because the subject vehicle has slowed down too much, the subject vehicle tries to reaccelerate toward its desired speed and will accelerate most quickly if it finds a large relative speed and a large relative spacing.

Time-space trajectories of vehicles can be traced as their paths are produced by a car-following simulation model. The slopes of the lines are the speeds of vehicles. Examples of such time-space trajectories are shown in Exhibits 10-1 and 10-8.

V. TYPICAL APPLICATIONS OF MODELS

Simulation models should be considered when the desired study of performance in a traffic situation is not explicitly covered by HCM methodologies presented in Part III of this manual or when the traffic situation is very difficult to analyze using empirical and analytical models. Exhibit 31-14 summarizes situations that might be addressed more effectively by simulation models.

EXHIBIT 31-14. SUMMARY OF TYPICAL MODEL APPLICATIONS

HCM Chapter	Traffic Situation
Interrupted-Flow Conditions	
Applicable to all interrupted-flow methodologies	Oversaturated flow analysis (except for signalized intersections) Bus activity On-street parking Special lane use Queue spillback Pedestrian/bicycle interactions
15. Urban Streets	Effects of signal coordination Mix of signals and no signals (stop and yield) Effects of driveways Effects of midblock bottlenecks
16. Signalized Intersections	Signal timing plan development Geometrically offset intersections Alternative arrival characteristics Phase skips Pedestrian actuation Timing plan development
17. Unsignalized Intersections	Two-way left turns Yield-controlled intersection delay
18. Pedestrians	Effects of pedestrian actuation
19. Bicycles	See interrupted-flow situations
26. Interchange Ramp Terminals	See interrupted-flow situations
27. Transit	See interrupted-flow situations
Uninterrupted-Flow Conditions	
Applicable to all uninterrupted-flow methodologies	Bottlenecks Oversaturated flow analysis Time-varying demands Unbalanced lane use Special lane restrictions Surveillance, work zones
20. Two-Lane Highways	Combination of terrain and traffic characteristics such as power-weight ratios or coefficient of variation of desired speeds
21. Multilane Highways	See uninterrupted-flow situations
22. Freeway Facilities	HOV lanes
23. Basic Freeway Segments	See uninterrupted-flow situations
24. Freeway Weaving	Complex weaving areas
25. Ramps and Ramp Junctions	Ramp metering

How a simulation model represents the traffic situation under evaluation is an important factor in selection of an appropriate model. For example, when queuing is evaluated from a design perspective, the analyst is concerned with the 85th-percentile or 95th-percentile back-of-queue situation rather than the average or 50th-percentile queue. In this case, a stochastic, microscopic model would better support the analysis compared with deterministic, macroscopic models, where the average queue would be appropriate.

PERFORMANCE MEASURES

Before the analyst can select the appropriate model, the performance measures that realistically reflect attributes of the problem under study must be identified. For example, when studying oversaturated conditions, the analyst must use a model that quantifies the effects of queuing as well as stops and delay. If the methodologies in this manual do not provide a particular performance measure of interest to the analyst (e.g., fuel consumption and emissions), a simulation model might be required. Exhibit 31-15 summarizes important performance measures discussed in HCM chapters on interrupted flow methodologies. Exhibit 31-16 summarizes important performance measures for uninterrupted-flow methodologies.

Certain performance measures may be desired that the HCM cannot deliver

EXHIBIT 31-15. PERFORMANCE MEASURES FOR INTERRUPTED-FLOW HCM METHODOLOGIES

HCM Chapter	Delay	Stops	Throughput	Queue Length	Cycle Failure	Fuel Consumption & Emissions	Speed	Demand/ Capacity
15. Urban Streets	√	mdnc	√	mdnc	mdnc	mdnc	√	√
16. Signalized Intersections	√	mdnc	√	√	mdnc	mdnc	dna	√
17. Unsignalized Intersections	√	mdnc	√	√	dna	mdnc	dna	√
18. Pedestrians	√	dna	√	√	dna	dna	dna	√
19. Bicycles	√	mdnc	√	dna	dna	dna	dna	√
26. Interchange Ramp Terminals	√	mdnc	√	√	mdnc	mdnc	dna	√
27. Transit	dna	dna	√	dna	dna	dna	√	dna

Notes:
dna = does not apply; mdnc = methodology does not compute

EXHIBIT 31-16. PERFORMANCE MEASURES FOR UNINTERRUPTED-FLOW HCM METHODOLOGIES

HCM Chapter	Speed	Delay	Throughput	Density	% Time Spent Following	Passing/Overtaking	Fuel Consumption & Emissions	Demand/ Capacity
20. Two-Lane Highways	√	√	√	mdnc	√	√	mdnc	√
21. Multilane Highways	√	mdnc	√	√	dna	dna	mdnc	√
22. Freeway Facilities	√	√	√	√	dna	dna	mdnc	dna
23. Basic Freeway Segments	√	mdnc	√	√	dna	dna	mdnc	√
24. Freeway Weaving	√	mdnc	√	√	dna	dna	mdnc	√
25. Ramps & Junctions	√	mdnc	√	√	dna	dna	mdnc	√

Notes:
dna = does not apply; mdnc = methodology does not compute

The same terms sometimes have different definitions between alternative models

It is important to understand underlying assumptions used in simulation models to make proper application of them

An important issue when a simulation model is selected is the exact definitions of the performance measures provided, particularly when a comparison of performance measures produced by different simulation models is to be made. Often, a performance measure is given the same name in various programs, but its definition and interpretation differ. For example, a model may define stop delay as the time during which a vehicle has a speed lower than 8 km/h, whereas another model may define stop delay as the time during which a vehicle has a speed of 0 km/h.

APPLYING A MODEL

Many assumptions are made to represent the simulated network. A lack of understanding or improper use of simulation models may result in unrealistic outcomes and provide incorrect information for decision making. Thus, considerable skill and attention to detail must be exercised in order to derive reliable results from the simulation model.

Exhibit 31-17 presents an eight-step procedure for determining which model or models to use when the HCM methodologies do not provide the information needed. Each step in this procedure is described in the following subsections.

EXHIBIT 31-17. MODEL SELECTION AND APPLICATION

Steps	Description
1 Project scoping	Determine objectives, results needed
2 HCM methodology assessment	Check HCM capabilities
3 Model selection	Select a suitable model given needs
4 Data assembly	Gather input data for model
5 Data input	Prepare input data sets for model
6 Calibration and validation	Ensure credibility of model outputs
7 Output analysis	Interpret output results
8 Alternatives analysis	Conduct analysis

Determining Project Scope

The first step is to identify the problem and to define the purpose of the study. A properly defined problem and project scope will lead to a correct selection of models or procedures for the project. Answers to the following questions will assist in scoping the project:

1. Does the network being studied include urban streets, freeways, or rural highways or any combination of them?
2. What are the size and topology (isolated junctions, linear arterial, grid) of the network?
3. What type of vehicles (cars, carpools, buses, trucks) should be considered?
4. What traffic control methods (regulatory signs, pretimed signals, actuated signals, real-time traffic adaptive signals, and ramp metering signals) should be considered?
5. Should oversaturated traffic conditions be considered?
6. What is the duration of the analysis period?
7. Do the geometric conditions of the roadway facility change during the analysis period?
8. Does the traffic demand fluctuate significantly during the analysis period?
9. Does the traffic control change during the analysis period?
10. What model output and level of detail are anticipated from the model?
11. What information is available for model input, model calibration, and validation?
12. Is there more than one method to be considered for the analysis?

Assessing HCM Methodologies

The purpose of the next step is to assess the capability of the existing HCM methodologies and to determine if these methodologies can be applied to the issues that are raised in the first step. In addressing these issues, two major questions should be answered: What are the limitations of the HCM methodologies? Can these limitations be overcome? Limitations of the existing HCM methodologies are identified in Part III of this manual. If it is determined that a traffic simulation model is needed or advisable, the analyst continues to the next step.

Selecting a Model

Each simulation model, depending on the application, has its own strengths and weaknesses. It is important to relate relevant model features to needs of an analysis and determine which model satisfies these needs to the greatest extent. The following criteria are considered in selecting a model: model capabilities, data availability, ease of use, required resources, model applications and past performance, and validation and calibration.

Each of the criteria is explained in detail in the next subsections. Above all, the analyst must review the user's guide of the selected model to get a more detailed description of its characteristics.

Model Capabilities

Review of model capabilities is probably the most important aspect of selecting a simulation model. Simulation model results may be of no value if the model is not capable of addressing the issues raised in Step 1 and providing satisfactory results. Some key features can be used to evaluate a model's capabilities, such as size of network, network representation, traffic representation, traffic composition, traffic operations, traffic control, and model output.

- **Size of Network:** Most models have size limitations regarding the network to be analyzed. The key network parameters limited by the model include number of nodes, number of links, number of lanes per link, and number of sign- or signal-controlled intersections.
- **Network Representation:** Network representation refers to the model's capability in representing the network geometries for urban streets, freeways, or rural highways or any combination of them, ranging from single intersections to grid networks. For urban streets, major geometric elements include lane channelization at intersections, turning pockets, and bus bays and stops. For freeways, major geometric elements are acceleration lanes, deceleration lanes, auxiliary lanes, on-ramps, off-ramps, lane additions, lane drops, horizontal curvature, and grade. Elements for rural highways include grade, curvature, passing and no-passing zones, and sight distance for overtaking and passing.
- **Traffic Representation:** In the representation of how traffic flows in the model, the terms microscopic, mesoscopic, and macroscopic are commonly used, based on the level of aggregation. Because of their microscopic and stochastic nature, microscopic models have the ability to simulate sophisticated vehicle movements, allowing analysts to perform complex traffic analyses such as those for weaving areas. In contrast, mesoscopic and macroscopic models are generally not appropriate for evaluating complex traffic conditions since they use aggregate measures of flows or densities to measure vehicle movements.
- **Traffic Composition:** Traffic composition represents the mix of cars, buses, trucks, and carpools in the network and is used to incorporate the differences in performance characteristics among types of vehicles.
- **Traffic Operations:** The model should be capable of modeling real-world traffic operations such as complex merging, diverging, and weaving maneuvers at interchanges,

HOV lanes, bus transit operations, lane channelization at intersections, lane restrictions, lane blockages, and parking activities.

- **Traffic Control:** For street intersections, control methods include yield signs, two-way stop signs, all-way stop signs, pretimed signals, actuated signals, and real-time traffic adaptive control signals. Those commonly used for freeway on-ramps are clock time (or pretimed) control, demand and capacity control, occupancy control, speed control, HOV priority at ramps, integrated (areawide) ramp control, ramp metering optimization, and dynamic real-time ramp metering control with flow prediction capabilities. Signal coordination between traffic signals or between on-ramp signals and traffic signals on adjacent streets may also need to be considered.

- **Model Output:** There are two types of model output, graphics files and static measures of effectiveness (MOEs). Graphics files provide graphics output, including animation, so that users can visually examine the simulation model results. Static MOEs provide output for numerical analysis.

Data Availability

The next criterion identifies data requirements and potential data sources so that the disparity between data needs and data availability can be identified. In general, microscopic models require more intensive and detailed data than do mesoscopic and macroscopic models. Three different types of data are required to make the application of the traffic simulation model successful: data for model input, data for model calibration, and data for model validation.

- **Data for Model Input:** The basic data items required to describe the network and the traffic conditions to be studied can be categorized into four major groups.

1. **Transportation Network Data:** Most models use the link-node concept to represent the network, in which a link represents a roadway segment and a node is an intersection or change in roadway geometry. The link data include link length, number of lanes per link, lane additions, lane drops, turning pockets, lane channelization at intersections, grade, and horizontal curvature. The node data include node coordinates and types of control.

2. **Traffic Control Data:** Detailed control data should be provided for all control points, such as street intersections or freeway on- and off-ramps. Sign controls include yield signs, two-way stop signs, and all-way stop signs. Signal controls include pretimed signals, actuated signals, or real-time traffic adaptive signals. Ramp metering control methods include clock time (pretimed) control, demand and capacity control, occupancy control, and dynamic real-time ramp control with demand prediction capability. Timing data are required for all signal controls. Detector data such as type and location of the detector are required for actuated and traffic-adaptive signals.

3. **Traffic Operations Data:** To model the real-world traffic environment, most simulation models take link-specific operations data as input, such as roadway capacity, lane use, lane restriction, desired free-flow speed, HOV lanes, parking activities, lane blockages, and bus transit operations.

4. **Traffic Demand Data:** Different models may require traffic demand data in different formats. The most commonly used demand data are traffic demand at the network boundary or within the network, traffic turning percentages at intersections or freeway junctions, O-D trip tables, path-based trips between origins and destinations, and traffic composition.

- **Data for Model Calibration:** Calibration is the process of quantifying model parameters using real-world data so that the model can realistically represent the traffic environment being analyzed. Vehicle characteristics and driver characteristics are the key parameters, which may be site specific and require calibration. These data take the form of scalar elements and statistical distributions that are referenced by the model. In general, simulation models are developed and calibrated on the basis of limited site-specific data available to the model developers. These parameters may not be

transferable and therefore may not accurately represent the local situation. In that case, the analyst has to examine the model results with caution and identify the default parameters that must be overridden to better reflect local conditions. Most simulation models allow the analyst to override the default driver behavior data and vehicle data to better match local conditions, thereby allowing for model calibration.

1. **Driver Behavior Data:** Driver behavior is not homogeneous, and thus different drivers may behave differently given the same traffic conditions. Most of the microscopic models represent stochastic or random driver behavior (from passive to aggressive drivers) by taking statistical distributions of behavior-related parameters such as desired free-flow speed, queue discharge headway, acceptable gaps for lane changing and car following, and driver response to advance information and warning signs.

2. **Vehicle Data:** Vehicle data represent characteristics and performance of the types of vehicles in the network. Different vehicle types (e.g., cars, buses, single-unit trucks, semitrailers) have different characteristics as well as different performance attributes. They vary in terms of vehicle length, maximum acceleration, maximum deceleration, emissions rate, and fuel consumption rate. All of the models provide default vehicle characteristics and performance data. These data need to be overridden only when the local vehicle data are known to be different from the default data provided by the model.

- **Data for Model Validation:** Validation is the process of comparing model results with corresponding data observed in the field and ensuring that such results realistically represent the real-world system. Only measurable data collected in the field can be used to validate model results. Validation can be performed at the component system level as well as for the model as a whole, depending on the purposes of the application. The most commonly used data for validation are queue length, travel time, delay, speed, density, and throughput. Individual vehicle trajectories are often used to validate the model at the microscopic level.

- **Data Sources:** Data collection is a costly undertaking. Analysts should explore all possibilities to leverage previous efforts in data collection. The analyst should identify which data are currently available and which data are missing and therefore need to be collected in the field. Most of the static network, traffic, and control data can be collected from local agencies. These include design drawings for geometries, signal timing plans, actuated controller settings, traffic volume and patterns, traffic composition, and transit schedules.

Ease of Use

Assumptions and complex theories are used in the simulation model to represent the real-world dynamic traffic environment. Therefore, useful tools like input-output graphical display and debugging tools that are easily understandable are important criteria in the selection of a model. Although ease of use is important in a simulation model, the fact that a particular model is easy to use does not necessarily imply that it is the correct model of choice. The following five criteria can be considered when ease of use of a simulation model is assessed:

- Preprocessor: input data handling (user-friendly preprocessor);
- Postprocessor: output file generation for subsequent analysis;
- Graphics displays: graphic output capabilities, both animated and static;
- On-line help: quality of on-line help support; and
- Calibration and validation: ability to provide guidelines and data sets for calibration and validation.

Required Resources

The following issues regarding resources should be addressed in the selection of a model:

- **Costs to run the model:** These costs include data collection and input preparation, hardware and software acquisition, and model use and maintenance.

- Staff expertise: Intelligent use of the model is key to success. The analyst should understand the theory behind the model to eliminate improper use and avoid unnecessary questions or problems during the course of the project.
- Technical support: Quality and timely support are of importance in the acquisition of a model.

Model Applications and Past Performance

Credibility and user acceptance of a model are built on the model's past applications and experiences. No models are error free when first released and require continuous maintenance as well as periodic enhancements.

Validation and Calibration

It is important to assess how extensively a given model has been validated. In many, but not all, cases, simulation models are validated as part of the formulation and development process. Certainly those that have been validated are nominally better to use than those that have not been validated. Generally, models that have been in use for some time are likely to have been assessed and validated by various researchers or those who are using them in practice. It is useful to look for evidence of this validation in professional journals and periodicals, which are valuable sources during model selection.

Some simulation models also allow the user to set critical parameters to values more valid for local conditions. This procedure calibrates the model so it provides better results than would be possible if default values were used. In certain situations, where default values do not really apply, this can be an important model feature. The analyst should determine what model parameters can be adjusted in this manner.

Assembling Data

Data assembly involves collecting the data required (but are not already available) for the selected model. Data collection is a costly undertaking. Analysts should capitalize on previous modeling efforts and identify data availability from local agencies. Once existing data are assembled, users should develop a comprehensive plan for collecting those that are missing. In some cases, a pilot data collection effort may be needed to ensure that the developed data collection plan is workable before a full-scale effort is conducted.

Inputting Data

When all required data are in hand, the next step is to create the input files in a format required by the selected model. The following are the most commonly used methods for creating input files:

- Importing from a traffic database: Many analysts have large amounts of data in a variety of formats for the general purpose of traffic analysis. Such databases can be used to create input files.
- Converting from the existing data of other models: Many traffic models use the same or similar data for modeling purposes so that these data may be shared. Some traffic simulation models are accompanied by utility programs that allow the user to convert data into input files required by other models.
- Entering the data from scratch: Many traffic models have their own specific input data preprocessors, most of which take advantage of the state of the art in software, which aids the analyst with input data edit checking. These advanced features of the input data preprocessor eliminate cumbersome coding efforts. In addition, some input preprocessors include on-line help features.

Calibrating and Validating Models

Model calibration and validation refers to the process by which the analyst confirms that the model does in fact provide a reasonable approximation of reality. The user

Data requirements of a model are an important financial consideration

Calibration can also be performed on HCM models

should run the model with the data set describing the existing network and traffic scenarios (i.e., the baseline case) and then compare the simulation model results with the observed data collected in the field. The primary objective of this activity is to adjust the parameters in the model so that simulation model results correspond to real-world situations. Adjustment of these parameters is called calibration. If the model is not properly calibrated or validated on the basis of limited site-specific data, the analyst should use it with great caution. Validation occurs when the output of the model is statistically compared with the baseline case observed in the field. Typical baseline case parameters are speed, delay, and queue length. Although traffic simulation models generally provide default values that represent average conditions for these calibration data elements, it is the responsibility of the analyst to quantify these data to the extent practicable through field observation rather than to accept these default values.

With respect to microscopic models, all of the driver behavior-related and vehicle performance-related parameters are likely to be site specific and may require calibration. These parameters include distribution of desired free-flow speed by driver type; headway distributions for lane changing, car following, and queue discharge at intersections; and drivers' responses to signs, signals, and geometric changes. In macroscopic and mesoscopic models, only a few link-specific parameters can be calibrated, such as capacity, desired free-flow speed, and speed-flow-density relationships.

Several critical issues must be addressed when an initial simulation model run is conducted for the baseline case. First, the model should be able to properly represent the initial state of the traffic environment before any statistics can be collected for analysis. Second, the time should be long enough to cover the entire analysis period. Third, if the model can handle time-varying input, the analyst should specify the dynamic input conditions that describe the traffic environment to the extent possible. For example, if 1 h of traffic is to be simulated, the analyst should always specify the variation in demand volumes over that hour at an appropriate level of detail rather than specifying average, constant values of volume.

Finally, the analyst should know how to interpret the simulation model results, draw any inferences from them, and determine whether they constitute a reasonable and valid representation of the traffic environment. Given the complex processes taking place in the real-world traffic environment, the user must be alert to the possibilities that the model's features may be deficient in adequately representing some important process; the specified input data, calibration, or both are inaccurate or inadequate; the results provided are of insufficient detail to meet the project objectives; the statistical analysis of the results is flawed (as discussed in the following section); or the model has bugs or some of its algorithms are incorrect, therefore necessitating revision. If animation displays are provided by the model, this option should always be exercised to identify any anomalies.

If the simulation model results do not reasonably match the observed data collected in the field, the user should identify the cause-and-effect relationships between the observed and simulated data and the calibration parameters and perform calibration and validation of the model. Information on calibration and validation of models may be found in the references to this chapter (2, 3, 22, 32, 38, 39, 49, 51, 63, 64).

Analyzing Output

Proper output analysis is one of the most important aspects of any study using a simulation model. A variety of techniques are used, particularly for stochastic models, to arrive at inferences that are supportable by the output.

Once the model is calibrated and validated, the user can conduct a statistical analysis of the simulation model results for the baseline case with calibrated parameters. If the selected simulation model is stochastic in nature, simulation model results produced by a single run of the model represent only point estimates in the sample population. Typical goals of data analysis using output from stochastic model experiments are to present point

estimates of the performance measures and to form confidence intervals around these estimates. Point estimates and confidence intervals for the performance measures can be obtained either from one run or from a set of replications of the system, using independent random number streams. The analyst should refer to previous studies for details on the design and analysis of stochastic simulation models (2-4,14,22,26,27,31,40,51,57,58,68,73,92,97,103,106).

Analyzing Alternatives

When satisfactory simulation model results are obtained from the baseline case, the user can prepare data sets for alternative cases by varying geometry, controls, and traffic demand. If the model is calibrated and validated on the basis of the observed data, values of these calibrated parameters should also be used in the alternatives analysis, assuming that driver behavior and vehicle characteristics in the baseline case are the same as those in the alternative cases.

Traffic simulation models produce a variety of performance measures for alternatives analysis. As discussed in Step 1 (see Exhibit 31-17), the user should identify what model performance measures and level of detail are anticipated. These performance measures, such as travel time, delay, speed, and throughput, should be quantifiable for alternatives analysis. Some models provide utility programs or postprocessors, allowing users to easily perform the analysis. If animation is provided by the model, the user can gain insight into how each alternative performs and can conduct a side-by-side comparison graphically.

VI. EXAMPLE PROBLEMS

Problem No.	Descriptions
1	Develop timing plan for a network of signalized intersections
2	Add capacity to existing freeway bottleneck area
3	Develop an off-line diversion plan for freeway incidents

EXAMPLE PROBLEM 1

The Objective Develop a timing plan for a network of signalized intersections.

The Facts

- √ Timing plan should be developed using p.m. peak-hour volumes and capacities.
- √ Optimal signal timing is required.
- √ Approximately 10 percent trucks on the entire network.
- √ Mixed actuated and pretimed signal controls.
- √ There are 120 signalized intersections in the network.
- √ Field-observed delay data are available on some key approaches.

Project Scope On the basis of this problem description, the analyst is looking for an evaluation procedure that

- Evaluates a network of intersections,
- Optimizes signal timing, and
- Computes traffic patterns in a deterministic manner.

HCM Assessment The HCM does not evaluate systems of intersections to develop optimum timing plans.

Model Selection Five criteria identify a model capable of addressing the issues of interest:

1. Model capabilities

- Network size: approximately 150 intersections or nodes.
- Network representation: at a microscopic level and on a lane basis.
- Traffic composition: mix of automobiles and trucks.
- Traffic operations: realistic lane changing, merging, diverging, weaving modeling logic required at intersections. Logic for lane channelization at intersections is also desirable.

- Traffic control: actuated and coordinated signals.
- Model outputs: graphics outputs and static performance measures (speed, throughput, delays, on a segment basis).

2. Data requirements

- System descriptors: it is assumed that transportation network data, traffic control data, traffic operations data, and traffic demand data are all available for input.
- Calibration and validation benchmarks: observed arterial speed and throughput are available for model calibration and validation. Delay data at some approaches are available at some signalized intersections.

3. Ease of use

The model needs to be easy to use and have graphical capabilities on both input and output to facilitate model development and debugging as well as results assimilation and analysis.

4. Resources required

Three resources are important:

- Cost to run the model,
- Staff expertise, and
- Technical support.

The cost of the software may not be an issue, depending on the size of the project. However, knowledge of use of the model is key to the success of the model application. The analyst also needs to ensure that technical support for the model will be available.

5. Model applications or past experience

The analytical staff should contact their technical support staff and the model developers to learn about experience with this model in similar application situations (i.e., assessing the impact of signal timing from the system perspective).

Data Assembly Check the data required for the selected model and assemble the data accordingly.

Data Input Use an input data preprocessor to create the network model for the problem situation.

Model Calibration and Validation

- Run the model for the baseline case conditions (without the lane addition) and the default values of the parameters.
- Compare the baseline case model results with the observed field data.
- Calibrate the key model parameters to match the baseline case model results and the observed data to the extent possible; repeat this step by calibrating other parameters. Make sure that the simulation model results are valid statistically.

Output Analysis Make multiple runs for the baseline case in order to address stochastic issues and make the performance measures (arterial speed and delay at select intersections) statistically meaningful.

Alternatives Analysis Perform the same analysis (i.e., make multiple runs) for the proposed case with the lane addition and values of the calibrated parameters.

EXAMPLE PROBLEM 2

The Objective Add capacity to an existing freeway bottleneck area.

The Facts

- √ Network encompasses a freeway, parallel arterial street, and several crossing streets.
- √ Interchanges connect the freeway to the surface street network.
- √ Freeway traffic includes 95 percent passenger cars and 5 percent trucks.
- √ Surface street traffic includes 98 percent passenger cars and 2 percent trucks.
- √ Mixed actuated and coordinated signal controls on surface streets.
- √ Analysis period between 7 and 9 a.m. with 30-min peak period.
- √ There is a proposal to add a new lane to the freeway bottleneck area.
- √ Assume demand remains unchanged after capacity is increased at the bottleneck.

Project Scope On the basis of the description of the project, an areawide analysis is required, and systemwide speed and delay need to be observed to assess the effect of a lane addition to the bottleneck area.

HCM Assessment Refer to Part IV and also to Chapter 22, "Freeway Facilities."

Model Selection Five criteria identify a model capable of addressing the issues of interest:

1. Model capabilities

- Network size: approximately 50 freeway links, 20 freeway nodes, 150 street links, and 50 street nodes. This is a small network and should be accommodated by most models.
- Network representation: at a microscopic level and on a lane basis.
- Traffic composition: mix of automobiles and trucks.
- Traffic operations: realistic lane changing, merging, diverging, weaving modeling logic required at interchanges and intersections. Logic for lane channelization at intersections is also desirable.
- Traffic control: actuated and coordinated signals on streets.
- Model outputs: graphics outputs and static performance measures (speed, throughput, delays on a link basis).

2. Data requirements

- System descriptors: it is assumed that transportation network data, traffic control data, traffic operations data, and traffic demand data are all available for input.
- Calibration and validation benchmarks: observed link speed and throughput are available for model calibration and validation.

3. Ease of use

The model needs to be easy to use and have graphical capabilities on both input and output to facilitate model development and debugging as well as results assimilation and analysis.

4. Resources required

Three resources are important:

- Cost to run the model,
- Staff expertise, and
- Technical support.

The cost of the software may not be an issue, depending on the size of the project. However, knowledge of use of the model is key to the success of the model application. The user also needs to ensure that technical support for the model will be available.

5. Model applications or past experience

The analytical staff should contact their technical support staff and the model developers to learn about experience with this model in similar application situations (i.e., assessing the impact of capacity increase from the system perspective).

Data Assembly Check the data required for the selected model and assemble the data accordingly.

Data Input Use an input data preprocessor to create the network model for the problem situation.

Model Calibration and Validation

- Run the model for the baseline case conditions (without the lane addition) and the default values of the parameters.
- Compare the baseline case model results with the observed field data.
- Calibrate the key model parameters to match the baseline case model results and the observed data to the extent possible; repeat this step by calibrating other parameters. Make sure that the simulation model results are valid statistically.

Output Analysis Make multiple runs for the baseline case in order to address stochastic issues and make the performance measures (system speed and delay) statistically meaningful.

Alternatives Analysis

- Perform the same analysis (i.e., make multiple runs) for the proposed case with the lane addition and values of the calibrated parameters.
- Compare the system speed and system delay for the baseline and the proposed cases and assess the effect of the added lane capacity on network performance.

EXAMPLE PROBLEM 3

The Objective Develop an off-line diversion plan for freeway incidents.

The Facts

- √ Same facts as in Example Problem 3.
- √ Instead of adding a new lane to freeway bottleneck area, identify intelligent transportation system (ITS) technologies that can help to reduce the nonrecurring congestion.

Project Scope On the basis of the description of the project, an areawide analysis is required, and systemwide speed and delay need to be observed to assess the effect of off-line diversion plans using ITS technologies.

HCM Assessment Refer to Chapter 22.

Model Selection Five criteria identify a model capable of addressing the issues of interest:

1. Model capabilities

- Network size: approximately 50 freeway links, 20 freeway nodes, 150 street links, and 50 street nodes. This is a small network and should be accommodated by most models.
- Network representation: at a microscopic level and on a lane basis.
- Traffic representation: either micro- or mesoscopic; microscopic is desirable.
- Traffic composition: mix of automobiles and trucks.
- Traffic operations: realistic lane changing, merging, diverging, weaving modeling logic required at interchanges and intersections. Logic for lane channelization at intersections is also desirable.
- Traffic control: on-ramp closure, off-ramp diversion, freeway traffic diversion, a new signal control plan during the diversion period to favor diverted traffic.
- Model outputs: graphics outputs and static performance measures (speed, throughput, delays on the link).

2. Data requirements

- System descriptors: it is assumed that transportation network data, traffic control data, traffic operations data, and traffic demand data are all available for input.
- Traffic management plan: proposed traffic diversion plan (e.g., percent of freeway traffic to be diverted to streets).
- Signal timing plan: a proposed signal timing plan during the diversion period to favor diverted freeway traffic.
- Calibration and validation benchmarks: observed link speed and throughput are available for model calibration and validation.

3. Ease of use

The model needs to be easy to use and have graphical capabilities on both input and output to facilitate model development and debugging as well as results assimilation and analysis.

4. Resources required

Three resources stand out as being important:

- Cost to run the model,
- Staff expertise, and
- Technical support.

The cost of the software may not be an issue, depending on the size of the project. However, knowledge of use of the model is key to the success of the model application. The user also needs to ensure that technical support for the model will be available.

5. Model applications or past experience

May contact model developers or the technical support center for past experience with this model application (i.e., assessing the impact of incidents on the network).

Data Assembly Check the data required for the selected model and assemble the data accordingly.

Data Input Use an input data preprocessor to create the network model for the problem situation.

Model Calibration and Validation

- Run the model for the baseline case conditions (without an incident) and the default values of the parameters.
- Compare the baseline case model results with the observed field data (with no incident).
- Calibrate the key model parameters to match the baseline case model results and the observed data to the extent possible; repeat this step by calibrating other parameters.
- Run the baseline case with an incident but without any incident diversion plan.

Output Analysis Make multiple runs for the baseline case in order to address stochastic issues and make sure the performance measures of interest (system speed and delay) are statistically meaningful.

Alternatives Analysis

- Perform the same analysis (multiple runs) for the proposed diversion plan.
- Compare the system speed and system delay for the baseline case and the proposed case and assess the effect of the proposed diversion plan on the network in the case with the incident.

VII. REFERENCES

1. *Special Report 209: Highway Capacity Manual*, 3rd ed. (1997 update). TRB, National Research Council, Washington, D.C., 1998.
2. Gartner, N., C. Messer, and A. Rathi. *Monograph on Traffic Flow Theory*. FHWA, U.S. Department of Transportation, June 1997.
3. Rathi, A. K., and M. Venigalla. Variance Reduction Applied to Urban Network Traffic Simulation. In *Transportation Research Record 1365*, TRB, National Research Council, Washington, D.C., 1992.
4. Torres, J. F., A. Halati, A. Gafarian, and S. Guevrekian. *Statistical Guidelines for Simulation Experiments*, Vols. 1, 2, and 3. JFT Associates. FHWA, U.S. Department of Transportation, June 1983.
5. DiCesare, F., P. Kulp, M. Gile, and G. F. List. The Application of Petri Nets to the Modeling, Analysis and Control of Intelligent Urban Traffic Networks in Valette. *Application and Theory of Petri Nets 1994: Proc., 15th International Conference*, Zaragoza, Spain, 1994, pp. 2–15.
6. Kulp, P. *The Application of Petri Nets to Modeling and Analysis of Traffic Networks*. Master's Thesis. Rensselaer Polytechnic Institute, Troy, N.Y., 1994.
7. Mahmassani, H. S., T. Hu, and R. Jayakrishnan. Network Performance Under System Optimal and User Equilibrium Dynamic Assignments: Implications for Advanced Traveler Information Systems. In *Transportation Research Record 1408*, TRB, National Research Council, Washington, D.C., 1993, pp. 83–93.
8. Törn, A. A. Simulation Graphs: A General Tool for Modeling Simulation Design. *Simulation*, Vol. 37, No. 6, 1981, pp. 187–194.
9. Törn, A. A. *The Simulation Net Approach to Modeling and Simulation*. *Simulation*, Vol. 57, No. 3, 1991, pp. 196–198.
10. Wang, H. *Modeling and Analysis of Traffic Signal Systems Using Petri Nets*. Ph.D. dissertation. Rensselaer Polytechnic Institute, Troy, N.Y., 1992.
11. Wang, H., G. F. List, and F. DiCesare. Modeling and Evaluation of Traffic Signal Control Using Timed Petri Nets. *Proc., 1993 IEEE International Conference on Systems, Man and Cybernetics 2*, Le Touquet, France, IEEE, 1993, pp. 180–185.
12. Akcelik, R. *Traffic Signals: Capacity and Timing Analysis*. Research Report ARR 123. Australian Road Research Board, 1981.
13. Akcelik, R. Estimation of Green Times and Cycle Time for Vehicle-Actuated Signals. In *Transportation Research Record 1457*, TRB, National Research Council, Washington, D.C., 1994, pp. 63–72.
14. Akcelik, R. Capacity Research and Applications in Australia 1994–1998. *Road and Transport Research*, Vol. 7, No. 3, 1998, pp. 58–65.
15. Akcelik, R., E. Chung, and M. Besley. *Roundabouts: Capacity and Performance Analysis*. Research Report ARR 321. Australian Road Research Board, 1998.
16. Alvarez, L. Activity Based Highway Capacity Analysis: A Case Study. *Proc., IEEE Conference on Intelligent Transportation Systems*, IEEE, 1997, pp. 153–158.
17. Antoniotti, M., A. Desphande, and A. Girault. Microsimulation Analysis of Multiple Merge Junctions Under Autonomous AHS Operation. *Proc., IEEE Conference on Intelligent Transportation Systems*, IEEE, 1997, pp. 147–152.
18. Bang, K. L., A. Carlsson, and A. Palgunadi. Development of Speed-Flow Relationships for Indonesian Rural Roads Using Empirical Data and Simulation. In *Transportation Research Record 1484*, TRB, National Research Council, Washington, D.C., 1995, pp. 24–32.
19. Banks, J. H. Effect of Response Limitations on Traffic-Responsive Ramp Metering. In *Transportation Research Record 1394*, TRB, National Research Council, Washington, D.C., 1993, pp. 17–25.
20. Ben-Akiva, M., H. N. Koutsopoulos, and A. Mukundan. A Dynamic Traffic Model System for ATMS/ATIS Operations. *IVHS Journal*, Vol. 2, No. 1, 1994.

21. Bifulco, G. N., and U. Crisalli. Dealing with Capacity Constraints Within Stochastic User Equilibrium Assignment Models. In *Fourth International Conference on Urban Transport and the Environment for the 21st Century*, Computational Mechanics Publications, Ashurst, U.K., 1998, pp. 237–246.
22. Bonneson, J. A., and J. W. Fitts. Effect of Upstream Signal on Non-Priority Movement Capacity and Delay. In *Transportation Research Record 1572*, TRB, National Research Council, Washington, D.C., 1996, pp. 174–182.
23. Brackstone, M., and M. McDonald. Modeling of Motorway Operations. In *Transportation Research Record 1485*, TRB, National Research Council, Washington, D.C., 1995, pp. 56–60.
24. Chang, G.-L., L. Zhuang, and C. Perez. Permitted Left-Turn Capacity of Exclusive Lanes: Simulation-Based Empirical Method. In *Transportation Research Record 1457*, TRB, National Research Council, Washington, D.C., 1994, pp. 96–103.
25. Cho, M. Y., A. J. Lichtenberg, and M. A. Lieberman. Minimum Stopping Distance for Linear Control of an Automatic Car Following System. *IEEE Transactions on Vehicular Technology*, Vol. 45, No. 2, 1996.
26. Courage, K. G., C. Wallace, and R. Alqasem. Modeling the Effect of Traffic Signal Progression on Delay. In *Transportation Research Record 1194*, TRB, National Research Council, Washington, D.C., 1988, pp. 139–146.
27. Daganzo, C. F. The Cell Transmission Model: A Simple Dynamic Representation of Highway Traffic Consistent with the Hydrodynamic Theory. *Transportation Research*, Vol. 28B, No. 4, 1994, pp. 269–287.
28. Dorothy, P. W., Th. L. Maleck, and K. K. Miller. Operational Aspects of the Michigan Urban Diamond Interchange. In *Transportation Research Record 1612*, TRB, National Research Council, Washington, D.C., 1998, pp. 55–66.
29. Dowling, R. G., and W. W. K. Cheng. Evaluation of Speed Measurement and Prediction Techniques for Signalized Arterials. In *Transportation Research Record 1564*, TRB, National Research Council, Washington, D.C., 1996, pp. 20–29.
30. Duan, J.-y., and P. Yang. Microscopic Simulator of Traffic Flow. *Proc., Conference on Traffic and Transportation Studies*, ASCE, 1998, pp. 633–641.
31. Engelbrecht, R. J., D. B. Fambro, N. M. Roupail, and A. A. Barkawi. Validation of Generalized Delay Model for Oversaturated Conditions. In *Transportation Research Record 1572*, TRB, National Research Council, Washington, D.C., 1996, pp. 122–130.
32. Fambro, D. B., and N. M. Roupail. Generalized Delay Model for Signalized Intersections and Arterial Streets. In *Transportation Research Record 1572*, TRB, National Research Council, Washington, D.C., 1996, pp. 112–121.
33. Ferrara, T. C., and T. N. Lam. Analysis of Bicycle Delays at Intersections and Crossings by Computer Simulation. In *Transportation Research Record 706*, TRB, National Research Council, Washington, D.C., 1979, pp. 36–44.
34. Fi, I. Application of Traffic Simulation in the Design of Intersection Systems Concerning Traffic and Environment. *Civil Engineering*, Vol. 40, No. 2, 1996, pp. 85–94.
35. Gal-Tzur, A., D. Mahalel, and J. N. Prashker. Signal Design for Congested Networks Based on Metering. In *Transportation Research Record 1398*, TRB, National Research Council, Washington, D.C., 1993, pp. 111–118.
36. Gazis, D. C. Optimum Control of a System of Oversaturated Intersections. *Operations Research*, Vol. 12, No. 6, 1964, pp. 815–831.
37. Gerlough, D. L., and M. J. Huber. *Special Report 165: Traffic Flow Theory: A Monograph*. TRB, National Research Council, Washington, D.C., 1975.
38. Gerlough, D. L., and F. C. Barnes. *Poisson and Other Distributions in Traffic*. Eno Foundation, 1977.

39. Gerlough, D. L. *Special Report 79: Simulation of Traffic Flow*. HRB, National Research Council, Washington, D.C., 1964.
40. Giannopoulos, G. A., and M. A. S. Mustafa. Saturation Flow and Capacity of Shared Lanes: Comparative Evaluation of Estimation Methods. In *Transportation Research Record 1555*, TRB, National Research Council, Washington, D.C., 1996, pp. 50–58.
41. Hunt, J. G., and L. D. Griffiths. Vehicle Capacity at Pedestrian Crossings in the United Kingdom. *Proc., International Symposium on Highway Capacity and Level of Service*, 1991, pp. 181–191.
42. Hunt, J. G., and A. H. K. Al-Neami. Effectiveness of Pedestrian Facilities at Signal Controlled Junctions. *Proc., Institution of Civil Engineers, Transport*, Vol. 111, No. 4, 1995, pp. 268–277.
43. Janson, B. N., and J. Robles. Quasi-Continuous Dynamic Traffic Assignment Model. In *Transportation Research Record 1493*, TRB, National Research Council, Washington, D.C., 1995, pp. 199–206.
44. Jayakrishnan, R., H. S. Mahmassani, and T. Y. Hu. An Evaluation Tool for Advanced Traffic Information and Management Systems in Urban Networks. *Transportation Research*, Vol. 2C, No. 3, 1994, pp. 129–147.
45. Johnson, M. E. *Multivariate Statistical Simulation*. Wiley, 1987.
46. Kikuchi, S., and P. Chakroborty. Car Following Model Based on Fuzzy Inference System. In *Transportation Research Record 1365*, TRB, National Research Council, Washington, D.C., 1992, pp. 82–91.
47. Kosonen, I. *Simulation Tool for Traffic Signal Control Planning*. Conference Publication 320. IEEE, 1990, pp. 72–76.
48. Kuek, S. S., and W. C. Wong. Ordered Dynamic Channel Assignment Scheme with Reassignment in Highway Microcells. *IEEE Transactions on Vehicular Technology*, Vol. 41, No. 3, 1992, pp. 271–277.
49. Kuhne, R. D., and M. B. Rodiger. Macroscopic Simulation Model for Freeway Traffic with Jams and Stop-Start Waves. *Winter Simulation Conference*, 1991, pp. 762–770.
50. Kurth, D. L., A. Van den Hout, and B. Ives. Implementation of Highway Capacity Manual-Based Volume-Delay Functions in Regional Traffic Assignment Process. In *Transportation Research Record 1556*, TRB, National Research Council, Washington, D.C., 1996, pp. 27–36.
51. Kyte, M., W. Kittelson, T. Z. Zhong, B. Robinson, and M. Vandehey. Analysis of Traffic Operations at All-Way Stop-Controlled Intersections by Simulation. In *Transportation Research Record 1555*, TRB, National Research Council, Washington, D.C., 1996, pp. 65–73.
52. Lee, J.-K., and J. J. Lee. Discrete Event Modeling and Simulation for Flow Control in an Automated Highway System. *Transportation Research*, Vol. 5C, Nos. 3 and 4, 1997, pp. 179–195.
53. Lewis, P. A. W. *Simulation Methodology for Statisticians, Operations Analysts, and Engineers*. Wadsworth & Brooks, 1989.
54. Lewis, T. G., and B. J. Smith. *Computer Principles of Modeling and Simulation*. Houghton Mifflin Company, 1979.
55. Li, J., N. M. Roupail, and R. Akcelik. Overflow Delay Estimation for a Simple Intersection with Fully Actuated Signal Control. In *Transportation Research Record 1457*, TRB, National Research Council, Washington, D.C., 1994, pp. 73–81.
56. Lieberman, E. Integrating GIS, Simulation and Animation. *Winter Simulation Conference*, 1991, pp. 771–775.
57. Lin, F.-B. Saturation Flow and Capacity of Shared Permissive Left-Turn Lane. *Journal of Transportation Engineering*, ASCE, Vol. 118, No. 5, pp. 611–630.

58. Lin, P.-S., and K. G. Courage. Phase Time Prediction for Traffic-Actuated Intersections. In *Transportation Research Record 1555*, TRB, National Research Council, Washington, D.C., 1996, pp. 17–22.
59. Liu, C. C. Bandwidth-Constrained Delay Optimization for Signal Systems. *ITE Journal*, Vol. 58, No. 12, 1988, pp. 21–26.
60. Lygeros, J., and D. N. Godbole. Interface Between Continuous and Discrete-Event Controllers for Vehicle Automation. *IEEE Transactions on Vehicular Technology*, Vol. 46, No. 1, 1997, pp. 229–241.
61. Madu, C. N. *Experimental Statistical Designs and Analysis in Simulation Modeling*. Quorum Books, 1993.
62. Mahmassani, H. S., S. Peeta, T. Y. Hu, and A. K. Ziliaskopoulos. Dynamic Traffic Assignment with Multiple User Classes for Real-Time ATIS/ATMS Applications. *Proc., Advanced Traffic Management Conference*, St. Petersburg, Fla., 1993, pp. 91–117.
63. May, A. D. *Traffic Flow Fundamentals*. Prentice-Hall, Englewood, N.J., 1990.
64. May, A. D. Traffic Management from Theory to Practice: Past, Present, Future. In *Transportation Research Record 1457*, TRB, National Research Council, Washington, D.C., 1994, pp. 5–14.
65. McDonald, M., J. Wu, and M. Brackstone. Development of a Fuzzy Logic Based Microscopic Motorway Simulation Model. *Proc., IEEE Conference on Intelligent Transportation Systems*, IEEE, 1997, pp. 82–87.
66. McDonald, M., M. Brackstone, and D. Jeffery. Data Requirements and Sources for the Calibration of Microscopic Motorway Simulation Models. *Proc., Vehicle Navigation and Information Systems Conference*, IEEE, 1993, pp. 233–238.
67. McGhee, C. C., and E. D. Arnold, Jr. Review and Evaluation of Methods for Analyzing Capacity at Signalized Intersections. In *Transportation Research Record 1572*, TRB, National Research Council, Washington, D.C., 1996, pp. 160–166.
68. Messer, C. J., and J. A. Bonneson. *Capacity Analysis of Interchange Ramp Terminals*. NCHRP Project 3-47. Final Report: NCHRP Web Document 12. TRB, National Research Council, Washington, D.C., 1997.
69. Michalopoulos, P. G., and G. Stephanopoulos. Optimal Control of Oversaturated Intersections: Theoretical and Practical Considerations. *Traffic Engineering and Control*, Vol. 19, No. 5, 1978, pp. 216–221.
70. Milton, J. S., and J. C. Arnold. *Introduction to Probability and Statistics*. McGraw-Hill, Inc., New York, 1995.
71. Morgan, B. J. T. *Elements of Simulation*. Chapman and Hall, 1984.
72. Nakamura, H., M. Kuwahara, and M. Koshi. Simulation Model for the Evaluation of Weaving Capacity. *Proc., International Symposium on Highway Capacity and Level of Service*, 1991, pp. 259–270.
73. Ostrom, B., L. Leiman, and A. D. May. Suggested Procedures for Analyzing Freeway Weaving Sections. In *Transportation Research Record 1398*, TRB, National Research Council, Washington, D.C., 1993, pp. 42–48.
74. Ozaki, H. Simultaneous Analysis of a Signalized Intersection. *Proc., International Symposium on Highway Capacity and Level of Service*, 1991, pp. 271–282.
75. Parker, M. T. Effect of Heavy Goods Vehicles and Following Behaviour on Capacity at Motorway Roadwork Sites. *Traffic Engineering and Control*, Vol. 37, No. 9, 1996, pp. 524–531.
76. Peeta, S., and H. S. Mahmassani. Multiple User Classes Real-Time Traffic Assignment for Online Operations: A Rolling Horizon Solution Framework. *Transportation Research*, Vol. 3C, 1995, pp. 83–98.
77. Peeta, S., H. S. Mahmassani, R. Rothery, and R. Herman. Effectiveness of Real-Time Information Strategies in Situations of Non-Recurrent Congestion. *Proc.*,

- 2nd International Conference on Applications of Advanced Technologies in Transportation Engineering*, ASCE, 1991, pp. 409–413.
78. Pignataro, L. J., W. R. McShane, K. W. Crowley, B. Lee, and T. W. Casey. *NCHRP Report 194: Traffic Control in Oversaturated Street Networks*. TRB, National Research Council, Washington, D.C., 1978.
 79. Porche, I., and S. Lafortune. Dynamic Traffic Control: Decentralized and Coordinated Methods. *Proc., IEEE Conference on Intelligent Transportation Systems*, IEEE, 1997, pp. 930–935.
 80. Prosser, N., and M. Dunne. A Procedure for Estimating Movement Capacities at Signalized Paired Intersections. *Proc., 2nd International Symposium on Highway Capacity*, Vol. 2, Sydney, Australia, 1994, pp. 473–492.
 81. Rakha, H., M. Van Aerde, E. R. Case, and A. Ugge. Evaluating the Benefits and Interactions of Route Guidance and Traffic Control Strategies Using Simulation. *Proc., First Vehicle Navigation and Information Systems Conference*, 1989, pp. 296–303.
 82. Ran, B., S. Leight, and B. Chang. Microscopic Simulation for AHS Merging Analysis. *Proc., International Conference on Applications of Advanced Technologies in Transportation Engineering*, ASCE, 1998, pp. 77–82.
 83. Ripley, B. D. *Stochastic Simulation*. Wiley, 1987.
 84. Roberston, D. I. Control of Congested Networks in Urban Areas. *Proc., Advanced Traffic Management Conference, Large Urban Systems*, 1993.
 85. Roupail, N. M., and R. Akcelik. Preliminary Model of Queue Interaction at Signalized Paired Intersections. *Proc., Australian Road Research Board*, Vol. 16, No. 5, 1992, pp. 325–345.
 86. Rubinstein, R. Y. *Modern Simulation and Modeling*. Wiley Interscience, 1998.
 87. Sabanayagam, S., J. J. Schuster, and S. Konyk. Traffic Simulation at Unsignalized Intersections Using GPSS. *Microcomputer Applications in Transportation III*, ASCE, 1989, pp. 425–433.
 88. Sanwal, K. K., K. Petty, J. Walrand, and Y. Fawaz. Extended Macroscopic Model for Traffic Flow. *Transportation Research*, Vol. 30B, No. 1, pp. 1–9.
 89. Shafer, J. H. Easing Tappan Zee Bridge Congestion. *Public Works*, Vol. 125, No. 1, 1994, pp. 35–36.
 90. Shi, Y. S., K. Wang, and Z. S. Yang. Research on Data Stream Coding of Vehicle Saturation in ITS. *Proc., Conference on Traffic and Transportation Studies*, ASCE, 1998, pp. 662–671.
 91. Skabardonis, A., and R. Dowling. Improved Speed-Flow Relationships for Planning Applications. In *Transportation Research Record 1572*, TRB, National Research Council, Washington, D.C., 1996, pp. 18–23.
 92. Skabardonis, A., and A. D. May. Comparative Analysis of Computer Models for Arterial Signal Timing. In *Transportation Research Record 1021*, TRB, National Research Council, Washington, D.C., 1985, pp. 45–52.
 93. Smith, M. J. A Local Traffic Control Policy Which Automatically Maximizes the Overall Travel Capacity of an Urban Road Network. *Traffic Engineering and Control*, Vol. 21, 1980, pp. 298–302.
 94. Stephanedes, Y. J., P. G. Michalopoulos, and R. A. Plum. Improved Estimation of Traffic Flow for Real Time Control. In *Transportation Research Record 795*, TRB, National Research Council, Washington, D.C., 1981, pp. 28–39.
 95. Troutbeck, R. J. Effect of Heavy Vehicles at Australian Traffic Circles and Unsignalized Intersections. In *Transportation Research Record 1398*, TRB, National Research Council, Washington, D.C., 1993, pp. 54–60.
 96. Unsal, C., P. Kachroo, and J. S. Bay. Simulation Study of Learning Automata Games in Automated Highway Systems. *Proc., IEEE Conference on Intelligent Transportation Systems*, IEEE, 1997, pp. 936–941.

97. Van Aerde, M., and S. Yagar. Dynamic Integrated Freeway/Traffic Signal Networks: Problems and Proposed Solutions. *Transportation Research*, Vol. 22A, No. 6, 1988, pp. 435–443.
98. Van Aerde, M., and S. Yagar. Dynamic Integrated Freeway/Traffic Signal Networks: A Routing-Based Modeling Approach. *Transportation Research*, Vol. 22A, No. 6, 1988, pp. 445–453.
99. Velan, S. M., and M. Van Aerde. Gap Acceptance and Approach Capacity at Unsignalized Intersections. *ITE Journal*, Vol. 66, No. 3, 1996, 5 pp.
100. Vermijs, R. G. M. M. Use of Micro Simulation for the Design of Weaving Sections. *Proc., International Symposium on Highway Capacity and Level of Service*, 1991, pp. 419–427.
101. Virkler, M. R., S. Gannavaram, and A. Ramabhadran. Comparison of Planning and Operational Analysis Procedures for Signalized Intersections from the Highway Capacity Manual. In *Transportation Research Record 1555*, TRB, National Research Council, Washington, D.C., 1996, pp. 59–64.
102. Virkler, M. R., and D. L. Guell. Passing Demand on Lower Volume Two-Lane Highways. *Proc., International Symposium on Highway Capacity and Level of Service*, 1991, pp. 429–438.
103. Wang, M.-H., M. J. Cassidy, P. Chan, and A. D. May. Evaluating the Capacity of Freeway Weaving Sections. *Journal of Transportation Engineering*, Vol. 119, No. 3, 1993, pp. 360–384.
104. Webster, N., and L. Elefteriadou. Simulation Study of Truck Passenger Car Equivalents (PCE) on Basic Freeway Sections. *Transportation Research*, Vol. 33B, No. 5, 1999, pp. 323–336.
105. Winsum, W. V., and A. Heino. Choice of Time-Headway in Car-Following and the Role of Time to Collision Information in Braking. *Ergonomics*, Vol. 39, 1996, pp. 579–592.
106. Zhang, H. J., S. G. Ritchie, and Z. P. Lo. Macroscopic Modeling of Freeway Traffic Using an Artificial Neural Network. In *Transportation Research Record 1588*, TRB, National Research Council, Washington, D.C., 1997, pp. 110–119.
107. Zhu, Z., and Z. Yang. Dynamic Prediction of Traffic Flow by Using Backpropagation Neural Network. *Proc., Conference on Traffic and Transportation Studies*, ASCE, 1998, pp. 548–555.
108. Zografos, K. G., T. Nathanail, and P. Michalopoulos. Analytical Framework for Minimizing Freeway-Incident Response Time. *Journal of Transportation Engineering*, ASCE, Vol. 119, No. 4, 1993, pp. 535–549.

INDEX

Primary entries are in boldface type; first-level and second-level subentries are indented progressively. A subentry note to *see above* or *see below* identifies a first-level subentry in the same primary-entry group. Cross-references to *see* or *see also* point to related primary entries.

Index entries defined in Chapter 5, "Glossary," are marked with an asterisk. All symbols used in HCM 2000 are defined in an alphabetical list in Chapter 6, "Symbols." "E" after a page number indicates an exhibit.

A

acceleration and deceleration

- delays 16-88, 16-91E
- lanes* 13-22, 13-24, 25-1

accessibility

- areawide analysis 28-3, 30-11, 30-13
- buses 14-10, 27-10
- corridor analysis 28-3, 29-9, 29-26
- highways 29-9
- rail transit 27-28
- transit facilities 14-6, 27-4-5, 30-13

access-point density*

- multilane highways 12-6, 12-9, 21-7
- two-lane highways 12-18, 20-6

accidents and freeway capacity 22-10-11

adjustment factors* 16-11E

- bicycles 16-135-139, 27-10-11
- buses 27-10-11, 27-17-18, 27-22-23
- directional distribution 20-10, 20-11E
- driver population 21-11, 23-11-12
- freeway segments 23-5-8
- grades and terrain 20-7, 20-13-19
- heavy vehicles
 - freeways 22-7-8, 23-7-8
 - highways 20-7, 20-13-19
- interchange density (freeways) 23-6-7
- left turns 16-13, 16-122-135
- multilane highways 21-5-8, 21-11
- pedestrians 16-135-139
- progression adjustment 15-6-7, 16-19-20
- right turns 16-11E, 16-12
- saturation flow rates 16-9-13
- signalized intersections 16-10-13
 - left turns 16-13, 16-122-135
 - progression 15-6-7, 16-19-20
 - right turns 16-11E, 16-12
- two-lane highways 20-7, 20-10, 20-11E, 20-13-19

alignments of roadways *see* grades and terrain

all-way stop-controlled (AWSC) intersections *see*

intersections, AWSC

analysis hour and peak-hour volume 8-6-9

analysis periods*

- bicycles 11-18
- freeway segments 13-12
- intersections
 - roundabouts 10-34
 - signalized 10-21

analysis periods (continued)

- intersections
 - unsignalized 10-33
- multilane highways 12-10
- ramps and ramp junctions 13-24
- pedestrians 11-13
- two-lane highways 12-18

analytical approaches and methodologies 9-1

- see also* areawide analysis; corridor analysis; design analysis; multiple facility assessment; operational analysis; planning analysis
- application example 3-3E
- areawide analysis 30-1-30-16
 - problems 30-17-26
- AWSC intersections 17-32-40
 - applications 17-40-45
 - problems 17-77-98
 - worksheets 17-103
- bicycles 19-1-8
 - applications 19-8-10
 - problems 19-11-23
 - worksheet 19-24
- buses *see below* transit facilities
- corridor analysis 29-1-12
 - problem 29-12-26
- economic analyses 3-5-6, 3-8E
 - utility models 28-1, 28-4-5
- elements of analysis 3-1E
- environmental analyses 3-6, 3-8E
- freeway facilities 22-1-3
 - applications 22-19-22
 - computations 22-42-64
 - problems 22-23-41
- freeway segments 23-1-13
 - applications 23-14-17
 - problems 23-17-27
 - worksheet 23-30
- freeway weaving 24-1-19
 - applications 24-19-21
 - problems 24-22
 - worksheet 24-39
- interchange ramp terminals 26-7-9
 - applications 26-10-11
 - problem 26-14-17
- levels of analysis 3-5-6
- light rail transit *see below* transit facilities
- limitations 9-1

analytical approaches and methodologies (continued)

- local default values 9-9, 9-10–11
- methodologies structure 9-4–5E
- modeling 31-1–3
 - problems 31-25–31
- multilane highways 21-1–3
 - applications 21-12–15
 - problems 21-16–29
 - worksheet 21-30
- objectives of analysis 3-4–5
- operational conditions 3-4
- pedestrians 18-1–18-15
 - applications 18-16–18-19
 - problems 18-20–18-30
 - worksheets 18-32
- performance-based planning 28-2
- performance measures 4-2–3, 9-2, 9-8
- precision and accuracy 9-2–8
- presentation of results 4-3–5
- procedures overview 9-1–2
- ramps and ramp junctions 25-1–19
 - applications 25-19–22
 - problems 22-23–40
 - worksheet 25-40
- roundabouts 17-45–48
 - applications 17-48
 - problem 17-99
 - worksheets 17-103
- service-volume tables 9-9, 9-11–12
- signalized intersections 16-1–26
 - applications 16-26–36
 - problems 16-37–86
 - quick estimation method 10-36–47
 - worksheets 16-161
- system analysis 3-2–4
- terminology 9-1
- transit facilities 27-1–31
 - applications 27-32–33
 - problems 27-35–44
- TWSC intersections 17-1–27
 - applications 17-28–32
 - problems 17-50–77
 - worksheets 17-103
- unsignalized intersections 17-1
 - see also above* AWSC, TWSC intersections
- urban streets 15-1–12
 - applications 15-12–15
 - problems 15-15–24
 - worksheets 15-28
- volume equivalencies 9-8–10
- annual average daily traffic* (AADT) factors** 9-8–9
 - directional volume (DDHV) 8-11, 23-16–17
 - subhourly flow variations 8-9

areawide analysis 3-2, 28-1, 30-1–2

- see also* multiple facility assessment
- accessibility* 28-3
 - highways 30-11
 - transit 30-13
- congestion carryover 30-36–38
- congestion duration* 28-3
 - highways 30-9–10
 - transit 30-13
- congestion extent* 28-3
 - highways 30-10
 - transit 30-13
- congestion intensity* 28-3
 - highways 30-8–9
 - transit 30-13
- congestion variability* 28-3
 - highways 30-11
 - transit 30-13
- delay 30-9, 30-36–38
- highway facilities 30-3
 - FFS 30-3–4
 - link capacity 30-4–6
 - link speed 30-6–8
 - node delay 30-6, 30-27–36
 - performance measures 30-8–10
 - problem 30-17–22
- link capacity
 - highways 30-4–6
 - transit 30-12
- link speed
 - highways 30-6–8
 - transit 30-12
- links 30-2
- methodology 30-2–3
 - highways 30-3–11
 - transit 30-11–16
- node delay estimation 30-6, 30-27–36
- nodes* 30-2
- performance measures 30-2
 - congestion 30-38
 - highways 30-8–11
 - transit 30-13–14
- quantity of service* 28-3
- system performance 28-2–4
 - reporting 28-4E
- terminology 30-2
- transit facilities 30-11–12
 - coverage area 30-13–14
 - GIS analysis 30-14–16
 - link capacity and speed 30-12
 - manual analysis 30-16
 - performance measures 30-13–14
 - problems 30-23–26
- travel time 30-6–7

- areawide analysis (continued)
 traversal time 30-7-8, 30-39
 variability 28-3
 highways 30-11
 transit 30-13
- arrival types*** 10-23, 16-4-5
 computation 16-19-20
 descriptions 16-4E
 platoon ratio and 15-5-6, 16-4-5
 progression quality and 10-23, 16-4
 speed changes 15-12E
- arterials*** 10-1, 10-6-7
see also urban streets
- automobiles**
 accessibility 27-4-5
 registered (1986-1996) 8-14E
 rural interstate travel by 8-15E
 transit interactions
 travel time 14-31, 27-3
 weight/power ratio 8-1E
- average travel speed*** 7-2, 7-3
see also speed
- AWSC (all-way stop-controlled*) intersections *see* intersections, AWSC
- B**
- back of queue*** 10-16, 16-151
 average 16-152-155
 determining 16-151-158
 percentile 16-155-156
 queue storage rate 16-156
 worksheet 16-157E
- bicycles and bicycle facilities*** 11-4, 19-1
 access to transit facilities 27-4-5
 adjustment factor 16-13
 computation 16-138E
 formula 16-11E
 procedure 16-135-139
 analysis period 11-18
 bicycle lanes* 11-14, 19-1, 19-4-5
 urban streets 19-7
 widths 19-4
 bicycle paths* 19-1
 exclusive 19-2-3
 lengths 11-18
 pedestrians 11-16
 shared 19-3-4
 widths 11-18
 bus interaction 27-10-11
 capacity 11-14
 computational steps 19-8
 conflict zones 16-135, 16-136E
 control delay 19-6-7
 critical gap 19-6-7
- bicycles and bicycle facilities (continued)
 events and interference 19-2, 19-3
 flow 2-1, 11-14
 flow-speed relations 19-5
 hindrance* 11-15, 19-2, 19-3
 input data and values 11-17-18
 interrupted-flow facilities 11-17, 19-5
 signalized intersections 19-5-6
 unsignalized intersections 19-6-7
 urban streets 19-7
 left-turning vehicles 16-135-139
 LOS and hindrance 11-15
 LOS criteria 11-16
 exclusive paths 19-3E
 shared paths 19-4E
 urban streets 19-7E
 methodology 19-1-8
 applications 19-8-9
 input parameters 11-17-18
 problems 19-11-23
 worksheet 19-24
 modeling application 31-16E
 off-street paths *see below* paths
 on-street lanes 11-14, 19-1, 19-4-5
 peak-hour factor 11-18
 pedestrian interactions 11-16
 shared facilities 18-6-7
 performance measures 11-4-5
 planning applications 19-8
 queuing 19-7
 right-of-way 19-6
 right-turning vehicles 19-6
 service volume table 11-18-20
 signalized intersections 19-5-6
 adjustment factor 16-11E, 16-13, 16-135-139
 turning movements 10-15
 speed 11-18, 19-5
 exclusive paths 19-3E
 urban streets 19-7E
 terminology 11-14
 traffic characteristics 8-2
 transit interactions 14-6, 14-27
 accessibility 27-4-5
 uninterrupted-flow facilities 11-17, 19-1-5
 unsignalized intersections 19-6-7
 urban streets 10-25, 19-1, 19-7
 worksheets 16-161, 19-24
 bike paths *see above* bicycle paths
- bottlenecks* (freeways)**
 analysis 22-14, 22-21
 problem 31-28-29
- breakdowns and freeway capacity** 22-10-11
- buses* and bus facilities** 14-2, 27-9
see also transit facilities

buses and bus facilities (continued)

- accessibility 14-10, 27-10
- adjacent lane use 27-13
 - urban buses 27-19E, 27-20
- adjustments
 - bicycles 27-10-11
 - blockage 16-10, 16-11E
 - right turns 27-17-18
- areawide analysis 30-11-16
 - problems 30-23-26
- berths* *see below* loading areas
- bicycle adjustment 27-10-11
- blockage adjustment 16-10, 16-11E
- boarding islands* 14-10, 14-18, 14-19E
- boarding times 27-10
- bus-bus interference 27-23-24, 27-26
- bus lanes* 14-3, 14-11
 - exclusive 14-14-15, 14-16E, 14-19E
 - mixed traffic 14-15, 14-16E, 27-25
 - reserved 14-18
 - vehicle capacity 14-12E
- bus malls 8-28
- bus signals 14-17
- bus stops* 14-9-11
 - capacity 14-13, 27-13-14, 29-12, 30-12
 - loading areas 14-10-11
 - location factors 27-18
 - relocation 14-18, 14-19E
 - vehicle capacity 14-12E
 - waiting area size 27-26
- bus terminals 14-9
 - loading areas 8-29
- busways* (CBD) 14-13-14
 - capacity 27-14-16
 - reserved 14-18
 - volumes 8-28
- capacity
 - bus stops 14-13, 27-13-14, 29-12, 30-12
 - busways 27-14-16
 - loading areas 14-13, 27-13
 - mixed-traffic 27-25-26
 - person capacity 14-3-5, 27-20
 - vehicle capacity 14-3-5, 14-12-15, 27-17-19
- clearance time 14-9, 27-11
- corridor analysis 29-10-12
 - problem 29-12-26
- crush loads 27-12
- curb extensions 14-18, 14-19E
- delays 14-18, 27-11
 - see also below* dwell time
- dwell time 14-3, 14-5-6
 - calculating 27-9-11
 - problem 27-36-37
 - variability 14-8, 27-11

buses and bus facilities (continued)

- exclusive urban facilities 27-16-24
- fare payment 14-6
- freeway segments 23-7-8
- freeways 13-12
- HOV lanes 14-18
 - capacity 27-14-16
- intersection preferences 14-15-19
- loading areas* 14-7-8, 14-9E
 - bus stops 14-10-11
 - capacity 14-13, 27-13
 - productivity 8-29
 - vehicle capacity 14-12E
 - volume 14-10
- methodology 27-2-26
 - applications 27-32-33
 - problems 27-36-43
- mixed-traffic facilities 27-24-26
 - problems 27-38-41
- parameters 27-9-26
- parking restrictions 14-18, 14-19E
- passenger loads 27-5, 27-12
- peak-hour factor 14-11
- person capacity 14-3, 14-4E
 - busways 14-14E
 - calculating 14-6
 - influences 14-5E
 - mixed-traffic 27-25-26
 - problem 27-42
 - urban bus lanes 27-20
- person delay 14-18
- platooning 14-11
- priority treatments 14-15-19
 - comparisons 14-9E
 - corridors 29-12
- queue bypass/jump 14-17, 14-18, 14-19E
- queue failure rate 27-11-12
- queue formation 14-10
- reentry delay 27-11
- registered buses (1986-1996) 8-14E
- right-turn adjustments 27-17-18
- rural interstate travel 8-15E
- service types 14-7
- signalized intersections 16-10, 16-11E
 - priorities 14-17, 14-19E
- skip-stop operation 14-11, 27-13
 - example 14-15, 14-16E
 - problems 27-41, 27-43
 - speed adjustment 27-22-23
 - urban bus lanes 27-18-19
- speeds 27-8
 - busways 27-14, 27-16
 - HOV lanes 27-15E, 27-16
 - mixed-traffic 27-26

buses and bus facilities (continued)

- speeds
 - problem 27-43
 - skip-stop 27-22–23
 - urban bus lanes 27-20–24
- traffic characteristics 8-2
- traffic condition impacts 2-4–5
- traffic signals
 - bus priorities 14-17
 - timing 14-11
- turn restrictions 14-18
- two-lane highways 12-7, 12-19
 - directional segments 20-13–14, 20-17–20
 - two-way segments 20-7–9
- urban bus facilities 27-16
 - adjacent lanes 27-19E, 27-20
 - busways 14-13–14, 27-14–16
 - person capacity 27-20
 - speed 27-20–24
 - vehicle capacity 27-17–19
- vehicle capacity 14-3, 14-4E, 14-5
 - bus stops 14-13
 - busways 14-14E
 - dwelling time 14-14–15
 - influences 14-12E
 - loading areas 14-7–11
 - mixed-traffic 27-25–26
 - urban bus lanes 27-17–19
- volumes 8-28–29
 - loading areas 14-10
- waiting area size 27-26
- wheelchair accessibility 27-10

C**capacity*** 2-1–2, 8-16

see also volume-to-capacity (v/c) ratios

- bicycle facilities 11-14
- bus transit
 - bus stops 14-13, 27-13–14
 - busways 27-14–16
 - loading areas 14-13, 27-13
 - mixed-traffic 27-25–26
 - person capacity 14-3–5, 27-20
 - vehicle capacity 14-3–5, 14-12–15, 27-17–19
- freeway weaving segments 24-9–19
- freeways 8-17, 13-2, 13-28
 - estimating 22-47–48
 - reductions 22-6–12
- highways (multilane) 12-2
- intersections
 - AWSC 17-34–44
 - roundabouts 17-46–48
 - signalized 10-25
 - TWSC 10-29, 17-7–21

capacity (continued)

- intersections
 - unsignalized 10-29
- movement capacity 17-8–21
- passenger capacity
- pedestrians 11-4–5
- person capacity 14-3–5, 27-20
- potential (TWSC) 17-7–8, 17-9E
- rail transit 14-20–14-22, 27-31–32
- ramp-freeway terminals
- ramps and ramp junctions 22-8
 - diverge 13-22, 25-14
 - merge 13-22, 25-7–8
- reasonable expectancy 2-2
- roundabouts 17-46–48
- shared lane 7-12–13
- urban streets 15-9, 10-36–47
- vehicle capacity 14-3–5, 14-12–15
 - calculations 27-17–19
- capacity analysis** 2-1, 2-2
 - freeways 13-2
 - signalized intersections 16-1, 16-30, 16-31–33
- change interval* lost time** 8-26
 - see also* lost time
- Class I/II highways** 12-12–13, 12-17
- clearance lost time** 10-12–13
 - see also* lost time
- climbing lanes* (highways)** 20-28–29
- cloverleaf interchanges** 26-2–3
 - see also* interchange ramp terminals
 - turning movements 26-4E
- collector-distributor roadways (freeways)** 24-19
- collector streets*** 10-1
 - see also* urban streets
- comfort and convenience**
 - freedom to maneuver 2-2, 12-2
 - LOS measure 2-2
 - multilane highways 12-12
 - transit facilities 14-24E, 14-26, 14-31
 - perceptions 14-29
 - measures 27-6–8
 - traveler satisfaction 28-4–5
- commuters**
 - freeways 13-7
 - multilane highways 12-7
- conflicting flows**
 - AWSC intersections 17-36–39
 - bicycles and pedestrians 11-7, 18-5
 - conflict zones 16-135, 16-136E
 - TWSC intersections 10-28, 17-4–5, 17-6E
 - computations 17-18–19
- congestion** 29-1
 - duration* 28-3
 - areawide 30-9–10, 30-13

- congestion (continued)
 - duration
 - corridor 29-8-9
 - extent* 28-3
 - areawide 30-10, 3-13
 - corridor 29-9
 - intensity* 28-3
 - areawide 30-8-9, 30-13
 - corridor 29-7-8
 - multiperiod carryover 30-36-38
 - status (freeways) 13-29
 - variability* 28-3
 - highways 29-9, 30-11
 - transit 30-13
- construction activities (freeways)** 22-7-8
- control conditions*** 2-5-6
 - see also* control delay; intersections, signalized; traffic signals
- control delay*** 7-9-10, 10-15-17, 15-2
 - see also* delay; dwell time
 - acceleration-deceleration 16-88, 16-91E
 - aggregated estimates 16-22-23
 - bicycles 19-6-7
 - buses 14-18, 27-11
 - computation 10-46-47
 - deceleration-acceleration 16-88, 16-91E
 - determination 15-3-8, 16-19-23
 - field measurement 16-88-92
 - incremental delay* 15-4, 15-5, 15-7-8
 - adjustment 10-24
 - calibration factor 16-22E, 16-33
 - computation 16-21-23, 16-33
 - initial queue* 16-22, 16-33, 16-142-150
 - interchange ramp terminals 26-8-9
 - intersection (node) delay 30-27
 - adaptive control 30-27-29
 - all-way stop 30-35-36
 - signal delay 30-29-34
 - two-way stop 30-34-35
 - LOS 16-23-24
 - minimizing 16-99
 - person delay* 14-18
 - reentry delay (buses) 27-11
 - sensitivities 16-24-25
 - uniform delay* 15-5, 16-19-21, 16-23
 - determining 16-33-35
 - exclusive lanes 16-140-141
 - worksheet 16-34E
 - urban streets 10-15-16, 15-2, 15-3-8
 - worksheet 16-89
- convenience *see* comfort and convenience
- corridor analysis** 3-2, 29-1-2
 - see also* multiple facility assessment
- corridor analysis (continued)
 - accessibility* 28-3, 29-26
 - highways 29-9
 - congestion duration* 28-3
 - highways 29-8-9
 - congestion extent* 28-3
 - highways 29-9
 - congestion intensity* 28-3
 - congestion variability* 28-3
 - highways 29-9
 - corridors (defined) 28-2
 - delay
 - highways 29-6, 29-8-9
 - transit 29-11-12
 - gates* 29-2
 - highway corridors 29-3
 - excess demand 29-5-6
 - input data 29-3
 - performance measures 29-7-10
 - queue delay 29-67
 - segment capacity 29-4
 - subperiods 29-7
 - traversal times 29-6
 - methodology 29-1-2
 - highway corridors 29-3-10
 - transit corridors 29-10-12
 - O-D matrix estimation 29-26-33
 - performance measures 29-7-9, 29-20
 - points* 29-2
 - problem 29-12-26
 - quantity of service* 28-3
 - segments* 29-2
 - system performance 28-2-4
 - reporting 28-4E, 29-24E
 - terminology 29-2
 - transit corridors 29-10
 - bus-stop capacity 29-10
 - input data 29-10
 - priority treatment 29-12
 - segment capacity 29-10-11
 - speeds 29-11
 - travel time and delay 29-10-11
 - trip table estimates 29-26-32
 - variability* 28-3, 29-9
 - vehicle-trip estimate 29-26-33
 - zones 29-2
- critical gap*** 7-9, 10-28
 - bicycles 19-6-7
 - roundabouts 17-46
 - TWSC 17-5, 17-7, 17-30
- critical lane groups*** 16-14-18
- cross-flow* traffic** 11-7, 18-5
- crosswalks***
 - delays in 18-7

- crosswalks (continued)
 evaluating 11-4
 lengths 11-13
 street corners 18-8, 18-10E
 time-space 18-12-13
 zebra-striped 18-13
- D**
- D-factor *see* directional distribution
 DDHV *see* directional design-hour volume
- deceleration and acceleration**
 delays 16-88, 16-91E
 lanes* 25-1, 13-22, 13-24
- delay*** 7-9-10
see also control delay; queues and queuing
 acceleration-deceleration 16-88, 16-91E
 areawide analysis 30-9, 30-36-38
 control delay *see* control delay
 corridor analysis 29-6, 29-8-9, 29-11-12
 deceleration-acceleration 16-88, 16-91E
 incremental delay 15-4, 15-5, 15-7-8
 intersection (node) delay 30-27-36
 lost time 7-10-11
 queue delay 15-5
 turning delays 20-47E
 TWSC intersections 17-15-17
 estimates 17-25-26
 uniform delay 15-4, 15-5
 value conventions 9-7
- demand***
 average values 9-8
 freeways 13-27-29, 22-5-6, 22-46-47
 highways (two-lane) 20-6-9, 20-13-22
 management strategies 13-28
 peak demand 8-8
 signalized intersections 16-36
 vehicles registered, 8-13-14
 volume and 2-2, 8-2
- demand-to-capacity ratio* (freeways)** 22-12-14
 computation 22-48-49
- density*** 7-4
 density-flow 7-5-6
 freeways 13-3-4
 multilane highways 12-3, 12-4E
 pedestrians 11-2-3
 density-speed
 pedestrians 11-2
- design analysis** 3-5, 3-6E, 4-1-2
 freeway segments (problem) 23-17
 freeway weaving segments 24-20
 problem 24-22
 multilane highways 21-13
 problems 21-24
- design analysis (continued)
 signalized intersections 16-26, 16-27E
 problems 16-37, 16-85
 ramps and ramp junctions 25-20
- diamond interchanges*** 26-1-2
see also interchange ramp terminals
 signalized 26-4-7, 26-11-14
- directional design-hour volume (DDHV)*** 8-11, 23-16-17
- directional distribution and split*** 8-11
 analytical factor 9-8-9
 D-factors 8-11, 8-12E
 multilane highways 12-13
 traffic condition impacts 2-5
 two-lane highways 8-11, 12-13, 12-18
 adjustments 20-10, 20-11E
- diverge* influence areas *see* ramps and ramp junctions
- downgrades**
see also grades and terrain
 freeways 23-11
 multilane highways 21-9, 21-11E
 two-lane highways 20-14, 20-20E
- drivers**
 commuter vs. noncommuter 12-7, 13-7
 driver populations*
 freeway segments 13-12, 23-11-12
 freeways 13-7
 multilane highways 12-7, 12-10
 ramp-freeway junctions 13-22, 13-25
 tasks and characteristics 8-1-2
- dwelt time***
 buses 14-3, 14-5-6
 calculating 27-9-11
 problem 27-36-37
 variability 14-8, 27-11
 light rail 27-26-28
 transit systems 14-3, 14-5-6
 variability 14-8
- E**
- economic analysis** 3-5-6, 3-8E
 utility models 28-1, 28-4-5
- effective green*** 10-11-13
see also traffic signals
 ratios 10-19, 10-23
- effective red*** 10-11, 10-12E
see also traffic signals
- entrance ramps *see* on- and off-ramps
- environmental analysis** 3-6, 3-8E
- events* and occurrences**
 bicycles 19-2, 19-3
 value conventions for 9-7
- exclusive turn lanes*** 10-17-19
 lane grouping 16-6, 16-7E

exclusive turn lanes (continued)
left turns 10-18, 16-27, 16-28E
number of lanes 10-17
protected-plus-permitted 16-140-142
right turns 10-18
signal control 16-95E, 16-9
uniform delay 16-33, 16-34E
exit ramps *see* on- and off-ramps
expressways *see* highways, multilane

F

FFS *see* free-flow speed

flow 2-1

see also flow rates
parameters for interrupted 7-6-13
parameters for uninterrupted 7-1-6

flow rates* 8-16

see also saturation flow rates
bicycles 11-14, 19-5
demand flow rate
directional segments 20-13-22
two-way segments 20-6-9
flow-density relations 7-5-6
pedestrians 11-2-3
freeways 13-3-4
multilane highways 12-3
freeways 13-2-3
segments 23-7-12
weaving segments 24-3
interrupted flow 7-6-7
signalized control 7-6-7
unsignalized control 7-8-9
multilane highways 12-7, 21-7-11
pedestrians 11-1, 11-10E, 11-17, 10-26
signalized intersections 16-3-4, 16-7-8
speed-flow functions 7-5-6
multilane highways 12-3, 12-4E
two-lane highways 12-14, 12-15E
traffic characteristics
demand and volume 8-2-3
values 8-13-29
vehicle and human factors 8-1-2
two-lane highways 12-13-15, 20-13-22
adjustments 20-6-9
uninterrupted flow 7-1-2
volumes and flow rates 8-16

freedom to maneuver 2-2, 12-2

free-flow speed* (FFS) 7-3

areawide analysis 30-3-4
freeway segments 23-4-7, 13-12
freeways 13-2, 13-5-6
values 13-12
multilane highways 12-2-7
calculating 21-3-7

free-flow speed (FFS) (continued)
multilane highways
values 12-10
ramp and ramp junctions 13-22
values 13-23
two-lane highways 12-14, 12-18
base 20-5
directional segments 20-13
two-way segments 20-4-6
urban streets 10-3
speed-flow 15-9-12
values 10-7-8, 15-3E

freeway facilities* 13-1, 13-26, 22-1

see also freeway segments; freeway weaving
segments; interchange ramp terminals; ramps and
ramp junctions
accidents and breakdowns 22-10-11
areawide analysis 30-1-30-16
problem 30-17-22
bottleneck analysis 22-14, 22-21
problems 31-28-31
capacity adjustments 22-6-14
see also below capacity reductions
capacity analysis 8-17, 13-2
capacity estimation 22-47-48
capacity management 13-28
capacity reductions 22-6-7, 22-11-12
accidents and breakdowns 22-10-11
construction 22-7-8
environmental 22-9-10
permanent 22-7
problem 22-23
speed-flow 22-48
weather 22-8-9, 22-11-12
computational modules 22-42-64
variables 22-43-45
construction and capacity 22-7-8
corridor analysis 29-2-10
problem 29-12-26
daylight and capacity 22-10E
demand 22-5-6
adjustment 22-47
bottlenecks 22-14
entrance and exit 22-5-6
estimation 22-46-47
management 13-27-29
demand-capacity ratio 22-12-14
computation 22-48-49
directional facilities 22-63-64
diversion (problem) 31-30-31
entrance and exit demand 22-5-6
entrance ramps 22-8
flow characteristics 13-2-3

- freeway facilities (continued)
- geometric adjustments 13-28
 - heavy vehicles 22-7
 - HOV facilities 13-26, 13-28, 22-3
 - ice and capacity 22-9
 - incident management 13-28
 - capacity reduction 22-10–11
 - problem 22-23
 - input data 22-20E
 - lane control signals 13-28
 - lengths of sections 22-5
 - LOS inapplicable 22-3
 - mainline factors 22-16–17
 - calculation 22-56–59
 - management strategies 13-27–29, 22-21–22
 - methodology 22-1–3
 - applications 22-19–22
 - computational modules 22-42–64
 - computational steps 22-19–20
 - input data 22-20E
 - problems 22-23–41
 - modeling application 31-16E
 - night and capacity 22-10E
 - nodes 22-15, 22-44
 - on-ramps and off-ramps 13-21–22
 - capacity 22-6, 22-48
 - example 22-5
 - flow (oversaturated) 22-15E, 22-17
 - variables 22-44–45
 - oversaturated conditions 13-3, 22-15
 - analytical procedure 22-52–55
 - flows 22-15–16, 22-50–1
 - mainline factors 22-16–17, 22-56–59
 - MOE computation 22-50–63
 - problems 22-23
 - ramp flows 22-17, 22-59–61
 - segment factors 22-18, 22-61–62
 - performance measures 13-29, 22-3
 - determining 22-18
 - queue backup 22-14
 - queues on ramps 22-18
 - rain and capacity 22-9
 - ramp capacity 22-8
 - ramp closure 13-28
 - ramp-freeway junctions 13-20–26, 25-1
 - ramp metering 13-28, 22-3, 22-6
 - problem 22-23
 - ramp roadways 25-4–5
 - rubbernecking 22-11
 - sections 22-5
 - segments 13-26, 22-4–5
 - variables 22-43–44
 - shock wave analysis 22-14, 22-57–59
 - snow and capacity 22-9
- freeway facilities (continued)
- speed 22-15
 - time interval scale factor 22-6
 - tollroads compared 13-1
 - traffic management strategies 13-27–29, 22-21–22
 - traffic signals 13-28
 - traffic volumes 8-3, 8-17, 8-18–20
 - undersaturated conditions 13-3, 22-14–15
 - MOE computation 22-49–50
 - problem 22-23
 - weather and capacity 22-8–10, 22-11–12
 - freeway segments** 13-1–2, 13-26, 22-4–5, 23-1
 - see also* freeway facilities; ramps and ramp junctions
 - analysis period 13-12
 - base conditions 13-2, 23-1
 - base FFS (BFFS) 23-5
 - capacity 13-2
 - composite grade 23-28–30
 - density-flow curves 13-4
 - design analysis (problem) 23-17
 - downgrades 23-11
 - driver population 13-7, 13-12
 - adjustment 23-11–12
 - extended segments 23-8–9
 - flow 13-2–3
 - saturation 13-3, 13-5
 - flow rate calculation 23-7–12
 - free-flow speed (FFS) 13-2, 13-5–6
 - base (BFFS) 23-5
 - determining 23-4–7
 - values 13-12
 - freeway facilities 13-26–29
 - grade and terrain 13-12
 - composite grade 23-28–30
 - downgrades 23-11
 - specific grades 23-9–11
 - upgrades 23-9–11
 - heavy vehicles 13-12
 - adjustment 23-7–8
 - input data and values 13-11–13
 - results sensitivity 23-12–13
 - interchange density 13-11
 - adjustment 23-6–7
 - lane width 13-5, 13-11
 - adjustment 23-5
 - lanes (numbers) 13-6
 - adjustment 23-6
 - lateral clearance 13-11, 13-12
 - adjustment 23-5–6
 - levels of service (LOS) 13-8–11
 - criteria 23-2–4
 - determining 23-12
 - methodology 23-1–13
 - applications 23-14–17

- freeway segments (continued)
 - flowchart 23-2E
 - input parameters 13-11-13
 - problems 23-17-27
 - worksheet 23-30
 - modeling application 31-16E
 - operational analysis (problems) 23-17
 - passenger-car equivalents 13-7
 - peak-hour factor (PHF) 13-12, 23-7
 - planning analysis 23-16-17
 - queue discharge 13-5
 - ramps and ramp junctions 13-20-26
 - saturation flows 13-3, 13-5
 - sections and segments 22-5
 - service volume tables 13-13
 - speed 13-6
 - see also above* free-flow speed
 - speed-flow curves 13-3-4
 - LOS and 23-4E
 - terrain and grade 13-12
 - upgrades 23-9-11
 - worksheet 23-30
 - freeway weaving segments*** 13-13-14, 24-1
 - see also* freeway facilities
 - capacity 24-9, 24-18-19
 - Type A 24-10-11
 - Type B 24-12-15
 - Type C 24-16-17
 - collector-distributor roadways 24-19
 - configurations 13-14, 24-5
 - capacity 24-9
 - effects 13-17
 - operation type and 13-18-20
 - Type A 13-14-15, 13-18-19, 24-10-11
 - Type B 13-15-16, 13-19, 24-12-15
 - Type C 13-16-17, 13-19, 24-16-17
 - constrained operation 13-19-20, 24-7-8
 - design analysis 24-20
 - problem 24-22
 - diagram 24-3, 24-4E
 - flow rates 24-3
 - intensity 13-17, 24-7
 - factors 24-6E, 24-7
 - lane changing 13-13, 13-14
 - see also above* configurations
 - lane use characteristics 13-18-20
 - configuration and 13-17
 - level of service (LOS) 24-2-3
 - lengths 13-17-18
 - methodology 24-1-19
 - applications 24-19-21
 - flowchart 24-2E
 - input parameters 24-3, 24-4E
 - problems 24-22
 - freeway weaving segments (continued)
 - worksheet 24-39
 - modeling application 31-16E
 - multiple segments 24-19
 - nonweaving flow 13-13
 - intensity 24-7
 - lane use 13-18
 - operation type 24-7-8
 - speed 24-5-7
 - operation type 13-28-20
 - determining 24-7-8
 - operational analysis 24-20
 - problems 24-22
 - planning analysis 24-20
 - problem 24-22
 - ramp-freeway junctions 13-20-26
 - ramp-weave 13-14, 13-15E
 - service volume tables 13-20
 - speeds 24-5-7, 24-8
 - two-sided weave 13-16, 13-17E
 - unconstrained operation 13-19-20, 24-7-8
 - widths 13-18
 - worksheet 24-39
- G**
- gaps*** 7-8-9
 - critical gap 7-9, 10-28
 - bicycles 19-6-7
 - roundabouts 17-46
 - TWSC 17-5, 17-7, 17-30
 - departure headway 17-42
 - gap acceptance* (TWSC) 10-28-29
 - model example 31-7-10
 - roundabouts 7-9, 17-45
 - two-stage 17-19-20, 17-31
 - headway compared 16-105
 - headway distribution 8-24, 8-26
 - time gap 16-105
 - grades and terrain**
 - climbing lanes 20-28-29
 - composite grade* 21-9, 23-8-10
 - downgrades
 - freeways 23-11
 - multilane 21-9, 21-11E
 - two-lane 20-14, 20-20E
 - freeway segments 23-8-11
 - general terrain* 12-9-10
 - heavy vehicles 20-8, 21-10-12
 - level terrain 21-8
 - heavy vehicles 20-8
 - mountainous terrain* 21-9
 - multilane highways 12-9-10, 12-11
 - adjustments 21-8-11
 - heavy vehicles 21-10-12

grades and terrain (continued)
 rolling terrain* 21-9
 heavy vehicles 20-8
 specific grade 12-9–10
 equivalents 21-9
 speeds and 20-7
 signalized intersections 10-25
 adjustments 16-10, 16-11E
 two-lane highways 12-13, 12-17
 adjustment factor 20-7
 adjustments 20-13–20
 upgrades
 climbing lanes 20-28–29
 freeways 23-9–11
 multilane 21-9, 21-10E
 two-lane 20-14

g/C ratio *see* green time

green time*

see also traffic signals
 allocation 16-98
 estimation 10-45–46
 computation 16-108
 model 16-106–107
 signal timing 16-100
 ratio (g/C) 10-19, 10-23, 16-25

H

HCM *see* Highway Capacity Manual 2000

headways* 7-4–5

adherence (transit) 27-3, 27-7, 27-8
 departure headways 17-42–43
 determining 7-7–8
 distribution 8-24–26
 gaps 8-24, 8-26
 time gap 16-105
 queue discharge headway 8-27
 rail transit 27-28–31
 random flow 8-24–26
 saturation headways 8-26
 AWSC 17-42–44
 sign-controlled intersections 7-8–9

heavy vehicles*

see also buses; recreational vehicles; trucks
 construction 22-7
 freeway segments 23-7–8
 freeways 13-12, 22-7
 multilane highways 12-7, 12-10
 adjustments 21-7–8
 grades 21-10–12
 two-lane highways 12-7, 12-19
 adjustments 20-7–8, 20-13–21
 ramps and ramp junctions 13-22, 13-25
 signalized intersections 10-25, 16-4
 adjustment factor 16-10, 16-11E

heavy vehicles (continued)
 traffic condition impacts 2-4–5

high-occupancy vehicle* (HOV) lanes

alternatives 13-28
 buses 14-18, 27-14–16
 capacity
 freeway facilities 13-26, 13-28, 22-3

high-speed merging *see* ramps and ramp junctions

high-speed street design 10-6E, 10-7

Highway Capacity Manual 2000 1-1–6

see also analytical approaches and methodologies;
 simulation and modeling
 analysis and applications 3-1–7
 example 3-3E
 decision making and 4-1–6
 methodologies and models 31-1
 methodologies structure 9-4–5E
 precision and accuracy 9-2, 9-3–8
 procedures overview 9-1–2
 research basis 1-7E
 scope of facilities 3-1E

highway facilities

see also areawide analysis; corridor analysis;
 highways, multilane; highways, two-lane; ramps
 and ramp terminals
 areawide analysis 30-3–11
 corridor analysis 29-3–10
 multilane 12-1–11
 two-lane 12-11–19

highways, multilane* 12-1–3

access-points density 12-6
 FFS adjustment 21-7
 values 12-9
 analysis period 12-10
 areawide analysis 30-3–11
 base conditions 21-1
 composite grade 21-9
 corridor analysis 29-3–10
 design analysis 21-13
 problems 21-24–29
 directional distribution 12-13
 downgrades 21-9, 21-11E
 driver population 12-7, 12-9
 adjustment 21-11
 extended general segments 21-8–9
 flow characteristics 2-1
 flow rate 12-7
 determining 21-7–11
 flow-density functions 7-5–6, 12-3, 12-4E
 free-flow speed (FFS) 12-2–3
 access points 12-6
 adjustments 21-5–7
 base 21-5
 data and values 12-10

* Defined in Chapter 5, "Glossary."

highways, multilane (continued)

- free-flow speed (FFS)
 - determining 21-3-5
 - estimating 21-7
 - lane width/lateral clearance 12-4-5
 - speed limits 12-6-7
- grade and terrain 12-9-10, 12-11E
 - equivalents 21-8-9
 - heavy vehicles 21-9, 21-10-11
 - specific grades 21-9
- heavy vehicles 12-7, 12-10
 - adjustments 21-7-8
 - grades 21-10-12
- input data and values 12-8-10
 - sensitivity of results 21-11
- lane width/lateral clearance 12-4-5
 - FFS adjustments 21-5-7
 - values 12-10
- level of service (LOS) 12-7-8
 - criteria 21-2-4
 - determining 21-11
- median types 12-5
 - FFS adjustment 21-6
 - values 12-9
- methodology 21-1-3
 - applications 21-12-15
 - computational steps 21-13
 - flowchart 21-2E
 - problems 21-16-29
 - worksheet 21-30
- modeling application 31-16E
- operational analysis 21-13
 - problems 21-16-23
- peak-hour factor (PHF) 12-10, 21-7
- planning applications 21-13-14
- service volume table 12-10, 12-11E
- speed 21-2-3, 21-12
 - FFS 12-2-7, 21-5-7
- speed-density functions 7-5-6, 12-3, 12-4E
- speed flow curves 21-4E
- speed limits 12-6-7
- terrain *see above* grade and terrain
- trucks *see above* heavy vehicles
- upgrades 21-9, 21-10E
- v/c ratio 21-12
- volume variations 8-17, 8-20E
- worksheet 21-30

highways, two-lane* 12-11-12, 20-1-2

- access-points density 12-18, 20-6
- analysis periods 12-18
- areawide analysis 30-3-11
- average travel speed* 12-12
- base conditions 12-13
- buses *see below* heavy vehicles

highways, two-lane (continued)

- classification (Class I, II) 12-12-13, 12-17
- climbing lanes 20-28-29
- corridor analysis 29-3-10
- demand flow rate
 - two-way segments 20-6-9
- design and operational treatments 20-44-48
- directional distribution/split 12-13, 12-18
 - adjustments 20-10, 20-11E
 - directional segments 12-14, 20-12
 - climbing lanes 20-28-29
 - demand flow rate 20-13-22
 - free-flow speed 20-13
 - grades 20-13-20
 - LOS 20-22
 - passing lanes 20-22, 20-24-28
 - problems 20-33-38
 - time-spent-following 20-22, 20-23-24
 - travel speed 20-20-21
- directional segments 20-13-22
- downgrades 20-14, 20-20E
- flow characteristics 2-1
- flow rate 12-13-15
 - adjustments 20-6-9
 - demand 20-6-9, 20-13-22
- free-flow speed (FFS) 12-14, 12-18
 - base 20-5
 - directional segments 20-13
 - two-way segments 20-4-6
- grade and terrain 12-13, 12-17
 - adjustment factors 20-15-19
 - computations 20-20
 - directional segments 20-13, 20-15-19
 - downgrades 20-14, 20-20E
 - two-way segments 20-7
 - upgrades 20-14
- heavy vehicles 12-7, 12-19
 - directional segments 20-13-14, 20-17-20
 - two-way segments 20-7-9
- input data and values 12-17-19
- intersection turn lanes 20-46-47
- lane widening 20-45-46
- lane widths 12-13
 - adjustment 20-5-6
 - input data 12-18
- left-turn lanes 20-46
 - two-way (TWLTL) 20-47-48
- level of service (LOS) 12-15-17, 20-2
 - directional segments 20-22
 - passing lanes 20-27
 - problems 20-30-43
 - two-way segments 20-3, 20-4E, 20-10-11
 - uninterrupted-flow facilities 20-29-30
- methodology 20-2-30

- highways, two-lane (continued)
- methodology
 - applications 20-30–32
 - flowchart 20-2
 - input parameters 12-17–19
 - problems 20-32–48
 - worksheets 20-49
 - modeling application 31-16E
 - no-passing zones 12-13, 12-17–18
 - speed effects 20-9, 20-10E
 - time-spent-following 20-23E
 - passing lanes 12-15
 - alternatives 20-44–46
 - analysis 20-25–28
 - climbing lanes 20-28–29
 - directional segments 20-22, 20-24–28
 - lengths 12-18, 20-24E
 - LOS 20-27–28
 - opposing traffic 20-28
 - time-spent-following 20-24, 20-26–27
 - travel speed 20-27, 20-28E
 - turnouts 20-45
 - peak-hour factor (PHF) 12-18, 20-7, 20-13
 - recreational vehicles *see above* heavy vehicles
 - service volume table 12-19
 - shoulder use 20-45
 - turnouts 20-44–45
 - shoulder widths 12-13, 12-18
 - adjustment 20-5–6
 - speeds
 - see above* free-flow speed
 - see below* travel speed
 - terrain and grade *see above* grade and terrain
 - time-spent-following 12-13, 12-14E, 12-15E
 - determining 20-9–10
 - directional distribution 20-9, 20-11E
 - directional segments 20-22, 20-23–24
 - two-way segments 20-9–10
 - total travel 20-12
 - travel speed 12-12, 20-9, 20-10E
 - directional segments 20-20–21
 - two-way segments 20-5
 - trucks *see above* heavy vehicles
 - turning delays 20-47E
 - turnouts 20-44–45
 - two-way left-turn lanes (TWLTL) 20-47–48
 - two-way segments 12-14–15, 20-3
 - demand flow rate 20-6–9
 - free-flow speed 20-4–6
 - LOS 20-10–11
 - problems 20-39–43
 - time-spent-following 20-9–10
 - travel speed 20-9, 20-10E
 - upgrades 20-14, 20-15–19
- highways, two-lane (continued)
- upgrades
 - climbing lanes 20-28–29
 - v/c ratio 20-11–12
 - volumes 8-20–21
 - wider cross sections 20-45–46
 - worksheets 20-49
 - hindrance* (bicycles)** 11-15, 19-2, 19-3
 - horizontal alignments of roadways *see* grades and terrain
 - HOV *see* high-occupancy vehicle lanes
 - human factors** 8-1–2
- I**
- incremental delay* *see* control delay
 - influence areas* *see* ramps and ramp junctions
 - initial queue delay*** 16-22, 16-33, 16-142
 - method 16-142–150
 - multiple time periods 16-146
 - numerical examples 16-145–148
 - worksheet 16-150E
 - intelligent transportation systems* (ITS)** 2-6
 - interchange ramp terminals*** 3-1E, 26-1–4
 - alternative configurations 26-14–17
 - cloverleaf interchanges 26-2–3, 26-4E
 - control delay 26-8–9
 - diamond interchanges 26-1–2
 - signalized 26-4–7, 26-11–14
 - interchange density 13-6, 13-11
 - FFS adjustment 23-6–7
 - level of service (LOS) 26-8–9
 - criteria 26-9
 - methodology 26-7–9
 - applications 26-10–11
 - problem 26-14–17
 - modeling application 31-16E
 - parclo 26-2–3, 26-4E
 - saturation flow rates 26-9
 - signalized interchanges 26-1, 26-4–5
 - demand starvation 26-7
 - lane change and use 26-6
 - off-sets 26-13–14
 - phasing and timing 26-7, 26-12–14
 - platoon behavior 26-6–7
 - queuing 26-5–6
 - turning movements 26-3–4
 - interchanges *see* interchange ramp terminals
 - intermediate street design** 10-6E, 10-7
 - interrupted-flow facilities** 2-1, 3-1E
 - see also* interchange ramp terminals; intersections; traffic signals
 - access control points 2-5
 - base conditions 2-3–4
 - bicycles 11-17, 19-5–7
 - control delay 7-9–10

- interrupted-flow facilities (continued)
 - intersections
 - control delay 7-9–10
 - sign-controlled 7-8–9
 - signalized 7-7–8
 - lost time 7-10–11
 - modeling application 31-16E
 - parameters 7-6–13
 - pedestrians 18-7–18-15
 - queuing 7-11–13
 - saturation flow rate 7-10–11
 - signal control 7-7–8
 - speed 7-9
- intersection turn lanes** 20-46–47
- intersection turning movements** 10-1
 - estimation method 10-19–20, 10-33
 - interchanges 26-1, 26-3–4
- intersections, AWSC (all-way stop-controlled)** 10-30–31, 17-32
 - analysis period 10-33
 - approaches 17-37
 - capacity model 17-34–44
 - multilane sites 17-36–39
 - single-lane sites 17-35–36
 - computations 17-41–44
 - conflict (degree of) 17-36–39
 - control delay 10-31
 - computation 17-40
 - estimation 30-35–36
 - gaps and headway 7-9
 - geometry 10-33, 17-41–42
 - headways 17-9, 17-33
 - saturation 17-42–44
 - input data and values 10-33
 - level of service (LOS) 17-32, 17-44
 - methodology 17-32–41
 - applications 17-40–43
 - flowchart 17-41E
 - input parameters 10-33
 - problems 17-80–99
 - worksheets 17-103
 - modeling application 31-16E
 - multilane sites 17-36–39
 - peak-hour factors (PHF) 10-33
 - planning and design 17-44–45
 - saturation headway 17-44
 - service volume table 10-35
 - single-lane sites 17-35–36
 - study period 10-33
 - traffic signs 2-5, 7-9
 - turning movements 10-33
 - volumes 10-33
 - worksheets 17-103
- intersections, signalized** 10-9, 10-11E, 16-1–2
 - acceleration-deceleration delays 16-88, 16-91E
 - actuated signal controls 10-14, 16-94–95
 - k-values 15-8E, 16-22E
 - adjustment factors 16-10–12
 - formulas 16-11E
 - signal progression 15-6–7, 16-19–20
 - analysis period 10-21
 - analysis types 16-26, 16-27E
 - area type 10-26
 - adjustment factor 16-11E, 16-12
 - arrival types 10-23, 15-5–6, 16-4–5
 - computation 16-19–20
 - descriptions 16-4E
 - progression quality 10-23
 - speed-flow 15-12E
 - back of queue 10-16, 16-151
 - average 16-152–155
 - determining 16-151–158
 - percentile 16-155–156
 - queue storage rate 16-156
 - worksheet 16-157E
 - bicycle blockage 16-13, 16-135–139
 - computation outline 16-138E
 - formula 16-11E
 - bicycles 19-5–6
 - protected turns 10-15
 - bus blockage 16-10, 16-11E
 - buses 10-25, 16-10, 16-11E
 - priorities 14-17, 14-18, 14-19E
 - capacity 10-15, 16-13–14
 - capacity analysis 16-30, 16-31–33
 - computational steps 16-27–35
 - results 16-35–36
 - control delay 10-15–16, 15-2
 - acceleration-deceleration 16-88, 16-91E
 - aggregated estimates 16-22–23
 - computation 10-46–47
 - determination 15-3–8, 16-19–23
 - field measurement 16-88–92
 - initial queue 16-22, 16-33, 16-142–150
 - LOS 16-23–24
 - minimizing 16-99
 - node delay 30-27–36
 - sensitivities 16-24–25
 - worksheet 16-89
 - critical lane groups 16-14–18
 - cycle failure 10-16
 - cycle length 10-19, 10-21–22
 - delay and 16-25
 - estimation 10-45
 - data and values 10-17–26
 - delay *see above* control delay

- intersections, signalized (continued)
- delay-to-demand ratio 16-24
 - demand volumes 16-36
 - dual-ring phases 16-96E, 16-97, 16-103–104
 - effective green time 10-11–13
 - effective red time 10-11, 10-12E
 - estimation method 10-36–47
 - data needs 10-37
 - worksheet 10-47
 - exclusive turn lanes 10-17–19
 - lane grouping 16-6, 16-7E
 - signal control 16-95E, 16-9
 - uniform delay 16-33, 16-34E
 - flow characteristics 10-9, 10-11–14
 - flow rates 16-3–4
 - determining 16-7–8
 - fully actuated controls 10-14, 16-94
 - gap 16-105
 - geometry 16-3
 - grade adjustments 10-25
 - factor 16-10, 16-11E
 - green extension time 16-108
 - green phasing 16-95E, 16-96–97
 - green time allocation 16-98
 - green time estimation 10-45–46
 - computation 16-108
 - model, 16-106–107
 - signal timing 16-100
 - green time ratio (g/C) 10-19, 10-23, 16-14, 16-25
 - heavy vehicle factors 10-25, 16-4
 - adjustment 16-10, 16-11E
 - incremental delay 15-4, 15-5, 15-7–8
 - computation 16-21–23, 16-33
 - initial queue delay 16-22, 16-33
 - method 16-142–150
 - worksheet 16-150E
 - input data and values 10-17–27
 - input parameters 16-3–6
 - interchanges 26-1, 26-4–7
 - timing 26-11–14
 - intersection control type 10-21
 - k-values for controllers 15-8E, 16-22E
 - lagging green phasing 16-95E, 16-96–97, 16-128–131
 - lane additions 10-17
 - lane grouping 16-6, 16-7E
 - analytic parameters 16-3E
 - capacity 10-15
 - equalizing 16-98
 - lane utilization 10-26
 - adjustment factor 16-11E, 16-12
 - lane volume 10-41–43
 - worksheet 10-47
 - lane widths 10-24–25
 - adjustment factor 16-10, 16-11E
- intersections, signalized (continued)
- leading green phasing 16-95E, 16-96–97, 16-128–131
 - left-turns 10-37–38
 - see also* left lanes and turns
 - adjustment factors 16-13, 16-122–135
 - exclusive lanes 10-18
 - permitted turn phases 16-23, 16-128–131
 - signal phasing 10-22–23
 - worksheets 10-47, 16-132E, 16-133E
 - level of service (LOS) 10-15–17, 16-2
 - control delay 10-15–16, 16-23–24
 - methodology 16-2–24
 - worksheet 16-32E
 - lost time 7-10, 10-12–14
 - estimation 10-45
 - signal timing 16-101
 - values 10-22–23
 - methodology (capacity/LOS) 16-1–24
 - applications 16-26–36
 - flowchart 16-2E
 - input parameters 10-17–27
 - inputs 16-3–6
 - problems 16-37–86
 - sensitivities 16-24–25
 - worksheets 16-161
 - methodology (estimation) 10-36–47
 - modeling application 31-16E
 - multiphase signals 16-96–98, 16-112–120
 - critical lanes 16-18E
 - node delay estimation 30-27
 - adaptive control 30-27–29
 - all-way stop 30-35–36
 - signal delay 30-29–34
 - two-way stop 30-34–35
 - operational analysis 16-1–24
 - flowchart 16-28E
 - parking maneuvers 10-25
 - peak-hour factor (PHF) 10-21
 - peak-hour volumes 10-19
 - pedestrian adjustments 16-135–139
 - blockage 16-11E, 16-13
 - computation 16-138E
 - flow values 10-25
 - protected turns 10-15
 - pedestrian facilities 11-13, 18-7–13
 - permitted phasing 16-23
 - left-turns 16-122–134
 - permitted turning 10-15
 - phase control plans 10-43–44, 16-95
 - dual ring 16-96E, 16-97, 16-103–104
 - multiphase 16-96–98, 16-112–120
 - two-phase 16-96E, 16-100, 16-109–110
 - phasing *see below* signal phasing
 - platoon ratio 15-6, 16-20

- intersections, signalized (continued)
 - pretimed signal controls 10-14, 16-94, 31-10–12
 - k-values 16-22E
 - timing plan 16-98–101
 - progression adjustment 16-19–20
 - progression quality 10-23, 16-4
 - protected phasing 10-15, 10-22, 16-16E
 - protected-plus-permitted phasing 16-23–24, 16-128
 - procedure 16-140–143
 - red time 10-11, 10-12E
 - right lanes 10-18, 16-11E, 16-12
 - RTOR 16-9, 16-12
 - queue accumulation polygons (QAPs) 16-23
 - application 16-106–107, 16-112–114
 - uniform delay 16-140–141
 - queue calculations *see above* back of queue
 - queue delay (initial) 16-22, 16-33
 - method 16-142–150
 - queue service time 16-107–108
 - queue size 16-112–114, 16-140–141
 - queue storage rate 16-156
 - queuing diagram 7-12E
 - right turns
 - adjustment factor 16-11E, 16-12
 - right turn on red 16-9, 16-12
 - volumes 10-42, 16-9
 - saturation conditions 7-11–12
 - saturation flow rates 7-10–11, 10-15
 - adjustment factors 16-10–12
 - determining 16-9–13, 16-30, 16-31E
 - measurement 16-158–160
 - signal timing 16-99
 - values 10-24
 - semiactuated controls 10-14, 16-94–95, 16-115–116
 - service volume table 10-26–27
 - signal characteristics 10-14–15
 - signal controllers 16-94–95
 - k-values 15-8E, 16-22E
 - settings 16-105–106
 - signal controls 16-94–95
 - flow rate and 7-7–8
 - fully actuated 10-14
 - semiactuated 10-14
 - traffic-actuated 16-101–120
 - signal coordination 15-9
 - signal cycle failure 10-16
 - signal cycle length 10-19, 10-21–22
 - delay and 16-25
 - estimation 10-45
 - signal delay *see above* control delay
 - signal density 10-8
 - speed and 15-9–12
 - signal phasing 10-14–15, 10-22
 - signal progression 15-6–7, 16-19–20
- intersections, signalized (continued)
 - signal timing
 - design method 16-93–121
 - estimation 10-43–46, 16-99–101
 - estimation limits 16-120–121
 - example 16-116–120
 - left-turn flows 10-37, 10-42
 - lost time 16-101
 - phase plans 16-95–98
 - pretimed 16-98–101
 - semiactuated 16-115–116
 - signal controllers 16-94–95
 - timing plans 16-98–112
 - traffic actuated 16-101–115
 - signalization conditions 16-3E, 16-5–6
 - speed-flow curves 15-9–12
 - terminology 10-12E
 - time gap 16-105
 - timing plans
 - minimum phase time 16-111
 - pretimed 16-98–100
 - traffic-actuated 16-101–115
 - traffic-actuated signal controls 16-94–95
 - control settings 16-105–106
 - estimation limits 16-120–121
 - model 16-101–104
 - multiphase example 16-116–120
 - timing computations 16-115E
 - timing plan 16-101–115
 - worksheet 16-103
 - traffic conditions 16-3–5
 - turning movements 10-15, 10-19–20
 - values 10-19–20, 10-33
 - two-phase signals 16-96, 16-100, 16-109–110
 - uniform delay 15-5, 16-19–21, 16-23
 - determining 16-33–35
 - exclusive lanes 16-140–141
 - worksheet 16-34E
 - variables 10-12E
 - v/c ratios 10-16, 16-14
 - application 15-9–12
 - computation 10-46
 - critical lanes 16-14–15
 - equalizing 16-98
 - volume adjustment 16-30, 16-31E
 - volumes 10-33, 16-3–5
 - worksheets 16-161
- intersections, TWSC (two-way stop-controlled)**
 - 10-27–29, 17-1
 - analysis period 10-33
 - blockage 17-15–17
 - delay estimates 17-25–26
 - capacity 10-29
 - computations 17-28

intersections, TWSC (two-way stop-controlled) (continued)

- capacity
 - movement 17-8–21
 - potential 17-7–8, 17-9E
 - shared lane 17-12–13
- computational steps 17-28–31
- conflicting flows 10-28, 17-4, 17-6E
 - computations 17-18–19
- control delay 10-31
 - computation 17-23–24
 - estimation procedure 30-34–35
- control determination 17-27
- criteria 17-27
- critical gap 17-5, 17-7
 - computing 17-30
- delay estimates 17-25–26
- flared approaches 17-21–22
 - computing 17-31
- flow conflicts 10-28, 17-4, 17-6E
 - computations 17-18–19
- follow-up time 10-28
 - computing 17-30
- gap acceptance
 - models 10-28–29
 - two-stage 17-19–20, 17-31
- gap, critical 17-5, 17-7
 - computing 17-30
- gaps and right-of-ways, 7-8–9
- geometry 10-32
- impedance effects 17-9–12
 - computing 17-30
- input data and values 10-32
 - requirements 17-3
- LOS criteria 17-1, 17-2
 - LOS F 17-26
- major-street approaches 10-27–28
 - conflicts 17-4–5, 17-6E
 - shared-lane capacity 17-13
 - stream priorities 17-3–4
- medians 10-29, 17-3
- methodology 17-1–28
 - applications 17-28–31
 - flowchart 17-29E
 - input parameters 10-32
 - problems 17-45–80
 - worksheets 17-103
- minor-street approaches 10-27–28
 - conflicts 17-4–5, 17-6E
 - flared 17-21–22, 17-31
 - shared-lane capacity 17-12
 - stream priorities 17-3–4
- modeling application 31-16E
- movement capacity 17-8
 - impedance effects 17-9–12

intersections, TWSC (two-way stop-controlled) (continued)

- movement capacity
 - shared-lane capacity 17-12–13
 - upstream signals 17-13–21
- peak-hour factor 10-33
- pedestrians 17-4, 17-5
 - impedance 17-10, 17-11–12
- performance measures 10-31
- planning and design 17-31–32
- platoon analysis 17-14–18
- queue clearance 17-14–15
- queue lengths 10-31
 - estimation 17-22–23
- right-of-way ranking 10-27–28
 - stream priority 17-3–4
- service volume tables 10-34–35
- shared-lane capacity 17-12–13, 17-26
 - computing 17-31
- traffic conflicts 17-4–5, 17-6E
- traffic signals 17-13–19
 - computing effects 17-30
- traffic signs 2-5, 7-8–9
- turning movements 10-33
- two-way left-turn lanes 10-29
- upstream signal effects 17-13–19
 - computing 17-30
- v/c ratio 10-31
- vehicle impedance 17-9–11
- volumes 10-33
- worksheets 17-103
- intersections, unsignalized** 10-27–35, 17-1
 - see also* intersections, AWSC; intersections, TWSC; roundabouts
 - AWSC intersections 10-30–31, 17-32–44
 - bicycles 19-6–7
 - modeling application 31-16E
 - pedestrians 11-13, 18-13–15
 - problems 17-29–101
 - roundabouts 10-31, 10-34, 17-45–48
 - service volume tables 10-34–35
 - TWSC intersections 10-27–29, 7-1–31
- interstate highways *see* highways, multilane
- ITS *see* intelligent transportation systems

K**K-factors** 9-8–9

- directional distribution 8-11
- peak volume 8-9–10
- values (typical) 8-9

L**lagging green phasing** 16-95E, 16-96–97, 16-128–131

lanes

- see also* exclusive turn lanes; left lanes and turns; right lanes and turns
 - acceleration lanes* 13-22, 13-24, 25-1
 - bicycle lanes* 11-14, 19-1, 19-4-5, 19-7
 - bus lanes* 14-3, 14-11
 - exclusive 14-14-15, 14-16E, 14-19E
 - mixed-traffic 14-15, 14-16E, 27-25
 - reserved 14-18
 - vehicle capacity 14-12E
 - deceleration lanes* 13-22, 13-24, 25-1
 - exclusive turn lanes* 10-17-18, 16-6-7
 - freeway segments 13-5, 13-11
 - FFS adjustments 23-5-6
 - freeway weaving 13-13-20
 - freeways 13-5-6
 - HOV* lanes 13-26
 - alternatives 13-28
 - intersection turn lanes 20-46-47
 - lane changing 13-13, 13-14
 - see also* freeway weaving segments
 - lane control signals 13-28
 - lane distribution* 2-5, 8-12-13
 - ramp areas 13-22
 - lane grouping* 16-6, 16-7E
 - analytic parameters 16-3E
 - capacity 10-15
 - equalizing 16-98
 - lane utilization* 10-26
 - adjustment factor 16-11E, 16-12
 - freeway weaving 13-17, 13-18-20
 - interchanges 26-6
 - lane volume 10-41-43
 - worksheet 10-47
 - lane widening 20-45-46
 - left-turn lanes (two-way*; TWLTL)
 - multilane highways 12-1
 - signalized intersections 10-29
 - two-lane highways 20-47-48
 - multilane highways 12-4-5, 12-10, 21-5-7
 - numbering conventions 13-21
 - passing lanes* *see* passing lanes
 - signalized intersections 10-24-25, 16-10, 16-11E
 - two-lane highways 12-13, 12-18
 - adjustment 20-5-6
 - weaving configurations 13-14-18
 - weaving lanes 13-18-20
- lateral clearance***
- freeway segments 13-5, 13-11
 - FFS adjustment 23-5-6
 - multilane highways 12-4-5
 - FFS adjustments 21-5-7
 - values 12-10
 - ramps and ramp junctions 13-22

leading green phasing 16-95E, 16-96-97, 16-128-131

left lanes and turns

- adjustment factors 16-11E, 16-13, 16-122E
 - method 16-122-135
 - bicycles and vehicles 16-135-139
 - complex phasing 16-23, 16-128-131
 - critical lane groups 16-15-17
 - dual-ring phases 16-97
 - exclusive lanes 10-18, 10-42, 16-6-7
 - green time 16-128-131
 - lane grouping 16-6, 16-7E
 - lane volume 10-40E, 10-42
 - estimating 10-43E
 - left-lane equivalence 10-42-43
 - multilane approaches 6-124-126
 - permitted turn phasing 16-23
 - procedure 16-122-134
 - phasing types 16-13
 - protected phasing 10-22, 16-16E
 - protected-plus-permitted phasing 16-23-24
 - critical lane groups 16-17E
 - lane volumes 10-42-43
 - procedure 16-140-142
 - signal phasing 10-22
 - single lane approaches 16-126-128
 - sneakers 10-42, 16-102, 16-124
 - turning movements 10-15
 - two-lane highways 20-46
 - two-way left-turn lanes (TWLTL) 10-29, 12-1
 - two-lane highways 20-47-48
 - uniform delay 16-140-142
 - worksheets 10-47, 16-132E, 16-133E
- level of service* *see* LOS
- light rail transit* (LRT)** 8-2, 14-1, 14-3, 14-19, 27-26
- capacity 14-20-22
 - calculating 27-31-32
 - door availability 27-27
 - dwelt time 27-26-28
 - minimum headways 27-28-31
 - on-street operation 27-29-30
 - operating margins 27-28
 - passenger flows 27-27E, 27-28
 - person capacities 14-22E, 27-31-32
 - priority treatments 14-22
 - problem 27-44-45
 - signal priorities 14-22
 - speed 27-31-32
 - signals and 27-30
 - single track sections 27-30-31
 - travel times 14-20, 14-22E
 - volumes 8-29
 - peak 27-27
 - wheelchair accessibility 27-28
- links and link analysis *see* areawide analysis

loading areas* (buses) 14-7-8, 14-9E

- bus stops 14-10-11
- capacity 14-13, 27-13
- productivity 8-29
- vehicle capacity 14-12E
- volume 14-10

loading areas (transit) 14-3

local streets 10-1

see also urban streets

LOS (level of service)* 2-2-4, 4-3, 28-1

see also performance measures; quality of service
analysis hour and 8-8

AWSC intersections 17-32, 17-44

bicycles (criteria) 11-6

- exclusive paths 19-3E
- shared paths 19-4E
- urban streets 19-7E

Class I/II highways 12-13

control delays

urban 10-15-16

factors affecting 2-3-6

freeway segments 23-2-4, 23-12

freeway weaving segments 24-2-3

freeways 13-8-11

HCM methods 4-1-4

interchanges 26-8-9

levels 2-3

measurements 4-2-5

MOE and 4-3

multilane highways 12-7-8

- criteria 21-2-4
- determining 21-11

pedestrians 18-1

- criteria 11-7
- cross flows 18-5E
- queuing areas 11-10E, 18-6E
- shared paths 18-7E
- signalized intersections 18-8E
- stairways 18-5E
- unsignalized intersections 18-15E
- urban streets 18-16E
- walkways 11-9E, 18-4E

ramp areas 13-23-24, 25-4-5

- diverge 25-14-15
- merge 25-8

service flow rates 2-3

service measures and 4-3

signalized intersections 10-15-17, 16-2

- control delay 10-15-16, 16-23-24
- methodology 16-2-24
- worksheet 16-32E

transit facilities 14-23

hours-of-service 27-6E

LOS (level of service) (continued)

transit facilities

- intercity transit 27-4E
- paratransit 27-4E
- passenger load 27-6E
- reliability 27-8E
- service frequency 27-2

two-lane highways 12-12, 12-15-17, 20-2, 20-29

directional segments 20-22

passing lanes 20-27

two-way segments 20-3, 20-4E, 20-10-11

uninterrupted-flow facilities 20-29-30

urban streets 10-4-5

determining 15-2-3, 15-27-28

weaving segments 24-2-3

lost time* 7-10-11, 10-12-14

change interval* lost time 8-26

clearance lost time* 10-12-13

estimation 10-45

example 7-8

signal timing 16-101

signalized intersections 8-26-28

start-up lost time* 8-26, 8-28, 10-12-13

total lost time 10-14

unsignalized intersections 8-28

values 10-22-23

LRT *see* light rail transit

M

mainlines* (freeways) 22-16-17

calculation 22-56-59

major-street* approaches (TWSC) 10-27-28

- conflicts 17-4-5, 17-6E
- shared-lane capacity 17-13
- stream priorities 17-3-4

measures of effectiveness* (MOE) 2-3, 3-2

see also service measures

computation 22-50-63

LOS and 4-3

procedures 22-49-63

oversaturated 22-50-63

undersaturated 22-49-50

uses 4-2

medians

multilane highways 12-1, 12-5, 12-9, 21-6

TWSC intersections 10-29, 17-3

merge* influence areas *see* ramps and ramp junctions

minor arterials* 10-6, 10-7

minor-street* approaches (TWSC) 10-27-28

- conflicts 17-4-5, 17-6E
- flared 17-21-22, 17-31
- shared-lane capacity 17-12
- stream priorities 17-3-4

* Defined in Chapter 5, "Glossary."

mixed-traffic bus facilities* 27-24–26

problems 27-38–41

modeling *see* simulation and modeling

MOE *see* measures of effectiveness

motorcycles 8-14E

motor vehicles

see also buses; passenger cars; recreational vehicles;
vans

driver characteristics 8-1

numbers registered 8-13–14

operating characteristics 8-2

multilane highways *see* highways, multilane

multiple facility assessment 28-1

see also areawide analysis; corridor analysis

areawide analysis 30-1–2

corridor analysis 29-1–2

system LOS 28-5–6

system performance 28-1–3

traveler satisfaction 28-1, 28-4–6

utility models 28-1, 28-4–5

N

node delay estimation 30-27

adaptive control 30-27–29

all-way stop 30-35–36

two-way stop 30-34–35

signal delay 30-29–34

nodes* 22-15, 30-27

variables 22-44

no-passing zones* (two-lane highways) 12-13, 12-17–18

see also passing lanes

speed effects 20-9, 20-10E

time-spent-following 20-23E

values 12-17-12-18

O

occurrences *see* events and occurrences

on- and off-ramps (freeways) 13-21–22

capacity 22-6, 22-48

example 22-5

flow (oversaturated) 22-15E, 22-17

influence areas 13-23

interchanges 26-1

off-ramps

capacity 25-4

left-hand 25-17

other 25-17

two-lane 25-4, 25-15–16

weaving 13-13

on-ramps 13-21–22

capacity 25-4

left-hand 25-11

other 25-10–11

two-lane 25-4, 25-8–9

on- and off-ramps (freeways) (continued)

variables 22-44–45

weaving 13-13

operational analysis 3-5, 3-6E, 4-1

bicycles (problems) 19-11

corridor analysis 29-1

freeway segments (problems) 23-17

freeway weaving segments 24-20

problems 24-22

models 31-1

multilane highways 21-13

problems 21-15

pedestrians (problems) 18-19

ramps and ramp junctions 25-20

problems 25-23

signalized intersections 16-1–24, 16-27

problems 16-37

two-lane highways (problems) 20-32

oversaturation* conditions (freeways) 13-3, 22-15

analytical procedure 22-52–55

flows 22-15–16, 22-50–1

mainline factors 22-16–17, 22-56–59

MOE computation 22-50–63

problems 22-23

queue discharge 13-5

ramp flows 22-17, 22-59–61

segment factors 22-18, 22-61–62

P

paratransit* 27-3–4

parclo (partial cloverleaf interchanges*) 26-2–3

turning movements 26-4E

parking

maneuvers (urban) 10-25

park-and-ride lots 14-24E, 14-27

transit flow restrictions 14-18, 14-19E

passenger cars *see* automobiles

passenger demand, loads, perceptions, etc. *see* transit facilities

passing lanes* (two-lane highways) 12-15

alternatives 20-44–46

analysis 20-25–28

climbing lanes 20-28–29

directional segments 20-22, 20-24–28

lengths 12-18, 20-24E

LOS 20-27–28

opposing traffic 20-28

time-spent-following 20-24, 20-26–27

travel speed 20-27, 20-28E

turnouts 20-45

peak-hour factors* (PHF) 9-8–9

bicycles 11-18

buses 14-11

freeway segments 13-12, 23-7

- peak-hour factors (PHF) (continued)
- multilane highways 12-10, 21-7
 - ramp-freeway junctions 13-25
 - roundabouts 10-34
 - signalized intersections 10-33
 - subhourly flow variations 8-9
 - transit facilities 14-4
 - two-lane highways 12-18, 20-7, 20-13
 - unsignalized intersections 10-19, 10-33
 - urban streets 10-8
- peak-hour volume** 8-6-9
- AADT and DDHV 8-11, 23-16-17
 - K-factors 8-9E, 8-11-12
 - transit trips 14-2E
- pedestrians*** 11-1, 18-1
- adjustment factor 16-11E, 16-13
 - computation 16-138E
 - formula 16-11E
 - procedure 16-135-139
 - bicycle interactions 11-16
 - shared facilities 18-6-7
 - body ellipse 11-4, 11-5E
 - capacity 11-4-5
 - circulation time 18-8, 18-11-12
 - clear walkway width 11-6
 - conflicts 11-7, 18-5
 - zones 6-135, 6-136E
 - cross-flows 11-7
 - determining 18-5
 - crosswalks
 - evaluating 11-4
 - lengths 11-13
 - street corners 18-8, 18-10E
 - time-space 18-12-13
 - zebra-striped 18-13
 - delays 11-13, 18-7
 - density 11-1
 - flow-density 11-2-3
 - speed-density 11-2
 - effective green time 18-13
 - effective walkway width 11-6, 11-12
 - determining 18-2-3
 - environmental factors 11-1
 - facility types 18-1
 - flow 2-1
 - flow-density relationships 11-2
 - flow rate 11-1, 11-10E
 - cross-flows 11-17
 - flow-speed relations 11-3
 - flow values (urban) 10-26
 - holding areas 18-8, 18-10-11
 - impedance 17-10, 17-11-12
 - input data and values 11-12-13
- pedestrians (continued)
- interrupted-flow facilities 18-7
 - signalized 18-7-18-13
 - unsignalized 18-13-15
 - levels of service (LOS) 18-1
 - criteria 11-7
 - cross flows 18-5E
 - queuing areas 11-10E, 18-6E
 - shared paths 18-7E
 - signalized intersections 18-8E
 - stairways 18-5E
 - unsignalized intersections 18-15E
 - urban streets 18-16E
 - walkways 11-9E, 18-4E
 - major-street crossing 18-8-10
 - methodology 18-1-15
 - applications 18-16
 - computations 18-16, 18-17-18
 - problems 18-19-31
 - worksheets 16-161, 18-32
 - minor-street crossing 18-8, 18-9
 - modeling application 31-16E
 - off-street paths 18-1
 - pedestrian space* 11-1
 - calculating 18-11-12
 - display convention 9-7
 - requirements 11-4, 11-5E
 - performance measures 11-7-8
 - platoons 11-1, 11-8, 11-11
 - calculation 11-13, 18-14
 - effects 18-4-5
 - numbers in 11-13
 - queuing areas 18-1
 - determining 18-5-6
 - LOS 11-10E
 - service volume table 11-14E
 - shared-use facilities 18-1, 18-6-7
 - sidewalks and walkways 18-1
 - analysis 18-3-4
 - lengths 11-12
 - LOS criteria 18-4
 - urban 18-15
 - widths 11-6, 11-12
 - signalized intersections
 - adjustment factor 16-11E, 16-13, 16-135-139
 - facilities 18-7-18-13
 - platoon size 11-13
 - turning movements 10-15
 - speed *see below* walking speed
 - speed-density relations 11-2
 - speed-flow relations 11-3
 - speed-space relations 11-4
 - stairways 18-5

- pedestrians (continued)
 - standing areas 11-4, 11-5E
 - start-up time 11-4, 11-13
 - street corners
 - areas 18-8, 18-9–10
 - radius 11-12
 - time-space 11-10–13
 - terminology 11-1
 - traffic characteristics 8-2
 - traffic control 11-1
 - pedestrian delay 11-13
 - trip purpose 11-6
 - TWSC intersections 17-4, 17-5
 - impedance 17-10, 17-11–12
 - types 11-6
 - uninterrupted-flow facilities 18-3–7
 - unsignalized intersections 1-13
 - facilities 18-13–15
 - urban street facilities 18-1
 - default flows 10-26
 - v/c ratios 18-4
 - vehicle-pedestrian interactions 17-11–12
 - waiting times 18-10–11
 - walking space *see above* pedestrian space
 - walking speed 11-1, 11-2, 11-4–5, 11-6E
 - determining 18-1
 - speed-density 11-2
 - speed-space 11-4
 - values 11-13
 - walkways *see above* sidewalks and walkways
 - worksheets 16-161, 18-32
 - performance measures*** 2-3, 28-1
 - accuracy and precision 9-2, 9-3
 - areawide analysis 30-2
 - congestion 30-38
 - highways 30-8–11
 - transit 30-13–14
 - average values 9-8
 - bicycle facilities 11-4–5
 - corridor analysis 29-7–9, 29-20
 - economic analyses and 3-7, 3-8E
 - environmental analyses and 3-6, 3-8E
 - freeways 13-29, 22-3, 22-18
 - models and 31-18
 - multiple facilities 28-1–3
 - pedestrian facilities 11-7–8
 - presentation of 4-3–4
 - roles and uses of 4-1–3
 - selection 4-3
 - transit facilities 14-23, 14-24E
 - person capacity***
 - buses 14-3, 14-4E
 - busways 14-14E
 - person capacity (continued)
 - buses
 - calculating 14-6
 - influences 14-5E
 - mixed-traffic 27-25
 - problem 27-42
 - urban bus lanes 27-20
 - rail transit 14-22E, 27-31–32
 - transit facilities 14-3, 14-4–5
 - calculating 14-6E
 - person delay (transit facilities)** 14-18
 - person flow** 2-2
 - see also* pedestrian flow
 - PHF *see* peak-hour factor
 - planning analysis** 3-6, 4-2
 - freeway segments (problems) 23-17
 - freeway weaving segments 24-20
 - problems 24-22
 - models 31-1
 - pedestrians (problem) 18-30
 - performance-based planning 28-2
 - ramps and ramp junctions
 - signalized intersections 16-26, 16-27E
 - problems 16-37, 16-79
 - platoons* and platoon analysis**
 - arrival types 15-5–6, 16-4–5
 - buses 14-11
 - gap distribution 7-9
 - interchanges 26-6–7
 - pedestrian 11-1, 11-8, 11-11
 - calculation 11-13
 - effects 18-4–5
 - platoon ratio* 15-6, 16-20
 - TWSC intersections 17-14–18
 - progression adjustment factor* (PF)** 15-6–7, 16-19–20
- Q**
- quality of service*** 2-2, 28-1
 - see also* LOS (levels of service); performance measures
 - multiple facilities 28-4–6
 - transit facilities 14-23, 14-24E
 - availability 14-30–31
 - comfort and convenience 14-31
 - factors 14-26–29
 - framework 14-29–31
 - measures 27-2
 - traveler perceptions 28-4–6
 - quantity of service*** 28-3
 - queue accumulation polygons (QAPs)** 16-23
 - application 16-106–107, 16-112–114
 - uniform delay 16-140–141
 - queues and queuing*** 7-11
 - see also* headway

queues and queuing (continued)

- back of queue* 10-16, 16-151
 - average 16-152–155
 - determining 16-151–158
 - percentile 16-155–156
 - queue storage rate* 16-156
 - worksheet 16-157E
- bicycles 19-7
- buses
 - bypass/jump 14-17, 14-18, 14-19E
 - formation 14-10
 - queue failure 27-11–12
- initial queue delay* 15-5, 16-22, 16-33
 - examples 16-145–148
 - method 16-142–150
 - multiple time periods 16-146
 - worksheet 16-150E
- interchange characteristics 26-5–6
- lengths 7-12
 - TWSC 10-31, 17-22–23
- pedestrians 18-1, 18-5–6
 - LOS 11-10E
- queue carryover* 16-7
- queue clearance* (TWSC) 17-14–15
- queue discharge flows*
 - freeways 13-3, 13-5
 - headways 8-27
- queue size 16-112–114, 16-140–141
- queue storage ratio* 16-156
- saturation conditions 13-5, 7-11–12
- service time 16-107–108

Rrail transit *see* light rail transit**ramp-freeway junctions** 13-21–22, 25-1*see also* ramps and ramp junctions**ramps and ramp junctions*** 13-20, 25-1*see also* interchange ramp terminals

acceleration and deceleration lanes

capacity 25-1

length 13-22, 13-24

analysis period 13-24

capacity 22-8

diverge 13-22, 25-14

merge 13-22, 25-7–8

components 13-20–21

corridor analysis 29-3–9

design analysis 25-20

diverge influence areas 13-21–23

analysis 25-11–17

capacity 13-22, 25-14

flow prediction 25-12–13

lane drops 25-16

ramps and ramp junctions (continued)

diverge influence areas

LOS 13-23–24, 25-4–5, 25-14–15

major diverges 25-16

off-ramp cases 25-15–17

weaving 13-13, 13-26

driver population factor 13-22, 13-25

entrance ramps *see below* on-rampsexit ramps *see below* off-ramps

free-flow speed (FFS) 13-22

values 13-24

freeway-to-freeway ramps 13-21

heavy vehicles 13-22, 13-25

input data and values 13-24–25

lane distribution 13-22

lane numbering 13-21

lateral clearances 13-22

levels of service (LOS) 13-23–24, 25-4–5

diverge areas 25-14–15

merge areas 25-8

merge influence areas 13-21–23

analysis 25-5–11

capacity 13-22, 25-7–8

flow prediction 25-5–7

lane additions 25-9

LOS 13-23–24, 25-4–5, 25-8

major merges 25-9–10

on-ramp cases 25-8–11

ramp control/meters 25-11

weaving 13-13, 13-26

methodology 25-1–19

applications 25-19–22

computational steps 25-20

flowchart 25-3E

problems 22-23–40

worksheet 25-40

modeling application 31-16E

off-ramps 13-21–22

capacity 25-4

left-hand 25-17

other 25-17

two-lane 25-4, 25-15–16

weaving 13-13

on-ramps 13-21–22

capacity 25-4

left-hand 25-11

other 25-10–11

two-lane 25-4, 25-8–9

weaving 13-13

operational analysis 25-20

problems 25-23

operational characteristics 13-21–22

parameters 13-22

peak-hour factor (PHF) 13-25

ramps and ramp junctions (continued)

- planning analysis 25-20
- ramp closure 13-28
- ramp-freeway junctions 13-20–21, 25-1
- ramp influence areas 25-1–3
 - capacity 13-23
 - diverge 13-21–23, 25-11–17
 - merge 13-21–23, 25-5–11
 - overlapping 25-17
 - speed 25-18–19
- ramp lanes 13-21–22
 - values 13-24
- ramp metering* 13-28, 22-3, 22-6
- ramp roadways* 25-3–4
- ramp-street junctions 13-20, 13-21
- ramp terminals 25-3
- ramp-weave 13-14, 13-15E
- service-volume table 13-25–26
- signalized intersections 25-2
- speed 25-18–19
- variables 25-2E, 25-3
- worksheet 25-40

recreational facilities and routes 8-6, 8-7, 8-8

recreational vehicles* (RVs)

- freeway segments 23-7–8
- freeways 13-12
- multilane highways 12-7, 12-10
 - adjustments 21-7–8
 - grades 21-10–12
- traffic condition impacts 2-4–5
- two-lane highways 12-7, 12-19
 - directional segments 20-13–14, 20-18–19
 - two-way segments 20-7–9

red time* 10-11, 10-12E

see also traffic signals

right lanes and turns

- adjustment factor 16-11E, 16-12
- bicycles 19-6
- buses 27-17–18
- exclusive lanes 10-18
- right turn on red (RTOR) 16-9, 16-12

right-of-ways

- bicycles 19-6
- TWSC intersections
 - gaps 7-8–9
 - ranking 10-27–28
 - stream priority 17-3–4

roadway conditions 2-4

see also exclusive turn lanes; lanes; lateral clearance; shoulders

roundabouts* 10-31, 17-45

- applications 17-48
- approach capacity 17-47E
- capacity model 17-46–48

roundabouts (continued)

- critical gap 17-46
- gap acceptance 7-9, 17-45
- geometry 10-32E
- headways 17-45
- input data and values 10-34
- methodology 17-45–48
- multilane limits 17-48
- volumes 10-33
- worksheets 17-103

RTOR (right turn on red) 16-9, 16-12

running speed* 7-3, 10-3

RVs *see* recreational vehicles

S

saturation* conditions (freeways)

- oversaturated conditions 13-3, 22-15
 - analytical procedure 22-52–55
 - flows 22-15–16, 22-50–1
 - mainline factors 22-16–17, 22-56–59
 - MOE computation 22-50–63
 - problems 22-23
 - ramp flows 22-17, 22-59–61
 - segment factors 22-18, 22-61–62
- undersaturated conditions 13-3, 22-14–15
 - MOE computation 22-49–50
 - problem 22-23

saturation flow rate*

- adjustment factors 16-10–13
- gaps and headway 7-9
- interchanges 26-9
- lost time and 7-8, 7-10–11
- signalized intersections 8-26–28, 10-15, 10-24
 - determining 16-9–13, 16-30, 16-31E
 - measurement 16-158–160
 - signal timing 16-99
 - values 10-24
- unsignalized intersections 8-28

service flow rates* 2-3

service measures* 2-3, 28-1

see also LOS (levels of service); quality of service
LOS and 4-3
uses 4-2–3

service volume* tables

- bicycle facilities 11-18–20
- freeway ramps 13-25–26
- freeway segments 13-13
- freeway weaving 13-20
- multilane highways 12-10, 12-11E
- pedestrian facilities 11-14E
- ramps and ramp junctions 13-25–26
- signalized intersections 10-26–27
- table preparation 9-7, 9-9, 9-11–12
- two-lane highways 12-19

- service-volume tables (continued)
 - TWSC intersections 17-12-13, 17-26, 17-31
 - unsignalized intersections 10-34-35
 - urban streets 10-9, 10-10
- shoulders***
 - bicycle lanes 19-4
 - two-lane highway use 20-45
 - turnouts 20-44-45
 - widths on highways
 - multilane
 - two-lane 12-13, 12-18, 20-5-6
- side streets *see* minor-street approaches
- sidewalks and walkways**
 - pedestrians 18-1
 - analysis 18-3-4
 - lengths 11-12
 - LOS criteria 11-9E, 18-4E
 - urban 18-15
 - walkways 11-6, 11-12
 - transit facilities 14-24E, 14-26, 14-27
- signals *see* traffic signals
- signs** 2-5, 7-8-9
 - see also* intersections, AWSC; intersections, TWSC
- simulation* and modeling** 31-1-3
 - alternatives analysis 31-24
 - examples 31-27, 31-29, 31-31
 - applications 31-16-24
 - calibration* and validation* 31-22
 - examples 31-27, 31-29, 31-31
 - data assembly and input 31-22, 31-23
 - examples 31-27, 31-29, 31-31
 - data availability 31-20-21
 - descriptive models* 31-5-6
 - descriptors 31-3
 - deterministic models* 31-4
 - exercises 31-10-14
 - ease of use 31-21
 - event-based models* 31-4
 - exercise 31-7
 - events 31-3
 - HCM assessment 31-9
 - examples 31-26, 31-28, 31-30
 - input parameters 31-3E
 - logic types 31-3-4
 - normative models* 31-5-6
 - numerical exercises 31-6-16
 - car following 31-14-16
 - gap acceptance 31-7-10
 - pretimed signal 31-10-12
 - toll booth 31-12-14
 - off-line models* 31-6
 - output analysis 31-23-24
 - examples 31-27, 31-29, 31-31
 - output parameters 31-3E
- simulation and modeling (continued)
 - performance measures in 31-18
 - problems 31-15-31
 - project scope 31-18
 - examples 31-26, 31-28, 31-30
 - randomness elements 31-4
 - real-time models* 31-6
 - resource requirements 31-21-22
 - selection of model 31-19-22
 - examples 31-26, 31-28, 31-30
 - state variables 31-3
 - stochastic models* 31-4
 - exercises 31-7-10, 31-12-16
 - time-based models* 31-4
 - exercise 31-14-16
 - traffic inputs to models 31-5
 - traffic simulation models 31-2-3
 - types of models 31-4-5
 - utility models 28-4
 - vehicle simulation models 31-3
 - exercise 31-14-16
- skip-stop bus service*** 14-11, 27-13
 - example 14-15, 14-16E
 - problems 27-41, 27-43
 - speed adjustment 27-22-23
 - urban bus lanes 27-18-19
- space mean speed*** 7-3
- spacing between vehicles *see* gaps; headway
- speed*** 7-2-4, 7-9, 8-21-23
 - bicycles 11-18, 19-3E, 19-5, 19-7E
 - buses 27-8
 - busways 27-14, 27-16
 - HOV lanes 27-15E, 27-16
 - mixed-traffic 27-26
 - problem 27-43
 - skip-stop 27-22-23
 - urban bus lanes 27-20-24
 - density-speed relations 7-5-6
 - freeway segments 13-3-4
 - multilane highways 12-3, 12-4E
 - flow-speed relations 7-5-6
 - bicycles 19-5
 - freeway segments 13-3-4, 23-4E
 - multilane highways 12-3, 12-4E
 - signalized intersections 15-9-12
 - two-lane highways 12-14
 - urban streets 15-9-12
 - free-flow speed (FFS) 7-3
 - freeway segments 23-4-7
 - freeways 13-2, 13-5-6, 13-12
 - multilane highways 12-2-7, 12-10
 - ramps and ramp junctions 13-22, 13-23
 - two-lane highways 12-14, 12-18
 - urban streets 10-3, 10-7-8

- speed (continued)
 - freeway weaving segments 24-5-8
 - freeways 13-6, 22-15
 - interrupted flow 7-9
 - as LOS measure 2-2
 - multilane highways 12-3, 12-6-7
 - parameters 7-3
 - pedestrians 11-1, 11-2, 11-6E
 - determining 18-1
 - factors 11-4-5
 - ramps and ramp junctions 25-18-19
 - running speed* 10-3
 - space-speed relations 11-4
 - speed limits (highways) 12-6-7
 - travel speed* 7-2, 7-3
 - urban 10-4
 - trends 8-21-23
 - two-lane highways 12-12, 20-9-10
 - directional 20-20-21
 - grade adjustment 20-7
 - no-passing 20-9, 20-10E
 - two-way 20-5, 20-10E
 - types 7-3
 - uninterrupted flow 7-2-4
 - urban streets 10-3-4
 - FFS 10-7-8
 - sensitivities 15-9-12
 - value conventions for 9-7
 - variations per volume 8-21, 8-23, 8-24E, 8-25E
 - speed limits**
 - multilane highways 12-6-7
 - urban streets 10-6
 - start-up lost time*** 8-26, 8-28, 10-12-13
 - see also* lost time
 - stop signs** 2-5, 7-8-9
 - see also* intersections, AWSC; intersections, TWSC
 - streetcars*** 14-19-20, 27-26
 - capacities 27-31-32
 - dwelt time 27-26-28
 - minimum headways 27-28-30
 - travel times 14-20, 14-22E
 - volumes 8-29
 - peak 27-27
 - streets *see* sidewalks and walkways; urban streets
 - suburban streets*** 10-6E, 10-7
 - symbols *see* Chapter 6
 - system analysis** 3-2-4
- T**
- terrain *see* grades and terrain
 - time mean speed*** 7-3
 - time-spent-following** 12-13, 12-14E, 12-15E
 - determining 20-9-10
 - directional distribution 20-9, 20-11E
 - time-spent-following (continued)
 - directional segments 20-22, 20-23-24
 - two-way segments 20-9-10
 - toll booth** (modeling example) 31-12-14
 - toll roads** 13-1
 - topography *see* grades and terrain
 - traffic-actuated signal controls *see* traffic signals
 - traffic characteristics**
 - demand and volume 8-2-13
 - values (measured and observed) 8-13-29
 - vehicle and human factors 8-1-2
 - traffic conditions*** 2-4-5
 - see also* directional distribution and split
 - signalized intersections 16-3-5
 - traffic control systems *see* traffic signal phasing; traffic signals
 - traffic signal phasing** 10-14-15, 10-22
 - see also* traffic signals
 - critical lanes 16-16E, 16-7E
 - interchanges 26-7, 26-12-14
 - leading/lagging 16-95E, 16-96-97, 16-128-131
 - multiphase 16-18E, 16-96-98, 16-112-120
 - overlapping phases 16-15
 - parameters 6-104-105
 - permitted 16-23, 16-122-134
 - phase plans 10-43-44, 16-95
 - pretimed signal controls 10-14, 16-94
 - k-values 16-22E
 - timing plan 16-98-100
 - protected 10-22, 16-16E
 - protected-plus-permitted 16-23-24, 16-128
 - procedure 16-140-143
 - two-phase 16-96E, 16-100, 16-109-110
 - types 16-13
 - traffic signals**
 - see also* traffic signal phasing
 - actuated signal controls 10-14, 16-94-95
 - control delay *see* control delay
 - controllers 16-94-95
 - settings 16-105-106
 - cycle failure 10-16
 - cycle length 10-12E, 10-19, 10-21-22
 - estimation 10-45
 - effective green 10-11-13
 - ratios 10-19, 10-23
 - effective red 10-11, 10-12E
 - freeways 13-28
 - fully actuated 10-14
 - green extension time 16-108
 - green phasing 16-95E, 16-96-97
 - green time 10-11-13
 - allocation 16-98
 - estimation 10-45-46
 - computation 16-108

- traffic signals (continued)
- green time
 - model 16-106–107
 - signal timing 16-100
 - ratio (g/C) 10-12E, 10-19, 10-23, 16-25
 - interrupted-flow facilities 2-5
 - lagging/leading green phasing 16-95E, 16-96–97, 16-128–131
 - light-rail trains 14-22
 - multilane highways 12-1
 - multiphase control 16-96–98, 16-112–120
 - critical lanes 16-18E
 - pedestrians 11-1
 - delay 11-13
 - permitted phasing 16-23
 - left turns 16-122–134
 - phase control plans 10-43–44, 16-95–98
 - dual-ring 16-96E, 16-97, 16-103–104
 - multiphase 16-96–98, 16-112–120
 - two-phase 16-96E, 16-100, 16-109–110
 - pretimed signal controls 10-14, 16-94
 - k-values 16-22E
 - modeling example 31-10–12
 - timing plan 16-98–100
 - protected phasing 10-15, 10-22, 16-16E
 - protected-plus-permitted phasing 16-23–24, 16-128
 - procedure 16-140–143
 - rail transit priorities 14-22
 - red time 10-11, 10-12E
 - semiactuated signals 10-14
 - signal controls 16-94–95
 - flow rate and 7-7–8
 - fully actuated 10-14
 - semiactuated 10-14
 - traffic-actuated 16-101–120
 - signal controllers 16-94–95
 - k-values 15-8E, 16-22E
 - settings 16-105–106
 - signal coordination 15-9
 - signal delay *see* control delay
 - signal density (urban) 10-8
 - speed and 15-9–12
 - signal phasing 10-14–15
 - signal progression 15-6–7, 16-19–20
 - signal timing
 - design method 16-93–120
 - estimation 10-43–46, 16-99–101
 - estimation limits 16-120–121
 - example 16-116–120
 - interchanges 26-7
 - left-turn flows 10-37, 10-42
 - lost time 16-101
 - phase plans 16-95–98
 - pretimed 16-98–101
- traffic signals (continued)
- signal timing
 - semiactuated 16-115–116
 - timing plans 16-98–112
 - traffic-actuated 16-101–115
 - signalization conditions 16-3E, 16-5–6
 - timing plans
 - minimum phase time 16-111
 - pretimed 16-98–100
 - problem 31-26–27
 - traffic-actuated 16-102–115
 - traffic-actuated controls 16-94–95
 - control settings 16-105–106
 - estimation limits 16-120–121
 - model 16-101–104
 - multiphase example 16-116–120
 - timing computations 16-115E
 - timing plan 16-101–115
 - worksheet 16-103
 - two-phase control 16-96, 16-100, 16-109–110
 - types 10-14
 - upstream signal effects (TWSC) 17-13–19
 - computing 17-30
 - traffic signs** 2-5, 7-8–9
 - see also* intersections, AWSC; intersections, TWSC
 - transit facilities** 14-1–3, 27-1–2
 - see also* areawide analysis; buses and bus facilities; corridor analysis; light rail transit; street cars
 - accessibility* to stops 14-10, 27-4–5
 - amenities 14-27, 27-6–7
 - areawide analysis 30-11–16
 - problems 30-23–26
 - availability *see below* transit availability
 - automobiles
 - accessibility 27-4–5
 - travel time 14-31, 27-3
 - bicycles 14-6, 14-27
 - accessibility 27-4–5
 - bus facilities 14-3, 14-7–18
 - bus priorities 14-15–19
 - parameters 27-9–26
 - signal timing 14-11
 - capacity 14-3–6
 - estimation 27-1
 - comfort and convenience 14-24E, 14-26, 14-31
 - measures 27-6–8
 - perceptions 14-29
 - corridor analysis 29-10–12
 - problem 29-12–26
 - costs to passengers 14-28
 - delays *see below* dwell time
 - dwell time 14-3, 14-5–6
 - variability 14-8
 - fare payment 14-6

transit facilities (continued)

- GIS analysis 30-14-16
- headway adherence 27-3, 27-7, 27-8
- hours of service 14-24E
 - determining 27-5-6
- intercity scheduled service 27-3, 27-4
- level of service (LOS) 14-23
 - hours of service 27-6E
 - intercity transit 27-4E
 - paratransit 27-4E
 - passenger load 27-6E
 - reliability 27-8E
 - service frequency 27-2
- light rail 14-3, 14-19-22
 - parameters 27-26-31
 - priority treatments 14-22
- loading areas 14-3
- modeling application 31-16E
- operator point of view 14-23, 14-24E
- paratransit 27-3-4
- park-and-ride lots 14-24E, 14-27
- passenger demand 14-4
 - dwelt time 14-6
- passenger loads 14-24E, 14-29, 14-31
 - determining 27-5
- passenger perceptions
 - appearance and comfort 14-29
 - point of view 14-23, 14-24E
 - safety and security 14-28
- peak-hour factor (PHF) 14-4
- peak-hour trips 14-2E
- pedestrians 14-26, 14-27
 - accessibility 27-4-5
- performance measures 14-23, 14-24E
 - areawide 30-13-14
 - corridor 29-10-12
- person capacity 14-3, 14-4-5
 - calculating 14-6E
- priority treatments
 - buses 14-15-19
 - rail 14-22
- quality of service 14-23, 14-24E
 - availability 14-30-31
 - comfort and convenience 14-31
 - factors 14-26-29
 - framework 14-29-31
 - measures 27-2
 - trip decision making 14-23, 14-25
- rail transit 14-3, 14-19-22
 - parameters 27-26-31
 - priority treatments 14-22
- reliability *see below* transit reliability
- routes and route segments
 - availability 14-30

transit facilities (continued)

- routes and route segments
 - comfort and convenience 14-31
 - hours of service 27-5
 - reliability 27-7-8
- safety and security 14-28
- scheduling 14-27
- seating availability 14-29
- service coverage 14-25E, 14-26-27
 - areawide analysis 30-13-16
 - availability 14-30-31
- service frequency 14-24E, 14-30
 - determining 27-2-4
 - LOS 27-3E
- service information 14-25E, 14-28
- service measures 14-23
 - quality-of-service 14-30E
 - threshold levels 14-31
- sidewalk conditions 14-24E, 14-26, 14-27
- speed 14-24E, 27-8
 - areawide 30-12
 - corridor 29-11
- streetcars 14-3, 14-20, 14-22E
 - parameters 27-26-31
- transit availability* 14-25E, 14-26
 - measures 27-2-5
- transit reliability* 14-24E, 14-29, 14-31
 - determining 27-7-8
- transit stations 14-3
 - amenities 14-27
 - spacing 14-6
- transit stops* 14-3
 - accessibility 27-4
 - amenities 14-6, 27-6-7
 - availability 14-30
 - comfort and convenience 14-31
 - passenger loads 27-6
 - service frequency 27-2
 - spacing 14-6
- travel time 14-31, 29-11-12
- trip decision making 14-23-24, 14-25E, 14-26E
- trip times 14-28
- trolleybuses 14-2
- unscheduled service 27-3-4
- urban scheduled service 27-3
- vehicle capacity 14-3, 14-24E
 - calculating 14-5E
- vehicle operation 14-23, 14-24E
- waiting areas *see above* transit stations; transit stops
- wheelchair accessibility 14-6

- transportation facilities** 3-1E, 3-3E, 9-1–2
see also bicycles; freeways; highways; interrupted-flow facilities; intersections; multiple facility assessment; pedestrians; transit facilities; uninterrupted-flow facilities; urban streets
- travel speed*** 7-2, 7-3, 10-4
see also speed
- traveler satisfaction* and utility** 28-1, 28-4–5
- trolleybuses*** 14-2
- trucks***
 freeways 13-12
 freeway segments 23-7–8
 multilane highways 12-7
 adjustments 21-7–8
 grades 21-10–12
 registered (1986–1996) 8-14E
 values 12-10
 rural interstate travel by 8-15E
 traffic condition impacts 2-4–5
 two-lane highways 12-7, 12-19
 directional segments 20-13–14, 20-17–20
 two-way segments 20-7–9
 volume variations (daily) 8-5E
 weight/power ratios 8-1E
- turning movements** 10-1, 10-15
 estimation 10-19–20
 values 10-19, 10-33
 interchanges 26-1, 26-3–4
- turnouts*** 20-44–45
- two-lane highways *see* highways, two-lane
- two-way left-turn lanes* (TWLTL)** 12-1
 gap acceptance 10-29
 two-lane highways 20-47–48
- TWSC (two-way stop-controlled) intersections *see* intersections, TWSC
- U**
- undersaturated conditions (freeways)** 13-3, 22-14–15
 MOE computation 22-49–50
 problem 22-23
- uninterrupted-flow facilities** 2-1,
see also freeways; highways
 density 7-4
 flow rate 7-1–2
 headway and spacing 7-4–5
 parameter relationships 7-5–6
 parameters for 7-1–6
 spacing and headway 7-4–5
 speed 7-2–4
- upgrades**
see also grades and terrain
 climbing lanes 20-28–29
 freeway segments 23-9–11
 multilane highways 21-9, 21-10E
- upgrades (continued)
 two-lane highways 20-14, 20-15–19
- urban streets** 10-1–2, 15-1
see also interchange ramp terminals; intersections; pedestrians; urban bus facilities
 analysis period 10-8–9
 analytical example 3-3E, 3-4E
 arrival types 10-23, 15-5–6
 arterials 10-1, 10-6–7
 AWSC intersections 10-30–31
 back of queue 10-16
 bicycles 10-25, 19-1, 19-7
 buses (local) 10-25
 bus facilities 27-16
 adjacent lanes 27-19E, 27-20
 lane speed 27-20–24
 person capacity 27-20
 vehicle capacity 27-17–19
 busways (CBD) 14-13–14
 capacity 27-14–16
 reserved 14-18
 volumes 8-28
 capacity 15-9
 estimation 10-36–47
 classification system 10-5–7, 10-8E
 classifications 10-1–3
 collector streets 10-1
 control delay 10-15–16, 15-2
 computation 10-46–47
 determination 15-3–8
 corridor analysis 29-3–9
 cycle length 10-19, 10-21–22, 15-9
 estimation 10-45
 design categories 10-6E, 10-7
 effective green 10-11–13
 ratios 10-19, 10-23
 exclusive turn lanes 10-17–18
 free-flow speeds (FFS) 10-3
 speed-flow curves 15-9–12
 values 10-7–8, 15-3E
 functional classes 10-1
 green time estimation 10-45–46
 green time ratio (g/C) 10-19, 10-23
 heavy vehicle factors 10-25
 highways compared 10-11
 incremental delay 15-4, 15-5, 15-7–8
 input data and values 10-7–9
 signalized intersections 10-17–27
 unsignalized intersections 10-32–34
 lengths 10-7, 15-13
 level of service (LOS) 10-4–5
 applications 15-5
 computations 15-13
 control delay 10-15–16

- urban streets (continued)
 - level of service (LOS)
 - determining 15-2-3, 15-9, 15-27-28
 - methodology 15-1-3
 - pedestrians 18-16E
 - problems 15-15-24
 - local streets 10-1
 - methodology 15-1-12
 - applications 15-12-15
 - flow chart 15-2E
 - input parameters 10-7-9
 - problems 15-15-24
 - worksheets 10-47, 15-28
 - peak-hour factor (PHF) 10-8
 - pedestrians 11-1, 18-1
 - default flows 10-26
 - street corners 11-10-13, 18-8, 18-9-10
 - planning applications 15-15
 - computations 15-25-26
 - platoon ratio 15-6
 - progression adjustment factor (PF) 15-6-7
 - queue delay (initial) 15-5
 - determining 16-22, 16-142-148
 - roundabouts 10-31
 - running time 10-3
 - determining 15-3, 15-4E
 - segments 15-13
 - service volume table 10-9, 10-10
 - signal coordination 15-9
 - signal density 10-8
 - speed and 15-9-12
 - signal progression 15-6-7
 - signalized intersections 10-9-27
 - estimation method 10-36-46
 - flow 10-9, 10-11
 - LOS 10-15-17
 - values 10-17-27
 - variables 10-12E
 - speed-flow curves 15-9-12
 - speed profiles 10-4
 - speeds 10-3-4
 - street classes 10-5-7, 10-8E
 - determining 15-3, 15-4E
 - speed and 15-9-12
 - street corners
 - areas 18-8, 18-9-10
 - radius 11-12
 - time-space 11-10-13
 - transit facilities
 - busways 14-13-14, 27-14-16
 - scheduled service 27-3
 - travel speed 10-4
 - sensitivities 15-9-12
 - urban streets (continued)
 - travel time 15-27-28
 - TWSC intersections 10-27-29
 - uniform delay 15-4, 15-5
 - unsignalized intersections 10-27-35
 - values 10-32-35
 - upstream signals 15-8
 - variables 10-12E
 - volumes 8-21, 8-22E
 - weaving 13-14
 - worksheets 10-47, 15-28
 - utility* and traveler perception** 28-1, 28-4-5
- V**
- variability* of congestion** 28-3
 - highway facilities 29-9, 30-11
 - transit facilities 30-13
 - v/c *see* volume-to-capacity ratios
 - vehicle capacity***
 - buses 14-3, 14-4E, 14-5
 - bus stops 14-13
 - busways 14-14E
 - dwelt time 14-14-15
 - influences 14-12E
 - loading areas 14-7-11
 - mixed-traffic 27-25
 - urban bus lanes 27-17-19
 - transit facilities 14-3, 14-24E
 - calculating 14-5E
 - vehicle types** 8-1
 - see also* automobiles; buses; recreational vehicles; trucks
 - lane distribution by 8-13E
 - rural interstate travel by 8-15E
 - vertical alignments of roadways *see* grades and terrain
 - volume*** 8-13-16, 8-17E
 - see also* service-volume tables
 - analysis hour and peak hour 8-7
 - average values 9-8
 - buses 8-28-29, 14-10
 - daily-hourly equivalencies 9-8-9
 - demand and volume 2-2, 8-2
 - directional distribution 8-11, 8-12E
 - equivalency factors 9-8-9
 - flow rate and volume 7-1-2, 8-16
 - forecasts 8-9
 - freeways 8-3, 8-17, 8-18-20
 - lane distribution 8-12-13
 - multilane highways 8-17, 8-20E
 - peak-hour volume 8-6-9
 - rail transit 8-29, 27-7
 - signalized intersections 10-33, 16-3-5
 - adjustment 16-30, 16-31E
 - spatial distributions 8-10-13

volume (continued)

- speed relationships 8-21, 8-23, 8-24E, 8-25E
- temporal distributions 8-9–10
- two-lane highways 8-20–21
- variations
 - daily 8-4, 8-5E
 - hourly 8-4, 8-6, 8-7E
 - seasonal and monthly 8-3–4
 - subhourly 8-9, 8-10E

volume-to-capacity (v/c) ratios*

- freeways 13-29
- pedestrians 18-4
- signalized intersections 10-16, 16-14
 - application 15-9–12
 - computation 10-46
 - critical lanes 16-14–15
 - equalizing 16-98
- two-lane highways 20-11–12
- value conventions for 9-7

W

- walkways *see* pedestrians; sidewalks
- weaving* and weaving segments* *see* freeway weaving
- wheelchair accessibility**
 - buses 27-10
 - rail transit 27-28
 - transit facilities 14-6

Y

- yield signs** 2-5, 7-8–9
 - see also* intersections, AWSC; intersections, TWSC

* Defined in Chapter 5, "Glossary."