





**west 8 | borneo sporenburg  
amsterdam, the netherlands, 1993-96**





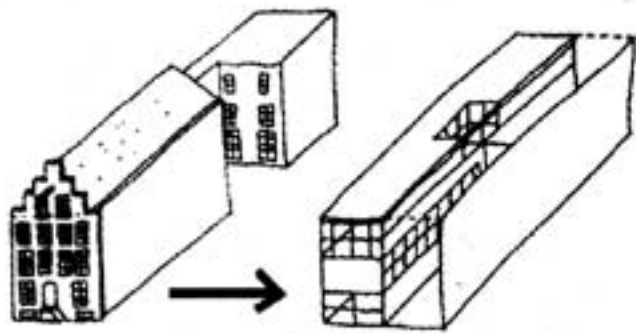

canal house

patio block

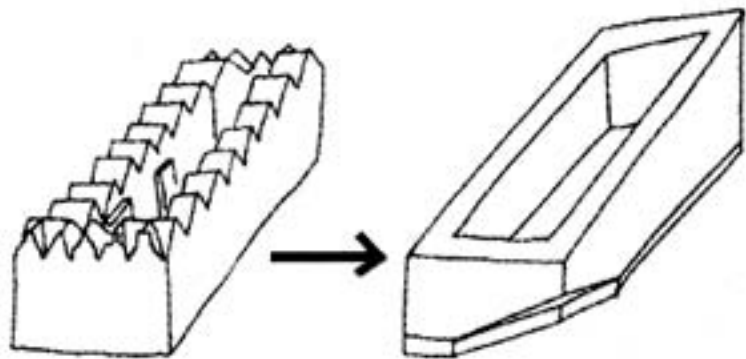

19th century  
city block

sculptural  
cityblock

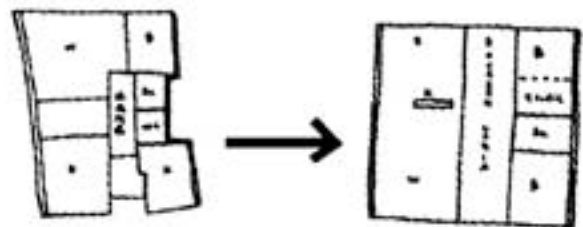

hall

winter garden/  
sun patio

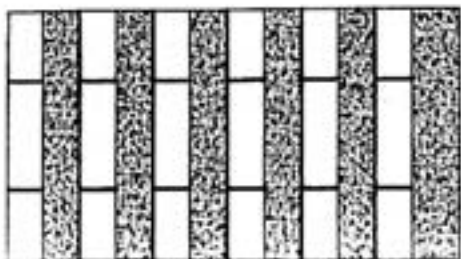

Wall house

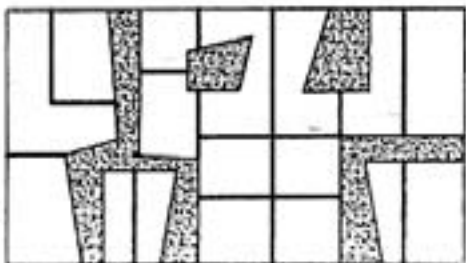

Emmenthal cheese

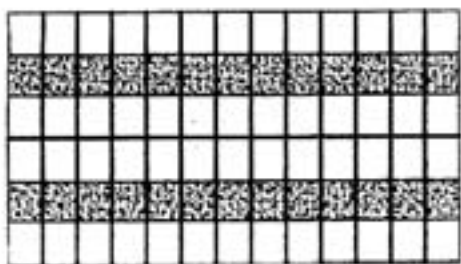

Drive-in

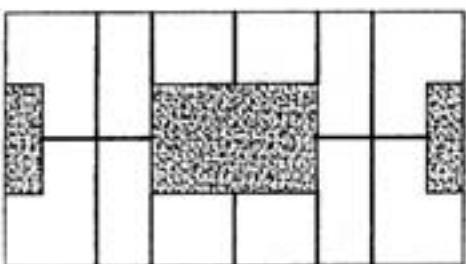

Court

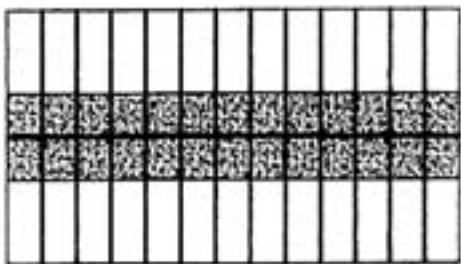

Void

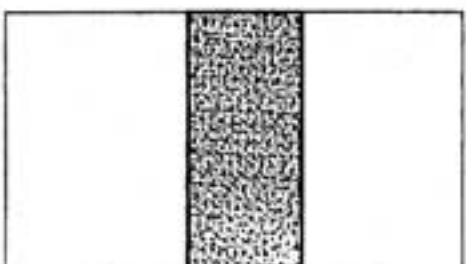

Big garden

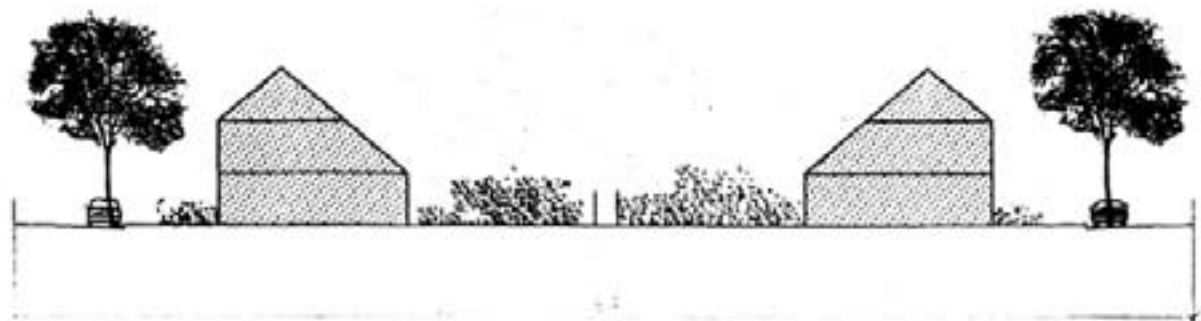

28-40 houses /Ha

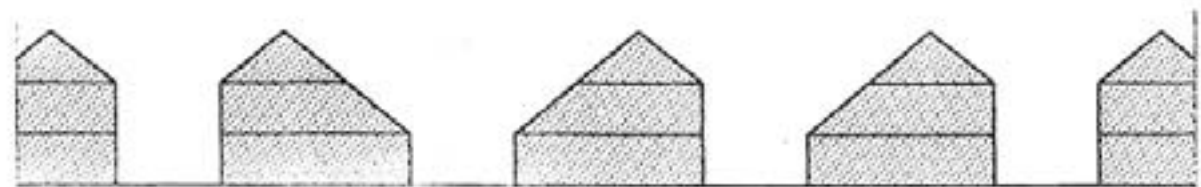

100 houses /Ha

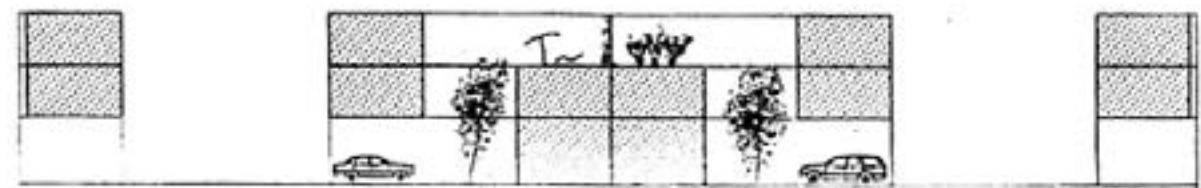

Borneo Sporenburg. 100 houses /Ha

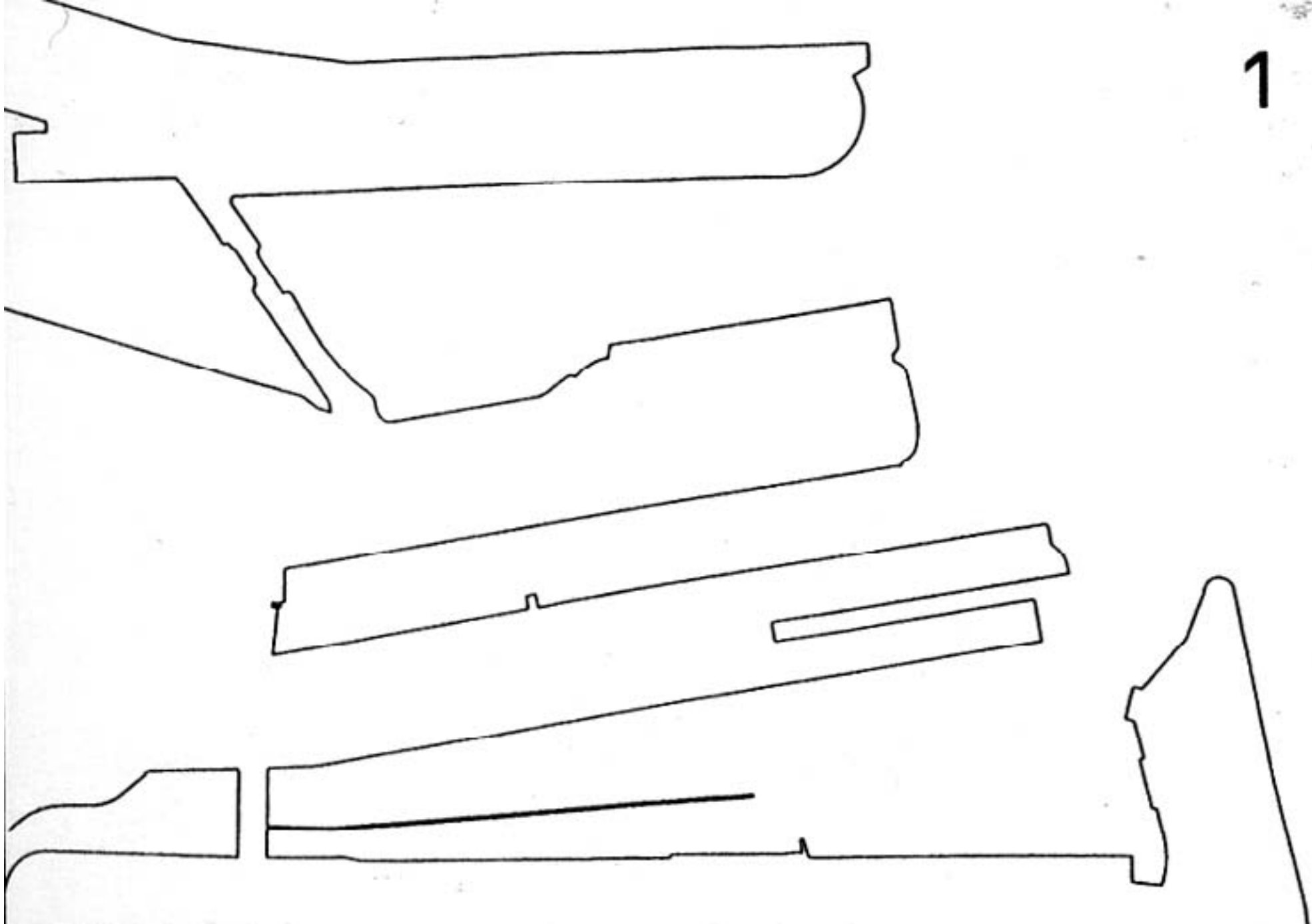



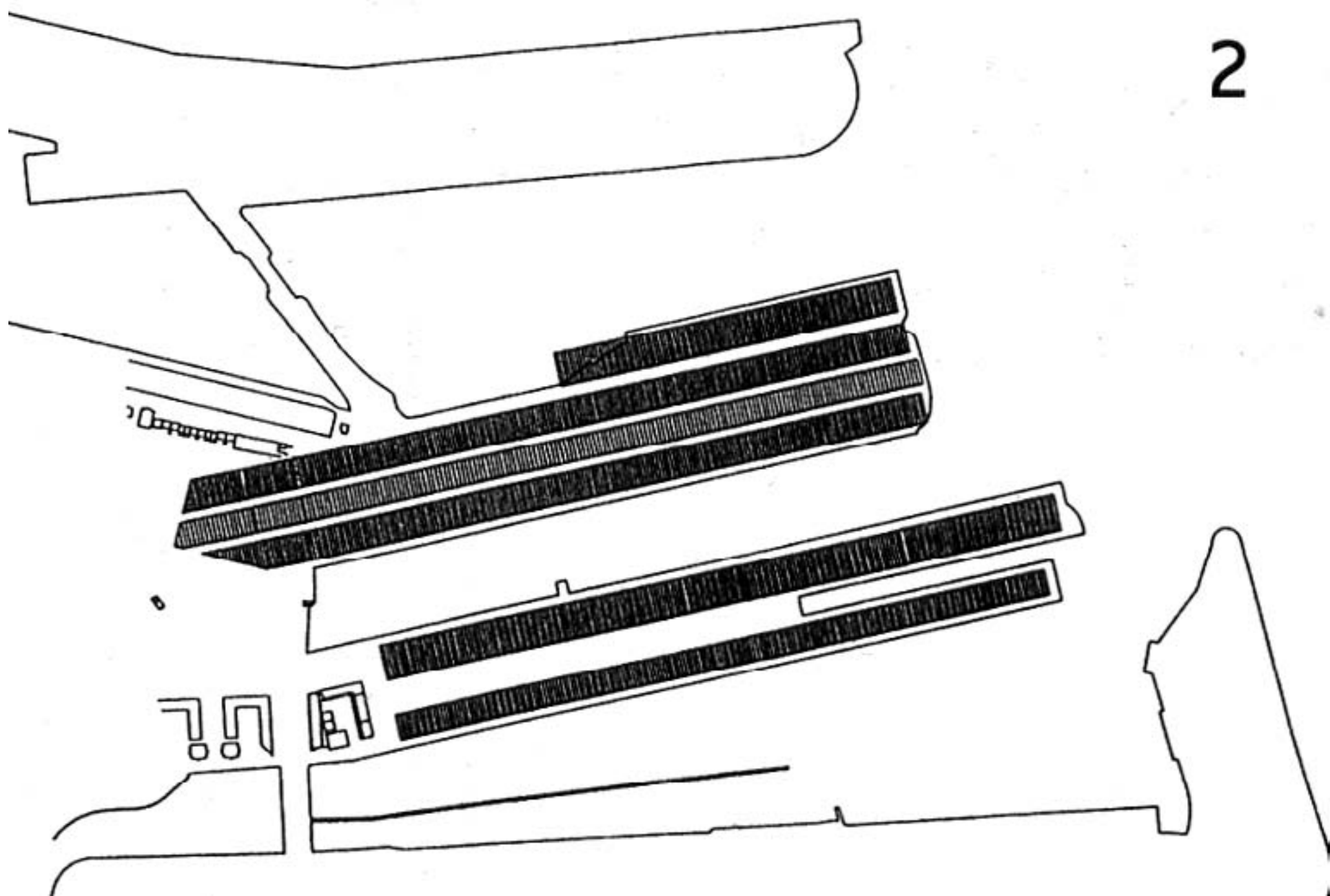

3

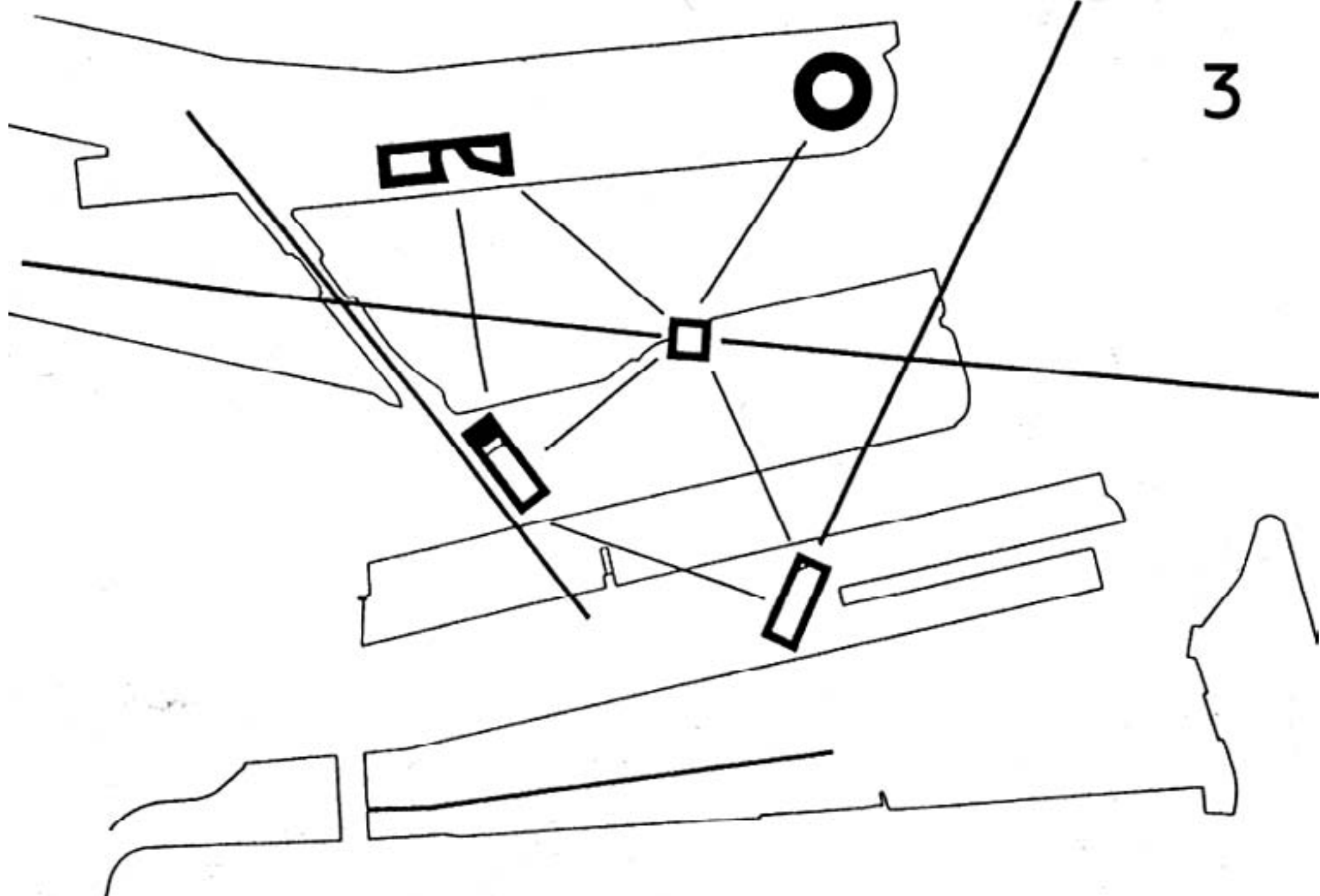

4

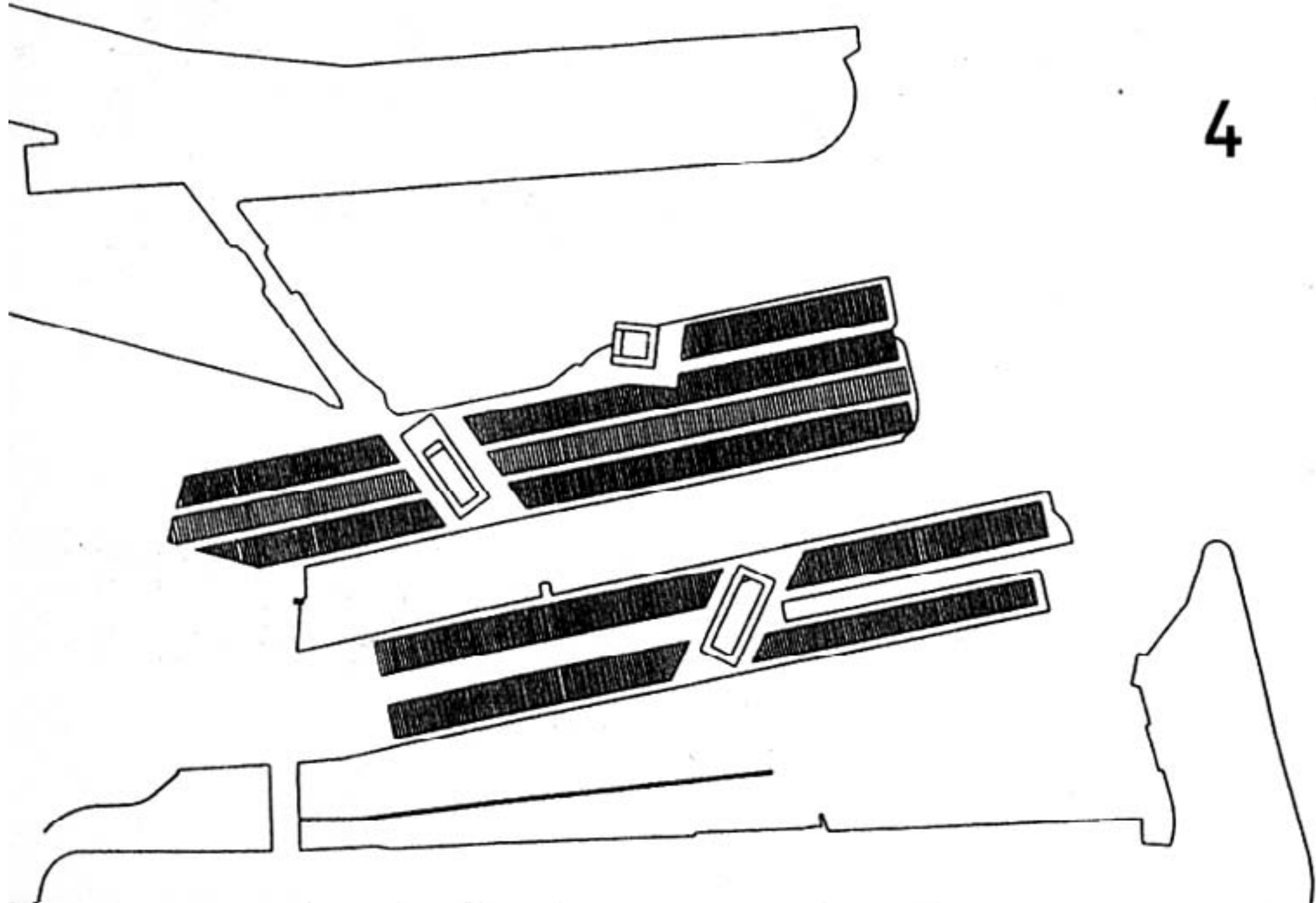

5

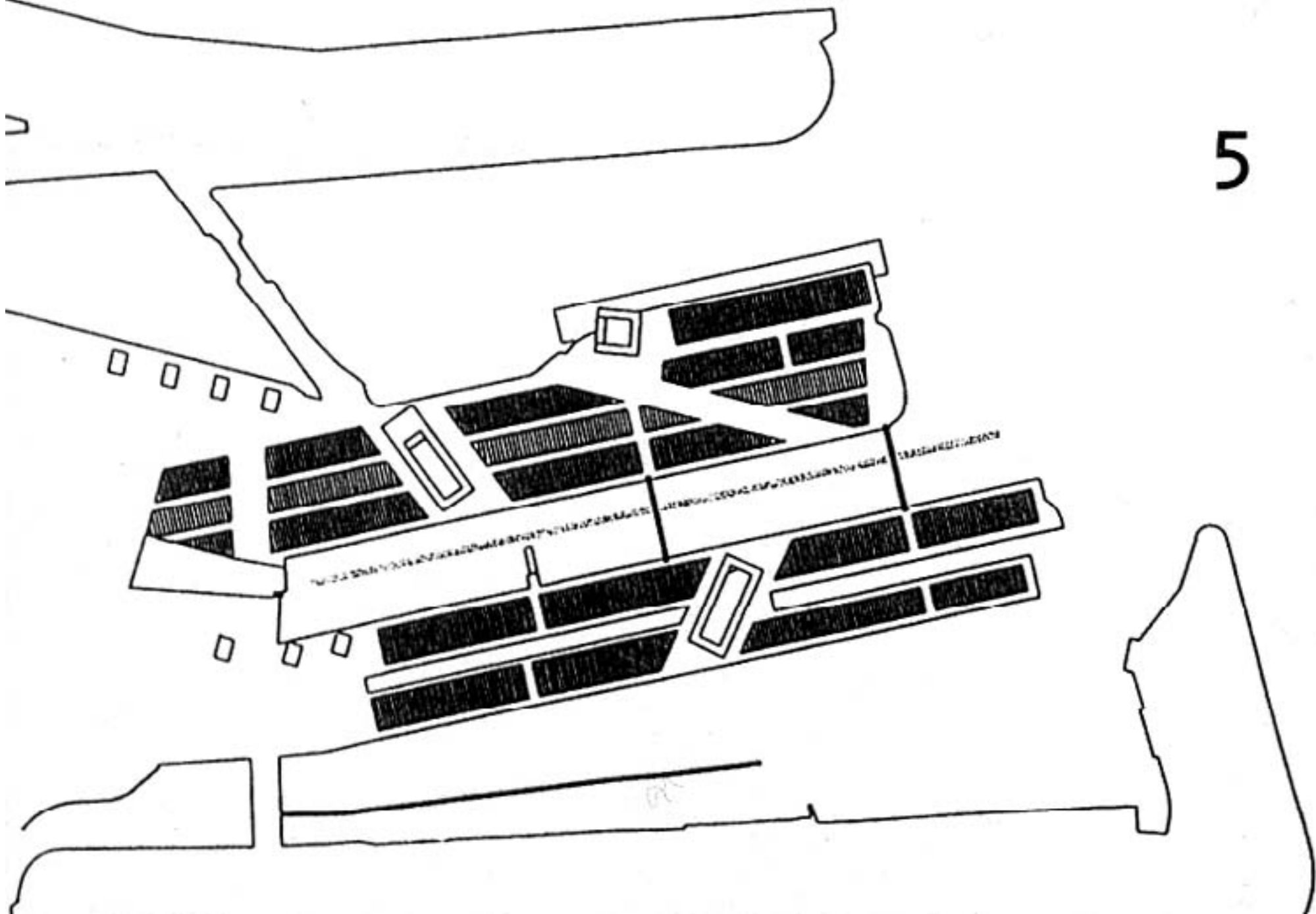

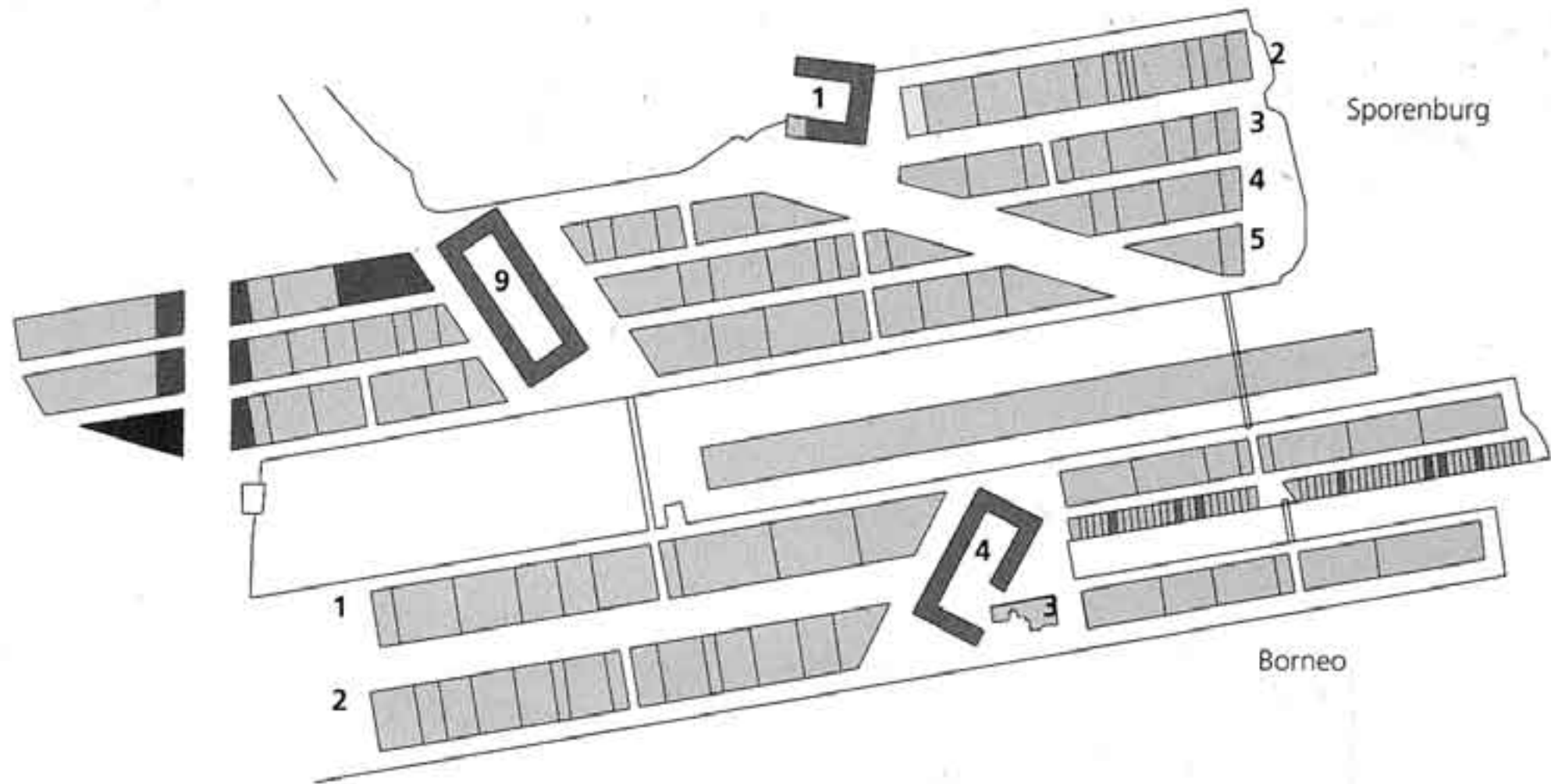

Sporenburg

Borneo



programma

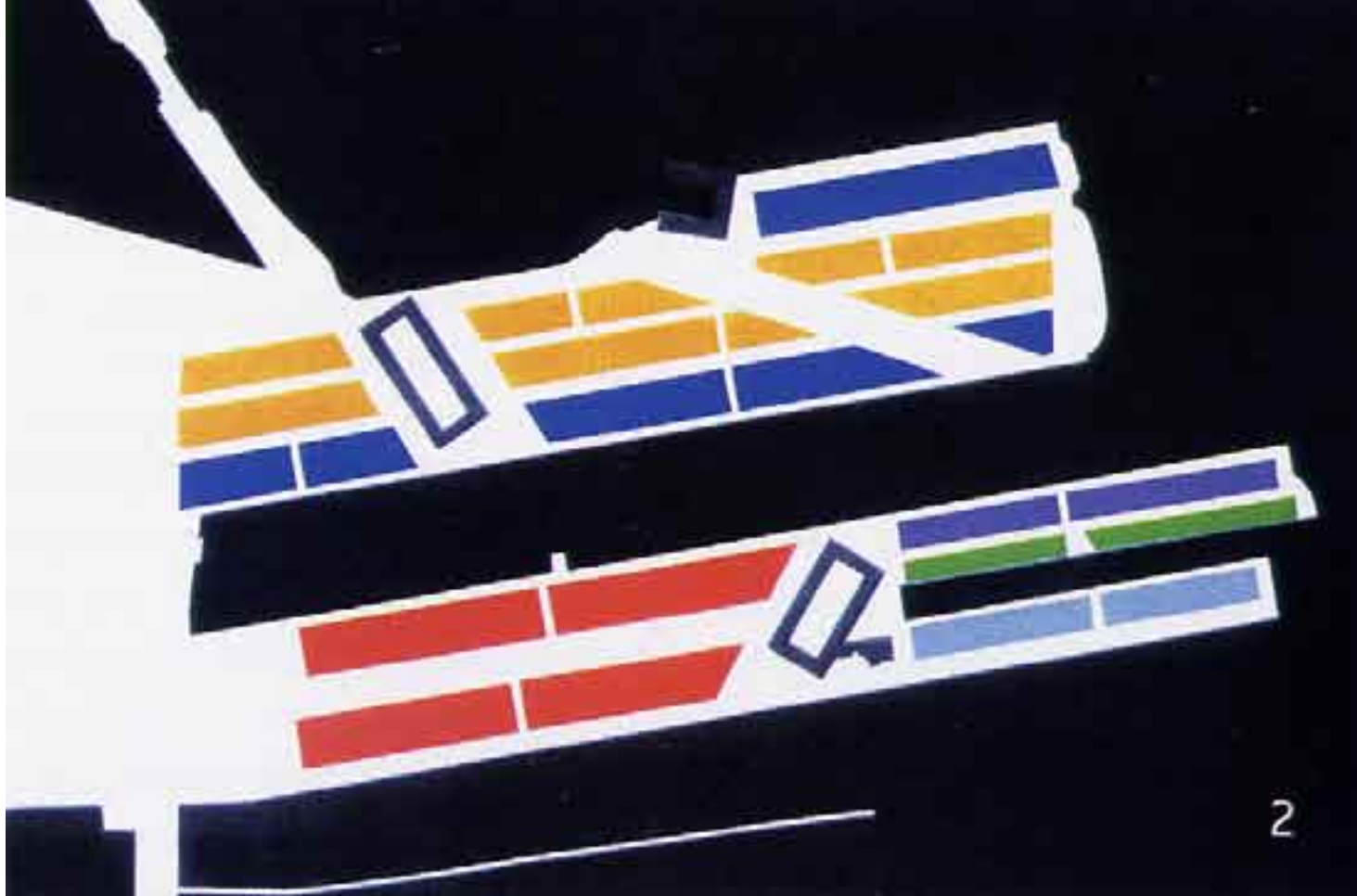

larghezza dei lotti

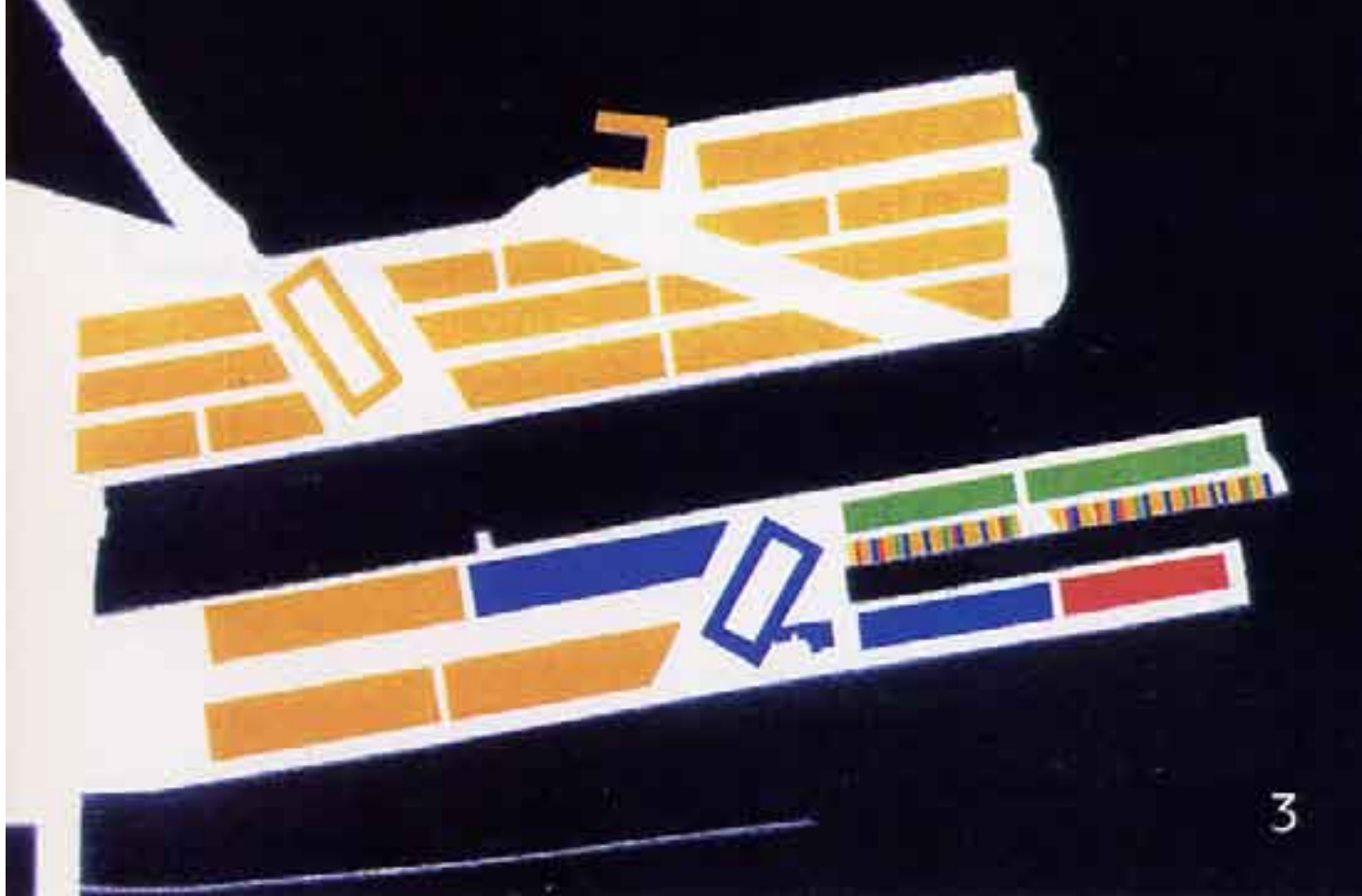

clienti





stili di vita

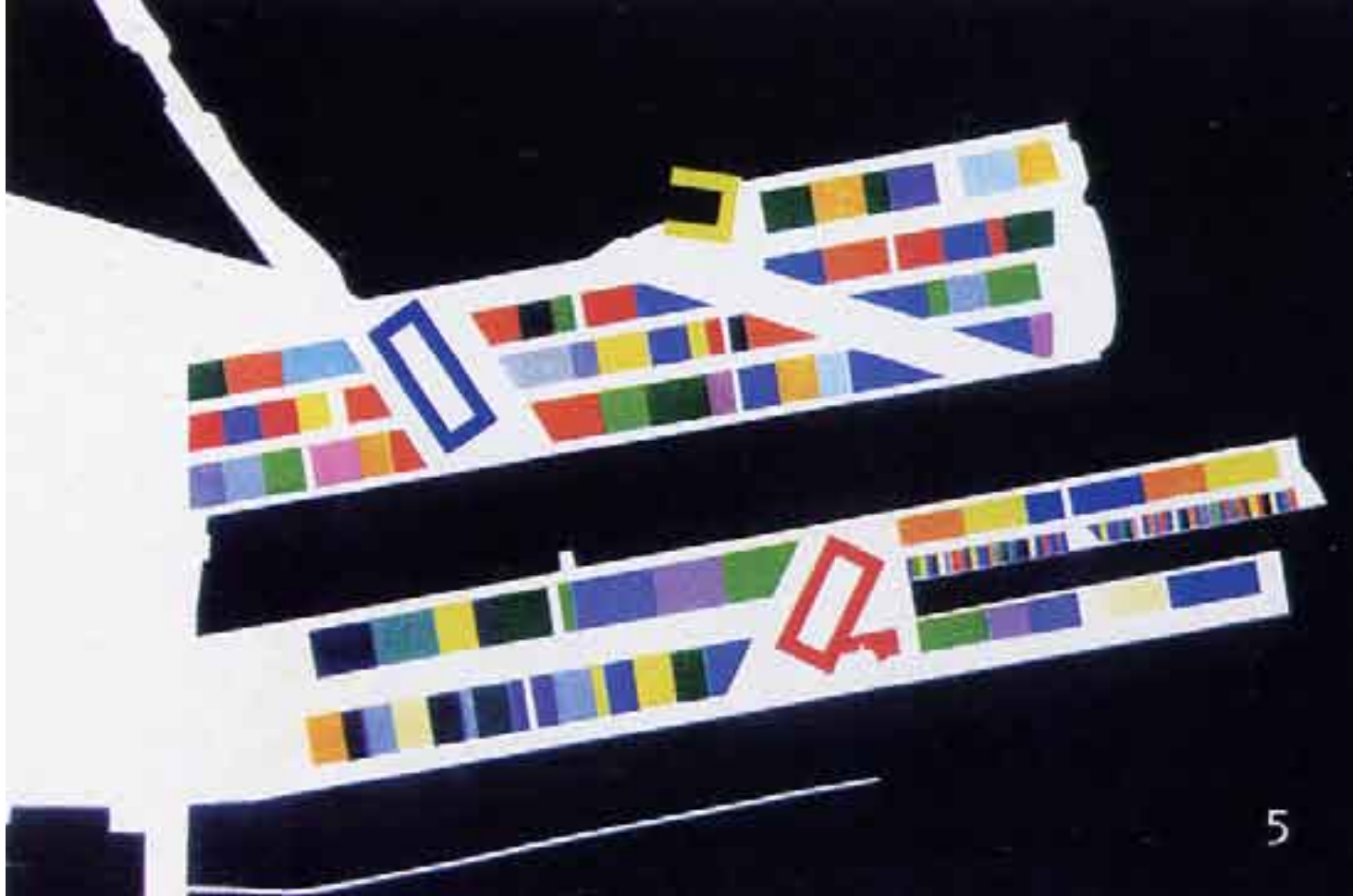

5

progettisti



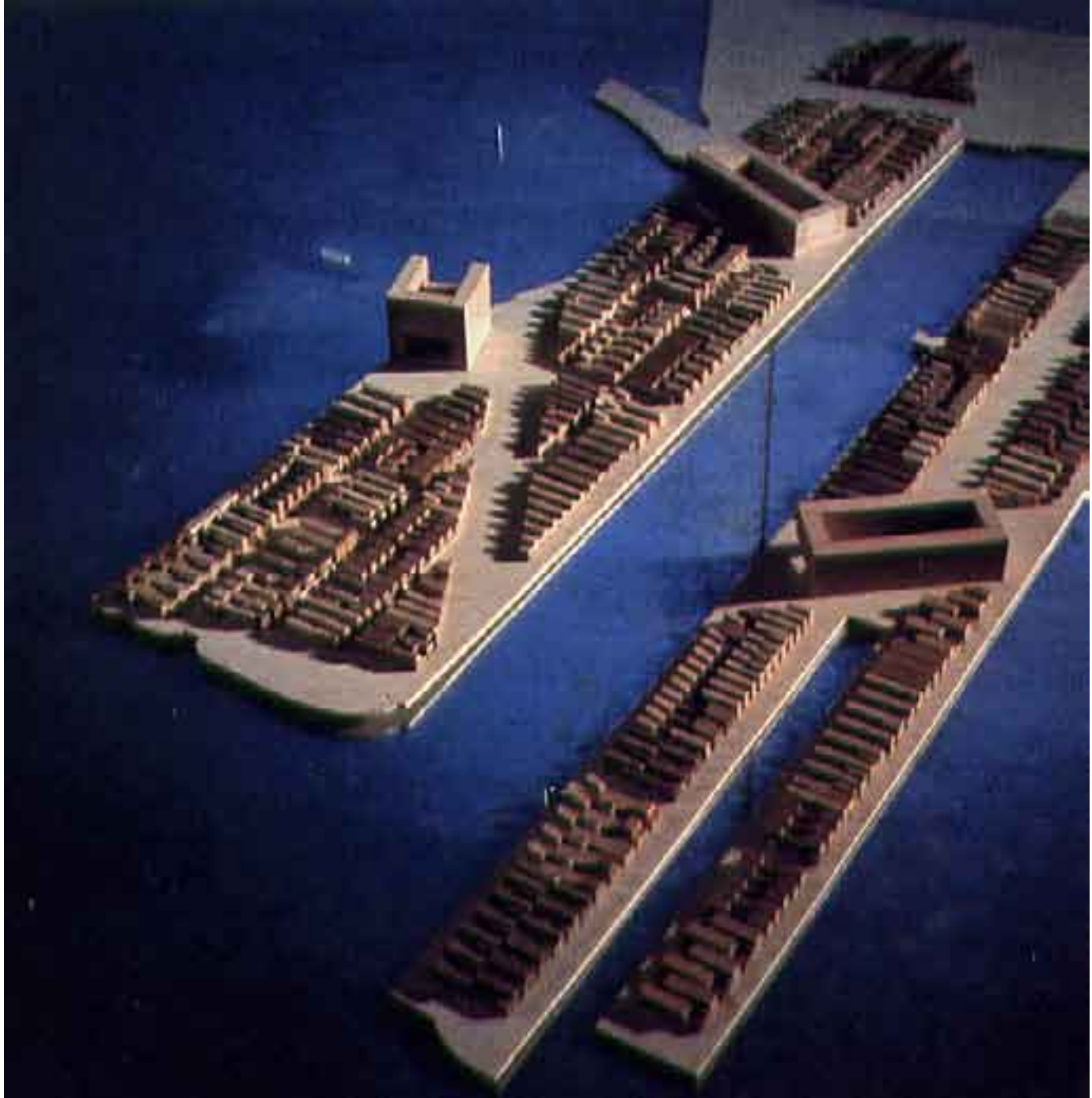





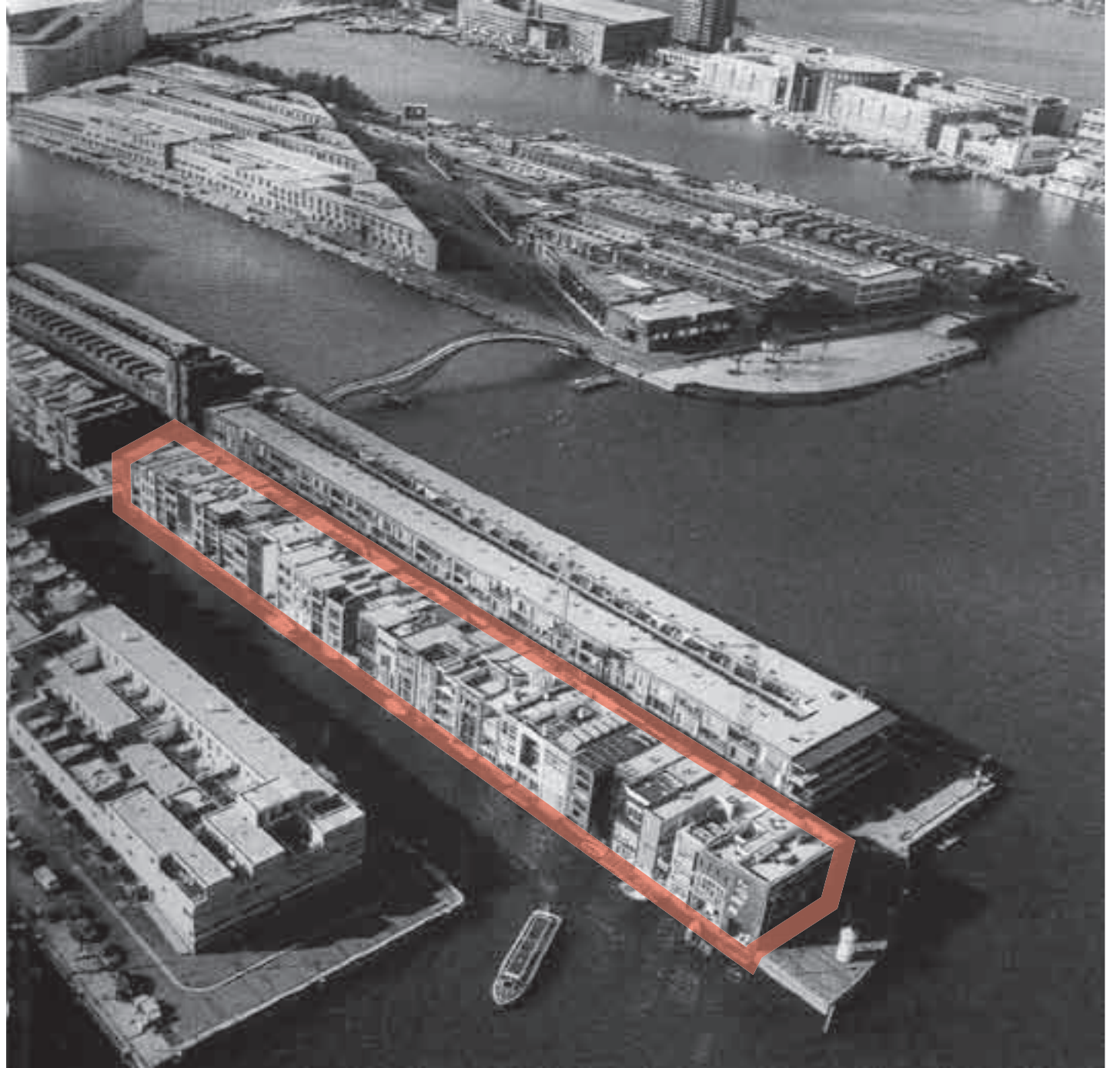

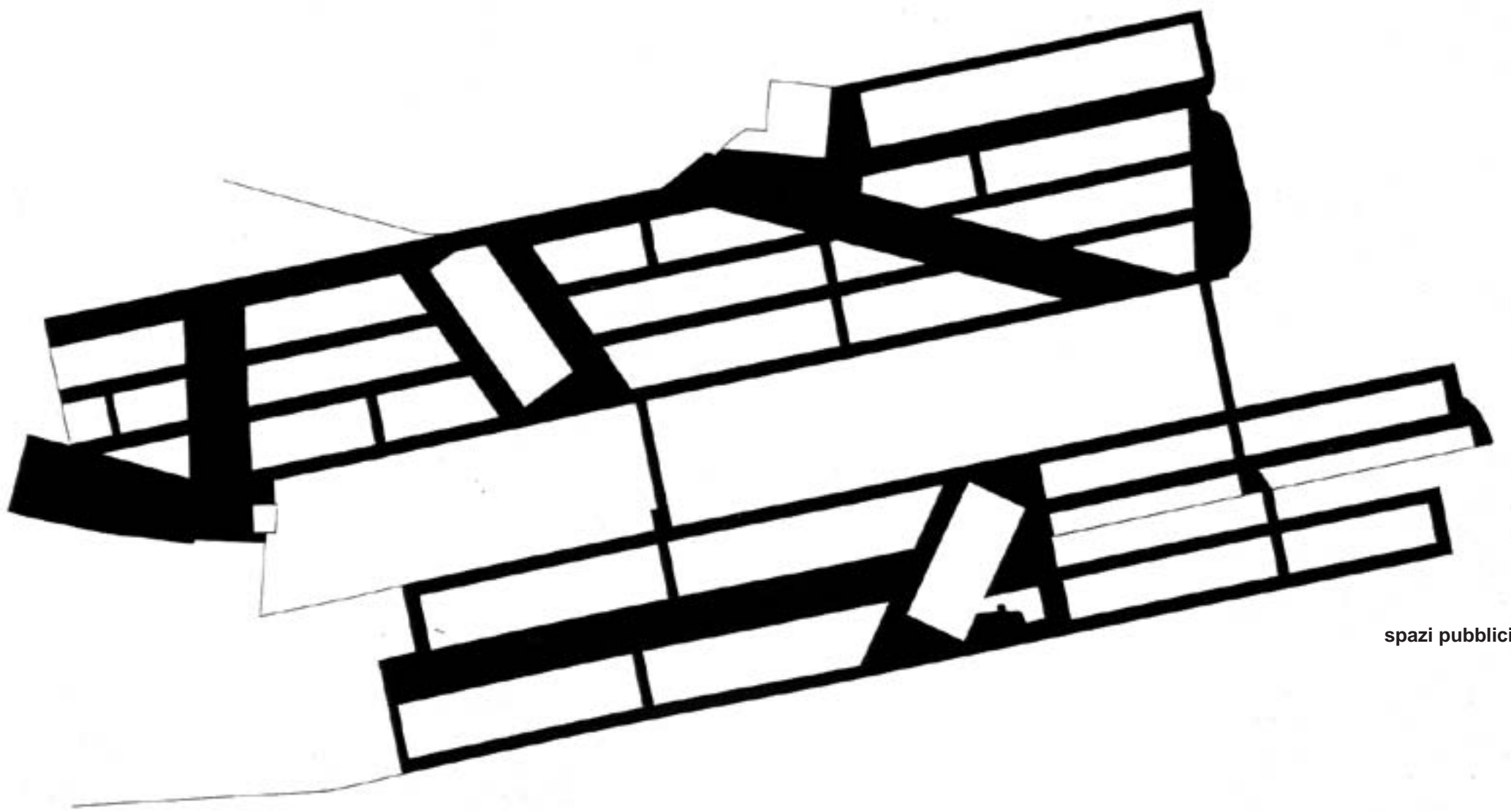

spazi pubblici



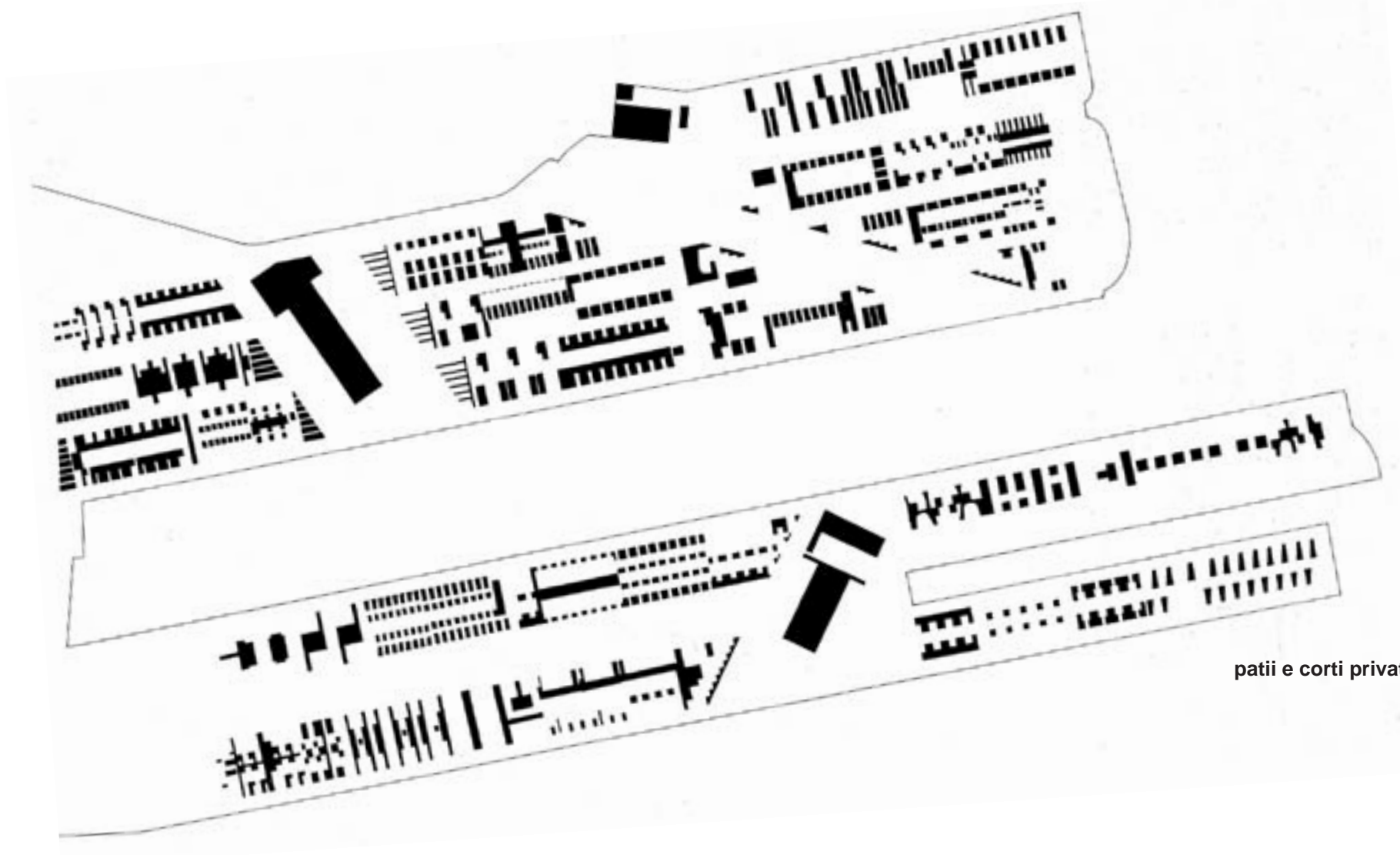

patii e corti privati









Heren 5

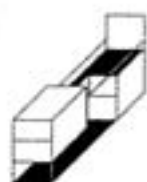

Kother & Salman



Erna van Sambeek



Wim Kloosterboer



Claus & Kaan



Höhne & Rapp

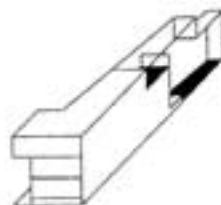

Van Herk

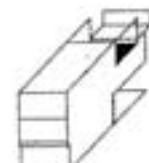

Kees Christiaanse

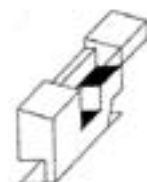

Hans Tüpkér

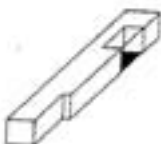

Marlies Röhmer

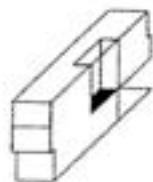

Herman Zeinstra

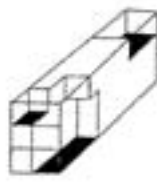

Van Berkel & Bos

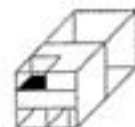

DKV



Xaveer de Geyter

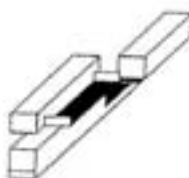

Willem Jan Neutelings



O.M.A.

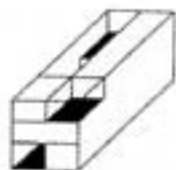

Claus & Kaan

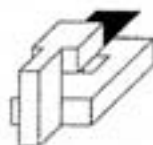

Liesbeth van der Pol



Willem Jan Neutelings

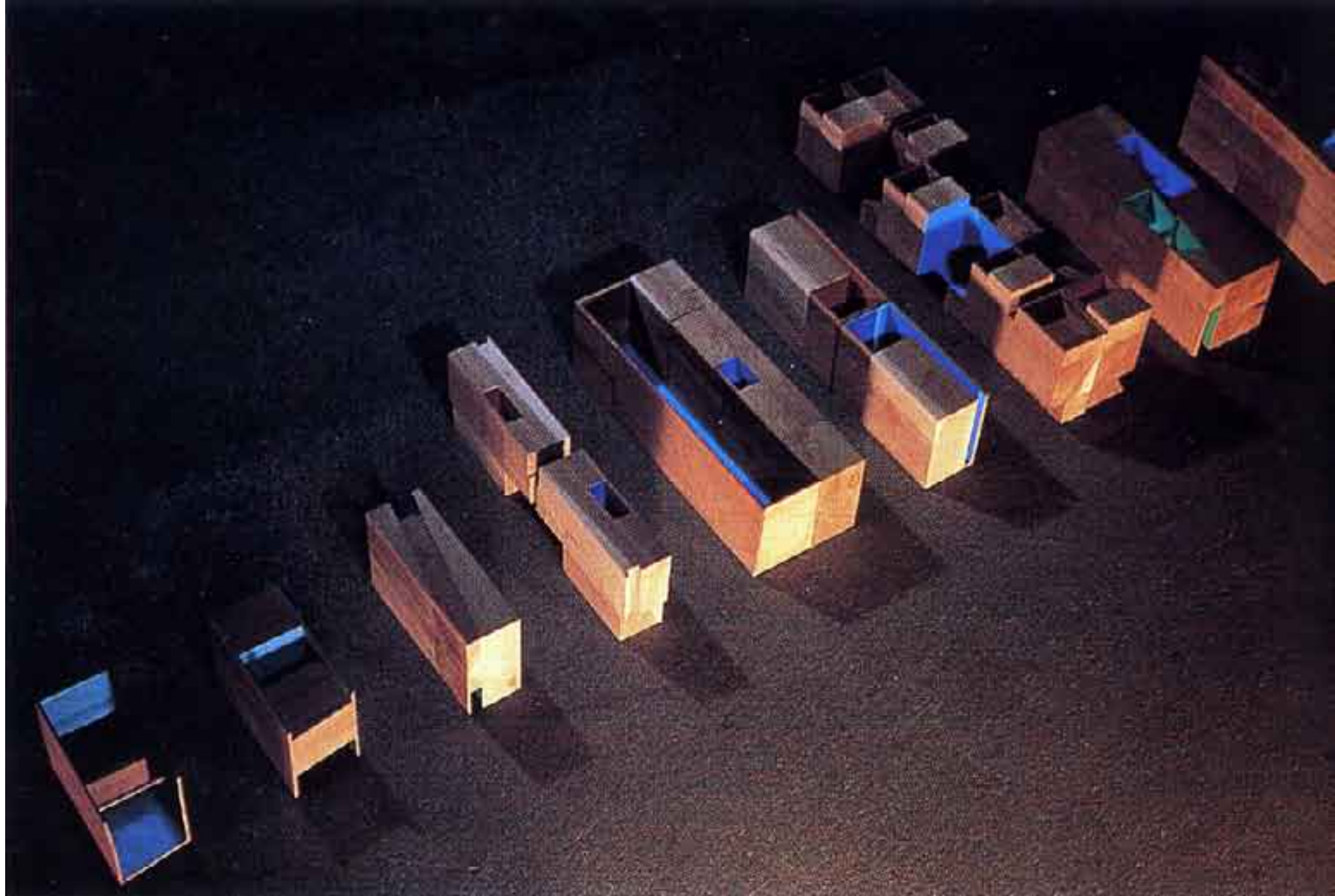

**mvrdiv | due case a borneo sporenburg  
amsterdam, the netherlands, 1999**

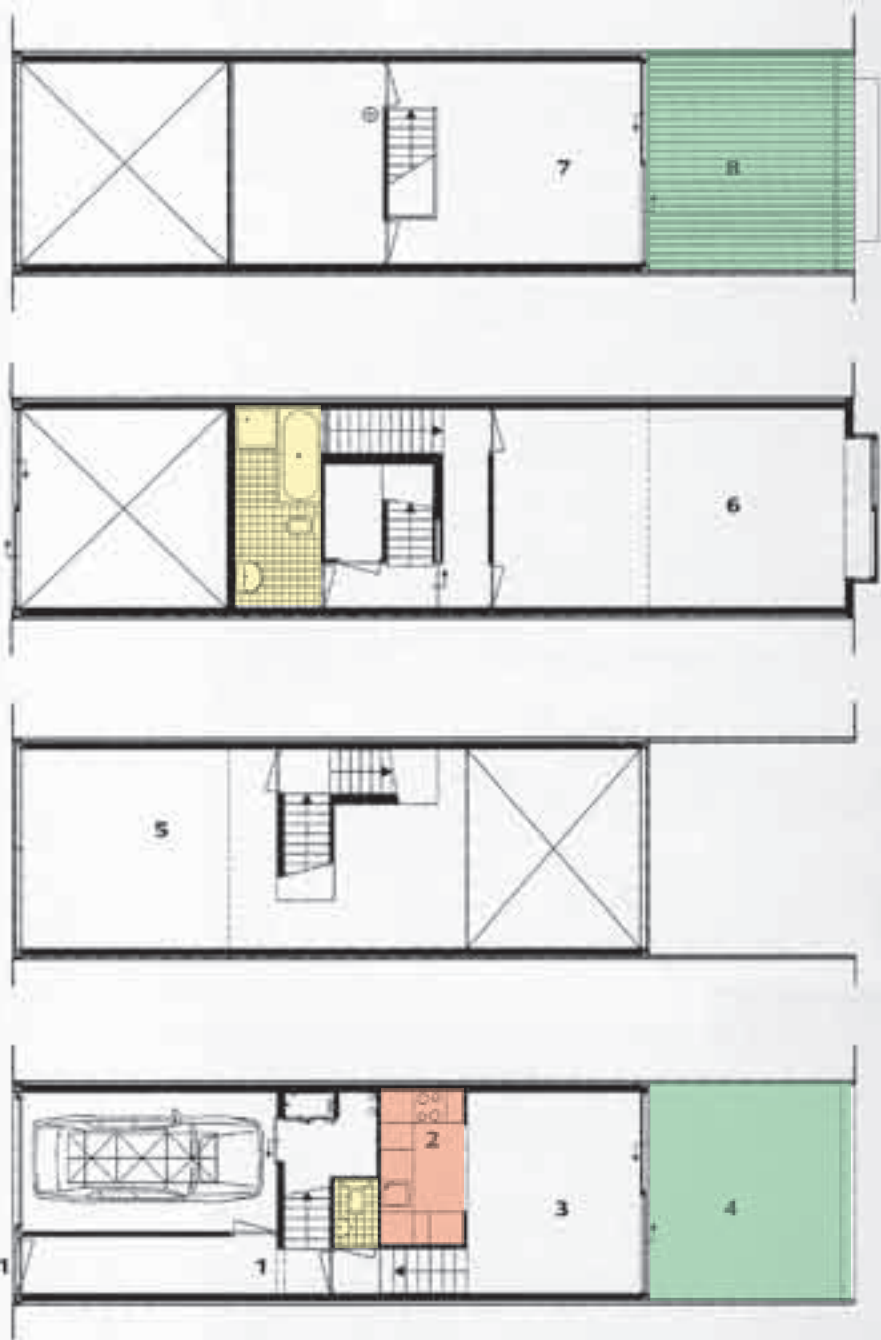

- 1 - ingresso
- 2 - cucina
- 3 - zona pranzo
- 4 - giardino
- 5 - zona giorno
- 6 - camera da letto
- 7 - studio
- 8 - terrazzo



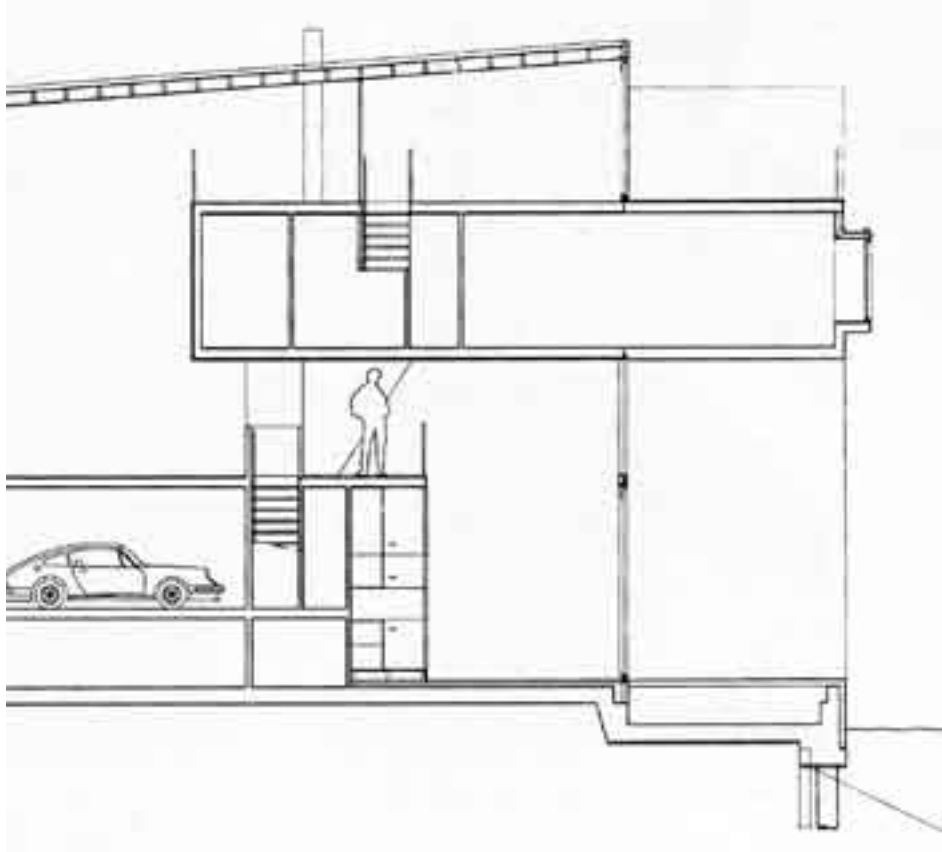

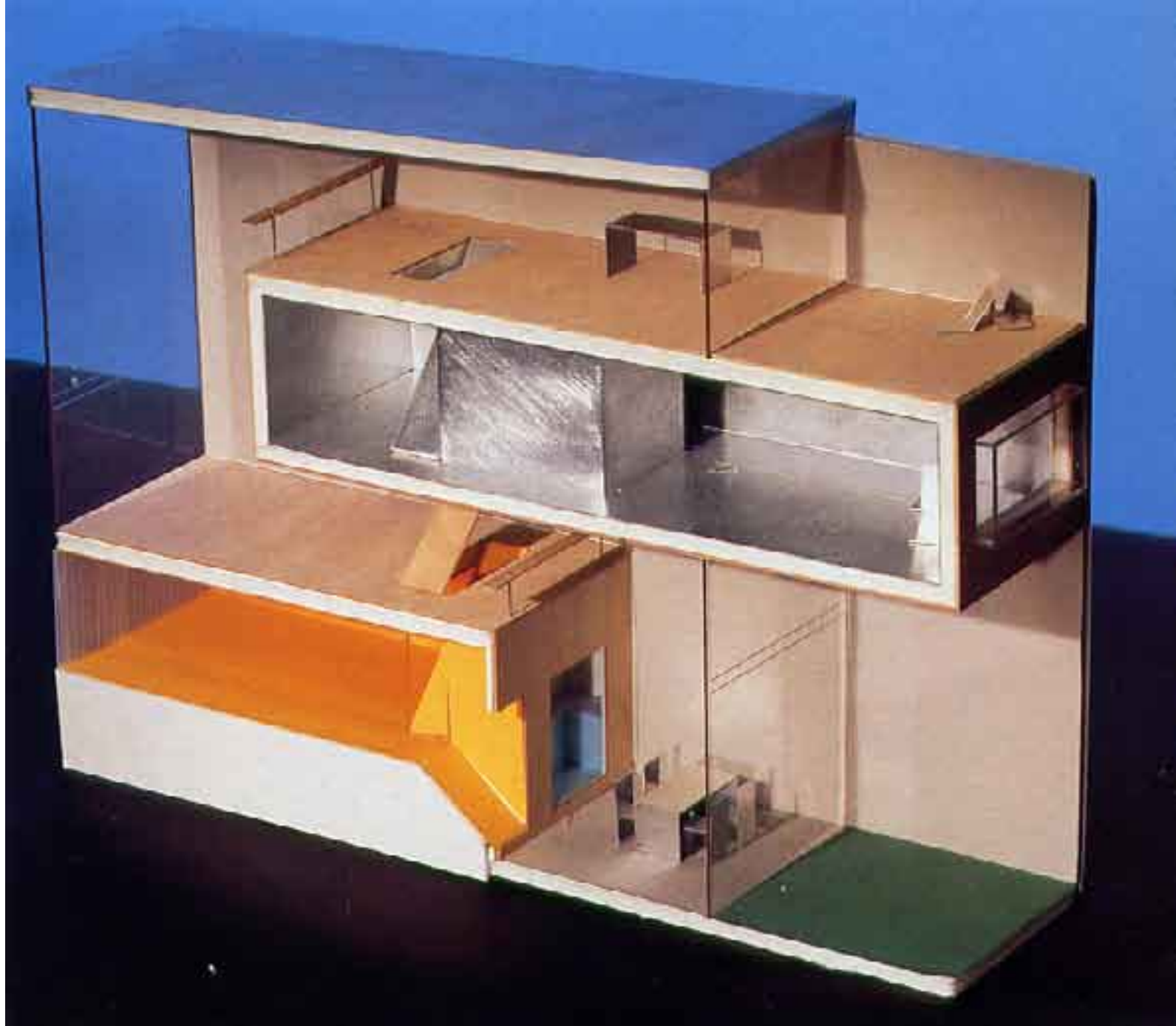

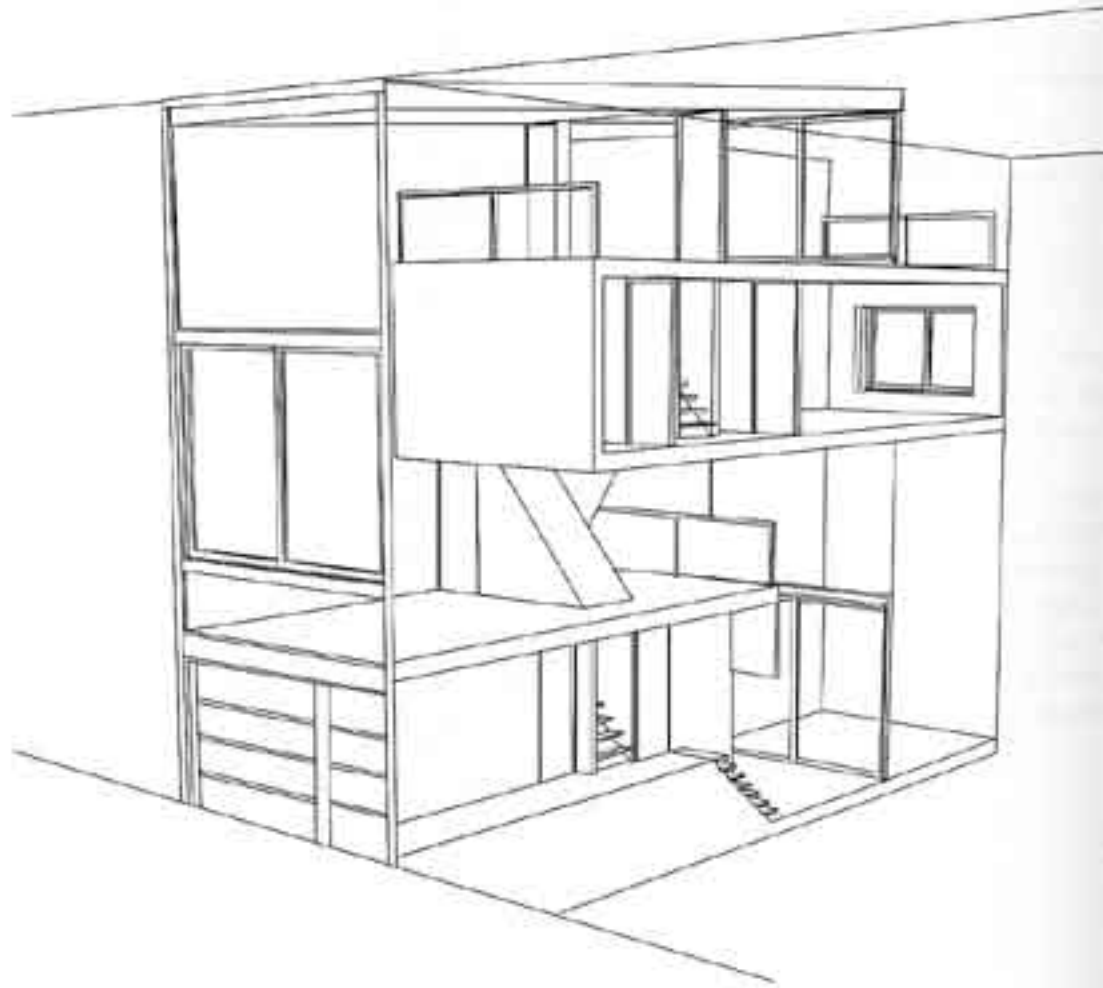



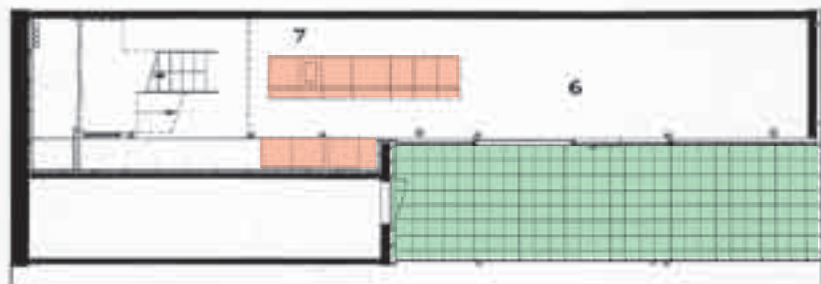
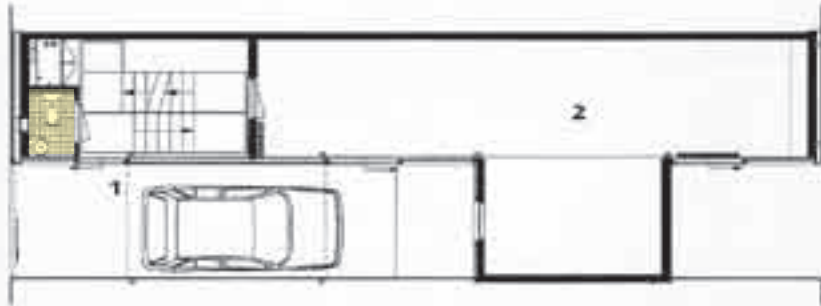

0 1 2 3 4 5

- 1 - ingresso
- 2 - studio
- 3 - camera da letto
- 4 - zona giorno / camera da letto
- 5 - terrazzo
- 6 - zona pranzo
- 7 - cucina

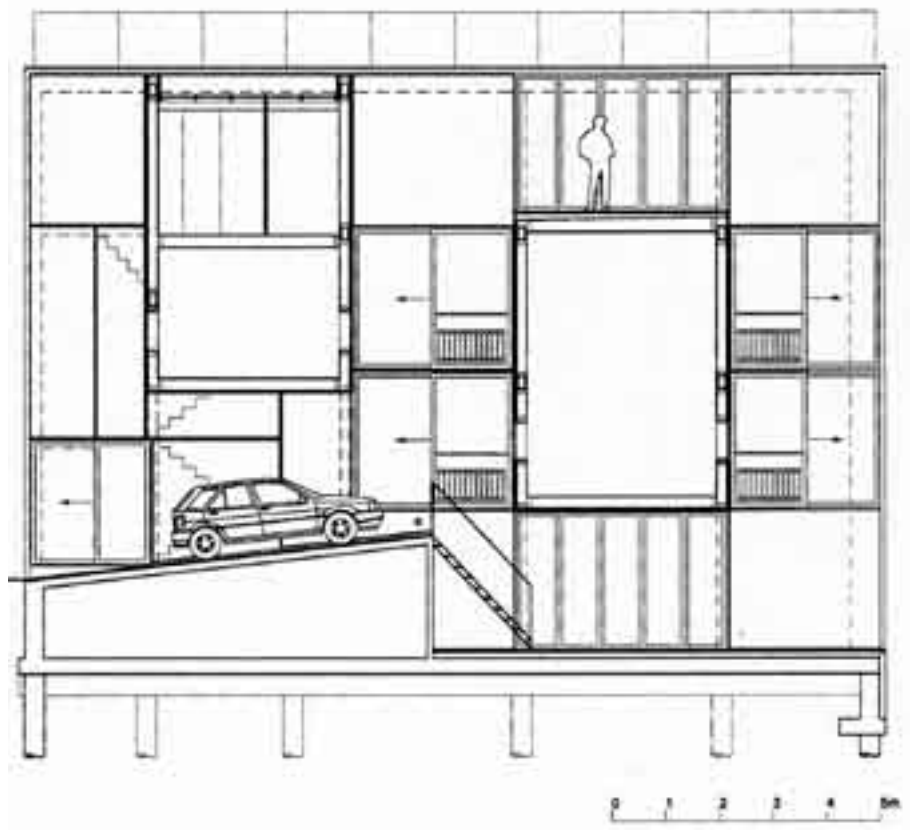

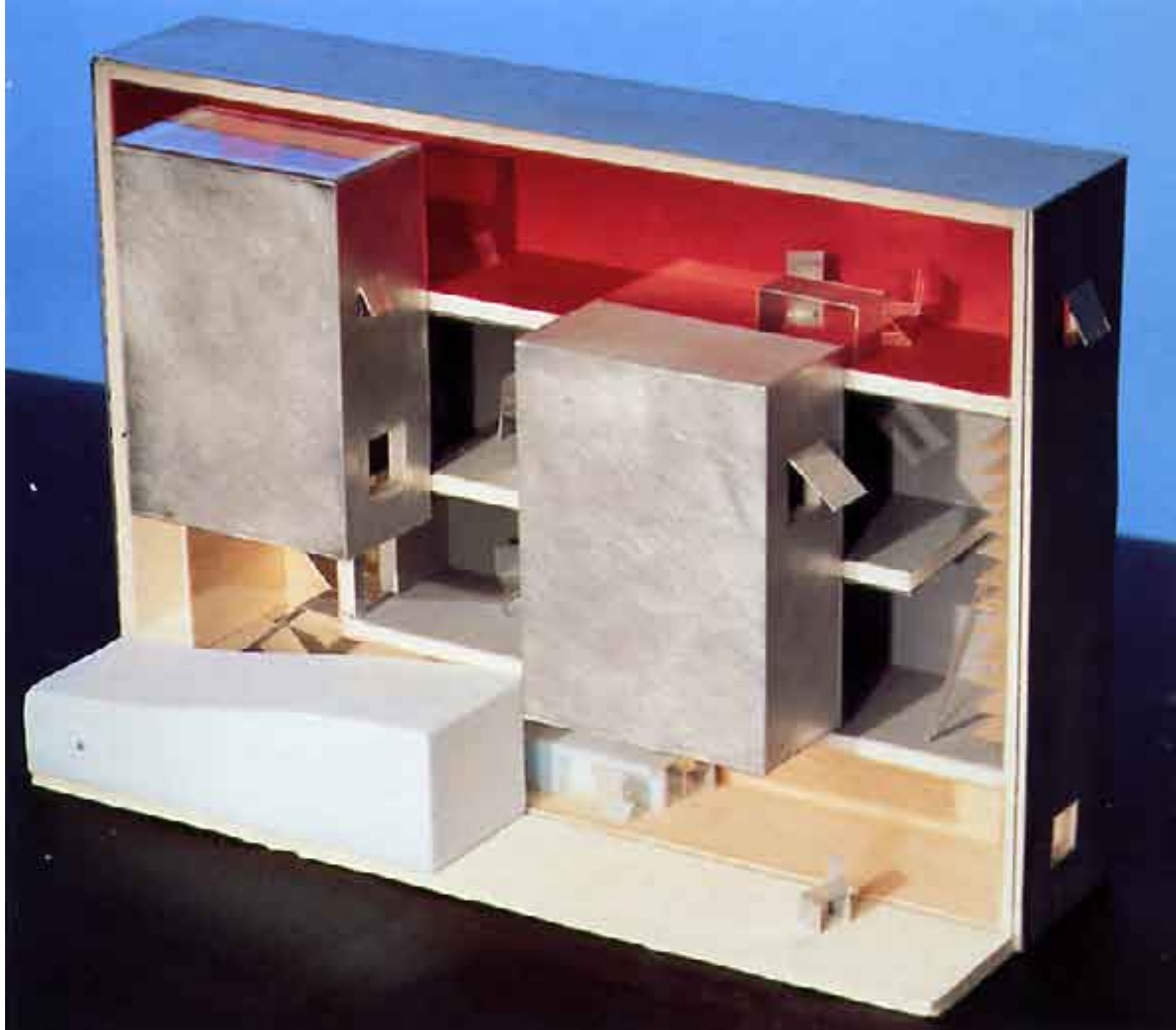

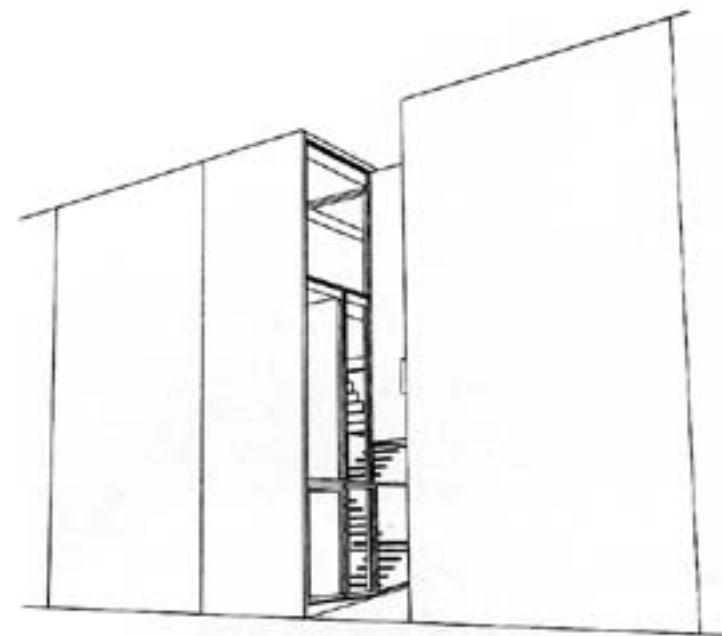
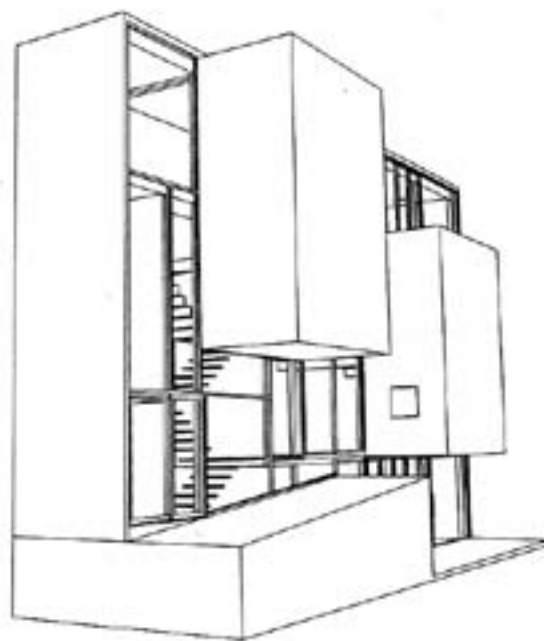
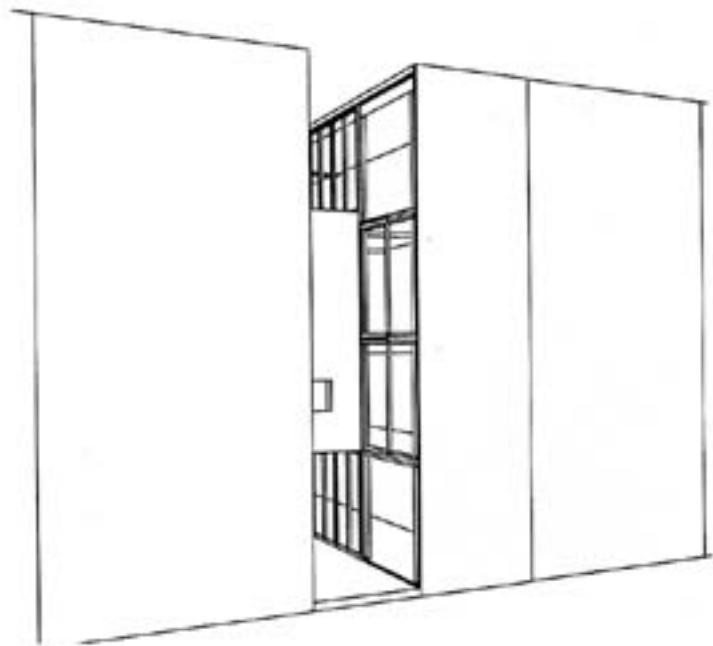





























































**sources:**

**Terence riley, The un-private house, the museum of modern art, new york, 1999**

**Manuel Gausa, housing! new alternatives new systems, birkhauser actar**

**Abitare, n. 417, maggio 2002**

**Lotus 109, il nuovo mondo allegorico, electa**