



Università degli Studi di Trieste

Dipartimento di Ingegneria e Architettura

Laurea Magistrale: Ingegneria Civile

Corso : Strade Ferrovie ed Aeroporti (248MI-2)



Lezione 04: Rotatorie

Roberto Roberti

Tel.: 040 558 3588

E-mail: roberto.roberti@dia.units.it



Anno accademico 2019/2020

Sommario

Cenni storici

Tipi di rotatorie

Classificazione rotatorie

Vantaggi e svantaggi rotatorie

Caratteristiche geometriche delle rotatorie

Capacità rotatorie

Sicurezza delle rotatorie

Zone di scambio

Cenni storici sulle rotatorie (1)

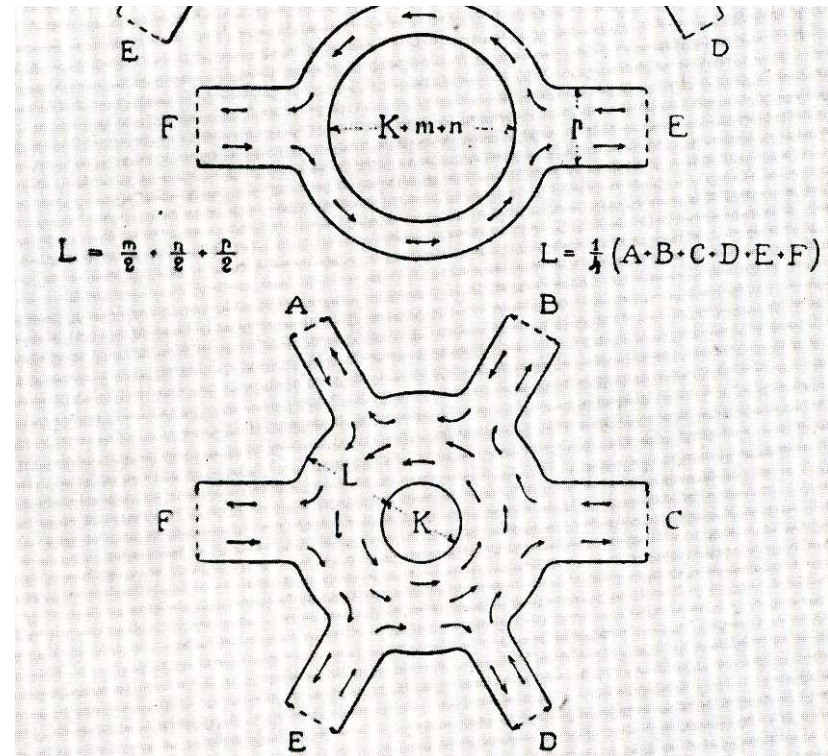
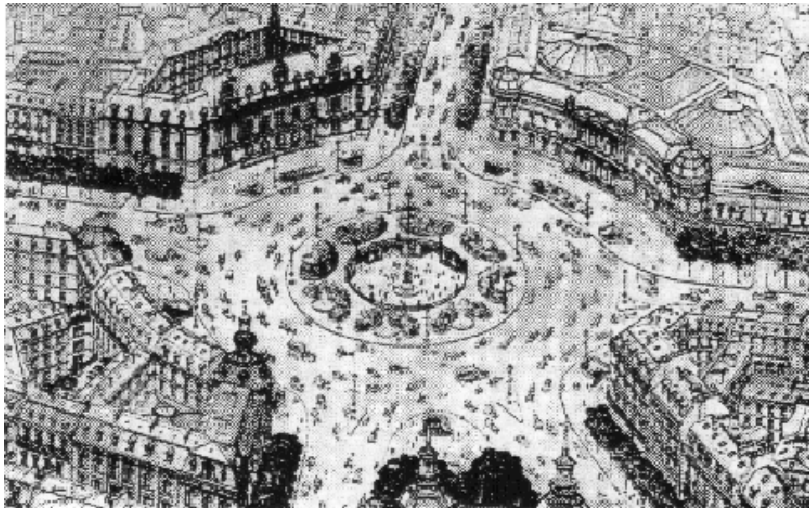

Cenni storici sulle rotatorie (2)



Cenni storici sulle rotatorie (3)

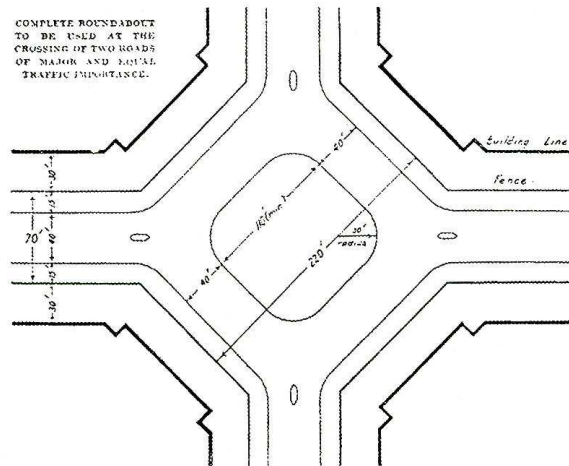
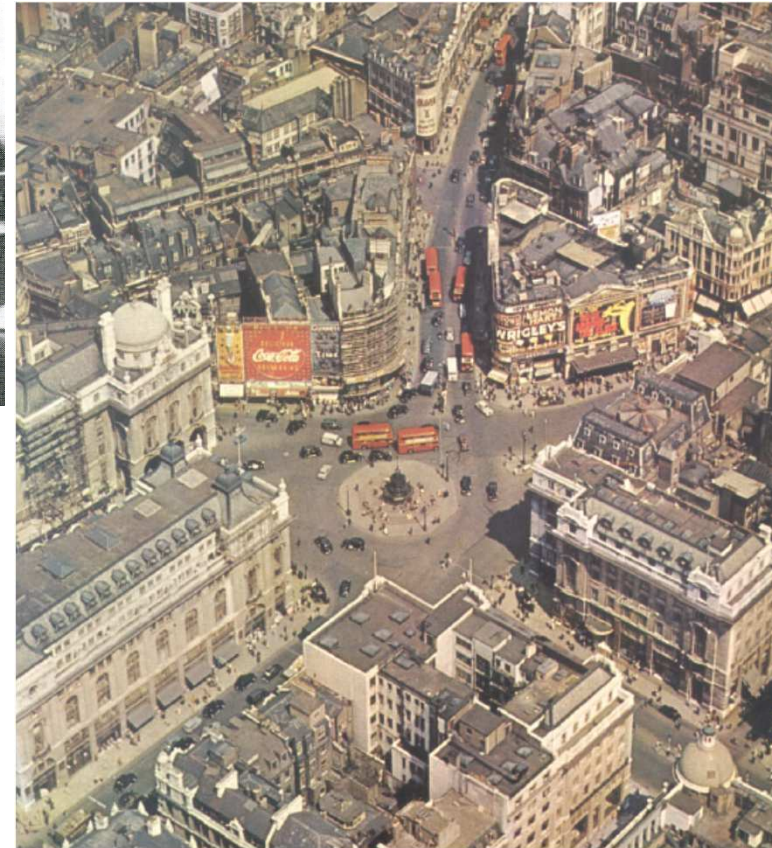
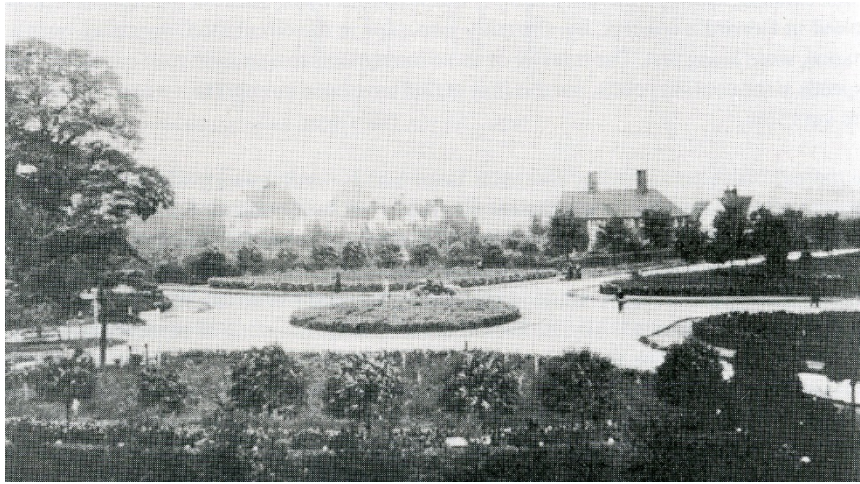

Cenni storici sulle rotatorie (4)

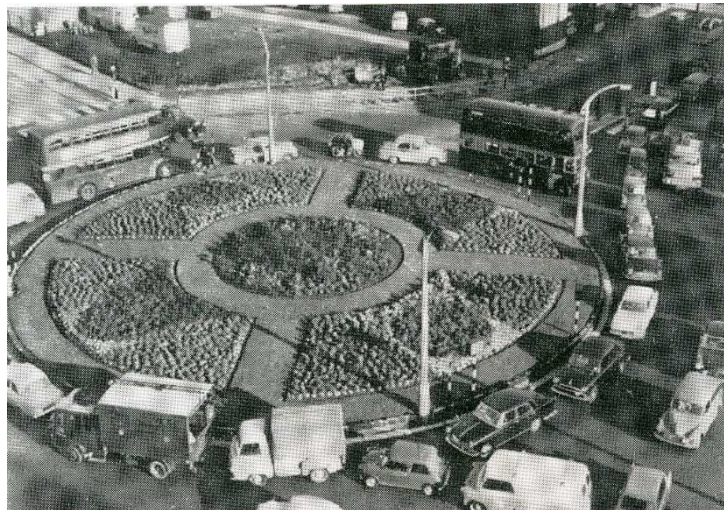
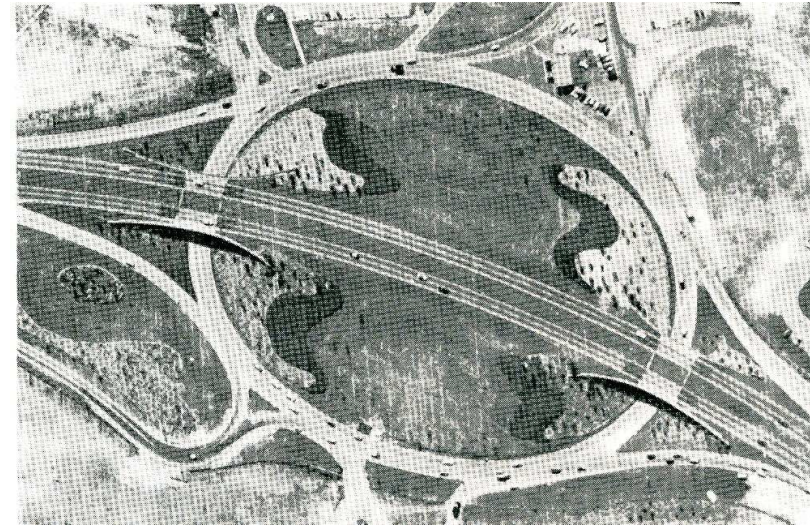
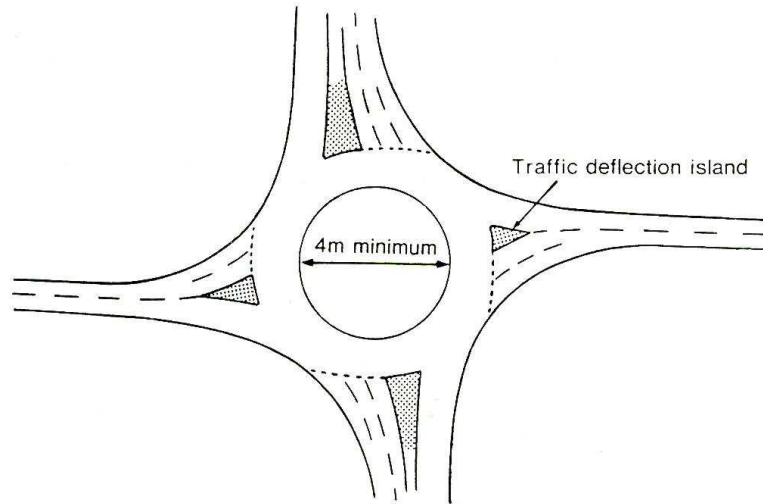

Definizione di rotatoria

Intersezione a raso costituita da un anello, in cui confluiscono i bracci dell'intersezione, che viene percorso a senso unico in direzione antioraria.

Un'intersezione stradale risolta a rotatoria va accompagnata lungo i rami di approccio da idonea segnaletica, se necessario anche integrativa rispetto a quella di preavviso, e da eventuali ulteriori strumenti di regolazione della velocità.



Figura II 27 Art. 96

CIRCOLAZIONE ROTATORIA
Presegnala sulle strade extraurbane una intersezione regolata con circolazione rotatoria.



Figura II 84 Art. 122

ROTATORIA
Indica la presenza di una intersezione, un'area, una piazza, ecc. nella quale la circolazione è regolata a rotatoria secondo il senso indicato dalle frecce.

Caratteristiche delle rotatorie

Isola centrale inaccessibile circondata da un anello percorso dal traffico proveniente da più entrate

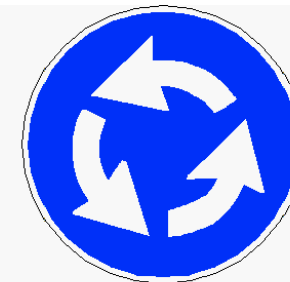
Circolazione nell'anello a senso unico antiorario **non necessariamente** con diritto di precedenza

Riduzione di velocità imposta dalla deflessione delle traiettorie

La regolazione della circolazione è affidata all'utente con il criterio della precedenza **non necessariamente** sull'anello



Tipi di rotatorie

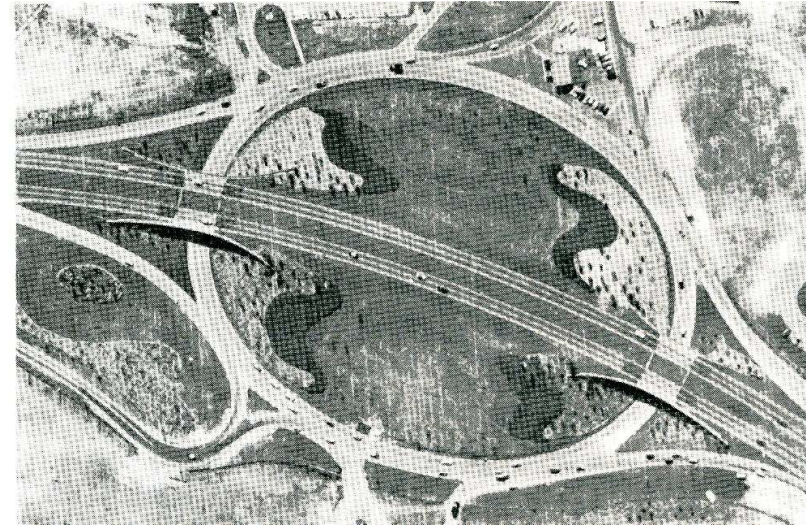

Traffic circle used in residential area to calm traffic



Hollywood Roundabout, MD

Rotatorie, rotonde e .. (1)

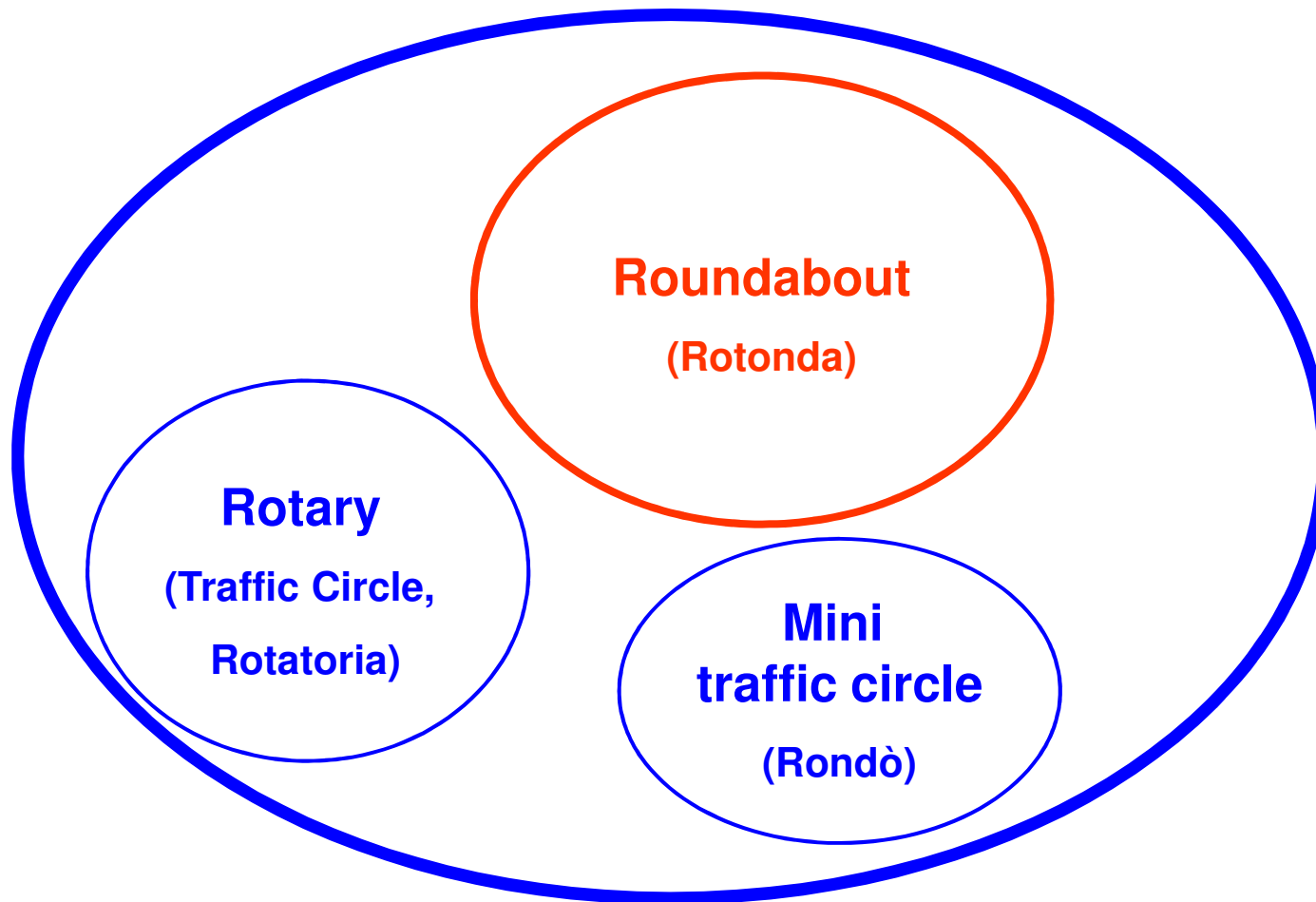

Rotatorie, rotonde e .. (2)



Table S.1: Distinguishing Features of Roundabouts and Traffic Circles

	Modern Roundabout	Traffic Circle
Control at Entry	Yield sign for entering vehicles.	Stop, signal, or give priority to entering vehicles.
Operational Characteristics	Vehicles in the roundabout will have a priority over the entering vehicle.	Allow weaving areas to resolve the conflicted movement.
Deflection	Use deflection to control the low speed operation through roundabout.	Some large traffic circles provide straight path for major movement with higher speed.
Parking	No parking is allowed on the circulating roadway.	Some larger traffic circles permit parking within the circulating roadway.
Pedestrian Crossing	No pedestrian activities take place on the central island.	Some larger traffic circles provide for pedestrian crossing to, and activities on, the central island.
Turning Movement	All vehicles circulate around the central island.	Mini-traffic circles, left-turning vehicles are expected to pass to the left of the central island.
Splitter Island	Required.	Optional.

Rotatorie, rotonde e .. (3)



Classificazione delle rotatorie (1)

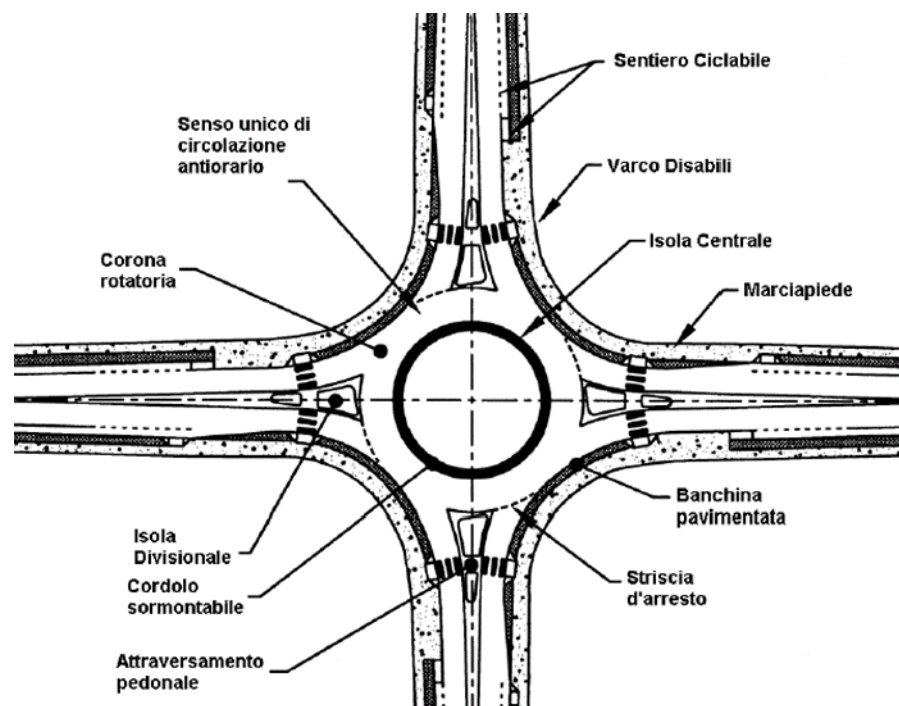

Si considerano tre tipologie fondamentali di rotatorie in base al diametro della circonferenza esterna (limite della corona rotatoria):

- rotatorie **CONVENZIONALI** con diametro esterno compreso tra 40 e 50 m;
- rotatorie **COMPATTE** con diametro esterno compreso tra 25 e 40 m;
- **MINI** rotatorie con diametro esterno compreso tra 14 e 25 m.

Per sistemazioni con "circolazione rotatoria", che non rientrano nelle tipologie su esposte, il dimensionamento e la composizione geometrica debbono essere definiti con il principio dei tronchi di scambio tra due bracci contigui. In questi casi le immissioni devono essere organizzate con appositi dispositivi.

Classificazione delle rotatorie (2)

Design Element	Mini-Roundabout	Urban Compact	Urban Single-Lane	Urban Double-Lane	Rural Single-Lane	Rural Double-Lane
Recommended maximum entry design speed	25 km/h (15 mph)	25 km/h (15 mph)	35 km/h (20 mph)	40 km/h (25 mph)	40 km/h (25 mph)	50 km/h (30 mph)
Maximum number of entering lanes per approach	1	1	1	2	1	2
Typical inscribed circle diameter ¹	13 m to 25 m (45 ft to 80 ft)	25 to 30 m (90 to 100 ft)	30 to 40 m (100 to 130 ft)	45 to 55 m (150 to 190 ft)	35 to 40 m (115 to 130 ft)	55 to 60 m (180 to 200 ft)
Splitter island treatment	Raised if possible, crosswalk cut if raised	Raised, with crosswalk cut	Raised, with crosswalk cut	Raised, with crosswalk cut	Raised and extended, with crosswalk cut	Raised and extended, with crosswalk cut
Typical daily service volumes on 4-leg roundabout (veh/day)	10,000	15,000	20,000	Refer to Chapter 4 procedures	20,000	Refer to Chapter 4 procedures

1. Assumes 90-degree entries and no more than four legs.

Mini rotatorie (1)

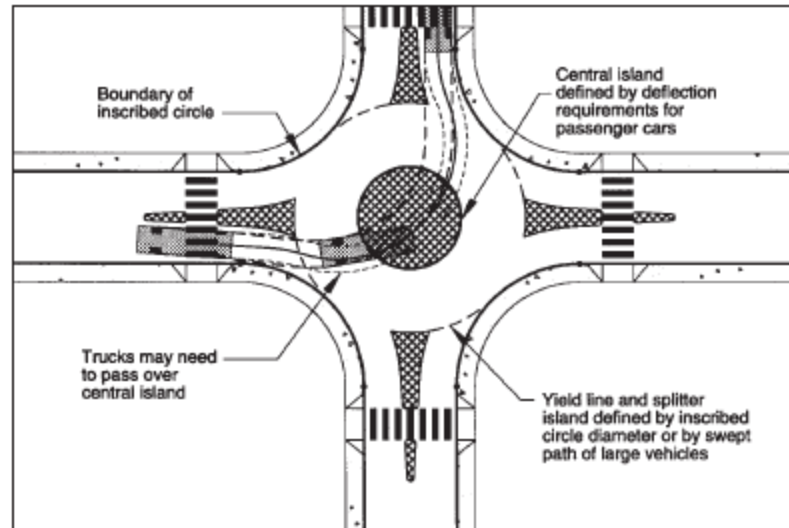

Un ulteriore elemento distintivo tra le tre tipologie fondamentali di attrezzatura rotatoria e rappresentato dalla sistemazione dell'isola circolare centrale, che può essere resa in parte transitabile per le manovre dei veicoli pesanti, nel caso di mini-rotatorie con diametro esterno compreso fra 25 e 18 m, mentre lo diventa completamente per quelle con diametro compreso fra 18 e 14 m;

Mini rotatorie (2)

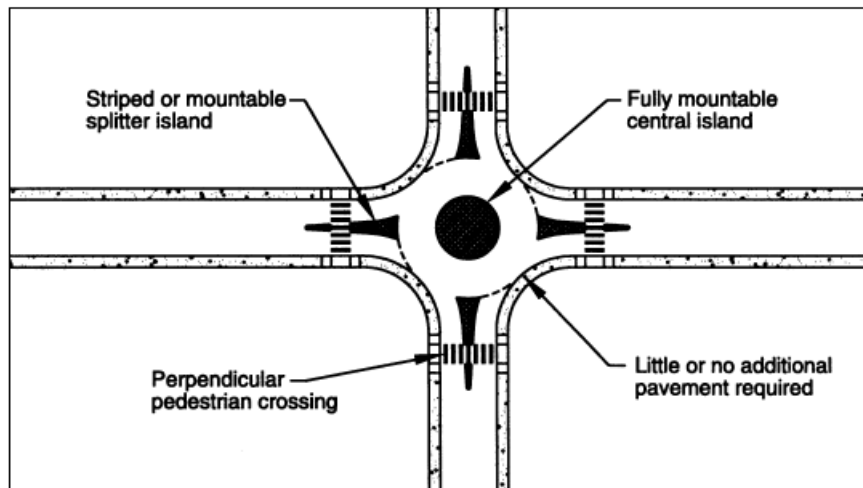

In base alla classificazione delle intersezioni riportata nel capitolo 3 (delle norma del 2006), in ambito extraurbano l'adozione di mini rotatorie viene limitata agli incroci tipo F/F tra strade locali,

Rotatorie compatte (1)

..... le rotatorie compatte sono invece caratterizzate da bordure non sormontabili dell'isola centrale.

In ambito extraurbano le rotatorie compatte sono consentite anche per gli incroci tipo *C/C*, *C/F*, *F/C*.

Rotatorie Extra-urbane Compatte a singola corsia

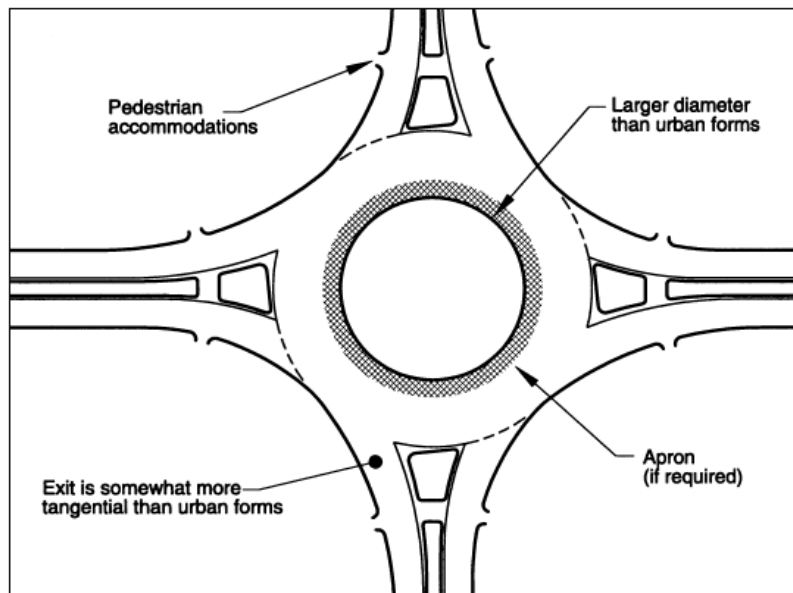

Rotatorie Compatte (2)

Rotatorie Urbane Compatte

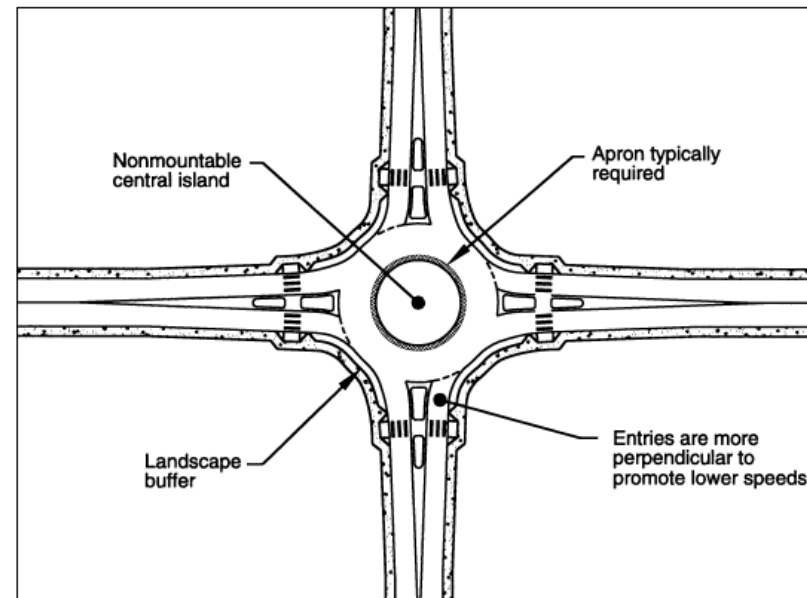

Rotatorie convenzionali (1)

Rotatorie Urbane a singola corsia

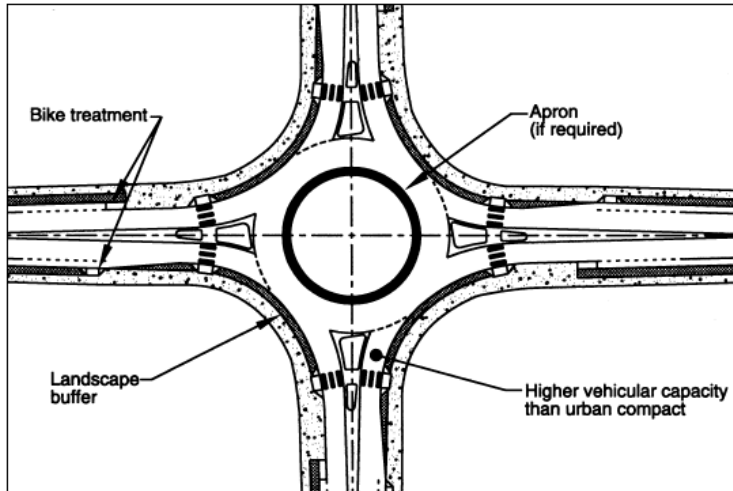

Rotatorie Urbane a doppia corsia

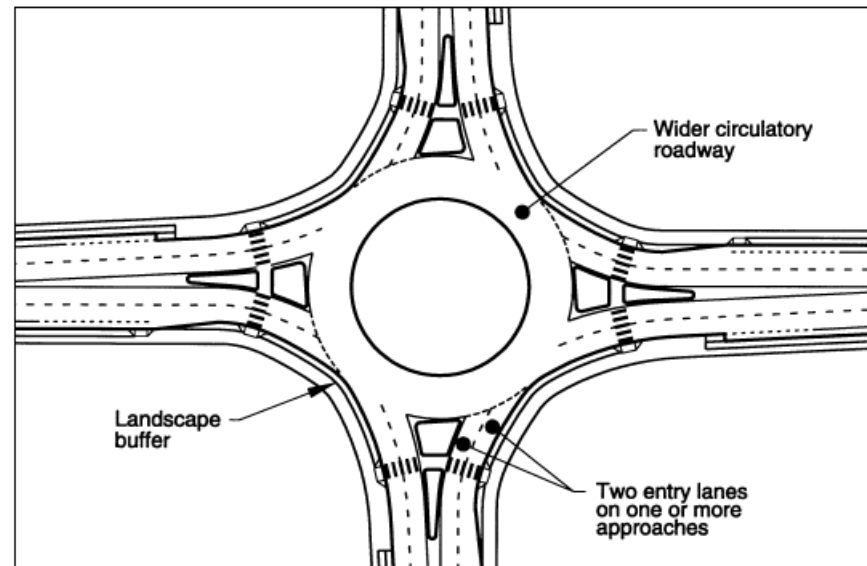

Rotatorie convenzionali (2)

Rotatorie Extra-urbane a doppia corsia

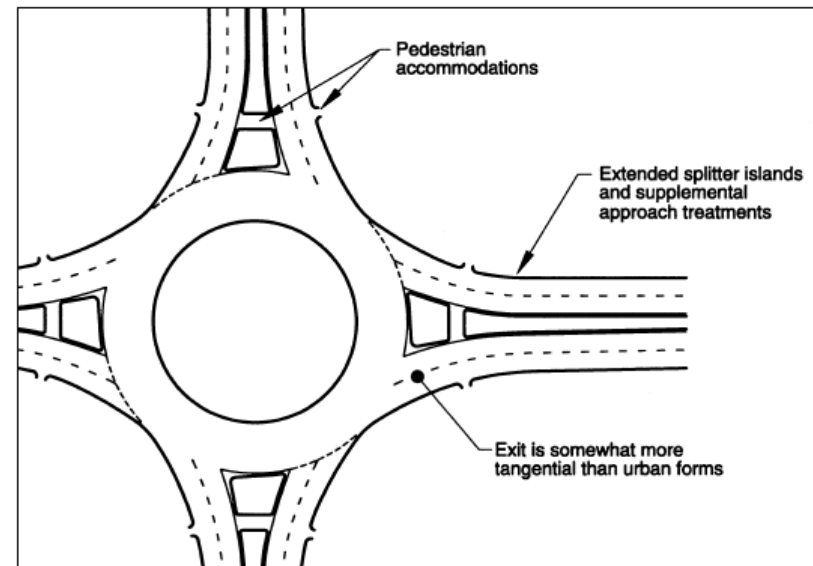

Vantaggi e svantaggi delle rotatorie (1)

Table S.2: Advantages and Disadvantages Comparison

Category	Advantages	Disadvantages
Safety	<ul style="list-style-type: none"> - There are a reduced number of conflict points compared to uncontrolled intersection. - Lower operational speeds yield less severe and fewer accidents. - Slower speeds because of intersection geometry reduce accidents. 	<ul style="list-style-type: none"> - Since roundabouts are unfamiliar to the average driver in the US, there is likely to be an initial period where accidents increase. - Signalized intersections can preempt control for emergency vehicles.
Capacity	<ul style="list-style-type: none"> - Traffic <i>yields</i> rather than <i>stops</i>, often resulting in the acceptance of smaller gaps. - For isolated intersections, roundabouts should give higher capacity/lane than signalized intersections due to the omission of lost time (red and yellow) at signalized intersections. 	<ul style="list-style-type: none"> - Where the coordinated signal network can be used, a signalized intersection will increase the overall capacity of the network. - Signals may be preferred at intersections that periodically operate at higher than designed capacities.
Delay	<ul style="list-style-type: none"> - Overall delay will probably be less than for an equivalent volume signalized intersection (this does not equate to a higher level of service). - During the off-peak, signalized intersections with no retiming produce unnecessary delays to stopped traffic when gaps on the other flow are available. 	<ul style="list-style-type: none"> - Drivers may not like the geometric delays which force them to divert their cars from straight paths. - When queuing develops, entering drivers tend to force into the circulating streams with shorter gaps. This may increase the delays on other legs and the number of accidents.
Cost	<ul style="list-style-type: none"> - In general, less right-of-way is required. - Maintenance costs of signalized intersections include electricity, maintenance of loops, signal heads, controller, timing plans (roundabout maintenance includes only landscape maintenance, illumination, and occasional sign replacement). - Accident costs are low due to the low number of accidents and severity. 	<ul style="list-style-type: none"> - Construction costs may be higher. - In some locations, roundabouts may require more illumination, increasing costs.
Pedestrians and Bicyclists	<ul style="list-style-type: none"> - A splitter island provides a refuge for pedestrians that will increase safety. - At low speed and low traffic volume, roundabouts should improve safety for bicyclists. 	<ul style="list-style-type: none"> - A splitter island may cause difficulty to people using wheelchairs. - Tight dimensions of roundabouts create an uncomfortable feeling to bicyclists. - Longer paths increase travel distances for both pedestrians and bicyclists. - Roundabouts may increase delay for pedestrians seeking acceptable gaps to cross.

Vantaggi e svantaggi delle rotatorie (2)

Type of Roundabout	Sites	Before Roundabout			Roundabout			Percent Change ⁵		
		Total Inj. ³	PDO ⁴		Total Inj.	PDO		Total Inj.	PDO	
Small/Moderate ¹	8	4.8	2.0	2.4	2.4	0.5	1.6	-51%	73%	-32%
Large ²	3	21.5	5.8	15.7	15.3	4.0	11.3	-29%	-31%	-10%
Total	11	9.3	3.0	6.0	5.9	1.5	4.2	-37%	-51%	-29%

Notes:

1. Mostly single-lane roundabouts with an inscribed circle diameter of 30 to 35 m (100 to 115 ft).
2. Multilane roundabouts with an inscribed circle diameter greater than 50 m (165 ft).
3. Inj. - Injury crashes
4. PDO - Property Damage Only crashes
5. Only injury crash reductions for small/moderate roundabouts were statistically significant.

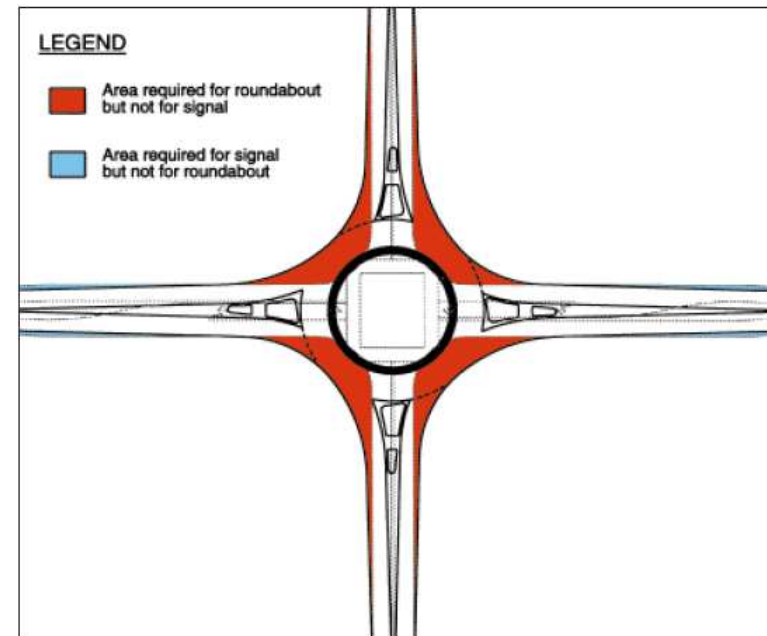

Riduzione dei punti di conflitto

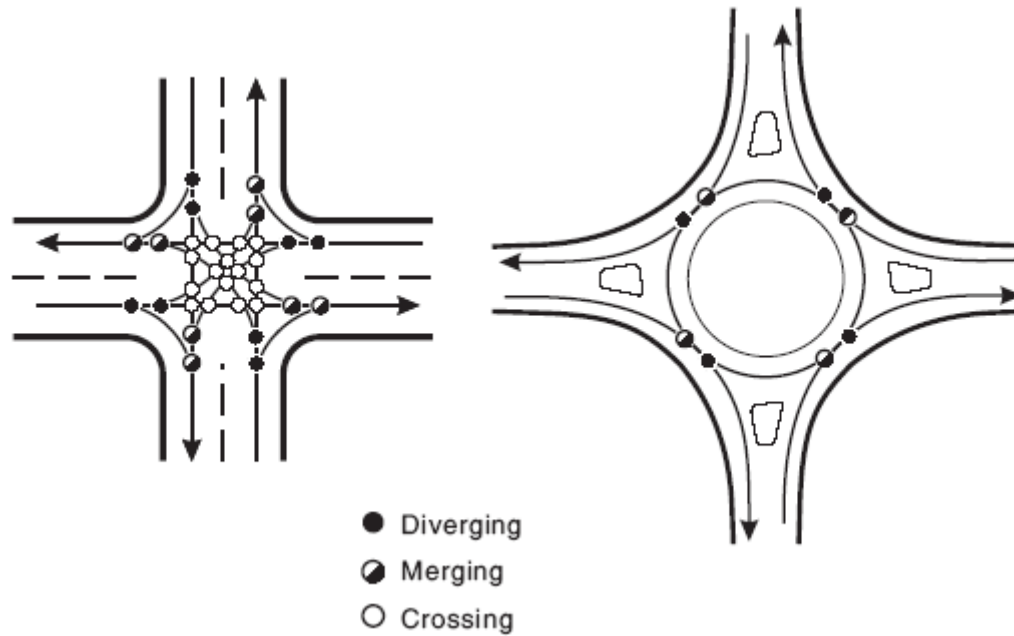

PUNTI DI CONFLITTO

32

8

Rotatorie e pedoni (1)

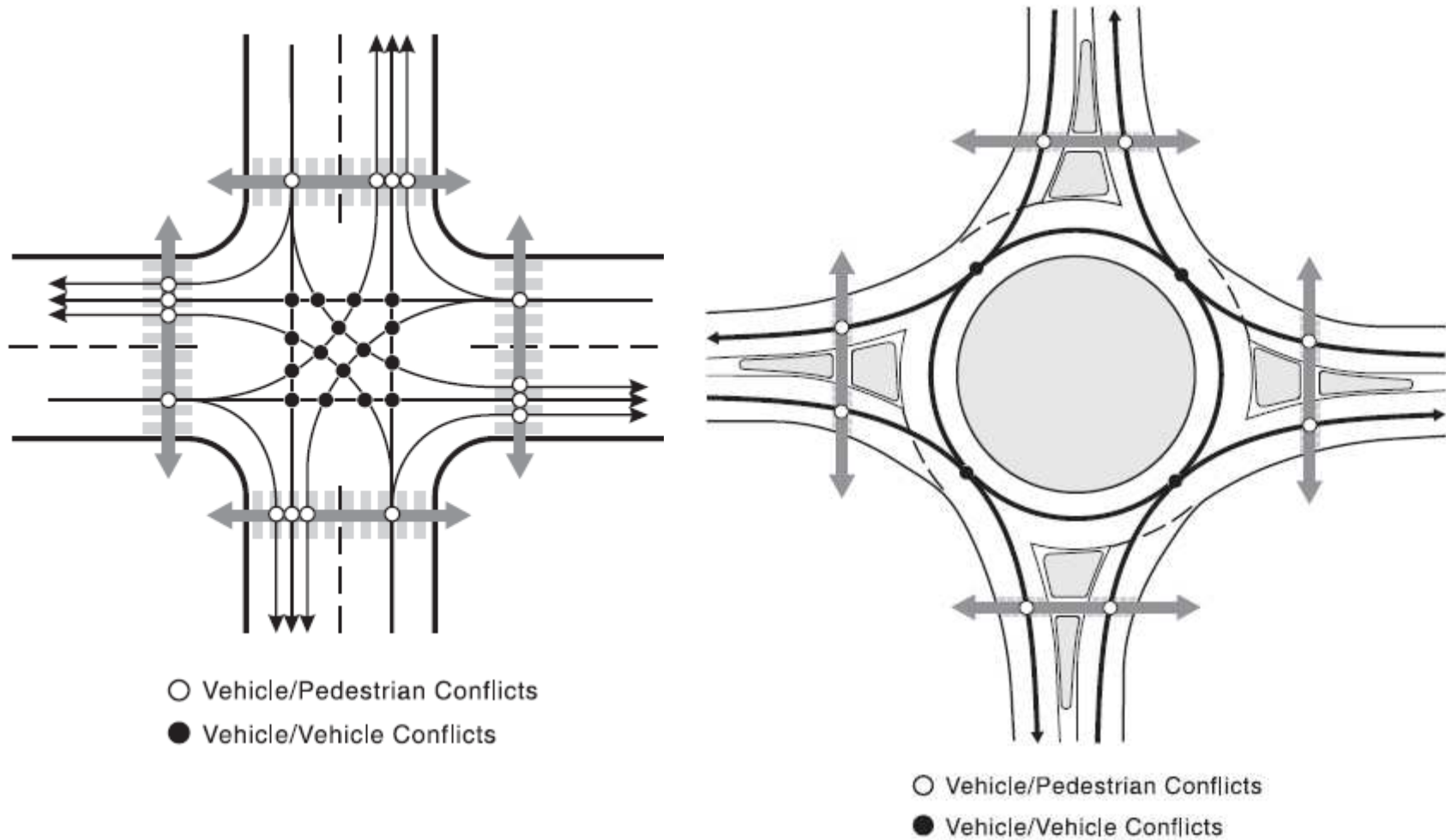

Rotatorie e pedoni (2)



Rotatorie e ciclisti (1)

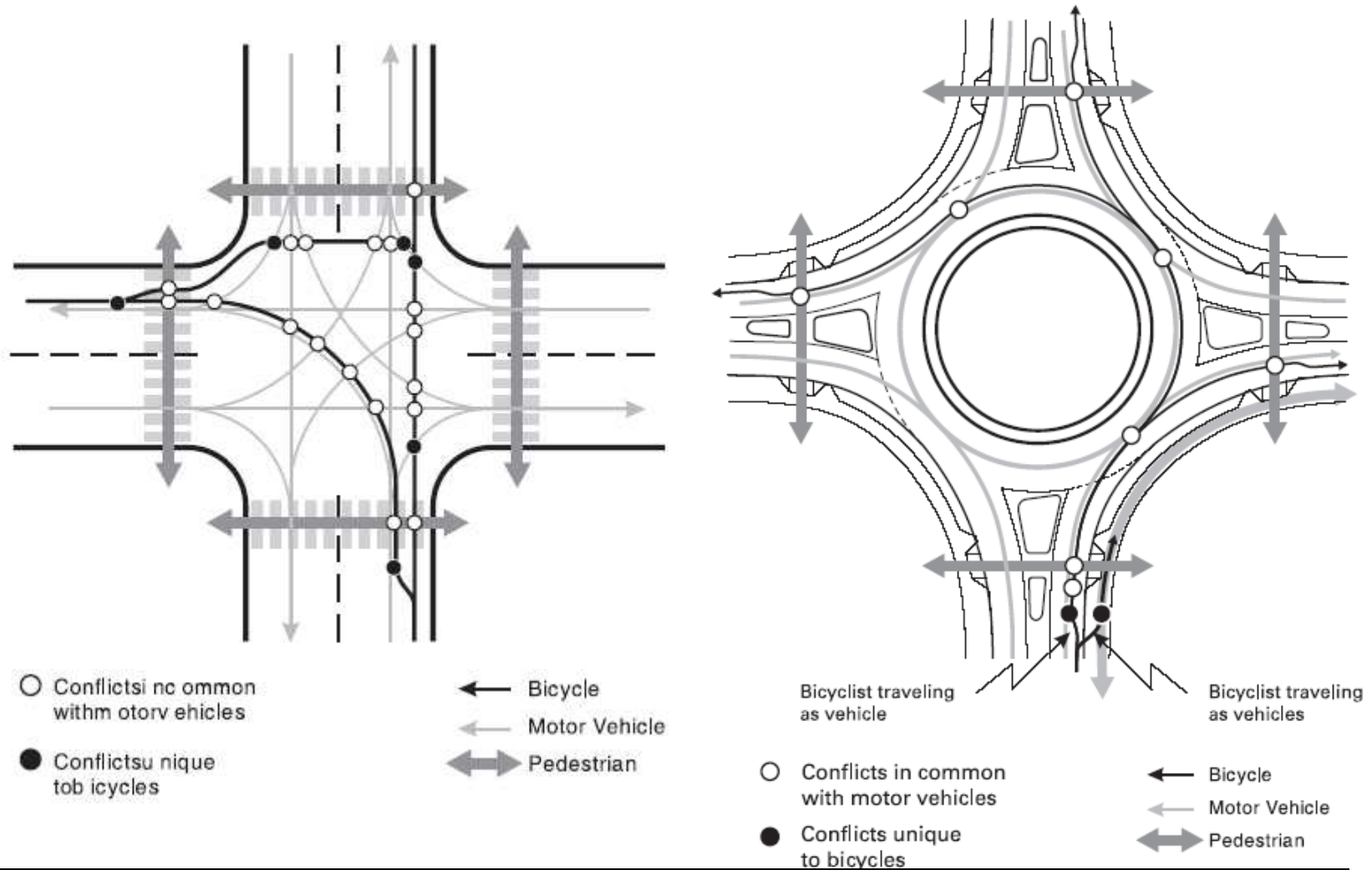

Rotatorie e ciclisti (2)

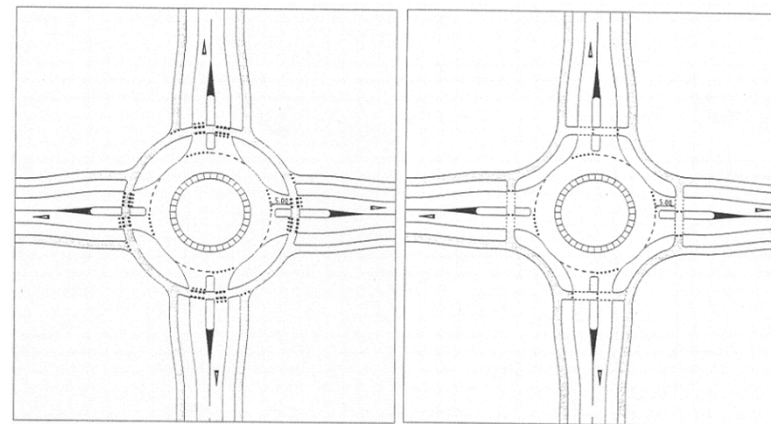
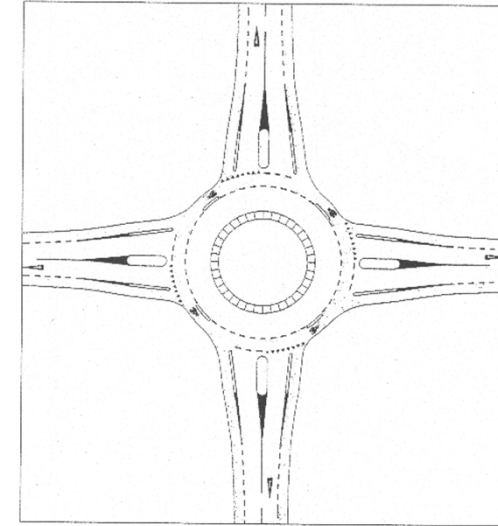

Rotatorie e ciclisti (3)



Rotatorie e ciclisti (4)

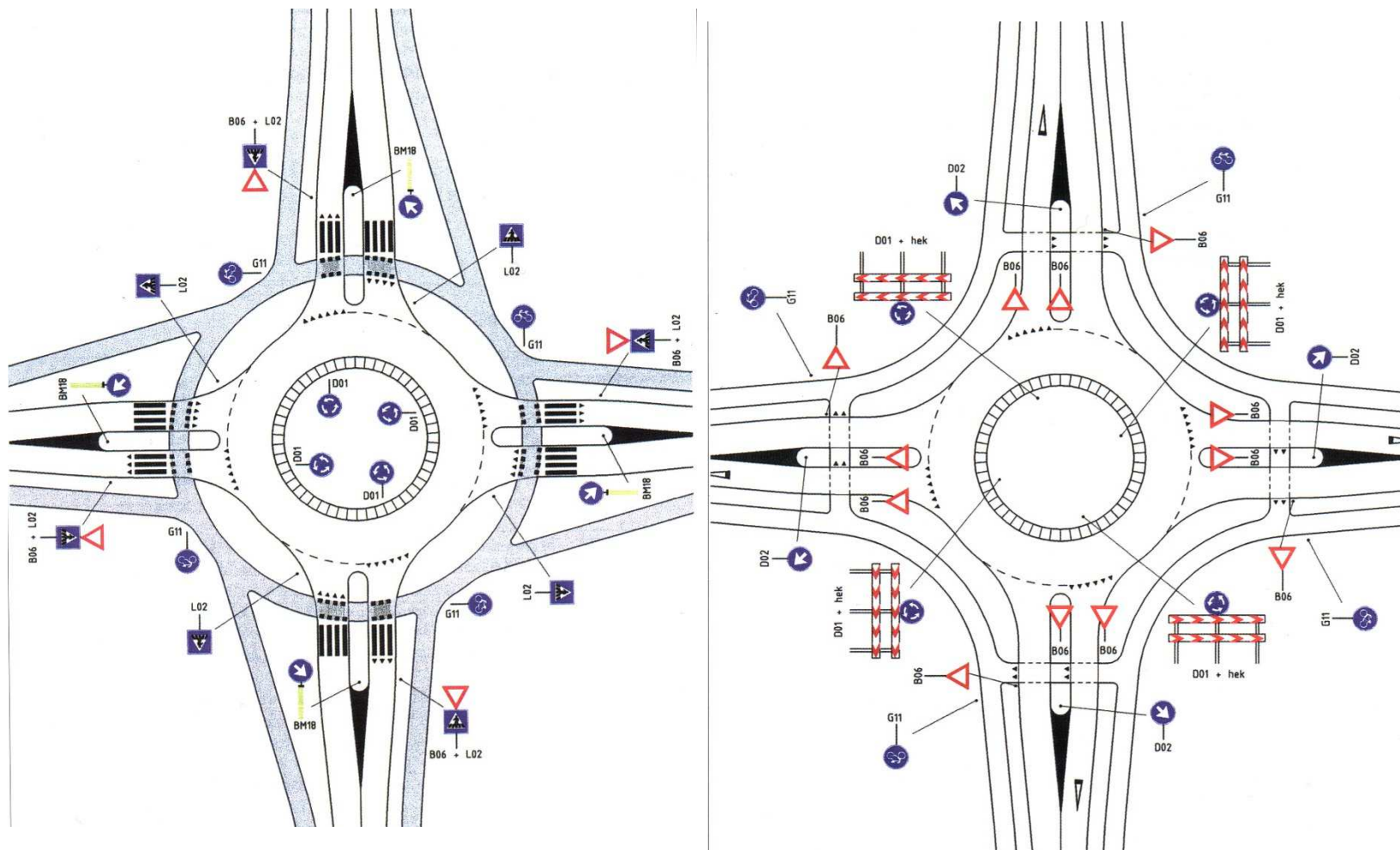

Tipologia di incidenti

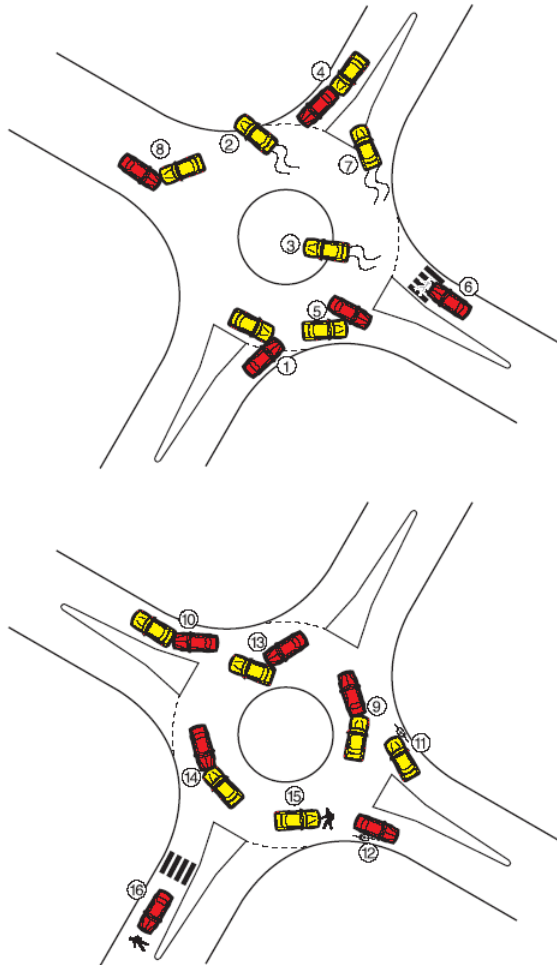

Collision Type	France	Queensland (Australia)	United Kingdom ¹
1. Failure to yield at entry (entering-circulating)	36.6%	50.8%	71.1%
2. Single-vehicle run off the circulatory roadway	16.3%	10.4%	8.2% ²
3. Single vehicle loss of control at entry	11.4%	5.2%	²
4. Rear-end at entry	7.4%	16.9%	7.0% ³
5. Circulating-exiting	5.9%	6.5%	
6. Pedestrian on crosswalk	5.9%		3.5% ⁴
7. Single vehicle loss of control at exit	2.5%	2.6%	²
8. Exiting-entering	2.5%		
9. Rear-end in circulatory roadway	0.5%	1.2%	
10. Rear-end at exit	1.0%	0.2%	
11. Passing a bicycle at entry	1.0%		
12. Passing a bicycle at exit	1.0%		
13. Weaving in circulatory roadway	2.5%	2.0%	
14. Wrong direction in circulatory roadway	1.0%		
15. Pedestrian on circulatory roadway	3.5%		⁴
16. Pedestrian at approach outside crosswalk	1.0%		⁴
Other collision types		2.4%	10.2%
Other sideswipe crashes		1.6%	

Notes:

1. Data are for "small" roundabouts (curbed central islands > 4 m [13 ft] diameter, relatively large ratio of inscribed circle diameter to central island size)

2. Reported findings do not distinguish among single-vehicle crashes.

3. Reported findings do not distinguish among approaching crashes.

4. Reported findings do not distinguish among pedestrian crashes.

Sources: France (12), Australia (13), United Kingdom (1)

Congruenza delle velocità operative

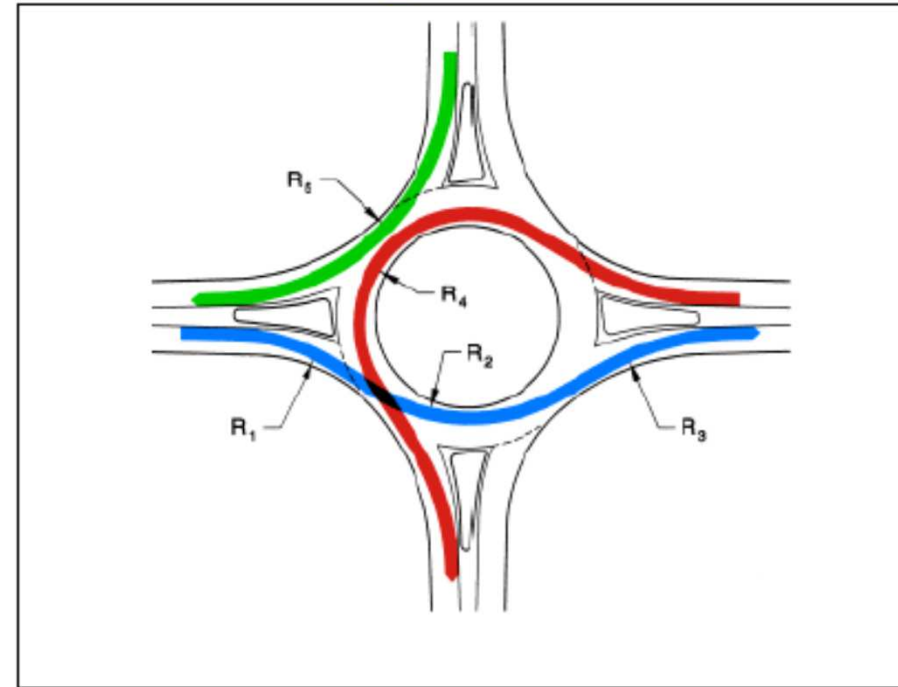
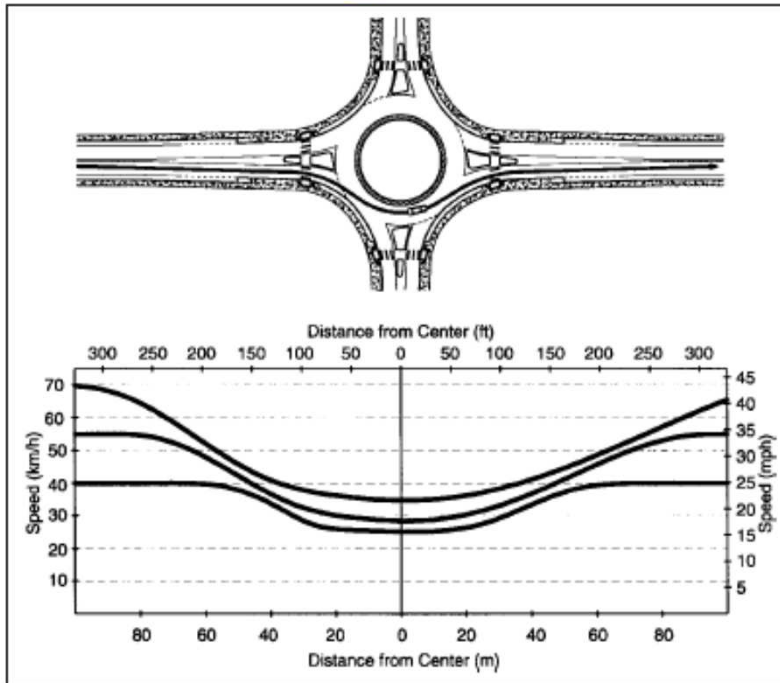

$$R_1 < R_2 < R_3$$

Site Category	Recommended Maximum Entry Design Speed
Mini-Roundabout	25 km/h (15 mph)
Urban Compact	25 km/h (15 mph)
Urban Single Lane	35 km/h (20 mph)
Urban Double Lane	40 km/h (25 mph)
Rural Single Lane	40 km/h (25 mph)
Rural Double Lane	50 km/h (30 mph)

Modelli di incidentalità (1)

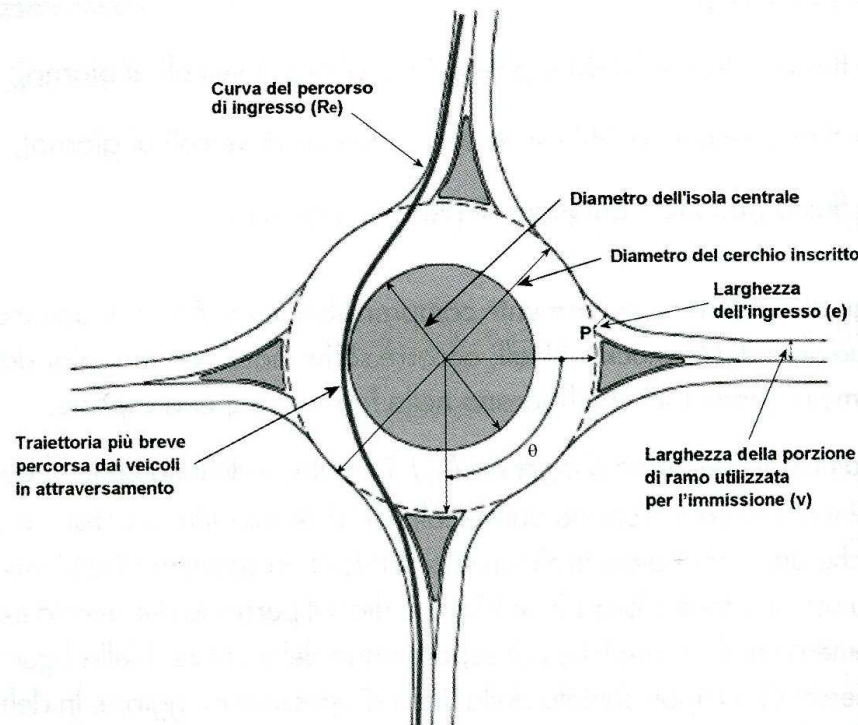

Modello di Maycock ed Hall

1) Incidenti tra veicoli entranti e circolanti

$$A = 0,052 \cdot Q_e^{0.7} \cdot Q_c^{0.4} \cdot \exp\left(-40 \cdot C_e + 0,14 \cdot e - 0,007 \cdot e \cdot v - \frac{1}{1 + \exp(4 \cdot R - 7)} + 0,2 \cdot P_m - 0,01 \cdot \theta\right)$$

dove:

- > A = incidenti annui (con feriti e/o morti) per ramo della rotatoria;
- > Q_e = flusso entrante (TGM espresso in migliaia di veicoli al giorno);
- > Q_c = flusso circolante (TGM espresso in migliaia di veicoli al giorno);
- > C_e = curvatura del percorso in ingresso = $1 / R_e$;
- > R_e = raggio della traiettoria più breve percorsa dai veicoli in ingresso (m);
- > e = larghezza dell'entrata (m);
- > v = larghezza della porzione di ramo utilizzata per l'immissione (m);
- > R = rapporto tra il diametro della corona giratoria e il diametro dell'isola centrale;
- > P_m = percentuale di motocicli (%);
- > θ = angolo formato con il ramo successivo, misurato da asse ad asse (gradi).

Modelli di incidentalità (2)

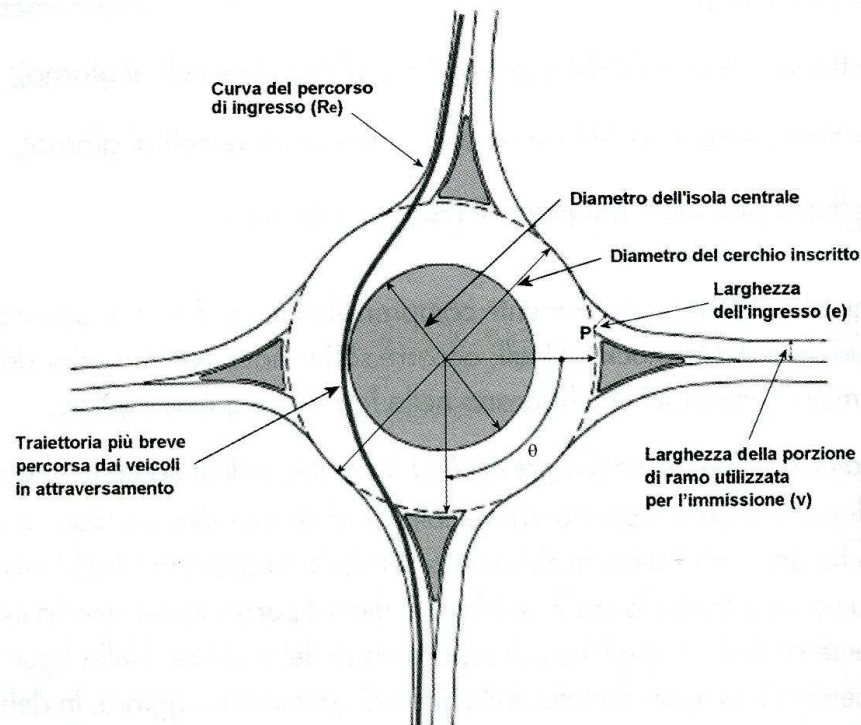

2) Incidenti in entrata

$$A = 0,0057 \cdot Q_e^{1,7} \cdot \exp(20 \cdot C_e - 0,1 \cdot e)$$

dove:

- A = incidenti annui (con feriti e/o morti) per ingresso o ramo della rotatoria;
- Q_e = flusso entrante (TGM espresso in migliaia di veicoli al giorno);
- C_e = curvatura del percorso in ingresso = $1 / R_e$;
- R_e = raggio della traiettoria più breve percorsa dai veicoli in ingresso (m);
- e = larghezza dell'entrata (m).

Modello di Maycock ed Hall

Modelli di incidentalità (3)

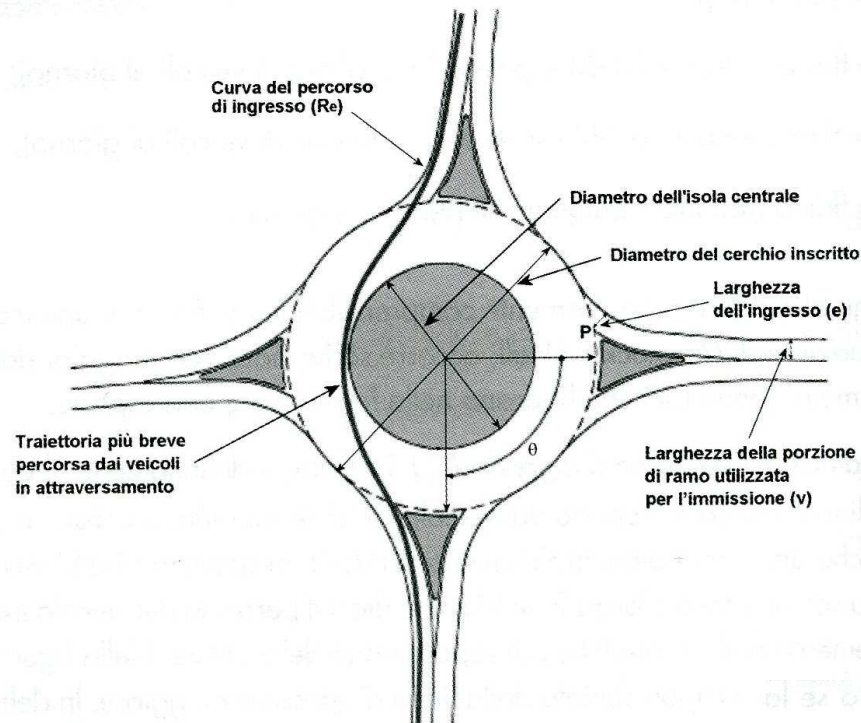

3) Incidenti relativi al veicolo isolato

$$A = 0,0064 \cdot Q_e^{0,8} \cdot \exp(25 \cdot C_e + 0,2 \cdot v - 45 \cdot C_a)$$

dove:

- > A = incidenti annui (con feriti e/o morti) per ingresso o ramo della rotatoria;
- > Q_e = flusso entrante (TGM espresso in migliaia di veicoli al giorno);
- > C_e = curvatura del percorso in ingresso = $1/R_e$;
- > R_e = raggio della traiettoria più breve percorsa dai veicoli in ingresso (m);
- > v = larghezza della porzione di ramo utilizzata per l'immissione (m);
- > C_a = curvatura del ramo d'ingresso = $1/R_a$;
- > R_a = raggio del ramo d'ingresso (m) (definito come il raggio della curva più vicina all'intersezione all'interno dello spazio compreso tra 50 m e 500 m dalla linea del "dare precedenza").

Modello di Maycock ed Hall

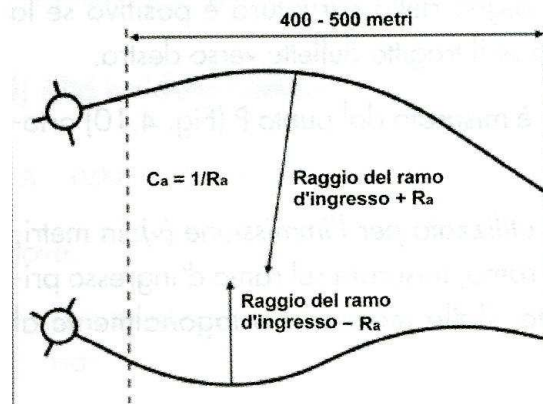

Modelli di incidentalità (4)

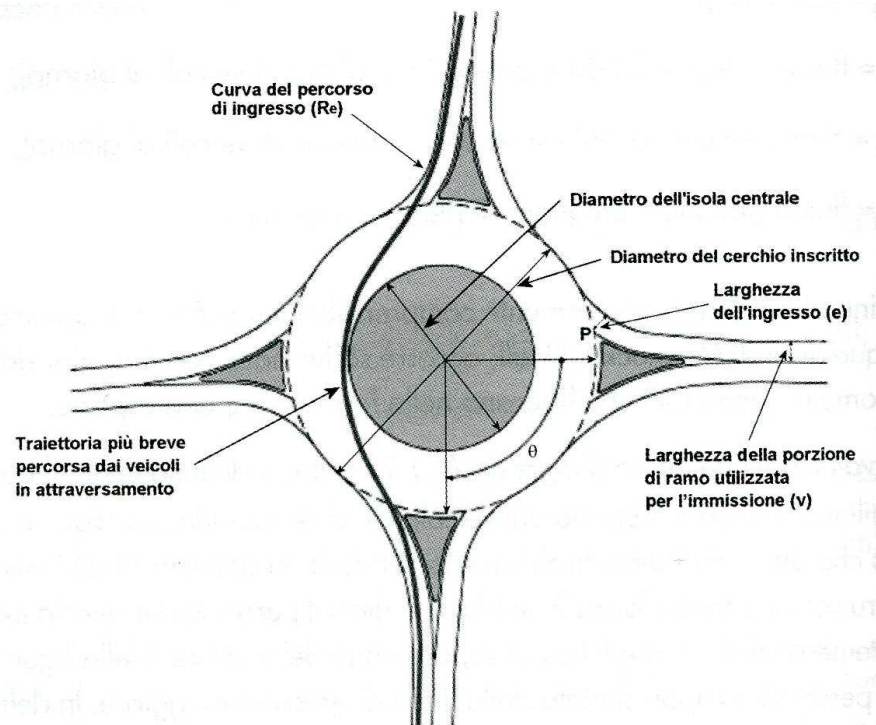

4) Altri incidenti (veicolari)

$$A = 0,0026 \cdot Q_{ec}^{0.8} \cdot \exp(0.2 \cdot P_m)$$

dove:

- > A = incidenti annui (con feriti e/o morti) per ingresso o ramo della rotatoria;
- > $Q_{ec} = Q_e \cdot Q_c$
- > Q_e = flusso entrante (TGM espresso in migliaia di veicoli al giorno);
- > Q_c = flusso circolante (TGM espresso in migliaia di veicoli al giorno);
- > P_m = percentuale di motocicli (%).

Modello di Maycock ed Hall

Modelli di incidentalità (5)

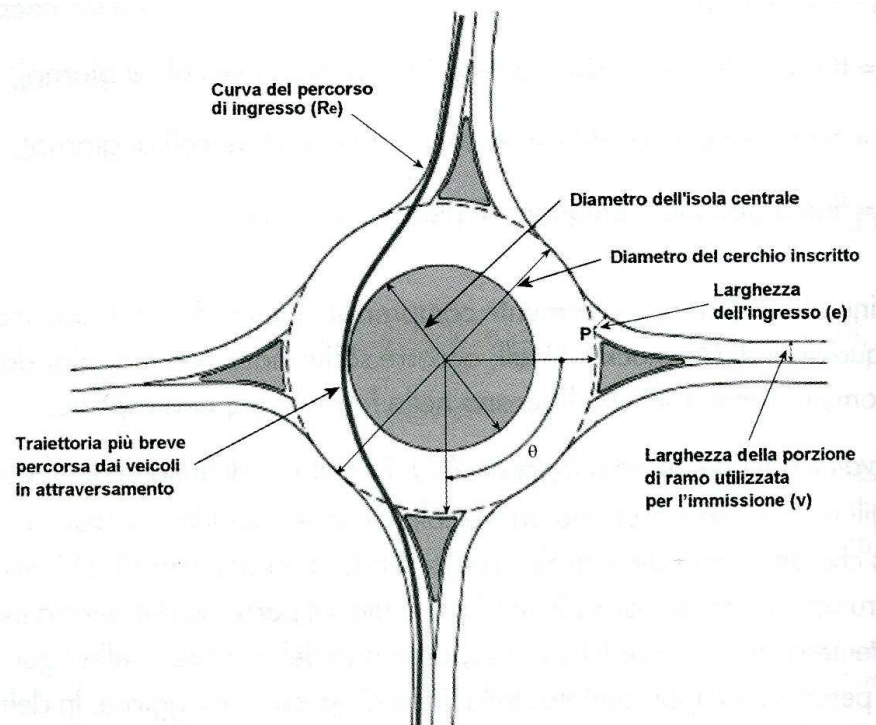

5) Incidenti tra veicoli e pedoni

$$A = 0,029 \cdot Q_{ep}^{0.5}$$

dove:

- > A = incidenti annui (con feriti e/o morti) per ingresso o ramo della rotonda;
- > $Q_{ep} = (Q_e + Q_{ex}) \cdot Q_p$
- > Q_e = flusso entrante (TGM espresso in migliaia di veicoli al giorno);
- > Q_{ex} = flusso uscente (TGM espresso in migliaia di veicoli al giorno);
- > Q_p = flusso pedonale (migliaia di pedoni al giorno).

Modello di Maycock ed Hall

Posizionamento rotatorie

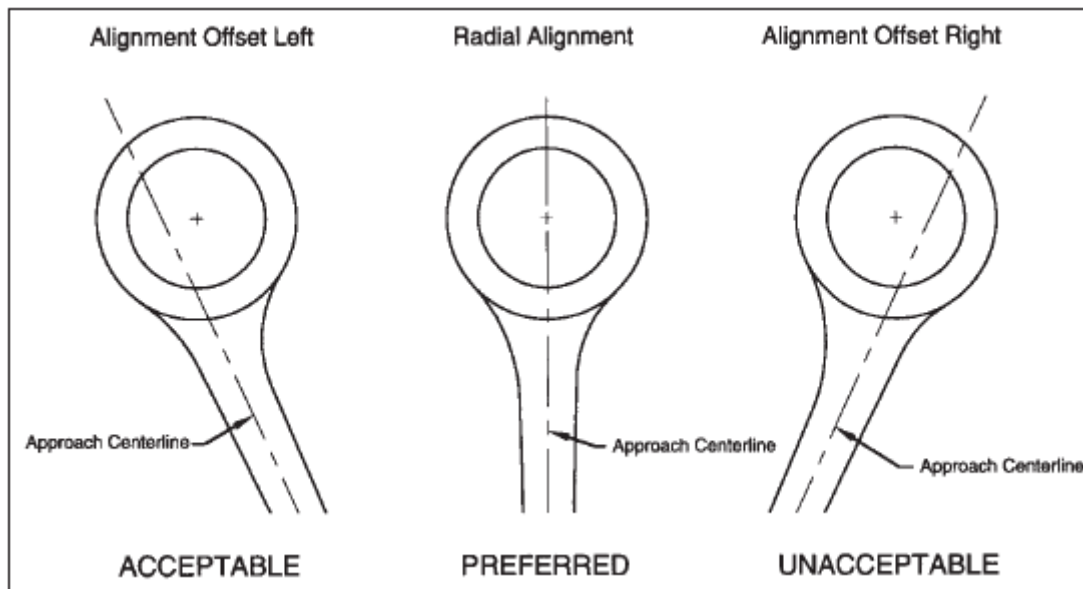

È opportuno evitare un posizionamento dell'incrocio in curva o all'uscita da una curva; in particolare la posizione dell'isola centrale è ottimale quando tutti gli assi dei bracci che confluiscono nella rotatoria passano per il centro della rotatoria stessa

È opportuno escludere una configurazione dell'approccio alla rotatoria in “curva e contro-curva”; è opportuno non posizionare dei filari di alberi lungo i bracci di accesso alla rotatoria che possono dare l'illusione di continuità dell'itinerario; è da escludere un'isola centrale di forma non circolare; è da escludere un anello di larghezza variabile; è da escludersi una pendenza dell'anello circolare verso l'interno della rotatoria; è da evitare la presenza di una corsia specializzata per la svolta a destra sull'anello.

Elementi funzionali delle rotatorie

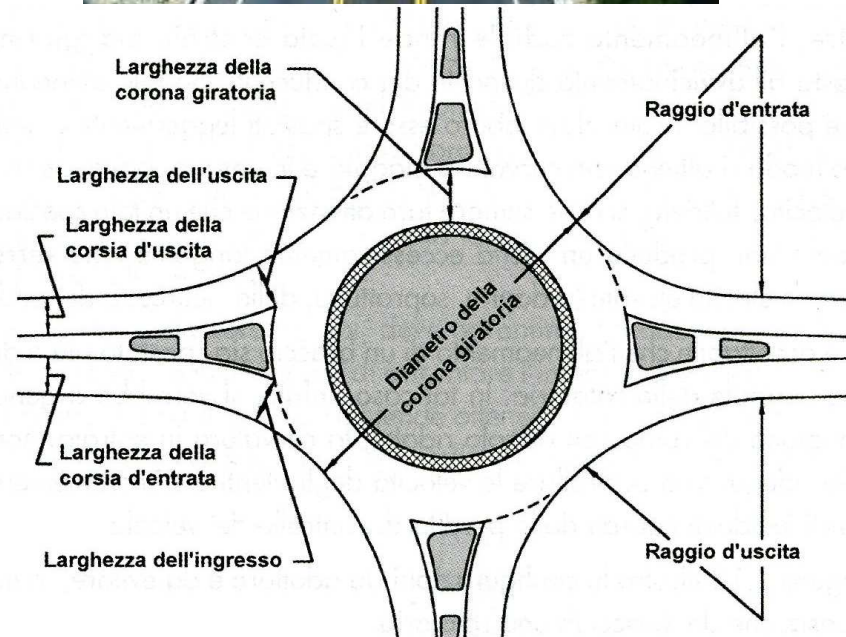
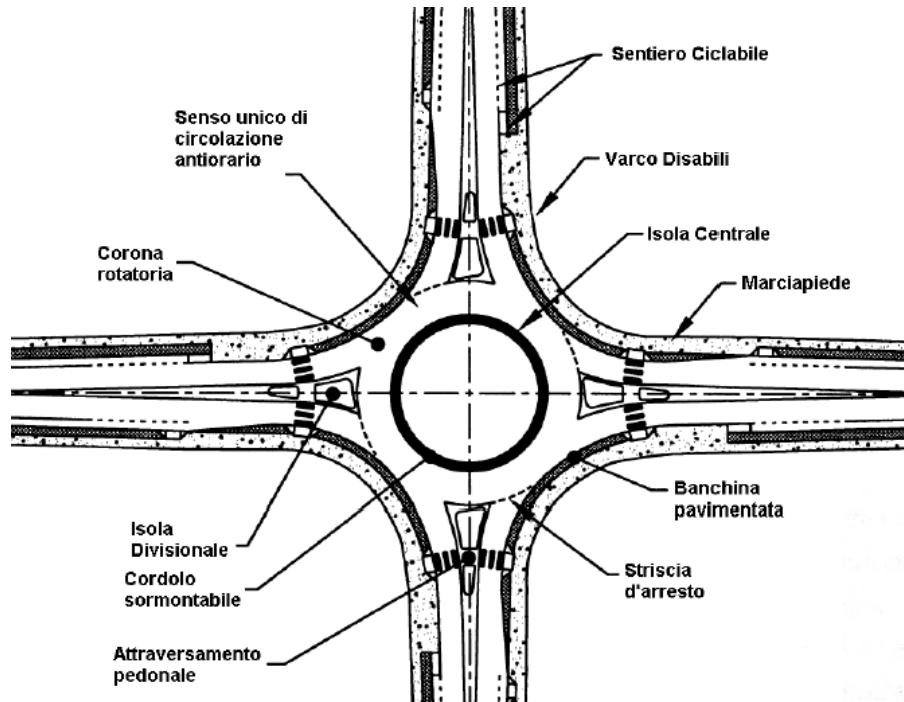

Geometria delle rotatorie (1)

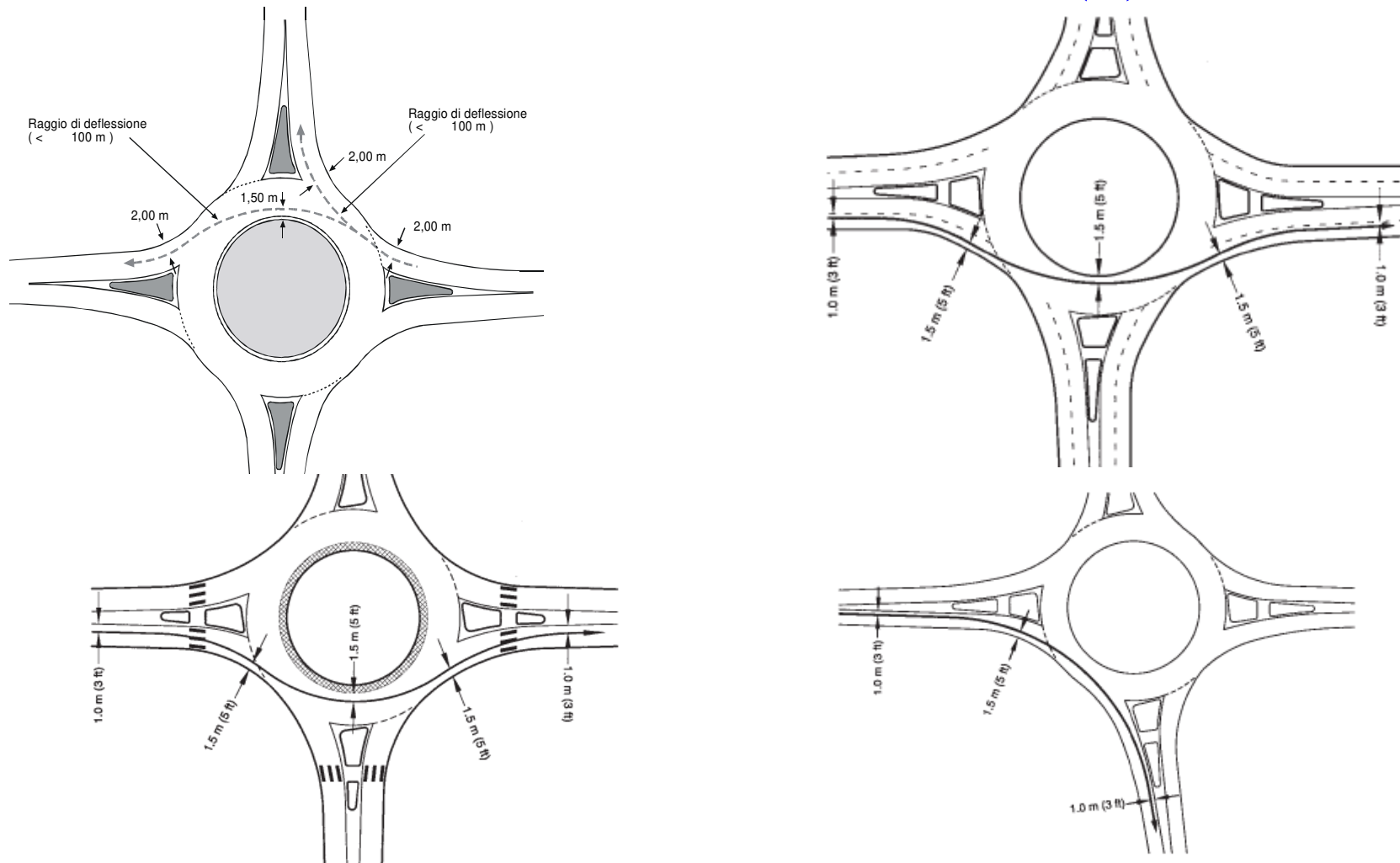

Geometria delle rotatorie (2)

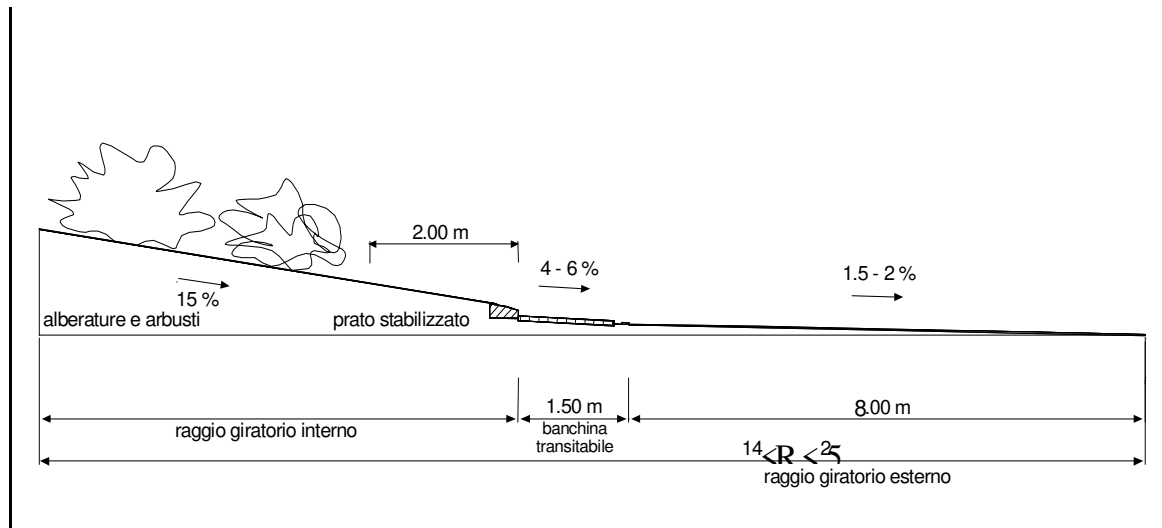

$$V = \sqrt{127 \cdot R(f + q)}$$

V (km/h)	25	40	60	80	100	120	140
Strade D, E, F urbane	0,22	0,21	0,20	0,16			
Strade A, B, C, F extr.		0,21	0,17	0,13	0,11	0,10	0,09

Geometria delle rotatorie (3)

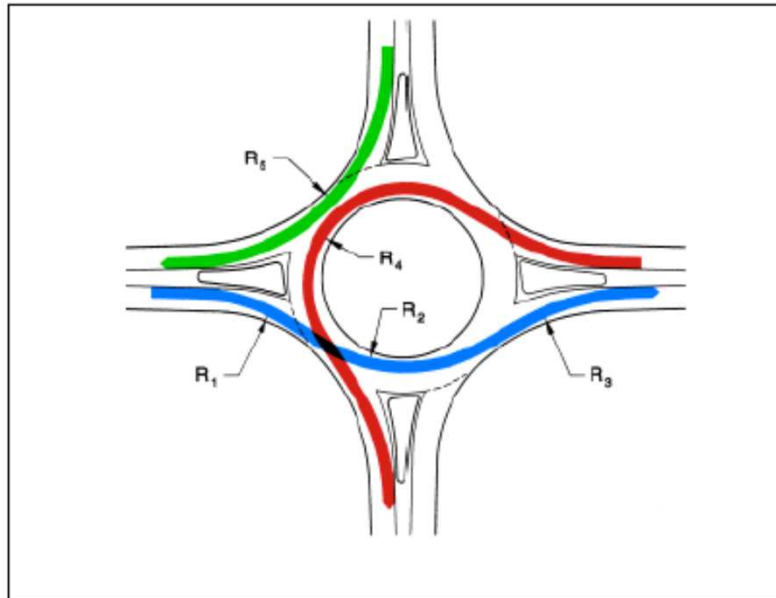

Geometria delle rotatorie (4)

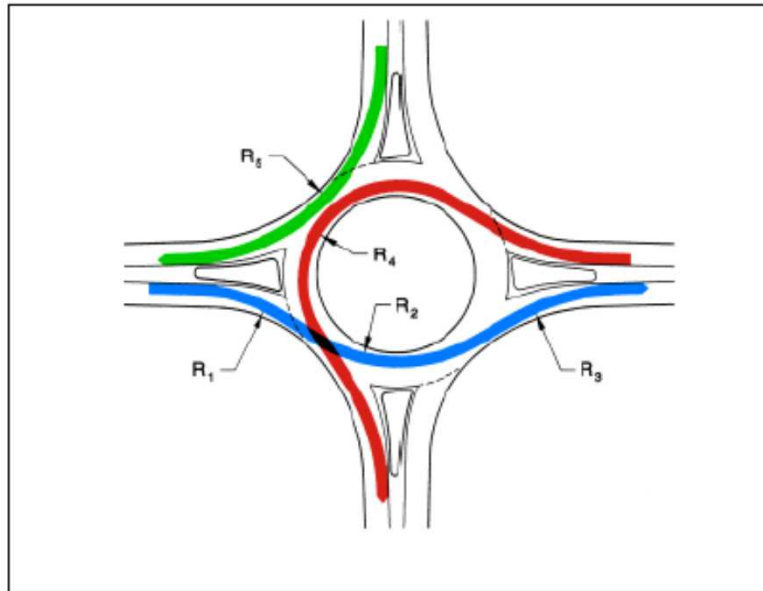

Inscribed Circle Diameter (m)	Approximate R_4 Value		Maximum R_1 Value	
	Radius (m)	Speed (km/h)	Radius (m)	Speed (km/h)
Single-Lane Roundabout				
30	11	21	54	41
35	13	23	61	43
40	16	25	69	45
45	19	26	73	46
Double-Lane Roundabout				
45	15	24	65	44
50	17	25	69	45
55	20	27	78	47
60	23	28	83	48
65	25	29	88	49
70	28	30	93	50

$$R_5 \leq R_1$$

$$R_5 \leq R^* = R_4 + 20$$

R^* è il raggio che consente una velocità corrispondente a $R_4 + 20$ km/h

Geometria delle rotatorie (5)

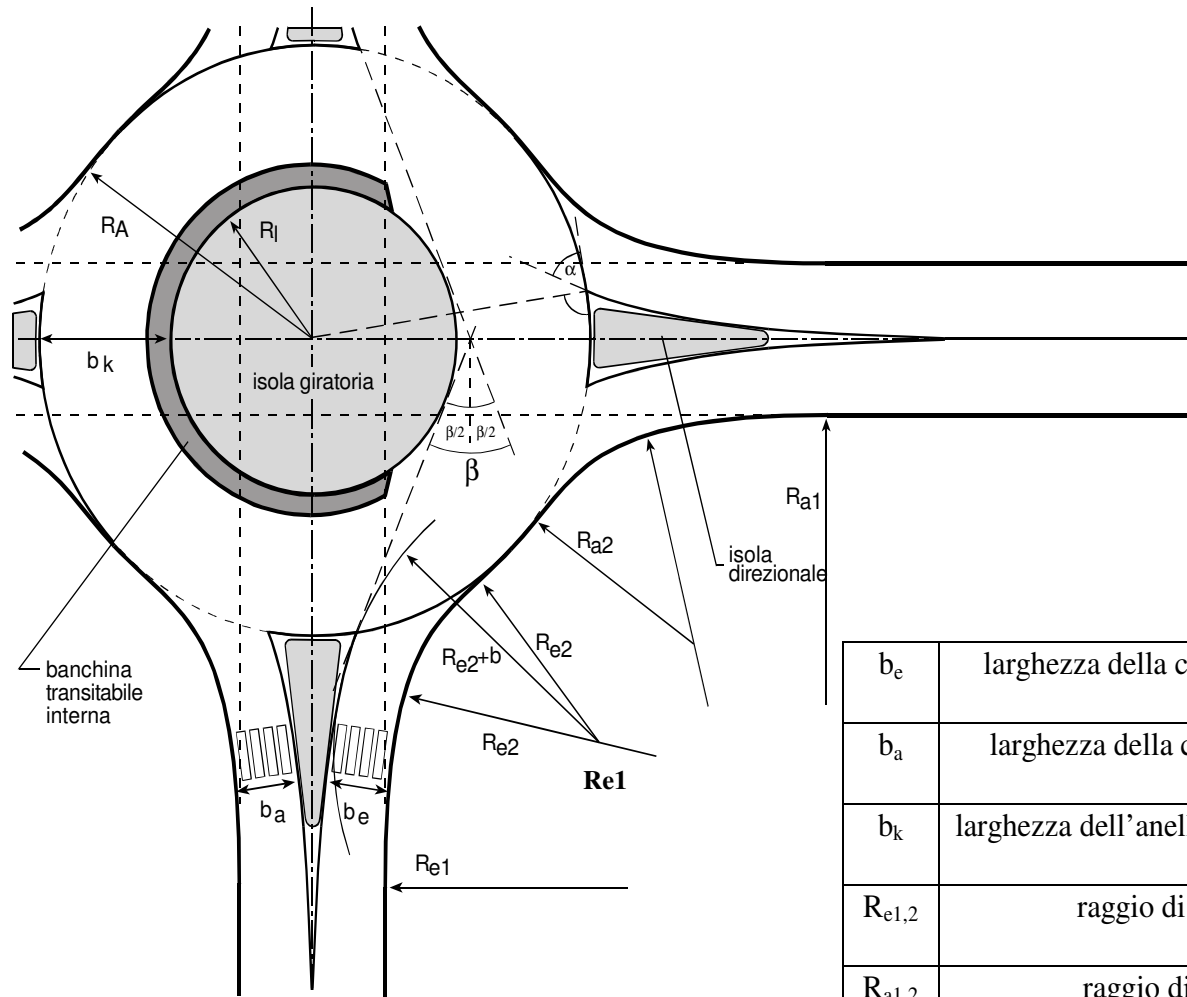

b_e	larghezza della corsia in entrata	R_A	raggio esterno
b_a	larghezza della corsia in uscita	R_I	raggio interno
b_k	larghezza dell'anello di circolazione	α	angolo d'entrata
$R_{e1,2}$	raggio di entrata	β	angolo di deviazione
$R_{a1,2}$	raggio di uscita	b	arretramento di R_{e2}

Geometria delle rotatorie (6)

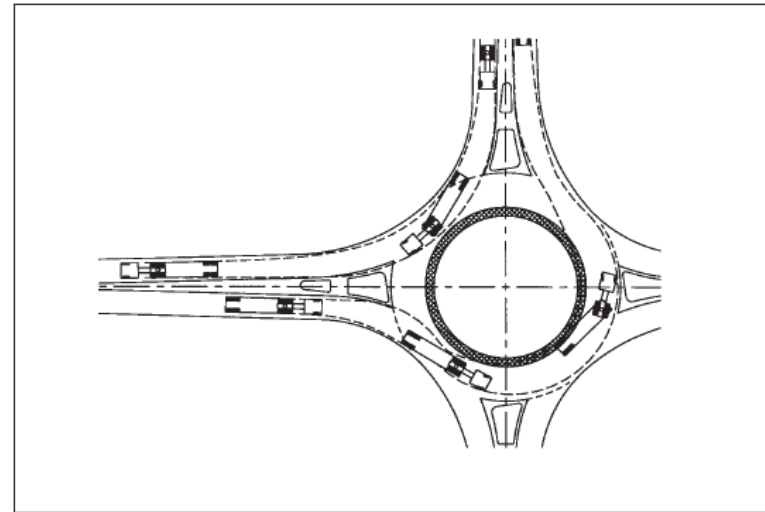
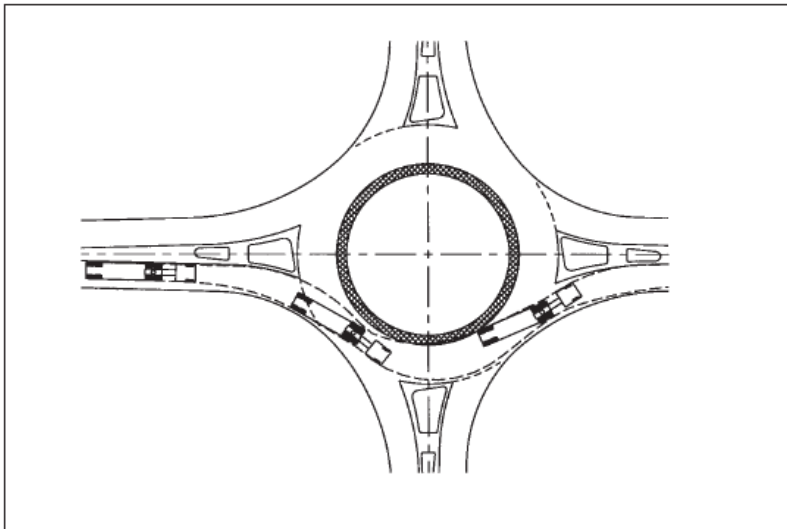

Site Category	Typical Design Vehicle	Inscribed Circle Diameter Range*
Mini-Roundabout	Single-Unit Truck	13–25m (45–80 ft)
Urban Compact	Single-Unit Truck/Bus	25–30m (80–100 ft)
Urban Single Lane	WB-15 (WB-50)	30–40m (100–130 ft)
Urban Double Lane	WB-15 (WB-50)	45–55m (150–180 ft)
Rural Single Lane	WB-20 (WB-67)	35–40m (115–130 ft)
Rural Double Lane	WB-20 (WB-67)	55–60m (180–200 ft)

* Assumes 90-degree angles between entries and no more than four legs.

Geometria delle rotatorie (7)

Metric

Design Vehicle Type	Symbol	Dimensions (m)											Typical Kingpin to Center of Rear Axle	
		Overall			Overhang		WB ₁	WB ₂	S	T	WB ₃	WB ₄		
		Height	Width	Length	Front	Rear								
Passenger Car	P	1.3	2.1	5.8	0.9	1.5	3.4	-	-	-	-	-	-	-
Single Unit Truck	SU	3.4-4.1	2.4	9.2	1.2	1.8	6.1	-	-	-	-	-	-	-
Buses														
Inter-city Bus (Motor Coaches)	BUS-12	3.7	2.6	12.2	1.8	1.9 ^a	7.3	1.1	-	-	-	-	-	-
	BUS-14	3.7	2.6	13.7	1.8	2.6 ^a	8.1	1.2	-	-	-	-	-	-
City Transit Bus	CITY-BUS	3.2	2.6	12.2	2.1	2.4	7.6	-	-	-	-	-	-	-
Conventional School Bus (65 pass.)	S-BUS 11	3.2	2.4	10.9	0.8	3.7	6.5	-	-	-	-	-	-	-
Large School Bus (84 pass.)	S-BUS 12	3.2	2.4	12.2	2.1	4.0	6.1	-	-	-	-	-	-	-
Articulated Bus	A-BUS	3.4	2.6	18.3	2.6	3.1	6.7	5.9	1.9 ^b	4.0 ^c	-	-	-	-
Trucks														
Intermediate Semitrailer	WB-12	4.1	2.4	13.9	0.9	0.8 ^d	3.8	8.4	-	-	-	-	-	8.4
Intermediate Semitrailer	WB-15	4.1	2.6	16.8	0.9	0.6 ^e	4.5	10.8	-	-	-	-	-	11.4
Interstate Semitrailer	WB-19*	4.1	2.6	20.9	1.2	0.8 ^d	6.6	12.3	-	-	-	-	-	13.0
Interstate Semitrailer	WB-20**	4.1	2.6	22.4	1.2	1.4-0.8 ^d	6.6	13.2-13.8	-	-	-	-	-	13.9-14.5
"Double-Bottom" Semitrailer/Trailer	WB-20D	4.1	2.6	22.4	0.7	0.9	3.4	7.0	0.9 ^e	2.1 ^f	7.0	-	-	7.0
Triple-Semitrailer/Trailers	WB-30T	4.1	2.6	32.0	0.7	0.9	3.4	6.9	0.9 ^d	2.1 ^d	7.0	7.0	7.0	7.0
Turnpike Double-Semitrailer/Trailer	WB-33D*	4.1	2.6	34.8	0.7	0.8 ^d	4.4	12.2	0.8 ^d	3.1 ^g	13.6	-	-	13.0
Recreational Vehicles														
Motor Home	MH	3.7	2.4	9.2	1.2	1.8	6.1	-	-	-	-	-	-	-
Car and Camper Trailer	P/T	3.1	2.4	14.8	0.9	3.1	3.4	-	1.5	5.8	-	-	-	-
Car and Boat Trailer	P/B	-	2.4	12.8	0.9	2.4	3.4	-	1.5	4.6	-	-	-	-
Motor Home and Boat Trailer	MH/B	3.7	2.4	16.2	1.2	2.4	6.1	-	1.8	4.6	-	-	-	-
Farm Tractor ^f	TR	3.1	2.4-3.1	4.9 ^g	-	-	3.1	2.7	0.9	2.0	-	-	-	-

Note: Since vehicles are manufactured in U.S. Customary dimensions and to provide only one physical size for each design vehicle, the values shown in the design vehicle drawings have been soft converted from numbers listed in feet, and then the numbers in this table have been rounded to the nearest tenth of a meter.

- * = Design vehicle with 14.63 m trailer as adopted in 1982 Surface Transportation Assistance Act (STAA).
- ** = Design vehicle with 16.16 m trailer as grandfathered in with 1982 Surface Transportation Assistance Act (STAA).
- ^a = This is overhang from the back axle of the tandem axle assembly.
- ^b = Combined dimension is 5.91 m and articulating section is 1.22 m wide.
- ^c = Combined dimension is typically 3.05 m.
- ^d = Combined dimension is typically 3.05 m.
- ^e = Combined dimension is typically 3.81 m.
- ^f = Dimensions are for a 150-200 hp tractor excluding any wagon length.
- ^g = To obtain the total length of tractor and one wagon, add 5.64 m to tractor length. Wagon length is measured from front of drawbar to rear of wagon, and drawbar is 1.98 m long.
 - WB₁, WB₂, and WB₄ are the effective vehicle wheelbases, or distances between axle groups, starting at the front and working towards the back of each unit.
 - S is the distance from the rear effective axle to the hitch point or point of articulation.
 - T is the distance from the hitch point or point of articulation measured back to the center of the next axle or center of tandem axle assembly.

Geometria delle rotatorie (8)

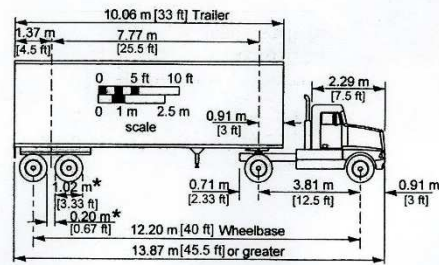

* Typical tire size and space between tires applies to all trailers.

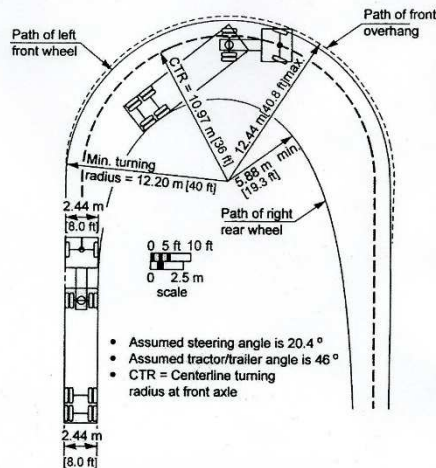

Exhibit 2-13. Minimum Turning Path for Intermediate Semitrailer (WB-12 [WB-40]) Design Vehicle

Design Vehicle Type	Passenger Car	Single Unit Truck	Inter-city Bus (Motor Coach)		City Transit Bus	Conventional School Bus (65 pass.)	Large ² School Bus (84 pass.)	Articulated Bus	Intermediate Semitrailer	Intermediate Semitrailer
Symbol	P	SU	BUS-12	BUS-14	CITY-BUS	S-BUS11	S-BUS12	A-BUS	WB-12	WB-15
Minimum Design Turning Radius (m)	7.3	12.8	13.7	13.7	12.8	11.9	12.0	12.1	12.2	13.7
Centerline ¹ Turning Radius (CTR) (m)	6.4	11.6	12.4	12.4	11.5	10.6	10.8	10.8	11.0	12.5
Minimum Inside Radius (m)	4.4	8.6	8.4	7.8	7.5	7.3	7.7	6.5	5.9	5.2
Design Vehicle Type	Interstate Semi-trailer	"Double Bottom" Combination	Triple Semi-trailer/trailer	Turnpike Double Semi-trailer/trailer	Motor Home	Car and Camper Trailer	Car and Boat Trailer	Motor Home and Boat Trailer	Farm Tractor w/One Wagon	
Symbol	WB-19*	WB-20**	WB-20D	WB-30T	WB-33D*	MH	P/T	P/B	MH/B	TR/W
Minimum Design Turning Radius (m)	13.7	13.7	13.7	13.7	18.3	12.2	10.1	7.3	15.2	5.5
Centerline ¹ Turning Radius (CTR) (m)	12.5	12.5	12.5	12.5	17.1	11.0	9.1	6.4	14.0	4.3
Minimum Inside Radius (m)	2.4	1.3	5.9	3.0	4.5	7.9	5.3	2.8	10.7	3.2

Note: Numbers in table have been rounded to the nearest tenth of a meter.
 * = Design vehicle with 14.63 m trailer as adopted in 1982 Surface Transportation Assistance Act (STAA).
 ** = Design vehicle with 18.16 m trailer as grandfathered in with 1982 Surface Transportation Assistance Act (STAA).
 1 = The turning radius assumed by a designer when investigating possible turning paths and is set at the centerline of the front axle of a vehicle. If the minimum turning path is assumed, the CTR approximately equals the minimum design turning radius minus one-half the front width of the vehicle.
 2 = School buses are manufactured from 42 passenger to 84 passenger sizes. This corresponds to wheelbase lengths of 3,350 mm to 6,020 mm, respectively. For these different sizes, the minimum design turning radii vary from 8.78 m to 12.01 m and the minimum inside radii vary from 4.27 m to 7.74 m.
 3 = Turning radius is for 150–200 hp tractor with one 5.64 m long wagon attached to hitch point. Front wheel drive is disengaged and without brakes being applied.

Exhibit 2-2. Minimum Turning Radii of Design Vehicles

Geometria delle rotatorie (9)

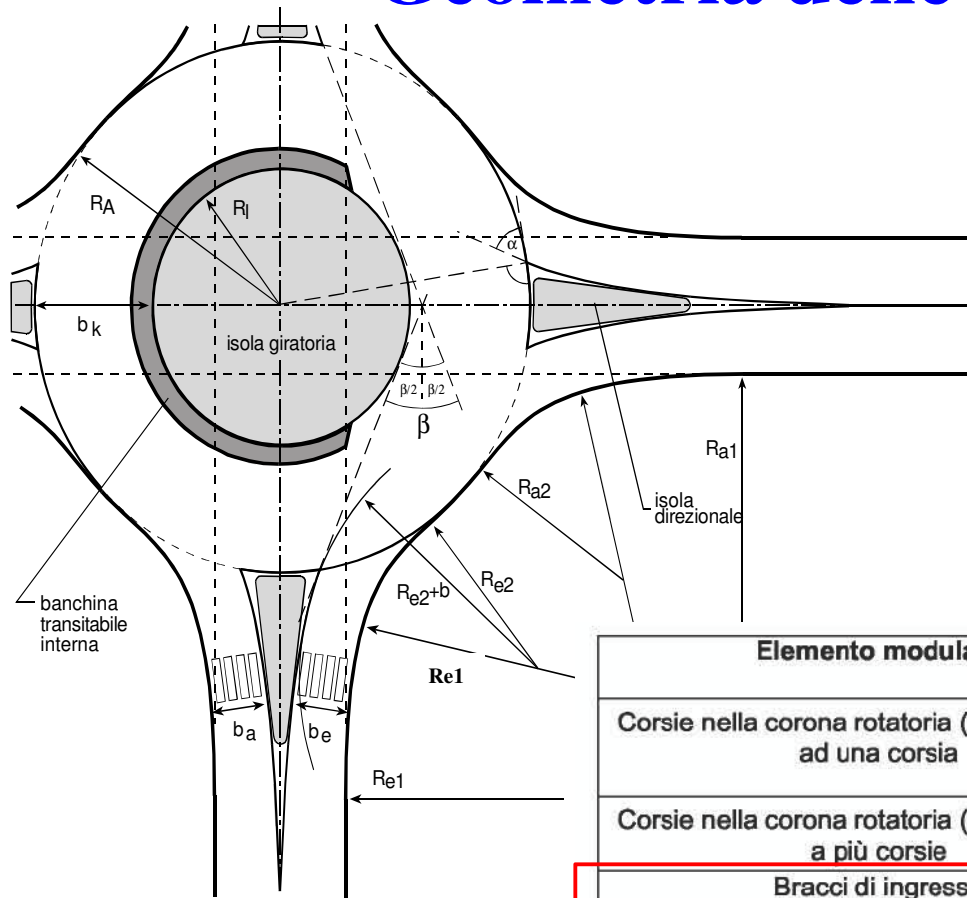

Elemento modulare	Diametro esterno della rotatoria (m)	Larghezza corsie (m)
Corsie nella corona rotatoria (*), per ingressi ad una corsia	≥ 40	6,00
	Compreso tra 25 e 40	7,00
	Compreso tra 14 e 25	7,00 - 8,00
Corsie nella corona rotatoria (*), per ingressi a più corsie	≥ 40	9,00
	< 40	8,50 - 9,00
Bracci di ingresso (**)		3,50 per una corsia 6,00 per due corsie
Bracci di uscita (*)	< 25	4,00
	≥ 25	4,50

(*) deve essere organizzata sempre su una sola corsia.
 (**) organizzati al massimo con due corsie.

Geometria delle rotatorie (10)

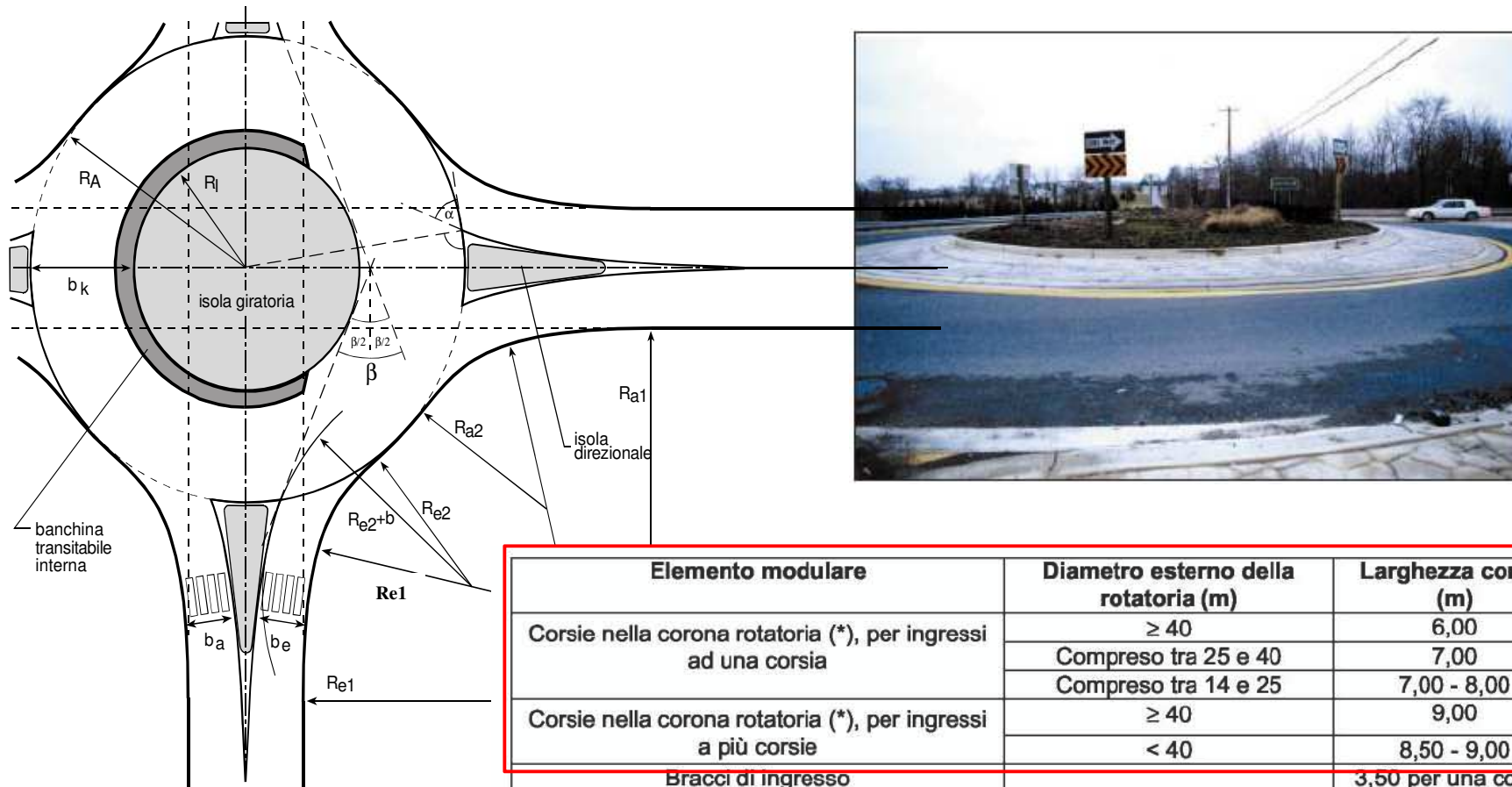

Elemento modulare	Diametro esterno della rotatoria (m)	Larghezza corsie (m)
Corsie nella corona rotatoria (*), per ingressi ad una corsia	≥ 40	6,00
	Compreso tra 25 e 40	7,00
	Compreso tra 14 e 25	7,00 - 8,00
Corsie nella corona rotatoria (*), per ingressi a più corsie	≥ 40	9,00
	< 40	8,50 - 9,00
Bracci di ingresso (**)		3,50 per una corsia 6,00 per due corsie
Bracci di uscita (*)	< 25	4,00
	≥ 25	4,50

(*) deve essere organizzata sempre su una sola corsia.

(**) organizzati al massimo con due corsie.

Geometria delle rotatorie (11)

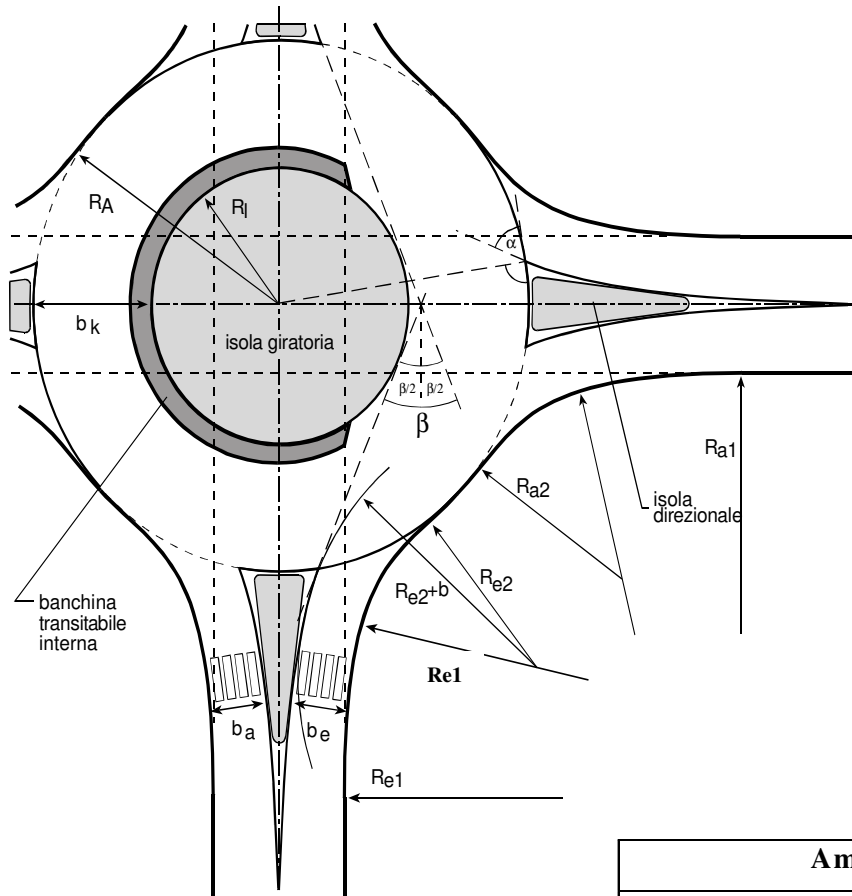

Re 1,2 – Il ciglio destro della carreggiata del braccio di ingresso è raccordato con il ciglio esterno dell'anello di circolazione centrale per mezzo di un raccordo costituito da due archi di cerchio.

Ambito urbano		Ambito extraurbano	
$R_{e,2}$ [m]	10,00	$R_{e,2}$ [m]	12,00
$R_{e,1}$ [m]	$5 \cdot R_{e,2}$	$R_{e,1}$ [m]	$5 \cdot R_{e,2}$

Geometria delle rotatorie (12)

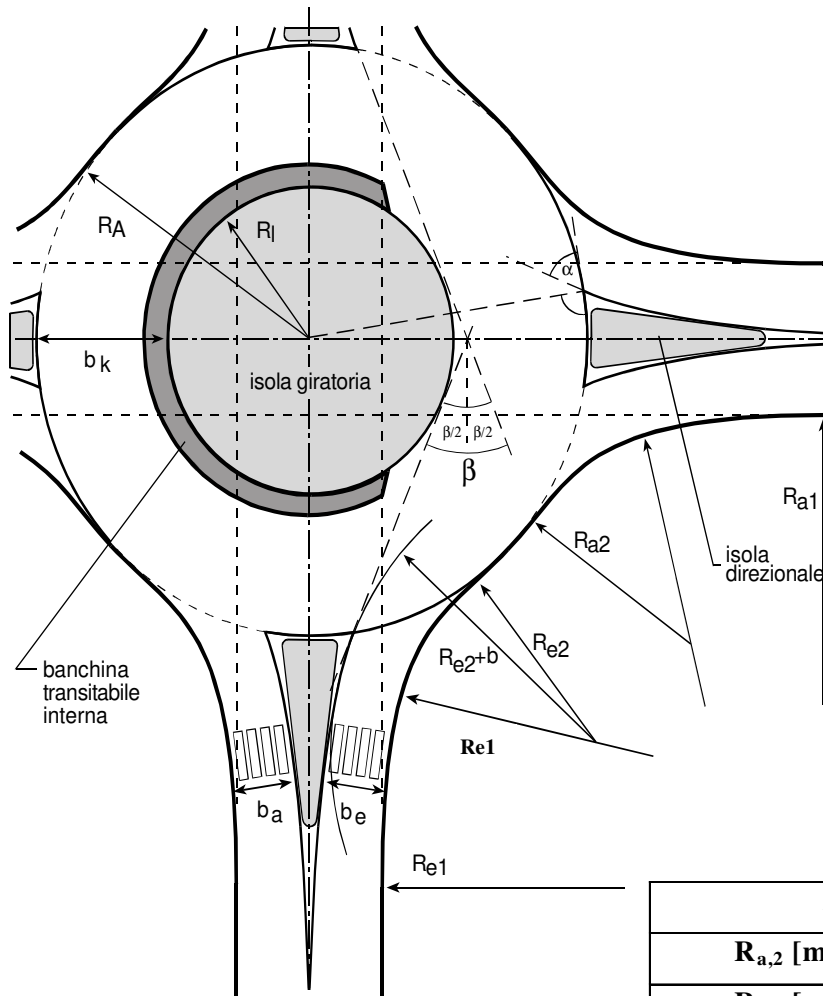

R_a 1,2 – Il ciglio destro dell’anello di circolazione è raccordato con il ciglio della carreggiata del braccio di uscita per mezzo del raggio di uscita **R_a**. In analogia con quanto detto per il raggio di entrata, la geometria del bordo di connessione adotta una curva costituita da due archi di cerchio

Ambito urbano		Ambito extraurbano	
R_{a,2} [m]	12,00	R_{a,2} [m]	14,00
R_{a,1} [m]	4·R_{e,2}	R_{a,1} [m]	4·R_{e,2}

Geometria delle rotatorie (13)

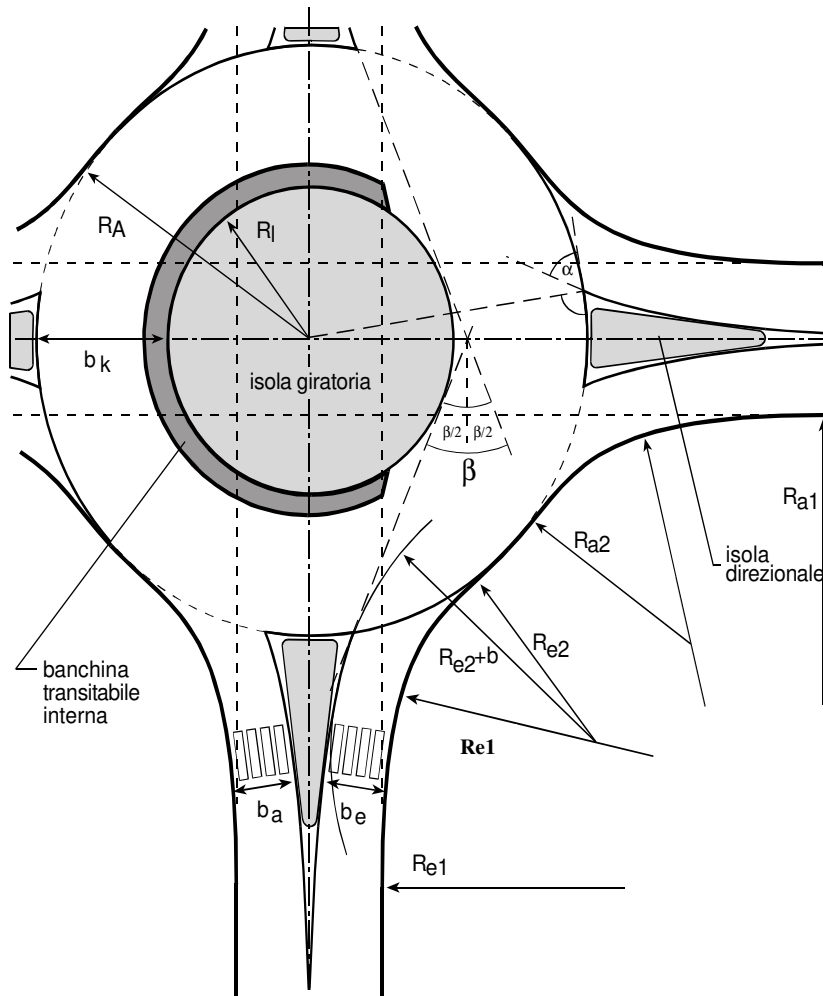

La valutazione del valore della deviazione viene effettuata per mezzo dell'angolo di deviazione β . Per determinare la tangente al ciglio dell'isola centrale corrispondente all'angolo di deviazione β , bisogna aggiungere, al raggio di entrata $R_{e,2}$, un incremento b pari a 3,50 m. Per ciascun braccio di immissione si raccomanda un valore dell'angolo di deviazione β di almeno 45°

Geometria delle rotatorie (13)

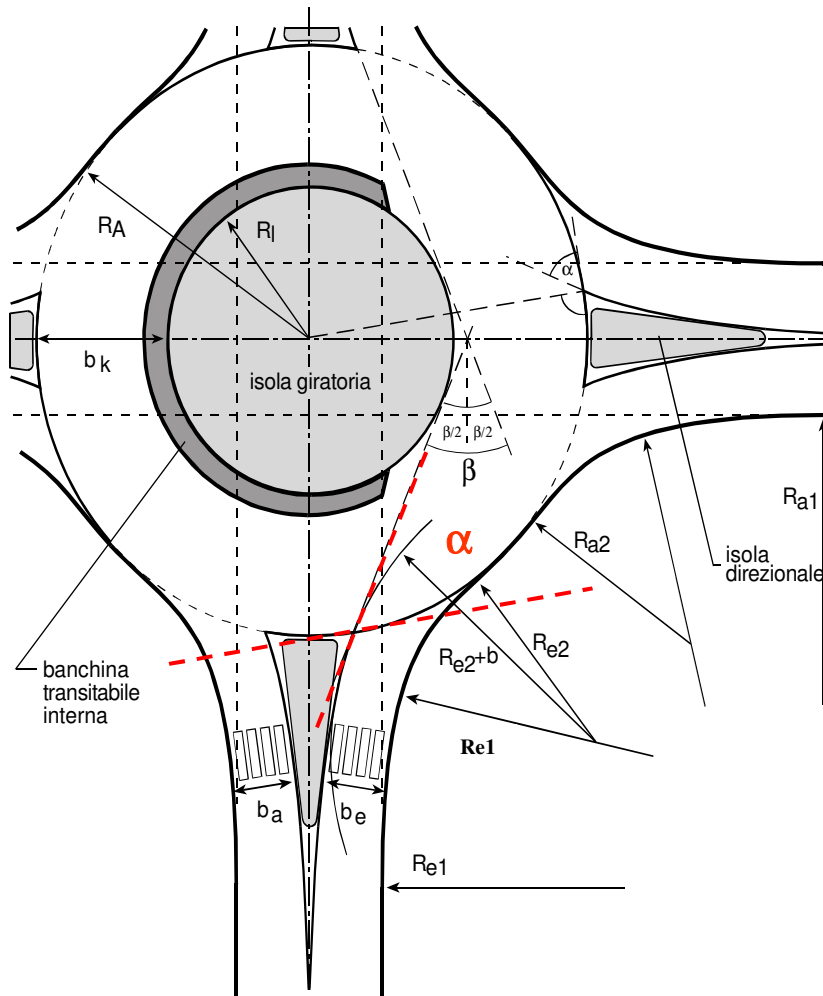

α – L'angolo di entrata α caratterizza l'angolo d'intersezione tra la direzione di ingresso e la tangente all'anello di circolazione; tale angolo dovrebbe assumere valori tra a 80° e 90° per evitare velocità elevate e il mancato rispetto della precedenza; se non si possono evitare angoli di entrata minori di 70° è opportuno, per ragioni di sicurezza, realizzare una deviazione ben marcata per mezzo di un angolo $\beta > 45^\circ$.

Geometria delle rotatorie (14)

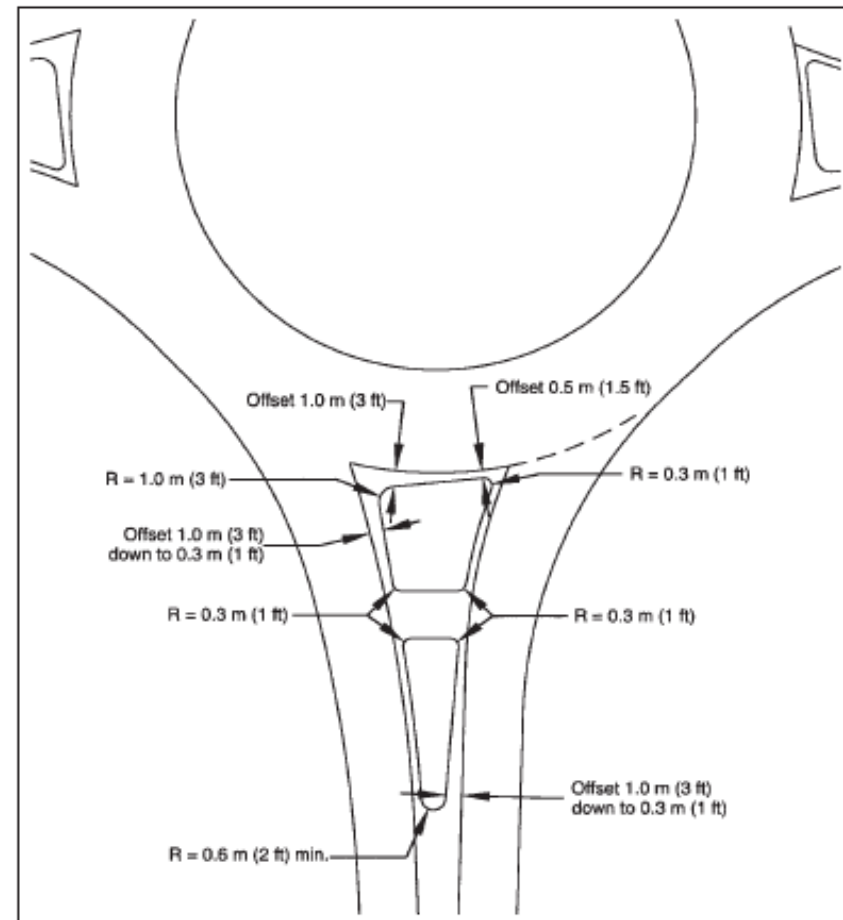
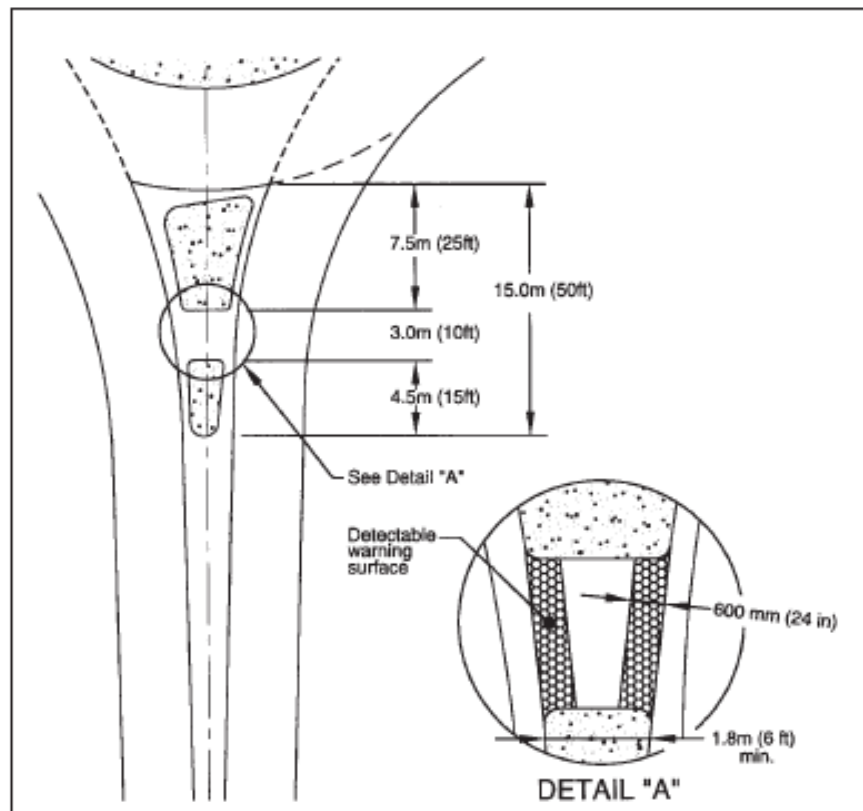

Geometria delle rotatorie (15)

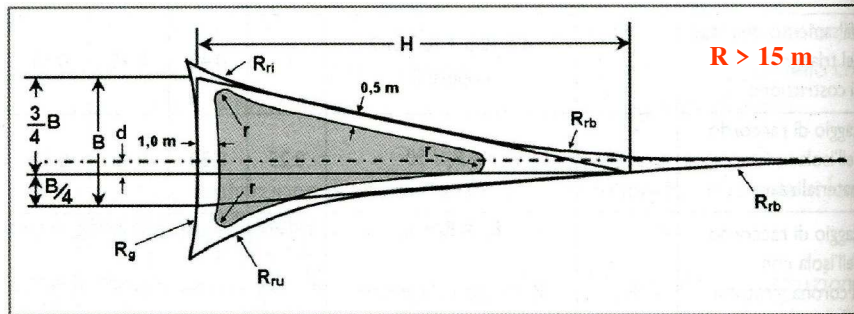
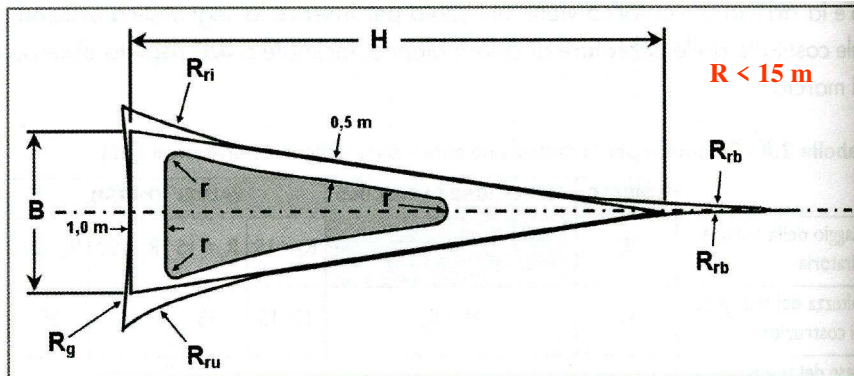

	SIMBOLO	ESPRESSIONE DI CALCOLO	VALORI (METRI)			
Raggio della corona giratoria	R_g		$R_g < 15$	$R_g = 15$	$R_g = 20$	$R_g = 25$
Altezza del triangolo di costruzione	H	$H = R_g$	12÷15	15	20	25
Base del triangolo di costruzione	B	$B = R_g / 4$	3÷3,75	3,75	5,00	6,25
Sfalsamento dell'asse del triangolo di costruzione	d	$d = (0,5 + R_g/50)/2$ oppure 0	0	0,40	0,45	0,50
Raggio di raccordo dell'isola materializzata	r	$r = R_g / 50$	0,25	0,30	0,40	0,50
Raggio di raccordo dell'isola con la corona giratoria (in prossimità dell'ingresso)	R_{ri}	$R_{ri} = R_i + L_i$ R_i = raggio d'ingresso L_i = larghezza dell'entrata				
Raggio di raccordo dell'isola con la corona giratoria (in prossimità dell'uscita)	R_{ru}	$R_{ru} = R_u + L_u$ R_u = raggio d'uscita L_u = larghezza dell'uscita				
Raggio di raccordo dell'isola con l'asse del braccio	R_{rb}	$R_{rb} = 4 \cdot R_g$				

Visuali libere (1)

Negli incroci a rotatoria, i conducenti che si approssimano alla rotatoria devono vedere i veicoli che percorrono l'anello centrale al fine di cedere ad essi la precedenza o eventualmente arrestarsi; sarà sufficiente una visione completamente libera sulla sinistra per un quarto della sviluppo dell'intero anello, secondo la costruzione geometrica riportata in Figura, posizionando l'osservatore a 15 metri dalla linea che delimita il bordo esterno dell'anello giratorio.

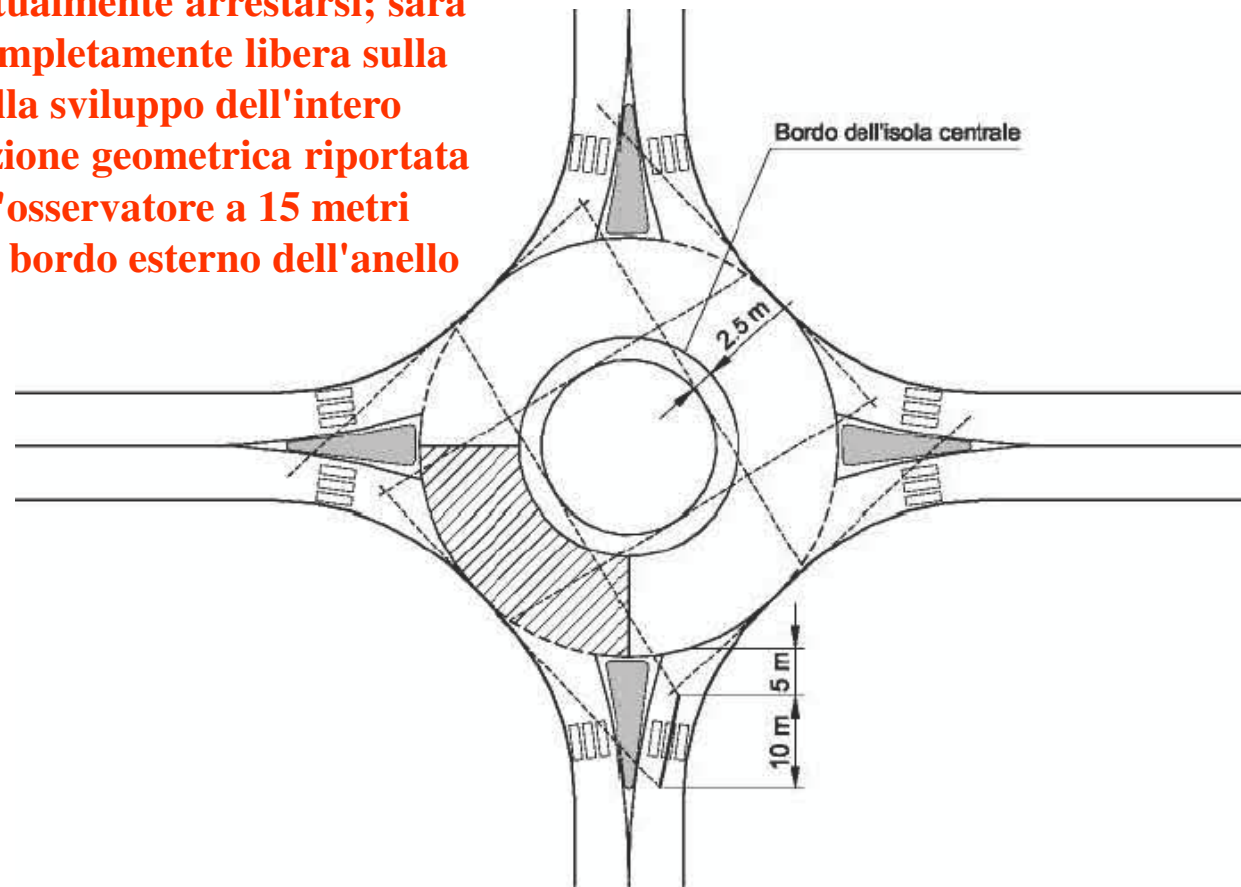

Visuali libere (2)

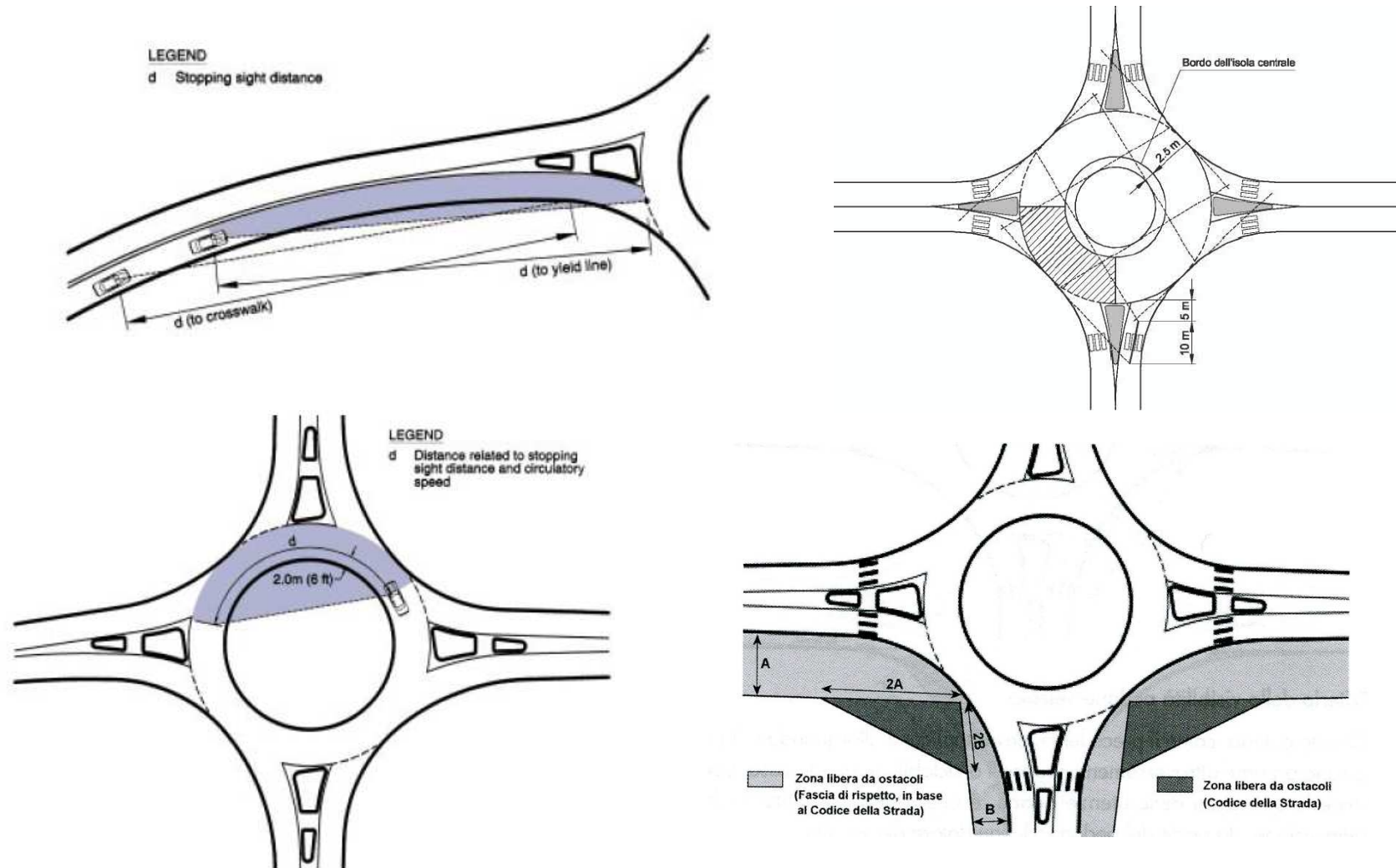

Visuali libere (3)

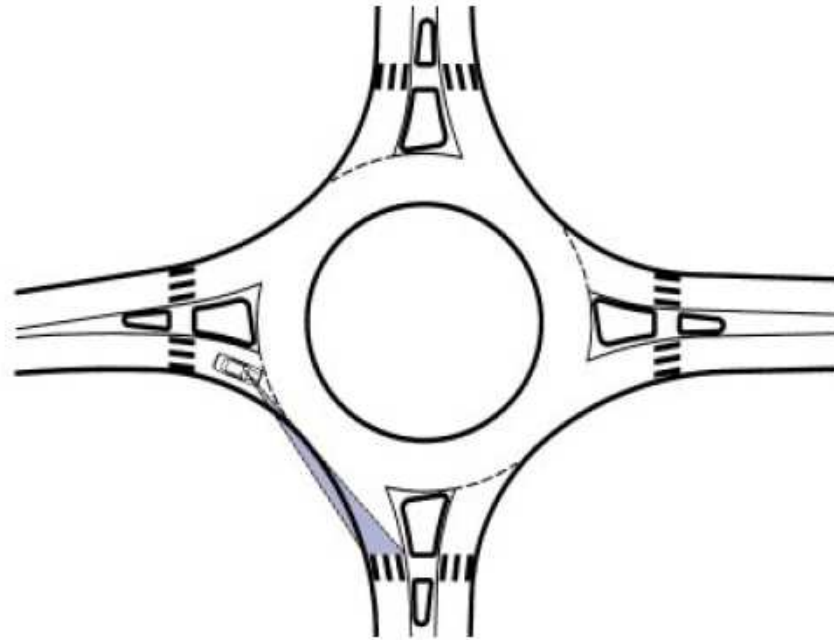

Capacità rotatorie (1)

La Federal Highway Association da alcune regole generali per le capacità di una rotatoria a singola corsia:

1800 veic/h circolanti sulla rotatoria;

1200 veic/h in uscita;

Le norme Francesi e Olandesi indicano come limite massimo, per una rotatoria a una sola corsia, 1500 veic/h circolanti + entranti in un braccio.

Mediamente si può approssimare la capacità totale entrante in una rotatoria a corsia singola a 2500 veic/h; 3500 – 4000 veic/h per una rotatoria a due corsie.

Capacità rotatorie (2)

Capacità di un singolo braccio (o capacità di ingresso): è il più piccolo flusso in ingresso su un braccio che determina la presenza permanente di veicoli in attesa di immettersi.

Capacità semplice: è la somma dei flussi nei bracci di entrata di una rotatoria quando uno dei bracci abbia raggiunto la sua capacità.

Capacità totale della rotatoria è la somma dei flussi in ingresso che distribuendosi fra le diverse uscite determinano il raggiungimento contemporaneo della capacità su tutti bracci

$$V_{EB,circ} = V_{WB,LT} + V_{SB,LT} + V_{SB,TH} + V_{NB,U-turn} + V_{WB,U-turn} + V_{SB,U-turn}$$

$$V_{WB,circ} = V_{EB,LT} + V_{NB,LT} + V_{NB,TH} + V_{SB,U-turn} + V_{EB,U-turn} + V_{NB,U-turn}$$

$$V_{NB,circ} = V_{EB,LT} + V_{EB,TH} + V_{SB,LT} + V_{WB,U-turn} + V_{SB,U-turn} + V_{EB,U-turn}$$

$$V_{SB,circ} = V_{WB,LT} + V_{WB,TH} + V_{NB,LT} + V_{EB,U-turn} + V_{NB,U-turn} + V_{WB,U-turn}$$

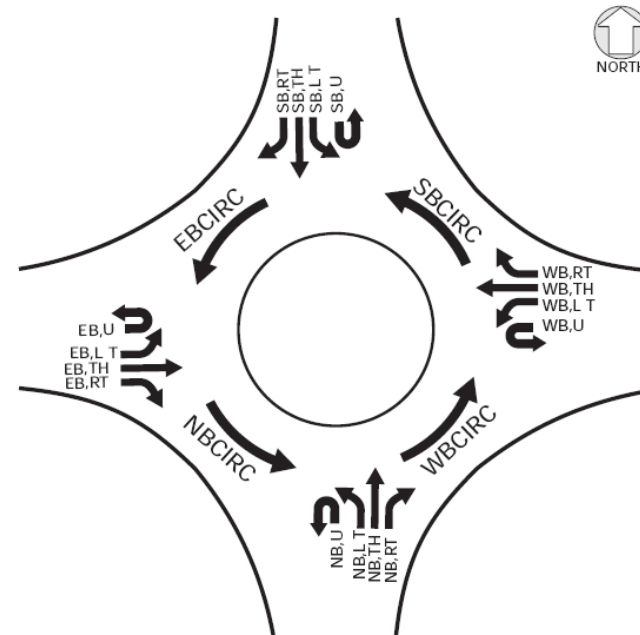

Capacità rotatorie (3)

$R_c = \text{Riserva di capacità} = C - Q_e$ $\text{Riserva capacità percentuale} = R_c(\%) = \frac{C - Q_e}{C} 100$

$C = \text{Capacità ingresso}$

$Q_e = \text{flusso in ingresso}$

Riserva di capacità (%)	Condizione di esercizio
$RC > 30 \%$	FLUIDO
$15 < RC \leq 30 \%$	SODDISFACENTE
$0 < RC \leq 15 \%$	ALEATORIO
$RC \leq 0 \%$	SATURO/CRITICO

Capacità rotatorie (4)

In letteratura esistono diversi metodi per il calcolo della capacità che si possono suddividere in tre tipi :

- a) **Metodi empirici (Es: Brilon, Kimber, Bovy, FHWA), si tratta di modelli di regressione calibrati con dati raccolti in sito e che usano le proprietà tipologiche o geometriche delle rotatorie come variabili indipendenti.**
- b) **Metodi basati sulla teoria del Gap Acceptance (Es: HCM, Tanner), si basano sul concetto che i veicoli della corrente secondaria (in questo caso l'ingresso) devono trovare un intervallo temporale sufficiente all'interno della corrente principale (in questo caso l'anello) per potersi immettere.**
- c) **Modelli di simulazione (Es: VISSIM, PARAMICS), si basano su programmi di simulazione che riproducono la situazione reale.**

Capacità rotatorie (5)

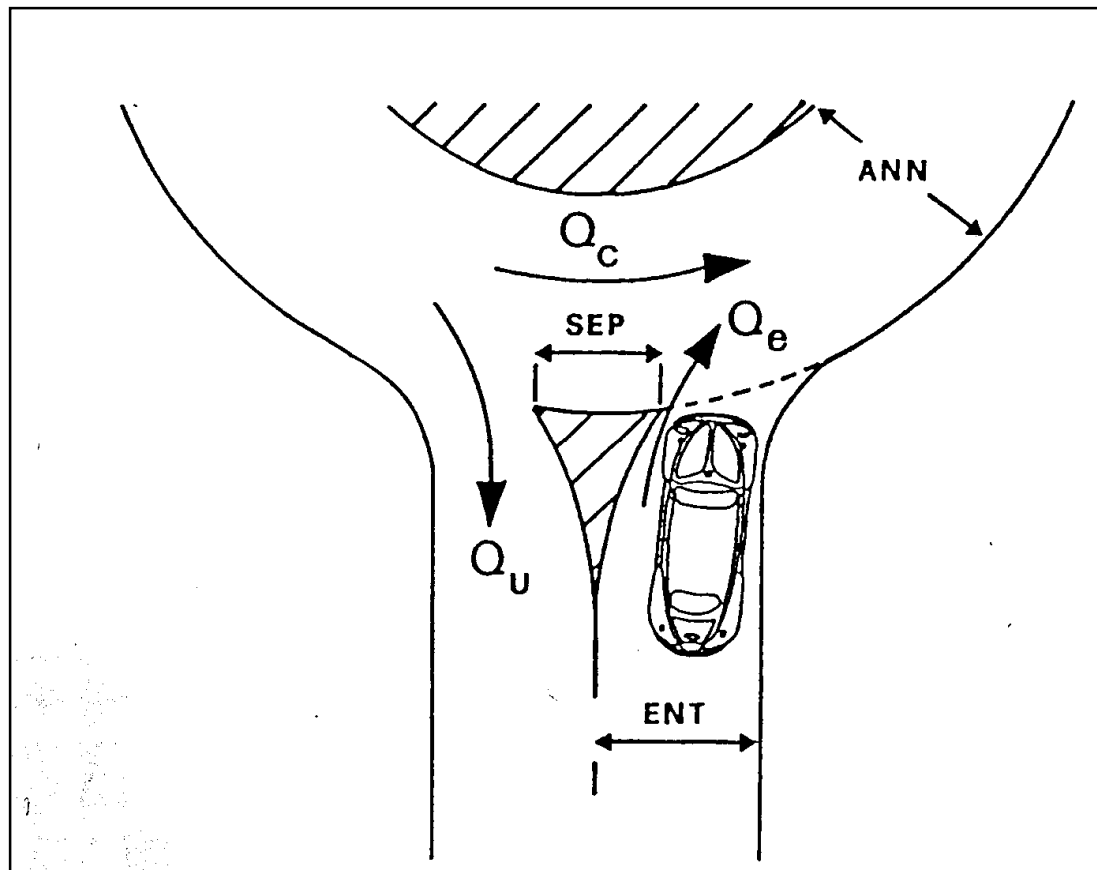

Capacità rotatorie - metodo tedesco (Brilon)

$$C_i = A - B \cdot Q_{C,i}$$

Numero di corsie all'anello	Numero di corsie all'entrata	A	B	Numerosità dei campioni
3	2	1409	0,42	295
2	2	1380	0,50	4574
2-3	1	1250	0,53	879
1	1	1218	0,74	1504

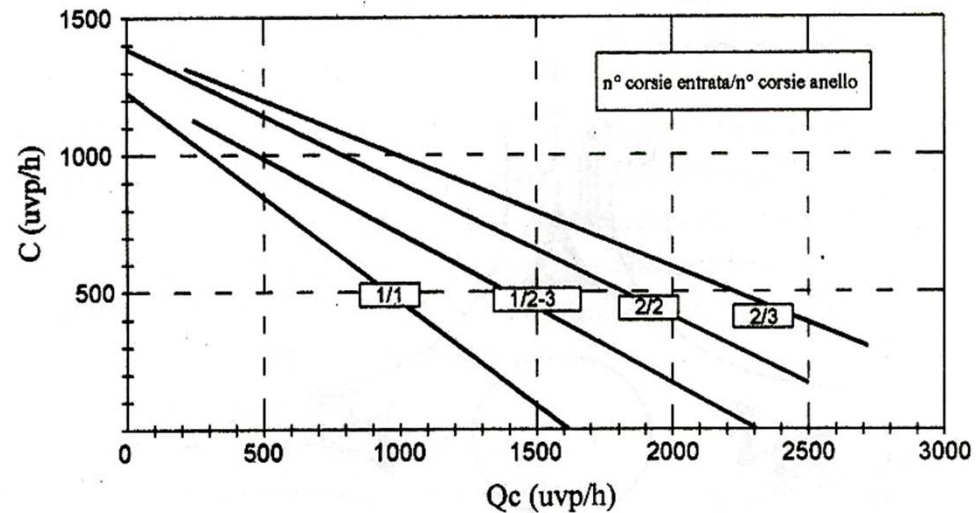
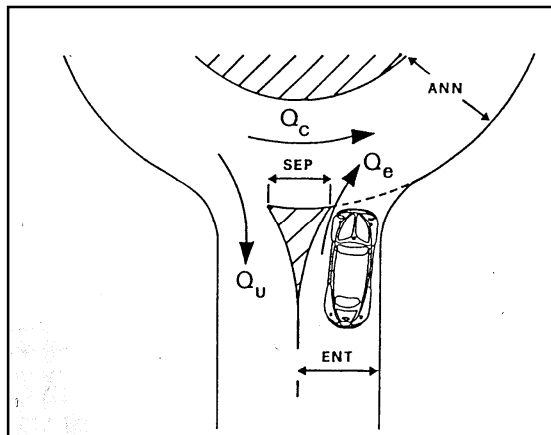

Metodo tedesco – Esempio (1)

Rotatoria a 4 bracci, con 2 corsie all'anello e 2 corsie agli ingressi

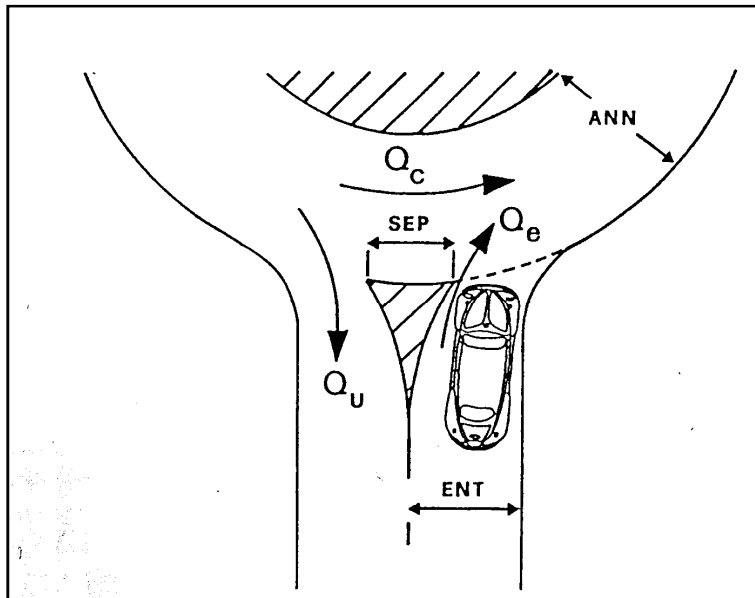

$$Q_{e,1} = 340 \text{ v/h} \quad Q_{u,1} = 380 \text{ v/h} \quad Q_{c,1} = 190 \text{ v/h}$$

$$Q_{e,2} = 236 \text{ v/h} \quad Q_{u,2} = 230 \text{ v/h} \quad Q_{c,2} = 300 \text{ v/h}$$

$$Q_{e,3} = 477 \text{ v/h} \quad Q_{u,3} = 322 \text{ v/h} \quad Q_{c,3} = 214 \text{ v/h}$$

$$Q_{e,4} = 152 \text{ v/h} \quad Q_{u,4} = 271 \text{ v/h} \quad Q_{c,4} = 418 \text{ v/h}$$

Metodo tedesco – Esempio (2)

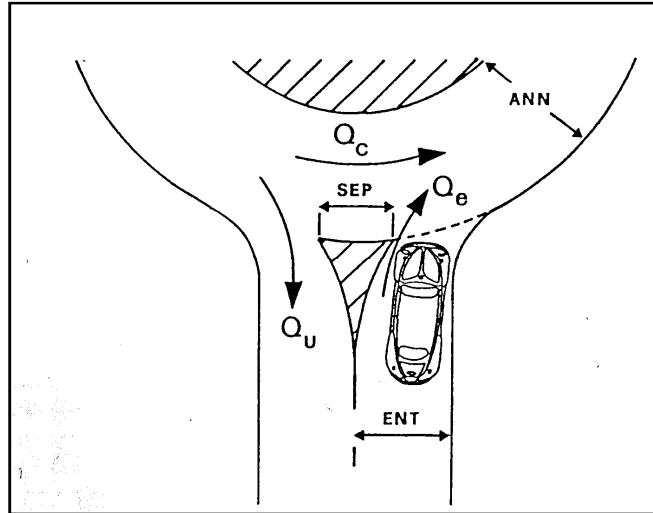

$$C_1 = 1380 - 0,5 * Q_{c,1} = 1380 - 0,5 * 190 = 1285 \text{ v/h}$$

$$C_2 = 1380 - 0,5 * Q_{c,2} = 1380 - 0,5 * 300 = 1230 \text{ v/h}$$

$$C_3 = 1380 - 0,5 * Q_{c,3} = 1380 - 0,5 * 214 = 1273 \text{ v/h}$$

$$C_4 = 1380 - 0,5 * Q_{c,4} = 1380 - 0,5 * 418 = 1171 \text{ v/h}$$

$$RC_1 = C_1 - Q_{e,1} = 1285 - 340 = 945 \text{ v/h}$$

$$RC_2 = C_2 - Q_{e,2} = 1230 - 236 = 994 \text{ v/h}$$

$$RC_3 = C_3 - Q_{e,3} = 1273 - 477 = 796 \text{ v/h}$$

$$RC_4 = C_4 - Q_{e,4} = 1171 - 152 = 1019 \text{ v/h}$$

$$(CT\%)_1 = 100 * Q_{e,1} / C_1 = 100 * 340 / 1285 = 26,46 \%$$

$$(CT\%)_2 = 100 * Q_{e,2} / C_2 = 100 * 236 / 1230 = 19,19 \%$$

$$(CT\%)_3 = 100 * Q_{e,3} / C_3 = 100 * 477 / 1273 = 37,47 \%$$

$$(CT\%)_4 = 100 * Q_{e,4} / C_4 = 100 * 152 / 1171 = 12,98 \%$$

Metodo Francese, SETRA (1)

$$Q_u' = \frac{Q_u \cdot (15 - SEP)}{15}$$

$$Q_u' = 0 \quad \text{per} \quad SEP > 15$$

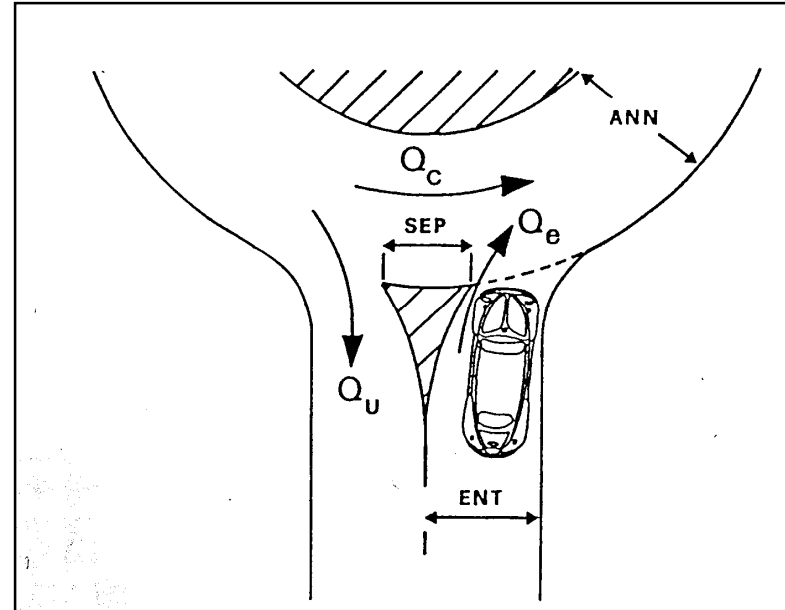

$$Q_d = \left(Q_c + \frac{2}{3} \cdot Q_u' \right) \cdot [1 - 0,085 \cdot (ANN - 8)]$$

$$C_i = (1330 - 0,7 \cdot Q_{d,i}) \cdot [1 + 0,1(ENT_i - 3,5)] \quad C_{p,i} = C_i - 150$$

Metodo Francese, SETRA (2)

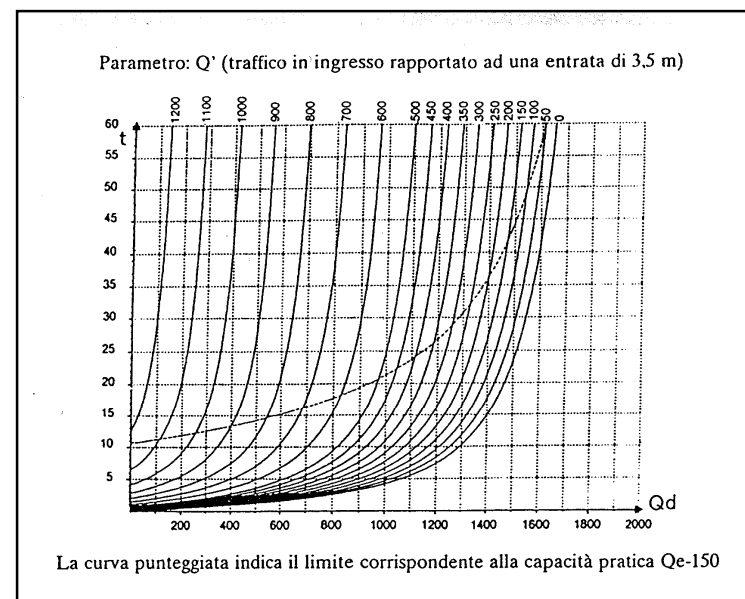
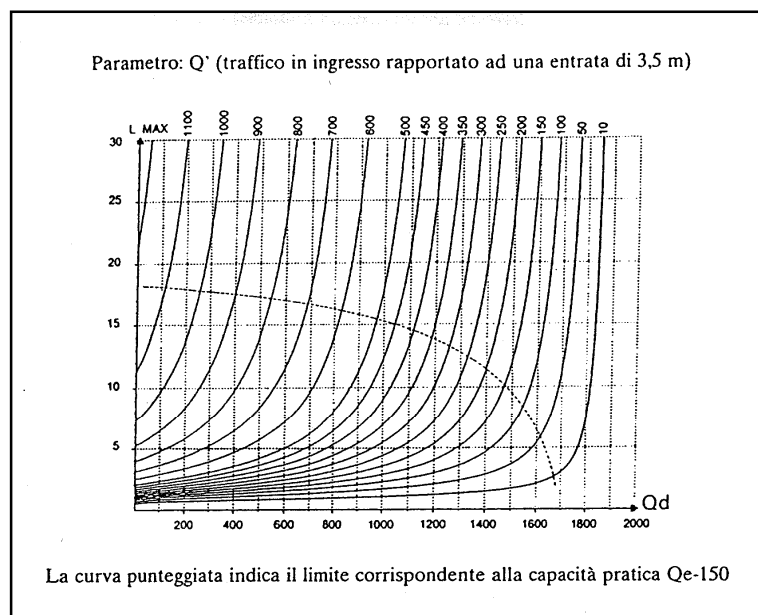

$$Q'_e = \frac{Q_e}{1 + 0,1(ENT - 3,5)}$$

Metodo Francese, SETRA – Esempio (1)

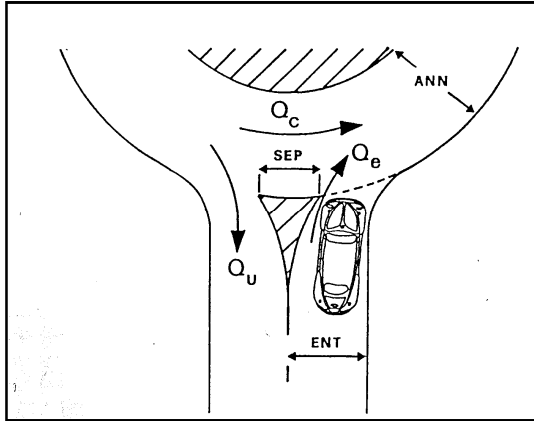

ANN = 8 m;

SEP₁ = SEP₃ = 2,37 m; SEP₂ = SEP₄ = 9,23 m

ENT₁ = ENT₃ = 7,00 m; ENT₂ = ENT₄ = 4,00 m

Q_{e,1} = 340 v/h Q_{u,1} = 380 v/h Q_{c,1} = 190 v/h

Q_{e,2} = 236 v/h Q_{u,2} = 230 v/h Q_{c,2} = 300 v/h

Q_{e,3} = 477 v/h Q_{u,3} = 322 v/h Q_{c,3} = 214 v/h

Q_{e,4} = 152 v/h Q_{u,4} = 271 v/h Q_{c,4} = 418 v/h

Metodo Francese, SETRA – Esempio (2)

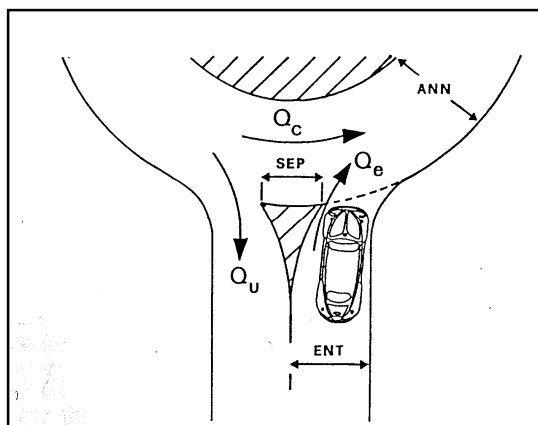

$$Q'_{u,1} = \frac{Q_{u,1} \cdot (15 - SEP_1)}{15} = \frac{380 \cdot (15 - 2,37)}{15} = 320 \text{ veic./h}$$

$$Q'_{u,2} = \frac{Q_{u,2} \cdot (15 - SEP_2)}{15} = \frac{230 \cdot (15 - 9,23)}{15} = 88 \text{ veic./h}$$

$$Q'_{u,3} = \frac{Q_{u,3} \cdot (15 - SEP_3)}{15} = \frac{322 \cdot (15 - 2,37)}{15} = 271 \text{ veic./h}$$

$$Q'_{u,4} = \frac{Q_{u,4} \cdot (15 - SEP_4)}{15} = \frac{271 \cdot (15 - 9,23)}{15} = 104 \text{ veic./h}$$

Metodo Francese, SETRA – Esempio (3)

$$Q_{d,1} = \left(Q_{c,1} + \frac{2}{3} \cdot Q'_{u,1} \right) \cdot [1 - 0,085 \cdot (ANN - 8)] = \left(190 + \frac{2}{3} \cdot 320 \right) \cdot [1 - 0,085 \cdot (8 - 8)] = 403 \text{ veic./h}$$

$$Q_{d,2} = \left(300 + \frac{2}{3} \cdot 88 \right) \cdot [1 - 0,085 \cdot (8 - 8)] = 359 \text{ veic./h}$$

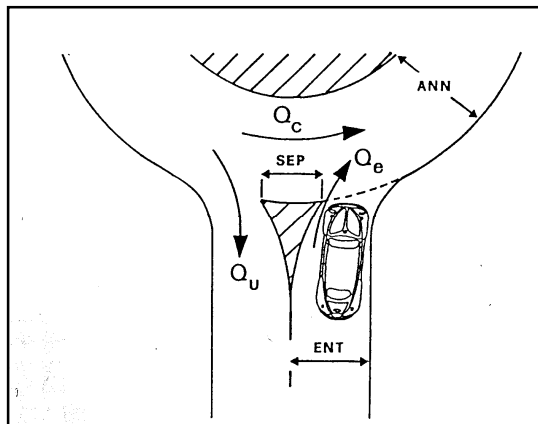

$$Q_{d,3} = \left(214 + \frac{2}{3} \cdot 271 \right) \cdot [1 - 0,085 \cdot (8 - 8)] = 395 \text{ veic./h}$$

$$Q_{d,4} = \left(418 + \frac{2}{3} \cdot 104 \right) \cdot [1 - 0,085 \cdot (8 - 8)] = 487 \text{ veic./h}$$

Metodo Francese, SETRA – Esempio (4)

$$C_1 = (1330 - 0,7 \cdot Q_{d,1}) \cdot [1 + 0,1 \cdot (ENT_1 - 3,5)] = (1330 - 0,7 \cdot 403) \cdot [1 + 0,1 \cdot (7,00 - 3,5)] = 1415 \text{ veic./h}$$

$$C_2 = (1330 - 0,7 \cdot 359) \cdot [1 + 0,1 \cdot (4,00 - 3,5)] = 1133 \text{ veic./h}$$

$$C_3 = (1330 - 0,7 \cdot 395) \cdot [1 + 0,1 \cdot (7,00 - 3,5)] = 1422 \text{ veic./h}$$

$$C_4 = (1330 - 0,7 \cdot 487) \cdot [1 + 0,1 \cdot (4,00 - 3,5)] = 1039 \text{ veic./h}$$

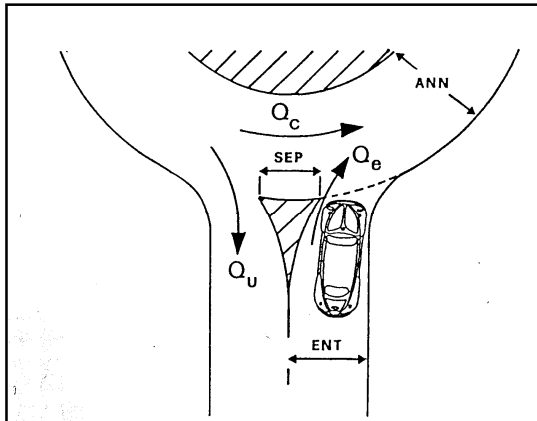

Metodo Francese, SETRA – Esempio (5)

$$Q'_{e,1} = \frac{Q_{e,1}}{1 + 0,1 \cdot (ENT_1 - 3,5)} = \frac{340}{1 + 0,1 \cdot (7,00 - 3,5)} = 252 \text{ veic/h}$$

$$Q'_{e,2} = \frac{236}{1 + 0,1 \cdot (4,00 - 3,5)} = 225 \text{ veic/h}$$

$$Q'_{e,3} = \frac{477}{1 + 0,1 \cdot (7,00 - 3,5)} = 353 \text{ veic/h}$$

$$Q'_{e,4} = \frac{152}{1 + 0,1 \cdot (4,00 - 3,5)} = 145 \text{ veic/h}$$

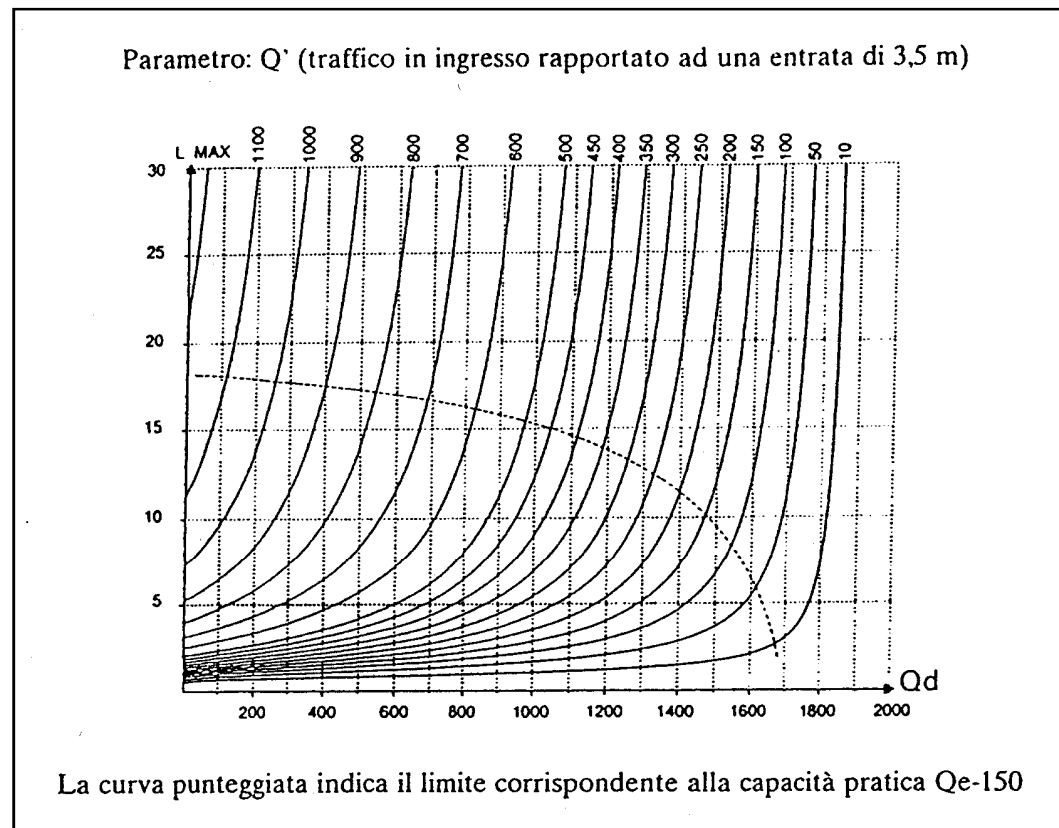

L1 = 2 veic.

L2 = 2 veic.

L3 = 3 veic.

L4 = 3 veic.

Metodo Francese, SETRA – Esempio (5)

$$Q'_{e,1} = \frac{Q_{e,1}}{1 + 0,1 \cdot (ENT_1 - 3,5)} = \frac{340}{1 + 0,1 \cdot (7,00 - 3,5)} = 252 \text{ veic/h}$$

$$Q'_{e,2} = \frac{236}{1 + 0,1 \cdot (4,00 - 3,5)} = 225 \text{ veic/h}$$

$$Q'_{e,3} = \frac{477}{1 + 0,1 \cdot (7,00 - 3,5)} = 353 \text{ veic/h}$$

$$Q'_{e,4} = \frac{152}{1 + 0,1 \cdot (4,00 - 3,5)} = 145 \text{ veic/h}$$

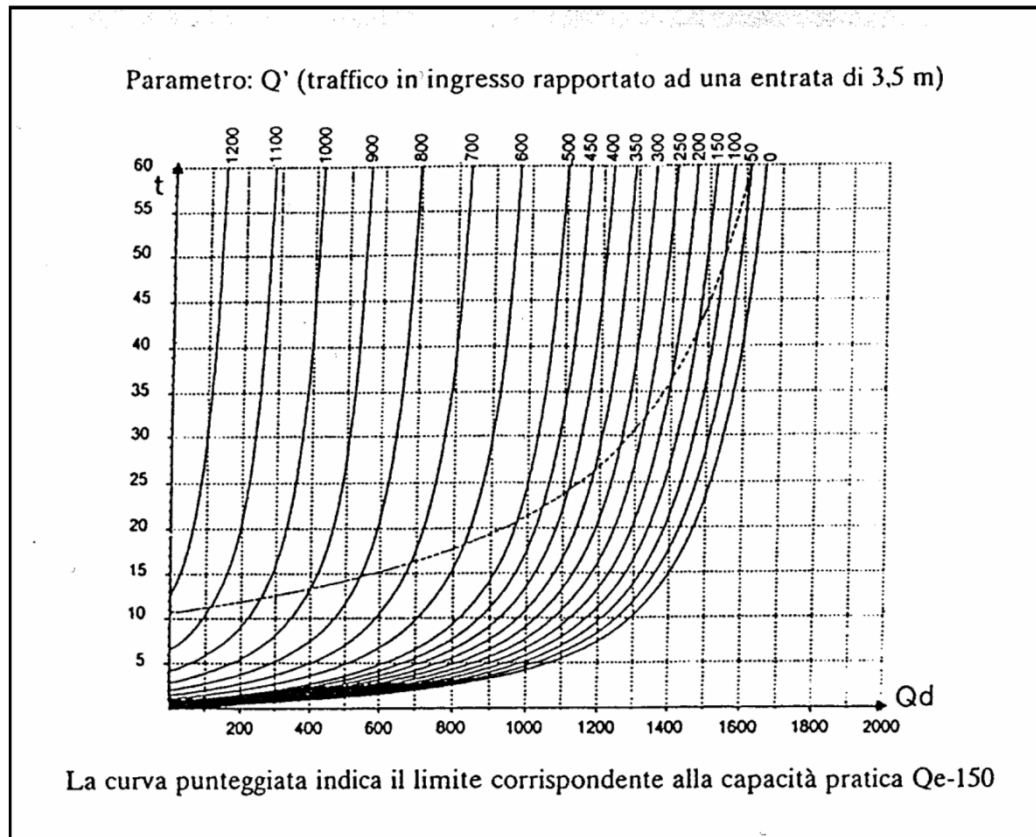

E1 = 1 s

E2 = 1 s

E3 = 2 s

E4 = 2 s

Metodo Francese, SETRA – Esempio (6)

$$C_{p,1} = C_1 - 150 = 1415 - 150 = 1265 \quad \text{veic./h}$$

$$C_{p,2} = C_2 - 150 = 1133 - 150 = 983 \quad \text{veic./h}$$

$$C_{p,3} = C_3 - 150 = 1272 - 150 = 1122 \quad \text{veic./h}$$

$$C_{p,4} = C_4 - 150 = 1039 - 150 = 889 \quad \text{veic./h}$$

$$(RC\%)_1 = \frac{C_{p,1} - Q_{e,1}}{C_{p,1}} \cdot 100 = \frac{1265 - 340}{1265} \cdot 100 = 73,12\% \quad \text{veic./h}$$

$$(RC\%)_2 = \frac{983 - 236}{983} \cdot 100 = 76,00\% \quad \text{veic./h}$$

$$(RC\%)_3 = \frac{1122 - 477}{1122} \cdot 100 = 57,50\% \quad \text{veic./h}$$

$$(RC\%)_4 = \frac{889 - 152}{889} \cdot 100 = 82,90\% \quad \text{veic./h}$$

Metodo Francese, CETUR

$$C = \gamma \cdot \left(1500 - \frac{5}{6} \cdot Q_d \right)$$

$$Q_d = \beta \cdot Q_c + 0,2 \cdot Q_u$$

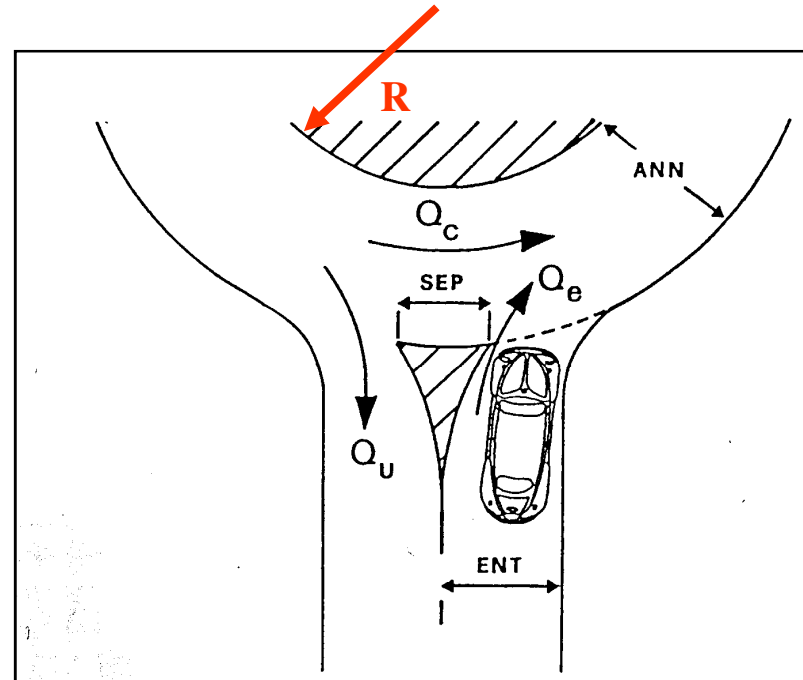

$\gamma = 1$ per ingressi con 1 corsia; $\gamma = 1,5$ per ingressi a due o più corsie

$\beta = 1$ per ANN < 8 m; $\beta = 0,9$ per ANN \geq 8 m e R < 20 m; $\beta = 0,7$ per ANN \geq 8 m e R \geq 20 m;

Metodo Francese, CETUR - Esempio

$$Q_{d,1} = \beta \cdot Q_{c,1} + 0,2 \cdot Q_{u,1} = 0,7 \cdot 190 + 0,2 \cdot 380 = 209 \text{ veic./h}$$

$$Q_{d,2} = 0,7 \cdot 300 + 0,2 \cdot 230 = 256 \text{ veic./h}$$

$$Q_{e,1} = 340 \text{ v/h} \quad Q_{u,1} = 380 \text{ v/h} \quad Q_{c,1} = 190 \text{ v/h}$$

$$Q_{d,3} = 0,7 \cdot 214 + 0,2 \cdot 322 = 214 \text{ veic./h}$$

$$Q_{e,2} = 236 \text{ v/h} \quad Q_{u,2} = 230 \text{ v/h} \quad Q_{c,2} = 300 \text{ v/h}$$

$$Q_{d,4} = 0,7 \cdot 418 + 0,2 \cdot 271 = 346 \text{ veic./h}$$

$$Q_{e,3} = 477 \text{ v/h} \quad Q_{u,3} = 322 \text{ v/h} \quad Q_{c,3} = 214 \text{ v/h}$$

$$Q_{e,4} = 152 \text{ v/h} \quad Q_{u,4} = 271 \text{ v/h} \quad Q_{c,4} = 418 \text{ v/h}$$

$$C_1 = \gamma \cdot \left(1500 - \frac{5}{6} \cdot Q_{d,1} \right) = 1,5 \cdot \left(1500 - \frac{5}{6} \cdot 209 \right) = 1988 \text{ veic./h}$$

$$C_2 = 1,5 \cdot \left(1500 - \frac{5}{6} \cdot 256 \right) = 1930 \text{ veic./h}$$

$$C_3 = 1,5 \cdot \left(1500 - \frac{5}{6} \cdot 214 \right) = 1982 \text{ veic./h}$$

$$C_{41} = 1,5 \cdot \left(1500 - \frac{5}{6} \cdot 346 \right) = 1817 \text{ veic./h}$$

Metodo Francese, Girabase (1)

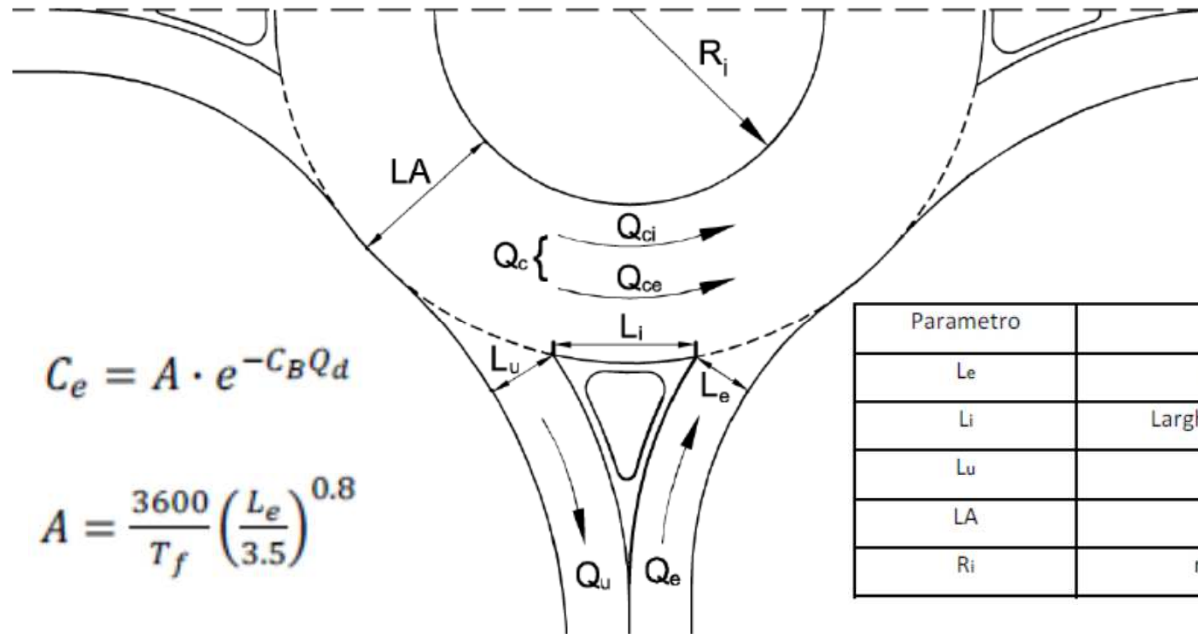

$$C_e = A \cdot e^{-C_B Q_d}$$

$$A = \frac{3600}{T_f} \left(\frac{L_e}{3.5} \right)^{0.8}$$

Parametro	Descrizione	Campo di variabilità
L_e	larghezza entrata	3 ÷ 11 m
L_i	Larghezza isola spartitraffico	0 ÷ 70 m
L_u	larghezza uscita	3,5 ÷ 10,5 m
LA	larghezza anello	4,5 ÷ 17,5 m
R_i	raggio isola centrale	3,5 ÷ 87,5 m

dove:

T_f = tempo di follow-up= 2,05 s

L_e = larghezza dell'entrata in prossimità della rotatoria, misurata perpendicolarmente alla direzione dell'ingresso(m)

C_B = coefficiente che vale 3,525 per aree urbane e 3,625 per aree extraurbane

Metodo Francese, Girabase (2)

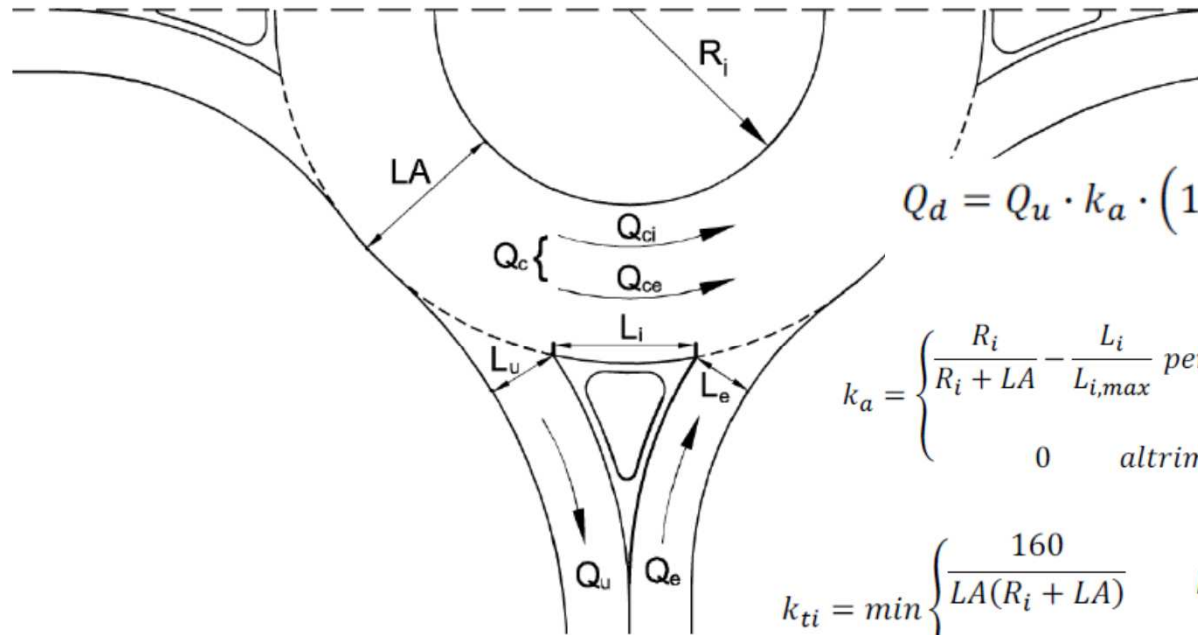

$$Q_d = Q_u \cdot k_a \cdot \left(1 - \frac{Q_u}{Q_c + Q_u}\right) + Q_{ci} \cdot k_{ti} + Q_{ce} \cdot k_{te}$$

$$k_a = \begin{cases} \frac{R_i}{R_i + LA} - \frac{L_i}{L_{i,max}} & \text{per } L_i < L_{i,max} \\ 0 & \text{altrimenti} \end{cases} \quad L_{i,max} = 4,55 \cdot \sqrt{R_i + \frac{LA}{2}}$$

$$k_{ti} = \min \left\{ \frac{160}{LA(R_i + LA)}, 1 \right\} \quad k_{te} = \min \left\{ 1 - \frac{(LA - 8)}{LA} \cdot \left(\frac{R_i}{(R_i + LA)}\right)^2, 1 \right\}$$

Q_d = traffico di disturbo in prossimità dell'ingresso considerato (veh/h)

Q_u = flusso uscente (veh/h)

$Q_c = Q_{ci} + Q_{ce}$ = flusso di traffico circolante sull'anello in corrispondenza dell'ingresso considerato (veh/h)

Q_{ci} = aliquota di traffico Q_c sulla semicarreggiata interna dell'anello (veh/h)

Q_{ce} = aliquota di traffico Q_c sulla semicarreggiata esterna dell'anello (veh/h)

Metodo Svizzero, Bovy (1)

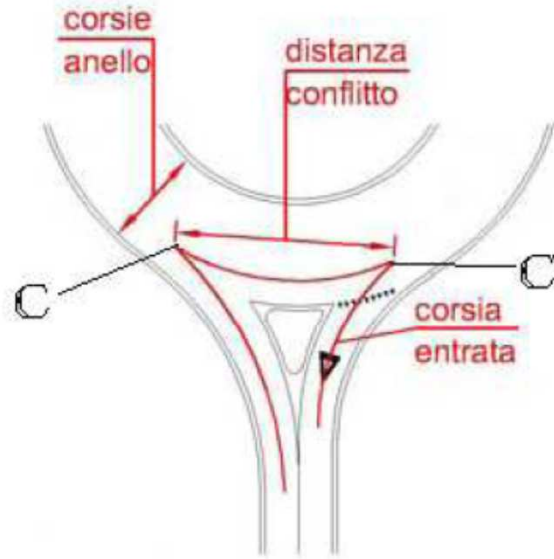

γ	n° corsie in ingresso
1,0	1
0,6-0,7	2
0,5	3

$$C_e = \frac{1}{\gamma} \left(1500 - \frac{8}{9} Q_d \right) \quad [veh/h]$$

$$Q_d = \alpha Q_u + \beta Q_c \quad [veh/h]$$

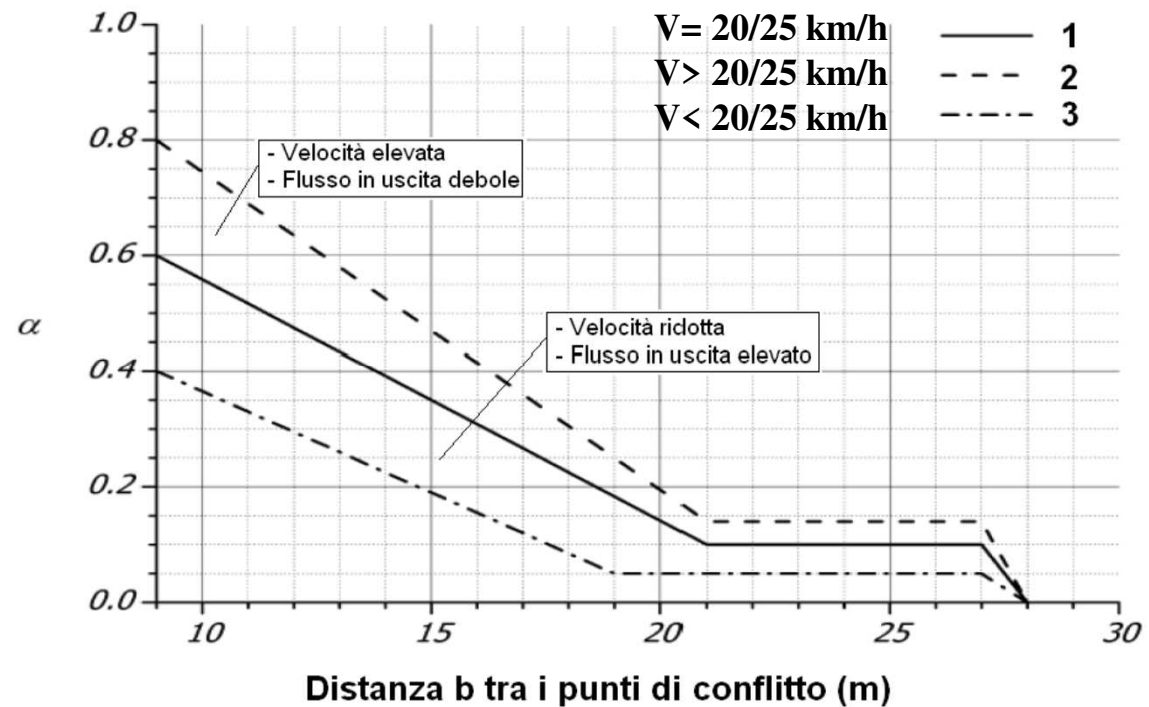

Metodo Svizzero, Bovy (2)

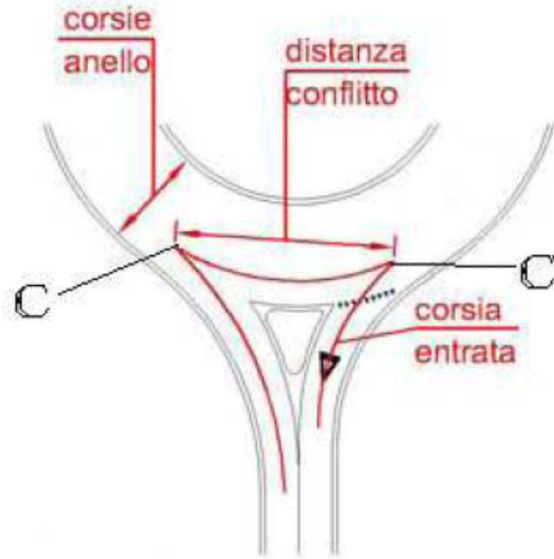

$$C_e = \frac{1}{\gamma} \left(1500 - \frac{8}{9} Q_d \right) \quad [veh/h]$$

$$Q_d = \alpha Q_u + \beta Q_c \quad [veh/h]$$

Tipo di veicolo	Coefficiente di equivalenza
1 ciclo o motociclo in ingresso	0,2 autovetture
1 ciclo o motociclo sull'anello	0,8 autovetture
1 mezzo pesante o autobus	2,0 autovetture

β	n° corsie sull'anello
0,9-1,0	1
0,6-0,8	2
0,5-0,6	3

Metodo inglese, Kimber (1)

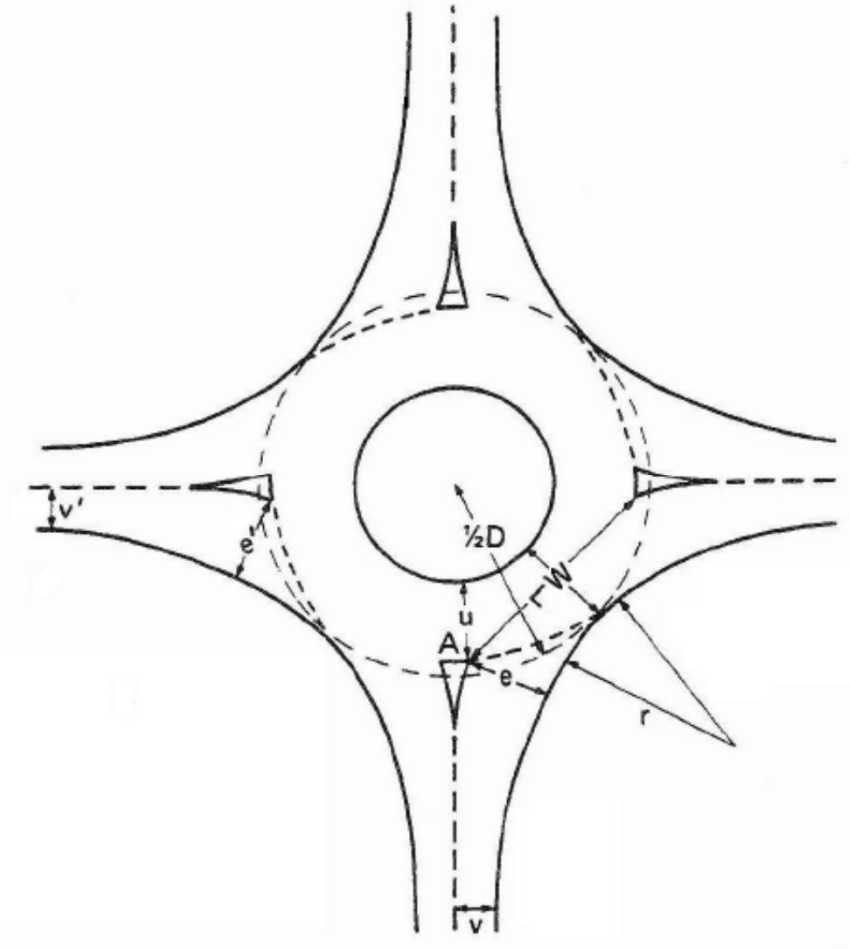

$$C_e = k(F - f_c Q_c) \quad [veh/h]$$

$$\text{con:} \begin{cases} F = 303x \\ f_c = 0,210t_D(1 + 0,2x) \\ k = 1 - 0,00347(\Phi - 30) - 0,978 \left(\frac{1}{r} - 0,05 \right) \end{cases}$$

$$t_D = 1 + \frac{1}{2 \left[1 + \exp \left(\frac{(D - 60)}{10} \right) \right]}$$

$$x = v + \frac{(e - v)}{(1 + 2S)}$$

$$S = \frac{1,6(e - v)}{l'} = \frac{(e - v)}{l}$$

Metodo inglese, Kimber (2)

Parametro	Descrizione	Campo di variabilità
e	larghezza entrata	3,6 ÷ 16,5 m
v	larghezza corsia	1,9 ÷ 12,5 m
e'	larghezza entrata precedente	3,6 ÷ 15,0 m
v'	larghezza corsia precedente	2,9 ÷ 12,5 m
u	larghezza anello	4,9 ÷ 22,7 m
l, l'	lunghezza media svasatura	1,0 ÷ ∞ m
S	acutezza svasatura	0 ÷ 2,9 m
r	raggio curvatura entrata	3,4 ÷ ∞ m
Φ	angolo d'entrata	0° ÷ 77°
D=Dext	diametro cerchio inscritto	13,5 ÷ 171,6 m
w	larghezza tronco di scambio	7,0 ÷ 26,0 m
L	lunghezza tronco di scambio	9,0 ÷ 86,0 m

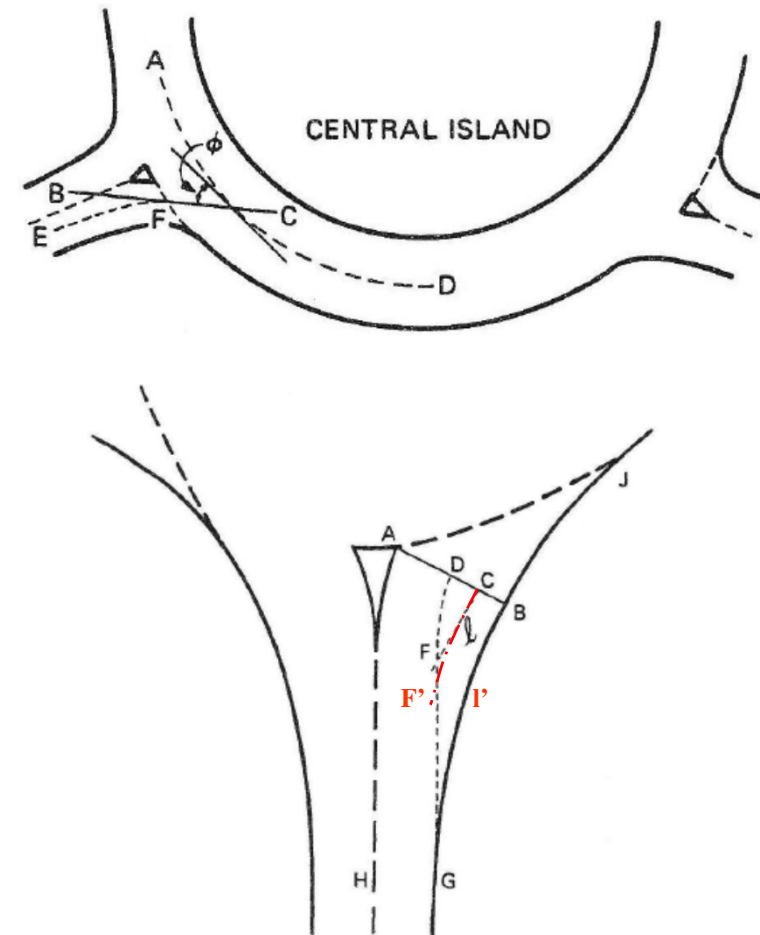

Metodo FHWA - USA (1)

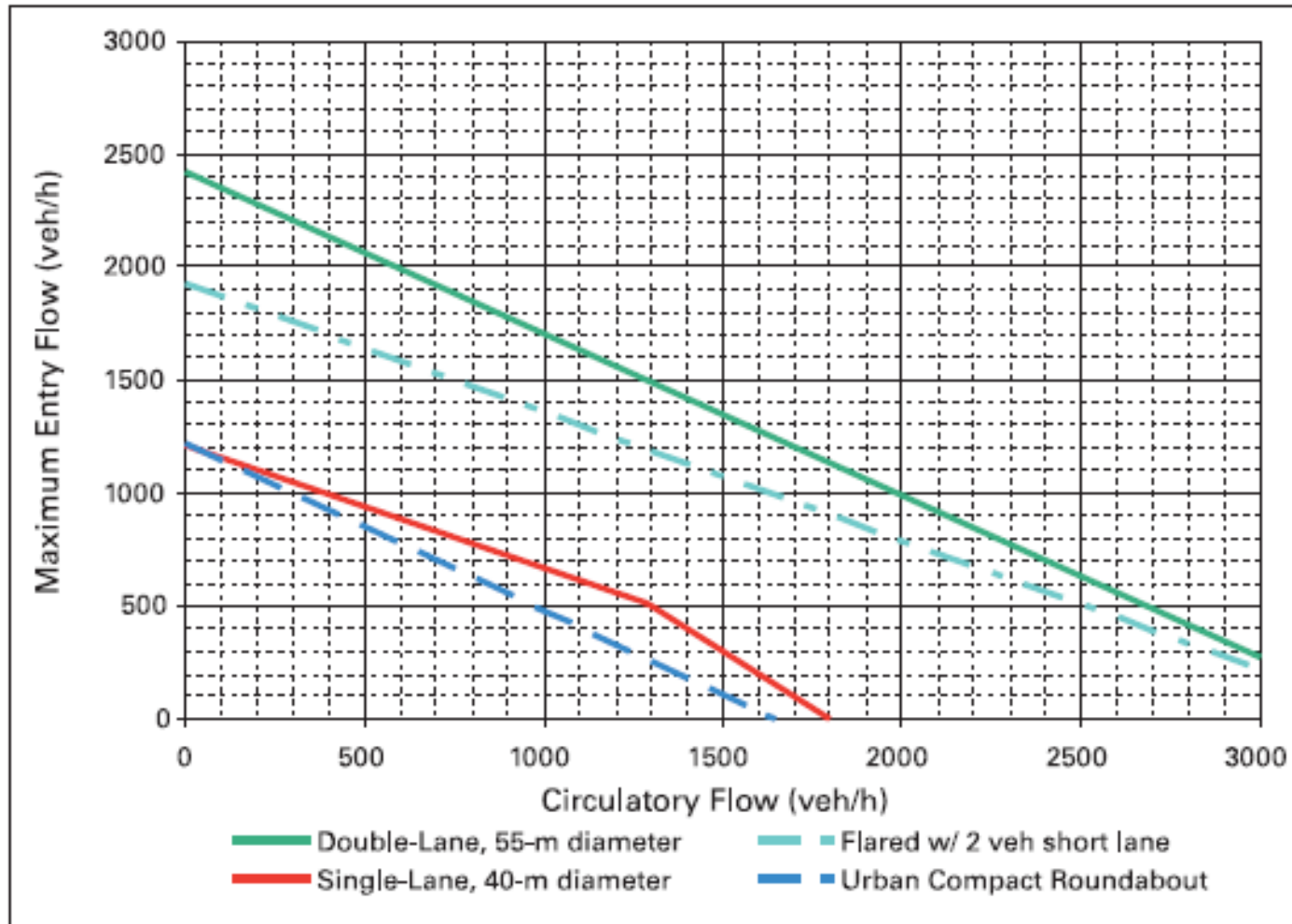

Metodo FHWA - USA (2)

Parametri geometrici	Rotatorie a singola corsia	Rotatorie a doppia corsia	Rotatorie urbane compatte
D	40 m	55 m	Basato sul metodo di Brilon Equazione 2.14
r _e	20 m	20 m	
Φ	30°	30°	
v	4 m	8 m	
e	4 m	8 m	
l'	40 m	40 m	
Q _e	1212-0,5447Q _c	2424-0,71Q _c	1218-0,74Q _c

Metodo HCM - USA (1)

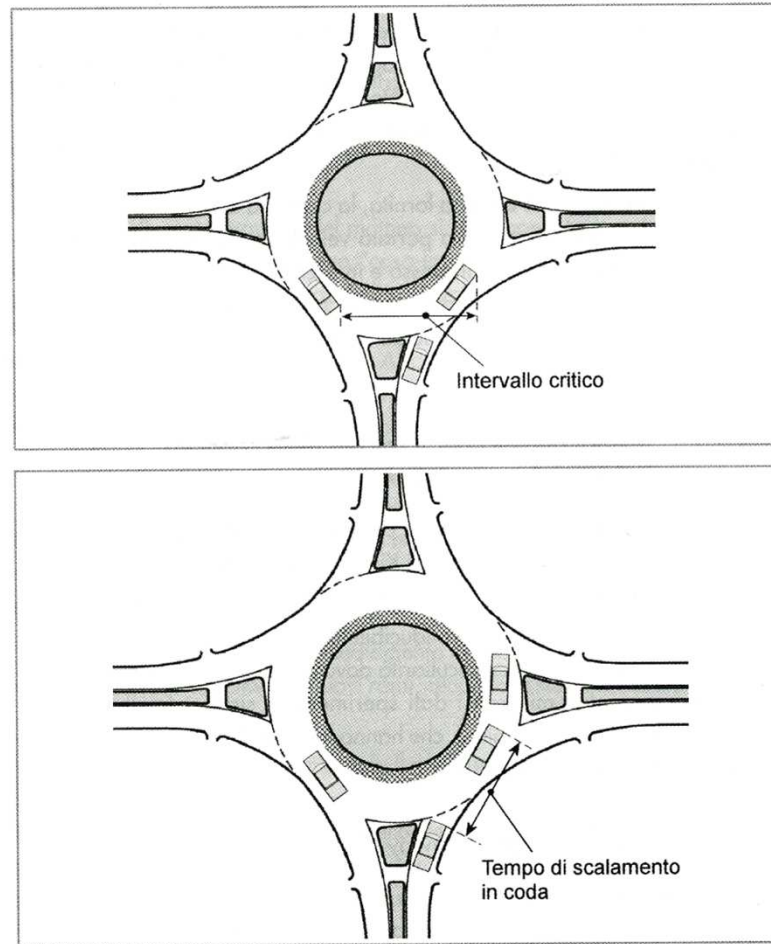

Metodo HCM - USA (2)

EXHIBIT 17-36. ANALYSIS ON ONE ROUNDABOUT LEG

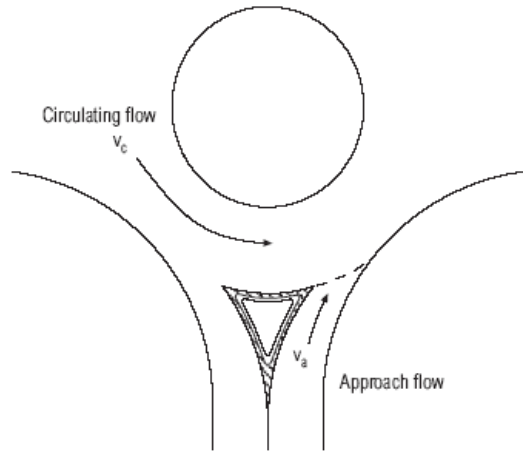

$$c_a = \frac{v_c e^{-v_c t_c / 3600}}{1 - e^{-v_c t_f / 3600}}$$

- c_a = approach capacity (veh/h),
- v_c = conflicting circulating traffic (veh/h),
- t_c = critical gap (s), and
- t_f = follow-up time (s).

EXHIBIT 17-37. CRITICAL GAP AND FOLLOW-UP TIMES FOR ROUNDABOUTS

	Critical Gap (s)	Follow-Up Time (s)
Upper bound	4.1	2.6
Lower bound	4.6	3.1

EXHIBIT 17-38. ROUNDABOUT APPROACH CAPACITY

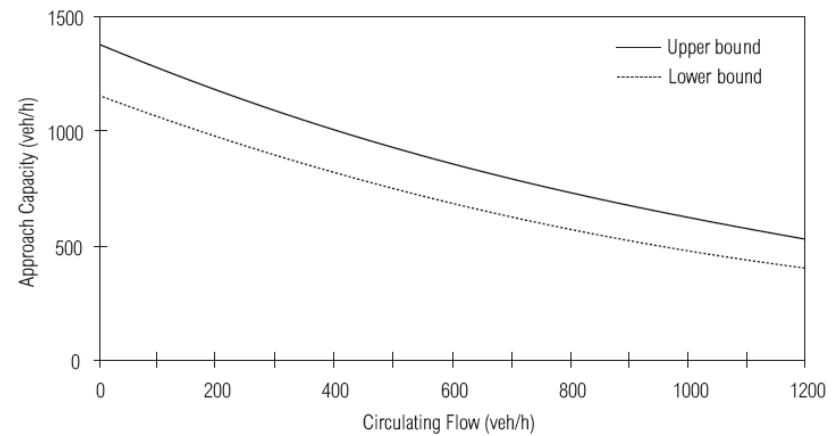

Metodo HCM - USA (3)

EXHIBIT 17-39. FLOW STREAM DEFINITIONS

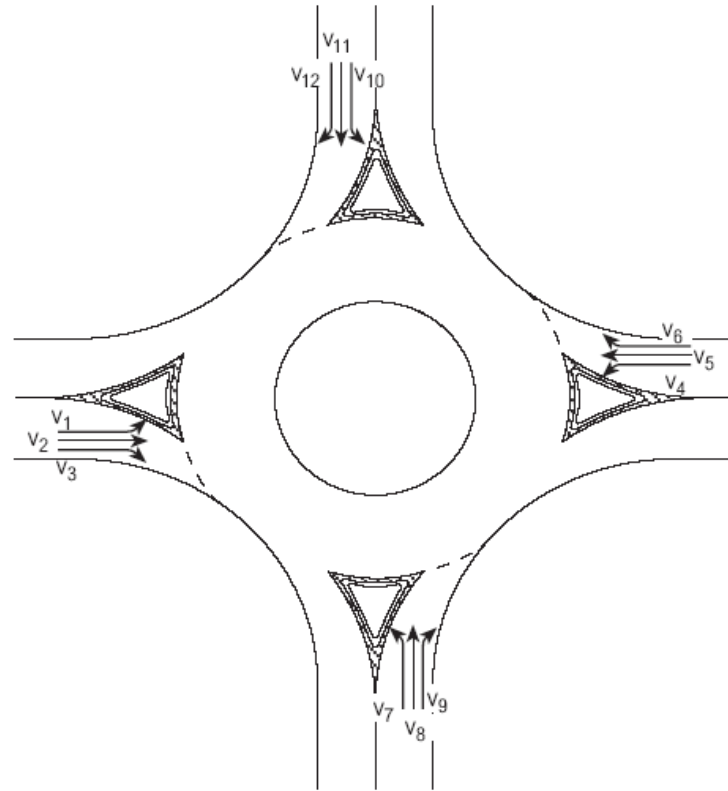

Metodo HMC - USA (4)

$$d = \frac{3600}{c_{m,x}} + 900T \times \left[\frac{v_x}{c_{m,x}} - 1 + \sqrt{\left(\frac{v_x}{c_{m,x}} - 1 \right)^2 + \frac{\left(\frac{3600}{c_{m,x}} \right) \left(\frac{v_x}{c_{m,x}} \right)}{450T}} \right]$$

where:

- d = average control delay, sec/veh;
- v_x = flow rate for movement x, veh/h;
- $c_{m,x}$ = capacity of movement x, veh/h; and
- T = analysis time period, h ($T = 0.25$ for a 15-minute period).

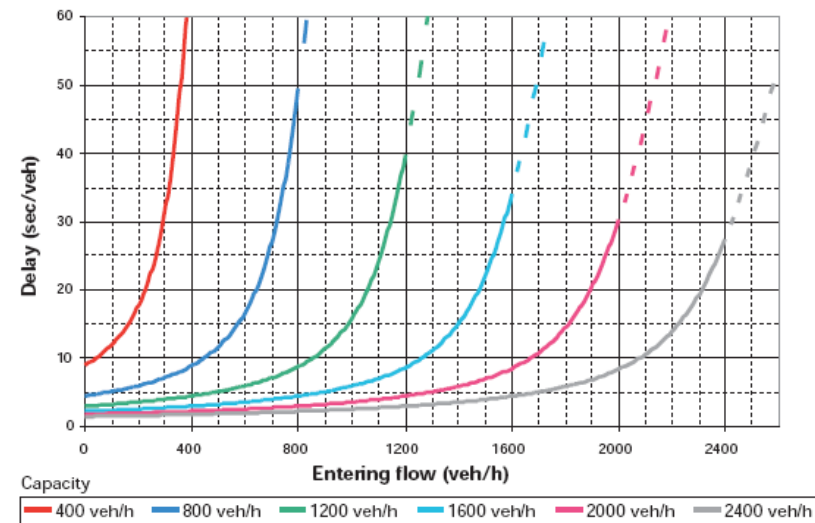

Metodo HMC - USA (5)

$$L = v \cdot \frac{d}{3600}$$

$$Q_{95} \approx 900T \left[\frac{v_x}{c_{m,x}} - 1 + \sqrt{\left(1 - \frac{v_x}{c_{m,x}}\right)^2 + \frac{\left(\frac{3600}{c_{m,x}}\right)\left(\frac{v_x}{c_{m,x}}\right)}{150T}} \right] \left(\frac{c_{m,x}}{3600}\right)$$

where: Q_{95} = 95th percentile queue, veh,
 v_x = flow rate for movement x, veh/h,
 $c_{m,x}$ = capacity of movement x, veh/h, and
 T = analysis time period, h (0.25 for 15-minute period).

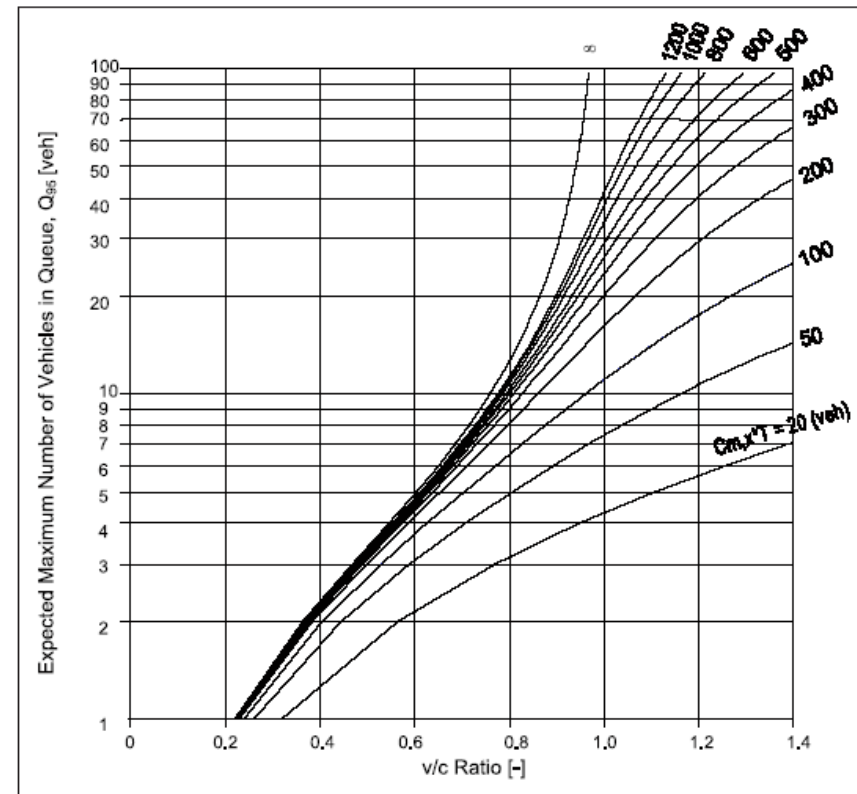

Metodo USA – Esempio (1)

$$V_{a,1} = 340 \text{ v/h} \quad V_{u,1} = 380 \text{ v/h} \quad V_{c,1} = 190 \text{ v/h}$$

$$V_{a,2} = 236 \text{ v/h} \quad V_{u,2} = 230 \text{ v/h} \quad V_{c,2} = 300 \text{ v/h}$$

$$V_{a,3} = 477 \text{ v/h} \quad V_{u,3} = 322 \text{ v/h} \quad V_{c,3} = 214 \text{ v/h}$$

$$V_{a,4} = 152 \text{ v/h} \quad V_{u,4} = 271 \text{ v/h} \quad V_{c,4} = 418 \text{ v/h}$$

$$C_{a,i} = \frac{V_{c,i} \cdot e^{-V_{c,i} \cdot t_c / 3600}}{1 - e^{-V_{c,i} \cdot t_f / 3600}}$$

EXHIBIT 17-37. CRITICAL GAP AND FOLLOW-UP TIMES FOR ROUNDABOUTS

	Critical Gap (s)	Follow-Up Time (s)
Upper bound	4.1	2.6
Lower bound	4.6	3.1

$$C_{a,1,u} = \frac{V_{c,1} \cdot e^{-V_{c,1} \cdot t_c / 3600}}{1 - e^{-V_{c,1} \cdot t_f / 3600}} = \frac{190 \cdot e^{-190 \cdot 4,1 / 3600}}{1 - e^{-190 \cdot 2,6 / 3600}} = 1193 \text{ veic./h}$$

$$C_{a,1,l} = \frac{190 \cdot e^{-190 \cdot 4,6 / 3600}}{1 - e^{-190 \cdot 3,1 / 3600}} = 987 \text{ veic./h}$$

$$C_{a,2,u} = \frac{300 \cdot e^{-300 \cdot 4,1 / 3600}}{1 - e^{-300 \cdot 2,6 / 3600}} = 1094 \text{ veic./h}$$

$$C_{a,2,l} = \frac{300 \cdot e^{-300 \cdot 4,6 / 3600}}{1 - e^{-300 \cdot 3,1 / 3600}} = 898 \text{ veic./h}$$

$$C_{a,3,u} = \frac{214 \cdot e^{-214 \cdot 4,1 / 3600}}{1 - e^{-214 \cdot 2,6 / 3600}} = 1171 \text{ veic./h}$$

$$C_{a,3,l} = \frac{214 \cdot e^{-214 \cdot 4,6 / 3600}}{1 - e^{-214 \cdot 3,1 / 3600}} = 967 \text{ veic./h}$$

$$C_{a,4,u} = \frac{418 \cdot e^{-418 \cdot 4,1 / 3600}}{1 - e^{-418 \cdot 2,6 / 3600}} = 996 \text{ veic./h}$$

$$C_{a,4,l} = \frac{418 \cdot e^{-418 \cdot 4,6 / 3600}}{1 - e^{-418 \cdot 3,1 / 3600}} = 810 \text{ veic./h}$$

Metodo USA – Esempio (2)

$$C_{m,1} = 1090 \text{ v/h}; C_{m,2} = 996 \text{ v/h}; C_{m,3} = 1069 \text{ v/h}; C_{m,4} = 903 \text{ v/h};$$

$$d_1 = \frac{3600}{C_{m,1}} + 900 \cdot T \cdot \left[\frac{V_1}{C_{m,1}} - 1 + \sqrt{\left(\frac{V_1}{C_{m,1}} - 1 \right)^2 + \frac{3600 \cdot V_1}{C_{m,1} \cdot C_{m,1}}} \right] = \frac{3600}{1090} + 900 \cdot 0,25 \cdot \left[\frac{340}{1090} - 1 + \sqrt{\left(\frac{340}{1090} - 1 \right)^2 + \frac{3600 \cdot 340}{1090 \cdot 1090}} \right] = 4,793 \text{ [s]}$$

$$L_1 = V_1 \cdot \frac{d_1}{3600} = 340 \cdot \frac{4,793}{3600} = 0,453 \text{ [veic.]}$$

$$Q_{95} = 900 \cdot T \cdot \left[\frac{V_1}{C_{m,1}} - 1 + \sqrt{\left(\frac{V_1}{C_{m,1}} - 1 \right)^2 + \frac{3600 \cdot V_1}{C_{m,1} \cdot C_{m,1}}} \right] \cdot \frac{C_{m,1}}{3600} = +900 \cdot 0,25 \cdot \left[\frac{340}{1090} - 1 + \sqrt{\left(\frac{340}{1090} - 1 \right)^2 + \frac{3600 \cdot 340}{1090 \cdot 1090}} \right] \cdot \frac{1090}{3600} = 1,341 \text{ [veic.]}$$

Confronti e considerazioni

	Braccio 1	Braccio 2	Braccio 3	Braccio 4
Germania	1285	1230	1273	1171
SETRA	1415	1133	1422	1039
CETUR	1988	1930	1982	1817
USA	1090	996	1069	903

Capacità in presenza di flusso pedonale

$$C_{ped} = C_e \cdot M$$

Metodo di Brilon, Struwe e Drews

dove M dipende dalla configurazione degli ingressi:

- Entrata ad 1 corsia

$$M = \frac{1119,5 - 0,715Q_c - 0,644Q_{ped} + 0,00073Q_c Q_{ped}}{1069 - 0,65Q_c}$$

- Entrata a 2 corsie

$$M = \frac{1260,6 - 0,381Q_{ped} - 0,329Q_c}{1380 - 0,50Q_c}$$

con:

Q_c = flusso circolante all'anello in prossimità dell'ingresso considerato (veh/h)

Q_{ped} = flusso di traffico pedonale in attraversamento del braccio considerato (ped/h)

Capacità in presenza di flusso pedonale

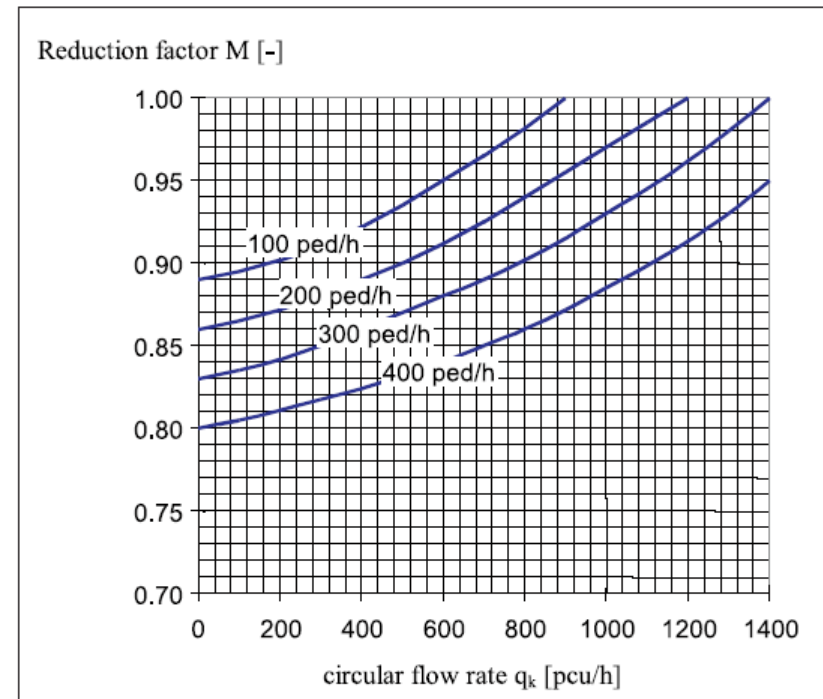
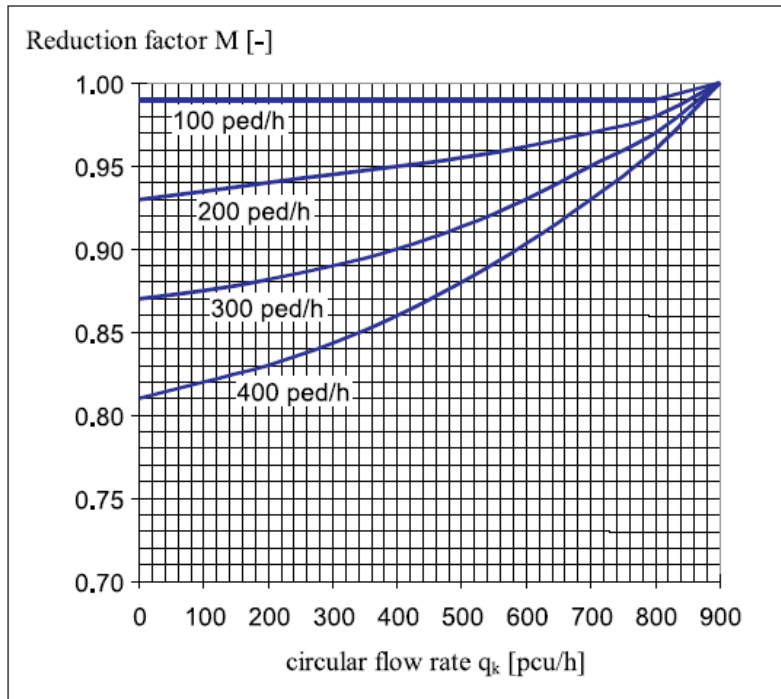

Capacità delle uscite e dell'anello

Da osservazioni sperimentali per le uscite, si sono ricavati valori del limite di capacità per corsia di 1200÷1400 veh/h.

Tipo di rotatoria	Numero di corsie agli ingressi	Capacità dell'anello [veh/h]
Rotatorie ad 1 corsia all'anello (minirotorie e rotatorie compatte)	1	1600
Rotatorie compatte con 2 corsie all'anello	1	1600
	2	1600
Grandi rotatorie	1	2000
	2	2500

Calcolo flussi

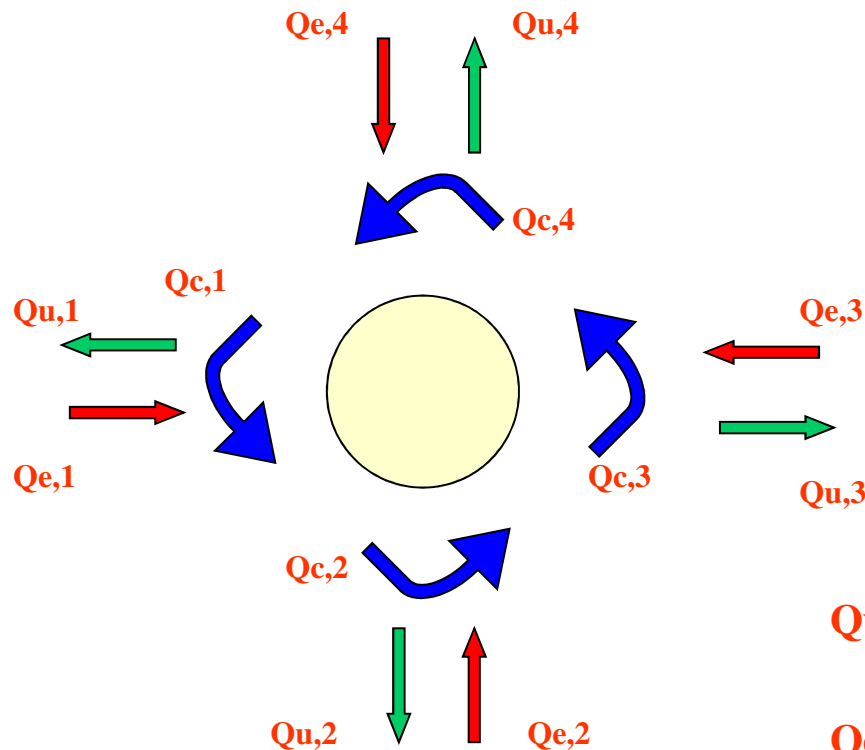

Uscite	1	2	3	4
Ingressi				
1	0,00	0,18	0,65	0,17
2	0,20	0,00	0,21	0,59
3	0,72	0,10	0,00	0,18
4	0,20	0,70	0,10	0,00

$$Qe,1=700; Qe,2=525; Qe,3=310; Qe,4=430$$

$$Qu,1= Qe,2*0,20+Qe,3*0,72+Qe,4*0,20$$

$$Qc,1= Qe,4*0,70+Qe,4*0,10+Qe,3*0,10$$

Flusso
entrato in
4 e uscente
in 2

Flusso
entrato in
4 e uscente
in 3

Flusso
entrato in
3 e uscente
in 2

Zone di scambio (1)

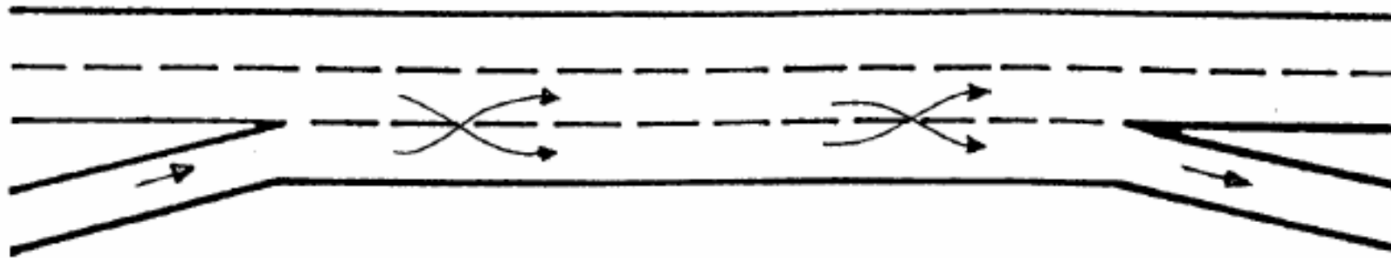
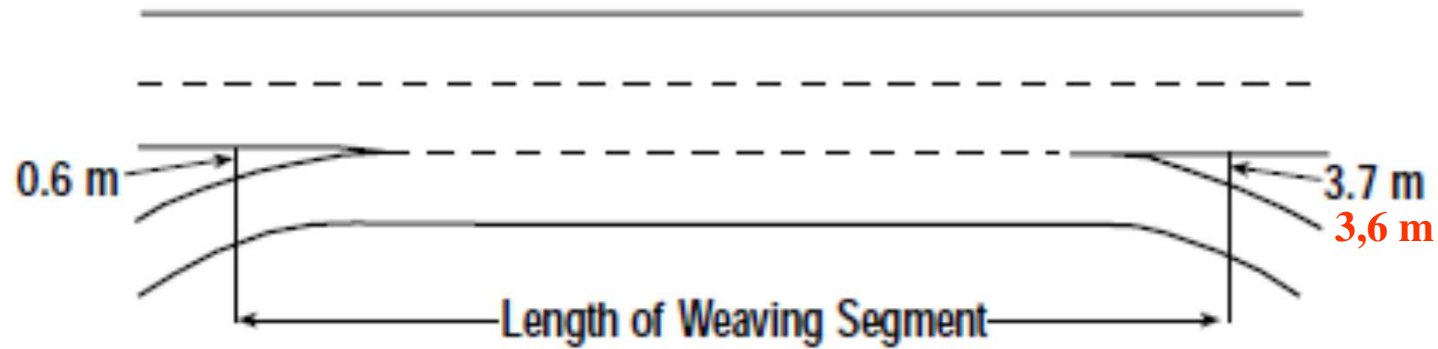

EXHIBIT 13-11. MEASURING THE LENGTH OF A WEAVING SEGMENT



Zone di scambio (2)

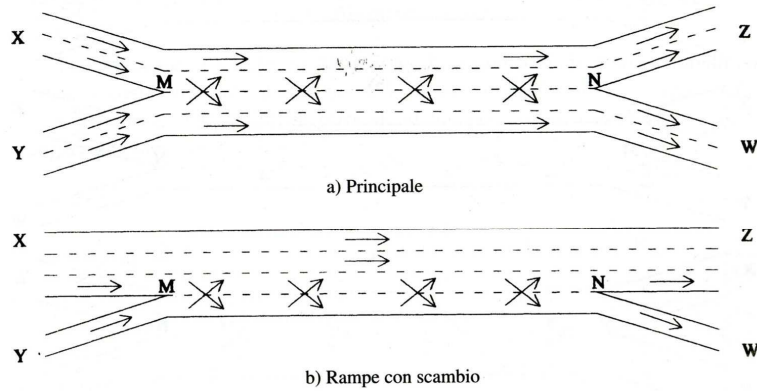

Fig.2 - Zone di scambio di tipo A

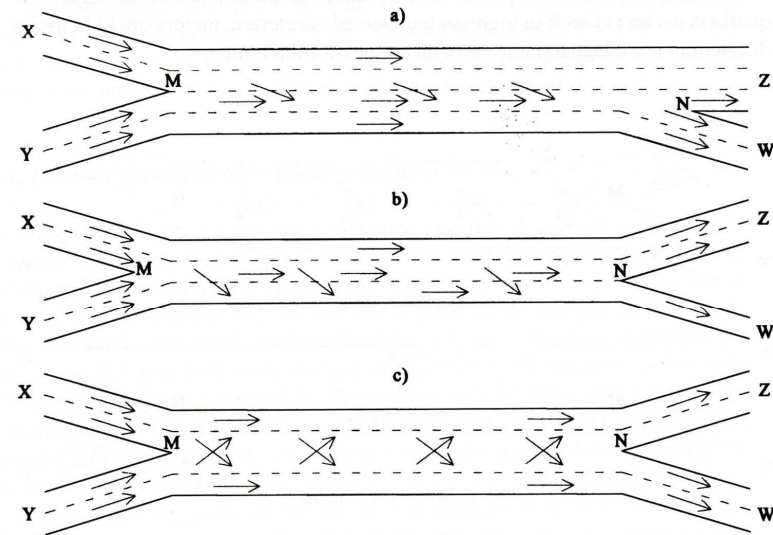

Fig.3 - Zone di scambio di tipo B

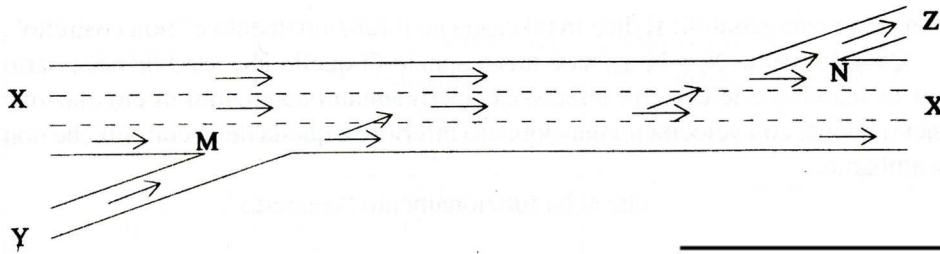

Fig.4 - Zona di scambio di tipo C

EXHIBIT 24-5. DETERMINING CONFIGURATION TYPE

Number of Lane Changes Required by Movement v_{w1}	Number of Lane Changes Required by Movement v_{w2}		
	0	1	≥ 2
0	Type B	Type B	Type C
1	Type B	Type A	N/A
≥ 2	Type C	N/A	N/A

Note:
N/A = not applicable; configuration is not feasible.

Zone di scambio (3)

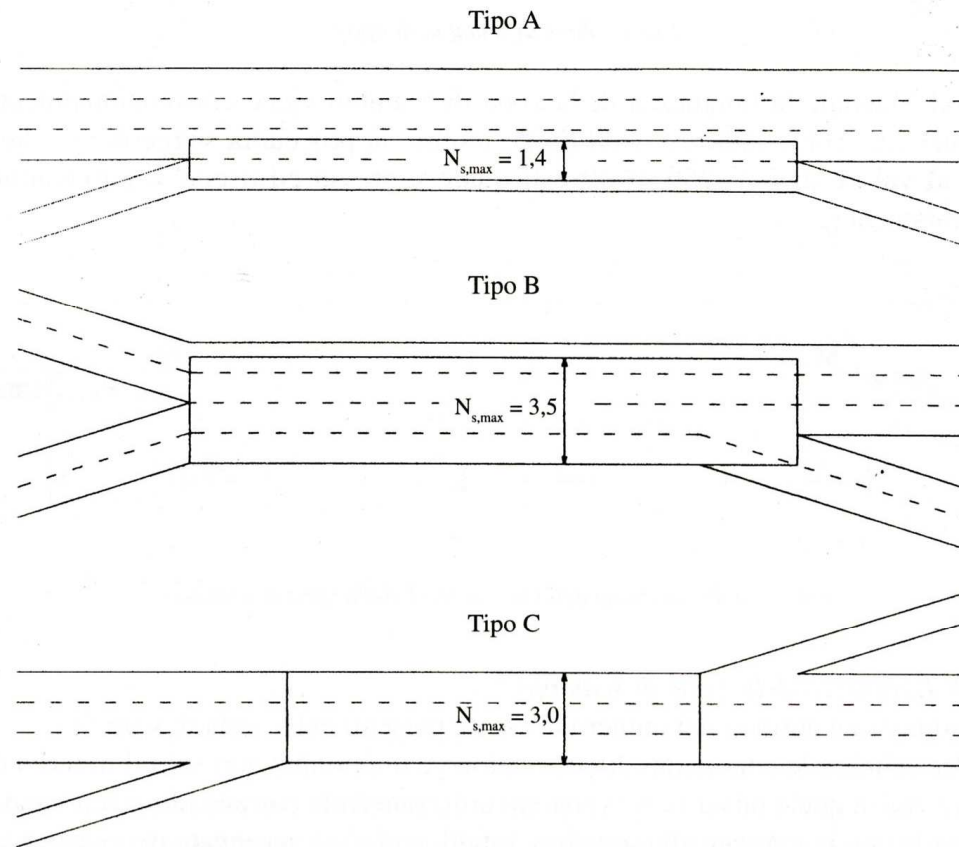

Fig.6 – Massimo numero di corsie utilizzabili dalle correnti che scambiano

Zone di scambio (4)

EXHIBIT 24-2. LOS CRITERIA FOR WEAVING SEGMENTS

LOS	Density (pc/km/ln)	
	Freeway Weaving Segment	Multilane and Collector-Distributor Weaving Segments
A	≤ 6.0	≤ 8.0
B	> 6.0–12.0	> 8.0–15.0
C	> 12.0–17.0	> 15.0–20.0
D	> 17.0–22.0	> 20.0–23.0
E	> 22.0–27.0	> 23.0–25.0
F	> 27.0	> 25.0

EXHIBIT 13-13. EXAMPLE SERVICE VOLUMES FOR FREEWAY WEAVING SEGMENTS
(SEE FOOTNOTE FOR ASSUMED VALUES)

Weaving Section Number of Lanes	Service Volumes (veh/h) for LOS				
	A	B	C	D	E
Type A					
3	1710	3010	3920	4740	5490
4	2280	4010	5230	6320	7330
5	2850	5010	6540	7930	9260
Type B					
3	1780	3290	4430	5490	6320
4	2380	4390	5900	7320	8430
5	2970	5490	7380	9140	10,540
Type C					
3	1790	3280	4380	5400	6320
4	2380	4370	5840	7200	8430

Note:
Assumptions: FFS = 120 km/h, PHF = 0.90, 5 percent trucks, level terrain, volume ratio = 0.20, weaving segment length = 300 m.

Zone di scambio (5)

EXHIBIT 24-3. PARAMETERS AFFECTING WEAVING SEGMENT OPERATION

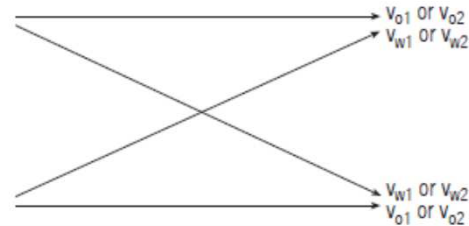

Symbol	Definition
L	Length of weaving segment (m)
N	Total number of lanes in the weaving segment
N_w	Number of lanes to be used by weaving vehicles if unconstrained operation is to be achieved
$N_w(\max)$	Maximum number of lanes that can be used by weaving vehicles for a given configuration
N_{nw}	Number of lanes used by nonweaving vehicles
v	Total flow rate in the weaving segment (pc/h)
V_{o1}	Larger of the two outer, or nonweaving, flow rates in the weaving segment (pc/h)
V_{o2}	Smaller of the two outer, or nonweaving, flow rates in the weaving segment (pc/h)
V_{w1}	Larger of the two weaving flow rates in the weaving segment (pc/h)
V_{w2}	Smaller of the two weaving flow rates in the weaving segment (pc/h)
V_w	Total weaving flow rate in the weaving segment (pc/h) ($V_w = V_{w1} + V_{w2}$)
V_{nw}	Total nonweaving flow rate in the weaving segment (pc/h) ($V_{nw} = V_{o1} + V_{o2}$)
VR	Volume ratio; the ratio of weaving flow rate to total flow rate in the weaving segment ($VR = V_w/v$)
R	Weaving ratio; the ratio of the smaller weaving flow rate to total weaving flow rate ($R = V_{w2}/V_w$)
S_w	Speed of weaving vehicles in the weaving segment (km/h)
S_{nw}	Speed of nonweaving vehicles in the weaving segment (km/h)
S	Speed of all vehicles in the weaving segment (km/h)
D	Density of all vehicles in the weaving segment (pc/km/ln)
W_w	Weaving intensity factor for prediction of weaving speed
W_{nw}	Weaving intensity factor for prediction of nonweaving speed

Zone di scambio (6)

$$S_i = S_{\min} + \frac{S_{\max} - S_{\min}}{1 + W_i} \quad (24-2)$$

where

- S_i = average speed of weaving ($i = w$) or nonweaving ($i = nw$) vehicles (km/h),
 S_{\min} = minimum speed expected in a weaving segment (km/h),
 S_{\max} = maximum speed expected in a weaving segment (km/h), and
 W_i = weaving intensity factor for weaving ($i = w$) and nonweaving ($i = nw$) flows.

$$S_i = 24 + \frac{S_{FF} - 16}{1 + W_i} \quad (24-3)$$

where S_{FF} is the average free-flow speed of the freeway segments entering and leaving the weaving segment (km/h).

Zone di scambio (7)

EXHIBIT 24-6. CONSTANTS FOR COMPUTATION OF WEAVING INTENSITY FACTORS

General Form								
$W = \frac{a(1+VR)^b \left(\frac{v}{N}\right)^c}{(3.28L)^d}$								
	Constants for Weaving Speed, S_w				Constants for Nonweaving Speed, S_{nw}			
	a	b	c	d	a	b	c	d
Type A Configuration								
Unconstrained	0.15	2.2	0.97	0.80	0.0035	4.0	1.3	0.75
Constrained	0.35	2.2	0.97	0.80	0.0020	4.0	1.3	0.75
Type B Configuration								
Unconstrained	0.08	2.2	0.70	0.50	0.0020	6.0	1.0	0.50
Constrained	0.15	2.2	0.70	0.50	0.0010	6.0	1.0	0.50
Type C Configuration								
Unconstrained	0.08	2.3	0.80	0.60	0.0020	6.0	1.1	0.60
Constrained	0.14	2.3	0.80	0.60	0.0010	6.0	1.1	0.60

where

- W_i = weaving intensity factors for weaving ($i = w$) and nonweaving ($i = nw$) flows;
- VR = volume ratio;
- v = total flow rate in the weaving segment (pc/h);
- N = total number of lanes in the weaving segment;
- L = length of the weaving segment (m); and
- a, b, c, d = constants of calibration.

Zone di scambio (8)

EXHIBIT 24-7. CRITERIA FOR UNCONSTRAINED VERSUS CONSTRAINED OPERATION OF WEAVING SEGMENTS

Configuration	Number of Lanes Required for Unconstrained Operation, N_w	$N_w(\text{max})$
Type A	$1.21(N) VR^{0.571} L^{0.234} / S_w^{0.438}$	1.4
Type B	$N[0.085 + 0.703VR + (71.57/L) - 0.0112(S_{nw} - S_w)]$	3.5
Type C	$N[0.761 + 0.047VR - 0.00036L - 0.0031(S_{nw} - S_w)]$	3.0 ^a

Note:

a. For two-sided weaving segments, all freeway lanes may be used by weaving vehicles.

Zone di scambio (9)

$$S = \frac{v}{\left(\frac{v_w}{S_w}\right) + \left(\frac{v_{nw}}{S_{nw}}\right)} \quad (24-5)$$

where

- S = space mean speed of all vehicles in the weaving segment (km/h),
- S_w = space mean speed of weaving vehicles in the weaving segment (km/h),
- S_{nw} = space mean speed of nonweaving vehicles in the weaving segment (km/h),
- v = total flow rate in the weaving segment (pc/h),
- v_w = weaving flow rate in the weaving segment (pc/h), and
- v_{nw} = nonweaving flow rate in the weaving segment (pc/h).

$$D = \frac{\left(\frac{v}{N}\right)}{S} \quad (24-6)$$

where D is the average density for all vehicles in the weaving segment (pc/km/ln).

Zone di scambio (10)

EXHIBIT 24-8. CAPACITY FOR VARIOUS WEAVING SEGMENTS

(A) Type A Weaving Segments—120-km/h Free-Flow Speed					
Volume Ratio, VR	Length of Weaving Segment (m)				
	150	300	450	600	750 ^a
Three-Lane Segments					
0.10	6050	6820	7200 ^b	7200 ^b	7200 ^b
0.20	5490	6260	6720	7050	7200 ^b
0.30	5040	5780	6240	6570	6830
0.40	4660	5380	5530	5800 ^c	6050 ^c
0.45 ^d	4430	5000 ^c	5270 ^c	5550 ^c	5800 ^c
Four-Lane Segments					
0.10	8060	9010	9600 ^b	9600 ^b	9600 ^b
0.20	7320	8340	8960	9400	9600 ^b
0.30	6710	7520 ^c	8090 ^c	8510 ^c	8840
0.35 ^e	6370 ^c	7160 ^c	7700 ^c	8000 ^f	8000 ^f
Five-Lane Segments					
0.10	10,080	11,380	12,000 ^b	12,000 ^b	12,000 ^b
0.20 ^g	9150	10,540 ^c	11,270 ^c	11,790 ^c	12,000 ^b
(B) Type A Weaving Segments—110-km/h Free-Flow Speed					
Volume Ratio, VR	Length of Weaving Segment (m)				
	150	300	450	600	750 ^a
Three-Lane Segments					
0.10	5770	6470	6880	7050 ^b	7050 ^b
0.20	5250	5960	6280	6680	6900
0.30	4830	5520	5940	6240	6480
0.40	4480	5150	5250 ^c	5530 ^c	5760 ^c
0.45 ^d	4190	4790 ^c	5020 ^c	5310 ^c	5530 ^c
Four-Lane Segments					
0.10	7690	8630	9180	9400 ^b	9400 ^b
0.20	7000	7940	8500	8900	9200
0.30	6440	7180 ^c	7710 ^c	8090 ^c	8390 ^c
0.35 ^e	6080 ^c	6830 ^c	7360 ^c	7730 ^c	8030 ^c
Five-Lane Segments					
0.10	9610	10,790	11,470	11,750 ^b	11,750 ^b
0.20 ^g	8750	10,030 ^c	10,690 ^c	11,160 ^c	11,520 ^c

Notes:
Refer to the last page of Exhibit 24-8.

EXHIBIT 24-8 (CONTINUED). CAPACITY FOR VARIOUS WEAVING SEGMENTS

(C) Type A Weaving Segments—100-km/h Free-Flow Speed					
Volume Ratio, VR	Length of Weaving Segment (m)				
	150	300	450	600	750 ^a
Three-Lane Segments					
0.10	5470	6110	6480	6730	6910
0.20	5000	5640	6020	6290	6490
0.30	4610	5240	5620	5900	6110
0.40	4290	4900	4990 ^c	5250 ^c	5460 ^c
0.45 ^d	4000	4520 ^c	4790 ^c	5040 ^c	5200 ^c
Four-Lane Segments					
0.10	7300	8150	8630	8970	9220
0.20	6660	7520	8030	8380	8650
0.30	6080 ^c	6830 ^c	7310 ^c	7650 ^c	7920 ^c
0.35 ^e	5780 ^c	6520 ^c	6990 ^c	7330 ^c	7600 ^c
Five-Lane Segments					
0.10	9120	10,180	10,790	11,210	11,500 ^b
0.20 ^g	8330	9500 ^c	10,080 ^c	10,510 ^c	10,830 ^c
(D) Type A Weaving Segments—90-km/h Free-Flow Speed					
Volume Ratio, VR	Length of Weaving Segment (m)				
	150	300	450	600	750 ^a
Three-Lane Segments					
0.10	5160	5730	6050	6270	6430
0.20	4730	5310	5650	5880	6060
0.30	4380	4850	5290	5540	5720
0.40	4090	4420 ^c	4730 ^c	4960 ^c	5140 ^c
0.45 ^d	3850	4240 ^c	4470 ^c	4780 ^c	4950 ^c
Four-Lane Segments					
0.10	6880	7460	8070	8350	8570
0.20	6310	7080	7530	7840	8080
0.30	5790 ^c	6360 ^c	6890 ^c	7190 ^c	7430 ^c
0.35 ^e	5520 ^c	6180 ^c	6590 ^c	6910 ^c	7140 ^c
Five-Lane Segments					
0.10	8600	9550	10,080	10,440	10,710
0.20 ^g	8060 ^c	8930 ^c	9460 ^c	9820 ^c	10,100 ^c

Notes:
Refer to the last page of Exhibit 24-8.

Zone di scambio (11)

EXHIBIT 24-8 (CONTINUED). CAPACITY FOR VARIOUS WEAVING SEGMENTS

(E) Type B Weaving Segments—120-km/h Free-Flow Speed					
Volume Ratio, VR	Length of Weaving Segment (m)				
	150	300	450	600	750 ^a
Three-Lane Segments					
0.10	7200 ^b	7200 ^b	7200 ^b	7200 ^b	7200 ^b
0.20	6830	7200 ^b	7200 ^b	7200 ^b	7200 ^b
0.30	6120	6690	7010	7200 ^b	7200 ^b
0.40	5550	6100	6430	6670	6850
0.50	5100	5630	5950	6180	6370
0.60	4750	5260	5570	5800	5980
0.70	4180	4990	5290	5520	5690
0.80 ^h	3900	4820	5000 ^f	5000 ^f	5000 ^f
Four-Lane Segments					
0.10	9600 ^b	9600 ^b	9600 ^b	9600 ^b	9600 ^b
0.20	9110	9600 ^b	9600 ^b	9600 ^b	9600 ^b
0.30	8170	8910	9350	9600 ^b	9600 ^b
0.40	7400	8140	8570	8890	9130
0.50	6670 ^c	7500	7930	8000 ^f	8000 ^f
0.60	6070 ^c	6670 ^f	6670 ^f	6670 ^f	6670 ^f
0.70	5580 ^c	5760 ^f	5760 ^f	5760 ^f	5760 ^f
0.80 ^h	5000 ^f	5000 ^f	5000 ^f	5000 ^f	5000 ^f
Five-Lane Segments					
0.10	12,000 ^b	12,000 ^b	12,000 ^b	12,000 ^b	12,000 ^b
0.20	11,390	12,000 ^b	12,000 ^b	12,000 ^b	12,000 ^b
0.30	10,210	11,140	11,690	12,000 ^b	12,000 ^b
0.40	9270 ^c	10,000 ^f	10,000 ^f	10,000 ^f	10,000 ^f
0.50	8000 ^f	8000 ^f	8000 ^f	8000 ^f	8000 ^f
0.60	6670 ^f	6670 ^f	6670 ^f	6670 ^f	6670 ^f
0.70	5760 ^f	5760 ^f	5760 ^f	5760 ^f	5760 ^f
0.80 ^h	5000 ^f	5000 ^f	5000 ^f	5000 ^f	5000 ^f

Notes:
Refer to the last page of Exhibit 24-8.

EXHIBIT 24-8 (CONTINUED). CAPACITY FOR VARIOUS WEAVING SEGMENTS

(F) Type B Weaving Segments—110-km/h Free-Flow Speed					
Volume Ratio, VR	Length of Weaving Segment (m)				
	150	300	450	600	750 ^a
Three-Lane Segments					
0.10	7050 ^b	7050 ^b	7050 ^b	7050 ^b	7050 ^b
0.20	6460	6950	7050 ^b	7050 ^b	7050 ^b
0.30	5810	6320	6620	6830	6980
0.40	5280	5790	6090	6300	6470
0.50	4860	5350	5650	5860	6030
0.60	4550	5010	5300	5510	5680
0.70	4320	4770	5050	5250	5410
0.80 ^h	3650	4600	4880	5000 ^f	5000 ^f
Four-Lane Segments					
0.10	9400 ^b	9400 ^b	9400 ^b	9400 ^b	9400 ^b
0.20	8610	9270	9400 ^b	9400 ^b	9400 ^b
0.30	7750	8430	8820	9100	9310
0.40	7040	7720	8120	8400	8620
0.50	6370 ^c	7140	7530	7820	8000 ^f
0.60	5810 ^c	6670 ^f	6670 ^f	6670 ^f	6670 ^f
0.70	5350 ^c	5760 ^f	5760 ^f	5760 ^f	5760 ^f
0.80 ^h	5000 ^f	5000 ^f	5000 ^f	5000 ^f	5000 ^f
Five-Lane Segments					
0.10	11,750 ^b	11,750 ^b	11,750 ^b	11,750 ^b	11,750 ^b
0.20	10,760	11,590	11,750 ^b	11,750 ^b	11,750 ^b
0.30	9690	10,540	11,030	11,370	11,640
0.40	8830 ^c	9650	10,000 ^f	10,000 ^f	10,000 ^f
0.50	7960 ^c	8000 ^f	8000 ^f	8000 ^f	8000 ^f
0.60	6670 ^f	6670 ^f	6670 ^f	6670 ^f	6670 ^f
0.70	5760 ^f	5760 ^f	5760 ^f	5760 ^f	5760 ^f
0.80 ^h	5000 ^f	5000 ^f	5000 ^f	5000 ^f	5000 ^f

Notes:
Refer to the last page of Exhibit 24-8.

Zone di scambio (12)

EXHIBIT 24-8 (CONTINUED). CAPACITY FOR VARIOUS WEAVING SEGMENTS

(G) Type B Weaving Segments—100-km/h Free-Flow Speed					
Volume Ratio, VR	Length of Weaving Segment (m)				
	150	300	450	600	750 ^a
Three-Lane Segments					
0.10	6750	6900 ^b	6900 ^b	6900 ^b	6900 ^b
0.20	6070	6510	6750	6900 ^b	6900 ^b
0.30	5490	5950	6210	6400	6540
0.40	5010	5470	5740	5930	6070
0.50	4620	5070	5340	5530	5680
0.60	4330	4760	5020	5220	5360
0.70	4120	4530	4790	4970	5120
0.80 ^h	3600	4380	4630	4820	4960
Four-Lane Segments					
0.10	9000	9200 ^b	9200 ^b	9200 ^b	9200 ^b
0.20	8100	8680	9010	9200 ^b	9200 ^b
0.30	7320	7930	8280	8530	8710
0.40	6680	7290	7650	7900	8100
0.50	6060 ^c	6760	7120	7370	7580
0.60	5540 ^c	6340	6670 ^f	6670 ^f	6670 ^f
0.70	5130 ^c	5640 ^b	5760 ^f	5760 ^f	5760 ^f
0.80 ^h	4800 ^c	5000 ^f	5000 ^f	5000 ^f	5000 ^f
Five-Lane Segments					
0.10	11,250	11,500 ^b	11,500 ^b	11,500 ^b	11,500 ^b
0.20	10,120	10,850	11,260	11,500 ^b	11,500 ^b
0.30	9150	9910	10,350	10,660	10,890
0.40	8370 ^c	9110	9560	9880	10,000 ^f
0.50	7570 ^c	8000 ^f	8000 ^f	8000 ^f	8000 ^f
0.60	6670 ^f	6670 ^f	6670 ^f	6670 ^f	6670 ^f
0.70	5760 ^f	5760 ^f	5760 ^f	5760 ^f	5760 ^f
0.80 ^h	5000 ^f	5000 ^f	5000 ^f	5000 ^f	5000 ^f

Notes:
Refer to the last page of Exhibit 24-8.

EXHIBIT 24-8 (CONTINUED). CAPACITY FOR VARIOUS WEAVING SEGMENTS

(H) Type B Weaving Segments—90-km/h Free-Flow Speed					
Volume Ratio, VR	Length of Weaving Segment (m)				
	150	300	450	600	750 ^a
Three-Lane Segments					
0.10	6270	6600	6750 ^b	6750 ^b	6750 ^b
0.20	5670	6050	6270	6410	6520
0.30	5150	5560	5790	5950	6070
0.40	4720	5130	5370	5540	5670
0.50	4370	4770	5010	5190	5320
0.60	4110	4500	4730	4900	5030
0.70	3910	4290	4520	4690	4820
0.80 ^h	3440	4150	4380	4540	4670
Four-Lane Segments					
0.10	8350	8800	9000 ^b	9000 ^b	9000 ^b
0.20	7560	8070	8360	8550	8690
0.30	6870	7410	7720	7940	8100
0.40	6290	6840	7160	7390	7560
0.50	5740 ^c	6360	6680	6920	7090
0.60	5270 ^c	5990	6310	6530	6670 ^f
0.70	4890 ^c	5350 ^c	5760 ^f	5760 ^f	5760 ^f
0.80 ^h	4590 ^c	5000 ^f	5000 ^f	5000 ^f	5000 ^f
Five-Lane Segments					
0.10	10,440	10,990	11,250 ^b	11,250 ^b	11,250 ^b
0.20	9450	10,090	10,440	10,680	10,860
0.30	8580	9260	9650	9920	10,120
0.40	7890 ^c	8550	8950	9230	9450
0.50	7170 ^c	7960	8000 ^f	8000 ^f	8000 ^f
0.60	6580 ^c	6670 ^f	6670 ^f	6670 ^f	6670 ^f
0.70	5760 ^f	5760 ^f	5760 ^f	5760 ^f	5760 ^f
0.80 ^h	5000 ^f	5000 ^f	5000 ^f	5000 ^f	5000 ^f

Notes:
Refer to the last page of Exhibit 24-8.

Zone di scambio (13)

EXHIBIT 24-8 (CONTINUED). CAPACITY FOR VARIOUS WEAVING SEGMENTS

(I) Type C Weaving Segments—120-km/h Free-Flow Speed					
Volume Ratio, VR	Length of Weaving Segment (m)				
	150	300	450	600	750 ^a
Three-Lane Segments					
0.10	7200 ^b	7200 ^b	7200 ^b	7200 ^b	7200 ^b
0.20	6590	7200 ^b	7200 ^b	7200 ^b	7200 ^b
0.30	5890	6540	6930	7200	7200 ^b
0.40	5530	5960	6350	6620	6840
0.50 ^f	4890	5500	5870	6140	6360
Four-Lane Segments					
0.10	9600 ^b	9600 ^b	9600 ^b	9600 ^b	9600 ^b
0.20	8780	9600 ^b	9600 ^b	9600 ^b	9600 ^b
0.30	7850	8720	9230	9590	9600 ^b
0.40	7110	7950	8470	8750 ^f	8750 ^f
0.50 ^f	6520	7000 ^f	7000 ^f	7000 ^f	7000 ^f
Five-Lane Segments					
0.10	12,000 ^b	12,000 ^b	12,000 ^b	12,000 ^b	12,000 ^b
0.20	11,520 ^c	12,000 ^b	12,000 ^b	12,000 ^b	12,000 ^b
0.30	10,140 ^c	11,170 ^c	11,670 ^f	11,670 ^f	11,670 ^f
0.40	8750 ^f	8750 ^f	8750 ^f	8750 ^f	8750 ^f
0.50 ^f	7000 ^f	7000 ^f	7000 ^f	7000 ^f	7000 ^f
(J) Type C Weaving Segments—110-km/h Free-Flow Speed					
Volume Ratio, VR	Length of Weaving Segment (m)				
	150	300	450	600	750 ^a
Three-Lane Segments					
0.10	7010	7050 ^b	7050 ^b	7050 ^b	7050 ^b
0.20	6240	6830	7050 ^b	7050 ^b	7050 ^b
0.30	5610	6200	6550	6790	6980
0.40	5090	5670	6020	6270	6470
0.50 ^f	4680	5240	5590	5840	6030
Four-Lane Segments					
0.10	9350	9400 ^b	9400 ^b	9400 ^b	9400 ^b
0.20	8320	9100	9400 ^b	9400 ^b	9400 ^b
0.30	7470	8270	8730	9060	9300
0.40	6240	7560	8030	8360	8620
0.50 ^f	5830	6990	7000 ^f	7000 ^f	7000 ^f
Five-Lane Segments					
0.10	11,750 ^b	11,750 ^b	11,750 ^b	11,750 ^b	11,750 ^b
0.20	10,900 ^c	11,750 ^b	11,750 ^b	11,750 ^b	11,750 ^b
0.30	9630 ^c	10,570 ^c	10,910	11,320	11,630
0.40	8590 ^c	8750 ^f	8750 ^f	8750 ^f	8750 ^f
0.50 ^f	7000 ^f	7000 ^f	7000 ^f	7000 ^f	7000 ^f

Notes:
Refer to the last page of Exhibit 24-8.

EXHIBIT 24-8 (CONTINUED). CAPACITY FOR VARIOUS WEAVING SEGMENTS

(K) Type C Weaving Segments—100-km/h Free-Flow Speed					
Volume Ratio, VR	Length of Weaving Segment (m)				
	150	300	450	600	750 ^a
Three-Lane Segments					
0.10	6570	6900 ^b	6900 ^b	6900 ^b	6900 ^b
0.20	5890	6410	6700	6900	6900 ^b
0.30	5310	5850	6160	6370	6540
0.40	4840	5370	5680	5910	6080
0.50 ^j	4460	4970	5290	5510	5690
Four-Lane Segments					
0.10	8760	9200 ^b	9200 ^b	9200 ^b	9200 ^b
0.20	7850	8540	8930	9200	9200 ^b
0.30	7080	7790	8210	8500	8720
0.40	6450	7150	7580	7880	8110
0.50 ^j	5950	6630	7000 ^f	7000 ^f	7000 ^f
Five-Lane Segments					
0.10	11,500 ^b	11,500 ^b	11,500 ^b	11,500 ^b	11,500 ^b
0.20	10,250 ^c	11,050 ^c	11,170	11,500	11,500 ^b
0.30	9110 ^c	9960 ^c	10,260	10,620	10,900
0.40	8170 ^c	8750 ^f	8750 ^f	8750 ^f	8750 ^f
0.50 ^j	7000 ^f	7000 ^f	7000 ^f	7000 ^f	7000 ^f

Notes:
Refer to the last page of Exhibit 24-8.

Zone di scambio (14)

EXHIBIT 24-8 (CONTINUED). CAPACITY FOR VARIOUS WEAVING SEGMENTS

(L) Type C Weaving Segments—90-km/h Free-Flow Speed					
Volume Ratio, VR	Length of Weaving Segment (m)				
	150	300	450	600	750 ^a
Three-Lane Segments					
0.10	6120	6520	6730	6750 ^b	6750 ^b
0.20	5510	5970	6230	6400	6520
0.30	5000	5480	5750	5940	6090
0.40	4570	5050	5330	5530	5680
0.50 ⁱ	4230	4700	4980	5180	5330
Four-Lane Segments					
0.10	8150	8700	8980	9000 ^b	9000 ^b
0.20	7350	7960	8300	8530	8700
0.30	6660	7300	7670	7920	8110
0.40	5640	6730	7110	7370	7580
0.50 ^j	5300	6260	6640	6900	7000 ^f
Five-Lane Segments					
0.10	10,770 ^c	11,250 ^b	11,230	11,250 ^b	11,250 ^b
0.20	9580 ^c	10,270 ^c	10,380	10,660	10,870
0.30	8570 ^c	9310 ^c	9580	9900	10,140
0.40	7720 ^c	8470 ^c	8750 ^f	8750 ^f	8750 ^f
0.50 ^j	7000 ^f	7000 ^f	7000 ^f	7000 ^f	7000 ^f

Notes:

- a. Weaving segments longer than 750 m are treated as isolated merge and diverge areas using the procedures of Chapter 25, "Ramps and Ramp Junctions."
- b. Capacity constrained by basic freeway capacity.
- c. Capacity occurs under constrained operating conditions.
- d. Three-lane Type A segments do not operate well at volume ratios greater than 0.45. Poor operations and some local queuing are expected in such cases.
- e. Four-lane Type A segments do not operate well at volume ratios greater than 0.35. Poor operations and some local queuing are expected in such cases.
- f. Capacity constrained by maximum allowable weaving flow rate: 2,800 pc/h (Type A), 4,000 (Type B), 3,500 (Type C).
- g. Five-lane Type A segments do not operate well at volume ratios greater than 0.20. Poor operations and some local queuing are expected in such cases.
- h. Type B weaving segments do not operate well at volume ratios greater than 0.80. Poor operations and some local queuing are expected in such cases.
- i. Type C weaving segments do not operate well at volume ratios greater than 0.50. Poor operations and some local queuing are expected in such cases.