

Course of Geodynamics

Dr. Magdala Tesauro

Course Outline:

1. Thermo-physical structure of the continental and oceanic crust
2. Thermo-physical structure of the continental lithosphere
3. Thermo-physical structure of the oceanic lithosphere and oceanic ridges
4. Rheology and mechanics of the lithosphere
5. **Plate tectonics and boundary forces**
6. Hot spots, plumes, and convection
7. Subduction zones systems
8. Orogens formation and evolution
9. Sedimentary basins formation and evolution



Geologic evidence for continental drift

There are many geologic features that can be correlated across juxtaposed continental margins:

1. **Fold belts:** e.g., the continuity of the Appalachian fold belt of eastern North America with the Caledonian fold belt of northern Europe.
2. **Age provinces:** matching of Precambrian cratons and rocks of Paleozoic age.
3. **Igneous provinces:** Distinctive igneous rocks can be traced between continents.
4. **Stratigraphic sections:** Distinctive stratigraphic sequences can also be correlated between adjacent continents.
4. **Metallogenic provinces:** Regions containing manganese, iron ore, gold, and tin can be matched across adjacent coastlines .

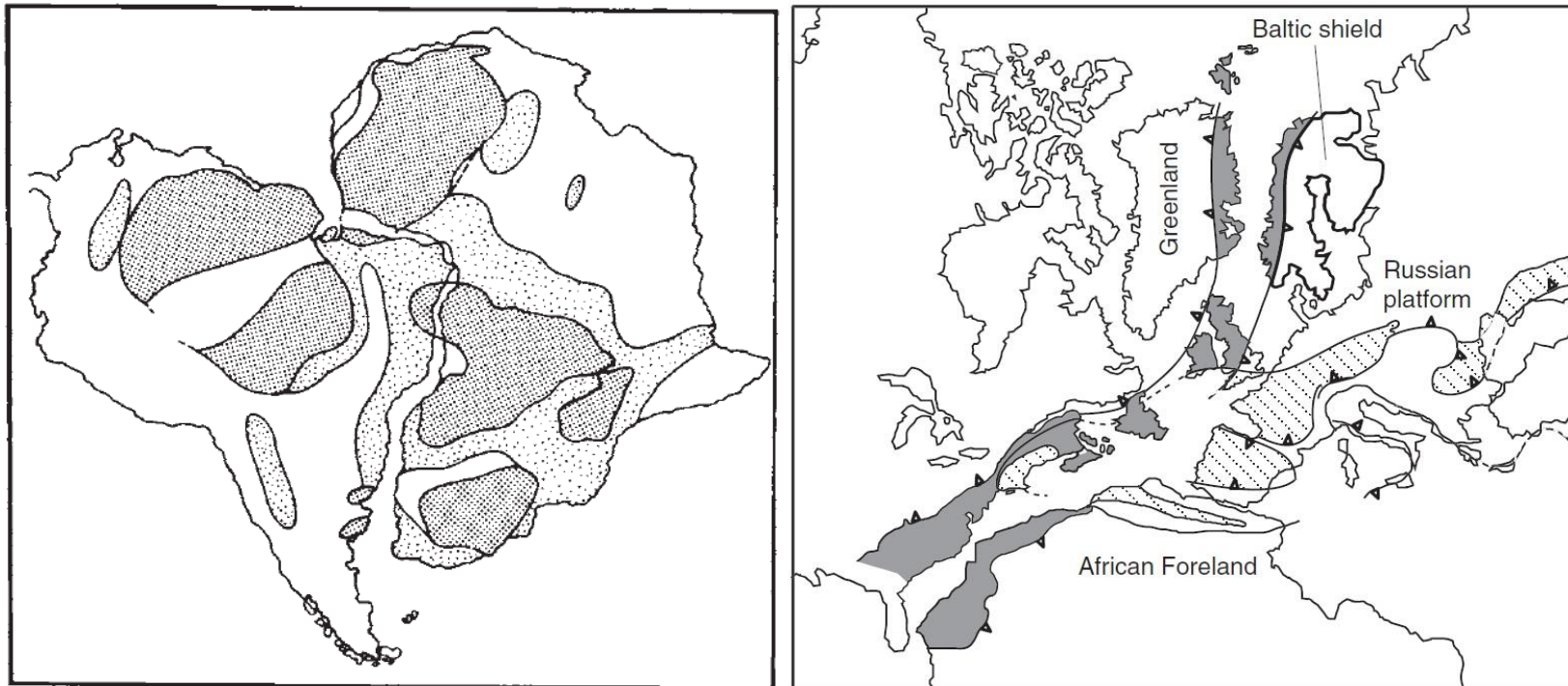
Correlation of cratons and younger mobile belts



-  Cratons
-  Younger mobile belts

Stratigraphy Correlations

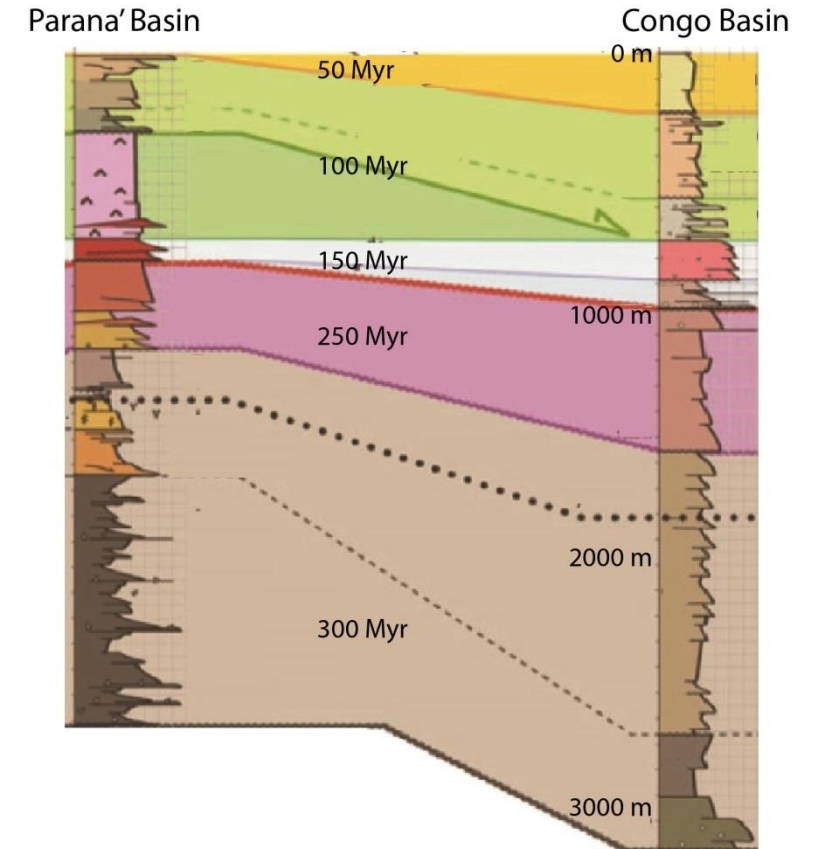

Geologic evidence for continental drift: Paleoclimatology

Paleoclimatology is used to demonstrate that continents have drifted at least in a north–south sense:

- During the Permian and Carboniferous the Gondwana continents were experiencing an extensive glaciation and must have been situated near the south pole.
- The northern continents were instead experiencing a tropical climate in equatorial latitudes, since extensive reef and evaporites deposits have been found.

Carbonates and reef deposits: They are restricted to warm water in the range 25– 30°C (within 30° of the equator at the present day).

Evaporites: Evaporites are formed under hot arid conditions in regions where evaporation exceeds seawater influx and/or precipitation. They form in the arid subtropical high pressure zones between about 10° and 50°.

Red-beds: These include arkoses, sandstones, shales, and conglomerates that contain hematite. They form under oxidizing conditions where there is an adequate supply of iron, at present they are restricted to latitudes < 30°, where dehydration of limonite into hematite occurs.

Coal: It is formed by the accumulation and degradation of vegetation where the rate of accumulation exceeds that of removal and decay, which occurs in tropical rain forests, where growth rates are very high, or in temperate forests where growth is slower but decay is inhibited by cold winters (both at high and low latitudes).

Phosphorites: At the present day they form within 45° of the equator along the western margins of continents where upwellings of cold, nutrient-rich, deep water occur, or in arid zones at low latitudes.

Bauxite and laterite: These aluminum and iron oxides only form in a strongly oxidizing environment, under the conditions of tropical or subtropical weathering.

Desert deposits: the dune bedding of desert sandstones can be used to infer the ancient direction of the prevailing winds and thus can indicate if the continent has undergone any rotation.

Glacial deposits: Large glaciers and icecaps are limited to regions within about 30° of the poles at the present day.

Geologic evidence for continental drift: Paleontologic evidence

Continental drift has affected the distribution of ancient animals and plants by creating barriers to their dispersal or favouring their spreading:

- The past distribution of tetrapods implies that there must have been easy communication between all parts of Gondwana and Laurasia.
- Ancient faunal province boundaries frequently correlate with sutures (join lines between ancient continents brought into juxtaposition by the consumption of an intervening ocean).
- Plate tectonics can cause latitudinal motions of continents can create climatic conditions (un)suitable for certain organisms and changes in topography, which modify the habitats available for colonization.
- Continental drift influences the diversity of species, which increases towards the equator (ten times higher than at the poles).
- Diversity also increases with continental fragmentation: each continental fragment becomes a nucleus for the adaptive radiation of the species as a result of genetic isolation.
- Continental suturing leads to the homogenization of faunas by cross-migration and the extinction of any less well-adapted groups which afford stronger competition.

Geologic evidence for continental drift: Paleomagnetism

Paleomagnetism studies the fossil magnetism that is retained in certain rocks containing paramagnetic minerals (those having an odd number of electrons, which cause the atoms to act as small magnets):

- If this magnetism originated at the time the rock was formed, measurements of its direction can be used to determine the latitude at which the rock was created.
- If this latitude differs from the present latitude at which the rock is found, the continent where the rock is found moved over the surface of the Earth.
- If the pattern of movement differs from that of rocks of the same age on a different continent, relative movement must have occurred between them.
- Paramagnetic substances which contain a large number of unpaired electrons are termed ferromagnetic: The magnetic structure of these substances tends to devolve into a number of magnetic domains, within which the atoms are coupled by the interaction of the magnetic fields of the unpaired electrons (for $T <$ of the Curie temperature).
- Within each domain the internal alignment of linked atomic dipoles causes the domain to possess a net magnetic direction.
- After removal from the external field a preferred direction is retained so that the substance exhibits an overall magnetic directionality (remnant magnetism).

Geologic evidence for continental drift: Paleomagnetism

Detrital remanent magnetization

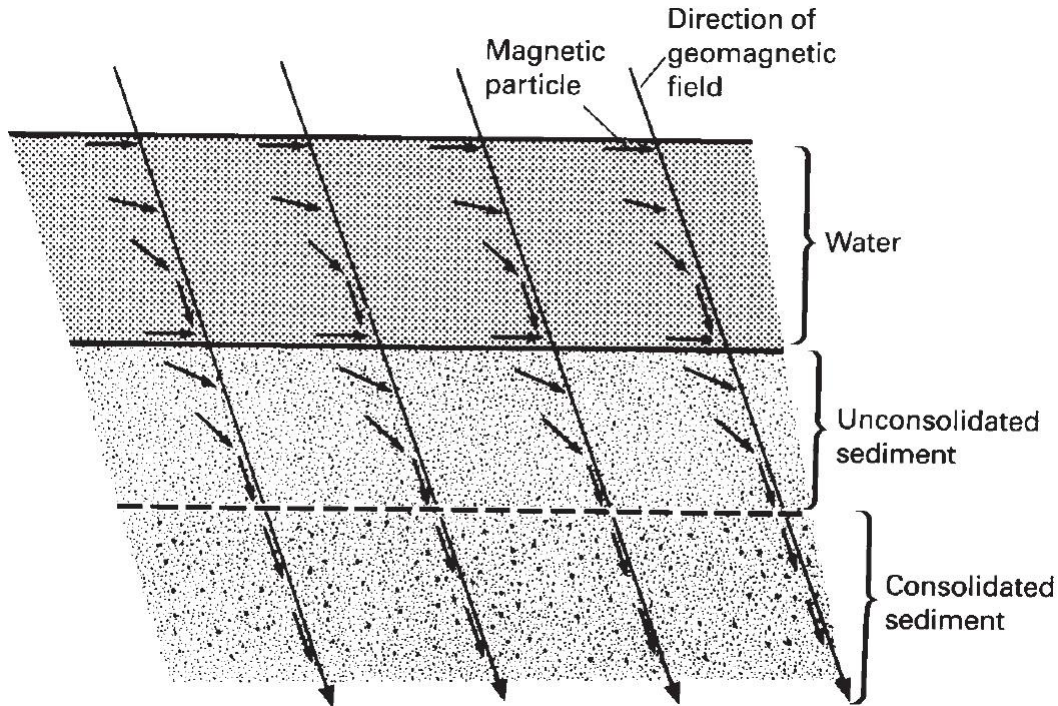

- A natural remnant magnetization (NRM) can be acquired by a rock during its formation (primary magnetization) or during the subsequent history of the rock (secondary magnetization).
- An igneous rock acquires a primary NRM during cooling (*thermoremanent magnetization*) below the Curie T (after solidification).
- A sedimentary rock acquires a primary NRM (*detrital remanent magnetization, DRM*) through a series of processes:
 - (1) On reaching bottom the particles flatten out, and assume an elongate form, preserving the azimuth of the geomagnetic field but not its inclination.
 - (2) After burial, the magnetic particles realign with the geomagnetic field as a result of microseismic activity, and
 - (3) this orientation is retained as the rock consolidates.

Secondary NRM is acquired during the subsequent history of the rock according to various possible mechanisms:

Chemical remanent magnetization (CRM) is acquired when ferromagnetic minerals are formed as a result of a chemical reaction, such as oxidation (e.g., during diagenesis or metamorphic events of known age).

Isothermal remanent magnetization (IRM) occurs in rocks which have been subjected to strong magnetic fields (e.g., in case of a lightning strike).

Viscous remanent magnetization (VRM) may arise when a rock remains in a relatively weak magnetic field over a long period of time as the magnetic domains relax and acquire the external field direction (it can be easily lost).

Geologic evidence for continental drift: Paleomagnetism

- The geomagnetic field undergoes progressive changes with time, resulting from variations in the convective circulation pattern in the core, known as *secular variation*. This implies that the direction of the magnetic field at a particular geographic location rotates irregularly with a periodicity of a few thousand years.
- The effects of secular variation can be removed by collecting samples from a site which span a stratigraphic interval of many thousands of years: averaging the data from these specimens should then remove secular variation so that the geomagnetic field in the past may be considered to originate from a dipole aligned along the Earth's axis of rotation.
- Paleomagnetic measurements provide the intensity, polarity, azimuth and inclination of the primary remnant magnetization, which reflect the geomagnetic parameters at the time and place at which the rock was formed:

(1) By assuming the axial geocentric dipole model for the geomagnetic field, the inclination I can be used to determine the paleolatitude φ at which the rock formed according to the relationship $2\tan\varphi = \tan I$; (2) With a knowledge of the paleolatitude and the azimuth of the primary remanent; (3) Such computations, combined with age determinations of the samples by radiometric or biostratigraphic methods, make it possible the calculation of the apparent location of the north magnetic pole at a particular time for the continent from which the samples were collected.

If a paleomagnetic study provides a magnetic pole position different from the present pole, it implies either that the magnetic pole has moved throughout geological time (unlikely since all theoretical models for the generation of the field predict a dominant dipole component paralleling the Earth's rotational axis) or continental drift.

Geologic evidence for continental drift: Paleomagnetism

Paleomagnetic data can be displayed in two ways:

- (1) Plotting the continent in a succession of positions according to the ages of the sampling sites, with the assumption of the paleo-longitudes of the sites.
- (2) Regarding the continent as remaining at a fixed position and plotting the apparent positions of the poles for various times to provide an *apparent polar wander* (APW) path.

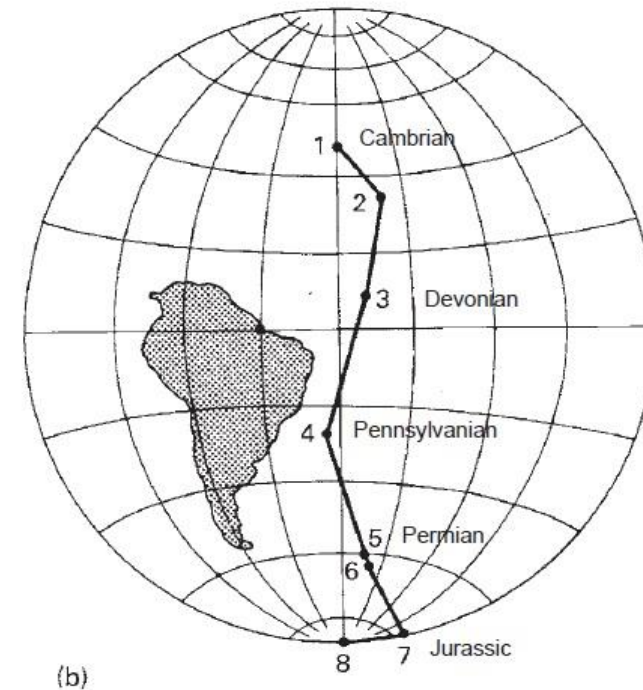
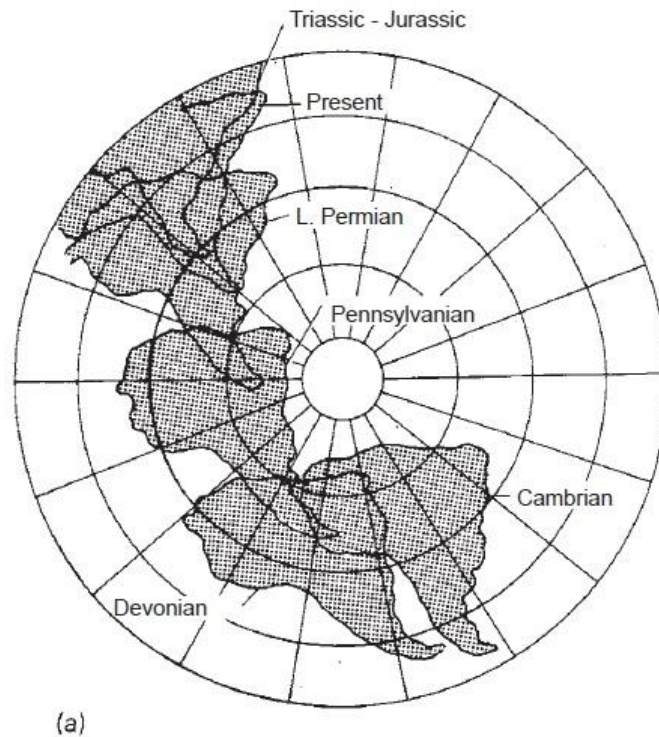

Since APW paths were different for different continents, we can demonstrate that relative movements of the continents had taken place, and thus continental drift had occurred.

Geologic evidence for continental drift: Paleomagnetism

APW paths for North America (*solid circles and solid line*) and Europe (*open circles and dashed line*) from the Ordovician to the Jurassic.

Result of rotating Europe and its APW path to close up the Atlantic Ocean.

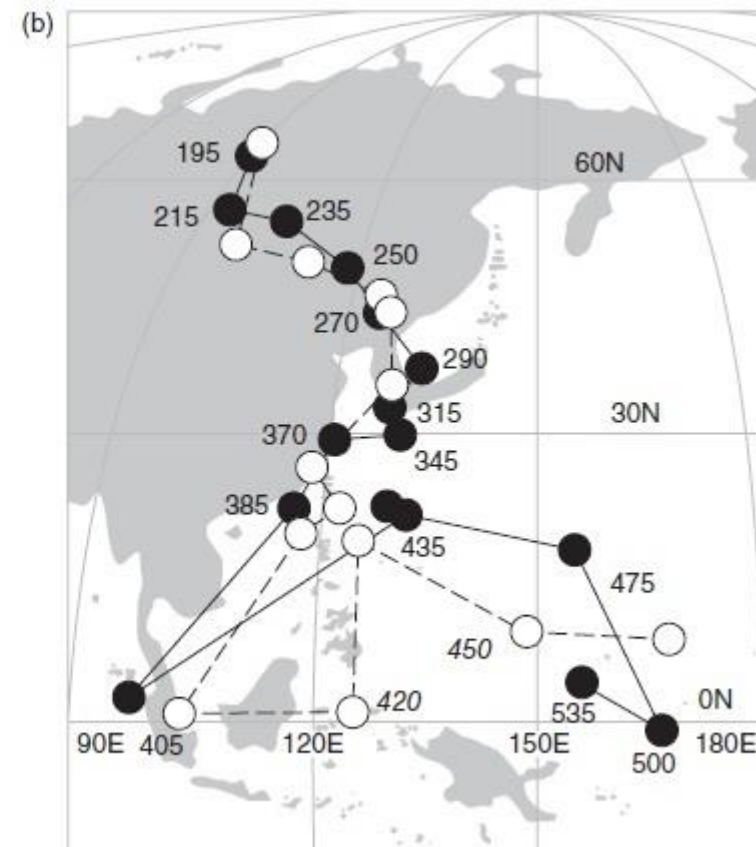
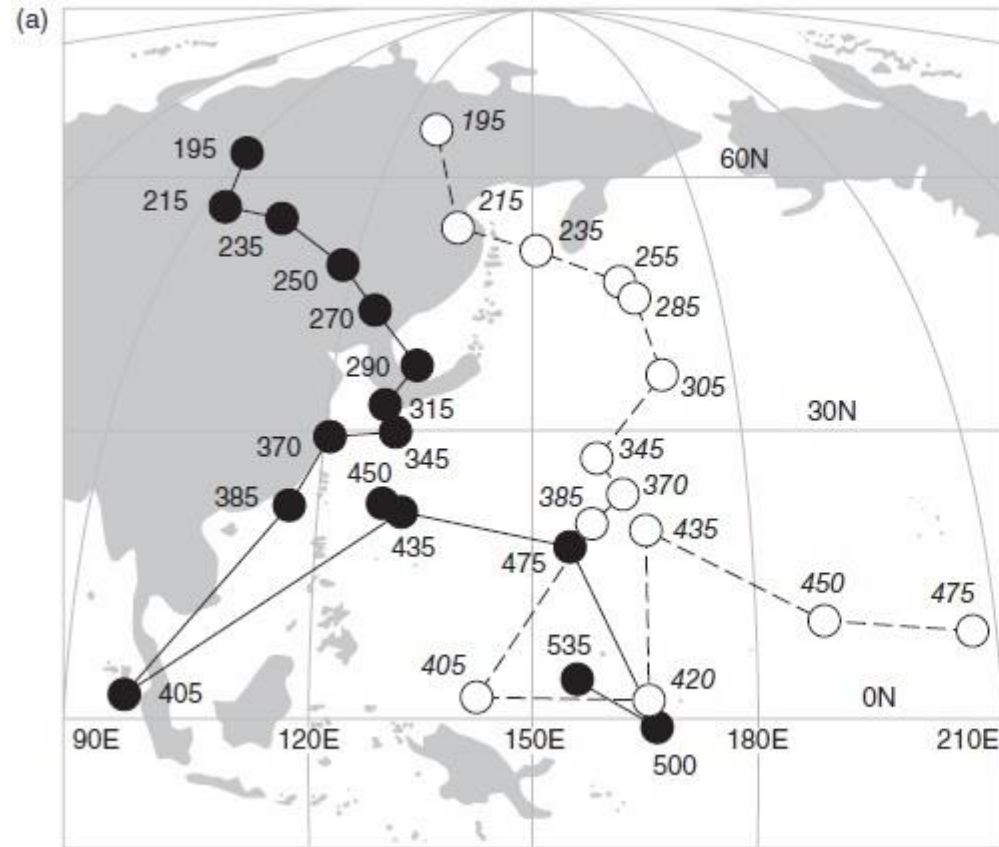

The APW paths for Europe and North America then correspond very closely from the time the continents were brought together at the end of the Caledonian orogeny, approximately 400 Myr ago, until the opening of the Atlantic.

Geologic evidence for continental drift: Paleomagnetism

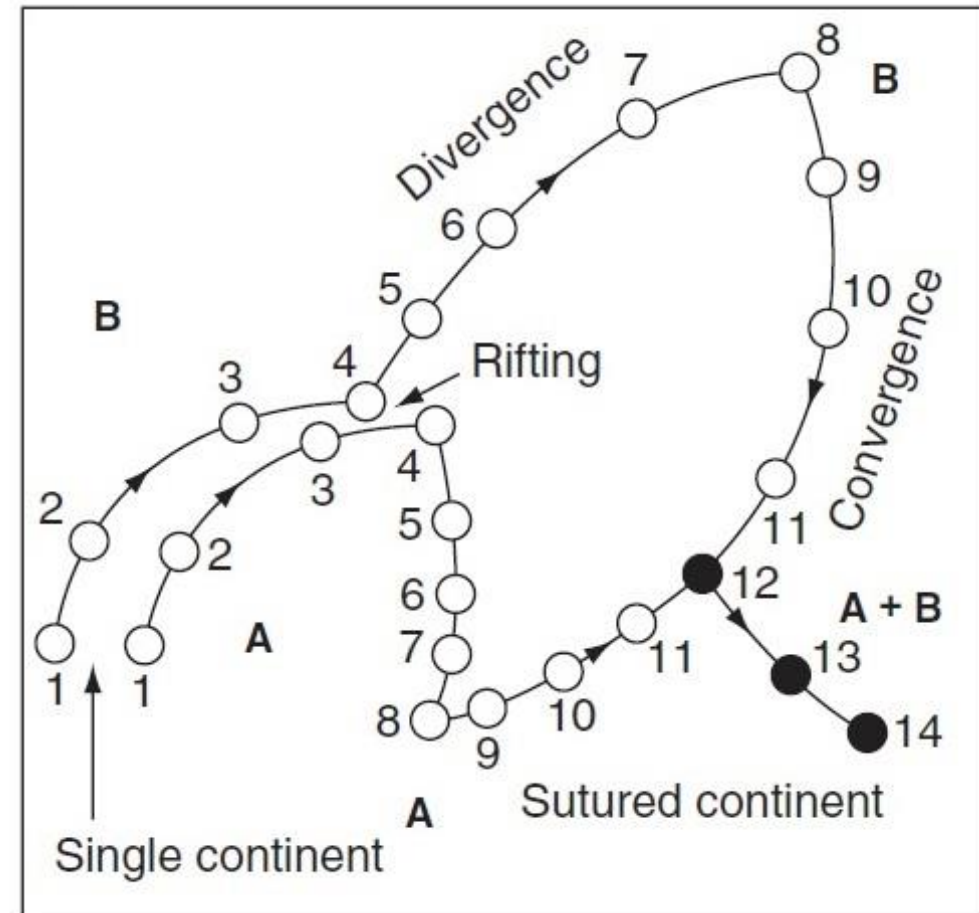
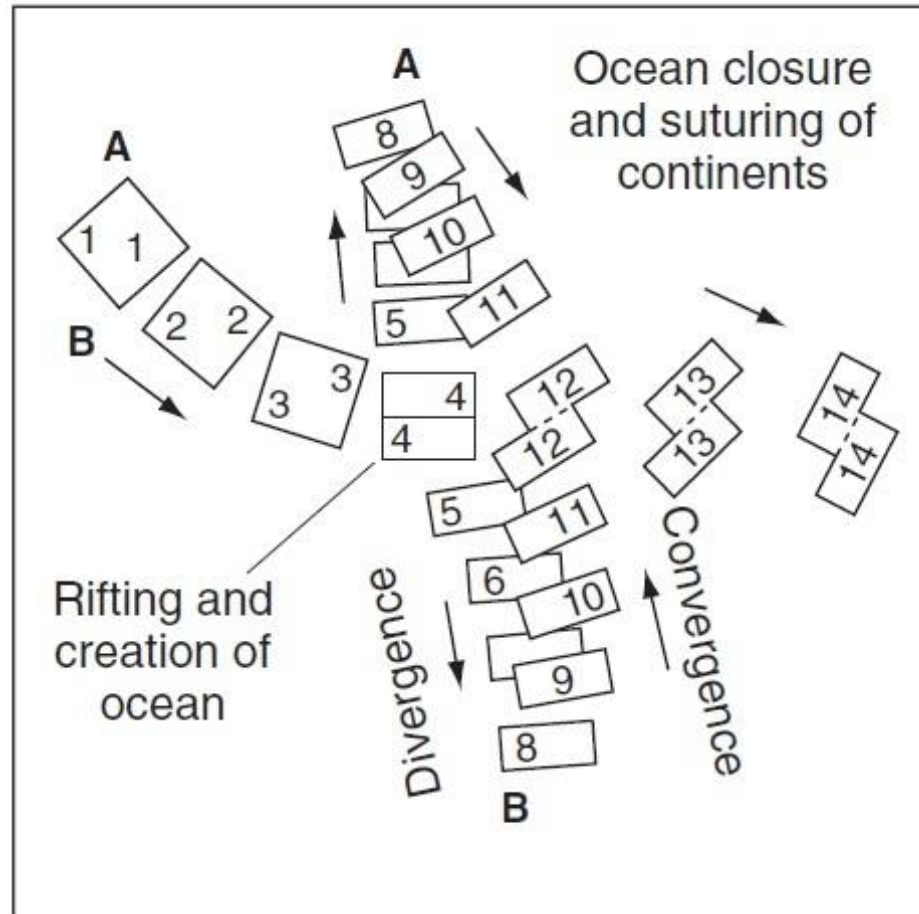

- Before rifting, the two segments A and B of the initial continent have similar APW paths.
- After rifting the two segments describe diverging APW paths until the hairpin at time 8 signals a change in direction of motion to one of convergence.
- After suturing at time 12 the two segments follow a common polar track.

Old Hypotheses on Earth dynamics

Contracting Earth hypothesis: Central region of the Earth underwent more rapid cooling/contraction than the outer part.

- The Earth is not cooling sufficiently rapidly to be consistent with contraction (cannot explain mountain belt formation).
- The lithosphere is not everywhere in compression, as required by this hypothesis (existence of ocean ridges and normal faults).

Earth in contraction

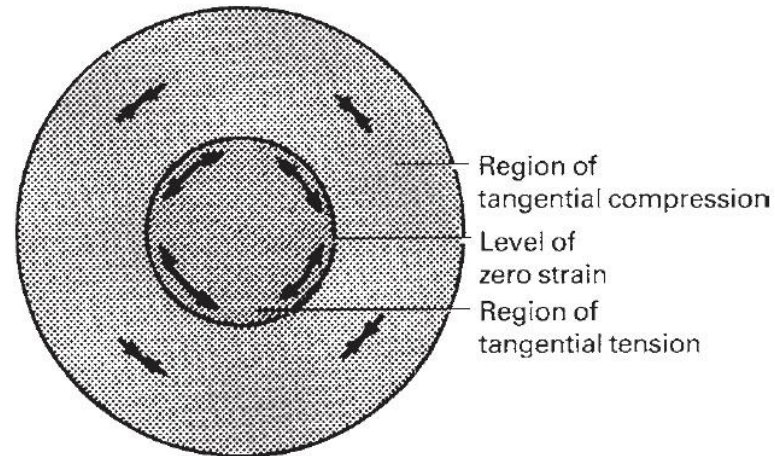

Expanding Earth hypothesis:

- The expanding Earth hypothesis proposed that the continental lithosphere was originally continuous over the surface of an Earth of smaller radius and that, as the Earth expanded and its surface area increased, the continental lithosphere fragmented and dispersed, allowing the mantle upwelling and formation of the ocean.
- This hypothesis correlate the period of rapid expansion with the break-up and fragmentation of Pangea in the past 200 Ma. During this period the surface area of the Earth would have increased by a factor of 2.5 implying an increase in the radius from 63% of its present value and a mean radial expansion rate of about 12 mm yr^{-1} .
- This hypothesis is wrong because (1) the Earth's radius has no significantly increased during the geological time: the tidal interaction of the Moon on the Earth is causing the latter's angular rotation to decelerate (the average increase of the length of day is 20 s Myr^{-1}) and thus the ancient (in the Devonian age) moment of inertia ($2MR^2/5$) was only slightly lower (99.5%) than its present value; (2) Drift occurred also before the Mesozoic time.

Plate tectonics

The lithosphere of the Earth is broken-up in several 'tectonic' plates, considered to be internally rigid

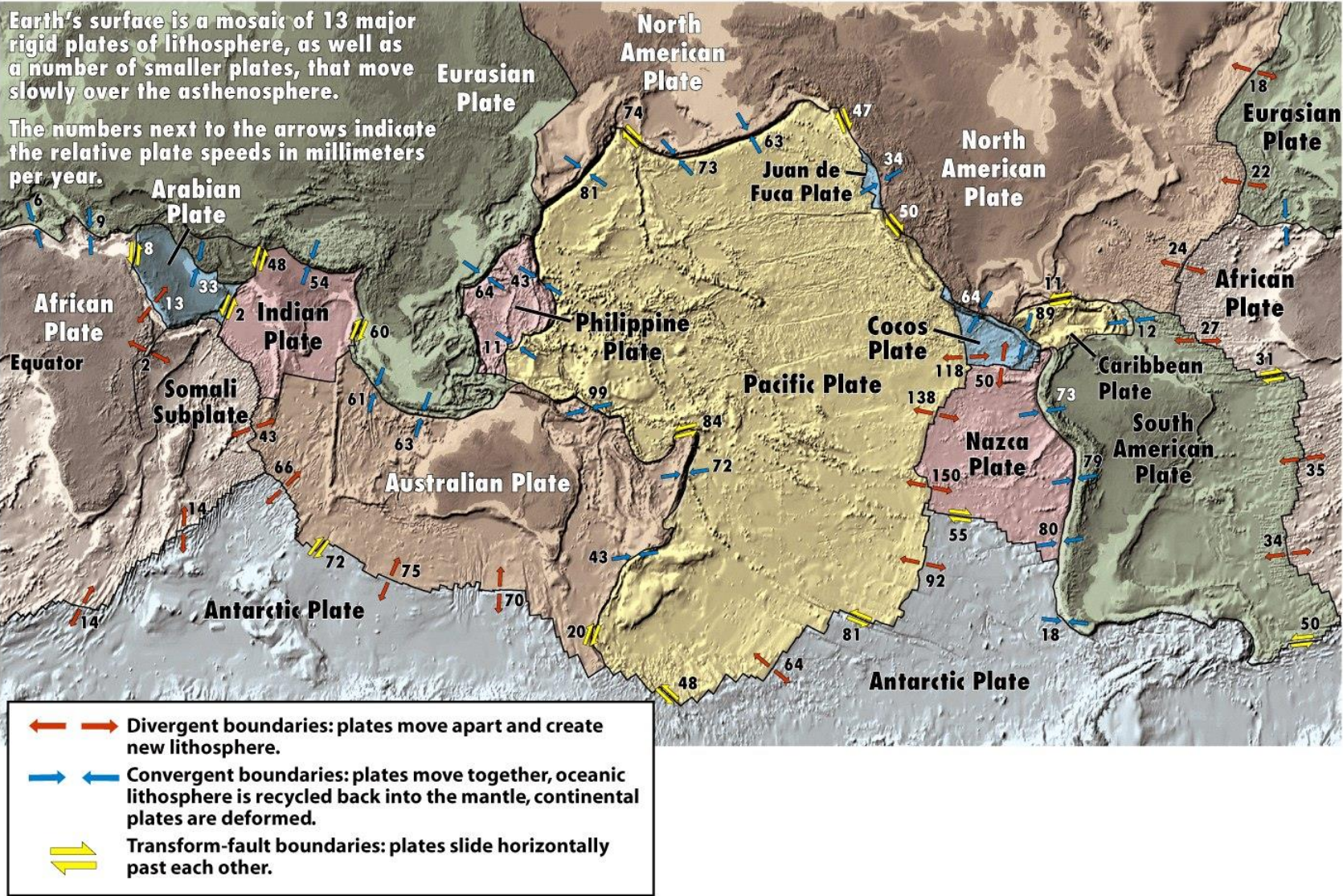

Figure 2-5
Understanding Earth, Fifth Edition
© 2007 W. H. Freeman and Company

Plate tectonics and seismic activity

Earthquakes since 1960

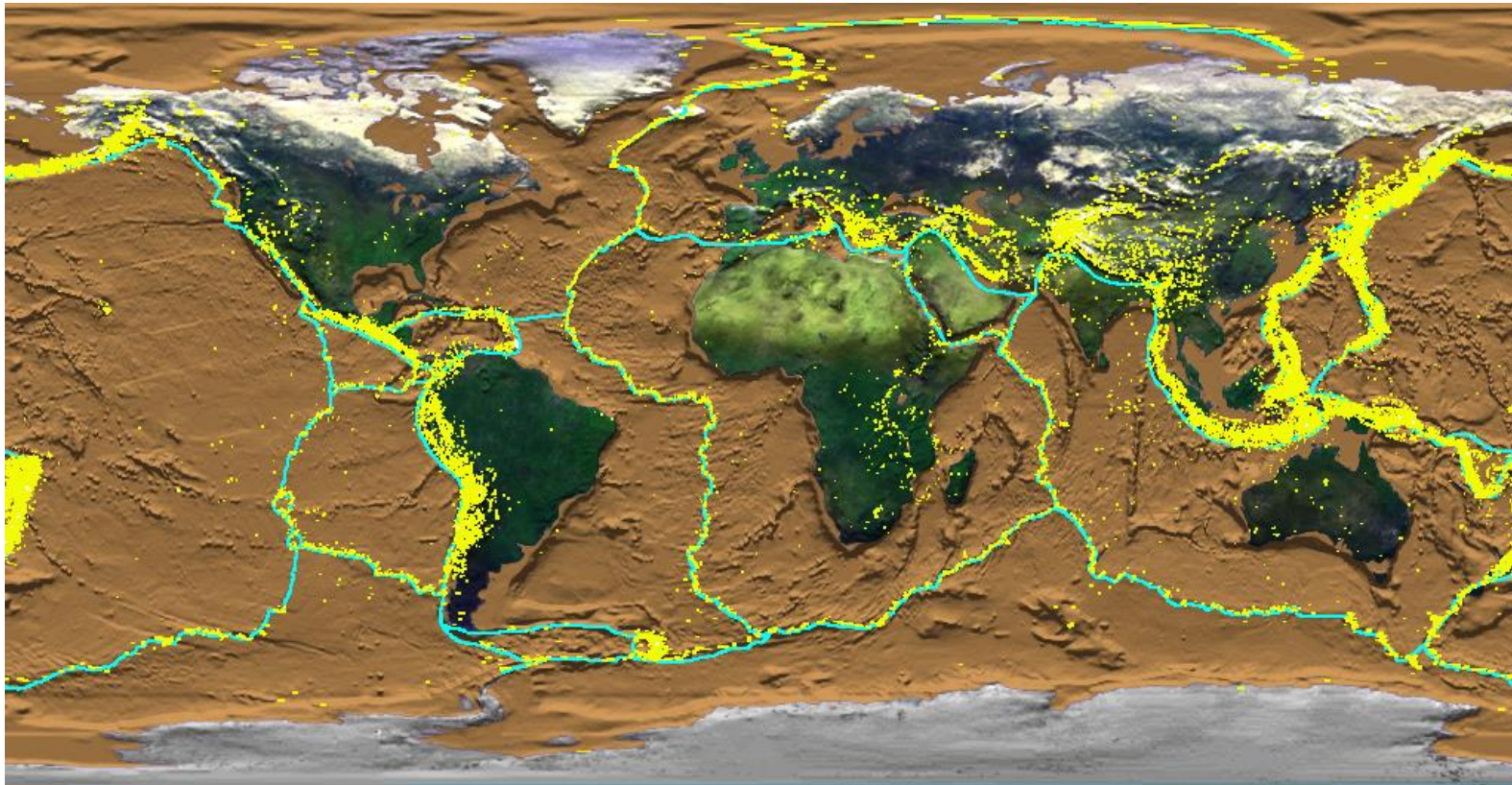

Plate tectonics and volcanism

Volcanism is predominantly confined to plate boundaries

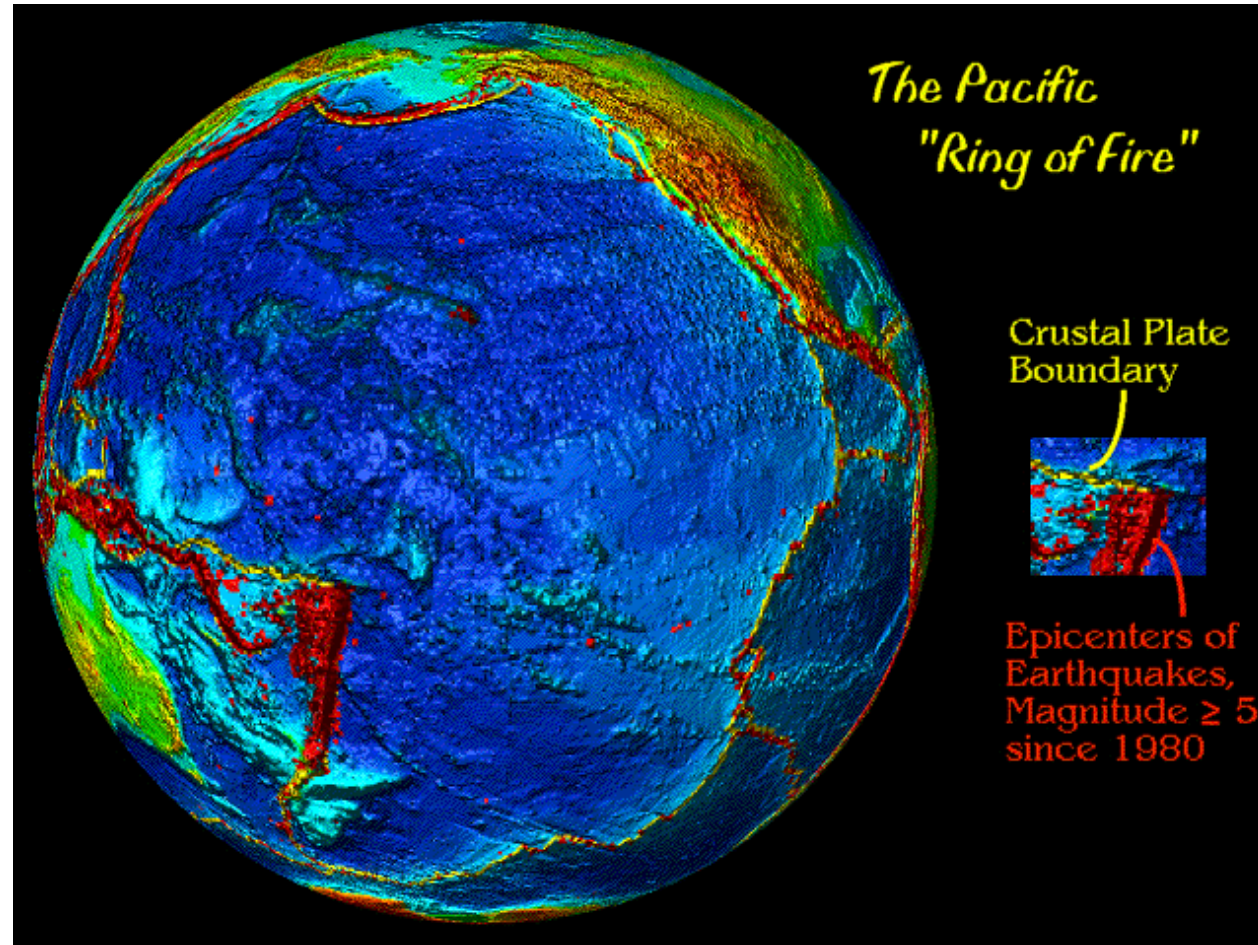
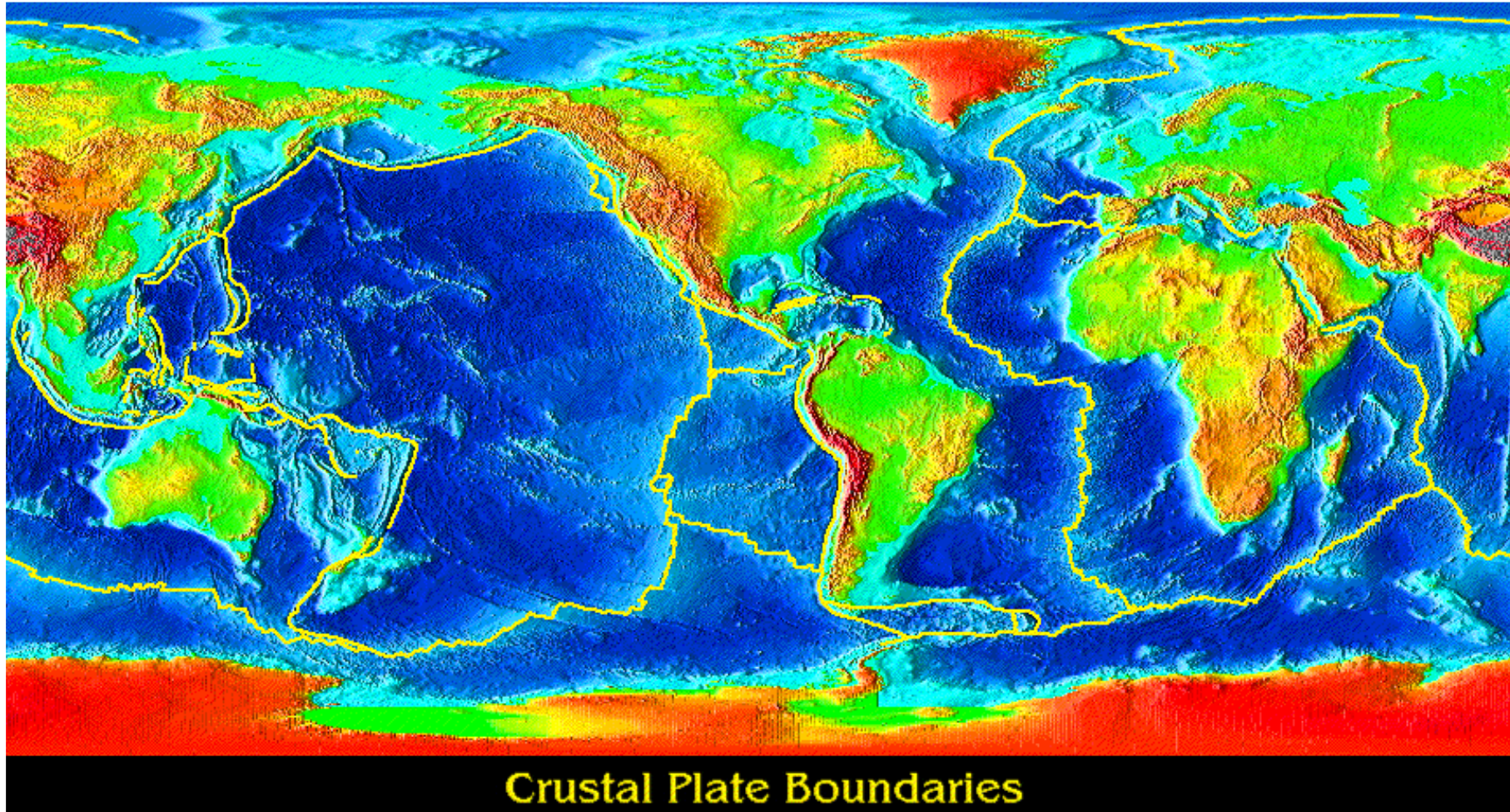

Plate tectonics and mountain formation (**orogenesis**)

Large mountain belts (Andes, Himalayas, Alps) are located along plate boundaries



Continental and oceanic plates

plate	% oceanic lith.	% continental lith.
<i>major plates</i>		
Pacific Plate	100	0
North-American Plate	30	70
South-American Plate	50	50
Eurasian Plate	30	70
Antarctic Plate	50	50
African Plate	50	50
Indo-Australian Plate	40	60
<i>important minor plates</i>		
Nazca Plate	100	0
Cocos Plate	100	0
Juan-de-Fuca Plate	100	0
Scotia Plate	100	0
Philippine Plate	100	0
Caribbean Plate	100	0
Arabic Plate	10	90

Kinematics of plate tectonics

- Plates should not be regarded as static features.
- Heat from Earth's core generates huge convection cells in the viscous mantle of the Earth.
- Plate motion is driven by plate boundary forces.
- The high weight of the plates also promotes plate motion during plate subduction.

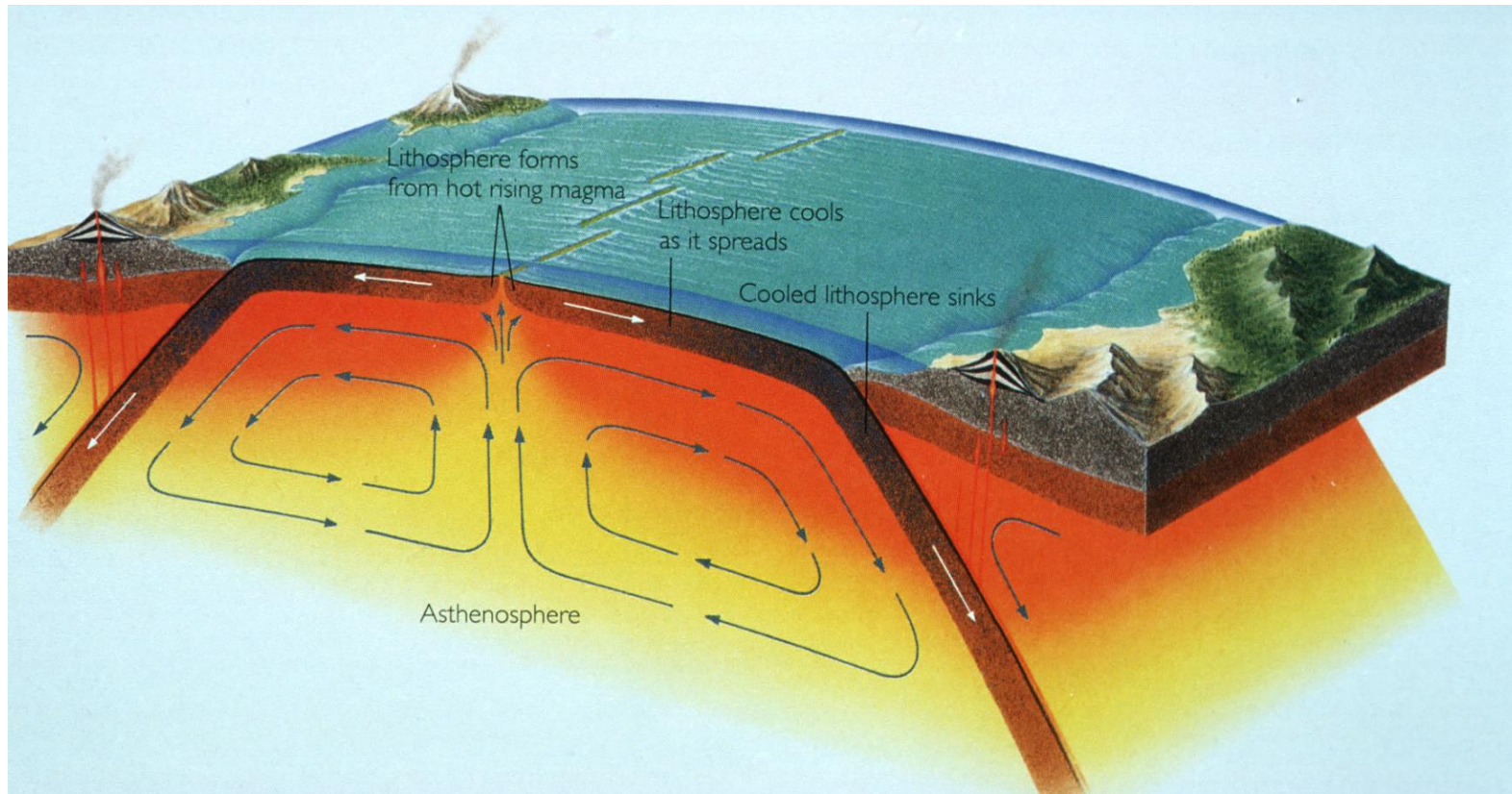

Kinematics of plate tectonics

Because the Earth has a spherical shape, plates are able to:

- Move apart (diverge: constructive plate margins)
- Move towards each other (converge: destructive plate margins)
- Move along each other (transform fault, marked by tangential motions: conservative plate margins)

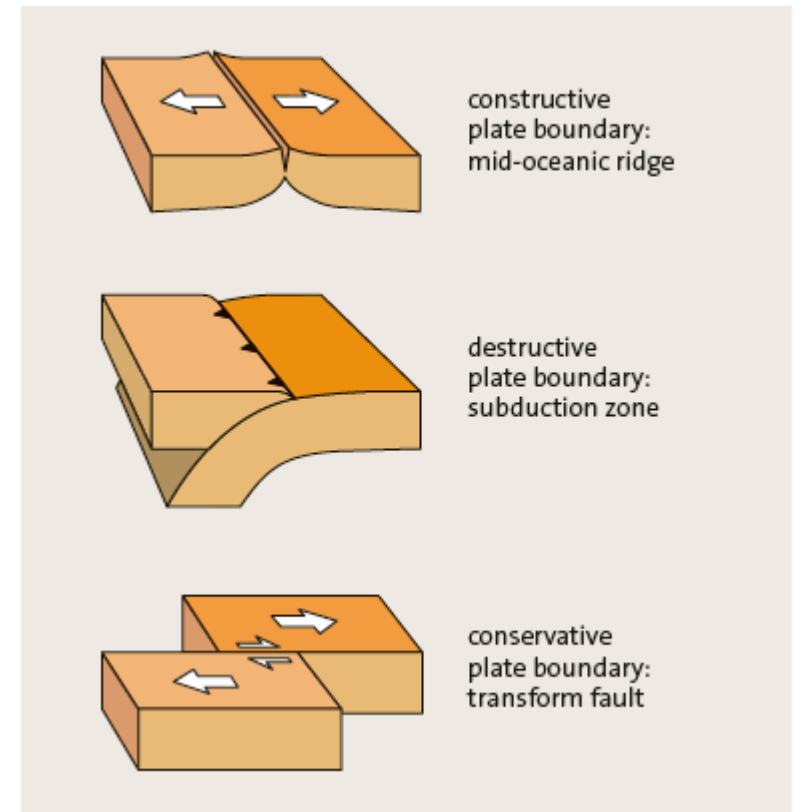
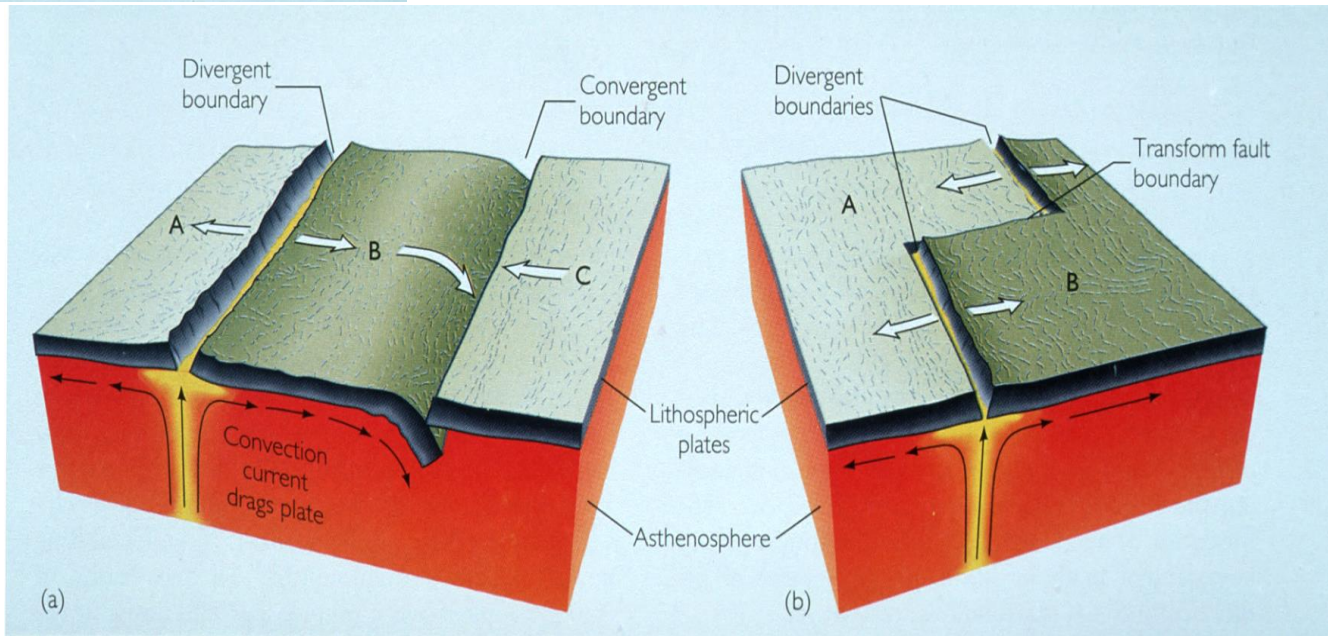
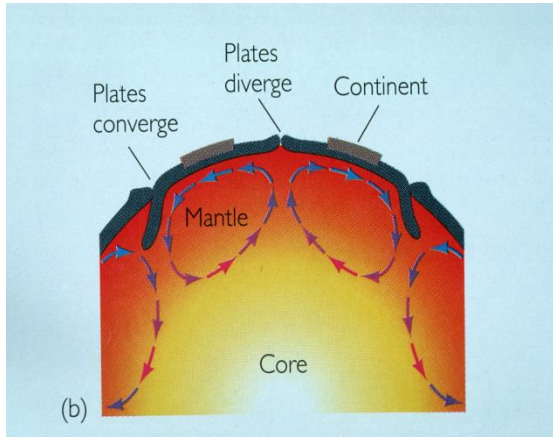

Kinematics of plate tectonics: divergent plate boundaries

- Because of heat convection from Earth's mantle, a single plate can potentially break-up and start to diverge
- *Ocean ridges* (accretive or constructive plate margins) mark boundaries where plates are diverging.
- Magma and depleted mantle upwell between the separating plates, giving rise to new oceanic lithosphere.

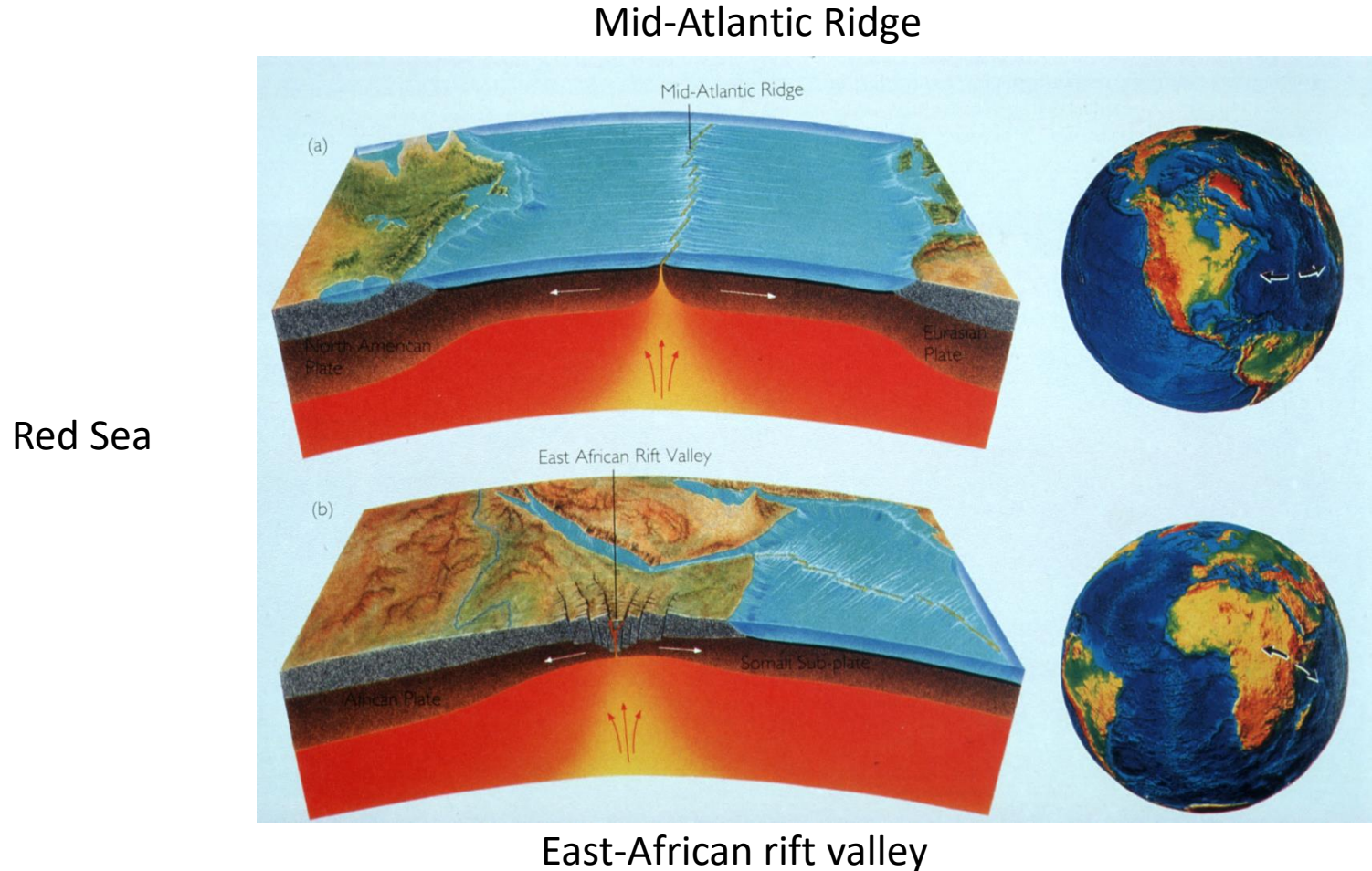

Kinematics of plate tectonics : convergent plate boundaries

- *Trenches* (destructive plate margins) mark boundaries where two plates are converging by the mechanism of the oceanic lithosphere of one of the plates being thrust under the other.
- Type of deformation depends on the composition of the converging plates: either oceanic or continental.

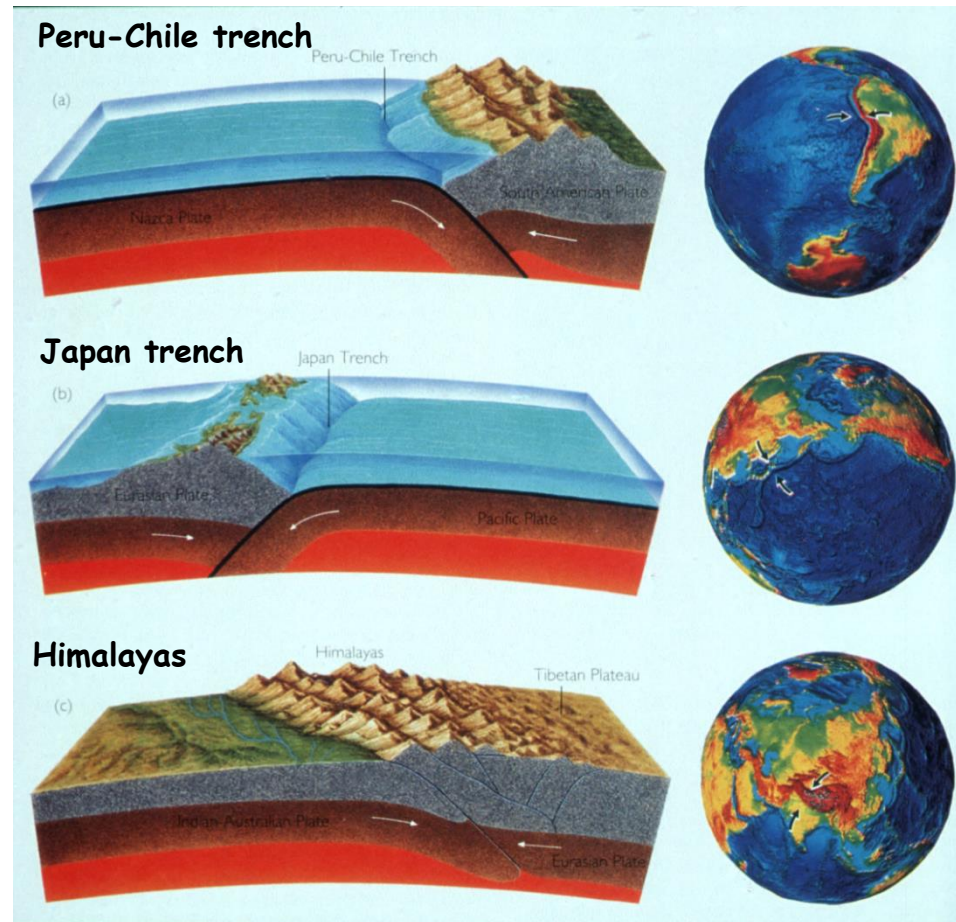

Oceanic - Continental

- Deep sea troughs
- Volcanic arcs

Oceanic – oceanic

- Deep sea troughs
- Volcanic island arcs

Continental – continental

- Fault and fold systems
- High mountain ranges
- Crustal thickening

Kinematics of plate tectonics : transform faults

- *Transform faults* (conservative plate margins) are marked by tangential motions, in which adjacent plates in relative motion undergo neither destruction nor construction. The relative motion is usually parallel to the fault.

A 'jump' at a divergent plate boundary gives rise to a so-called transform fault: two plates move along each other

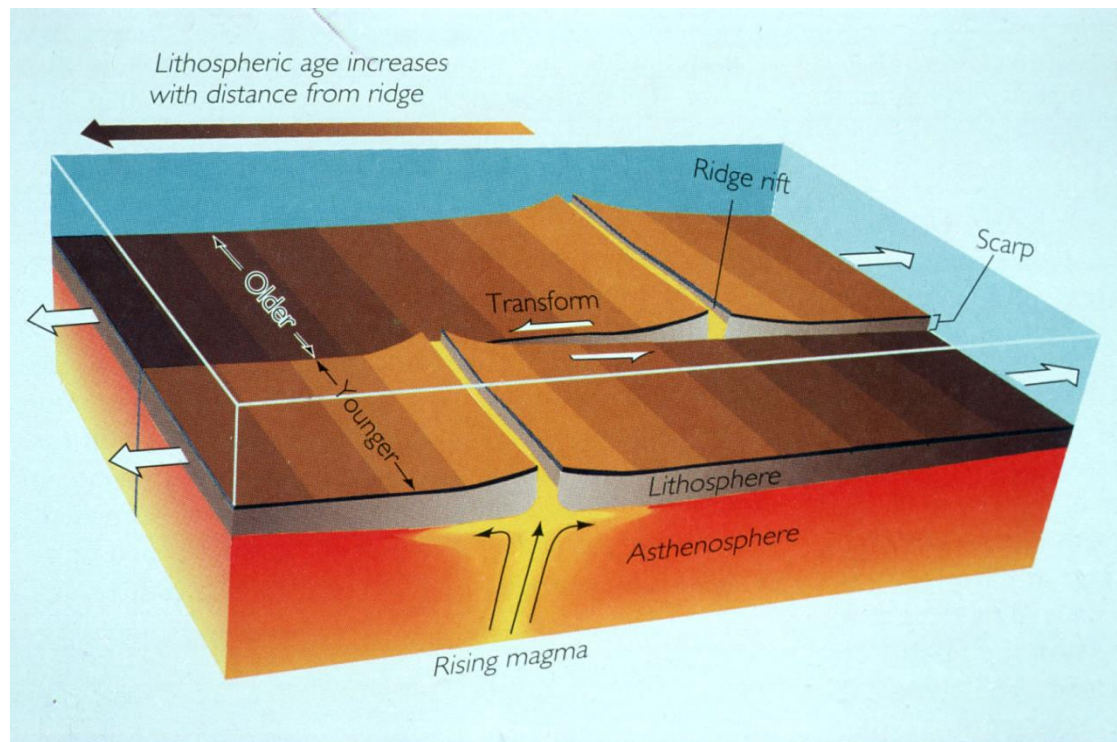

San Andreas fault



Plate tectonic forces

Plate tectonic driving forces may be divided into two fundamental groups according to the way they are transmitted:

- Transmission by shear stresses
- Transmission by normal stresses

Because plate tectonic driving forces act horizontally, *shear stresses* must be applied to horizontal surfaces and *normal stresses* to vertical surfaces.



a force applied at base

Basal Drag

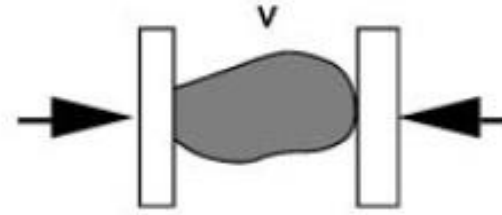

b force applied at sides

Side Forcing

- The friction between the base of the lithosphere and the convective motion in the asthenosphere (basal drag) is not the principal driving mechanism: The traction at the base of the lithosphere is too small to be able to transmit forces from the mantle into the lithosphere.
- *Plate boundary* forces, caused by potential energy variations occurring inside the continents and along the boundaries of oceanic lithosphere drive plate tectonics by lateral normal stresses.

Driving mechanisms of plate tectonics

- The **mantle drag model** considers that the upper, cool, boundary layer of the convecting system is represented by the upper part of the asthenosphere and that plates are driven by the viscous drag of the asthenosphere on their bases.
- The **edge-force model** recognizes the lithosphere itself as the upper, cool boundary layer of the convection cells and proposes that the plates are driven by forces applied to their margins.

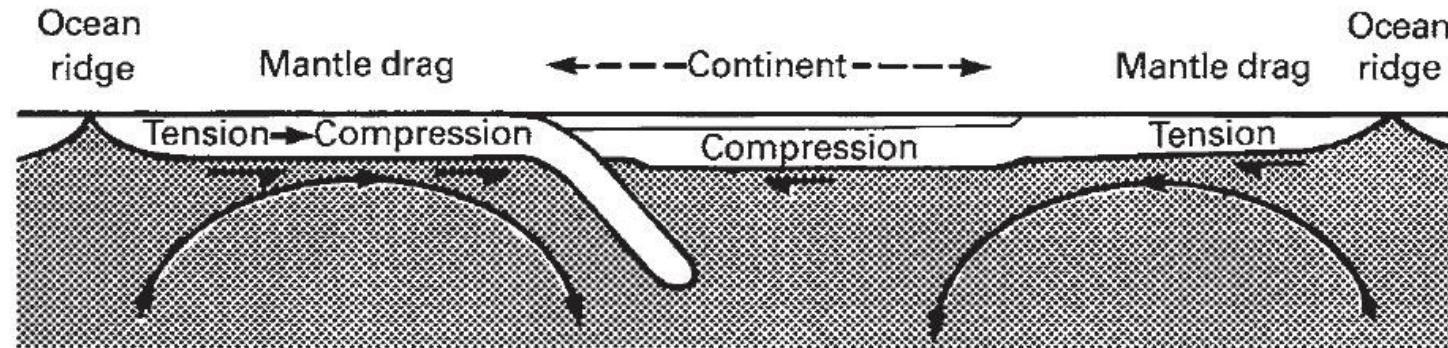

(a)

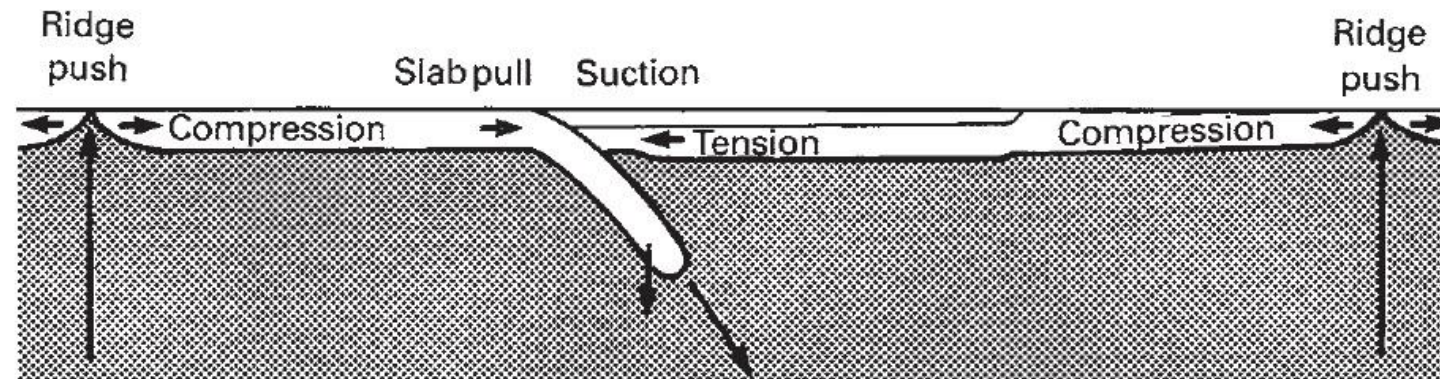

(b)

Driving mechanisms of plate tectonics

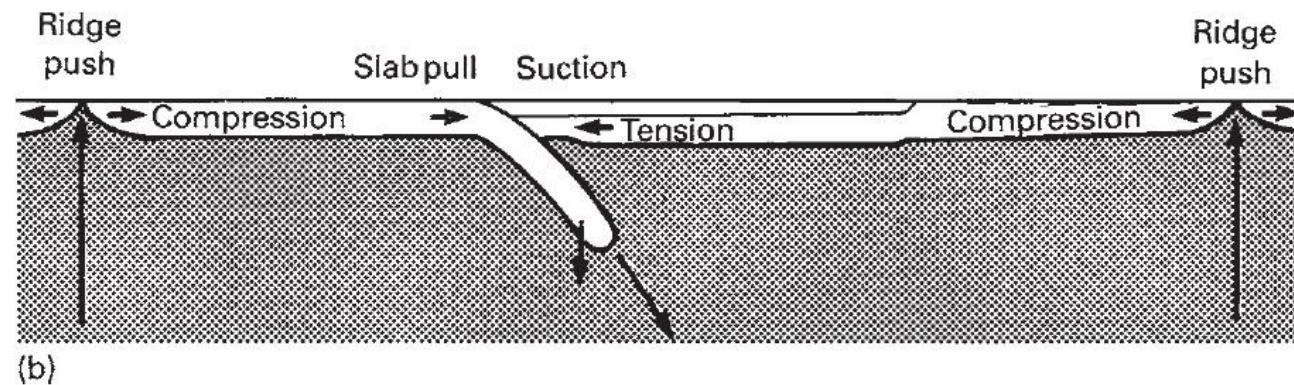
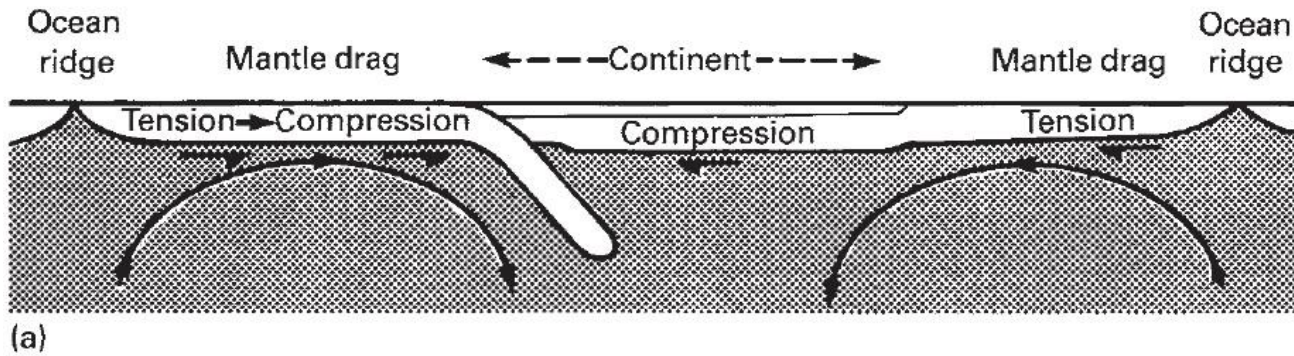

Mantle drag model:

- The convection cells would rise beneath oceanic ridges and descend beneath trenches, being largely absent beneath continental regions.
- The constant geometry and large horizontal dimensions of the cells of the convection cells cannot explain the relative movements between plate margins and cannot account for the movements of small plates (e.g., the Caribbean and Philippine plates).

Edge-force model:

- The edge-force mechanism causes the opposite stress configuration given by mantle drag model, in agreement with the stress regime shown by focal mechanism solutions of intraplate earthquakes.
- It is reconcilable with the following observations :
 - (a) plate velocity is independent of plate area,
 - (b) plates attached to downgoing slabs move more rapidly than other plates, in agreement with the slab-pull force being greater than other forces affecting the plates.
 - (c) Plates with a large area of continental crust move more slowly (mantle drag inhibits the motion of such plates rather than driving them).

Plate tectonic forces

Plate interaction generates very large forces (10^{12} - 10^{13} N/m) and releases energy (earthquakes and lithospheric deformation)

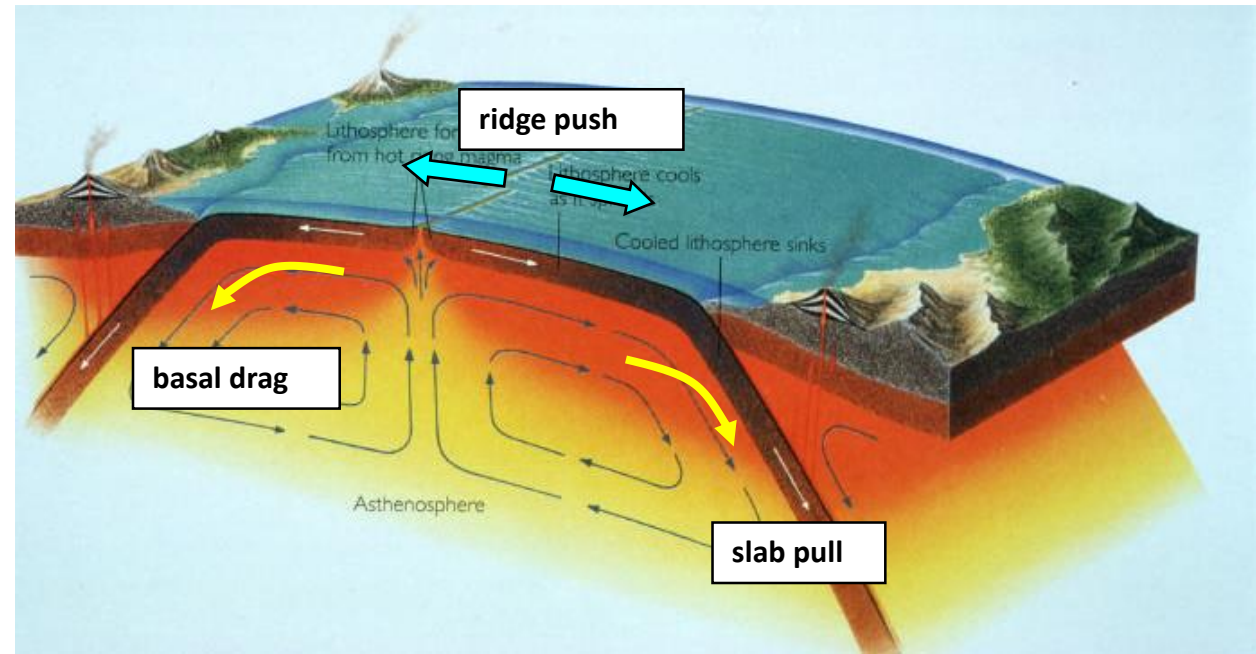
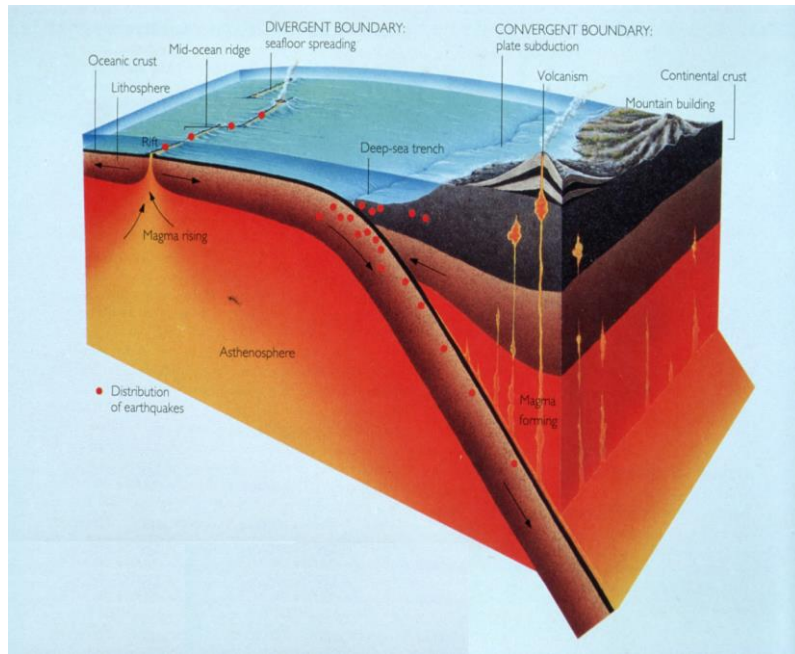

Plate Boundary forces main driving mechanisms of plate motion

- **Ridge Push:** caused by passive upwelling of hot buoyant asthenosphere and progressive cooling and thickening of the new lithosphere.
- **Slab Pull and Trench Suction:** caused by subduction of cold, dense lithosphere at trenches.
- **Basal Shear Traction:** caused by shear forces acting at the base of the plates with the convecting mantle (differential stress at the base of the lithosphere are likely too small to transmit forces from the mantle into the lithosphere).
- **Collisional forces:** caused by frictional forces between two colliding plates (they impede plate motions, but produce crustal thickening).

Plate tectonic forces

- Tectonics plates are considered to be internally rigid, and to act as extremely efficient stress guides.
- To determine the relative size of the forces on the 12 plates which make up the Earth's lithosphere, we should assume that the sum of the torques on each plate must be zero.
- A stress applied to one margin of a plate is transmitted to its opposite margin with no deformation of the plate interior.
- When plate behavior is examined in more detail, it is recognized that there are many locations where intra-plate deformation occurs.

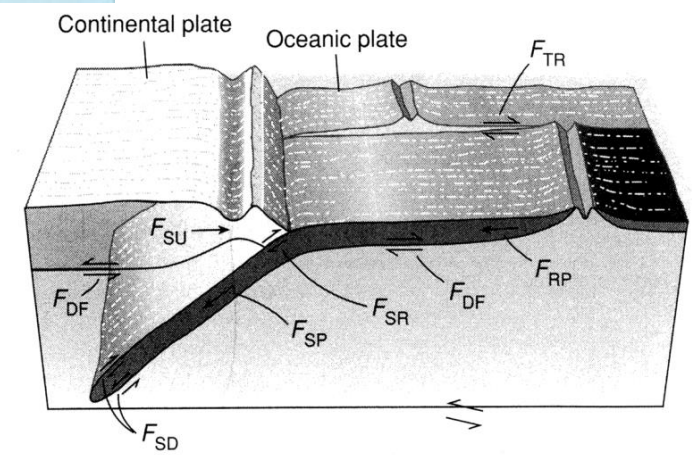
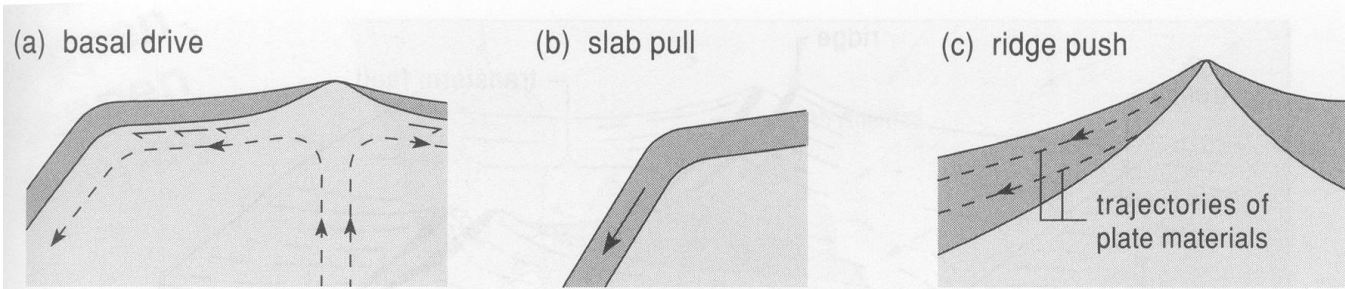
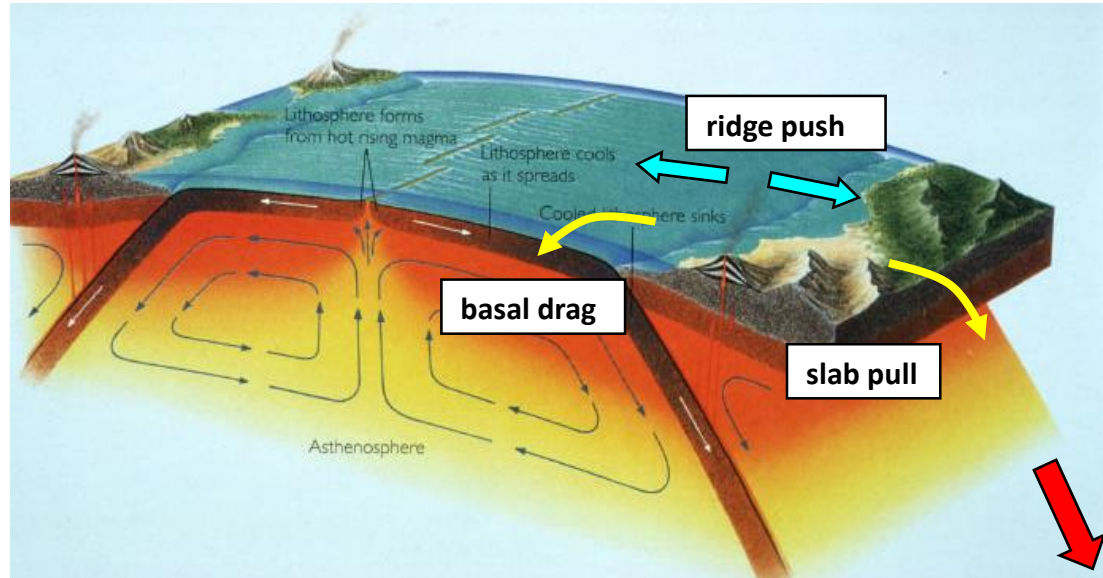
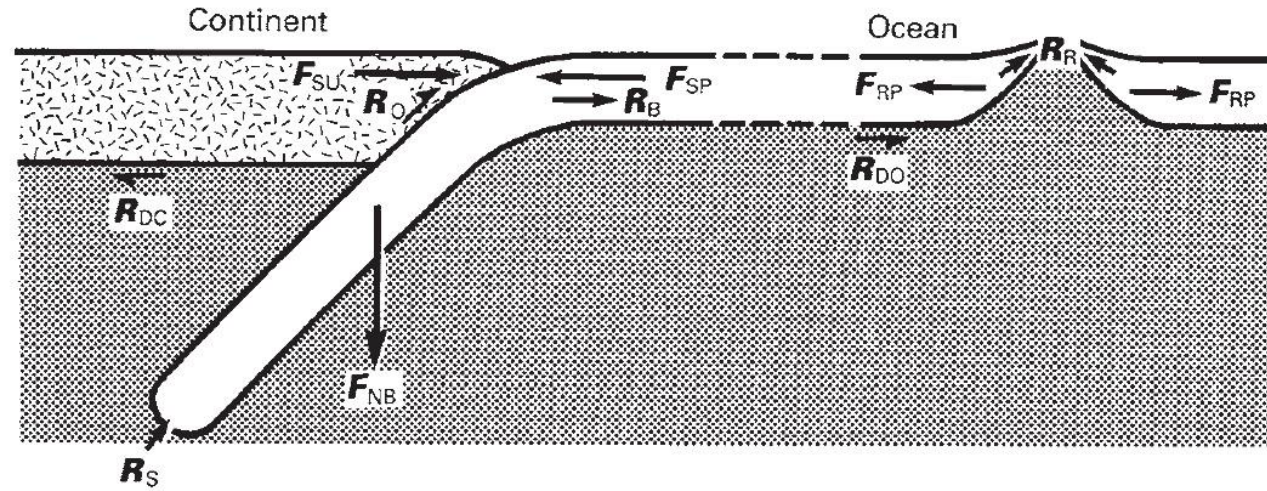

Plate tectonic forces



- F_{RP} – Ridge push
- F_{NB} – Negative buoyancy
- F_{SP} – Slab pull
- F_{SU} – Trench suction
- R_R – Ridge resistance
- R_B – Bending resistance
- R_S – Slab resistance
- R_O – Overriding plate resistance
- R_{DO} – Mantle drag under ocean
- R_{DC} – Mantle drag under continent

Mantle drag beneath continents is about eight times the drag beneath oceans.

- At ocean ridges the **ridge push force** F_{RP} acts on the edges of the separating plates, which derives from the buoyancy of the hot inflowing material causing the elevation of the ridge.
- The ridge-push force may be two or three times greater if a mantle plume underlies the ridge, because of the increased pressure in the asthenosphere at the ridge crest.
- The separation of plates at ocean ridges is opposed by a minor ridge resistance R_R that originates in the brittle upper crust, as demonstrated by earthquakes activity at ridge crests.
- Beneath plate interiors a **mantle drag force** acts on the base of both the oceanic and continental lithospheres if the velocity of the underlying asthenosphere differs from that of the plate.
- If the asthenosphere velocity exceeds that of the plate, mantle drag enhances the plate motion (F_{DO} , F_{DC}), but if the asthenosphere velocity is lower, the mantle drag tends to resist plate movement (R_{DO} , R_{DC}).

Upwelling of asthenospheric material below the mid ocean ridge

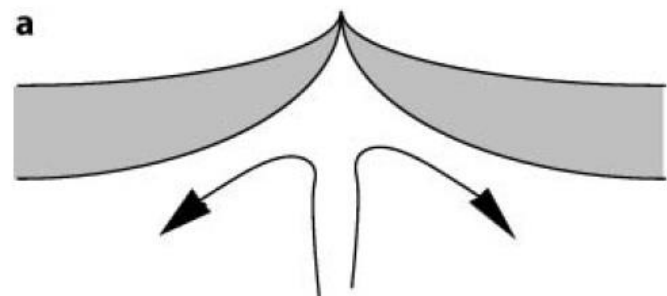

Mantle motion below most of the oceanic ridges

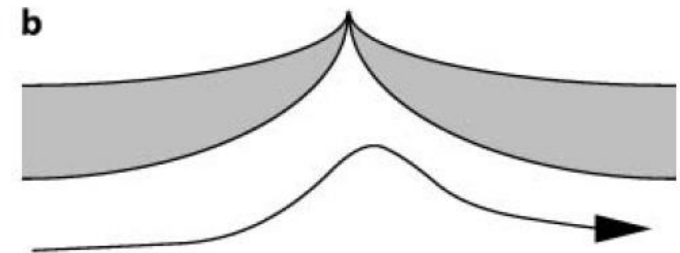
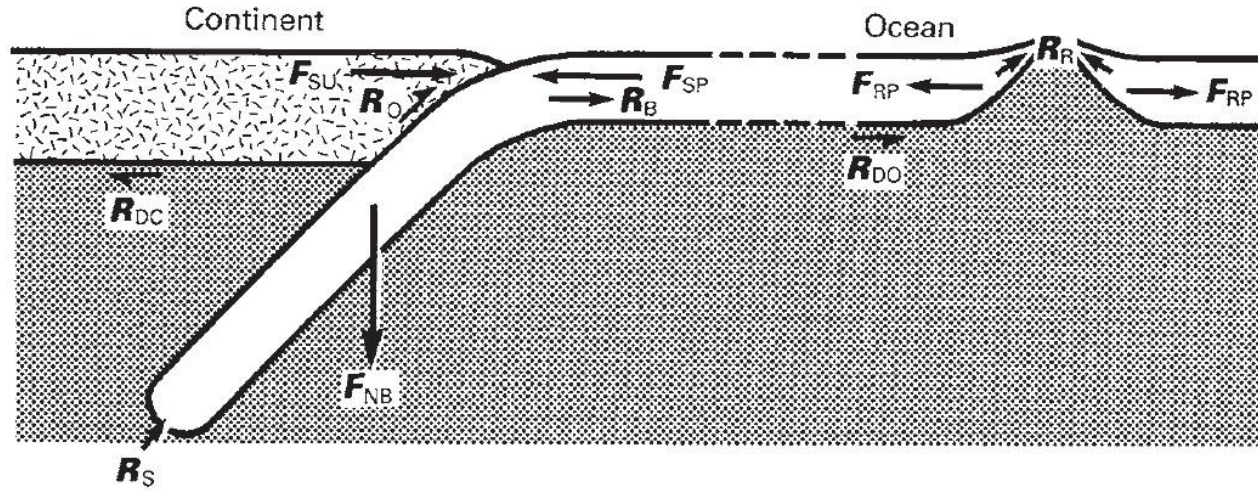

Plate tectonic forces



F_{RP} – Ridge push	R_R – Ridge resistance
F_{NB} – Negative buoyancy	R_B – Bending resistance
F_{SP} – Slab pull	R_S – Slab resistance
F_{SU} – Trench suction	R_O – Overriding plate resistance
	R_{DO} – Mantle drag under ocean
	R_{DC} – Mantle drag under continent

- The downgoing slab achieves a terminal velocity when F_{SP} is nearly balanced by $R_S + R_O$.
- If $F_{SP} \gg R_S + R_O$, the slab descends at greater than the terminal velocity and throws the slab into tension at shallow depths.
- If $F_{SP} \ll R_S + R_O$ the slab is thrown into compression.

- At subduction zones the major force acting on plates results from the **negative buoyancy** (F_{NB}) of the cold, dense slab of descending lithosphere.
- Part of this vertical force is transmitted to the plate as the **slab-pull force** (F_{SP}).
- The density contrast, and hence F_{NB} , is greatly enhanced at depths of 300–400 km where the olivine–spinel transition occurs in the slab.
- F_{SP} is opposed by a slab resistance (R_S), which mainly acts on the leading edge of the descending plate where it is five to eight times greater than the viscous drag on its upper and lower surfaces.
- Underthrusting involves a downward flexure of the lithosphere in response to F_{NB} , and since it behaves in an elastic manner in the top few tens of kilometers flexure is opposed by a bending resistance (R_B).
- A further resistance to motion at subduction zones is the **friction** between the two plates (R_O), expressed in the intense earthquake and tectonic activity observed at shallow depths

Plate tectonic forces

Possible sources of the trench suction force

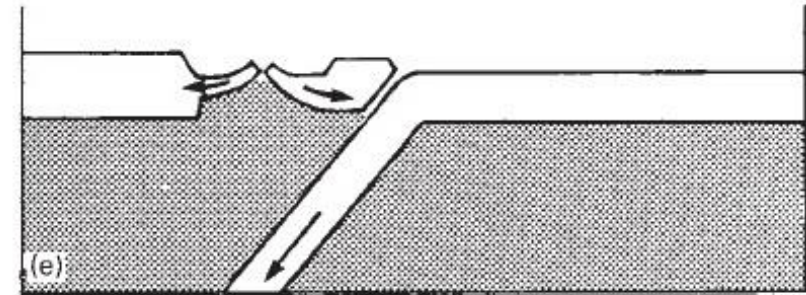
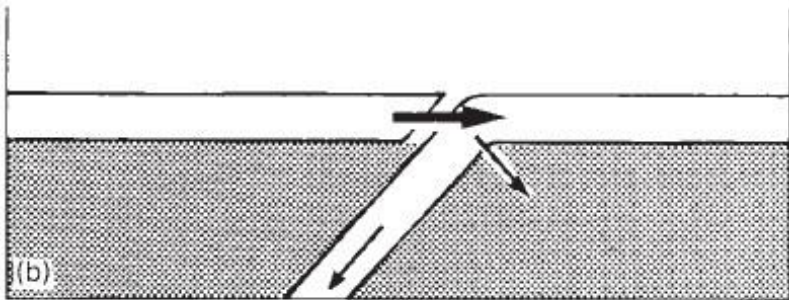
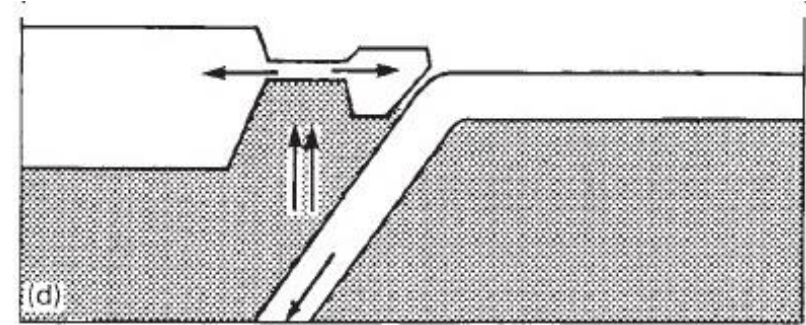
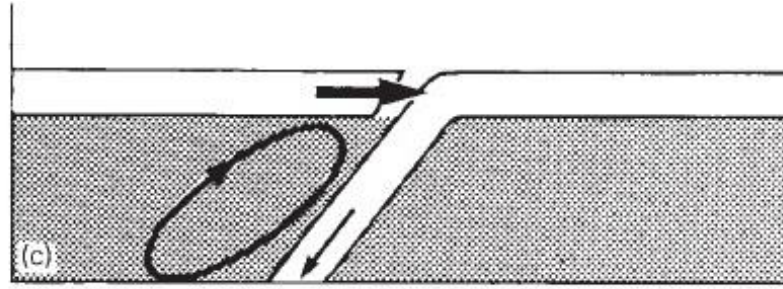
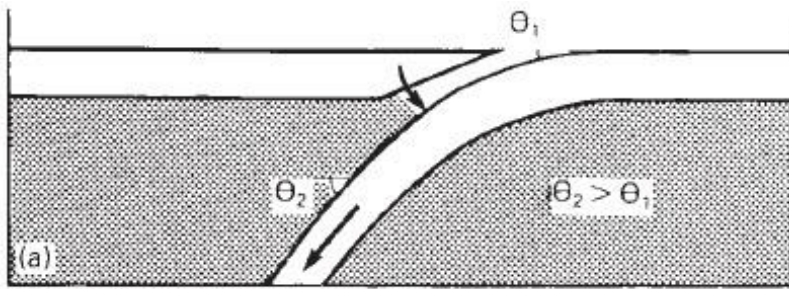

In the region on the landward side of subduction zones the overriding lithosphere is thrown into tension by the **trench suction force (F_{SU})**.

1. The force could arise because the angle of subduction becomes progressively greater with depth. Tension would then arise as the overriding plate collapses toward the trench.
2. The tension could result from the “roll-back” of the underthrusting plate.
3. Tension could be generated by secondary convective flow in the region overlying the downgoing slab (mantle wedge).
4. Tension may arise from any of several mechanisms inducing the formation of back-arc basins on the landward side of subduction zones.
5. Once back-arc spreading commences the landward plate becomes decoupled from the trench system.

Plate tectonic forces

Plate tectonic driving forces originate in differences of potential energy existing between different parts of the Earth

To compare different regions on the globe (different lithospheric columns), we introduce potential energy per area (E_p):

$$E_p = \int_0^z \sigma_{zz} dz = \int_0^z \int_0^z \rho(z) g dz dz \quad E_p = \int_0^z \sigma_{zz} dz = \int_0^z \rho g z dz = \frac{\rho g z^2}{2}$$

Where z is the isostatic compensation depth

(Integral of the vertical stress in the lithospheric column)

(If density is independent on depth)

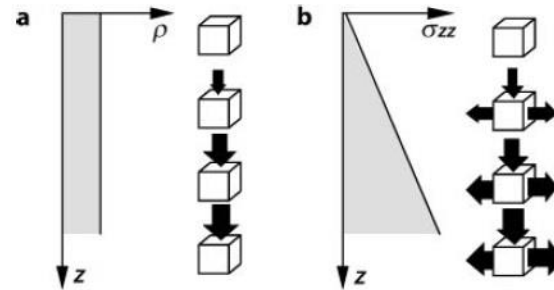

The vertical stress increases with depth.

The horizontal force exerted by the column on its surroundings is given by the sum of all vertical stresses.

The potential energy difference between two plates is a net force F_b (horizontal buoyancy force or gravitational stress), exerted by one column onto the other in the horizontal direction and per meter length of orogen

Column A

$$\int_0^{z_1} \int_0^{z_1} \rho^A(z) g dz dz = \int_0^{z_c} \sigma_{zz} dz + \int_{z_c}^{z_1} \sigma_{zz} dz$$

$$= \int_0^{z_c} \rho_1 g z dz + \int_{z_c}^{z_1} \rho_1 g z_c + \rho_3 g (z - z_c) dz$$

$$= \frac{\rho_1 g z^2}{2} \Big|_0^{z_c} + \rho_1 g z_c z \Big|_{z_c}^{z_1} + \frac{\rho_3 g z^2}{2} \Big|_{z_c}^{z_1} - \rho_3 g z_c z \Big|_{z_c}^{z_1}$$

$$\Delta E_p = F_b = \int_0^{z_K} \int_0^{z_K} \rho^A(z) g dz dz - \int_0^{z_K} \int_0^{z_K} \rho^B(z) g dz dz$$

(If we consider the Moho depth discontinuity, z_c is the Moho depth and z_1 the depth of the lithosphere)

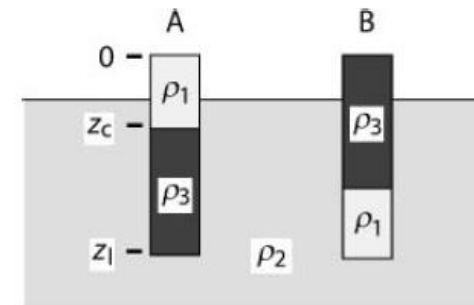

$$H_A = H_B \\ E_p^A < E_p^B$$

E_p depends on **thickness**, **density**, and **density distribution** in the lithospheric column

Horizontal Plate forces: Ridge Push

Pressure

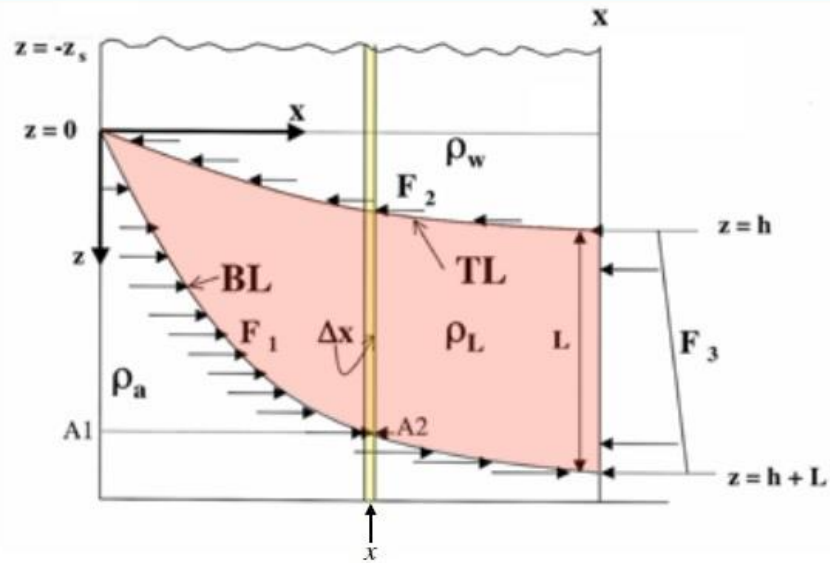

$$P(x=0) = g\rho_w z_s + g\rho_a z \quad \text{for } z \geq 0$$

$$P(x) = g\rho_w(z_s + z) \quad \text{for } 0 \leq z \leq h$$

$$P(x) = g\rho_w(z_s + h) + g\rho_L(z - h) \quad \text{for } h \leq z \leq h + L$$

1. Ridge push

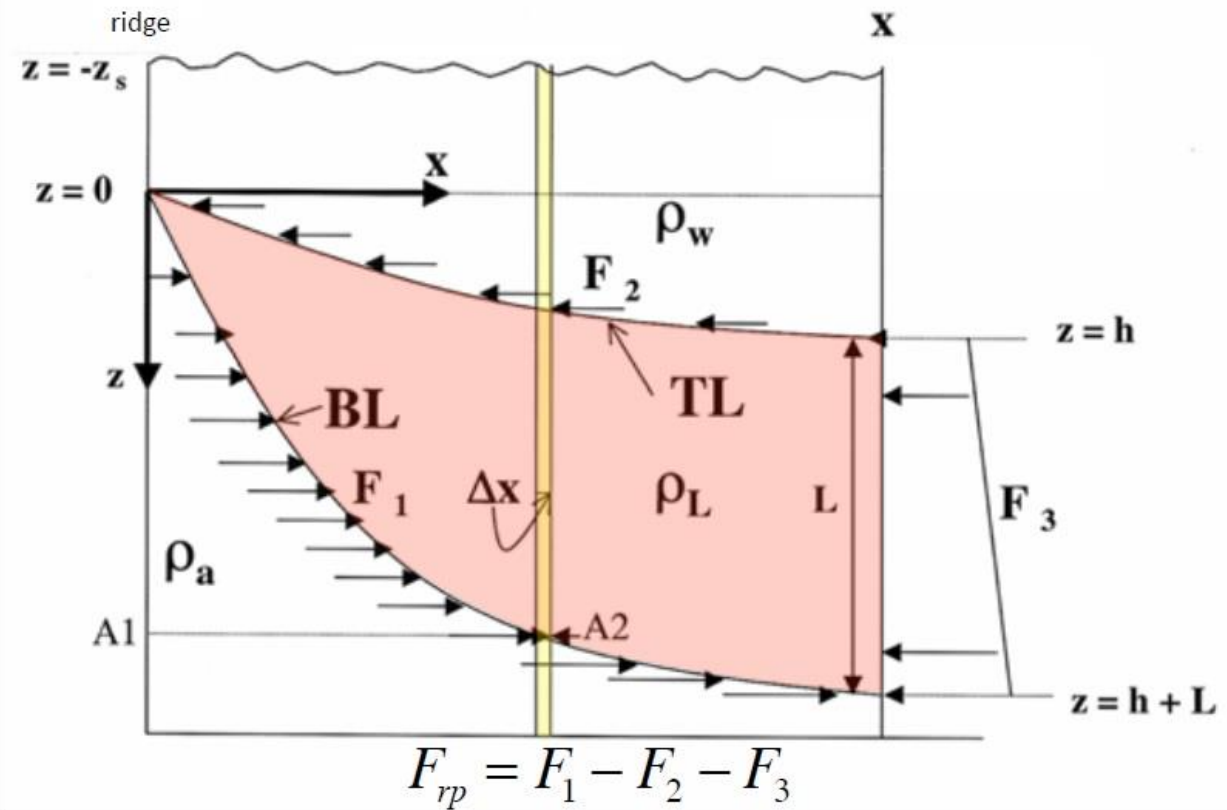

Horizontal Plate forces: Ridge Push

F_1

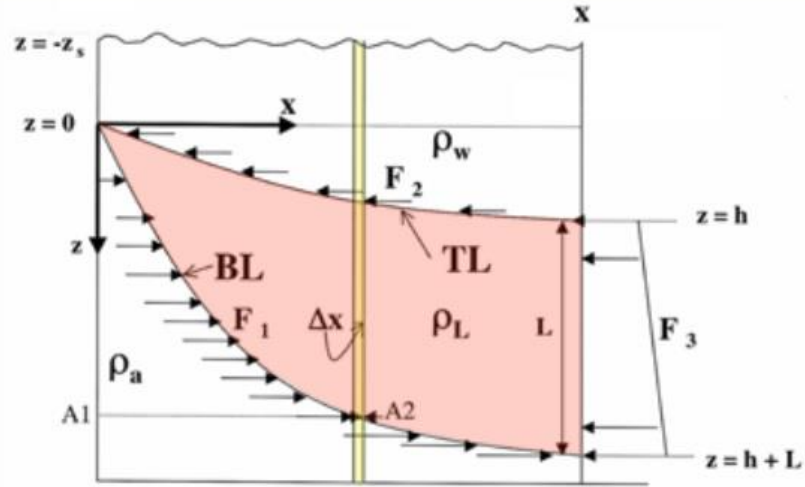

Horizontal force on the base of the lithosphere

$$F_1 = \int_{BL} P_x dl \quad F_1 = g\rho_w z_s (h+L) + \frac{1}{2} g\rho_a (h+L)^2$$

F_2

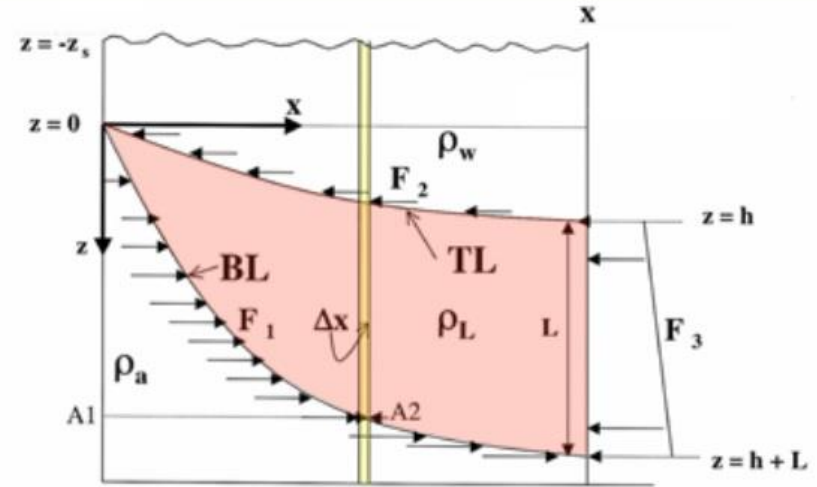

Horizontal force on the top of the lithosphere (TL):

$$F_2 = \int_{TL} P_x dl \quad F_2 = \int_{TL} P_x dl = \frac{1}{2} g\rho_w (h^2 + 2z_s h)$$

Horizontal Plate forces: Ridge Push

F_3

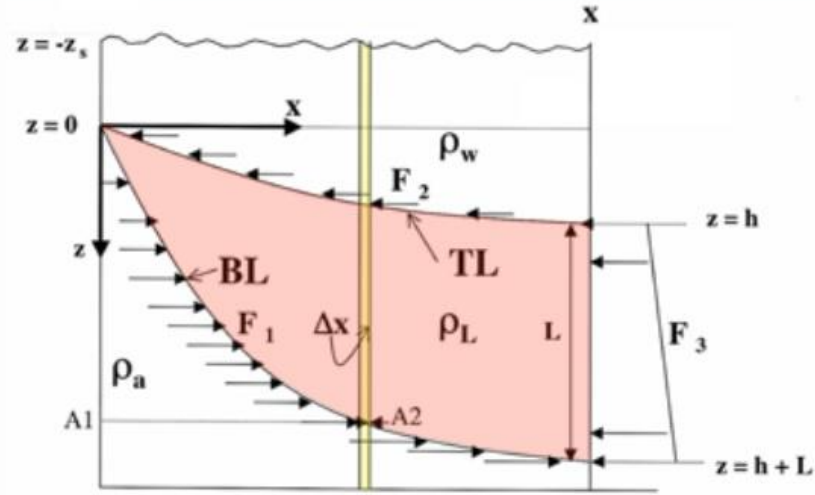

Horizontal force on the right hand side of the lithosphere

$$F_3 = g\rho_w(z_s + h)L + \frac{1}{2}g\rho_L L^2$$

Ridge push force

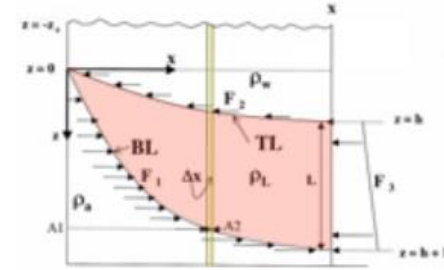

$$F_{rp} = F_1 - F_2 - F_3$$

Ridge push is the result of horizontal components of pressure differences

The magnitude of the ridge push force is

$$|\vec{F}_{rp}| = \frac{1}{2}g(\rho_a - \rho_w)(hL + h^2) \quad [\text{N/m}]$$

Horizontal Plate forces: Ridge Push

The forces acting on the plate

- Mid-oceanic ridges have a high topography and a high potential energy relative to the average oceanic lithosphere.
- Ridge push originates from a distributed pressure gradient (i.e., a body force) acting on the entire plate normal to the strike of a mid-ocean ridge.
- It arises from the isostatic sinking of the oceanic lithosphere away from the mid-ocean ridge as it cools and densifies.
- The lithosphere tends to “slide” downward putting the remaining of the system under compression, perpendicular to the direction of the spreading ridge.
- Ridge push can be calculated as a pressure gradient integrated over a profile perpendicular to the strike of the mid-ocean ridge crossing an entire ridge flank.

Density of oceanic lithosphere is expressed in terms of temperature as a function of depth (and thus age).

Ridge Push according to half space cooling model

$$F_b = g\rho_m\alpha T_1\kappa t \left(1 + \left(\frac{\rho_m}{\rho_m - \rho_w} \right) \frac{2\alpha T_1}{\pi} \right) \approx 1.19 \cdot 10^{-3}t$$

$$F_b = 1.5 \times 10^{12} \text{ N/m}$$

where $\rho_m = 3300 \text{ kg/m}^3$, $\rho_0 = 1000 \text{ kg/m}^3$, $\kappa = 10^{-6} \text{ m}^2/\text{s}$, $(T_m - T_0) = 1200 \text{ K}$, $\alpha = 3 \times 10^{-5} \text{ K}^{-1}$ and t is the age of the lithosphere

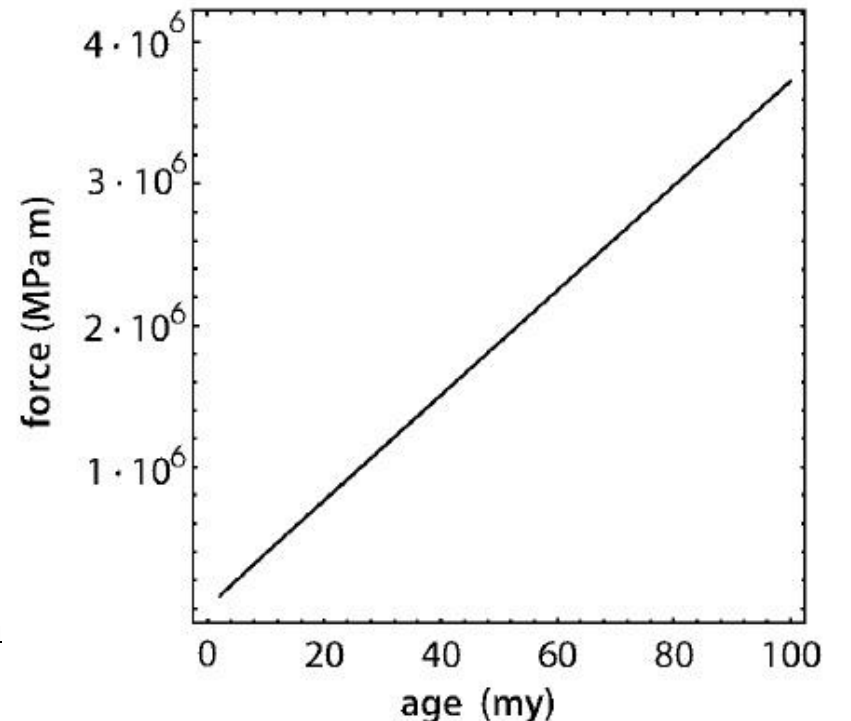
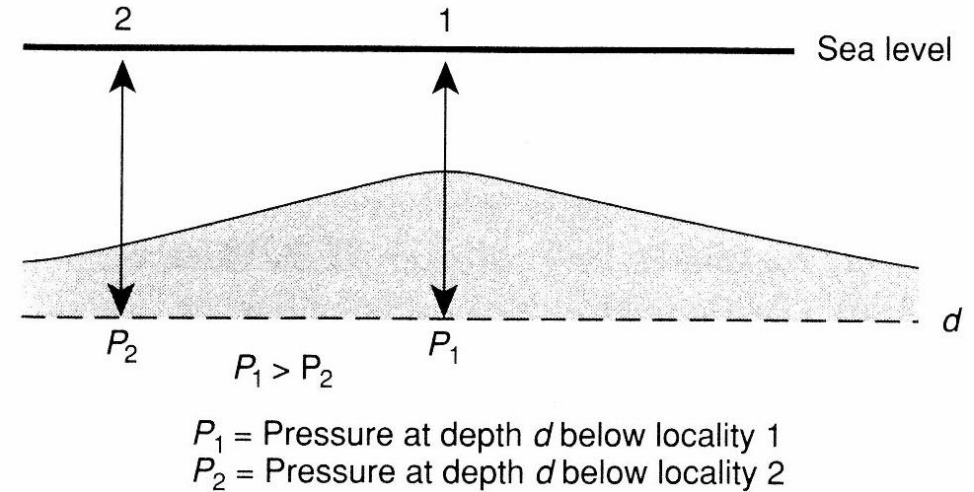

Downwards Plate forces : Slab Pull and Trench Suction

- The **slab-pull force** (F_{sp}) originates from the negative buoyancy of the downgoing dense oceanic lithosphere at subduction zones and is proportional to the excess mass of the cold slab with respect to the mass of the warmer displaced mantle (density contrast enhanced by phase transformation olivine-spinel at a depth of 400 km).
- Once the edge of an old oceanic plate started to subduct, it drags the remainder of the plate behind it.
- Subduction induces mantle flow toward the downwelling material and these tractions cause the overriding plate to move toward subduction zones.

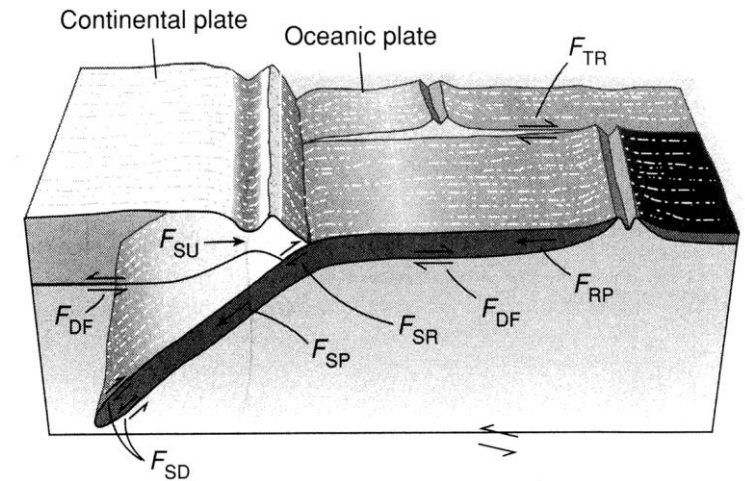
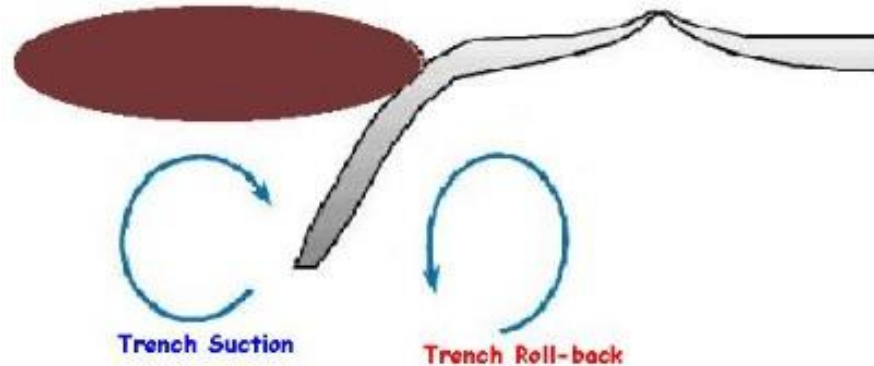
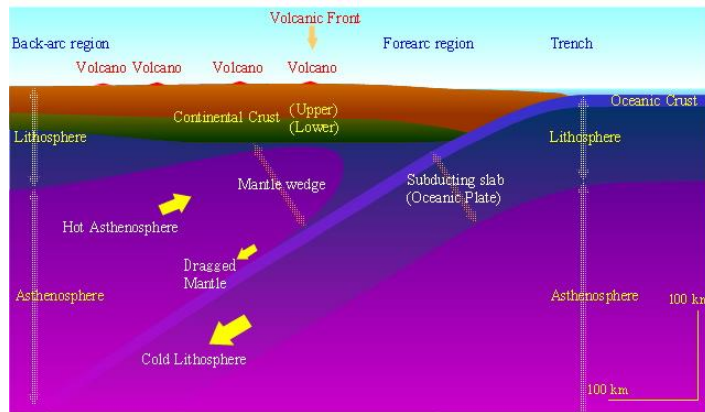

- The **trench suction** is a lifting pressure on the upper surface of the downgoing plate caused by an asthenospheric corner flow that is induced by the motion of the descending plate.

Energy transmitted to the plate from the downgoing slab must be proportional to the excess mass M_e of the plate.

$$M_e = 1/2(\rho_L - \rho_m) \frac{LE}{\sin \Psi}$$

where ρ_L is the density of the lithosphere, ρ_m is the density of the mantle, L is the thickness of the lithosphere, E is the depth at which the excess density vanishes, and ψ is the dip of the slab.

$$F_{SP} = M_e g \quad \sim 10^{13} \text{ N/m} \quad (\text{it determines absolute plate speed})$$

Downwards Plate forces : Slab Pull and Trench Suction

Slab pull

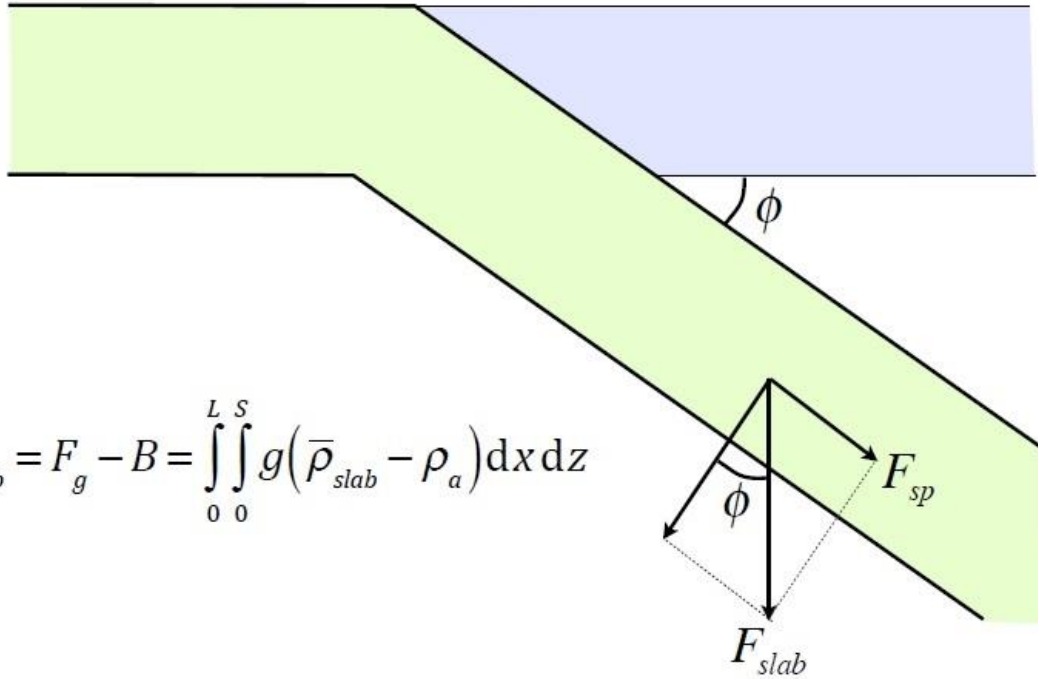

$$F_{slab} = F_g - B = \int_0^L \int_0^S g(\bar{\rho}_{slab} - \rho_a) dx dz$$

Summary: forces on oceanic plate

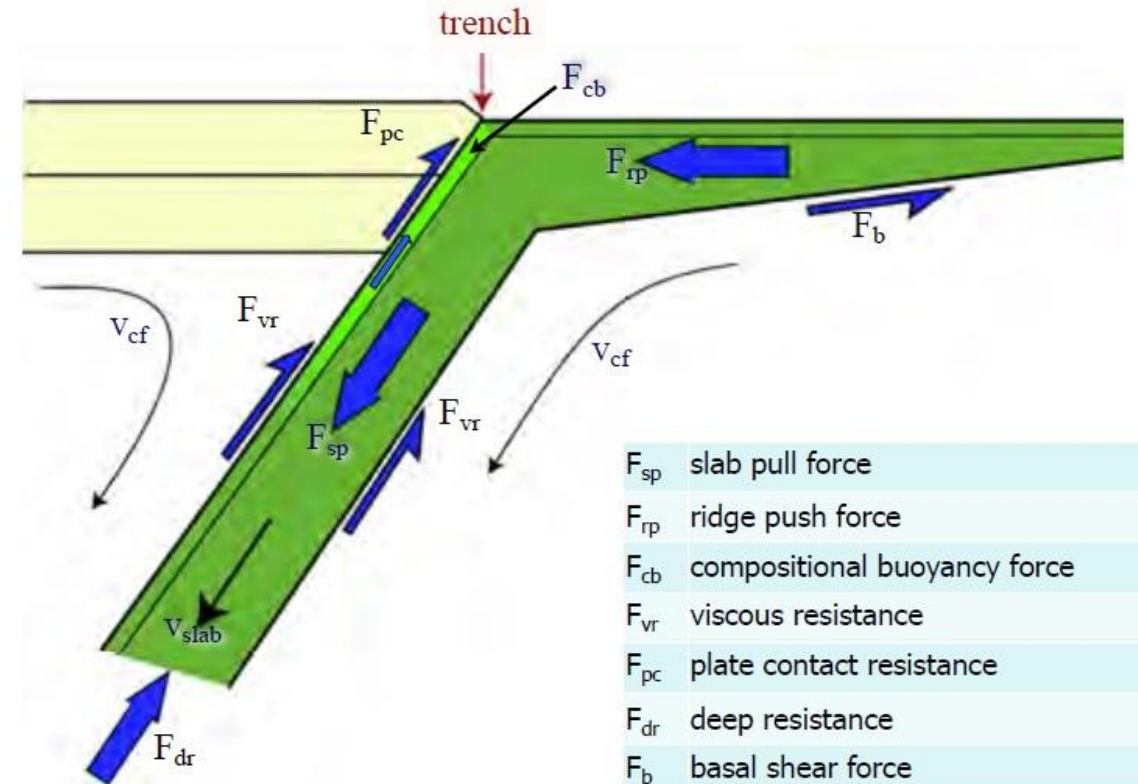

- The slab pull is the horizontal component of the slab force and is due to pressure difference due to different temperature.

- Along the slab the surrounding fluid resists the slab subduction, if the fluid is very viscous there is a high resistance and viceversa.

Plate boundary forces and velocities

Trench length as a percentage of plate circumference vs plates velocity

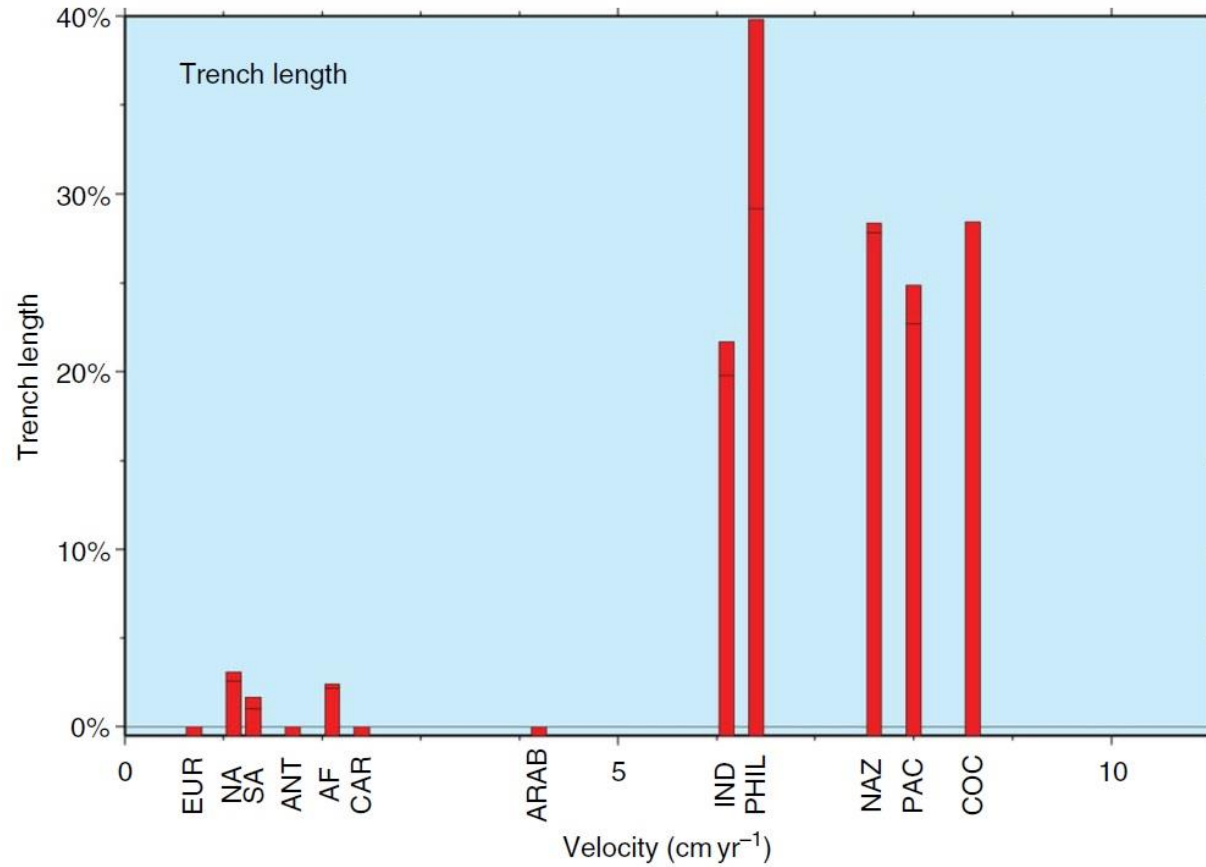

Area of continental crust associated with a plate vs plate velocity

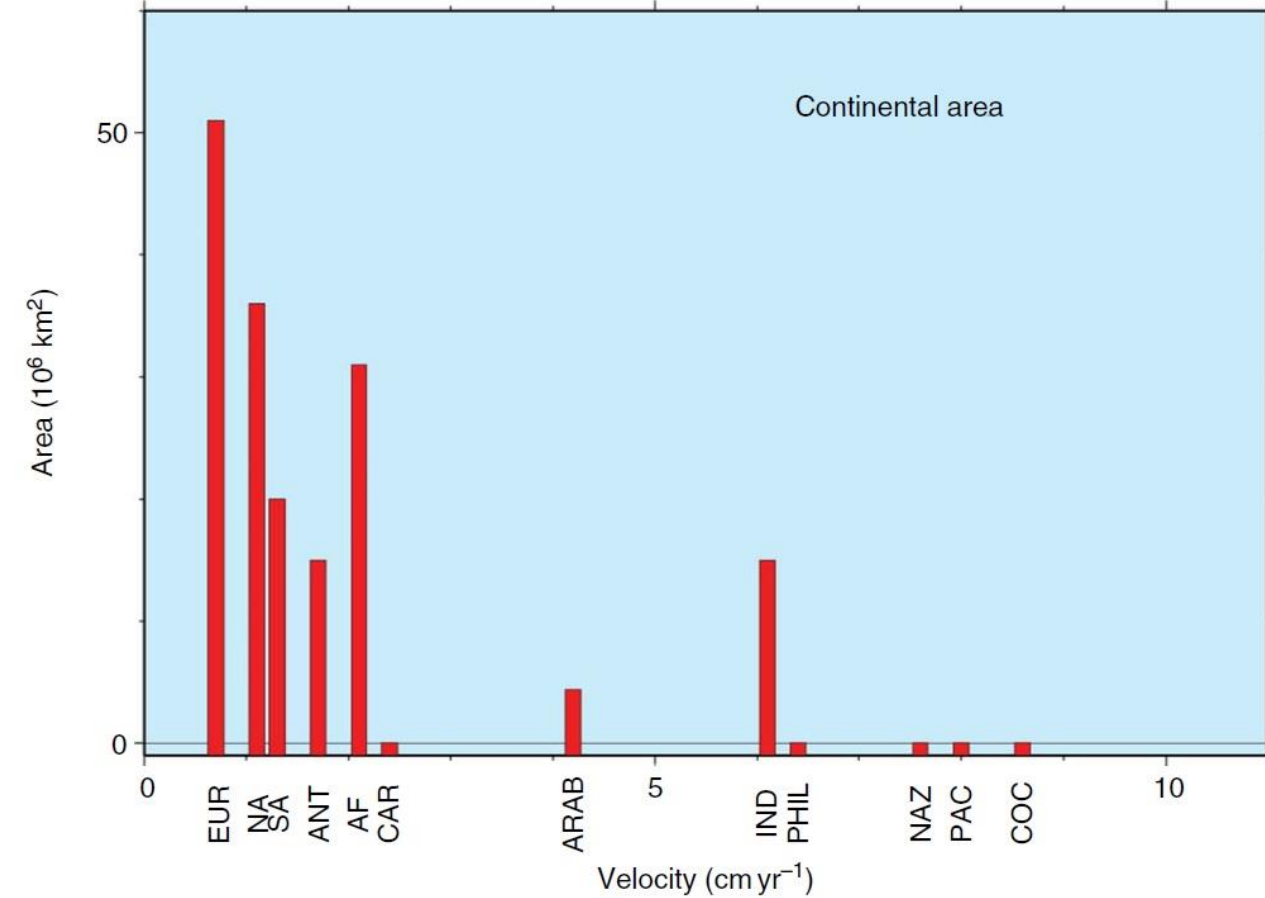

Influence of lithospheric thickness

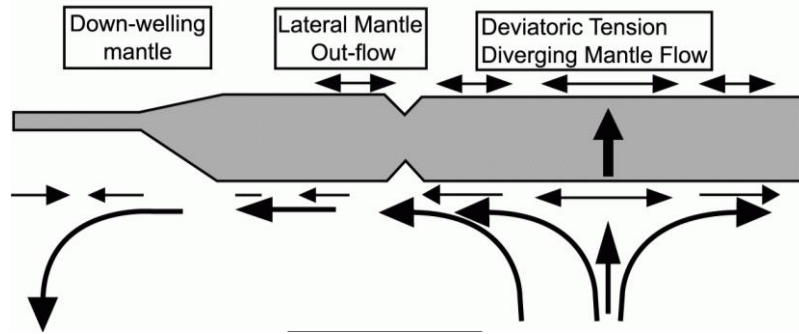

Not only forces, but all relict lithospheric discontinuities contribute potentially to the break-up of tectonic plates

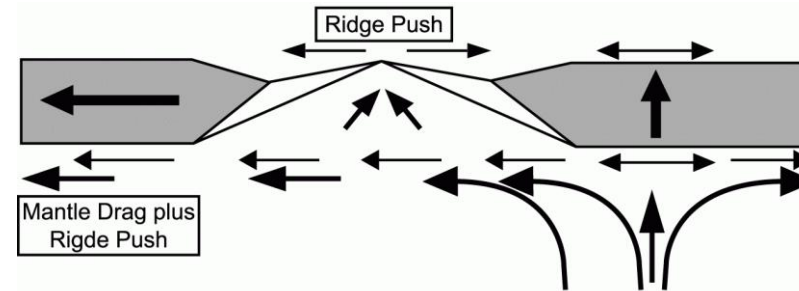
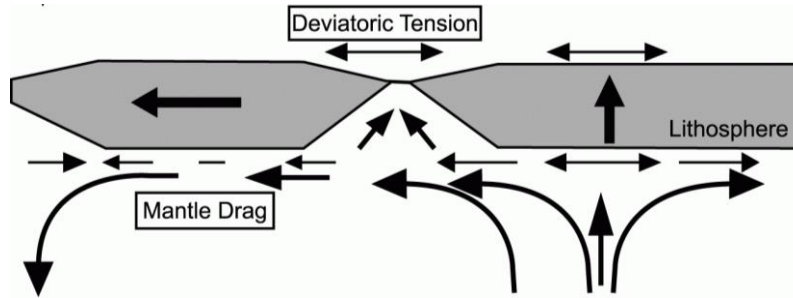

- ← Displacement Vector
- ← Mantle Flow Directions
- ← Stress Vectors

Forces between mountain ranges and foreland

$$E_p^{\text{foreland}} = \rho_c g z_c^2 / 2$$

$$E_p^{\text{range}} = \rho_c g (H + z_c)^2 / 2 + \Delta \rho g w^2 / 2$$

(potential energy of the thickened crust relative to the Moho)

$$\Delta E_p = F_b = E_p^{\text{range}} - E_p^{\text{foreland}} = \rho_c g H^2 / 2 + \rho_c g H z_c + \Delta \rho g w^2 / 2$$

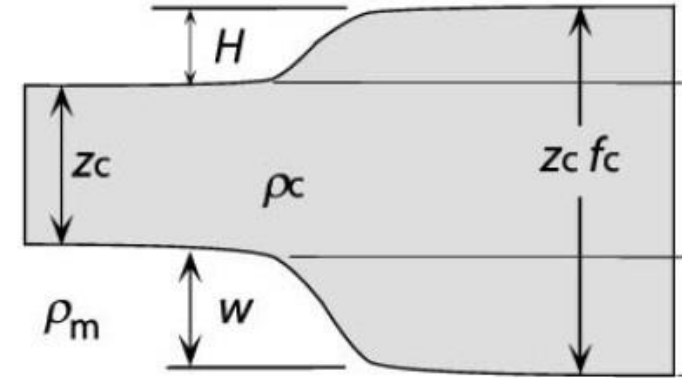

In isostatic conditions: $\Delta \rho w = H \rho_c$

$$\Delta E_p = F_b = \rho_c g H (H/2 + z_c + w/2)$$

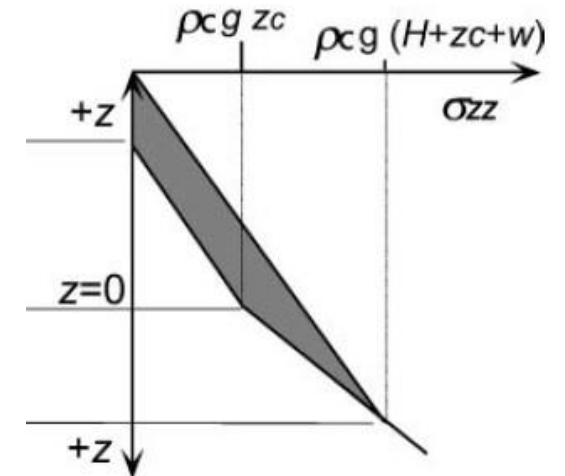

- E_p of a mountain range grows with the square of both surface elevation and thickness of its roots (mountains do not grow infinitely).
- E_p difference between two mountains of the same elevations grows if the compensating root is thicker.

(Difference between vertically integrated vertical stress)

$$F_b = 3-4 \times 10^{12} \text{ N/m}$$

Lithospheric body forces models

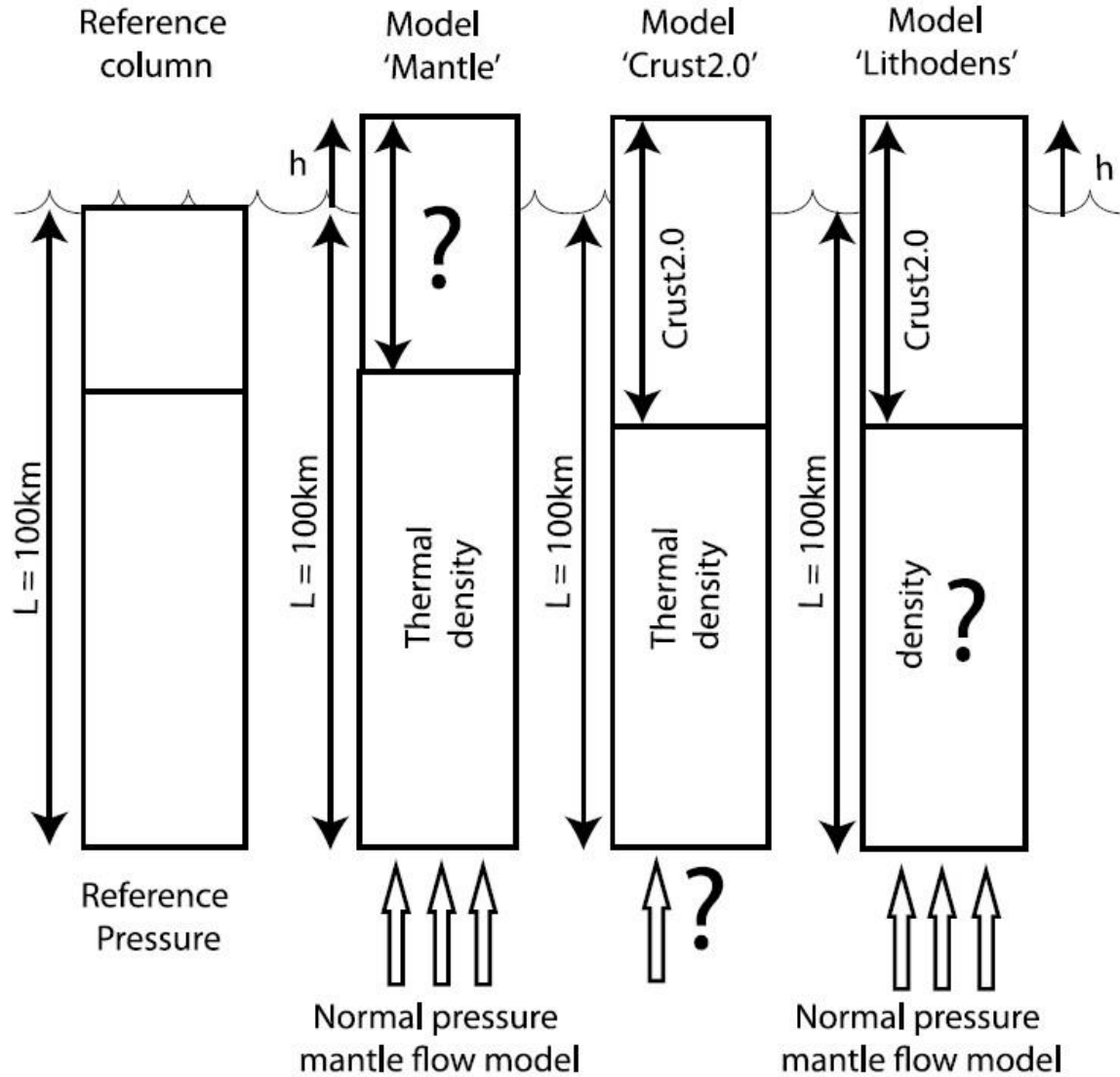

- Topography is influenced by the density distribution with depth.
- Which is the quantity that is taken to be unknown (and therefore is calculated) so that the high of the column matches the observed topography?
- In model *Mantle*, crustal thickness is taken to be poorly constrained, in model *Crust2.0* normal components of mantle tractions are taken to be unknown and in model *Lithodens* the weight of the lithospheric mantle is considered to be uncertain.

Potential energy excess due to external forces

The vertical stresses exerted from an upwelling mantle plume to the base of the lithosphere causes the lift of the entire plate

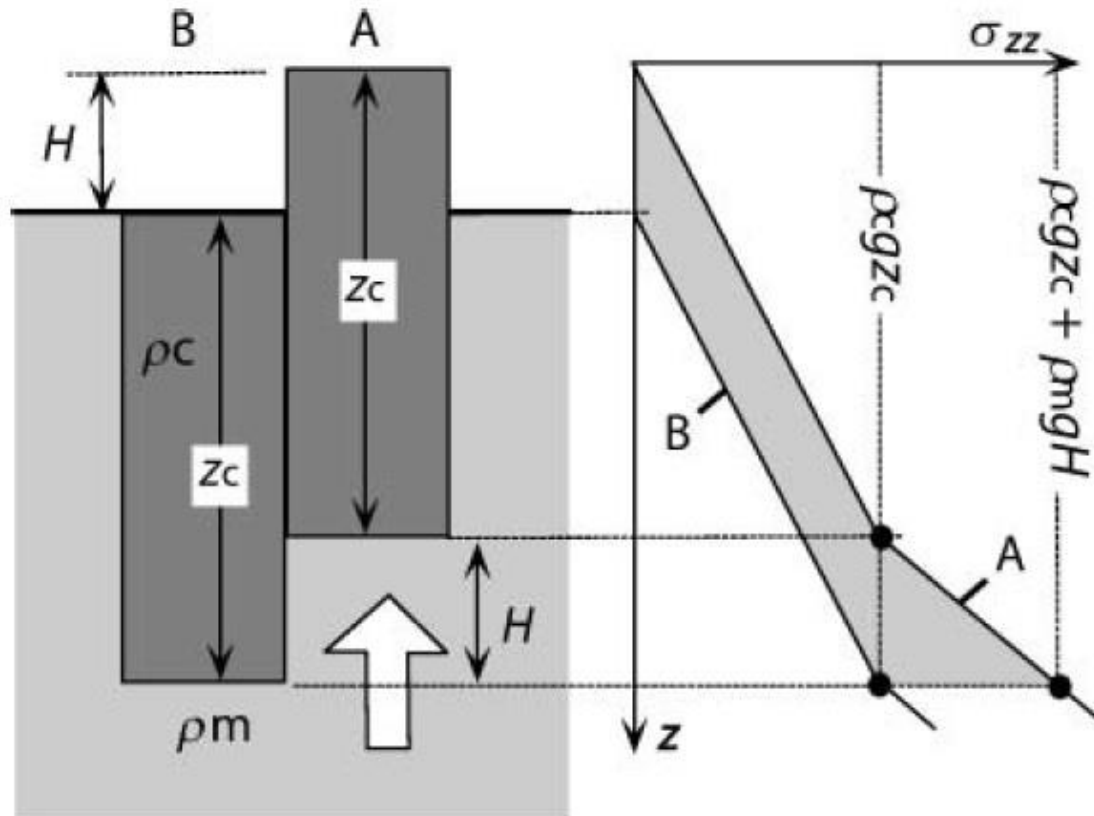

$$F_b = \Delta E_p = \frac{\rho_m g H^2}{2} + \rho_c g H z_c$$

(Difference between vertically integrated vertical stress)
For an uplift of 1 km, we get $F_b = 9 \times 10^{11}$ N/m

The vertical stresses of the two profiles do not converge, since the two columns are not in isostatic equilibrium.

Plate margin migrations

Velocity measured from different references

- Ridge is (in most of cases) symmetric: accretion of material occurs along both plates.
- Velocity of two plates are relative to the ridge are equal and opposite.

- Trench is asymmetric (only one plate is consumed)
- Trench moves with the overriding plates.

Different reference frame

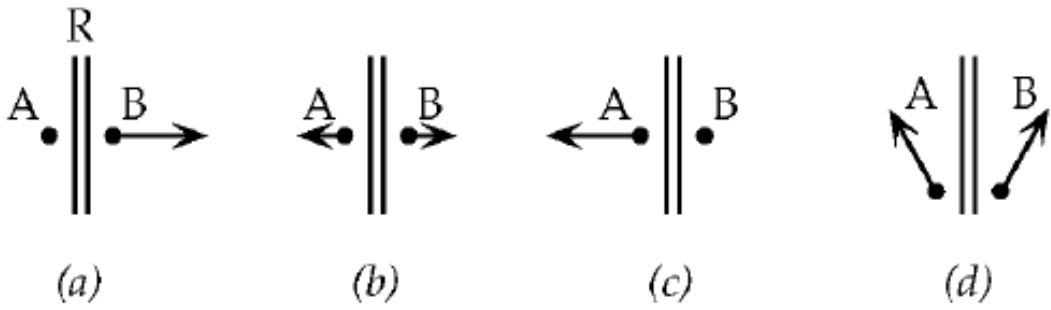
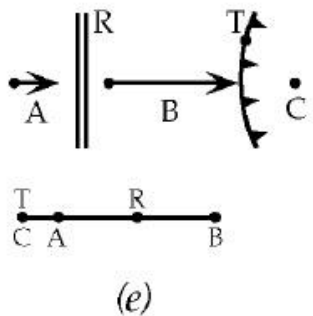
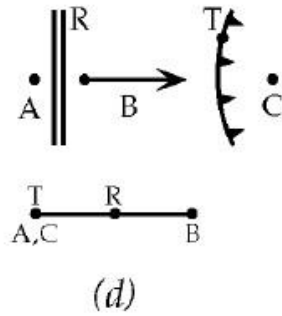
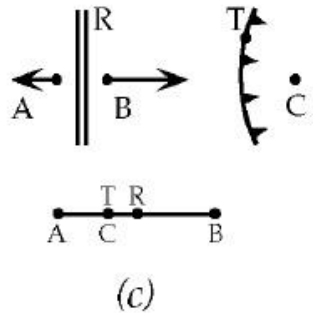
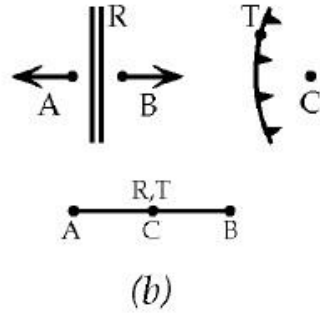
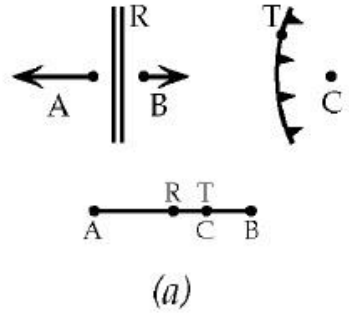

Plate margin migrations

Ridges and trenches are not stationary relative to each other



a) Plate B is growing; b) Plate B is unchanged; c) Plate B is consumed

- **magnitude of velocity is changing** (not direction)

(c-e) Plate B is consumed

- **Change the direction of plate A relative to C**, which determines the nature of the new margin delimiting plate A and C when they come in contact (ridge, single plate, trench).

Case d: Plate A in contact with Plate C and coalesce in a new margin (no relative motion, formation of an inactive margin).

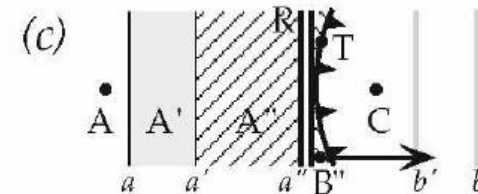
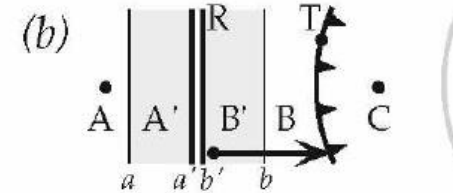
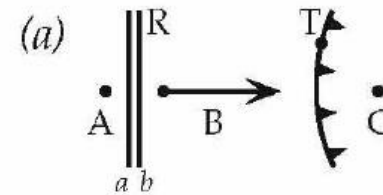
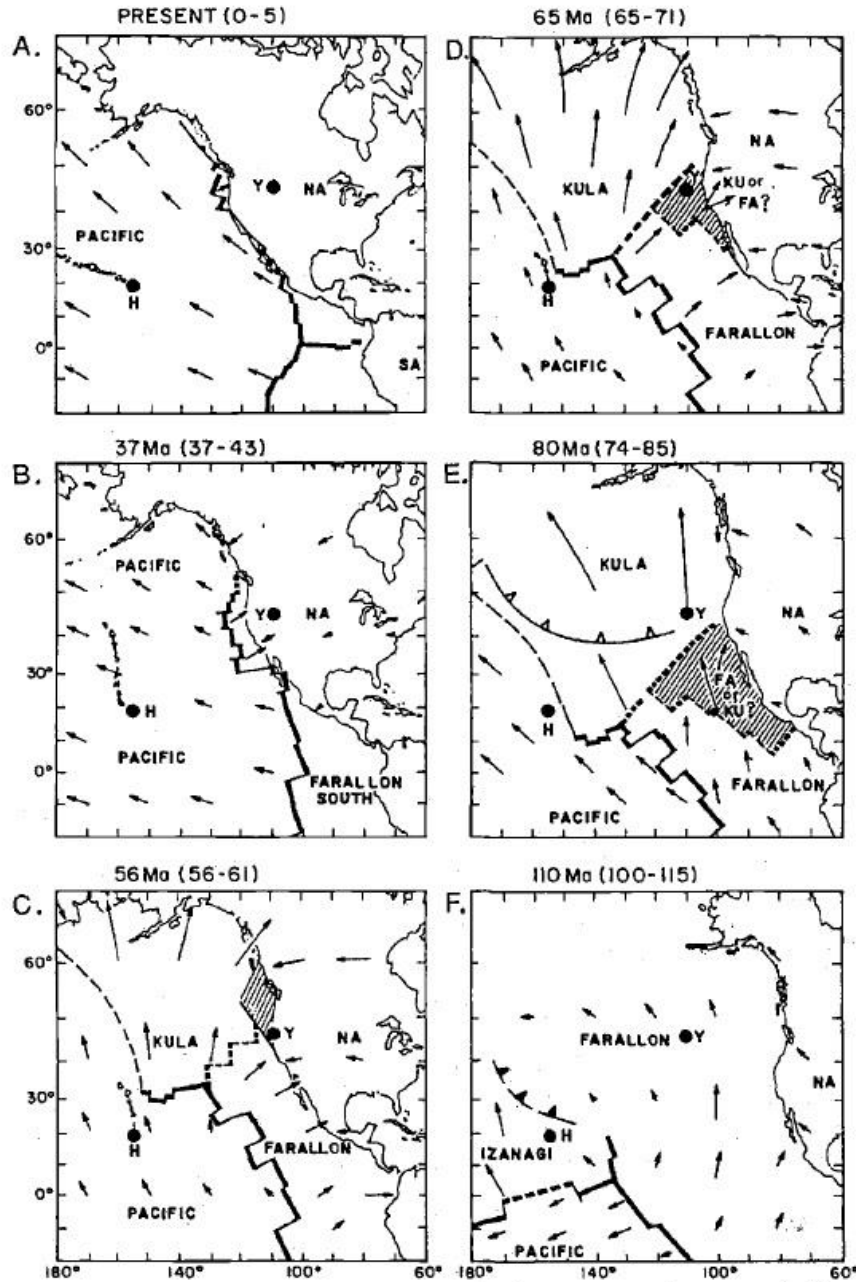

Plate Evolution



In Nature: case c) is represented by Pacific-Antarctic ridge, which migrates slowly away from Antarctica; case d) resembles the former situation of western North America, where the former Farallon plate has disappeared; case e) is similar to the North Pacific, where the Kula plate used to subduct under the Aleutian Islands, but now the Pacific plate subducts after it.

Relative plate motions

- Relative motion between two plates is defined by an angular separation about a pole of relative motion
- The motion of plates over the Earth's surface can be described by making use of Euler's theorem

- When tangential motion occurs during the relative movement of two plates, the transform faults along their common boundary must follow the traces of small circles centered upon the pole of relative motion.
- The pole of rotation of two plates can thus be determined by constructing great circles at right angles to the trends to transform faults affecting their common margin and noting their point of intersection.

The velocity of the relative movement from the equator to the common pole of rotation decreases according to the cosine of the Euler pole's latitude :

$$v_{\alpha} = v_0 \cos \alpha$$

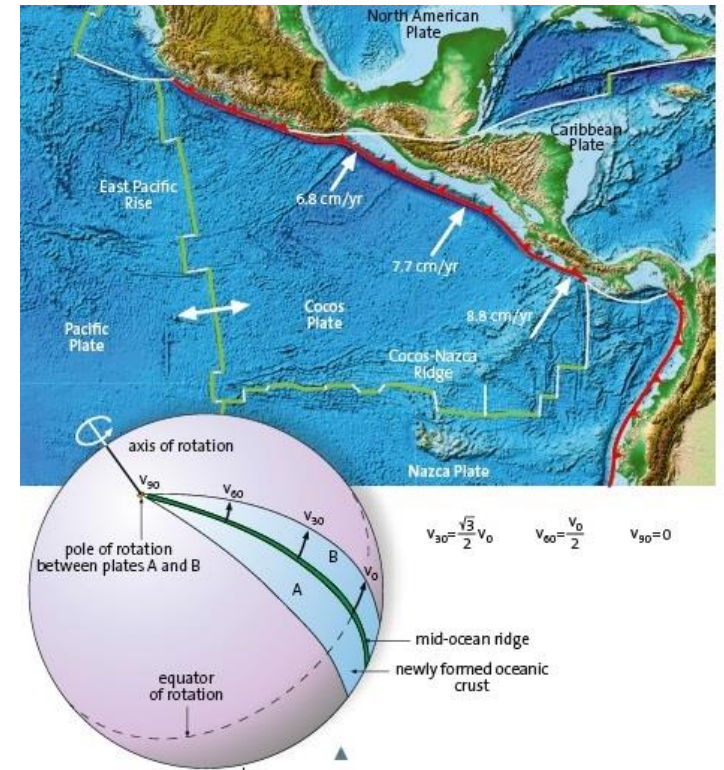
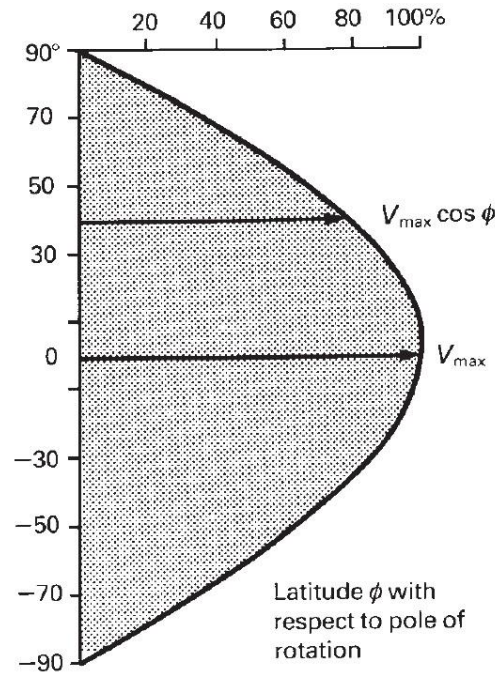
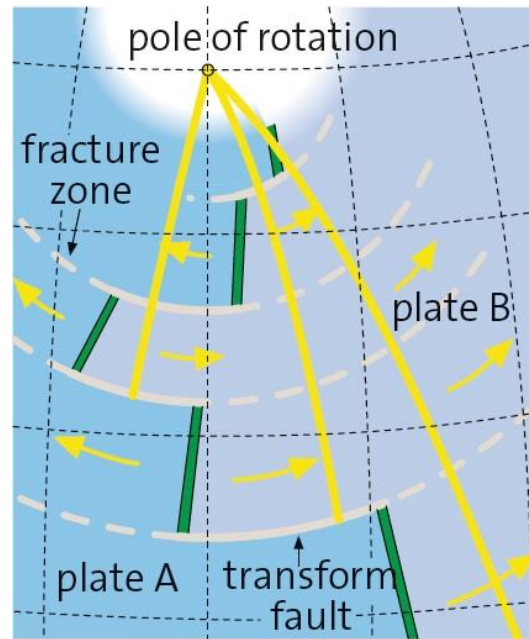
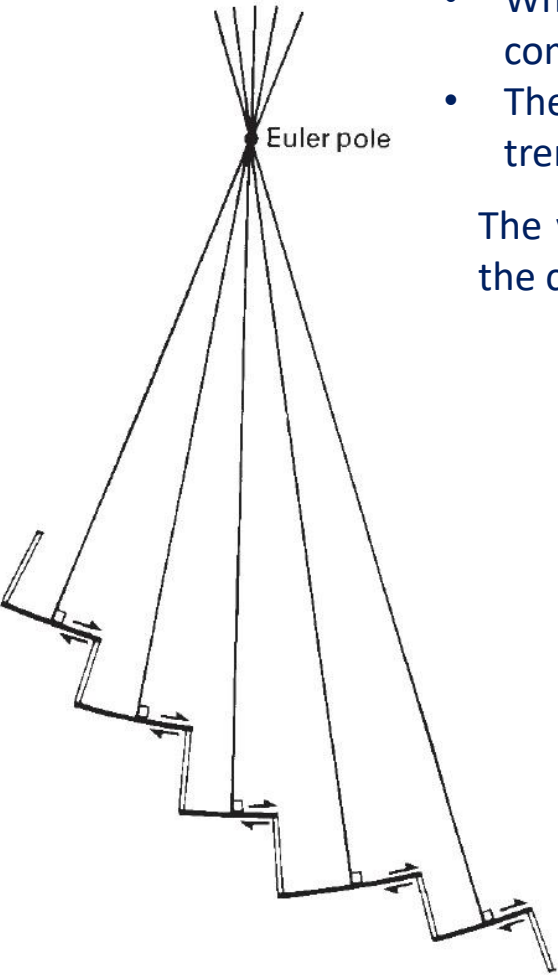

Relative plate motions

Other Methods:

Variation of spreading rates with angular distance from the pole of rotation:

Spreading rates are determined from magnetic lineations, by identifying anomalies of the same age on either side of the ocean ridge. Stripes located at two plates which are connected at the mid-ocean ridge become narrower towards the common pole of rotation.

Focal mechanism solution of earthquakes on their common margins: horizontal component of the slip vector is the direction of relative motion (less reliable because of the detailed geometry of fault systems).

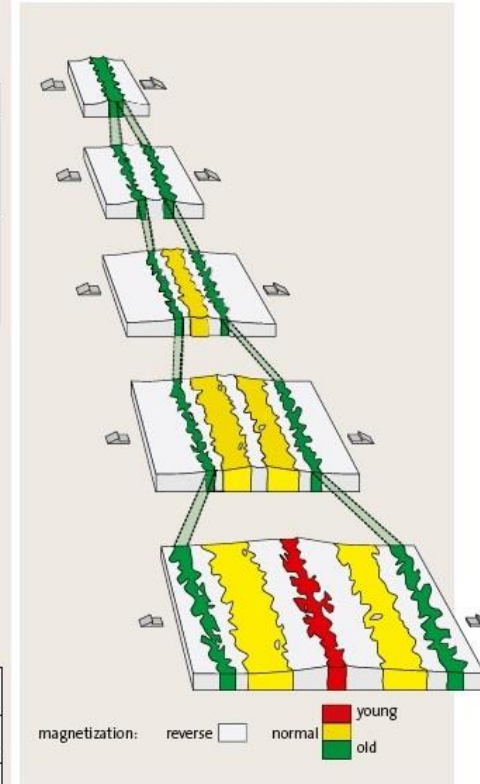
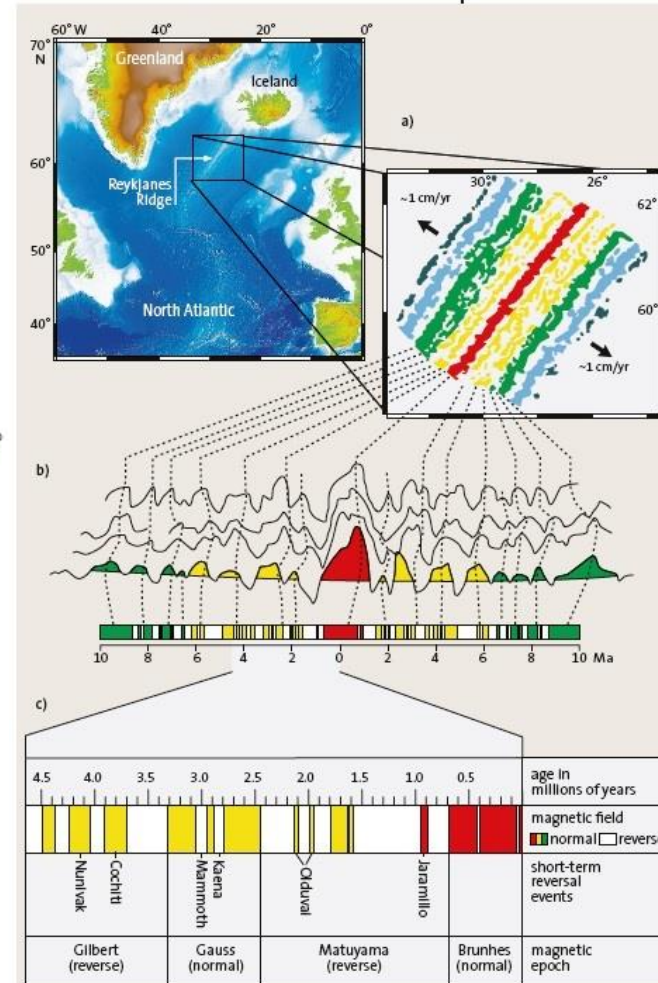
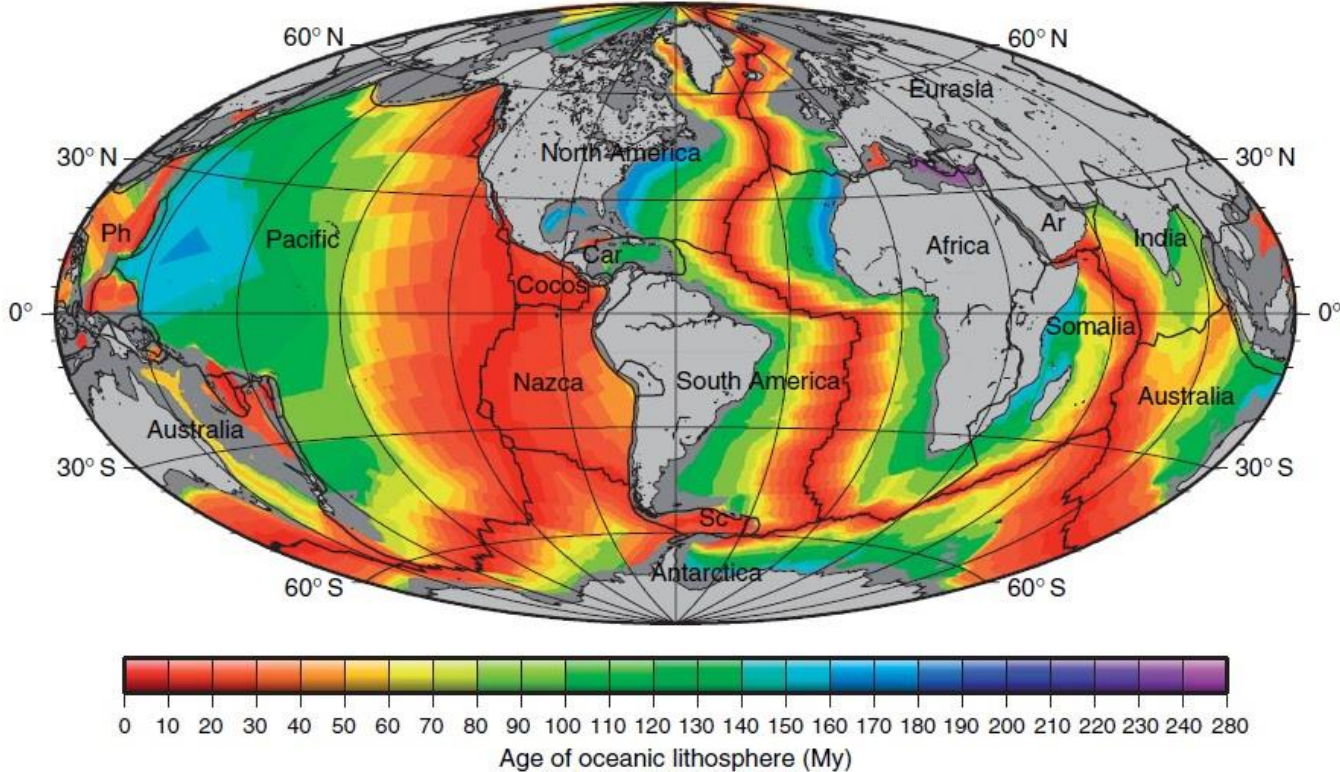

Relative plate motions

- Divergent plate boundaries can be studied using spreading rates and transform faults, while for convergent boundaries it is often necessary to use indirect means to determine relative velocities: e.g., information from adjoining plates and treating the rotations between plate pairs as vectors.

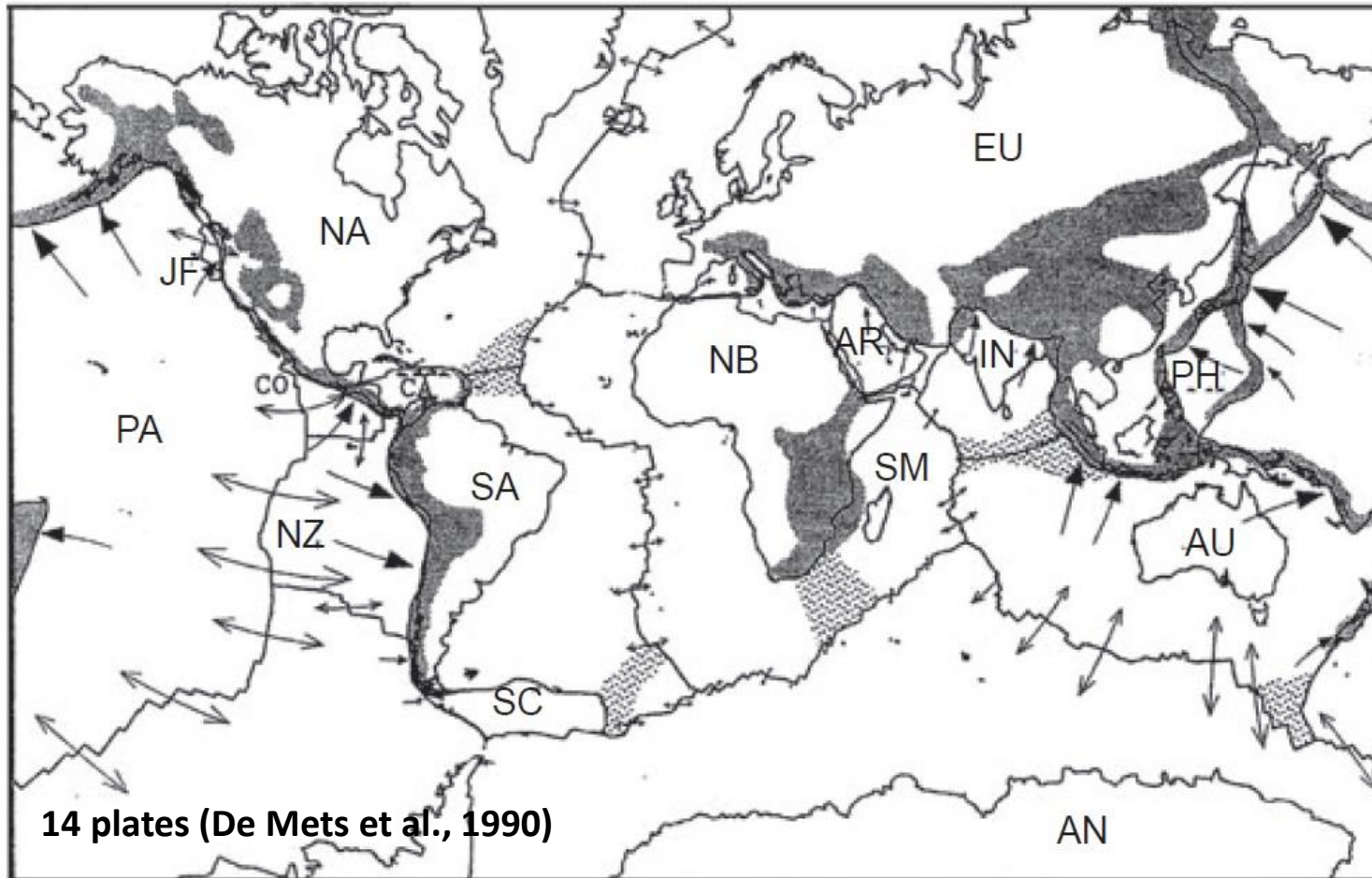

The oceanic plates of the Pacific are steadily reducing in size as they are being consumed at subduction zones at a higher rate than they are being created at the East Pacific Rise:

- Accretion rates per ridge flank along the East Pacific margin: 25-75 mm/yr
- Subduction rate along the other margins of the Pacific: 60-90 mm/yr

Approximately 15% of the Earth's surface is covered by regions of deforming lithosphere

AN, Antarctica; AR, Arabia; AU, Australia; CA, Caribbean; CO, Cocos; EU, Eurasia; IN, India; JF, Juan de Fuca; NA, North America; NB, Nubia; NZ, Nazca; PA, Pacific; PH, Philippine; SA, South America; SC, Scotia Sea; SM, Somalia

Relative plate motions

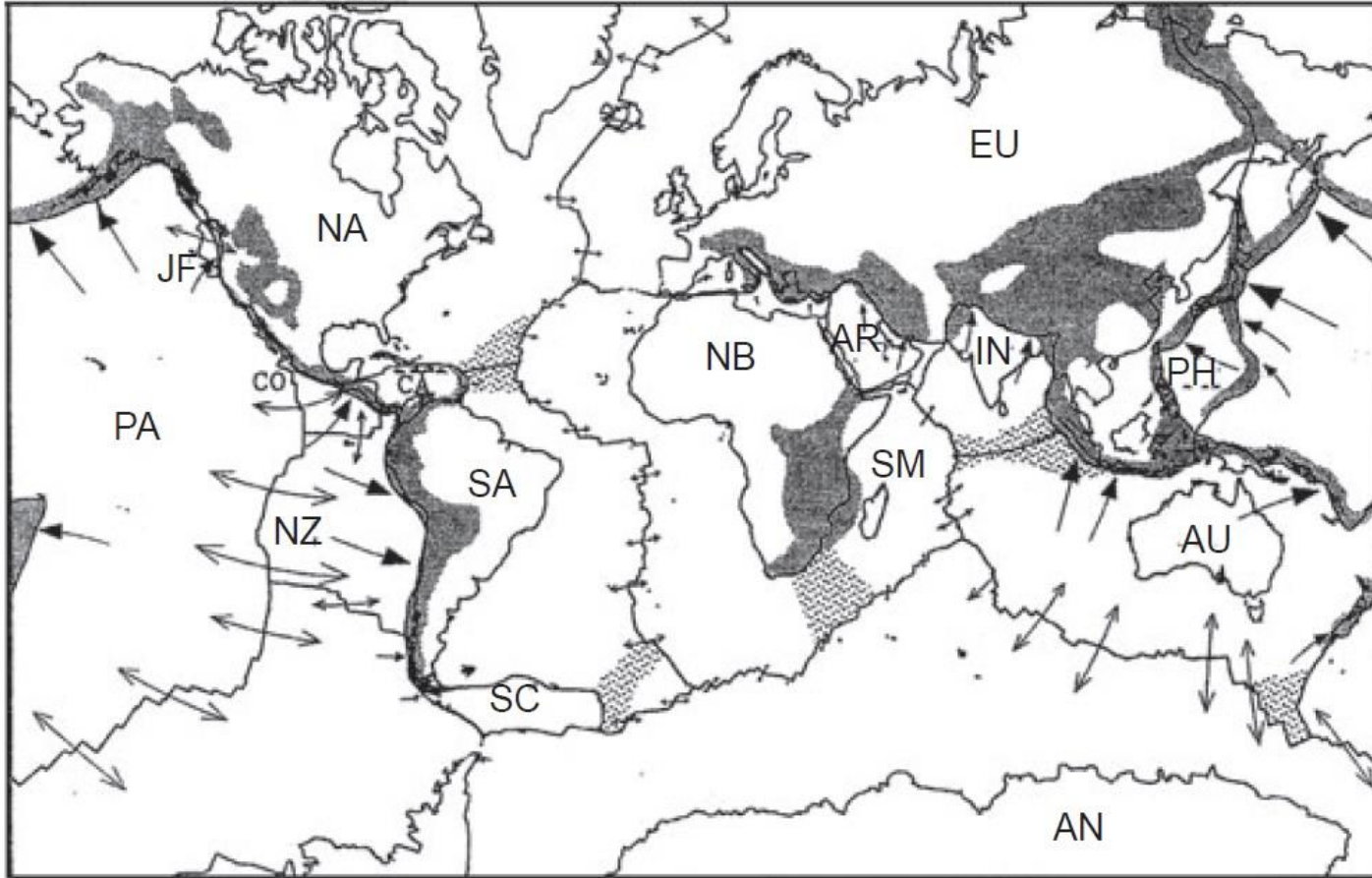

Spreading rates at mid-ocean ridges ("spreading rate" is defined as the accretion rate per ridge flank).

Ridge	Latitude	Observed rate (mm a ⁻¹)	Predicted rate (mm a ⁻¹)
Juan de Fuca	46.0°N	29	†
Gulf of California	23.4°N	25	24.7
Cocos – Pacific	17.2°N	37	39.4
Pacific	3.1°N	67	65.4
Galapagos	2.3°N	22	22.0
Galapagos	3.3°N	34	34.6
Nazca – Pacific	12.6°S	75	74.2
Chile Rise	43.4°S	31	30.2
Pacific – Antarctic	35.6°S	50	49.5
Antarctic	51.0°S	44	44.6
Antarctic	65.3°S	26	29.0
North Atlantic	86.5°N	6	5.7
North Atlantic	60.2°N	9.5	9.2
North Atlantic	42.7°N	11.5	11.9
Central Atlantic	35.0°N	10.5	11.0
Central Atlantic	23.0°N	12.5	12.6
Cayman	18.0°N	7.5	5.9
South Atlantic	38.5°S	18	17.6
Antarctic – South America	55.3°S	10	9.3
Africa – Antarctic	44.2°S	8	7.4
Northwest Indian Ocean	4.2°N	14	14.6
Northwest Indian Ocean	12.0°S	18.5	17.9
Northwest Indian Ocean	24.5°S	25	24.5
Southeast Indian Ocean	25.8°S	28	28.8
Southeast Indian Ocean	50.0°S	38	37.3
Southeast Indian Ocean	62.4°S	34.5	33.7
Gulf of Aden	12.1°N	8	8.6
Gulf of Aden	14.6°N	12	12.1
Red Sea	18.0°N	10	8.2

- Spreading boundary is perpendicular to the direction of relative motion.
- In the convergent margins, relative motion vector makes an oblique angle with the plate boundary (western end of Aleutine arc): in addition to the component of motion perpendicular to the plate boundary, that produces underthrusting, there will be a component of relative motion parallel to the plate boundary.
- Focal mechanism solution underestimate the trench parallel component, because part of this is taken up by strike-slip faulting.

Direct measurement of relative plate motions

Three independent methods of extraterrestrial surveying are available: (1) very long baseline interferometry, (2) satellite laser ranging, and (3) satellite radio positioning (GPS):

1. Very long baseline interferometry (VLBI) makes use of the radio signals from extragalactic radio sources or quasars (quasi-stellar radio sources): The signal from a particular quasar is recorded simultaneously by two or more radio telescopes at the ends of baselines which may be up to 10,000 km long. The signals received at the telescopes are delayed by different times, the magnitude of the delays between two stations, being proportional to the distance between them and the direction from which the signals are coming (20 mm of accuracy).
2. Satellite laser ranging (SLR) calculates the distance to an orbiting artificial satellite or a reflector on the Moon by measuring the two-way travel time of a pulse of laser light reflected from the satellite (repeated measurements from two laser systems that at different sites simultaneously track the same satellite provide an accuracy of about 80 mm).
3. Satellite radio positioning makes use of radio interferometry from the 24 GPS satellites. It is a 3D method by which the relative positions of instruments at the ends of baselines are determined from the signals received at the instruments from several satellites.

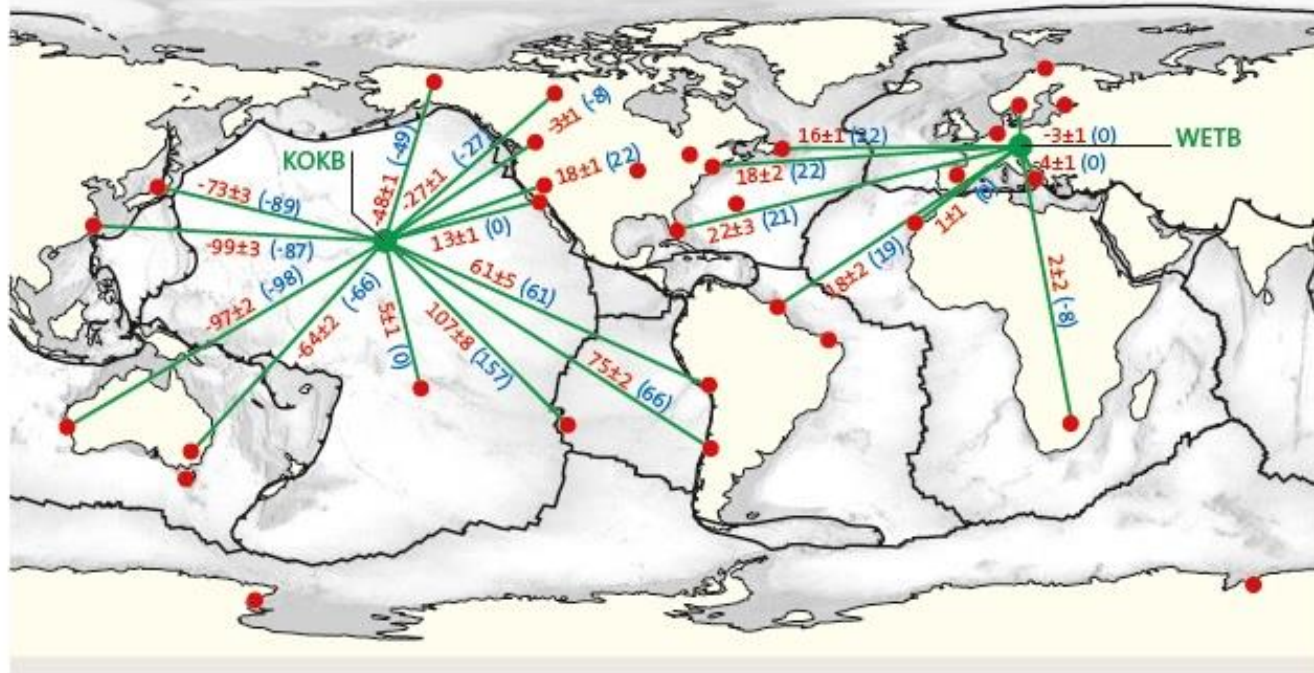

Relative movements between points belonging to the same plate indicate a certain internal deformation related to earthquake activity within the plate.

— GPS
— NUVEL

Time Period: 1993-1995

Absolute plate motion No Net Rotation reference frame (NNR)

- The *absolute* motion of plates is much more difficult to define than the relative motion between plates at plate boundaries also because the whole solid Earth is in a dynamic state: To measure *absolute plate motions*, a stationary coordinate system is required that is centered in the Earth's center of gravity and defined by the geographic pole (z axis) and the spring point of the ecliptic (x axis).
- Absolute plate motions should specify the motion of the lithosphere relative to the lower mantle as this accounts for 70% of the mass of the solid Earth and deforms very slowly.
- If the lithosphere and asthenosphere would be everywhere of the same thickness and effective viscosity, there would be no net torque on the plates and no net rotation of the lithosphere relative to the Earth's deep interior.
- If plate velocities are specified in the no net rotation (NNR) reference frame, the integration of the vector product of the velocity and position vectors for the whole Earth's surface will equal zero.

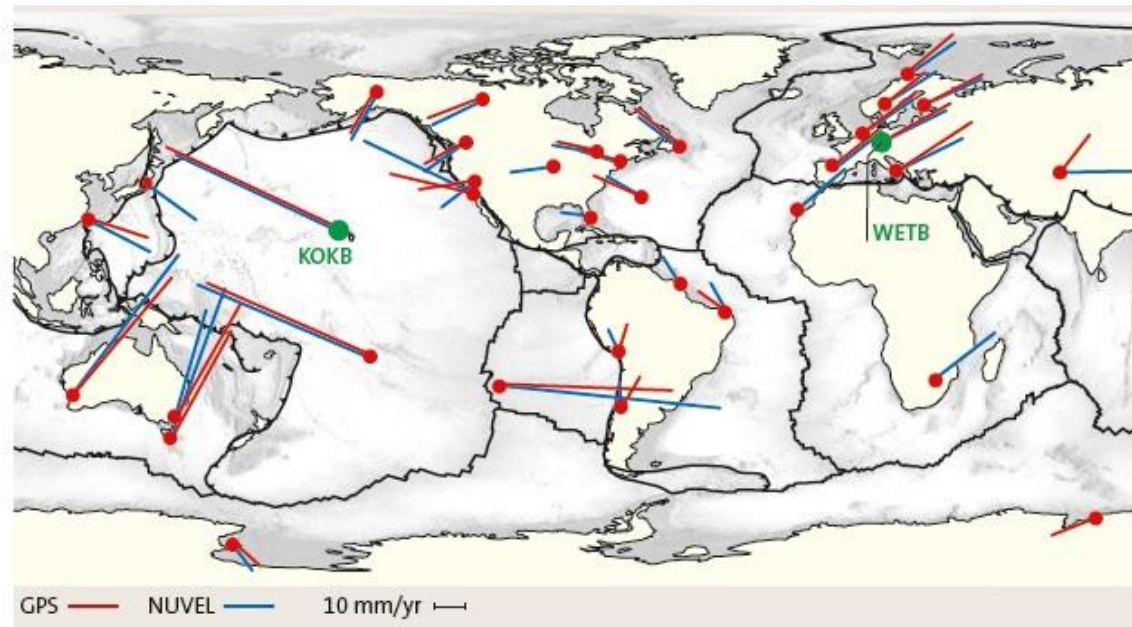

Other frames of reference for absolute motions proposed that:

- Africa became stationary during the past 25 Myr. Its uplift during the late Cenozoic is likely the result of the plate becoming stationary over hotspots in the upper mantle.
- Caribbean plate is likely to be stationary, as it has subduction zones of opposite polarity along its margins.

Absolute plate motion (hotspots reference frame)

- Hotspots are located over plumes of hot material rising from the lower mantle, and hence provide a fixed reference frame with respect to the lower mantle and offers the possibility of determining the absolute motion of plates throughout the past 200 Myr.
- Between 40 and 50 present day hotspots have been suggested. Many are short-lived, and consequently have no tracks reflecting the motion of the plate on which they occur, while others have persisted for tens or hundreds of millions of years.
- The island chains lying on hot spots are invariably younger than the ocean crust on which they stand. The lower parts of these volcanic edifices are formed predominantly of tholeiitic basalt, while the upper parts are alkali basalts and compared to mid-ocean ridge basalts, have higher concentrations of Fe, Ti, Ba, Zr, and rare earth elements (REE).

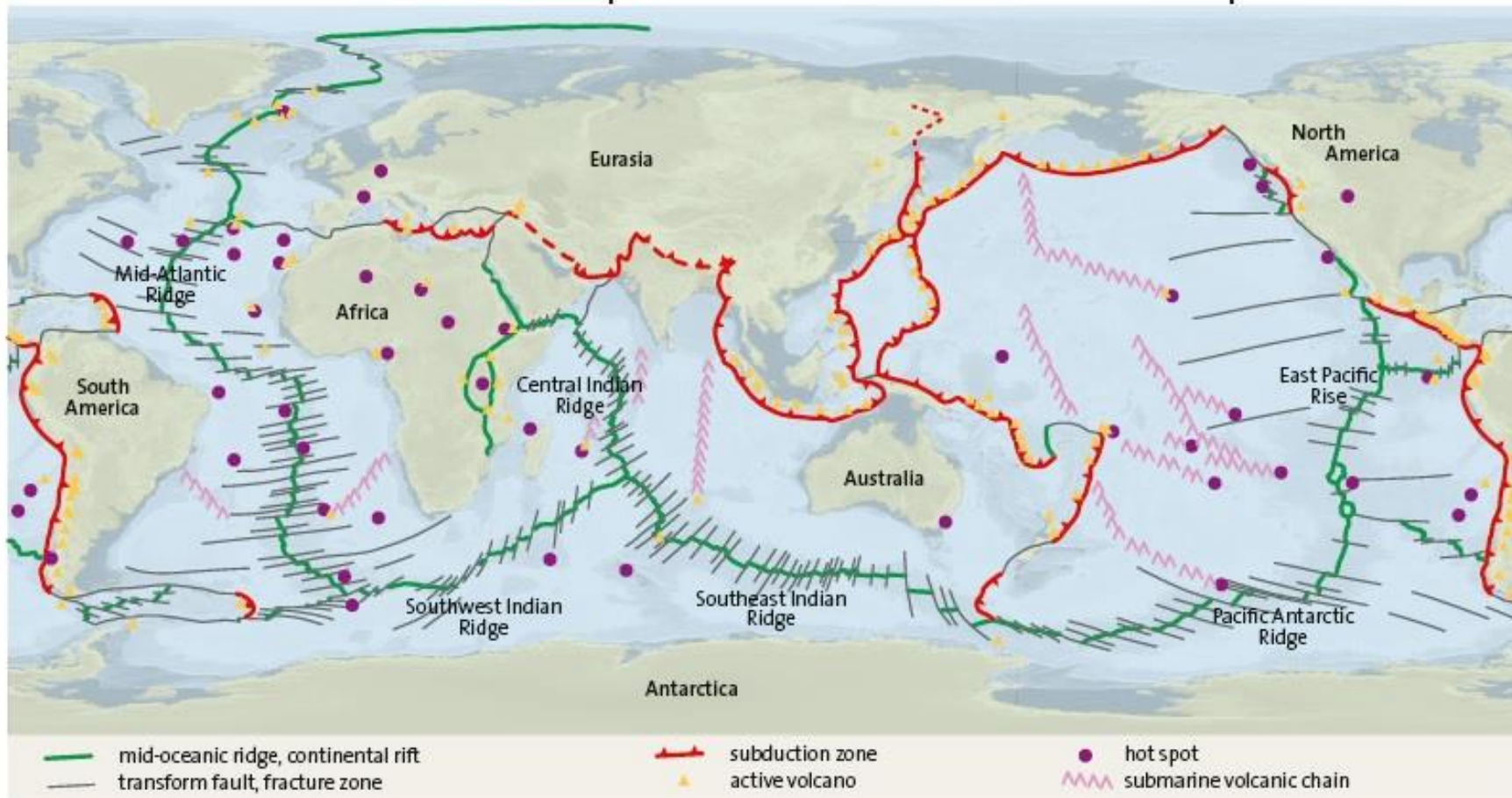

Absolute plate motion (hotspots reference frame)

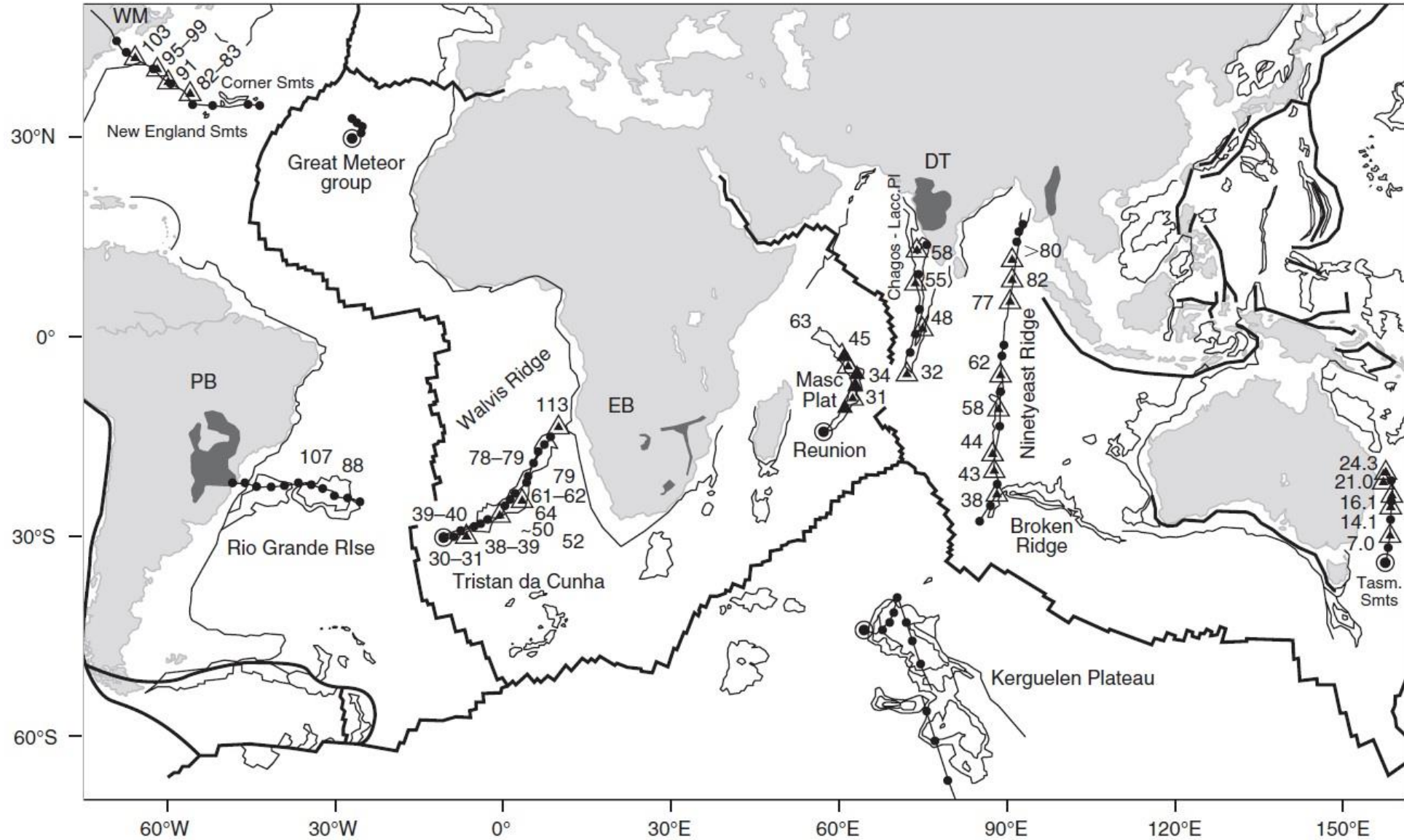

Small filled circles define the modeled paths of hotspots at 5 Ma intervals. Triangles on hotspot tracks indicate radiometric ages.

Absolute plate motion (hotspots reference frame)

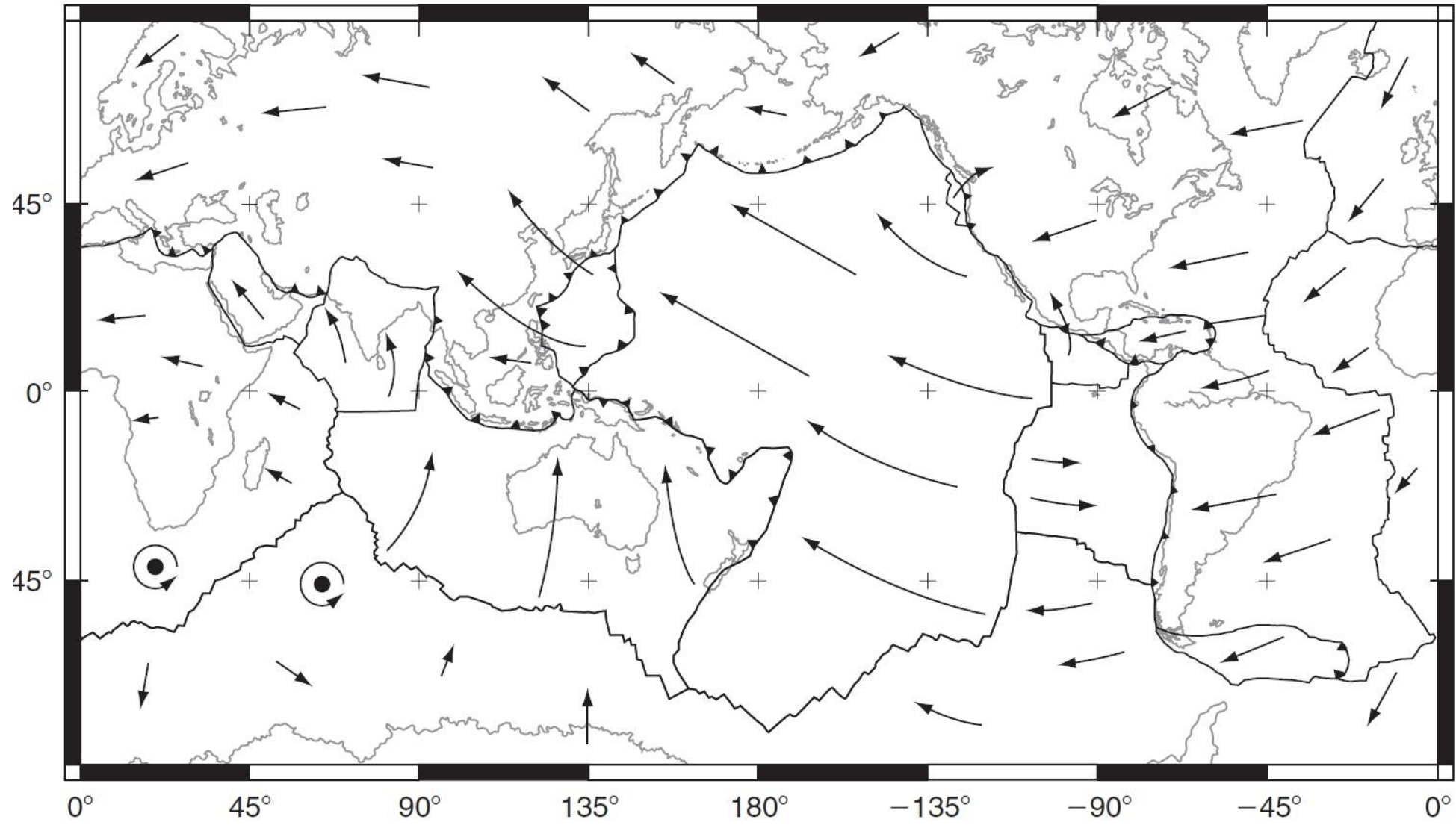

The arrows indicate the displacement of points within the plates if the plates were to maintain their current angular velocities, relative to the hotspots, for 40 Myr.

Hot Spots movements

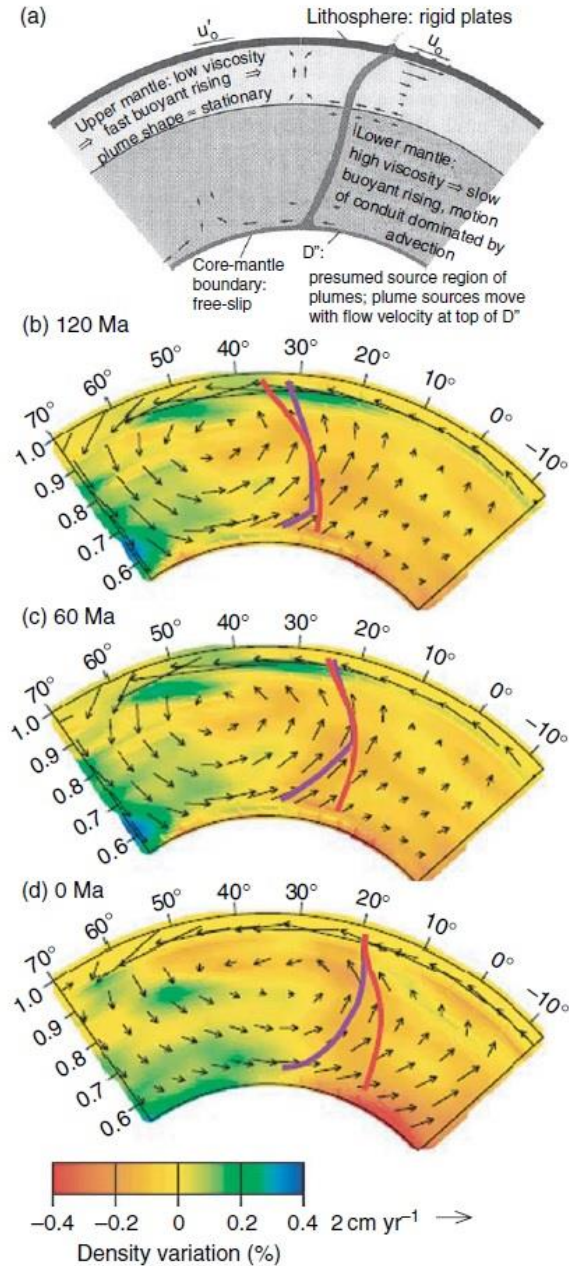

- Although hot spots are supposed stationary and define a global kinematic reference frame separate from the plates, ongoing studies established that hot spots move relative to the Earth's spin-axis and that there is motion between the Pacific and Indo-Atlantic hot spots with speeds comparable to the average plate speed (e.g., rapid southward motion of the Kerguelen hot spot in the past 100 Myr and of the Hawaiian hot spot before than 50 Myr).
- Since plumes rise from the deep, it should be intuitive that hot spots are not stationary due to the convecting mantle flow. Plume conduits therefore deform with time and where they intersect the base of the lithosphere defines the location of the hot spots.
- For the Hawaiian hot spot, mantle flow models predict absolute southward motion that was rapid (average 40 kmMyr⁻¹) during 50–80 Myr and slower (<20 kmMyr⁻¹) since 50 Myr, fitting paleomagnetic data.

(a) Rise and deformation of plumes through a flowing mantle with layered viscosity and surface plate motion. (b-d) Arrows show predicted mantle flow, while colors density variations and deformation of the Hawaiian plume rising from the CMB at a location that is fixed (purple, initiated 150 Ma, or moving with the mantle (red, initiated 170 Ma).

Stability of triple junctions

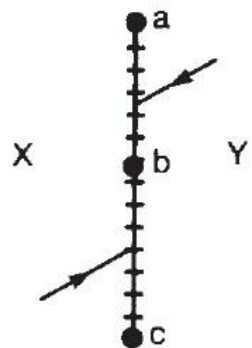

+++++ Trench

====><==== Transform fault

Alpine fault

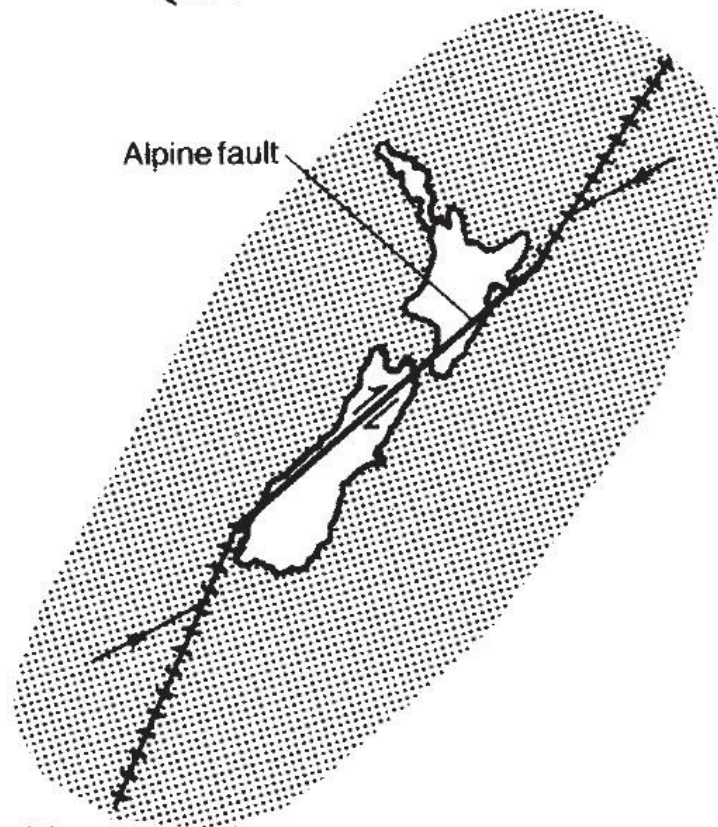

(a)

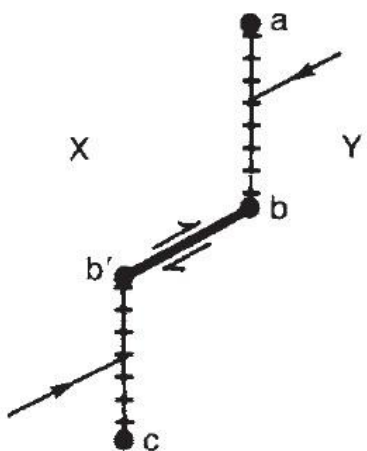

(b)

(c)

Plate X is underthrusting plate Y at bc in a northeasterly direction and plate Y is underthrusting plate X at ab in a southwesterly direction:

- The boundary is unstable because a trench can only consume in one direction, so to accommodate these movements a dextral transform fault develops at b.
- A more complex and potentially unstable situation arises when three plates come into contact at a triple junction.
- Quadruple junctions are always unstable, and immediately devolve into a pair of stable *triple junctions*.
- Only six types of triple junction are present during the current phase of plate tectonics: RRR (e.g. the junction of East Pacific Rise and Galapagos Rift Zone), TTT (central Japan), TTF (junction of Peru–Chile Trench and West Chile Rise), FFR (possibly at the junction of Owen Fracture Zone and Carlsberg ridge), FFT (junction of San Andreas Fault and Mendocino Fracture Zone), and RTF (mouth of Gulf of California).

T=Trench F=Transform Fault R=Ridge

Stability of triple junctions

Transform Fault Boundary

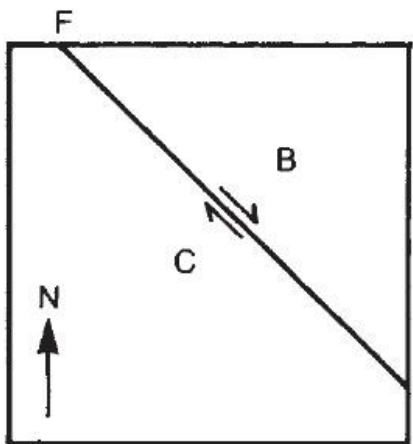

(a)

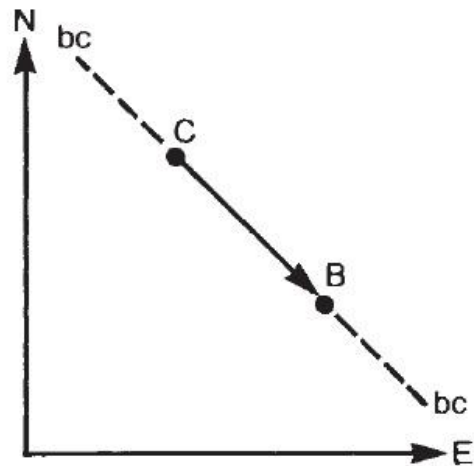

(b)

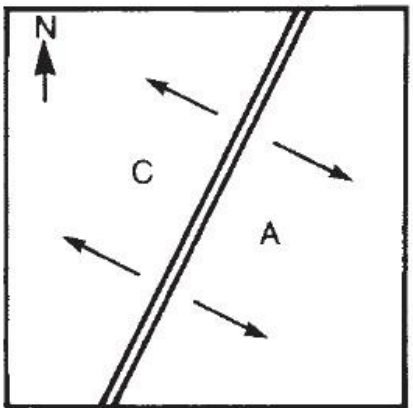

(a)

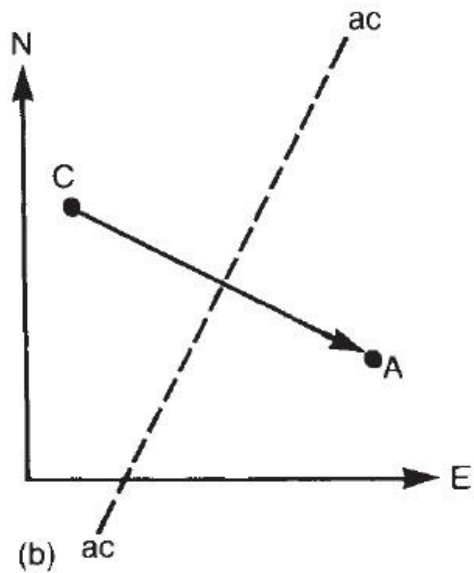

(b)

Ridge Boundary

Trench Boundary

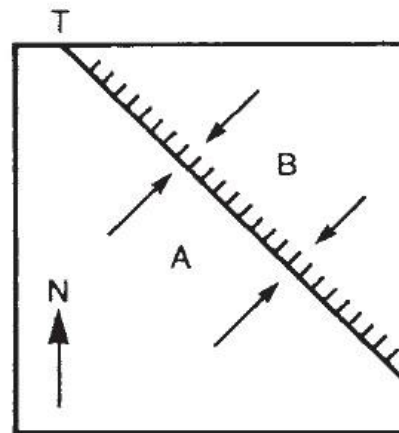

(a)

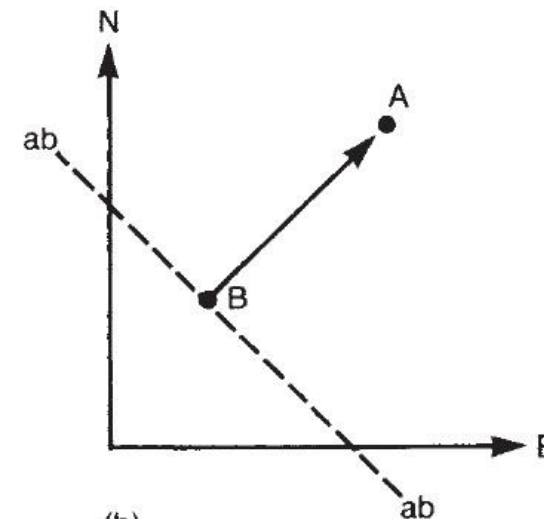

(b)

- **R Boundary**: velocity vector AC is now orthogonal to the plate margin, and so the line *ac* now represents the locus of a point traveling along the ridge.
- **F Boundary**: Line BC represents the relative velocity vector between the plates, but the locus of a point traveling up and down the fault, *bc*, is now in the same sense as vector BC (the relative motion direction of B and C is along their boundary).
- **T Boundary**: The direction of line AB represents the direction of relative movement between A and B, while Line *ab* must represent the locus of a point that travels up and down the trench.

Stability of triple junctions

Stable Triple Junction

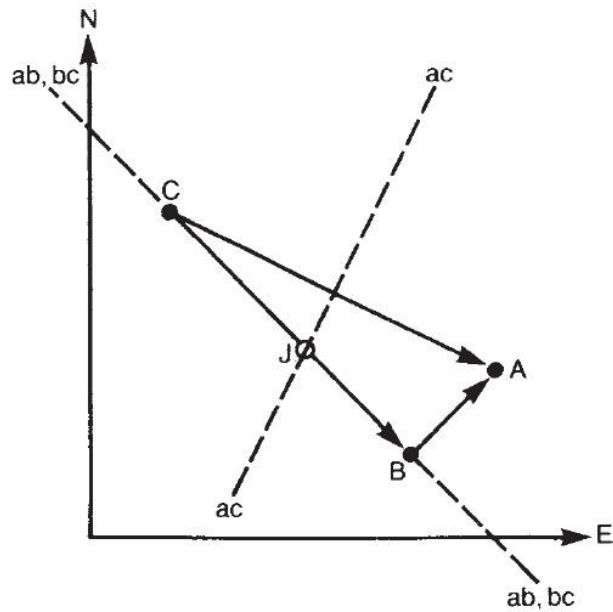
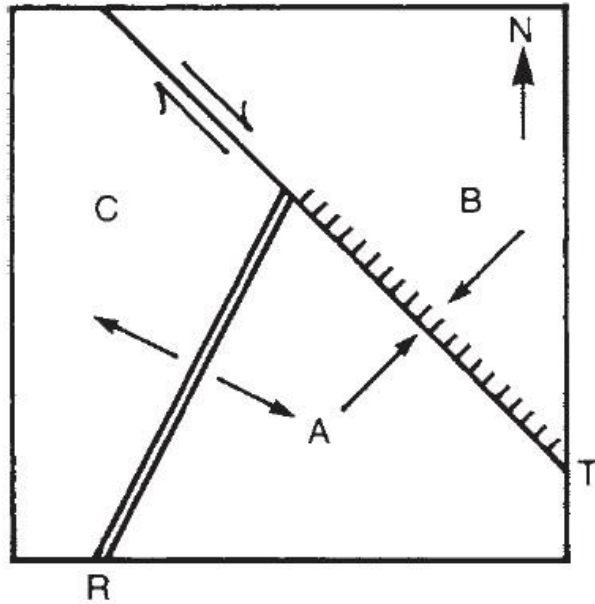

Unstable Triple Junction

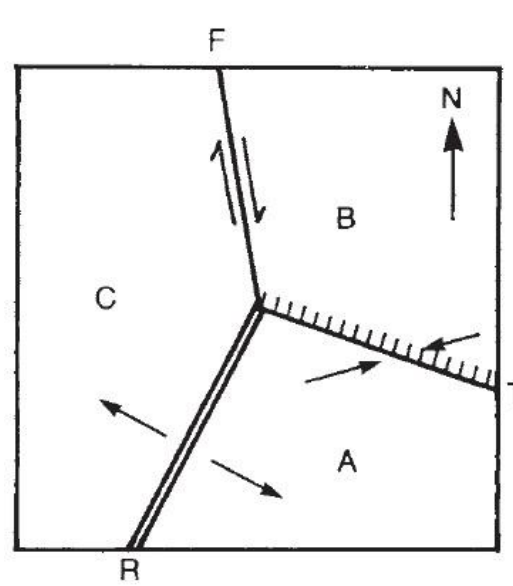

(a)

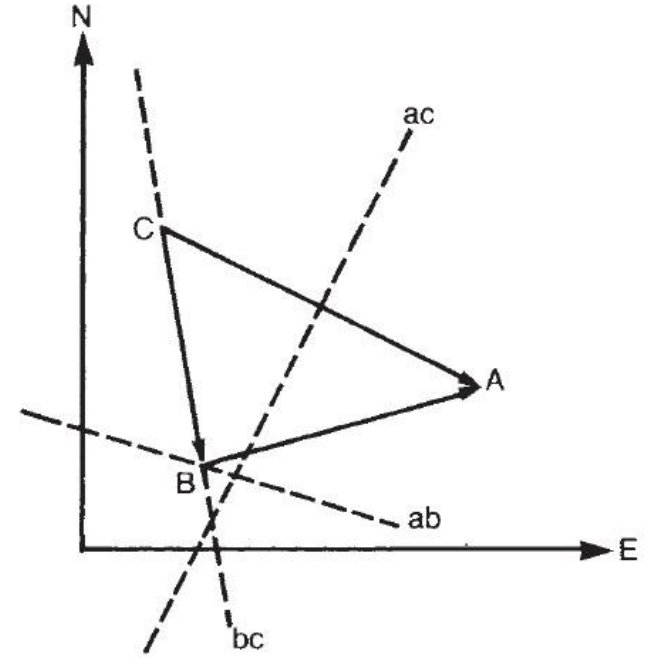

(b)

- By combining the velocity space representations, the stability of the triple junction can be determined from the relative positions of the velocity lines representing the boundaries, if they intersect at one point the triple junction is stable.

Triple Junctions

Triple Junctions: Points where three plate margins meet

R=Ridge F=Transform Fault T=Trench

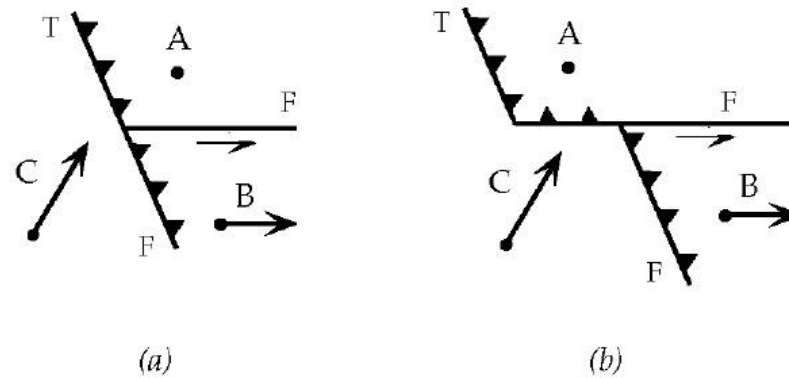
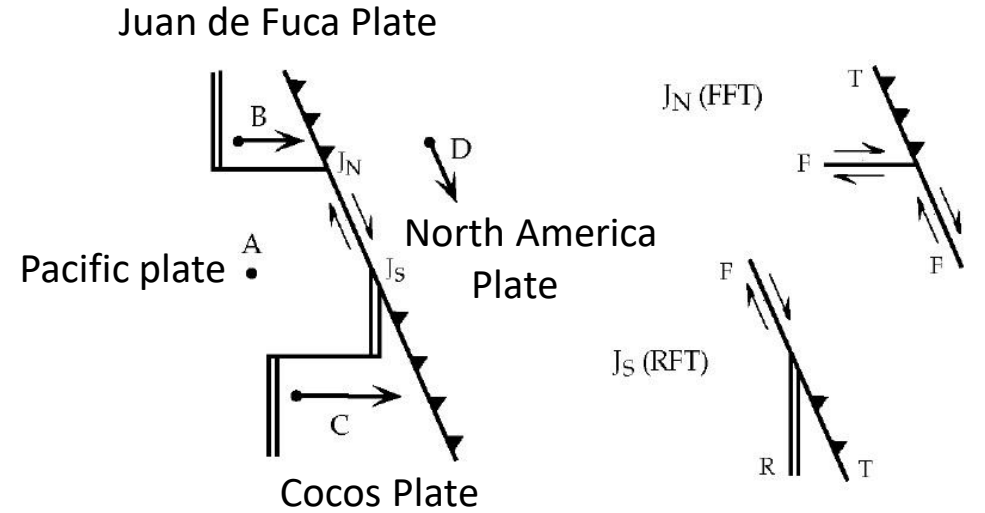
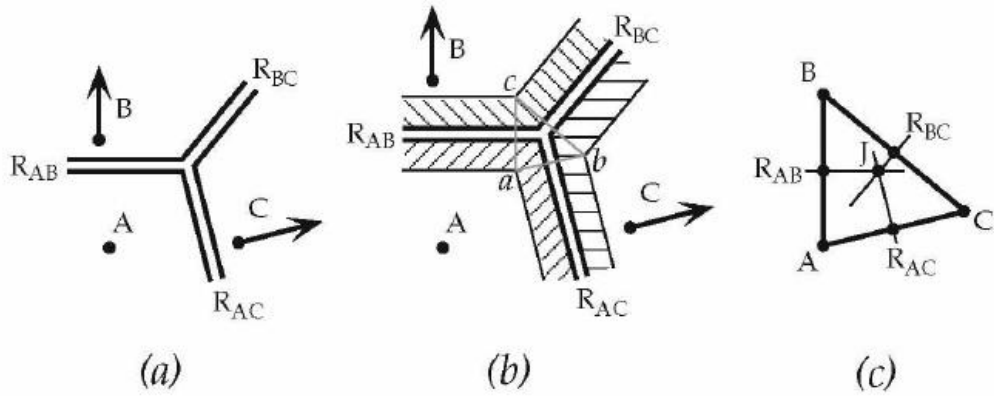

Unstable

Stable

(part of the trench moves with a different plate) (Plates are separated)

Stability of triple junctions

- Among 16 possible combinations of trench, ridge, and transform fault, taking into account the two possible polarities of trenches, but not transform faults, only the RRR triple junction is stable for any orientation of the ridges.
- This comes about because the associated velocity lines are the perpendicular bisectors of the triangle of velocity vectors, and these always intersect at a single point (the circumcenter of the triangle).
- The FFF triple junction is never stable, as the velocity lines coincide with the vector triangle, and, of course, the sides of a triangle never meet in a single point. The other possible triple junctions are only stable for certain particular orientations of the juxtaposed plate margins.

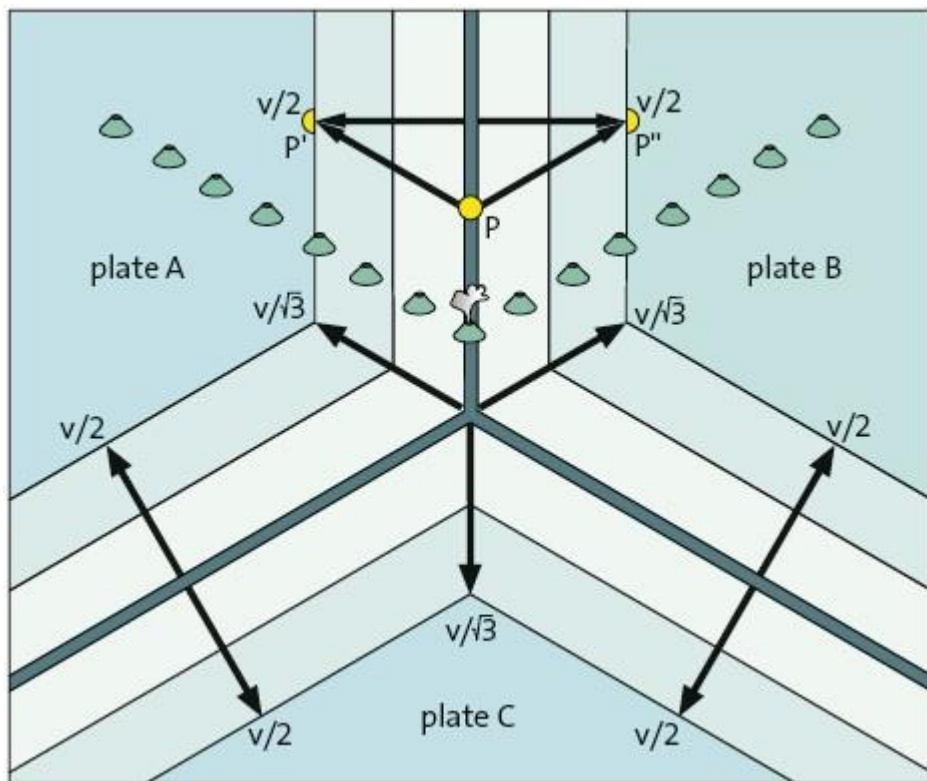

Type	Geometry	Velocity triangle	Stability	Examples	Type	Geometry	Velocity triangle	Stability	Examples
RRR			All orientations stable	East Pacific Rise and Galapagos Rift Zone Great Magnetic Bight	TTR(c)			Stable if the angles between ab and ac, bc respectively, are equal, or if ac, bc form a straight line	
TTT(a)			Stable if ab, ac form a straight line, or if bc is parallel to the slip vector CA	Central Japan	TTF(a)			Stable if ac, bc form a straight line, or if C lies on ab	Intersection of the Peru-Chile Trench and the Chile Ridge
TTT(b)			Stable if the complicated general condition for ab, bc and ac to meet at a point is satisfied		TTF(b)			Stable if bc, ab form a straight line, or if ac goes through B	
FFF			Unstable		TTF(c)			Stable if ab, ac form a straight line, or if ab, bc do so	
RRT			ab must go through circumcenter of ABC		FFR			Stable if C lies on ab, or if ac, bc form a straight line	Owen Fracture Zone and the Carlsberg Ridge West Chile Ridge and the East Pacific Rise
RRF			Unstable, evolves to FFR		FFT			Stable if ab, bc form a straight line, or if ac, bc do so	San Andreas Fault and Mendocino Fracture Zone
TTR(a)			Stable if ab goes through C, or if ac, bc form a straight line		RTF(a)			Stable if ab goes through C, or if ac, bc form a straight line	Mouth of the Gulf of California
TTR(b)			Stable if complicated general conditions are satisfied		RTF(b)			Stable if ac, ab cross on bc	

Plate tectonics during the geological time

Possible craton configurations during Late Archean–Early Proterozoic times.

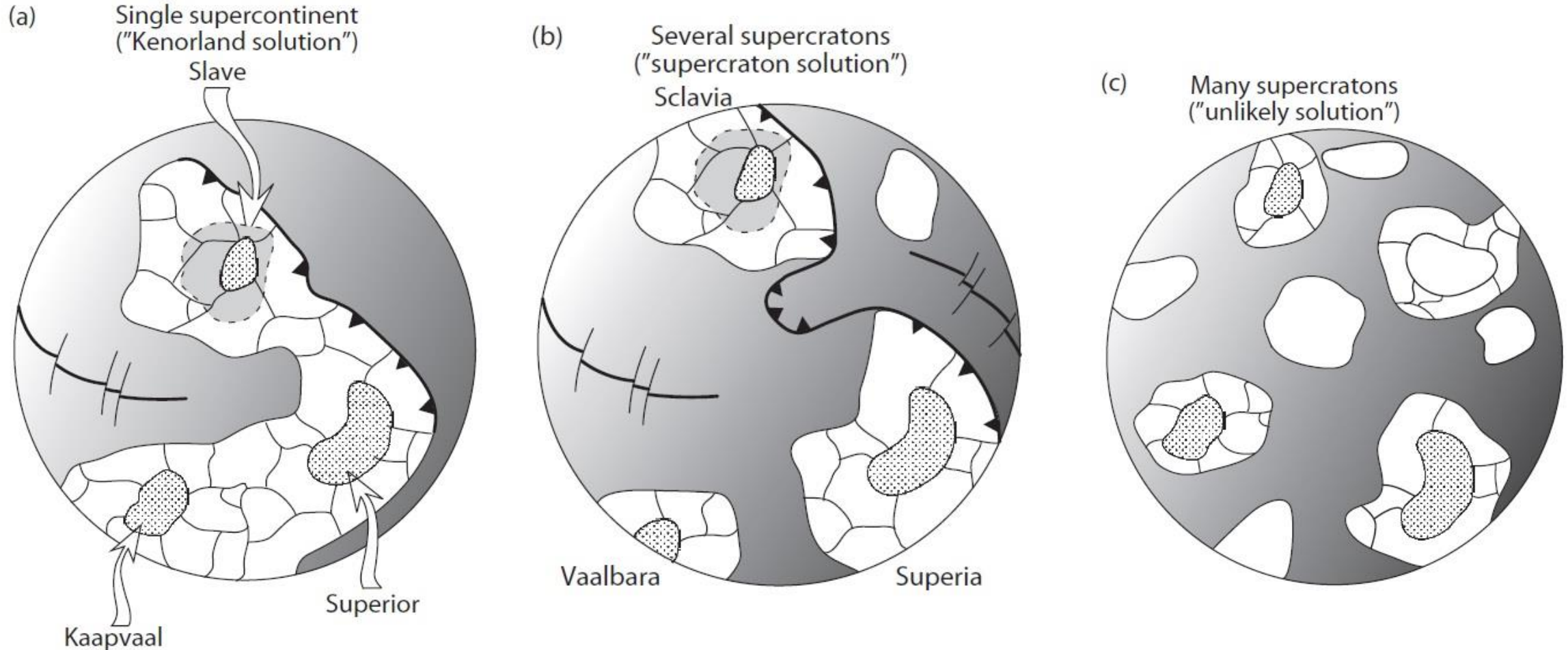

Diachronous break-up of the supercratons occurred during the period 2.5–2.0 Gyr, resulting in the 35 or more independently drifting cratons: Paleomagnetic evidence supports the conclusion that significant differences in the paleolatitudes existed between at least several of these fragments during the Early Proterozoic.

Plate tectonics during the geological time

Late Proterozoic Supercontinent Rodinia

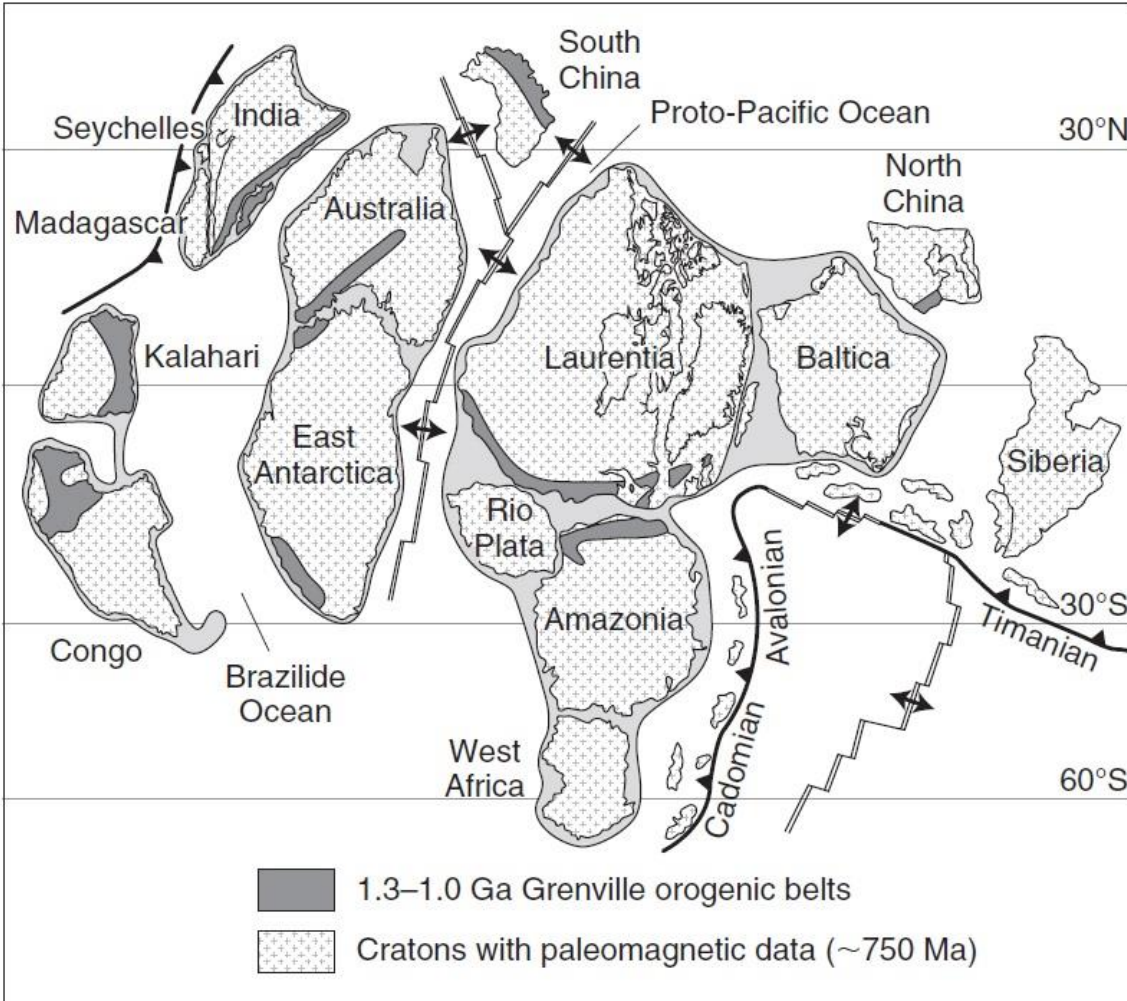

- Paleogeographic maps for the Mesozoic and Cenozoic can be computed by the fitting together of continental margins or oceanic lineations of the same age on either side of an ocean ridge.
 - Methods of quantifying plate motions in pre-Mesozoic times involve the use of paleomagnetic data coupled with high-precision geochronology.
 - Most reconstructions rely on combinations of many different data sets (e.g., geological correlations, sedimentary provenance, the ages of rifting and continental margin formation, and the record of mantle plume events).
 - Evidence provided from the past distributions of flora and fauna and indicators of paleoclimate also aid these plate reconstructions, which become more and more uncertain going back in time.
-
- The majority of assembly of Rodinia supercontinent occurred between 1.1 and 1.0 Gyr, and only minor collisions between 1.0 and 0.9 Ga.
 - The position of the continents suggests that the break-up of Rodinia began by 850 or 800 Myr with the opening of the proto-Pacific ocean between western Laurentia and Australia-East Antarctica.

Plate tectonics during the geological time

- Laurentia (North America and Greenland) forms the core of the supercontinent Rodinia and is flanked to the north by East Antarctica.
- During the fragmentation (~750 Myr) the blocks making up East Gondwana (East Antarctica, Australia, and India) moved anticlockwise, opening the proto-Pacific Ocean (Panthalassa), and collided with the blocks of West Gondwana (Congo, West Africa, and Amazonia).
- The break-up of Rodinia triggered large changes in global climate: there were two periods of global glaciation during the Late Proterozoic, controlled by anomalously low atmospheric CO₂ concentrations.

Late Proterozoic Supercontinent Rodinia

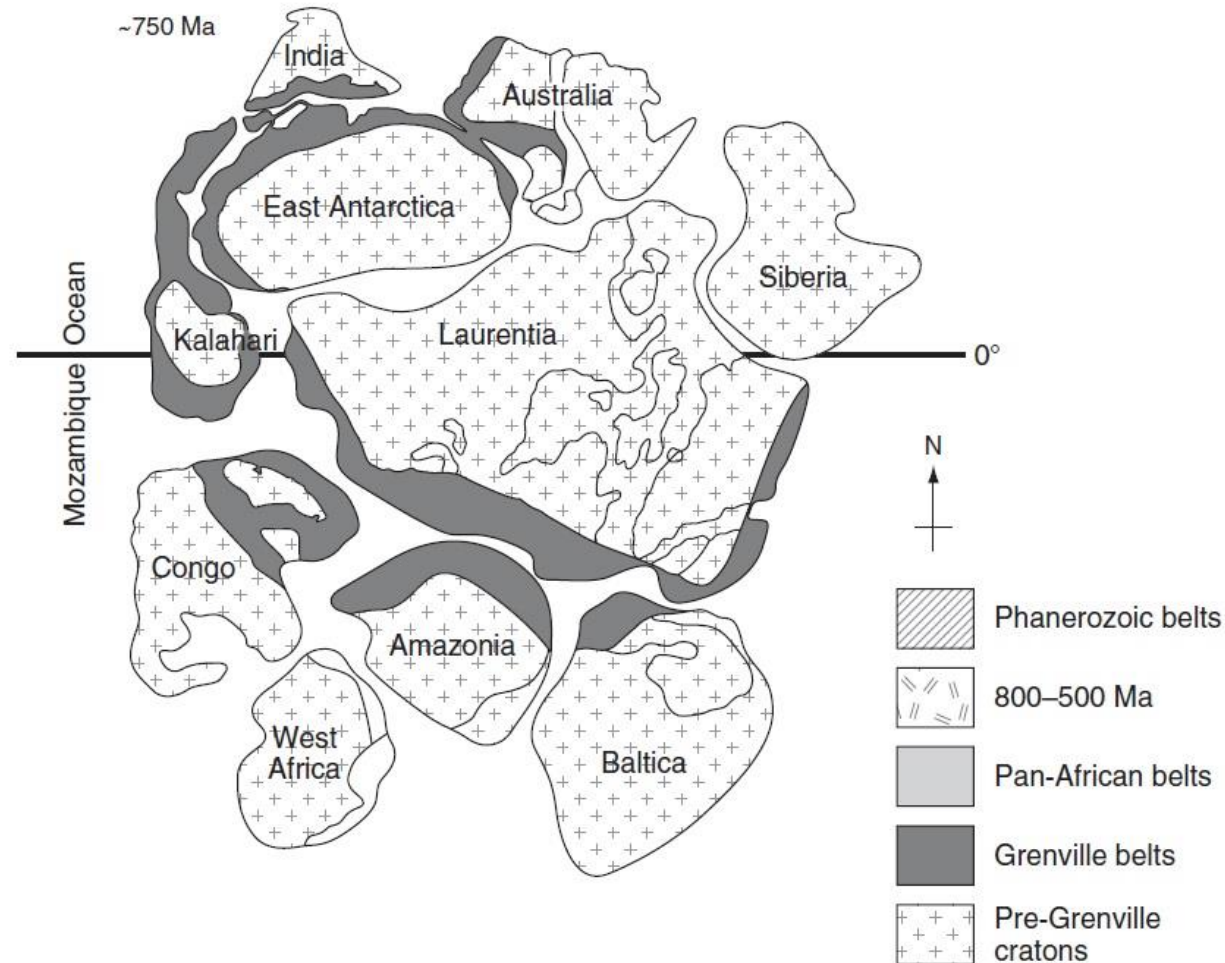
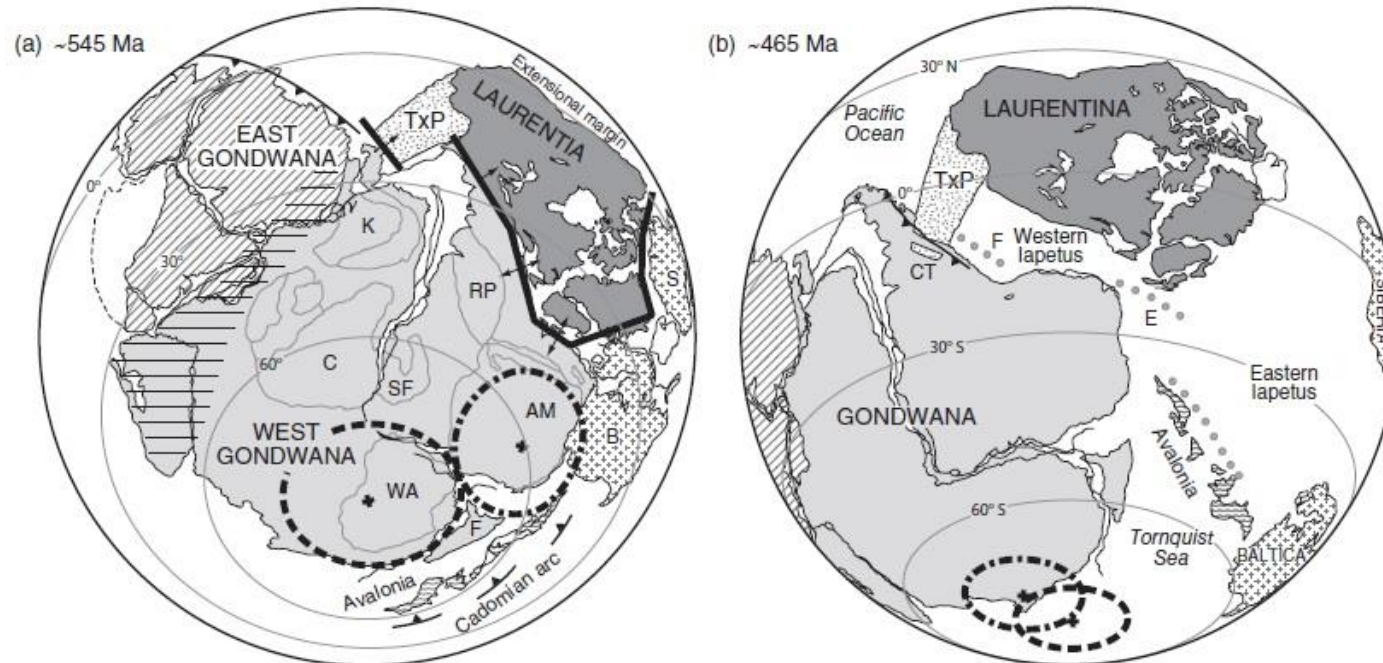

Plate tectonics during the geological time

- West Gondwana formed when many small ocean basins that surrounded the African and South American cratons closed during the opening of the proto-Pacific Ocean, creating the Pan-African orogens.
- Subsequent closure of the Mozambique Ocean resulted in the collision and amalgamation of West Gondwana with the blocks of East Gondwana, which created a short-lived Early Cambrian supercontinent called *Pannotia*.
- The break-up of Pannotia began with the latest Proterozoic or Early Cambrian opening of the Iapetus Ocean as Laurentia rifted away from South America and Baltica.
- Subduction zones subsequently formed along the Gondwana and Laurentia margins of Iapetus, creating a series of volcanic arcs, extensional backarc basins, and rifted continental fragments. As the ocean closed this complex assemblage of terranes accreted onto the margins of both Laurentia and Gondwana.



Gondwana–Pangea assembly and dispersal

Plate tectonics during the geological time

Late Proterozoic Supercontinent Rodinia

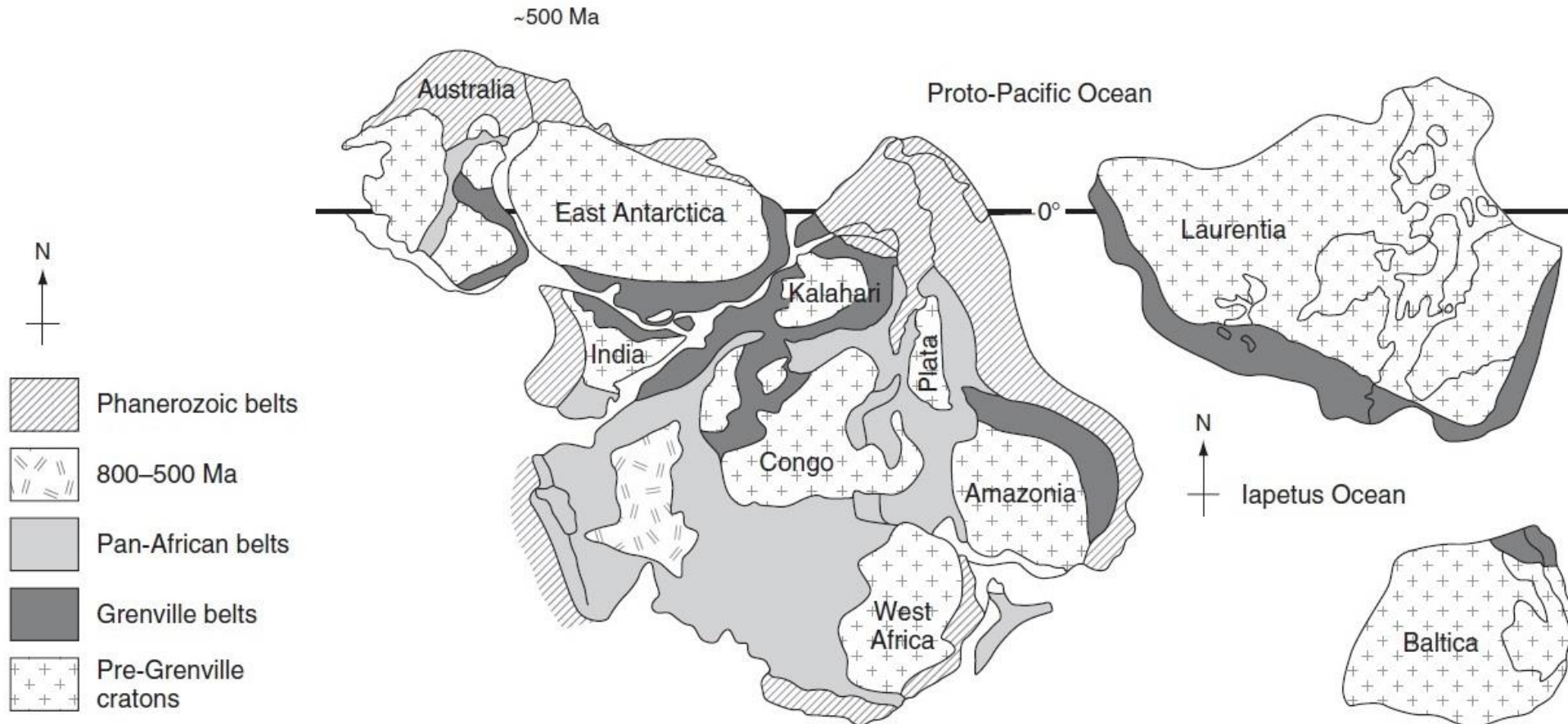

- Gondwana rotated clockwise away from Laurentia about 500 Myr ago and Baltica moved independently away from Laurentia, opening the Iapetus Ocean, which subsequently closed during the assembly of Pangea.

Plate tectonics during the geological time

(a)



~490 Ma

Subduction zone Transform and spreading center

(b)

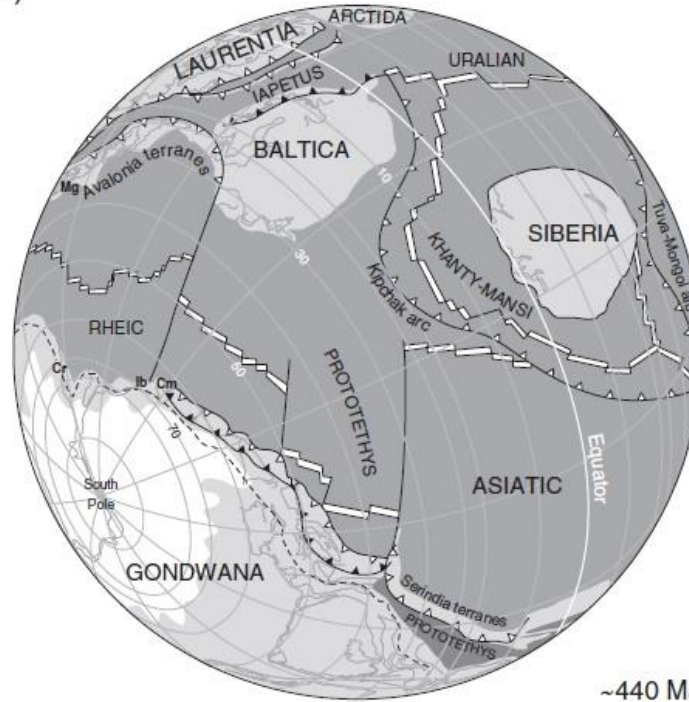

~440 Ma

Subduction zone Transform and spreading center Suture zone

(c)

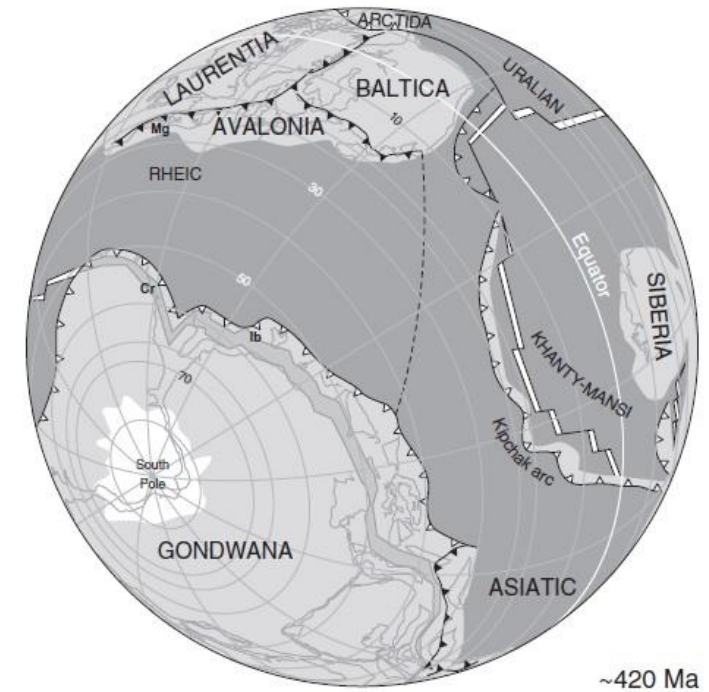

~420 Ma

Subduction zone Transform and spreading center Suture zone

- The rifting of the Avalonia terranes from Gondwana in the Late Cambrian and Early Ordovician led to the opening of the Rheic Ocean between the Gondwana mainland and the offshore crustal fragments (a and b).
- After the closure of Iapetus and the accretion of Avalonia, the Rheic Ocean continued to exist between Laurentia and Gondwana (c).

Plate tectonics during the geological time

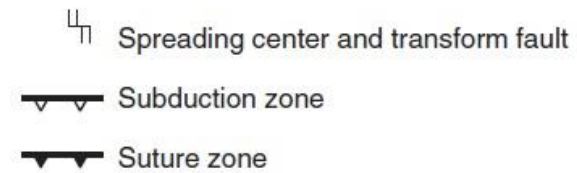
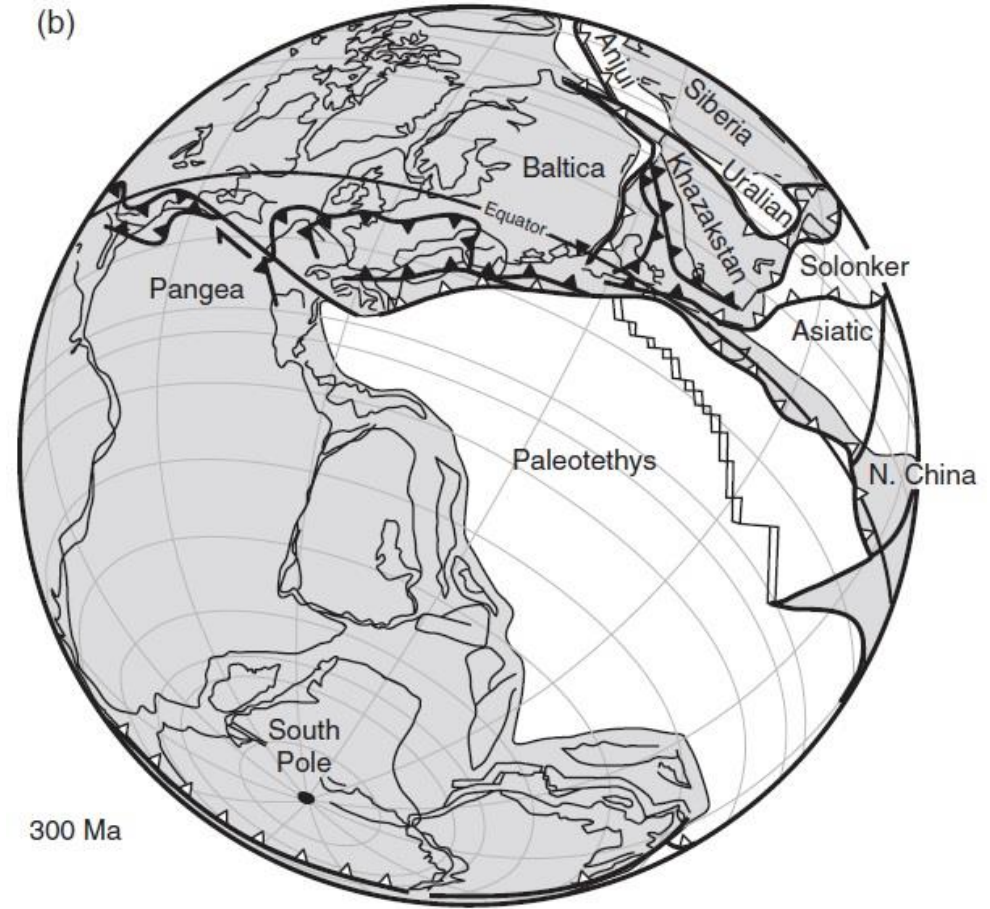
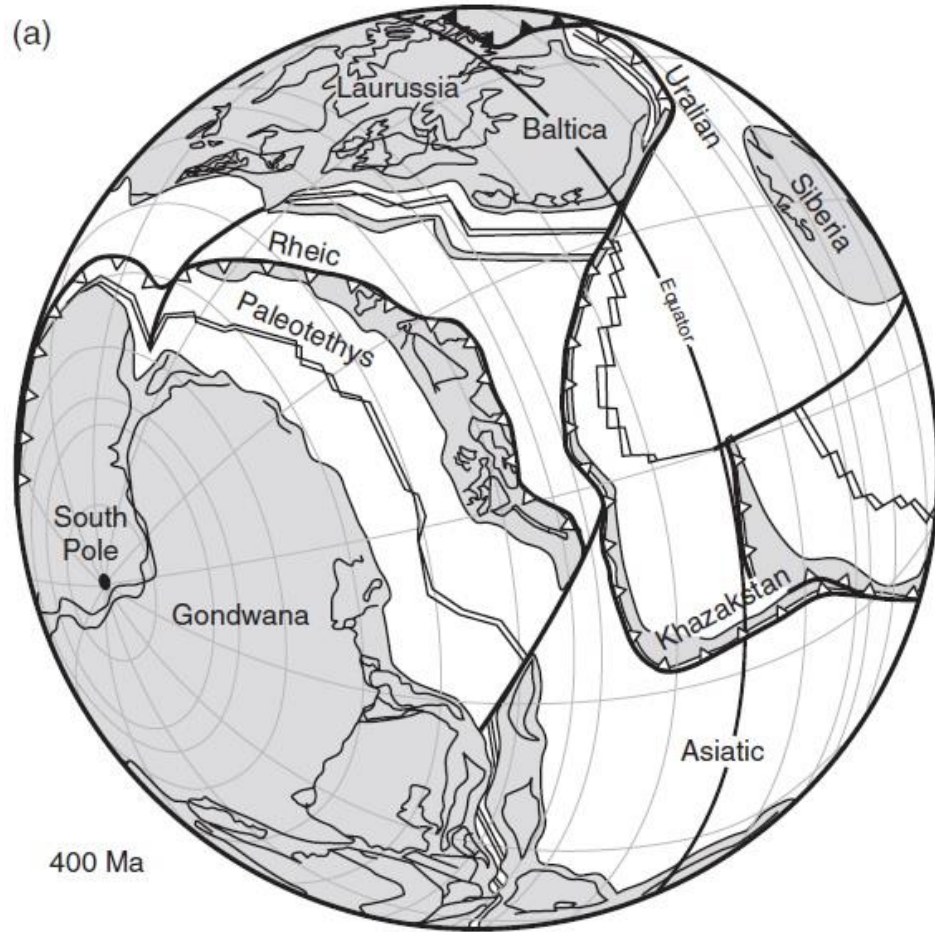

- A new series of arc terranes rifted from the Gondwana margin, resulting in the opening of the Paleotethys Ocean (a).
- The opening of Paleotethys and the closure of the Rheic Ocean resulted in the accretion of these Gondwana-derived terranes onto Laurentia followed by a continent–continent collision between Laurentia and Gondwana (b).

Plate tectonics during the geological time

Pangea

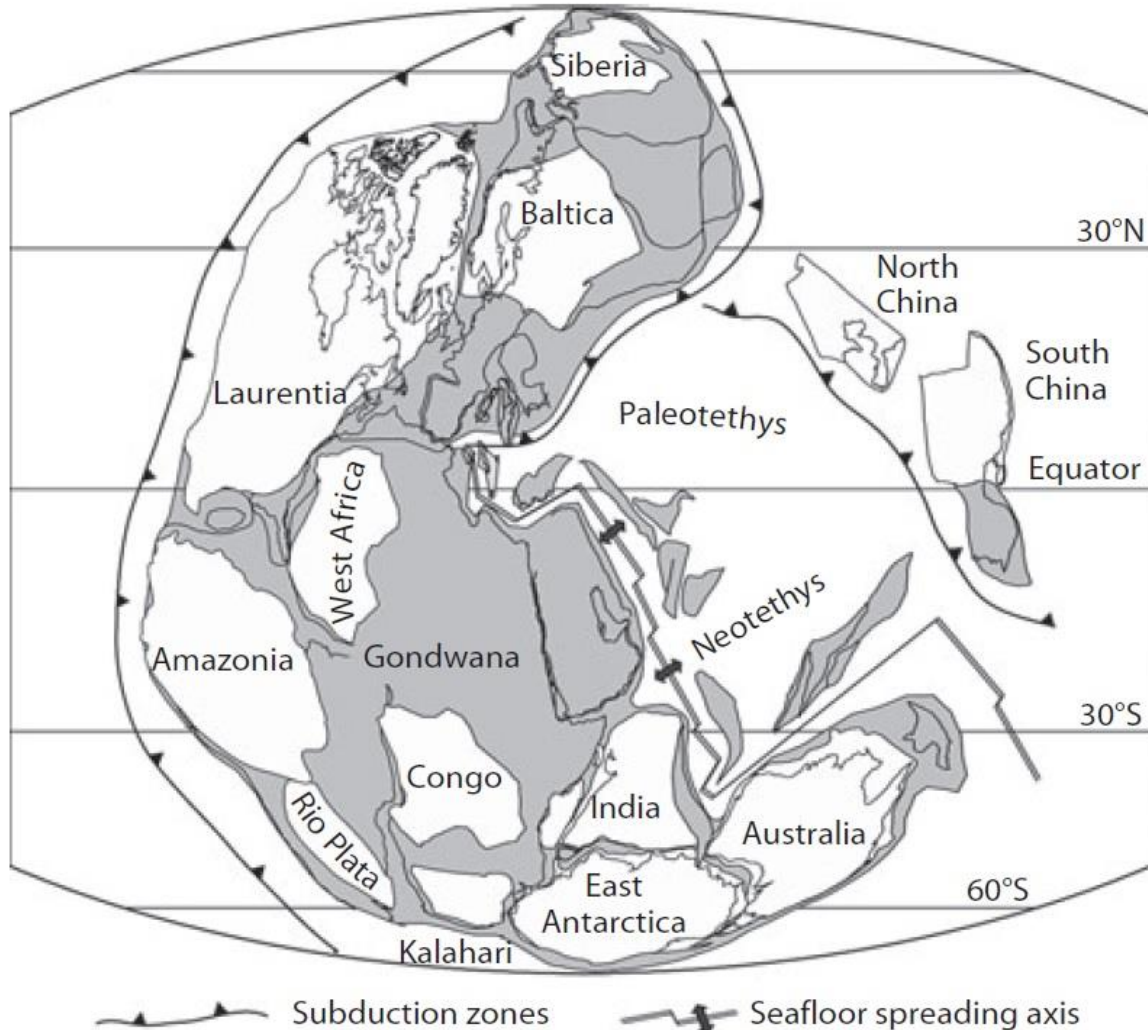

- The latter collision produced the Permo-Carboniferous Alleghenian and Variscan orogenies in North America, Africa, and southwest Europe.
- Collisions in Asia, including the suturing of Baltica and Siberia to form the Ural Orogen at ~280 Myr, resulted in the final assembly of Pangea.
- Break-up of Pangea occurred during the interval 150–95 Myr: it began in the mid-Jurassic with the rifting of Lhasa and West Burma from Gondwana and the opening of the central Atlantic shortly after 180 Myr.
- Rifting between North America and Europe began during the interval 140–120 Myr. Africa and Antarctica began to separate by 150 Myr. Australia began to rift from Antarctic by 95 Myr with India separating from Antarctica at about the same time.
- The break-up of Pangea was accompanied by the closure of oceans, such as Paleotethys and Neotethys, and by collisions, including those that occur presently in southern Asia, southern Europe, and Indonesia.

Wilson Cycle

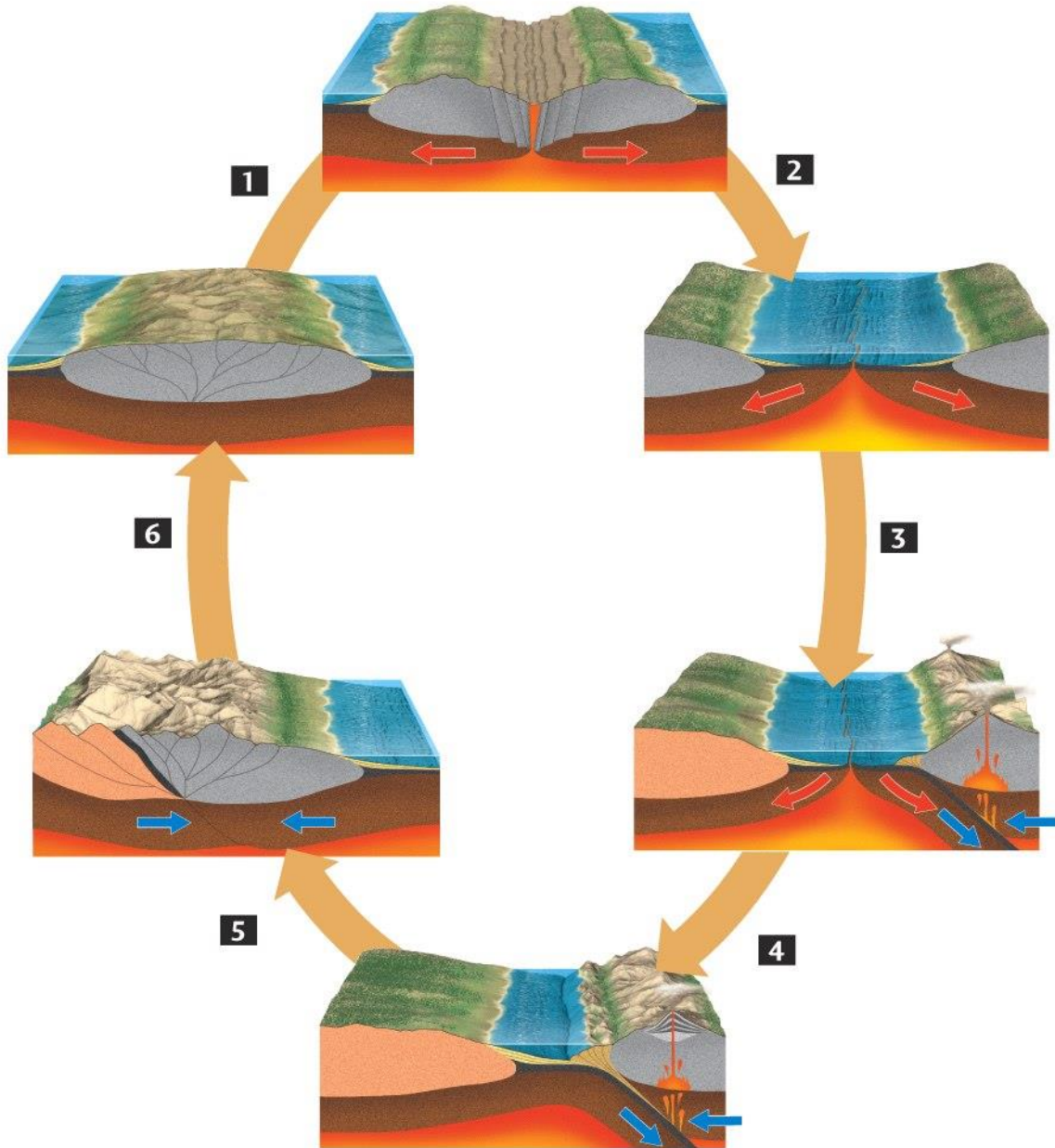

- During periods of dispersal, the continents tend to aggregate over cold downwellings in the mantle, where they act as an insulating blanket (3-6).
- The mantle consequently heats up, altering the convection pattern, and the supercontinent rifts apart in response to the resulting tension (1-2).
- The continental fragments move toward the new cold downwellings resulting from the changed convective regime.

Intra-plate stresses

Dynamical processes and forces operating at plate boundaries generate large scale stress fields in plate interiors

Lithospheric stress field is estimated through different methods:

(1) Earthquake focal plane mechanisms (Depth: 5-20 km), (2) young geologic data on fault slip and volcanic alignments (1-2 km), (3) *in situ* stress measurements (1-2 km), and wellbore breakout and drilling induced fracture data (1-5 km).

World Stress Map Database

Stress at depth can be described by three principal stresses ($S_1 > S_2 > S_3$) lying in horizontal and vertical planes.

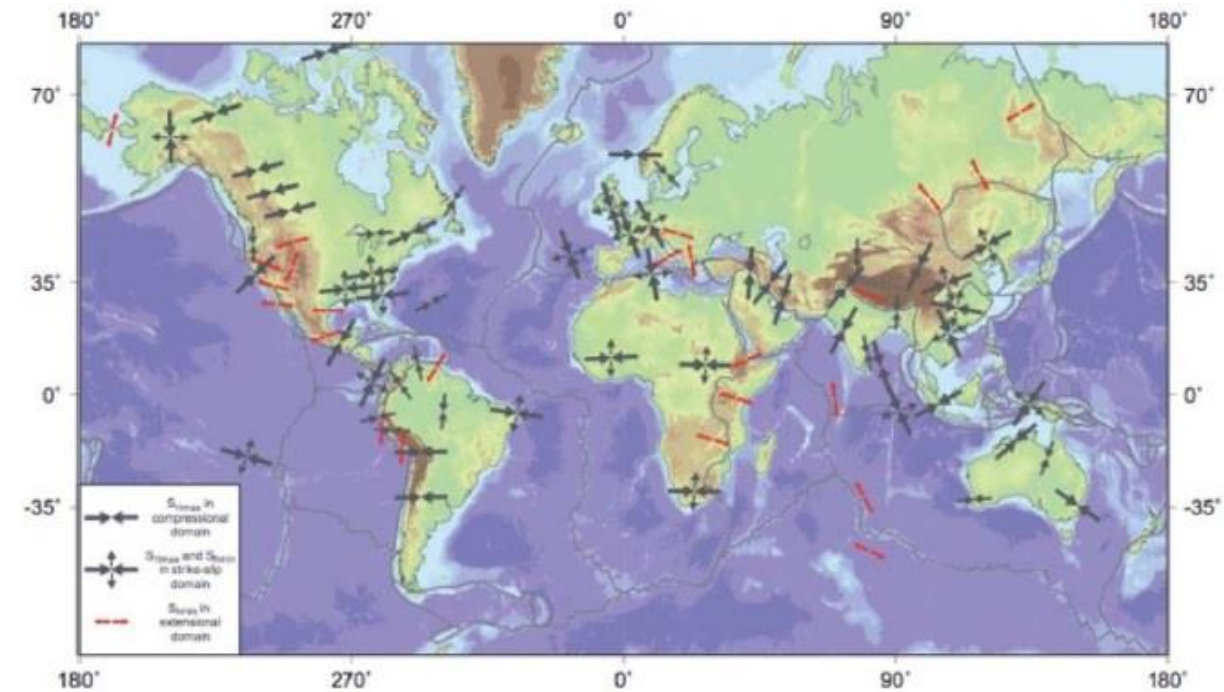
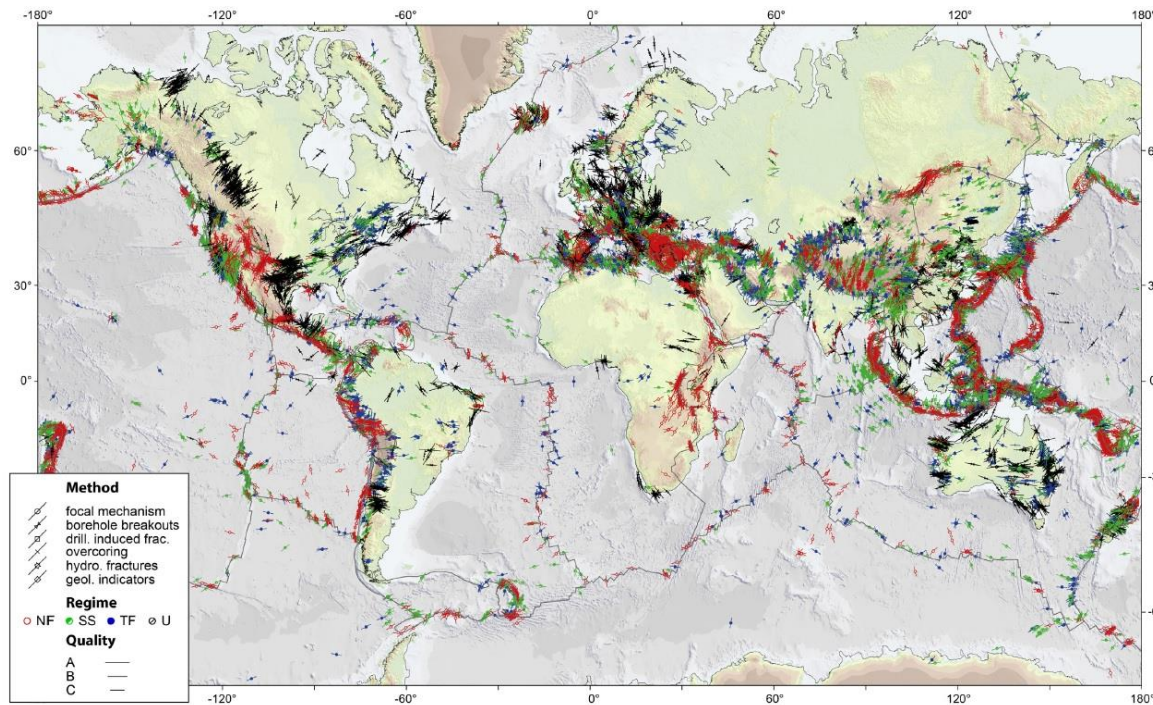

- **Normal Faults:** When the vertical stress dominates ($S_1=S_v$). $S_v > S_{Hmax} > S_{Hmin}$
- **Thrust Faults:** When both horizontal stresses exceed the vertical stress ($S_3=S_v$). $S_{Hmax} > S_{Hmin} > S_v$
- **Strike Slip:** When the difference between the two horizontal stresses (horizontal shear) dominates deformation ($S_2=S_v$). $S_{Hmax} > S_v > S_{Hmin}$
- **Unknown**

Intra-plate stresses

- The inner parts of the plates are dominated by compression (thrust and strike-slip stress regimes) in which the maximum principal stress is horizontal.
- Active extensional tectonism in which the maximum principal stress is vertical, generally occurs in topographically high continental and oceanic areas.
- Regional consistency of both stress orientations and relative magnitudes permits the definition of broad-scale regional stress provinces, many of which coincide with tectonic provinces, having lateral dimensions of $\sim 10^3$ – 10^4 km \gg lithospheric thickness (100–300 km).
- The lithospheric stress field is the result of present-day active tectonics and most of the stress is carried in its strong uppermost brittle layer, since, to first order, stress field is uniform with depth (throughout brittle crust) and over broad regions (despite changes in crustal geology/history).

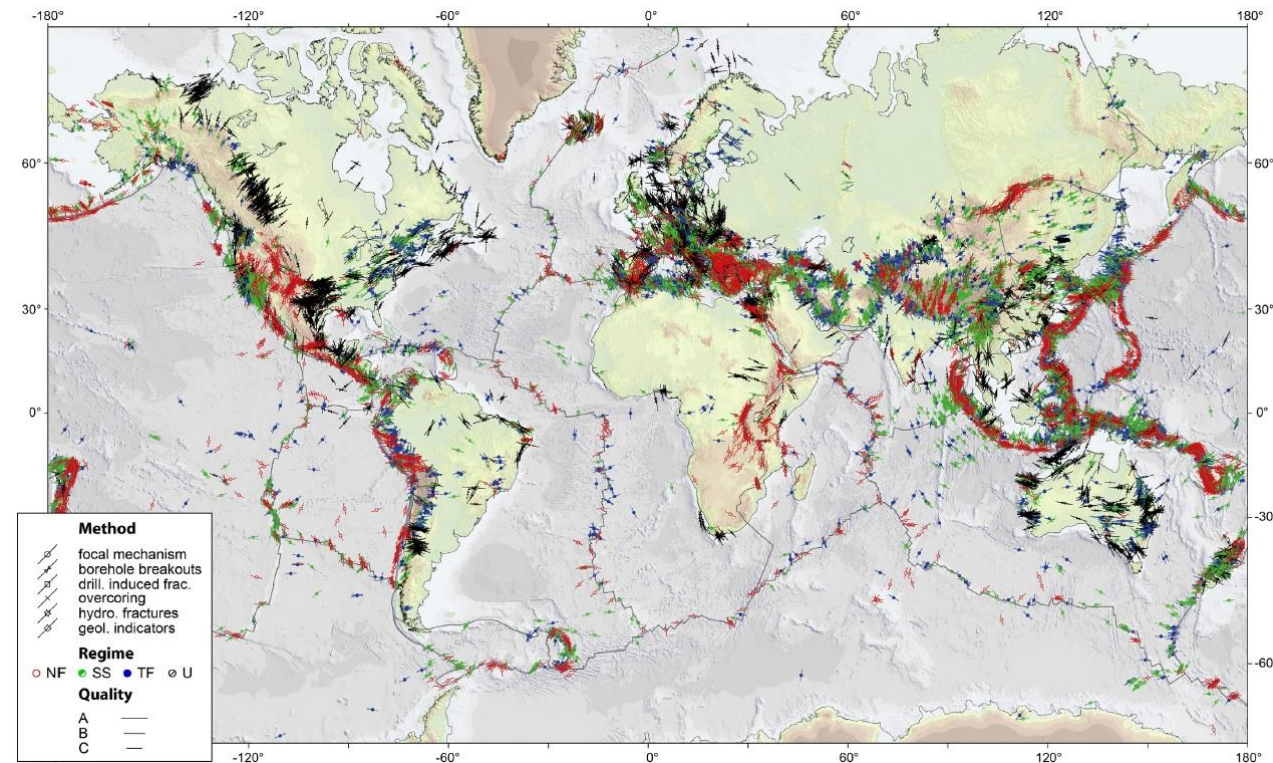

Intra-plate stresses

First-order stress pattern ($\lambda \sim 5000$ km): plate boundary forces.

Second-order stress pattern ($\lambda \sim 500$ km): lithospheric flexure and intraplate lateral density contrasts, such as continental rifting, isostatic compensation, topography, and deglaciation.

Third-order stress pattern ($\lambda < 100$ km): local density and strength contrasts, basal detachment, basin geometry, topography and active faulting.

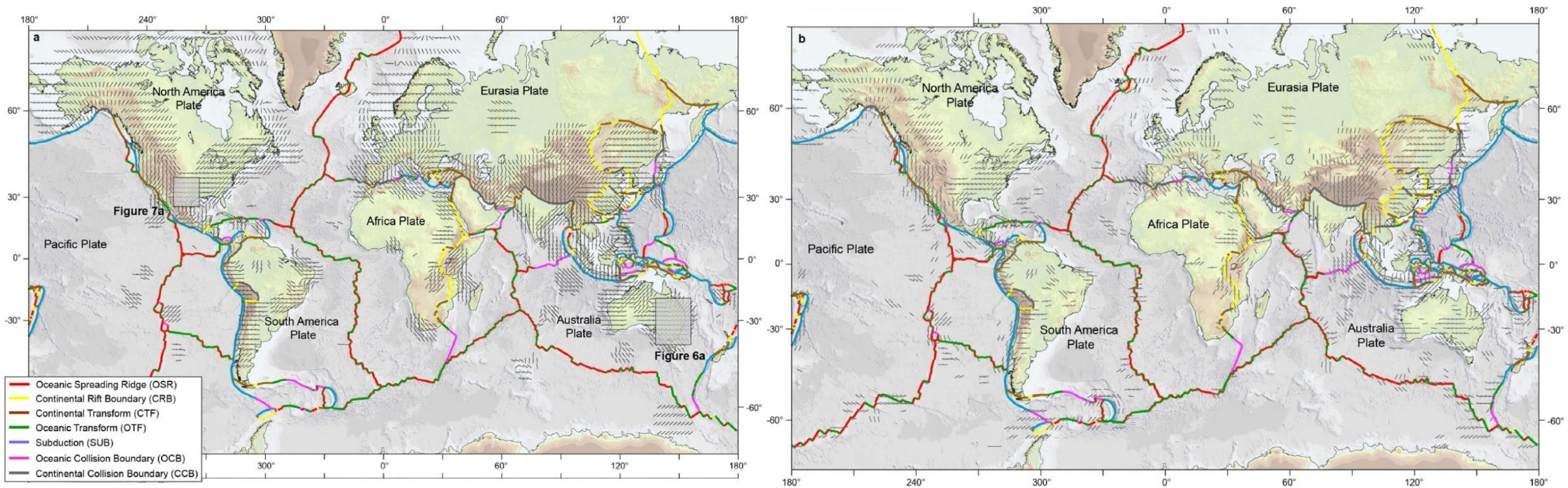

Heidbach et al., 2018, Tectonophysics, 744

a) Smoothed global intra-plate stress maps with a fixed search radius of 500 km and b) variable search radii (starts with 1000 km and is decreased in 100 km steps down to 100 km).

Intra-plate stresses

Comparison between Gravitational Potential Energy and Intraplate Stress

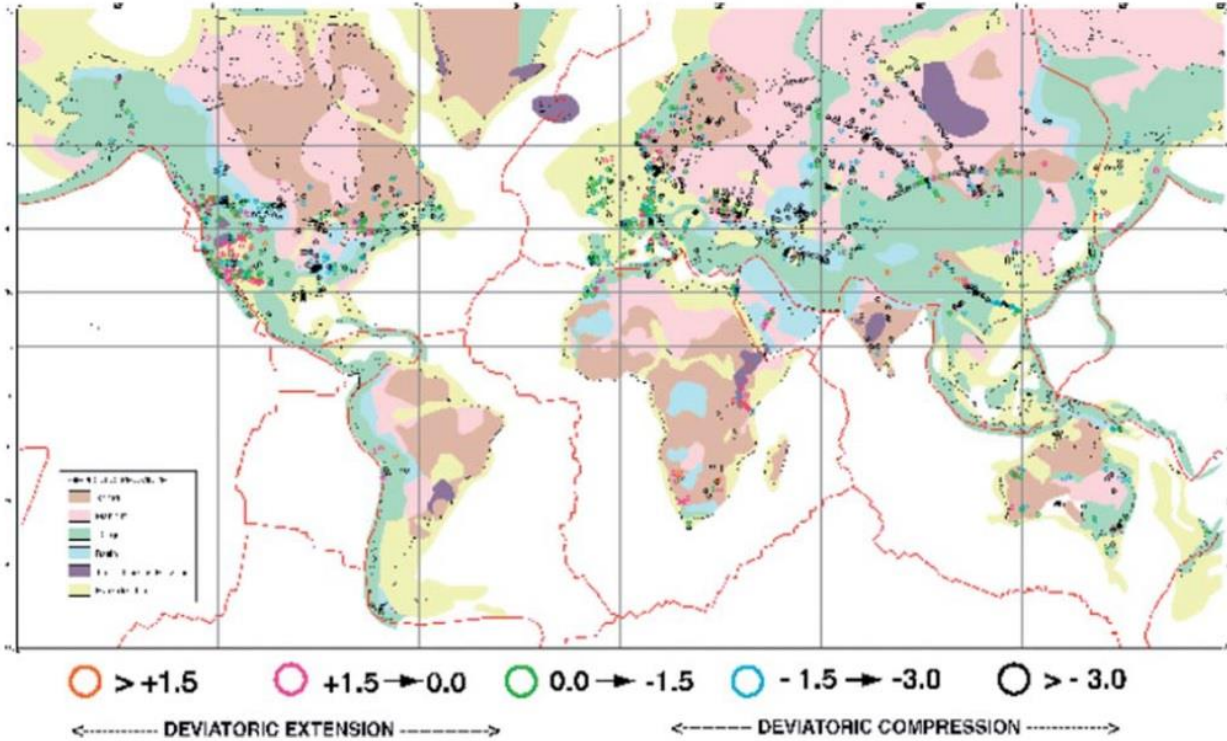

Gravitational potential energy differences relative to midocean ridges by taking a vertical integral over the computed lithosphere density structure.

- Thick mantle roots beneath shields lead to strong negative potential energy differences relative to surrounding regions, resulting in additional compressive stresses superimposed on the intraplate stresses.
- Areas of high elevation and a thin mantle lid (e.g., western US Basin and Range, East African Rift, and Baikal Rift) are predicted to be in extension, consistent with the observed stress regime.

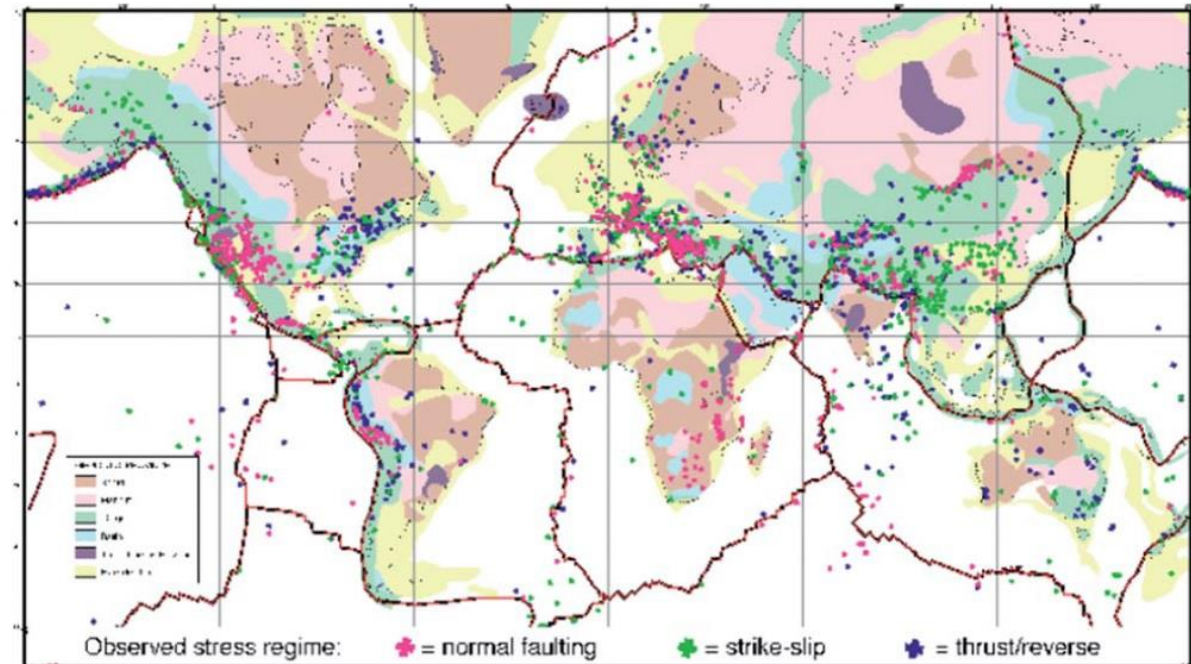

Observed stress regime from World Stress Map Database

References

Main Readings

Books:

- Kearey, Klepeis, and Vine, 2015, The framework of plate tectonics (Chapter 5), Global Tectonics.
- Kearey, Klepeis, and Vine, 2015, Continental drift (Chapter 3), Global Tectonics.
- Kearey, Klepeis, and Vine, 2015, Precambrian tectonics and the supercontinent cycle (Chapter 11), Global Tectonics.
- Kearey, Klepeis, and Vine, 2015, The mechanism of plate tectonics, (Chapter 12), Global Tectonics.
- Stuwe, 2007, Mechanics: Force and Rheology (Chapter 5), Geodynamics of the Lithosphere, Springer.
- Frisch, Meschede, Blakey, 2011, Contractual theory, continental drift and plate tectonics (Chapter 1), Plate Tectonics, Springer.
- Frisch, Meschede, Blakey, 2011, Plate movements and their geometric relationships (Chapter 2), Plate Tectonics, Springer.
- Zoback and Zoback, 2009, Lithosphere Stress and Deformation, Treatise of Geophysics, vol 6.
- Davies, 1999, Plates (Chapter 9), Dynamic Earth, Cambridge and University Press.

Articles:

- Schellart and Rawlinson, 2010, Convergent plate margin dynamics: New perspectives from structural geology, geophysics and geodynamic modelling, Tectonophysics, 483, 4–19.

Further Readings:

- Heidbach et al., 2018, The World Stress Map database release 2016: Crustal stress pattern across scales, Tectonophysics, 484-498.
- Warners-Ruckstuhl et al., 2012, Lithosphere–mantle coupling and the dynamics of the Eurasian Plate, Geophys. J. Int., 189, 1253–1276.
- Ito and van Keken, 2007, Hot Spots and Melting Anomalies, Treatise of Geophysics, vol. 7, 371-435.