

# Asymmetric Organic Catalysis with Modified Cinchona Alkaloids

SHI-KAI TIAN, YONGGANG CHEN,  
JIANFENG HANG, LIANG TANG,  
PAUL MCDAID, AND LI DENG\*

*Department of Chemistry, Brandeis University,  
Waltham, Massachusetts 02454*

Received December 10, 2003

## ABSTRACT

Insights into the role played by modified cinchona alkaloids in the Sharpless asymmetric dihydroxylation inspired studies of modified cinchona alkaloids as chiral organic catalysts that lead to the development of highly enantioselective alcoholyses for the desymmetrization, kinetic resolution, and dynamic kinetic resolution of cyclic anhydrides, cyanation of ketones, and 1,4-addition of thiols to cyclic enones. These studies demonstrate the potential of modified cinchona alkaloids as broadly useful chiral organic catalysts for asymmetric synthesis.

## I. Introduction

The reaction between a nucleophile and an electrophile is one of the most fundamental mechanisms underlying an extremely broad range of reactions in organic synthesis. Consequently, the development of enantioselective nucleophile–electrophile reactions is a major focus of catalytic asymmetric synthesis. Since the electrophile and the nucleophile can be activated by an acid and a base,

Shi-Kai Tian was born in 1970. He obtained his B.S. degree from Lanzhou University and earned both his M.S. and Ph.D. degrees from Shanghai Institute of Organic Chemistry (SIOC) in 1996 and 1998, respectively. In 1999 he joined the Deng group at Brandeis University as a postdoctoral fellow, and since 2002 he has worked at Vertex Pharmaceuticals Inc.

Yonggang Chen was born in 1973. He obtained both his B.S. and M.S. degrees from Lanzhou University. He received his Ph.D. degree from Brandeis University in 2003 with Li Deng. He is currently a postdoctoral fellow of the American Heart Association with Professor Jacobsen at Harvard.

Jianfeng Hang was born in China. He received his B.S. degree from Beijing Normal University and M.S. degree from SIOC. Since 1999 he has been pursuing his Ph.D. degree in Chemistry at Brandeis University under the guidance of Professor Deng.

Liang Tang was born in 1974. He obtained his B.S. degree at the University of Science and Technology of China in 1995. Then he moved to SIOC and received his M.S. degree in 1998. Currently, he is a Ph.D. candidate in Professor Deng's group at Brandeis University.

Paul McDaid was born in 1975. He obtained his B.S. degree from University College Dublin in 1997. Since 1998, he has been working as a graduate student under the direction of Professor Deng at Brandeis University.

Li Deng received his B.S. degree from Tsinghua University, China, M.S. degree with Professor Cook from University of Wisconsin-Milwaukee, and Ph.D. degree with Professor Jacobsen from Harvard University. After an American Cancer Society postdoctoral fellowship with Professors Verdine and Whitesides at Harvard University, he joined the faculty at Brandeis University in 1998, where he is currently an Associate Professor.

respectively, either a chiral acid or a chiral base can, in principle, promote an enantioselective nucleophile–electrophile reaction. When we started our research program in 1998, chiral Lewis acids containing a catalytic metal center were the most extensively explored and most successful catalysts for enantioselective nucleophile–electrophile reactions. The combination of a wide range of Lewis-acidic metals and numerous chiral ligands provides a very resourceful approach for the discovery, development, and optimization of a catalytic asymmetric reaction. Numerous highly enantioselective reactions have been, and will continue to be, successfully developed via the chiral Lewis-acid approach.<sup>1</sup> On the other hand, chiral Lewis-base/nucleophilic catalysts were clearly an underexplored class of catalysts. Importantly, Fu<sup>2</sup> and Oriyama<sup>3</sup> reported promising results in the enantioselective acylation of racemic and meso alcohols by chiral amine catalysts. Denmark<sup>4</sup> described the use of chiral phosphoramides to achieve synthetically useful enantioselectivity for asymmetric aldol reactions.

Despite these exciting advances, it was uncertain whether studies of chiral Lewis-base/nucleophilic catalysts constituted a broadly applicable approach for the development of new and useful asymmetric catalysis. However, certain properties of chiral Lewis-bases make them particularly attractive catalysts for asymmetric reactions. Considering the Lewis-basic nature of most organic functionalities, one can argue that chiral Lewis-base catalysts should possess excellent functional-group tolerance. Moreover, organic chiral Lewis bases, such as chiral amines, can often be easily separated from most organic compounds and subsequently recovered through simple extractive procedures. These characteristics of chiral amine catalysts render them especially valuable for the development of practical asymmetric catalysis. While these practical considerations guide our research program in a significant way, we are most interested in the discovery of new catalytic activity and selectivity by exploring the asymmetric Lewis-base/nucleophilic catalysis of chiral amines.

## II. Previous Studies of Asymmetric Catalysis of Cinchona Alkaloids

**Early Studies of Asymmetric Chiral Lewis-Base/Nucleophilic Catalysis of Cinchona Alkaloids.** Cinchona alkaloids are abundant natural products that exist as pseudoenantiomeric pairs, as exemplified by quinine and quinidine. They are readily accessible amine catalysts that could be used to generate either enantiomer of a chiral product of interest. Accordingly, numerous efforts have been devoted to the development of cinchona alkaloid-catalyzed enantioselective reactions.<sup>5</sup> Early studies of the asymmetric catalysis of cinchona alkaloids, carried out at a time when a metal-catalyzed asymmetric reaction was still largely an alien concept to most organic chemists,

\* To whom correspondence should be addressed. Phone: 781-736-2529. Fax: 781-736-2516. E-mail: deng@brandeis.edu.

naturally concentrated on Lewis-base/nucleophilic organic catalysis. In 1960 Pracejus reported that methyl phenyl ketene was converted to (*S*)-methyl hydratropate in 74% ee using *O*-acetylquinine as a catalyst.<sup>6</sup> This is one of the earliest examples of a catalytic asymmetric nucleophile–electrophile reaction. Wynberg and co-workers carried out extensive studies of the use of cinchona alkaloids as chiral Lewis-base/nucleophilic catalysts.<sup>7</sup> Cinchona alkaloids were shown to be versatile catalysts, promoting a variety of 1,2- and 1,4-additions of a wide range of nucleophiles to carbonyl compounds. However, synthetically useful enantioselectivity was only obtained in the reaction of ketenes with chloral to form chiral oxetan-2-ones.<sup>8</sup> Enantioselectivities were unsatisfactory for numerous other reactions.<sup>7</sup>

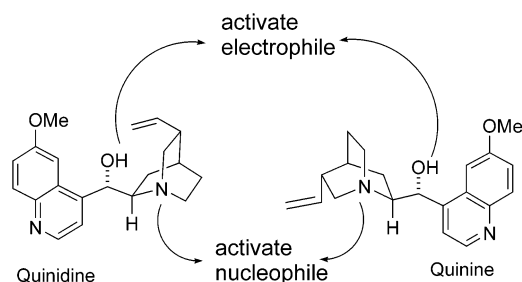

In those early studies it was often observed that natural cinchona alkaloids were superior, in terms of both catalytic activity and selectivity, to modified cinchona alkaloids derived from modification of the C-9 hydroxyl group. To rationalize this phenomenon, Wynberg proposed that the natural cinchona alkaloids are bifunctional catalysts utilizing both the tertiary amine and the hydroxyl group to activate and orient the nucleophile and electrophile, respectively, thus achieving optimum asymmetric catalysis.<sup>7</sup> Despite the versatile Lewis-base/nucleophilic catalysis of cinchona alkaloids and the obvious practical advantages of efficient cinchona alkaloid-catalyzed enantioselective reactions, the development of such reactions proved extremely difficult. This was summarized by Kagan in his “Historical Perspective” of asymmetric catalysis: There are many attempts to modify well-established base-catalyzed reactions, mostly with limited success.<sup>9</sup>

**Modified Cinchona Alkaloids and Their Applications in Asymmetric Transition-Metal Catalysis.** While little progress was made after Wynberg’s early studies of chiral Lewis-base/nucleophilic catalysis by cinchona alkaloids, spectacular developments in cinchona alkaloid-based transition-metal catalysts led to the emergence of one of the most powerful catalytic asymmetric reactions, the Sharpless asymmetric dihydroxylation (AD) of simple olefins.<sup>10</sup> The use of aryl ethers of mono- and biscalcinona alkaloids (**2–6**) as chiral ligands was critical to the dramatic expansion of the scope of the Sharpless AD. Extensive mechanistic and structural studies were carried out by the Sharpless and Corey groups.<sup>11</sup> Corey demonstrated very similar enantioselectivity profiles for biscalcinona alkaloid **7** and its rigid analogue **8** for a wide range of olefins, indicating that the extraordinarily reliable and high enantioselectivity of the Sharpless AD could be

attributed to the ability of modified cinchona alkaloids to form a rigid, enzyme-like pocket around the metal (Os) center upon binding of the nitrogen of the quinuclidine unit to the metal center.<sup>12</sup>

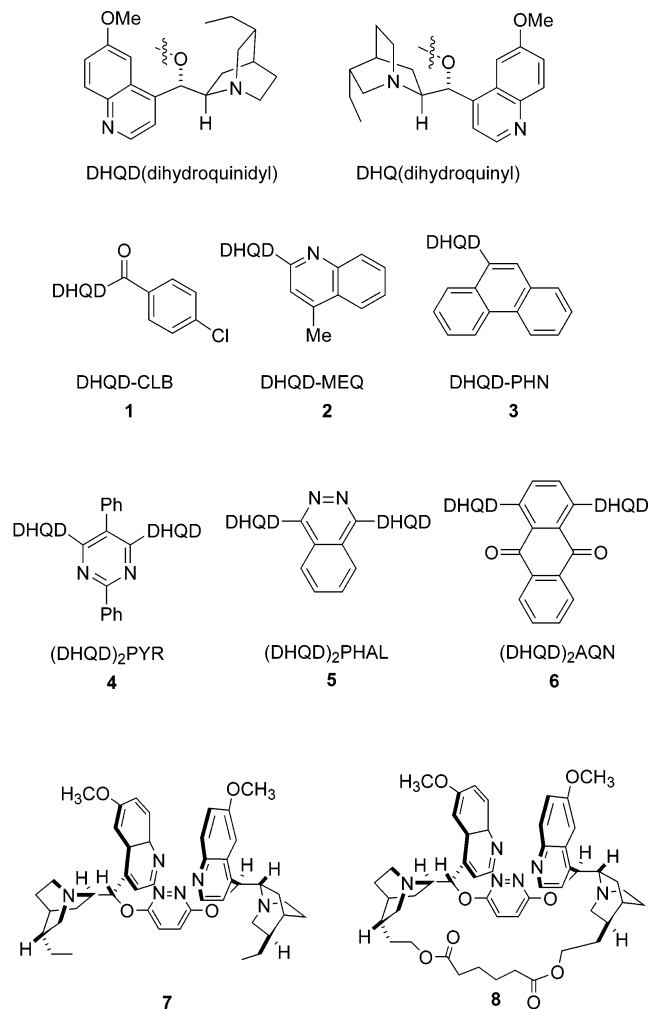

We hypothesized that these modified cinchona alkaloids, upon interaction with either a nucleophile (chiral Lewis-base catalysis) or an electrophile (nucleophilic catalysis) through the nitrogen of the quinuclidine unit, might also be able to form a rigid enzyme-like pocket around the activated nucleophile or electrophile, thereby allowing them to function as efficient chiral Lewis-base or nucleophilic organic catalysts. Furthermore, modified cinchona alkaloids (**1–6**) are commercially available, and consequently, enantioselective reactions which are efficiently catalyzed by them will be very useful methods for asymmetric synthesis. Following these considerations, we embarked on an investigation of the asymmetric Lewis-base/nucleophilic catalysis of modified cinchona alkaloids.

### III. Development of New Catalytic Asymmetric Reactions with Readily Accessible Modified Cinchona Alkaloids

**Desymmetrization of Meso and Prochiral Cyclic Anhydrides.** Initially, when selecting a specific reaction to test the aforementioned hypothesis, we were most interested

in a transformation involving simple reagents that could convert readily accessible achiral starting materials into valuable chiral building blocks. Such a value-added reaction that had not yet been accomplished with efficient catalytic control would be ideal for our investigation. Utilizing a solvent-cheap reagent to convert a class of readily accessible achiral compounds to widely useful chiral hemiesters, the desymmetrization of meso cyclic anhydrides with alcohols fits these criteria almost perfectly.<sup>13</sup>

Particularly relevant to our studies is the cinchona alkaloid-catalyzed alcoholysis of meso anhydrides first reported by Oda in 1985.<sup>14</sup> Remarkably, Oda obtained excellent yields using a base catalyst to mediate a reaction producing an acidic product, the hemiester. The enantioselectivity of the reaction is moderate when mediated by a catalytic amount (0.1 equiv) of natural cinchona alkaloids or their C9-epimers. Aitken showed that the enantioselectivity could be improved by increasing the catalyst loading.<sup>15</sup> Later, Bolm reported that excellent enantioselectivity could be attained for a wide variety of meso succinic anhydrides with a stoichiometric amount of quinidine or quinine at  $-50\text{ }^{\circ}\text{C}$ .<sup>16</sup> Inspired and guided by these studies, we began to examine the ability of the commercially available modified cinchona alkaloids to catalyze the enantioselective alcoholysis of meso cyclic anhydrides. Surprisingly, these modified cinchona alkaloids, although commercially available for several years prior to our studies, had never been reported to function as chiral Lewis-base/nucleophilic organic catalysts.

Initial screening studies with anhydride **9h** as the model substrate led us to the discovery that (DHQD)<sub>2</sub>AQN and DHQD-PHN were able to catalyze highly enantioselective alcoholysis of a broad range of succinic and glutaric anhydrides (Scheme 1).<sup>17</sup> However, attempts to improve the unsatisfactory ee obtained with 2,4-dimethyl glutaric anhydride were unsuccessful. The high enantioselectivities obtained for the desymmetrization of both the bulky and highly functionalized Goldberg–Sternbach anhydride (**9c**) and the prochiral 3-substituted glutaric anhydrides (**9i–j**) are noteworthy as they had eluded previous efforts utilizing even stoichiometric amounts of chiral reagents.<sup>18</sup>

The modified cinchona alkaloid-catalyzed alcoholysis is often so clean that isolation of the enantiomerically enriched hemiester and recovery of the catalyst can be accomplished in virtually quantitative fashion via a simple extractive procedure. More importantly, our studies revealed that commercially available modified cinchona alkaloids such as (DHQD)<sub>2</sub>AQN are able to function as effective chiral Lewis-base/nucleophilic organic catalysts.

#### Kinetic Resolution of Racemic Cyclic Anhydrides.

Analysis of the absolute configuration of most of the hemiesters indicated that the stereochemical outcome of the desymmetrization is consistent with the projection described in Figure 1. The modified cinchona alkaloid-catalyzed alcoholysis is remarkably tolerant of variation of the substituents on the succinic and glutaric anhydrides. This suggested that it might also tolerate other

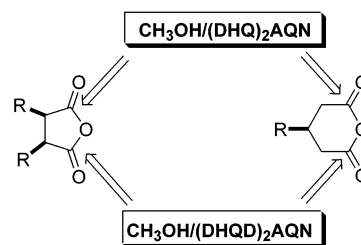
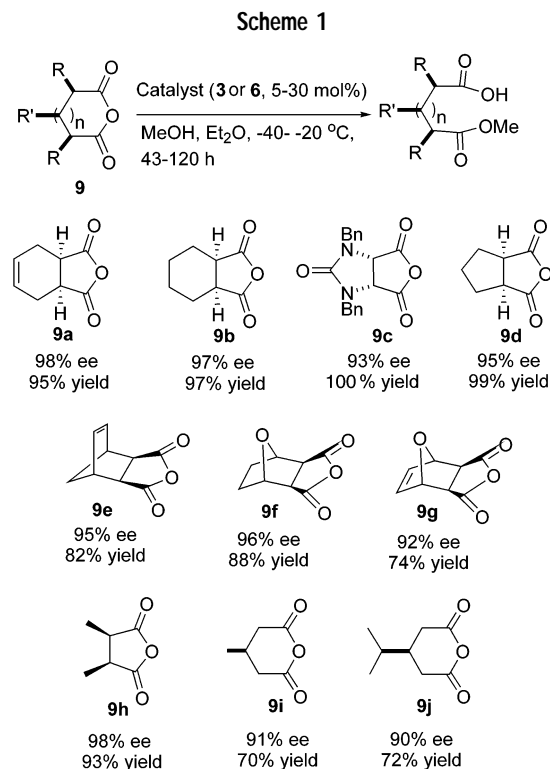

FIGURE 1. Stereochemical projection for desymmetrization of prochiral and meso cyclic anhydrides.

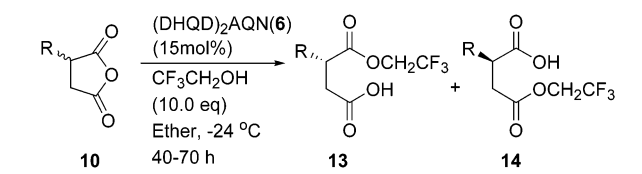

**Table 1**

entry	ROH	temp ( $^{\circ}\text{C}$ )	conv (%)	<b>11/12</b>	% ee	
					<b>11</b>	<b>12</b>
1	MeOH	25	100	39/61	74	67
2	EtOH	25	100	49/51	82	67
3	<i>n</i> -PrOH	25	100	45/55	81	72
4	CF <sub>3</sub> CH <sub>2</sub> OH	25	100	49/51	85	72
5	CF <sub>3</sub> CH <sub>2</sub> OH	-25	100	44/56	91	80

modifications of the cyclic anhydride. An interesting question was what would happen if one of the two substituents of the meso anhydride was removed? To answer this question, (DHQD)<sub>2</sub>AQN-catalyzed methanolysis of racemic 2-methyl succinic anhydride (**10a**) was investigated (Table 1). We found that as racemic **10a** was being consumed, two regioisomers of the hemiesters, **11** and **12**, were being formed at similar and steady rates throughout the reaction process. This phenomenon seemed

Table 2



entry	substrate	% ee		% yield		
		13/14	13	14	13	14
1 <sup>a</sup>	<b>10a</b> : R = Me	44/55	93	80	36	41
2	<b>10b</b> : R = Et	40/60	91	70	38	50
3	<b>10c</b> : R = <i>n</i> -C <sub>8</sub> H <sub>17</sub>	42/56	98	66	38	41
4	<b>10d</b> : R = CH <sub>2</sub> CH=CH <sub>2</sub>	46/53	96	82	40	49

<sup>a</sup> 20 mol % catalyst was used.

Table 3

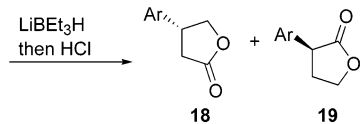
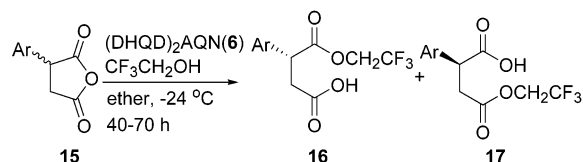

entry	substrate	% ee		% ee (% yield)	
		16	17	18	19
1	<b>15a</b> : Ar = Ph	95	87	95 (44)	82 (32)
2	<b>15b</b> : Ar = 3-MeO-C <sub>6</sub> H <sub>4</sub>	96	83	95 (45)	83 (30)
3	<b>15c</b> : Ar = 4-Cl-C <sub>6</sub> H <sub>4</sub>	96	76	96 (44)	63 (29)

to suggest that the alcoholysis proceeded with low enantioselectivity and regioselectivity. Surprisingly, the ee values of **11** and **12** were found to be 74% and 67%, respectively. Apparently a parallel kinetic resolution (PKR) transformed the two enantiomers of **10a** into optically active **11** and **12**.<sup>19</sup>

Alcoholysis at  $-25\text{ }^{\circ}\text{C}$  with trifluoroethanol produced **11** and **12** in significantly improved ee (Table 1). Importantly, both alkyl and aryl succinic anhydrides were resolved efficiently (Tables 2 and 3).<sup>20</sup> The access to optically active aryl-substituted succinate monoesters (**16** and **17**) is noteworthy as these important chiral building blocks were inaccessible via enantioselective catalytic approaches. In contrast to their alkyl counterparts, **16** and **17** are not separable by normal chromatographic methods. The lactones (**18** and **19**) derived from **16** and **17** can be purified by silica gel chromatography. To our knowledge, these results constitute the first efficient catalytic parallel kinetic resolution (PKR) mediated by a single organic catalyst.

The origin of the PKR is revealed in the respective alcoholysis of the optically pure *R* and *S* enantiomers of anhydride **10a** with (DHQD)<sub>2</sub>AQN and (DHQ)<sub>2</sub>AQN.<sup>20</sup> As summarized in Scheme 2, the alcoholyses of (*R*)- and (*S*)-**10a** proceed with divergent regioselectivity. For a given enantiomer, the regioselectivity is controlled by the chirality of the catalyst. Thus, the PKR arises from two parallel running enantioselective and regioselective alcoholyses of

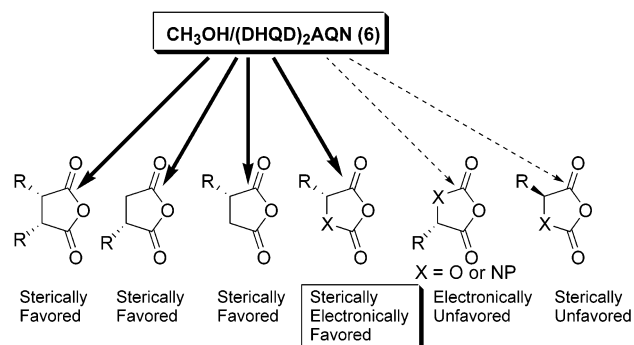
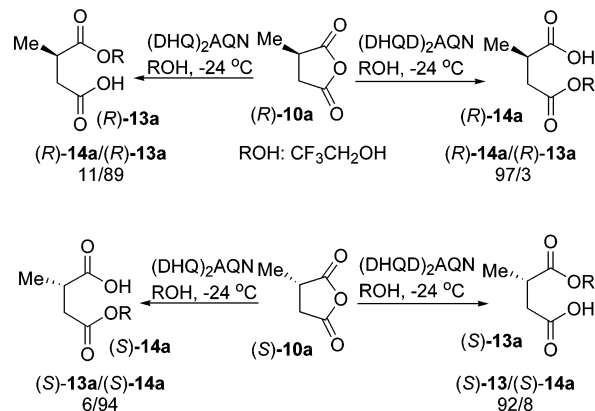

FIGURE 2.

Scheme 2



the two enantiomers of **10a**. The stereochemical outcome of both the desymmetrization and parallel kinetic resolution are consistent with the projection illustrated in Figure 2. These results demonstrate that alteration of the electronic and steric properties of the substituent of the cyclic anhydride or even the removal of one substituent from the meso cyclic anhydride does not change how the modified cinchona alkaloid-catalyzed alcoholysis recognizes the cyclic anhydride. In view of the similarly high enantioselectivity obtained with either an alkyl or aryl substituent, we concluded that this highly efficient yet remarkably resilient chiral recognition of the cyclic anhydride by the modified cinchona alkaloid is due to nonbonding steric interactions.

**Kinetic Resolutions of *N*-Carboxy and *O*-Carboxy Anhydrides.** The lessons learned from the enantioselective alcoholysis of cyclic anhydrides provided us with new insights into the development of new and synthetically important catalytic asymmetric reactions. We envisioned that the modified cinchona alkaloid-catalyzed alcoholysis might be able to differentiate the two enantiomers of *N*-protected-*N*-carboxy anhydrides and *O*-carboxy anhydrides, molecules which, in terms of shape, closely resemble succinic anhydrides. Importantly, efficient kinetic resolutions of *N*-carboxy anhydrides and *O*-carboxy anhydrides could convert readily accessible racemic  $\alpha$ -amino and  $\alpha$ -hydroxy acids (**20** and **24**) into their respective optically active counterparts (Scheme 3).

We first attempted the resolution of urethane-protected  $\alpha$ -amino acid *N*-carboxyanhydrides (UNCAs, **21a–l**).<sup>21</sup> Gratifyingly, the most efficient catalyst for enantioselective



Scheme 3

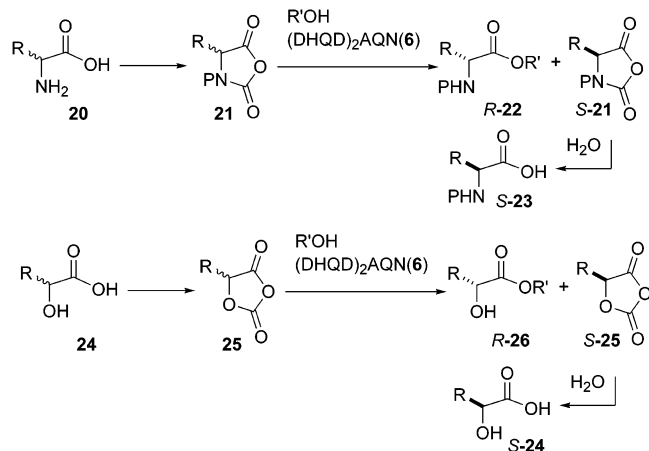

alcoholysis of cyclic anhydrides, (DHQD)<sub>2</sub>AQN, was also found to be highly efficient for the enantioselective alcoholysis of UNCA **21**, resolving a broad range of UNCAs bearing alkyl or aryl substituents with exceedingly high enantioselectivities and excellent yields (Scheme 4).<sup>22</sup> Furthermore, all commonly used carbamate groups are well-tolerated. The purification of the optically active amino esters and acids as well as the quantitative recovery of (DHQD)<sub>2</sub>AQN can be routinely carried out using extractive procedures.

In contrast to the well-established preparation of UNCA from  $\alpha$ -amino acids, only a few examples of modest yield were reported for the preparation of *O*-carboxy anhydrides via a condensation of  $\alpha$ -hydroxy acids (**24**) with diphosgene in refluxing THF.<sup>23</sup> Therefore, a high-yielding procedure for conversion of the  $\alpha$ -hydroxy acids to *O*-carboxy anhydrides **25** had to be established. We observed that condensation of the hydroxyacid with diphosgene proceeded cleanly, but a significant amount of 4-chlorobutyl chloroformate was generated. Also, the *O*-carboxy anhy-

Table 4

entry	R	% yield	entry	R	% yield
1	a C <sub>6</sub> H <sub>5</sub>	100	8	h 1-naphthyl	100
2	b 4-Cl-C <sub>6</sub> H <sub>4</sub>	100	9	i 2-Cl-C <sub>6</sub> H <sub>4</sub>	100
3	c 4-Br-C <sub>6</sub> H <sub>4</sub>	100	10	j 2-Me-C <sub>6</sub> H <sub>4</sub>	95
4	d 4-F-C <sub>6</sub> H <sub>4</sub>	100	11	k C <sub>6</sub> H <sub>5</sub> CH <sub>2</sub>	95
5	e 4-CF <sub>3</sub> -C <sub>6</sub> H <sub>4</sub>	100	12	l C <sub>6</sub> H <sub>5</sub> CH <sub>2</sub> CH <sub>2</sub>	97
6	f 4- <sup>i</sup> Pr-C <sub>6</sub> H <sub>4</sub>	100	13	m CH <sub>3</sub> (CH <sub>2</sub> ) <sub>3</sub>	92
7	g 3,4-F <sub>2</sub> -C <sub>6</sub> H <sub>3</sub>	100	14	n (CH <sub>3</sub> ) <sub>2</sub> CH	90

drides **25** were unstable on silica gel, and a yield-compromising crystallization or distillation had to be performed for product isolation. We found that the use of activated charcoal as an additive allowed the condensation to proceed at room temperature, which greatly minimized the byproduct formation. A wide variety of *O*-carboxyanhydrides (**25**) were prepared from the corresponding  $\alpha$ -hydroxy acids (**24**) in high purity and 90–100% yield (Table 4).<sup>24</sup> The kinetic resolutions of alkyl-substituted *O*-carboxy anhydrides proceeded with enantioselectivities comparable to those obtained with UNCAs. A hydrolysis of the products afforded both the  $\alpha$ -hydroxy ester (**26**) and the  $\alpha$ -hydroxy acid (**24**) in good yield (Scheme 5).<sup>24</sup> Once again, product isolation and catalyst recovery can both be accomplished via a facile extractive procedure.

**Mechanistic Study of Cinchona Alkaloid-Catalyzed Asymmetric Alcoholysis of UNCA.** To gain an understanding of the fundamental chemical mechanism of the kinetic resolution of UNCA, we carried out kinetic studies on the methanolysis of UNCA **21a** in toluene.<sup>22</sup> We found that the reaction is first order in the modified cinchona alkaloid catalyst, alcohol, and UNCA. We further estab-

Scheme 4

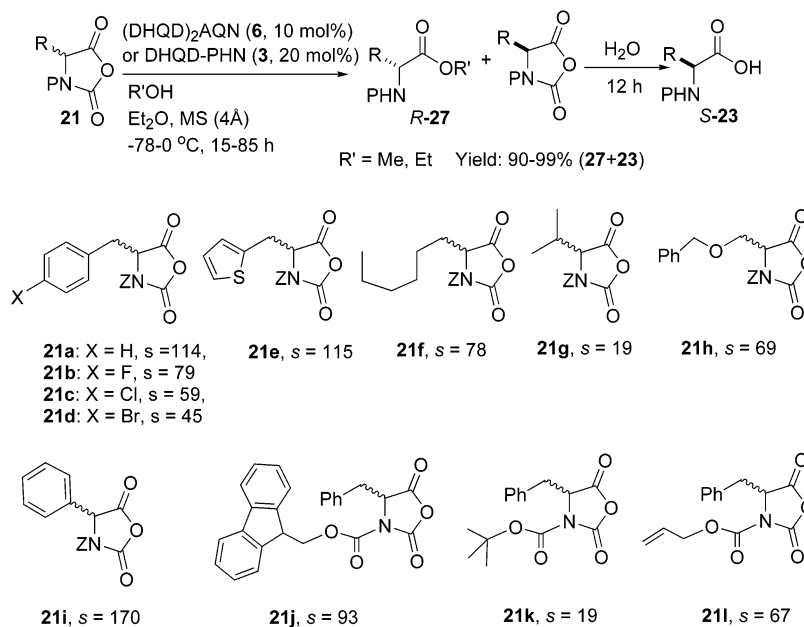

Scheme 5

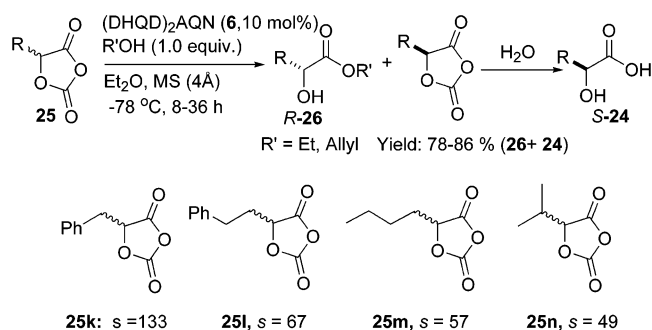

Scheme 6

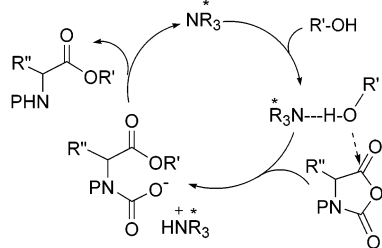

lished that the reaction is first order in either the dimeric cinchona alkaloid (DHQD)<sub>2</sub>AQN or the monomeric cinchona alkaloid DHQD-PHN and proceeds with similar rates and enantioselectivities ( $s = 50$  vs  $47$ ) with either catalyst. Moreover, a kinetic isotope effect was detected for alcoholysis with MeOD. These results strongly indicate that alcoholysis of the UNCA proceeds via a general base catalysis mechanism (Scheme 6).<sup>22</sup>

In this mechanism the alcohol is activated for nucleophilic attack via hydrogen bonding with the amine catalyst. The attack on the anhydride by the amine-alcohol hydrogen-bonding complex is the ee-determining and rate-determining step. The kinetic data also indicates that, most likely, only one quinidine unit is responsible for the highly enantioselective catalysis even when (DHQD)<sub>2</sub>AQN, a dimeric cinchona alkaloid, is used as the catalyst. Most interestingly, the general base catalysis mechanism implies that the highly reliable stereocontrol with an enzyme-like efficiency demonstrated by the modified cinchona alkaloid is mediated by a hydrogen-bonding interaction with the alcohol. The mechanistic model that emerges from our kinetic studies is unexpected, because other highly effective amine catalysts are believed to transfer chirality when they are covalently linked to a reacting substrate.<sup>2a,25</sup> As discussed below, the general base catalysis mechanism provided us with insights which were instrumental in the development of an efficient dynamic kinetic resolution (DKR) of UNCAs.

**Dynamic Kinetic Resolutions of *N*- and *O*-Carboxy Anhydrides.** Converting both enantiomers of a racemic mixture into a single optically active product, DKR is the most desirable form of kinetic resolution.<sup>26</sup> In addition to a highly enantioselective kinetic resolution, racemization of the starting material that is faster than but does not interfere with the kinetic resolution needs to be established under conditions that must not cause racemization of the product. Consequently, development of an efficient

Table 5

entry	temp./ °C	R'	time/ h	conv./ %	er of <b>28i</b> or <b>29i</b>
1	-78	Et (10 equiv)	2	48	97:3
2	-78	Et (10 equiv)	336	100	56:44
3	34	Et (10 equiv)	0.2	100	79:21
4	34	Et (1.2 equiv)	2	100	93:7
5	23	Allyl (1.2 equiv)	1	100	96:4

DKR with a substantial substrate scope represents one of the most challenging endeavors in asymmetric catalysis.

Recognizing that *N*- and *O*-carboxy anhydrides are more susceptible to racemization than their corresponding esters, we began to develop experimentally simple yet efficient DKRs of these cyclic anhydrides. We envisioned that the modified cinchona alkaloids could perform a dual-function catalytic role, promoting both the highly enantioselective kinetic resolution and the racemization required for a DKR (Scheme 7). Indeed, we found that, in the presence of (DHQD)<sub>2</sub>AQN, the interconversion between the *S*- and the *R*-enantiomer of phenyl *O*-carboxy anhydride **25a** was much faster than the enantioselective alcoholysis. Thus, the synergistic combination of the (DHQD)<sub>2</sub>AQN-catalyzed racemization and alcoholysis led to efficient DKRs of aryl *O*-carboxy anhydrides (**25a-h**), generating the corresponding esters **26** in excellent ee and in 65–85% isolated yields. This is the first efficient DKR promoted by an organic catalyst.

This dual-function catalysis of modified cinchona alkaloids has been extended to realize an efficient DKR of  $\alpha$ -aryl UNCAs.<sup>27</sup> As shown in Table 5, the ethanolysis of racemic **21i** at -78 °C with (DHQD)<sub>2</sub>AQN afforded a normal kinetic resolution. Upon complete conversion of the UNCA, the amino ester **28i** was formed in only 12% ee. This result indicated that the racemization proceeded at a negligible rate relative to the alcoholysis (Scheme 8,  $k_{inv} \ll k_{fast}, k_{slow}$ ). An efficient DKR of **21i** requires a reversal in the order of these rates ( $k_{inv} \gg k_{fast}, k_{slow}$ ). Our previous kinetic studies indicate that a general base catalysis mechanism is operating, implying a termolecular transition state for the alcoholysis. The epimerization of UNCA by (DHQD)<sub>2</sub>AQN has a bimolecular transition state.

We hypothesized and subsequently showed that by raising the reaction temperature to enhance the role played by the entropic factor in determining the relative rates of these two reactions, the order of the rates could be reversed (Table 5). This dramatic acceleration of the rate of the racemization relative to the kinetic resolution, when combined with a slow addition of the alcohol, converts a normal kinetic resolution to an efficient DKR (Table 5).<sup>27</sup>

We were fortunate to find that allyl alcohol is the best nucleophile for the DKR, as the enantioenriched allyl amino esters (**29** and **30**) can be converted to aryl  $\alpha$ -amino acids **23** without compromising optical purity via a mild

Scheme 7

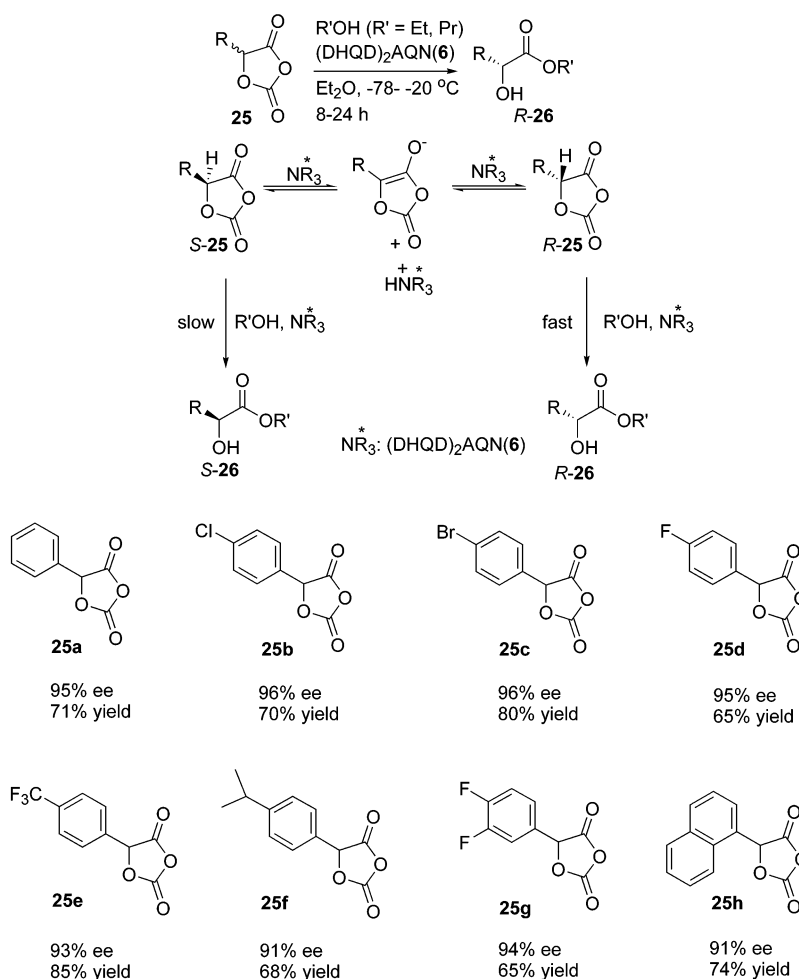

Scheme 8

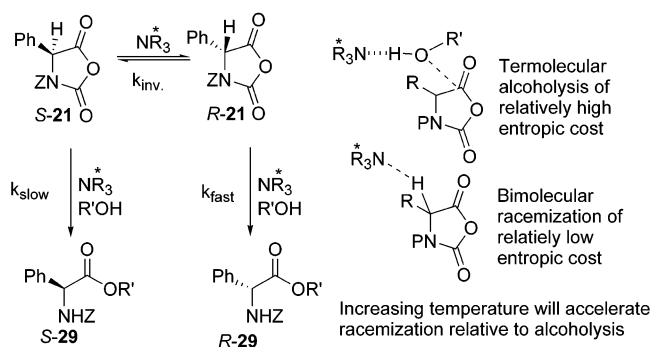

Pd-catalyzed deallylation. Consequently, a wide variety of optically active  $\alpha$ -aryl amino acids can be prepared from the corresponding racemic amino acids via an efficient DKR of aryl UNCAs (Scheme 9).<sup>27</sup>

**Asymmetric Cyanation of Simple Ketones.** In parallel with our studies of the enantioselective alcoholysis of cyclic anhydrides, we started to develop novel asymmetric organic catalysis by applying modified cinchona alkaloids to address other challenging problems in asymmetric synthesis. The catalytic enantioselective construction of a quaternary stereocenter is a fundamentally important yet largely unsolved problem in catalytic asymmetric synthesis.<sup>28</sup> Although catalytic enantioselective C–C bond

formation with ketones represents an attractive strategy for the construction of quaternary stereocenters, realization of this approach has proven to be extremely challenging. The two substituents of a ketone greatly diminish its activity toward nucleophilic additions. Their resemblance to each other makes it difficult for a small molecule catalyst to discriminate between them.

We became interested in the catalytic asymmetric cyanation of ketones because of its synthetic utility. In principle, this reaction could be promoted by either chiral Lewis acids or chiral Lewis bases (Scheme 10). However, no attempts to use a chiral base catalyst had been described. Also, no well-defined study of an amine-catalyzed ketone cyanation had been reported. Thus, the first obstacle to overcome in the development of a cinchona alkaloid-catalyzed cyanation was the establishment of an efficient amine-catalyzed cyanation of ketones.

Poirier's report,<sup>29</sup> which described an addition of alkyl cyanofornate (10 equiv) to ketones with a large excess amount (20 equiv) of diisopropylamine (Scheme 11), attracted our attention. Our first objective was to develop a cyanocarboxylation with a catalytic amount of amine. The use of the secondary amine and the alkyl cyanofornate in such excess amounts hinted at the existence of a decomposition reaction involving these two reagents. We believe that while the reaction proceeds through the

Scheme 9

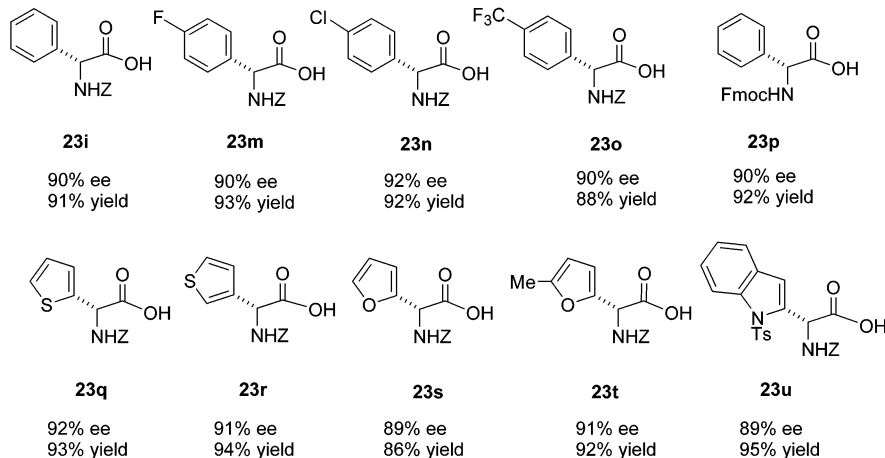
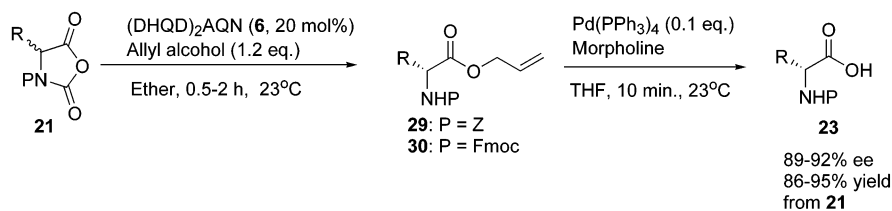

Scheme 10

Table 6

entry	catalyst	conv./%
1	Et <sub>3</sub> N	38
2	quinuclidine	37
3	DABCO	84

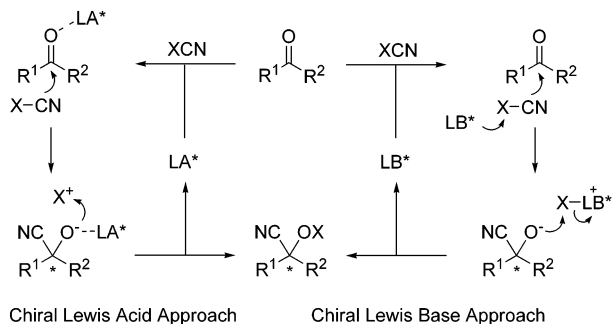

Scheme 11

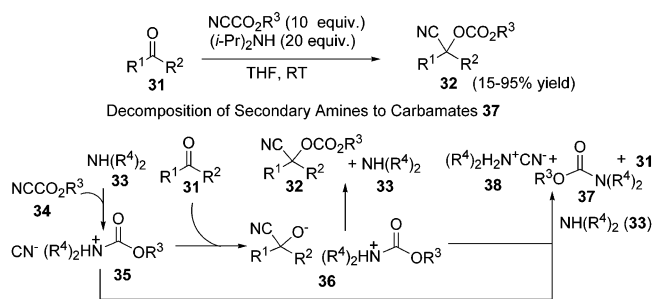

proposed mechanism outlined in Scheme 10, acylammonium intermediates **35** and **36**, derived from amine **33** and the alkyl cyanoformate **34**, may undergo deprotonation by another molecule of **33** to irreversibly form carbamate **37**. Conceivably, this decomposition pathway could be eliminated by using a tertiary amine, instead of a secondary amine, to mediate the cyanocarbonation. Our initial studies following these considerations established that reasonable catalytic turnovers could be obtained with DABCO even when only 1.5 equiv of alkyl cyanoformate was employed (Table 6).<sup>30</sup>

Building on this new amine-catalyzed cyanocarbonation, we subsequently developed the first chiral Lewis base-catalyzed enantioselective cyanation of ketones.<sup>30,31</sup> In general, this reaction provides good to excellent enantioselectivity for various  $\alpha$ -substituted and  $\alpha,\alpha$ -disubstituted dialkyl ketones with 20–35 mol % catalyst (Table 7). The same yields and ee's were obtained with lower catalyst loading (10 mol %) when the reactions were allowed to proceed for an extended time (1–3 weeks). Fortunately, the reaction could be performed by allowing the reaction mixture to stand in a vial without stirring and with no special precautions to exclude moisture and air. However, the reaction became sluggish with conjugated ketones.

While the enantioselective cyanocarbonation was found to proceed cleanly, the ee of the cyanohydrin carbonate generated from simple dialkyl ketones (**31a–f**) started to decrease noticeably when the conversion of the reaction reached the range of 60–80%. Thus, the modest yet still useful yield for reactions involving **31a–f** resulted from incomplete conversion of the starting ketones. Interestingly, this ee variation is significantly less pronounced in reactions employing  $\alpha,\alpha$ -dialkoxy cyclic and acyclic ketones (**31g–j**). Highly enantioenriched cyanohydrin carbonates generated from these ketones were isolated in good to excellent yields.



Scheme 12

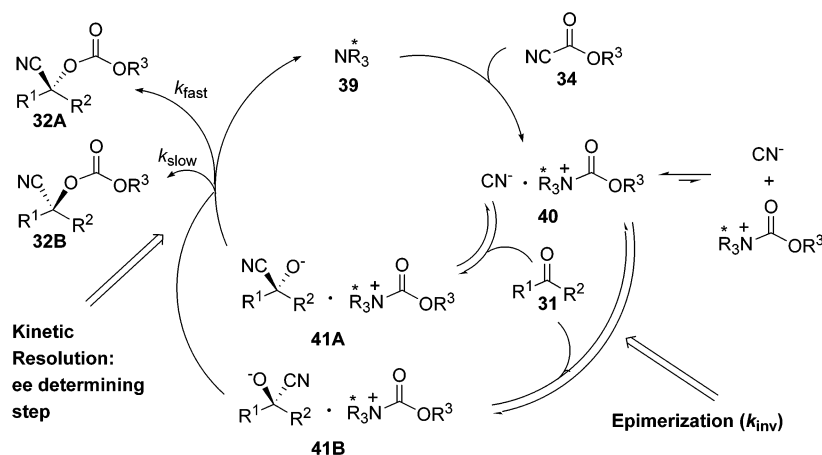
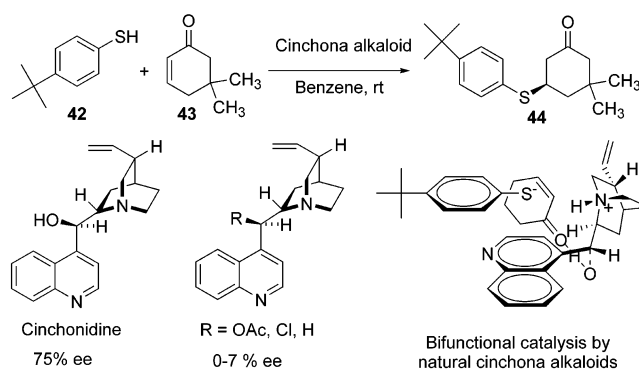

Table 7

entry	ketone	catalyst (mol%)	T (°C)	time (d)	ee (%)	conv (%)	yield (%)
1		(DHQD) <sub>2</sub> AQN (15)	-24	4	95	79	76
2		(DHQD) <sub>2</sub> AQN (15)	-24	2	97	68	66
3		(DHQD) <sub>2</sub> AQN (30)	-12	5	92	56	53
4		(DHQD) <sub>2</sub> AQN (20)	-24	4	91	65	62
5		(DHQD) <sub>2</sub> AQN (20)	-24	2	87	55	52
6		(DHQD) <sub>2</sub> AQN (20)	-24	2	81	57	54
7		(DHQD) <sub>2</sub> AQN (30)	-24	5	88	58	55
8		DHQ-PHN (30)	-24	4	95	83	80
9		DHQD-PHN (20)	-24	3	93	97	96
10		DHQD-PHN (10)	-24	7	94	100	99
11		DHQD-PHN (35)	-12	5	96	82	78
12		DHQD-PHN (30)	-24	4	96	90	86
13		DHQD-PHN (35)	-12	4	90	68	65
14		(DHQD) <sub>2</sub> AQN (20)	-24	0.5	59	56	54
15		(DHQD) <sub>2</sub> AQN (20)	-24	2.5	40	96	93

As shown in a proposed mechanism displayed in Scheme 12,<sup>30</sup> the enantioselectivity of the modified cinchona alkaloid-catalyzed cyanocarbonylation may originate from the enantioselective addition of the cyanide, as part of a chiral ion complex (**40**), to ketone **31**. However, the unusual ee deterioration of the cyanohydrin carbonate **32** could be explained by an alternative mode of asymmetric induction invoking a dynamic kinetic resolution of **41A** and **41B**. Conceivably, the two diastereomeric complexes, **41A** and **41B**, undergo transfer of the alkoxy carbonyl group at different rates to give product **32** in optically active form, while **41A** and **41B** are equilibrating with each other through ketone **31**. According to this model, the

Scheme 13



significant drop in ee observed with simple dialkyl ketones is because the rate of the epimerization step, the addition of  $\text{CN}^-$  to ketone **31a-f**, is not significantly faster than that of the kinetic resolution step (**41** to **32**).<sup>26a</sup> Increasing the rate of the epimerization step should lead to a reduction in the extent of the ee drop, a phenomenon observed in the reaction with ketones **31g-i**. The electron-withdrawing dialkoxy group presumably activates the ketone toward nucleophilic attack by  $\text{CN}^-$ , thereby increasing the rate of the epimerization step. This in turn lessens the decline in the ee of the product as the reaction proceeds to high conversion.

**Asymmetric Conjugate Addition of Thiols to Cyclic Enones.** Wynberg's seminal studies of the cinchona alkaloid-catalyzed 1,4-addition of thiols to cyclic enones bear historic significance in the development of asymmetric catalysis by cinchona alkaloids.<sup>7,32</sup> A high of 75% ee was attained in the addition of thiols to 5,5-dimethyl cyclohexenone catalyzed by cinchonidine (Scheme 13). Although modest compared to those reported recently, this was a remarkably high enantioselectivity for a 1,4-addition in 1981. Kinetic studies indicated that the cinchona alkaloid, the cyclic enone, and the thiol are all involved in the transition state. In general, significantly better activity and selectivity were obtained with natural cinchona alkaloids such as cinchonidine than their derivatives that had undergone modification of the C9-OH. Wynberg attributed the superior catalytic properties of cinchonidine to a bifunctional catalysis mechanism in-

Scheme 14

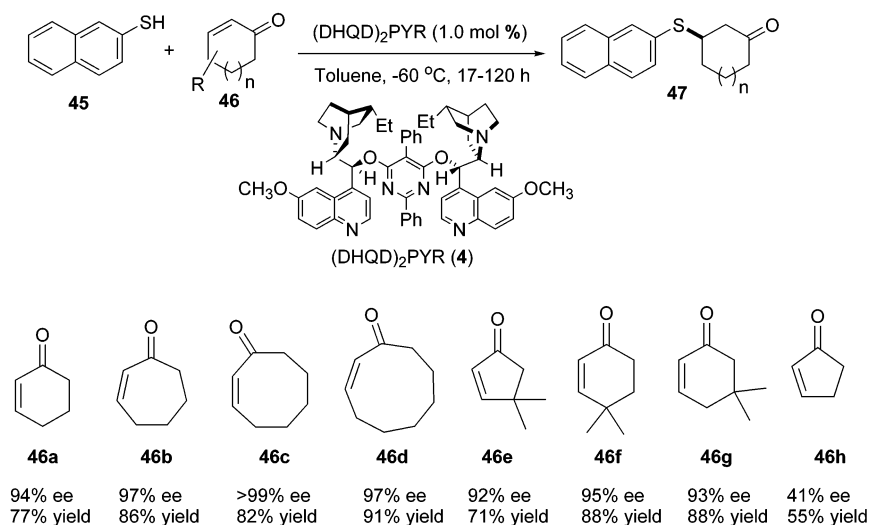

volving simultaneous activation of the cyclic enone and the thiol by the hydroxyl and the amine groups, respectively. This bifunctional catalysis model was believed to be generally applicable to many asymmetric reactions in which natural cinchona alkaloids performed better than modified cinchona alkaloids.

The superior catalytic properties demonstrated by  $(\text{DHQD})_2\text{AQN}$  and  $\text{DHQD-PHN}$ , relative to natural cinchona alkaloids, in the enantioselective alcoholysis and cyanocarbonation prompted us to examine the 1,4-addition of thiols to cyclic enones catalyzed by the modified cinchona alkaloids. This investigation led to the interesting discovery that  $(\text{DHQD})_2\text{PYR}$  (**4**), a modified cinchona alkaloid lacking a hydrogen-bond donor, catalyzed highly enantioselective 1,4-additions of thiols to five- to nine-membered cyclic enones (Scheme 14).<sup>33</sup> These are unexpected results as previous studies of the same reaction by Wynberg and Mukaiyama using other organic catalysts had indicated that an amino alcohol moiety was required for optimal activity and selectivity.<sup>32,34</sup> These results constitute the first general and highly enantioselective catalytic asymmetric 1,4-addition of thiols to cyclic enones. It should be noted that the sense of asymmetric induction obtained with  $(\text{DHQD})_2\text{PYR}$  with respect to the absolute configuration of C8 and C9 of the cinchona alkaloid skeleton is opposite to that obtained with natural cinchona alkaloids. This suggests that the corresponding mechanisms for the conjugate additions catalyzed by the modified and natural cinchona alkaloids must differ significantly. These findings should provide stimulus for new studies of other synthetically important catalytic asymmetric 1,4-additions as well as significantly expand the scope of chiral Lewis-base/nucleophilic catalysis of cinchona alkaloids.

#### IV. Summary and Outlook

Our extensive studies of chiral Lewis-base/nucleophilic catalysis of modified cinchona alkaloids have led to the development of a wide variety of new, highly enantioselective, general, and clean catalytic reactions. Utilizing

simple reagents and commercially available and readily recyclable catalysts to transform readily accessible meso, achiral, and racemic compounds into valuable chiral building blocks, these new reactions represent not only conceptually new approaches but also useful solutions for important and challenging problems in catalytic asymmetric synthesis, such as the development of efficient dynamic kinetic resolutions (DKR) and the catalytic enantioselective construction of quaternary stereocenters. It is noteworthy that these highly enantioselective reactions, alcoholysis of cyclic anhydrides, cyanocarbonation of ketones, and the 1,4-addition of thiols to enones, are all catalyzed by modified cinchona alkaloids and yet are mechanistically unrelated. In addition to our studies, Calter,<sup>35</sup> Hatakeyama,<sup>36</sup> Lectka,<sup>37</sup> and Romo<sup>38</sup> reported several highly enantioselective additions of chiral zwitterionic enolates to various electrophiles facilitated by modified cinchona alkaloids. These recent developments establish modified cinchona alkaloids as one of the most broadly useful, privileged classes of chiral Lewis-base/nucleophilic organic catalysts. It remains to be seen whether these promising results will lead to the development of powerful reactions that are routinely applicable to both commercial-scale synthesis and complex natural product synthesis.

*This work has been supported by the National Institute of Health (National Institute of General Medical Sciences, R01-GM61591).*

#### References

- (1) *Comprehensive Asymmetric Catalysis*; Jacobsen, E. N., Pfaltz, A., Yamamoto, H., Eds.; Springer: New York, 1999; Vols. I–III.
- (2) (a) Ruble, J. C.; Fu, G. C. Chiral  $\pi$ -Complexes of Heterocycles with Transition Metals: A Versatile New Family of Nucleophilic Catalysts. *J. Org. Chem.* **1996**, *61*, 7230–7231. (b) For a review, see: Fu, G. C. Enantioselective Nucleophilic Catalysis with “Planar-Chiral” Heterocycles. *Acc. Chem. Res.* **2000**, *33*, 412–420 and references therein.
- (3) Oriyama, T.; Imai, K.; Hosoya, T.; Sano, T. Asymmetric Acylation of meso-Diols with Benzoyl Halide in the Presence of a Chiral Diamine. *Tetrahedron Lett.* **1998**, *39*, 397–400.

- (4) (a) Denmark, S. E.; Stavenger, R. A.; Su, X. P.; Wong, K. T.; Nishigaichi, Y. Asymmetric Catalysis with Chiral Lewis Bases. *Pure Appl. Chem.* **1998**, *70*, 1469–1476. (b) For a review, see: Denmark, S. E.; Stavenger, R. A. Asymmetric Catalysis of Aldol Reactions with Chiral Lewis Bases. *Acc. Chem. Res.* **2000**, *33*, 432–440.
- (5) For a comprehensive review of a wide range of asymmetric catalysis of cinchona alkaloids, see: Kacprzak, K.; Gawronski, J. Cinchona Alkaloids and Their Derivatives: Versatile Catalysts and Ligands in Asymmetric Synthesis. *Synthesis* **2001**, 961–998.
- (6) Pracejus, H. Asymmetrische Synthesen mit Ketene. I *Justus Liebigs Ann. Chem.* **1960**, *634*, 9–22.
- (7) Wynberg, H. Asymmetric Catalysis by Alkaloids. *Top. Stereochem.* **1986**, *16*, 87–129.
- (8) Wynberg, H.; Staring, E. G. J. Asymmetric Synthesis of (S)- and (R)-Malic Acid from Ketene and Chloral. *J. Am. Chem. Soc.* **1982**, *104*, 166–168.
- (9) Kagan, H. B. Historical Perspective. In *Comprehensive Asymmetric Catalysis*; Jacobsen, E. N., Pfaltz, A., Yamamoto, H., Eds.; Springer-Verlag: Berlin, 1999; Chapter 2.
- (10) For a review, see: Kolb, H. C.; VanNieuwenhze, M. S.; Sharpless, K. B. Catalytic Asymmetric Dihydroxylation. *Chem. Rev.* **1994**, *94*, 2483–2547.
- (11) Marko, I. E.; Svendsen, J. S. Dihydroxylation of Carbon–Carbon Double Bonds. In *Comprehensive Asymmetric Catalysis*; Jacobsen, E. N., Pfaltz, A., Yamamoto, H., Eds.; Springer: New York, 1999; Vols. I–III, Chapter 20.
- (12) Corey, E. J.; Noe, M. C. Rigid and Highly Enantioselective Catalyst for the Dihydroxylation of Olefins Using Osmium Tetraoxide Clarifies the Origin of Enantiospecificity. *J. Am. Chem. Soc.* **1993**, *115*, 12579–12580.
- (13) For a review, see: Chen, Y.; McDaid, P.; Deng, L. Asymmetric Alcoholysis of Cyclic Anhydrides. *Chem. Rev.* **2003**, *103*, 2965–2984.
- (14) (a) Hiratake, J.; Yamamoto, Y.; Oda, J. Catalytic Asymmetric Induction from Prochiral Cyclic Acid Anhydrides Using Cinchona Alkaloids. *J. Chem. Soc., Chem. Commun.* **1985**, 1717–1719. (b) Hiratake, J.; Inagaki, M.; Yamamoto, Y.; Oda, J. Enantiotopic-Group Differentiation–Catalytic Asymmetric Ring-Opening of Prochiral Cyclic Acid Anhydrides with Methanol, Using Cinchona Alkaloids. *J. Chem. Soc., Perkin. Trans. 1* **1987**, 1053–1058.
- (15) Aitken, R. A.; Gopal, J.; Hirst, J. A. Catalytic Asymmetric Synthesis of Highly Functionalized Compounds with 6 Contiguous Stereocenters. *J. Chem. Soc., Chem. Commun.* **1988**, 632–634.
- (16) (a) Bolm, C.; Gerlach, A.; Dinter, C. L. Simple and Highly Enantioselective Nonenzymatic Ring Opening of Cyclic Prochiral Anhydrides. *Synlett* **1999**, 195–196. (b) Bolm, C.; Schiffers, I.; Dinter, C. L.; Gerlach, A. Practical and Highly Enantioselective Ring Opening of Cyclic meso-anhydrides Mediated by Cinchona Alkaloids. *J. Org. Chem.* **2000**, *65*, 6984–6991.
- (17) Chen, Y.; Tian, S.-K.; Deng, L. A Highly Enantioselective Catalytic Desymmetrization of Cyclic Anhydrides with Modified Cinchona Alkaloids. *J. Am. Chem. Soc.* **2000**, *122*, 9542–9543.
- (18) Choi, C.; Tian, S.-K.; Deng, L. A Formal Catalytic Asymmetric Synthesis of (+)-Biotin with Modified Cinchona Alkaloids. *Synthesis* **2001**, 1737–1741.
- (19) For a review, see: Eames, J. Parallel Kinetic Resolutions. *Angew. Chem., Int. Ed.* **2000**, *39*, 885–888.
- (20) Chen, Y.; Deng, L. Parallel Kinetic Resolutions of Monosubstituted Succinic Anhydrides Catalyzed by a Modified Cinchona Alkaloid. *J. Am. Chem. Soc.* **2001**, *123*, 11302–11303.
- (21) For preparations of UNCAs from  $\alpha$ -amino acids, see: Fuller, W. D.; Goodman, M.; Naider, F. R.; Zhu, Y. F. Urethane-Protected  $\alpha$ -Amino Acid N-Carboxyanhydrides and Peptide Synthesis. *Biopolymers (Peptide Sci.)* **1996**, *40*, 183–205.
- (22) Hang, J.; Tian, S.-K.; Tang, L.; Deng, L. Asymmetric Synthesis of  $\alpha$ -Amino Acids via Cinchona Alkaloid-Catalyzed Kinetic Resolution of Urethane-Protected  $\alpha$ -Amino Acid N-Carboxyanhydrides. *J. Am. Chem. Soc.* **2001**, *123*, 12696–12697.
- (23) Toyooka, K.; Takeuchi, Y.; Kubota, S. A Novel and Facile Synthesis of 5-Substituted 1,3-Dioxolane-2,4-Diones using Trichloromethyl Chloroformate. *Heterocycles* **1989**, *29*, 975–978.
- (24) Tang, L.; Deng, L. Dynamic Kinetic Resolution via Dual-function Catalysis of Modified Cinchona Alkaloids: Asymmetric Synthesis of  $\alpha$ -Hydroxy Carboxylic Acids. *J. Am. Chem. Soc.* **2002**, *124*, 2870–2871.
- (25) (a) France, S.; Guerin, D. J.; Miller, S. J.; Lectka, T. L. Nucleophilic Chiral Amines as Catalysts in Asymmetric Synthesis. *Chem. Rev.* **2003**, *103*, 2985–3012. (b) Dalko, P. I.; Moisan, L. Enantioselective Organocatalysis. *Angew. Chem., Int. Ed.* **2001**, *40*, 3726–3748 and references therein.
- (26) (a) Kitamura, M.; Tokunaga, M.; Noyori, R. Quantitative Expression of Dynamic Kinetic Resolution of Chirally Labile Enantiomers: Stereoselective Hydrogenation of 2-Substituted 3-Oxo Carboxylic Esters Catalyzed by BINAP–Ruthenium(II) Complexes. *J. Am. Chem. Soc.* **1993**, *115*, 144–152. (b) For a review see: Ward, R. S. Dynamic Kinetic Resolution. *Tetrahedron: Asymmetry* **1995**, *6*, 1475–1490 and references therein.
- (27) Hang, J.; Li, H.; Deng, L. Development of a Rapid, Room-Temperature Dynamic Kinetic Resolution for Efficient Asymmetric Synthesis of  $\alpha$ -Aryl Amino Acids. *Org. Lett.* **2002**, *4*, 3321–3324.
- (28) For a review, see: Corey, E. J.; Guzman-Perez, A. The Catalytic Enantioselective Construction of Molecules with Quaternary Carbon Stereocenters. *Angew. Chem., Int. Ed. Engl.* **1998**, *37*, 388–401.
- (29) Poirier, D.; Berthiaume, D.; Boivin, R. P. Unexpected Formation of O-Methoxycarbonyl Cyanohydrin Showing Potential as a Protective Group of Ketones. *Synlett* **1999**, 1423–1425.
- (30) Tian, S.-K.; Deng, L. A Highly Enantioselective Chiral Lewis Base-Catalyzed Asymmetric Cyanation of Ketones. *J. Am. Chem. Soc.* **2001**, *123*, 6195–6196.
- (31) In parallel with our studies with chiral Lewis bases, highly enantioselective cyanation of ketones with chiral Lewis acids were also reported: (a) Hamashima, Y.; Kanai, M.; Shibasaki, M. Catalytic Enantioselective Cyanosilylation of Ketones. *J. Am. Chem. Soc.* **2000**, *122*, 7412–7413. (b) Deng, H.; Isler, M. P.; Snapper, M. L.; Hoveyda, A. H. Aluminum-Catalyzed Asymmetric Addition of TMSCN to Aromatic and Aliphatic Ketones Promoted by an Easily Accessible and Recyclable Peptide Ligands. *Angew. Chem., Int. Ed.* **2002**, *41*, 1009–1012.
- (32) Hiemstra, H.; Wynberg, H. Addition of Aromatic Thiols to Conjugated Cycloalkenones Catalyzed by Chiral  $\beta$ -Hydroxy Amines. A Mechanistic Study on Homogeneous Catalytic Asymmetric Synthesis. *J. Am. Chem. Soc.* **1981**, *103*, 417–430.
- (33) McDaid, P.; Chen, Y.; Deng, L. A Highly Enantioselective and General Conjugate Addition of Thiols to Cyclic Enones with an Organic Catalyst. *Angew. Chem., Int. Ed.* **2002**, *41*, 338–340.
- (34) Suzuki, K.; Ikegawa, A.; Mukaiyama, T. The Enantioselective Michael Addition of Thiols to Cycloalkenones by Using (2S,4S)-2-Anilinomethyl-1-ethyl-4-hydroxypyrrolidine as Chiral Catalyst. *Bull. Chem. Soc. Jpn.* **1982**, *55*, 3277–3282.
- (35) Calter, M. A. Catalytic, Asymmetric Dimerization of Methylketene. *J. Org. Chem.* **1996**, *61*, 8006–8007.
- (36) Iwabuchi, Y.; Nakatani, M.; Yokoyama, N.; Hatekeyama, S. J. Chiral Amine-Catalyzed Asymmetric Baylis–Hillman Reaction: A Reliable Route to Highly Enantiomerically Enriched ( $\alpha$ -Methylene- $\beta$ -hydroxy)esters. *J. Am. Chem. Soc.* **1999**, *121*, 10219–10220.
- (37) (a) Taggi, A. E.; Hafez, A. M.; Wack, H.; Young, B.; Drury, W. J.; Lectka, T. Catalytic Asymmetric Synthesis of  $\beta$ -Lactams. *J. Am. Chem. Soc.* **2000**, *122*, 7831–7832. (b) Wack, H.; Taggi, A. E.; Hafez, A. M.; Drury, W. J.; Lectka, T. Catalytic, Asymmetric  $\alpha$ -Halogenation. *J. Am. Chem. Soc.* **2001**, *123*, 1531–1532.
- (38) (a) Cortez, G. S.; Tennyson, R. L.; Romo, D. Intramolecular, Nucleophile-Catalyzed Aldol-Lactonization (NCAL) Reactions: Catalytic, Asymmetric Synthesis of Bicyclic  $\beta$ -Lactones. *J. Am. Chem. Soc.* **2001**, *123*, 7945–7946. (b) Cortez, G. S.; Oh, S. H.; Romo, D. Bicyclic  $\beta$ -Lactones via Intramolecular NCAL Reactions with Cinchona Alkaloids: Effect of the C9-Substituent on Enantioselectivity and Catalyst Conformation. *Synthesis* **2001**, 1731–1736.

AR030048S