

FACIOSCAPULOHUMERAL MUSCULAR DYSTROPHY (FSHD)

AN (EPI-)GENETIC DISEASE

THE ROLE OF THE lncRNA DBE-T IN FACIOSCAPULOHUMERAL MUSCULAR DYSTROPHY (FSHD)

FSHD: <http://www.omim.org/entry/158900>

Facioscapulohumeral muscular dystrophy (FSHD) is a genetic muscle disorder that starts in the second decade. Frequency 1:200.000

Characterized by progressive muscle weakness

Initially: facial, scapular and humeral muscles

Later: abdominal muscles and muscles of the lower limb and feet

Asymmetric body

The long name comes from facies, the Latin word and medical term for face; scapula, the Latin word and anatomical term for shoulder blade; and humerus, the Latin word for upper arm and the anatomical term for the bone that goes from the shoulder to the elbow.

The term muscular dystrophy means progressive muscle degeneration, with increasing weakness and atrophy (loss of bulk) of muscles. In FSHD, weakness first and most seriously affects the face, shoulders and upper arms, but the disease usually also causes weakness in other muscles.

Genetic disease: variable amongst family members

Aberrant expression of genes in vicinity to subtelomeric D4Z4 repeats, including DUX4, ANT1, FRG1, FRG2 in FSHD patients are thought to mediate the syndrome (have a “toxic” effect)

Muscles affected by wasting in FSHD patients

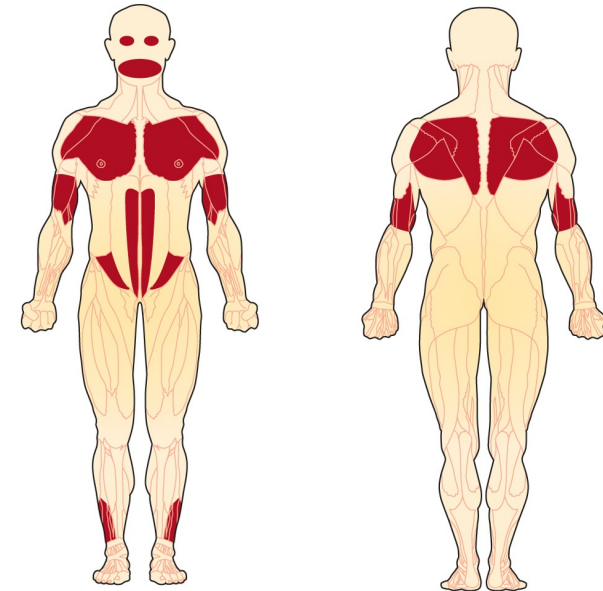

A

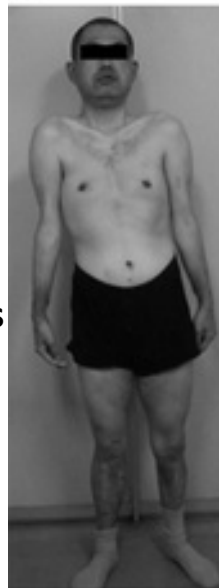

B

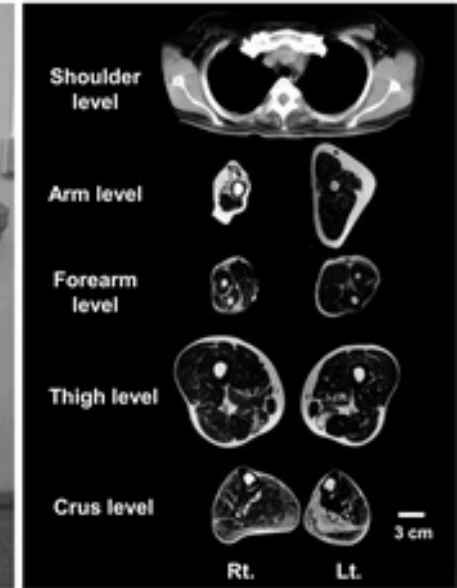

FSDH impairs muscle cell function

Moreover, in patients affected with FSHD, it is quite common to observe the co-existence of affected and apparently healthy muscles. Myoblasts, which were obtained from muscle typically affected in FSHD, manifested an increased susceptibility to oxidative stress during proliferation.

Myotubes obtained from patient/healthy myoblasts show abnormal morphology and muscle marker expression

Myoblasts = muscle cell progenitors that proliferate and fuse to form myotubes

Anti **actin/tubulin** immunostaining of myotubes obtained by differentiating myoblasts cells isolated from healthy or FSHD patients

anti-**troponinT** immunostaining of myotubes obtained by differentiating myoblasts cells isolated from healthy or FSHD patients

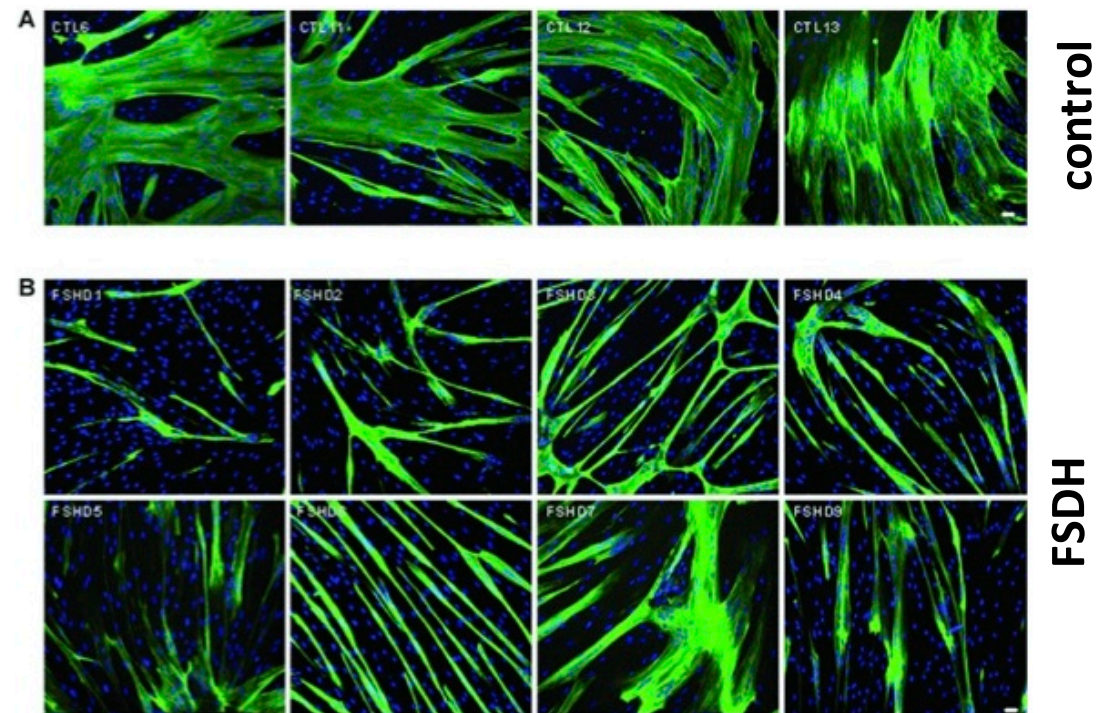
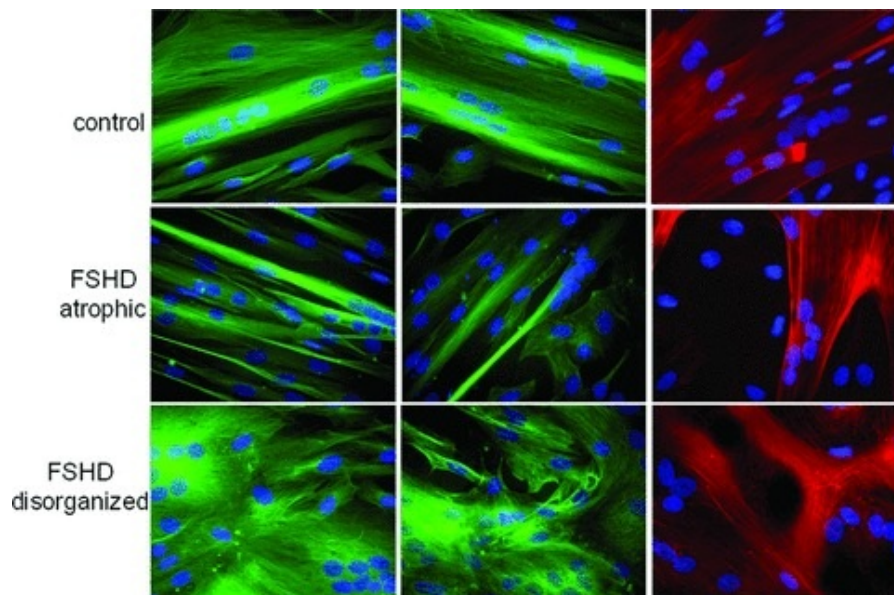

Common feature: aberrant expression of genes in vicinity to subtelomeric D4Z4 repeats, including DUX4, ANT1, FRG1, FRG2 in FSHD patients → “toxic” effect

The genetics of FSDH

FSDH is linked with aberrant D4Z4 repeat numbers at subtelomeric repeats of Chr4q

D4Z4: 3,3kb, repeats oriented head-to-tail, 11-100 repeat in healthy individuals - polymorphic

Located on Chr4q → disease relevant

Located on Chr10q → not disease relevant (99% identical to Chr4q D4Z4 repeats)

Each D4Z4 repeat contains: DUX4 ORF

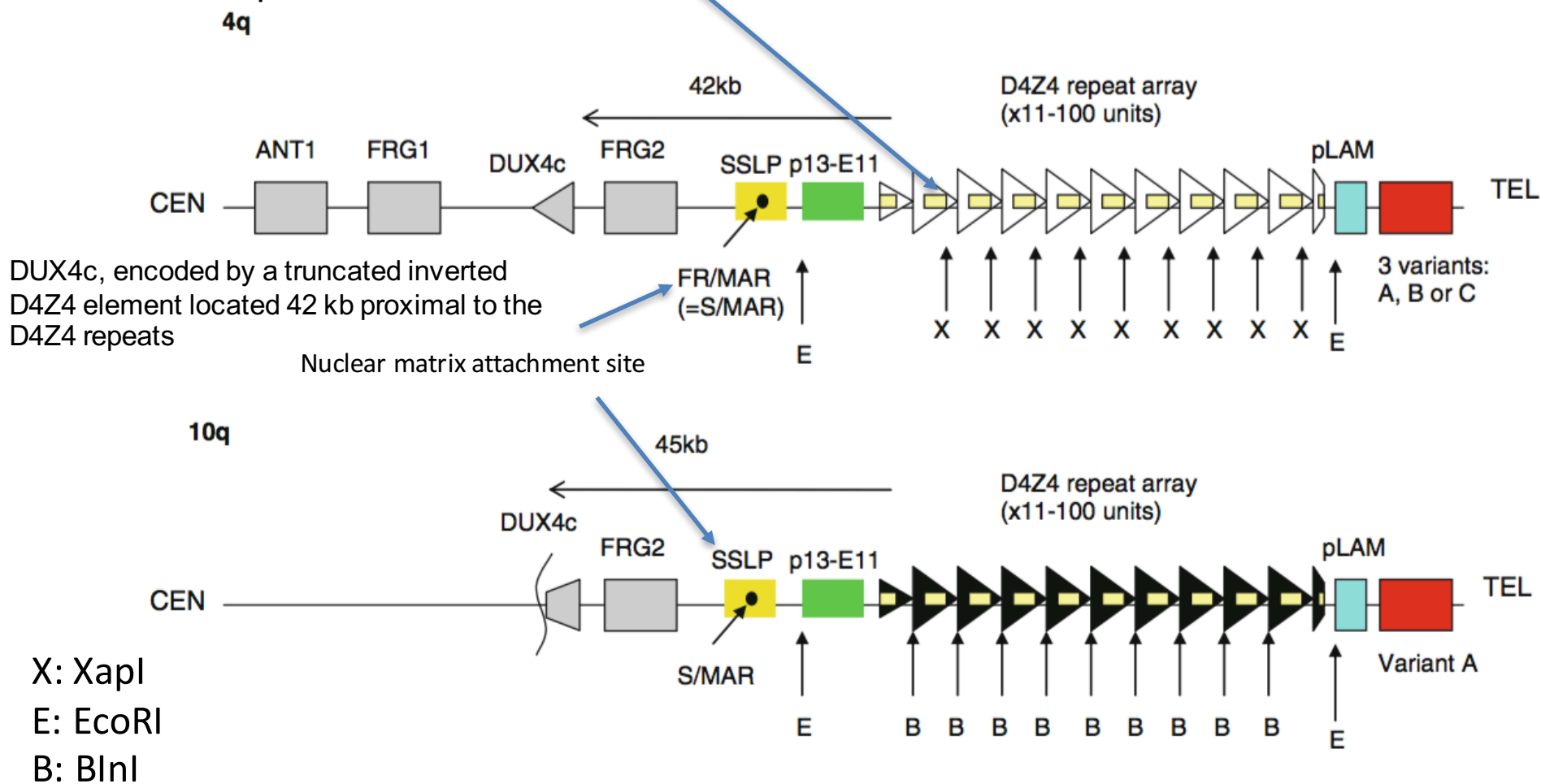

The genetics of FSDH

Facioscapulohumeral muscular dystrophy-1 (FSDH1) is associated with contraction of the D4Z4 macrosatellite repeat in the subtelomeric region of **chromosome 4q35**.

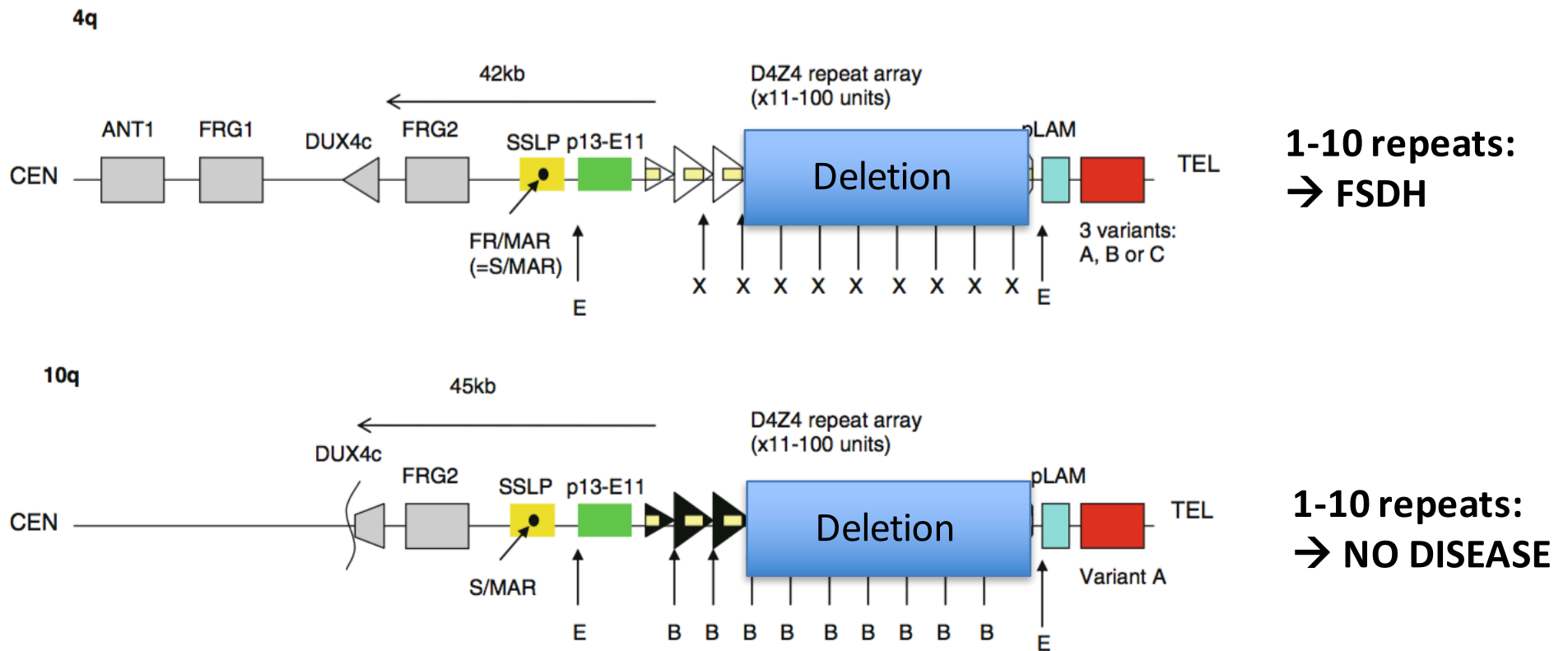

The genetics of FSDH

Repeat aberrations can be detected by Pulsed field gel electrophoresis

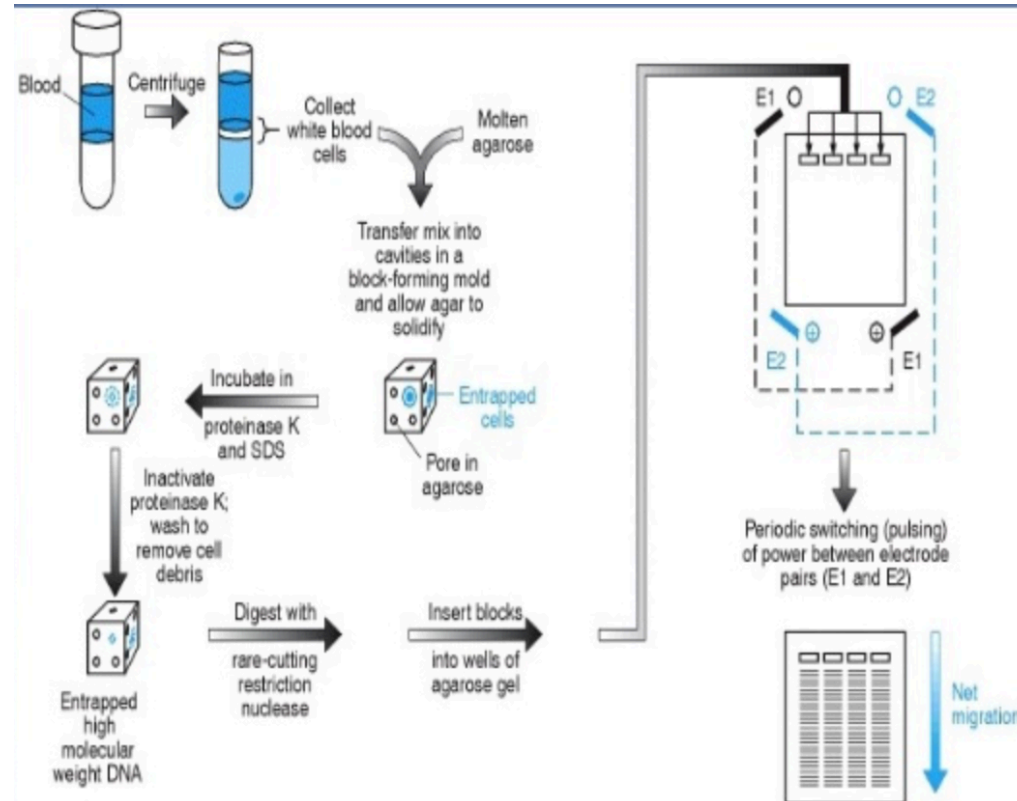
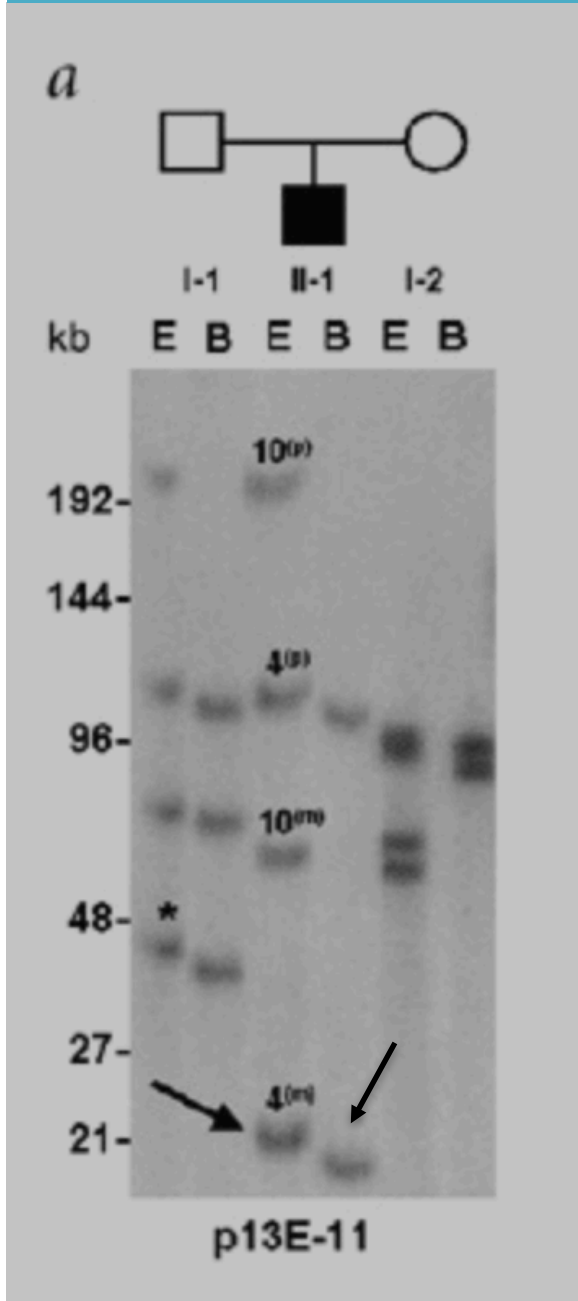

Southern blot

p13E-11

Pulsed-field gel electrophoresis (PFGE) analysis of kindred 25 affected with FSHD using probe **p13E-11**. *a*, We digested DNA with EcoRI and HindIII (E) and with EcoRI and BlnI (B), separated fragments by PFGE and hybridized them with p13E-11 (left panel). **Ade novo fragment of 21 kb is visible for individual II-1** (arrow).

DUX4 ORF DUX4 ORF DUX4 ORF

The genetics of FSDH

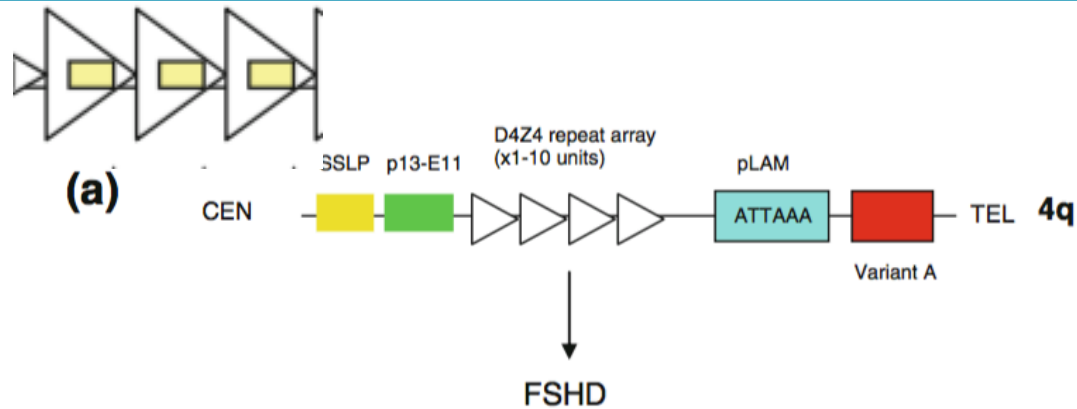

**Deletion of repeats,
SNP in pLAM box generates a Poly A site
combined with VARIANT A**

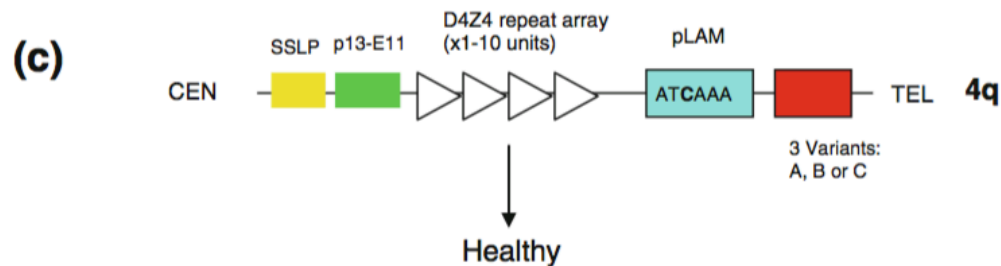

**Deletion of repeats,
NO Poly-A sequence in pLAM box
combined with VARIANT A, B, C**

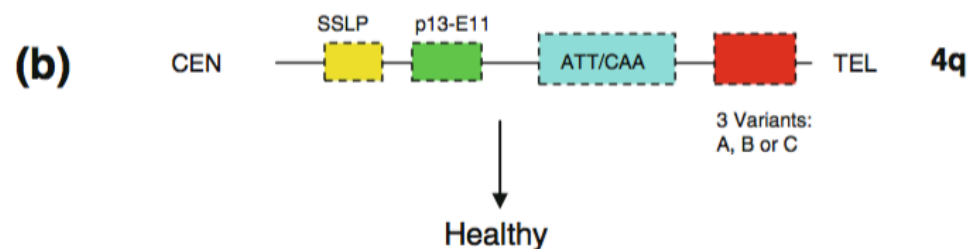

**Deletion of all repeats,
Poly-A sequence in pLAM box
combined with VARIANT A, B, C**

DUX4 gene in D4Z4 repeats must be linked with disease, AATAAA stabilizes most distal DUX4 mRNA

The epi-genetics of FSHD

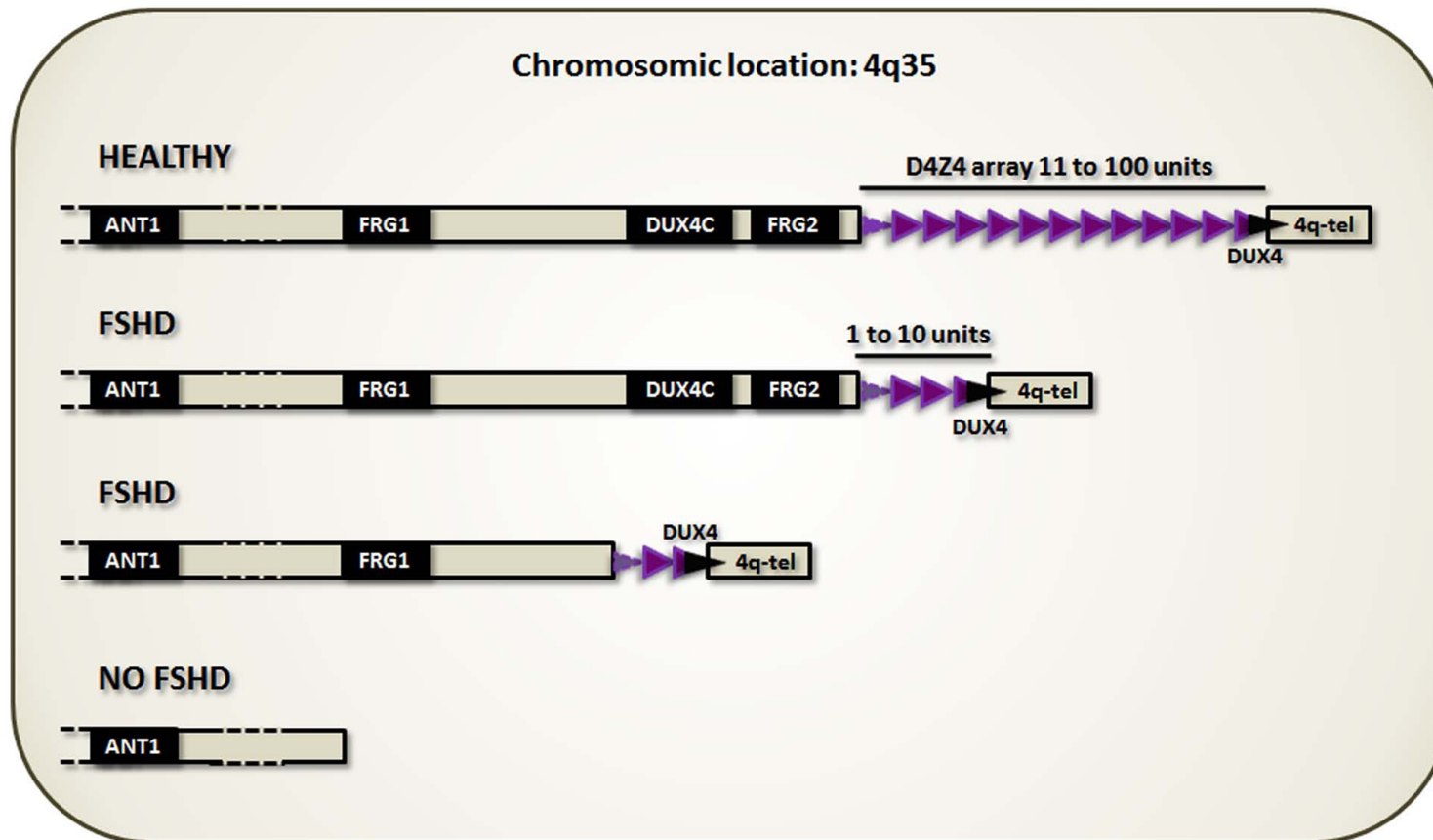

Upregulation
of ANT1, 2, FRG1

Upregulation
of ANT1, 2, FRG1

No DUX4 in
D4Z4 repats

Observation: repeat restriction leads to upregulation of ANT1, FRG1, and FRG2 genes
→ Epigenetic effect?

MISS-EXPRESSION OF DUX4 and ANT1, ANT2 and FRG2 causes “cell wasting” of muscles

The epi-genetics of FSDH

NORMAL SITUATION 11-100 DZ4Z repeat units

Figure shows most distal (close to telomere) DZ4Z unit

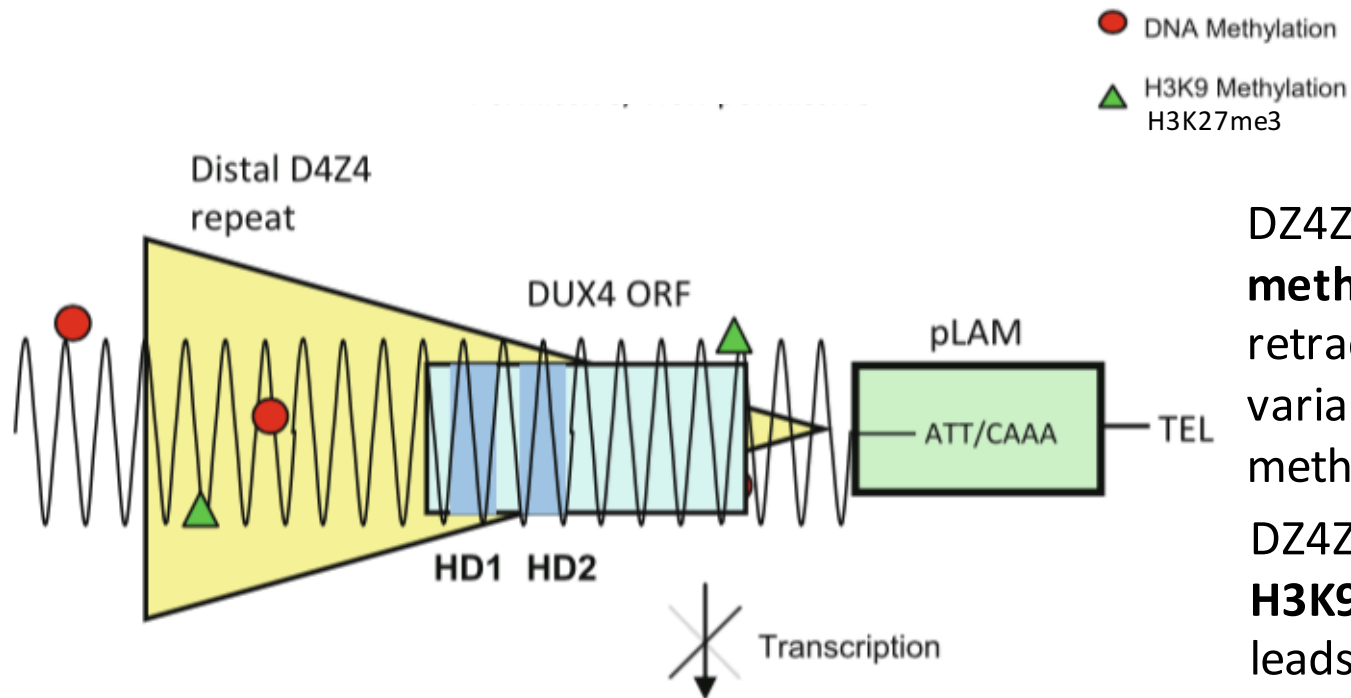

DZ4Z repeats contain **methylated CpG island**; repeat retraction leads to variable/reduced DNA methylation

DZ4Z repeats show **H3K9me3**; repeat retraction leads to variable/reduced H3K9me3

Also observed:

H3K27me3/Polycomb

The epi-genetics of FSDH

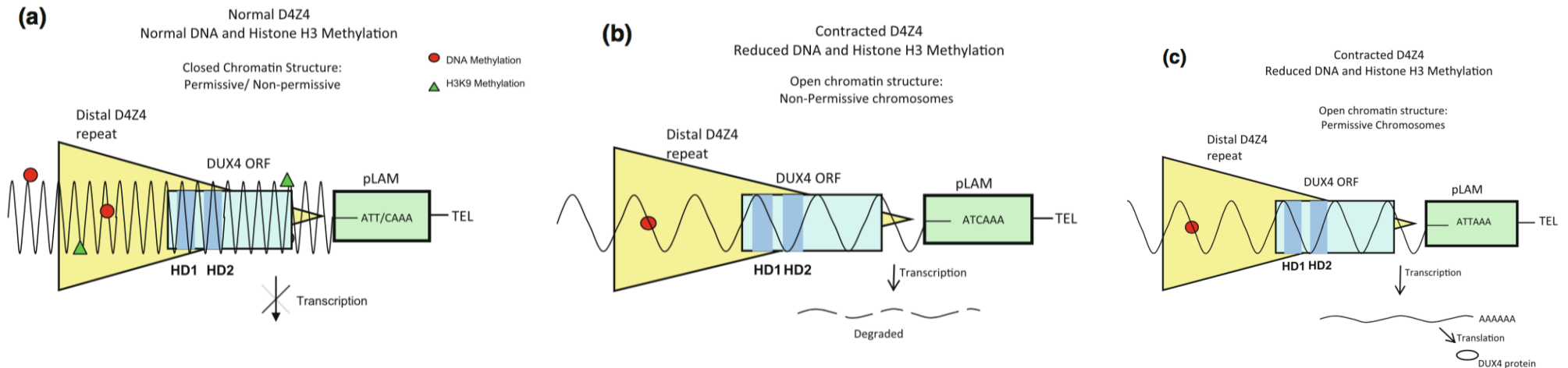

Normal situation
 H3K27me3
 H3K9me3-HP1

Reduced D4Z4 repeats
 - No polymorphism in pLAM box
 - No poly-A site for most distal DUX4 ORF
 - RNA degradation

Reduced D4Z4 repeats
 - polymorphism in pLAM box
 - poly-A site for most distal DUX4 ORF
 - RNA stable
 - DUX4 expression

The epi-genetics of FSDH

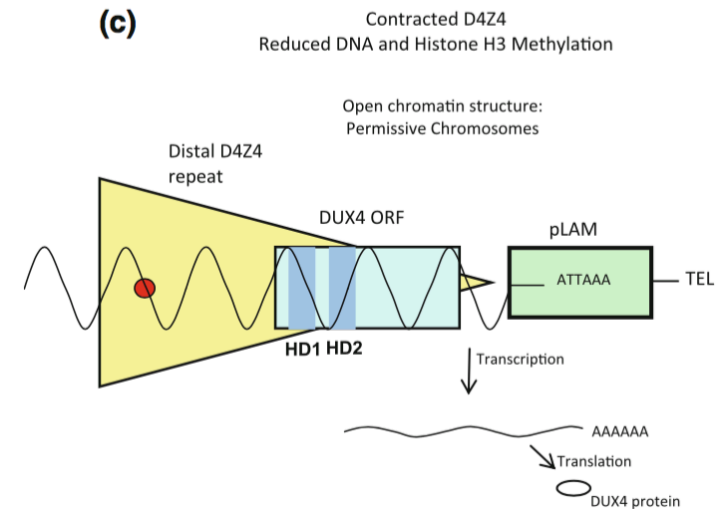
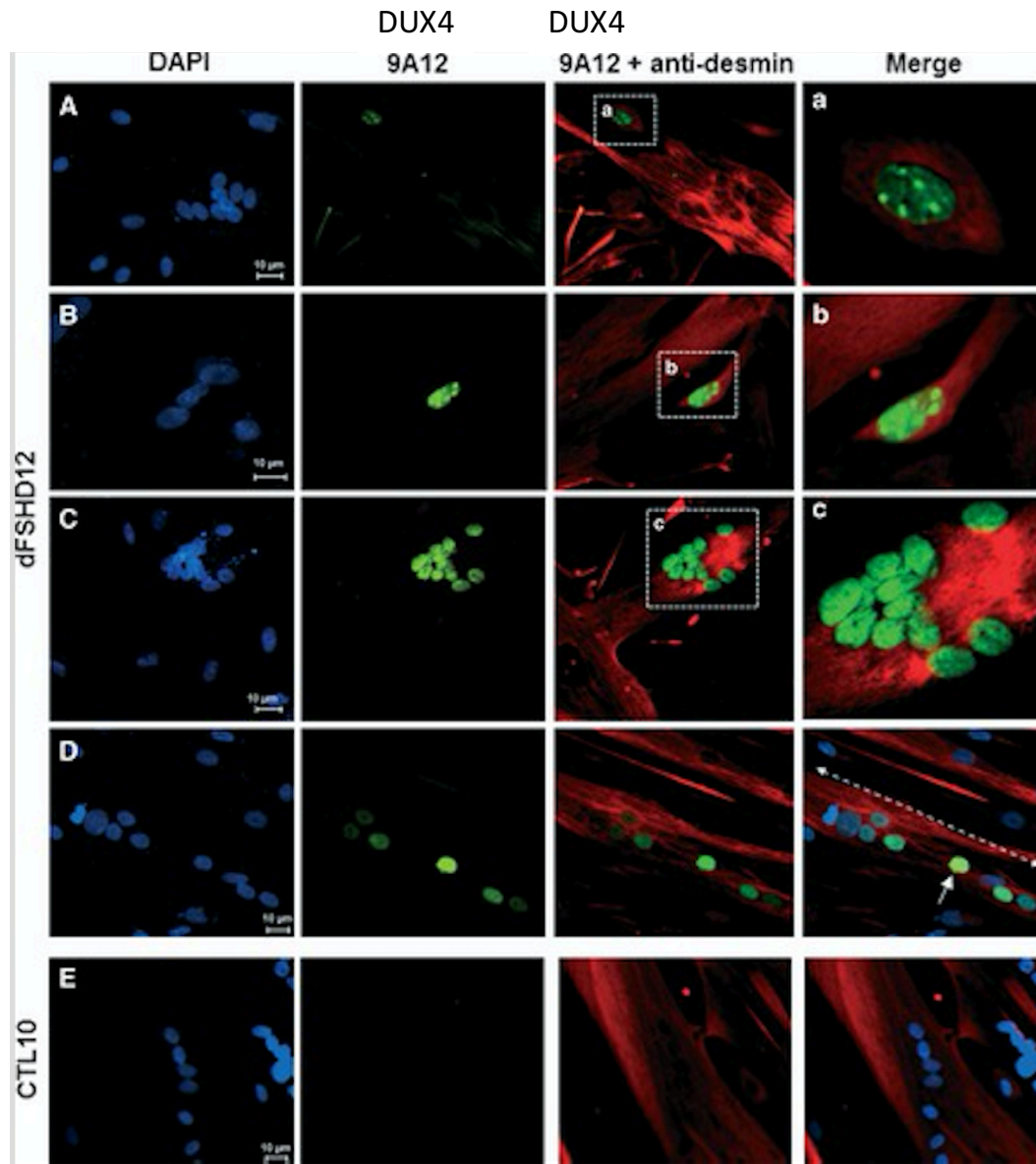

DUX4 expression:

- DUX4 is a TF that contains homeobox domains (HD1, HD2)
- Transcription factor
- Interferes with muscle differentiation
- Impairs muscle for muscle regeneration
- wasting

DUX4 is expressed in facioscapulohumeral muscular dystrophy (FSHD) myoblasts and in consecutive nuclei in FSHD myotubes. Co-immunofluorescence with MAAb 9A12 = DUX4 (green) and a rabbit serum directed against desmin = muscle marker (red) on FSHD (dFSHD12) and control (CTL10) primary myotubes, 5 days after the induction of differentiation. a, b and c correspond to enlarged fields from the left boxes. Arrows indicate the most stained nuclei and the dotted arrows the intensity gradient of the DUX4 staining (D: merge panel). DAPI (blue) was used to visualize nuclei.

The transcriptional cascade caused by DUX4 in FSDH

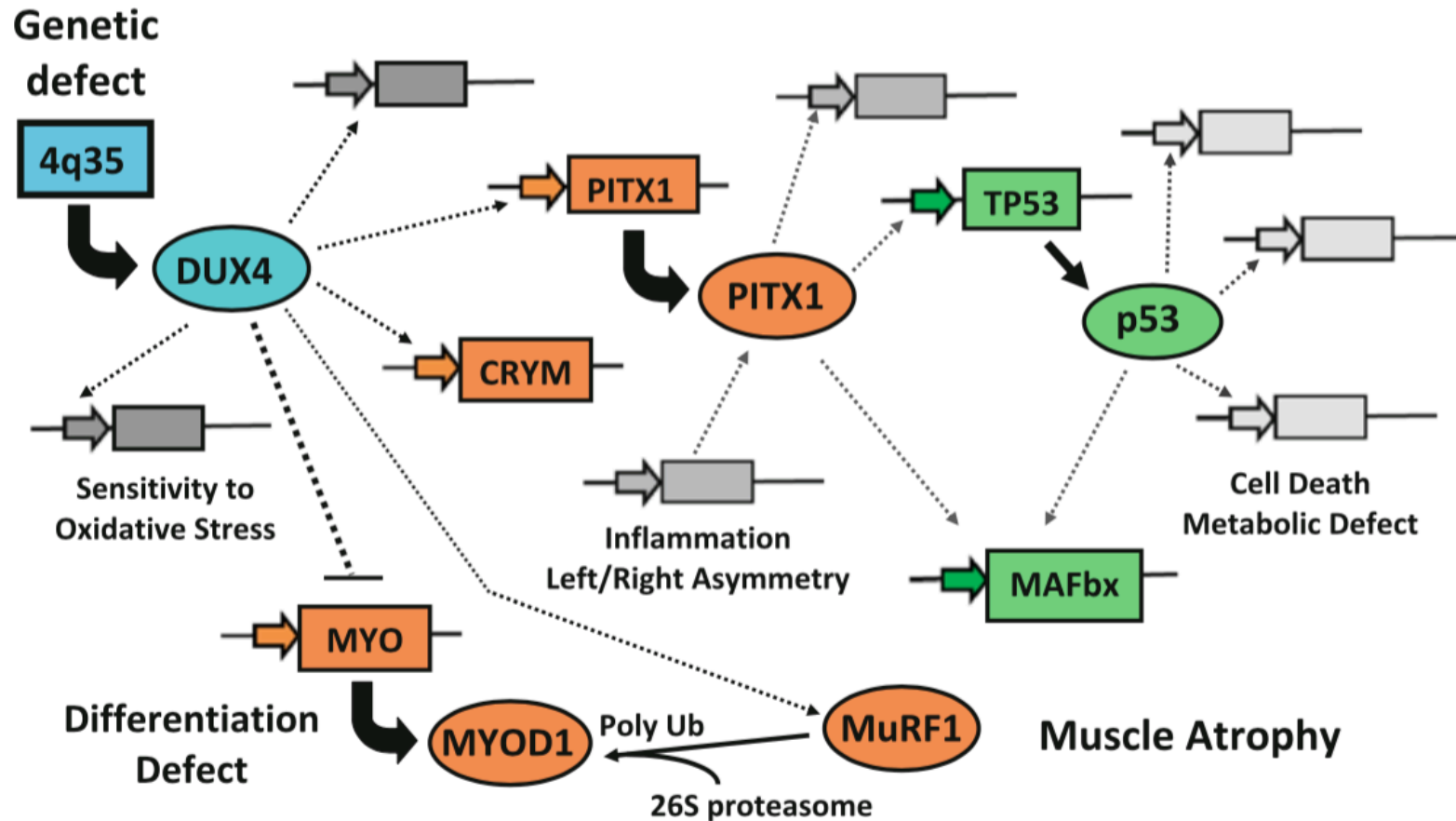

A transcription dysregulation cascade in FSDH. The DUX4 gene mapped in the D4Z4 repeated element at 4q35 is activated either by the pathogenic deletion that contracts the repeat array, or by another uncharacterized mutation that leads to chromatin opening of normal sized repeat arrays. The chromatin changes allow transcription of the DUX4 gene. On permissive alleles that carry the poly-A signal in the pLAM region this results in a stable mRNA that can be translated. The expressed DUX4 protein is a transcription factor that may directly or indirectly interact with a set of target genes. Among those, DUX4 expression results in the inhibition of the MyoD gene which encodes the transcription master switch of muscle differentiation thus **causing inhibition of the MyoD target genes in FSDH**. DUX4 over-expression also **inhibits the expression of genes involved in response to oxidative stress**, and probably inducing the Icrystallin (CRYM) gene whose promoter carries a DUX4 binding site. A direct DUX4 target gene is PITX1 at 5q31 which encodes a transcription factor that is the **master switch for hindlimb** development in embryogenesis. PITX1 is specifically induced in FSDH muscles as compared to 11 neuromuscular disorders; it induces E3 ubiquitin ligase which is linked to atrophy in adult skeletal muscles and is involved in inflammation. Among the PITX1 target genes is TP53 which has major roles in the control of DNA repair, cell cycling and apoptosis as well as in multiple levels of cell metabolism and muscle atrophy.

FSDH impairs muscle cell function

Moreover, in patients affected with FSHD, it is quite common to observe the co-existence of affected and apparently healthy muscles. Myoblasts, which were obtained from muscle typically affected in FSHD, manifested an increased susceptibility to oxidative stress during proliferation. Myotubes obtained from patient/healthy myoblasts show abnormal morphology and muscle marker expression

Anti **actin/tubulin** immunostaining of myotubes obtained by differentiating myoblasts cells isolated from healthy or FSHD patients

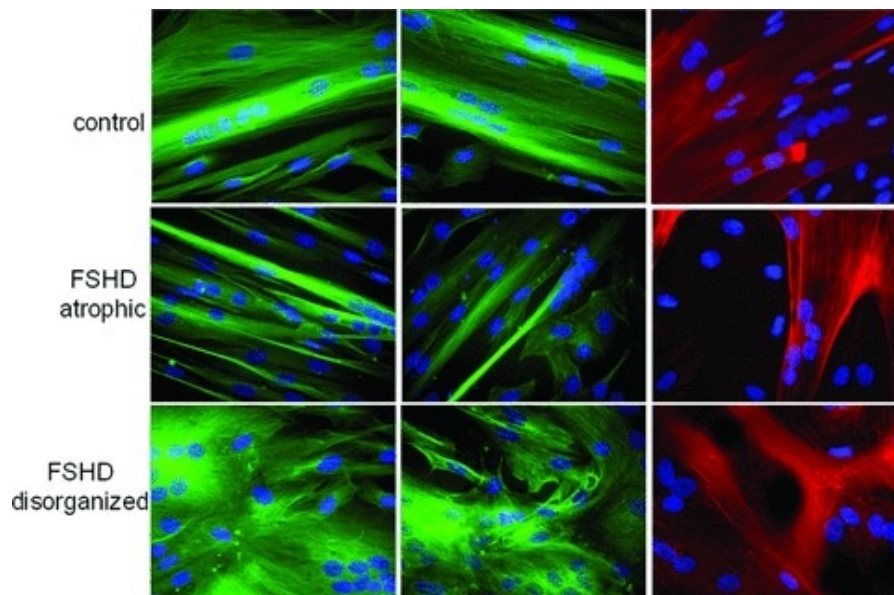

anti-**troponinT** immunostaining of myotubes obtained by differentiating myoblasts cells isolated from healthy or FSHD patients

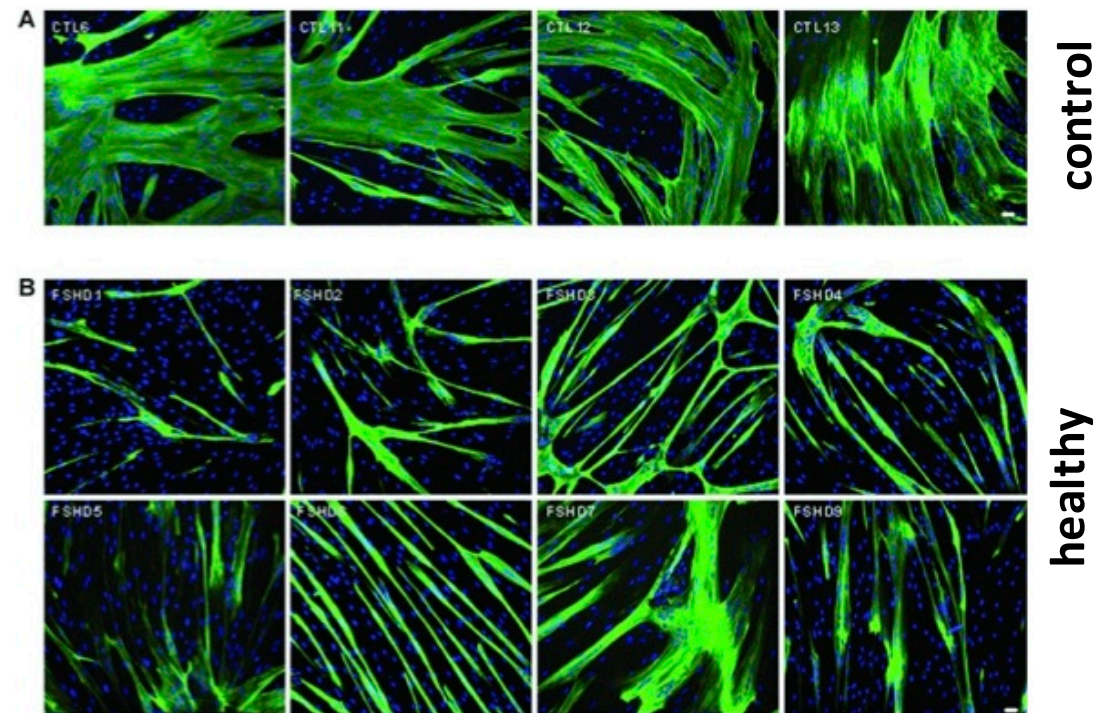

A Long ncRNA Links Copy Number Variation to a Polycomb/Trithorax Epigenetic Switch in FSHD Muscular Dystrophy

Daphne S. Cebianca,¹ Valentina Casa,^{1,2} Beatrice Bodega,^{3,5} Alexandros Xynos,¹ Enrico Ginelli,³ Yujiro Tanaka,⁴ and Davide Gabellini^{1,*}

¹Dulbecco Telethon Institute at San Raffaele Scientific Institute, Division of Regenerative Medicine, Stem Cells, and Gene Therapy, 20132 Milan, Italy

²Università Vita-Salute San Raffaele, 20132 Milan, Italy

³Department of Biology and Genetics for Medical Sciences, University of Milan, 20133 Milan, Italy

⁴Genome Structure and Regulation, School of Biomedical Science and Biochemical Genetics, Medical Research Institute, Tokyo Medical and Dental University, Tokyo 113-8510, Japan

⁵Present address: Dulbecco Telethon Institute at Fondazione Santa Lucia, 00143 Rome, Italy

*Correspondence: gabellini.davide@hsr.it

DOI [10.1016/j.cell.2012.03.035](https://doi.org/10.1016/j.cell.2012.03.035)

HETEROCHROMATIN AT D4Z4 REPEATS SILENCES LOCAL GENE EXPRESSION

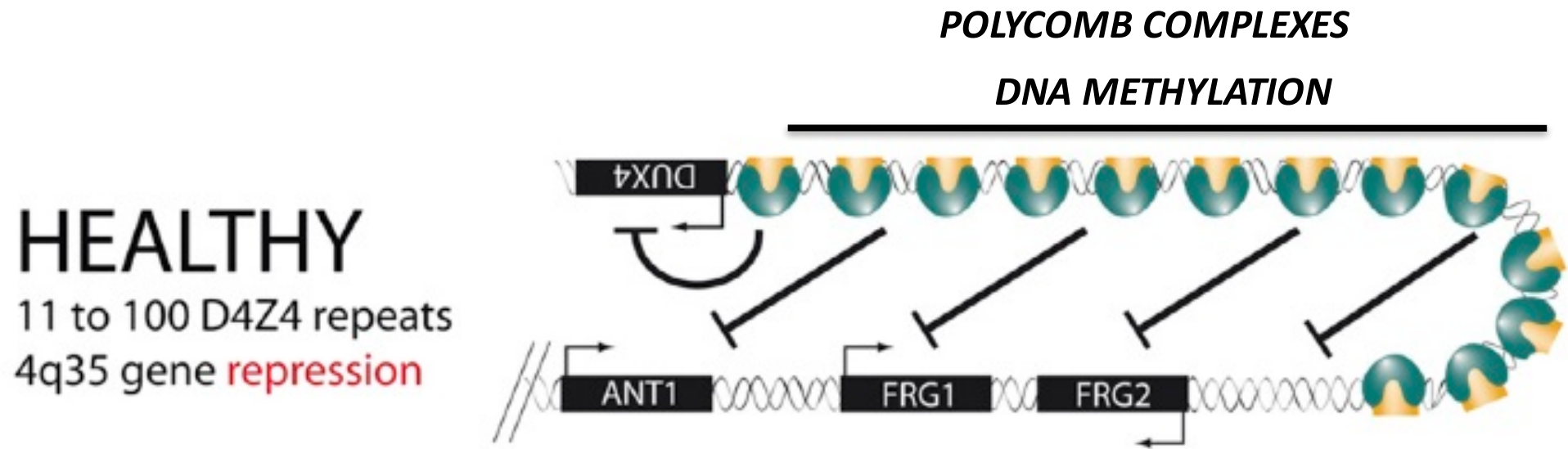

Formation of a loop structure that supports silencing of DUX4, ANT1, FRG1, FRG2

D4Z4 repeats in Chr. 4q subtelomeres give rise to various transcripts

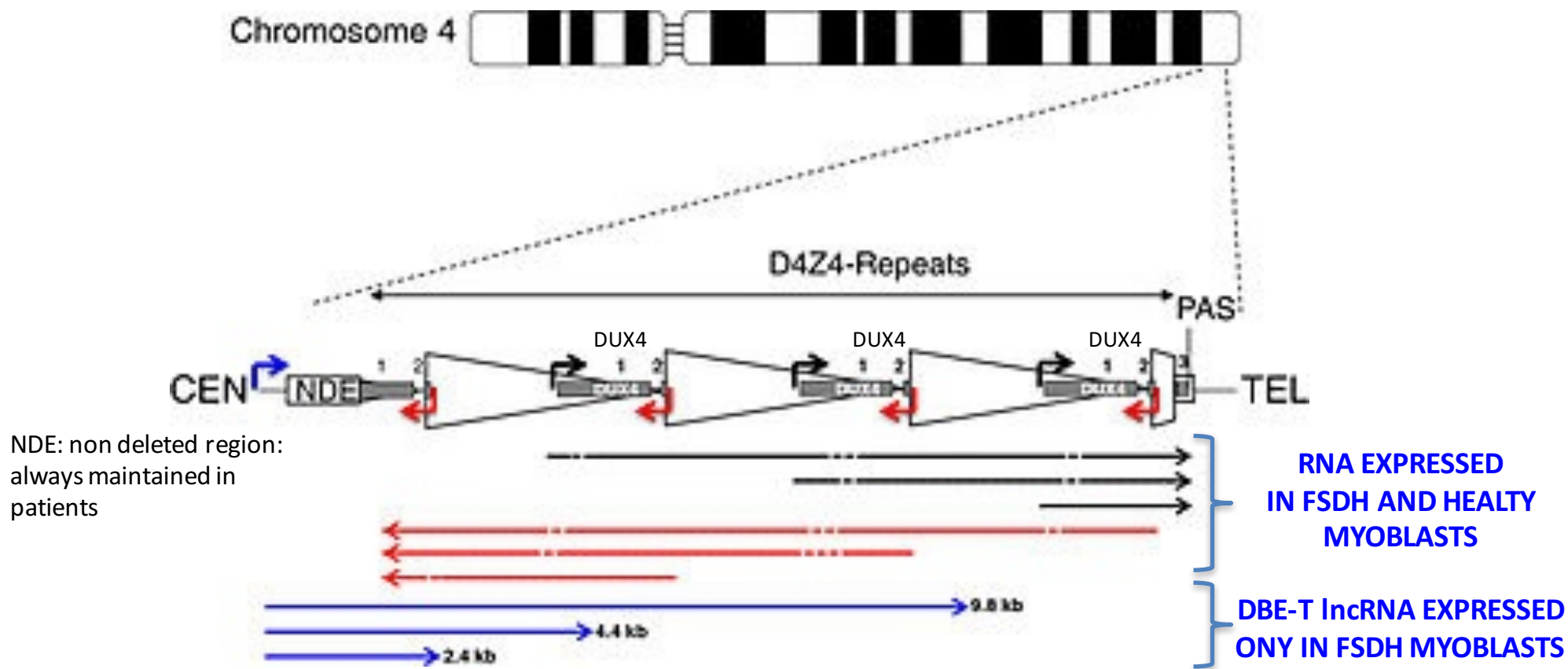

A schematic of D4Z4 locus on chromosome 4: The D4Z4 locus is in the sub-telomeric region of 4q. The figure shows a three repeat D4Z4 array. CEN indicates the centromeric end and TEL indicates the telomeric end. The DUX4 gene is shown as a gray rectangle with exon 1 and exon 2 in each repeat and exon 3 in the pLAM region telomeric to the last partial repeat (numbered 1, 2, and 3). PAS indicates the polyadenylation site on the permissive 4qA allele that is not present on the non-permissive 4qB allele or on chromosome 10. The arrowed lines represent: Blue, DBE-T transcripts (2.4, 4.4, and 9.8 kb) found in FSHD cells and reported to de-repress DUX4 expression; Black and red, transcripts in the sense and antisense direction were detected in both FSHD and control cells and might originate from the mapped sense promoters (black) and anti-sense promoters (red) with dashed lines indicating areas that might be degraded or produce si-like small RNAs. NDE, non-deleted element identified as the transcription start site for the DBE-T transcripts. Always present in patient DNA.

IS SILENCING IMPAIRED IN FSDH PATIENTS??

PRC2 → H3K27me3

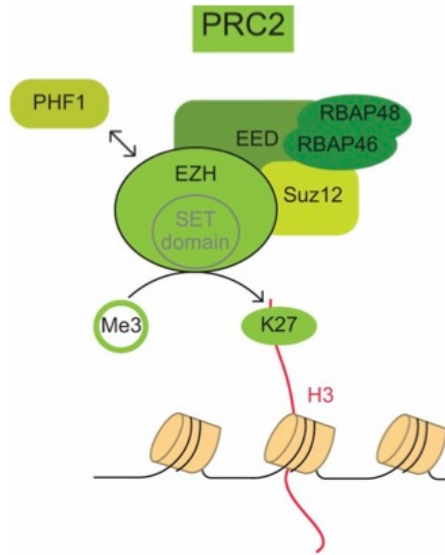

POLYCOMB COMPLEX 2

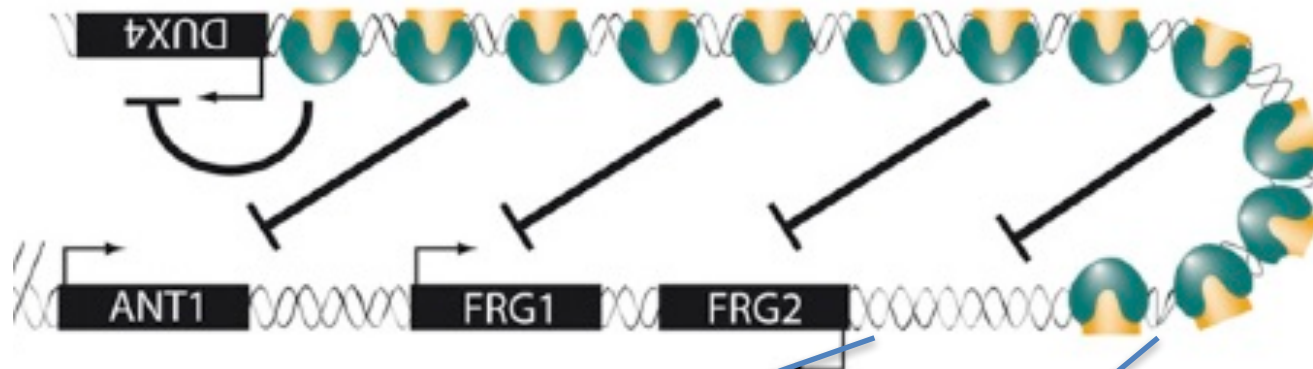

A

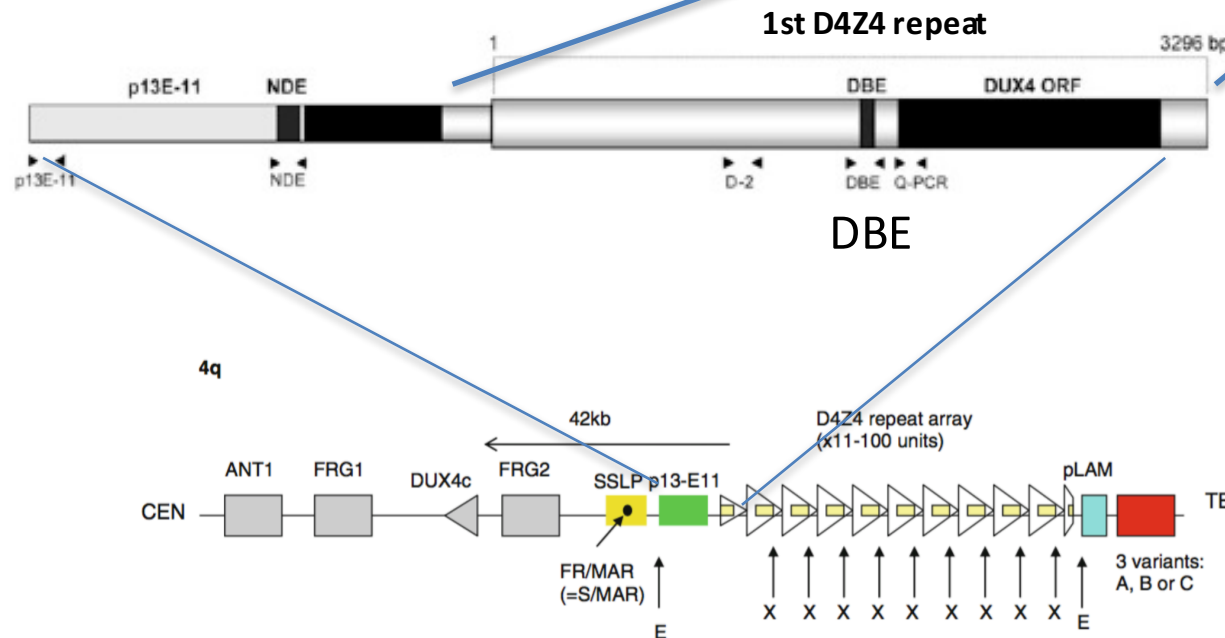

DBE (D4Z4 binding element), a region necessary and sufficient to confer copy-number-dependent repressive activity due to its ability to recruit YY1, EZH2, and HMGB2 (human homologs of the *Drosophila* PcG proteins Pho and E(z) and the PcG recruiter Dsp1, respectively)

IS SILENCING IMPAIRED IN FSDH PATIENTS??

CHEMICALLY CROSSLINKED CHROMATIN ISOLATED FROM

- a. Patient primary muscle cells
- b. Normal primary muscle cells

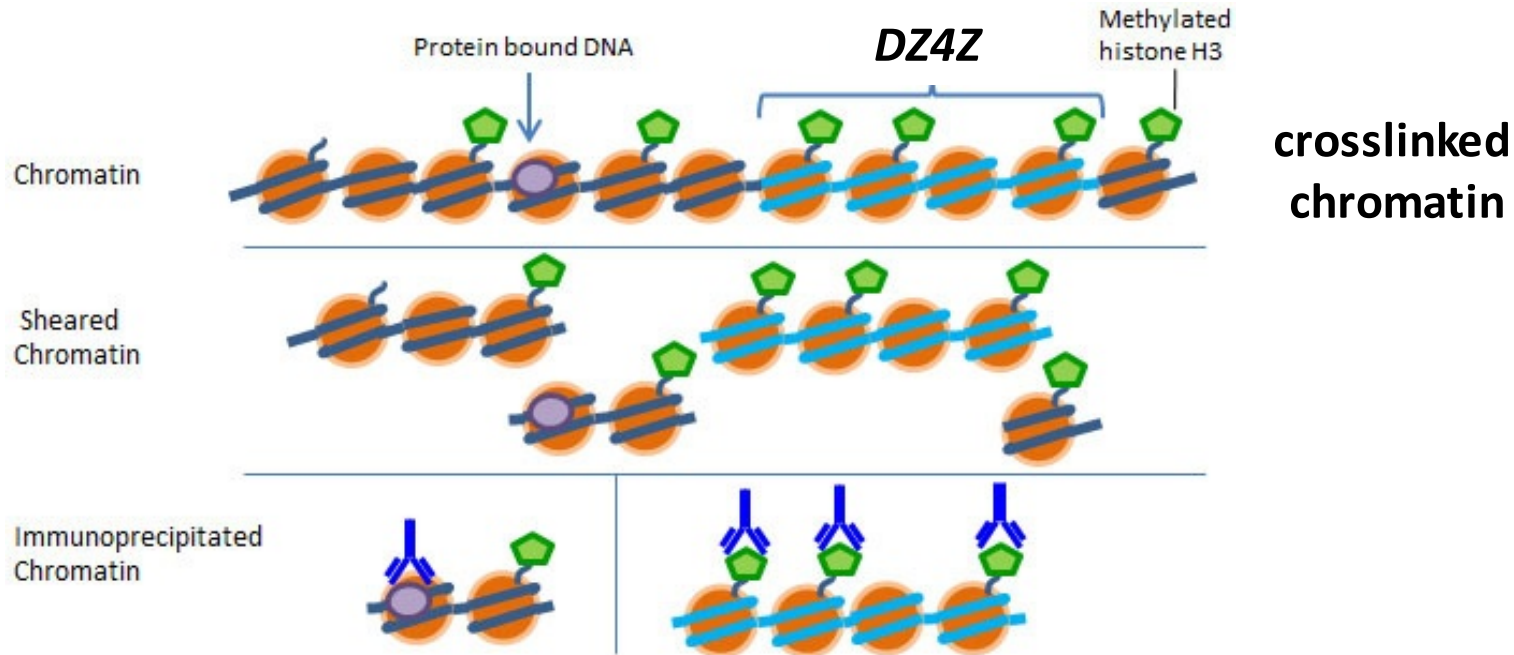

Precipitate-Ab-Chromatin complex with beads that bind heavy chain of antibody



Make PCR with primers that amplify specific regions in D4Z4 repeats

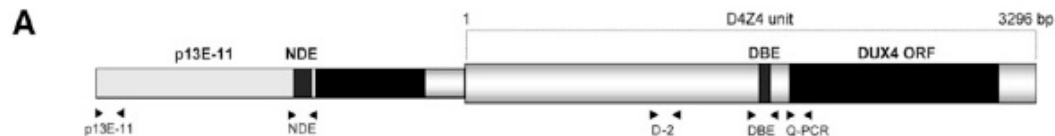

FSDH IS LINKED WITH LOSS OF PRC2 FUNCTION AT DZ4Z REPEATS

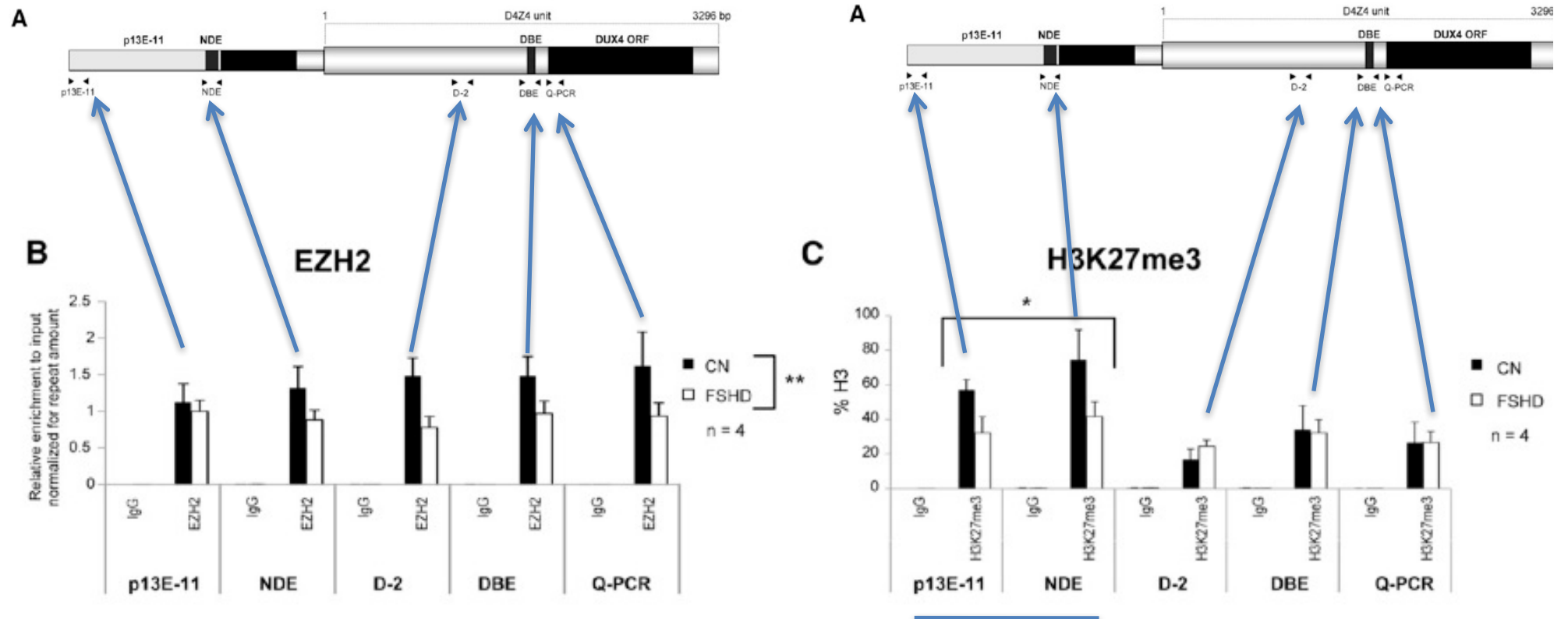

D4Z4 repeats in Chr. 4q subtelomeres give rise to various transcripts

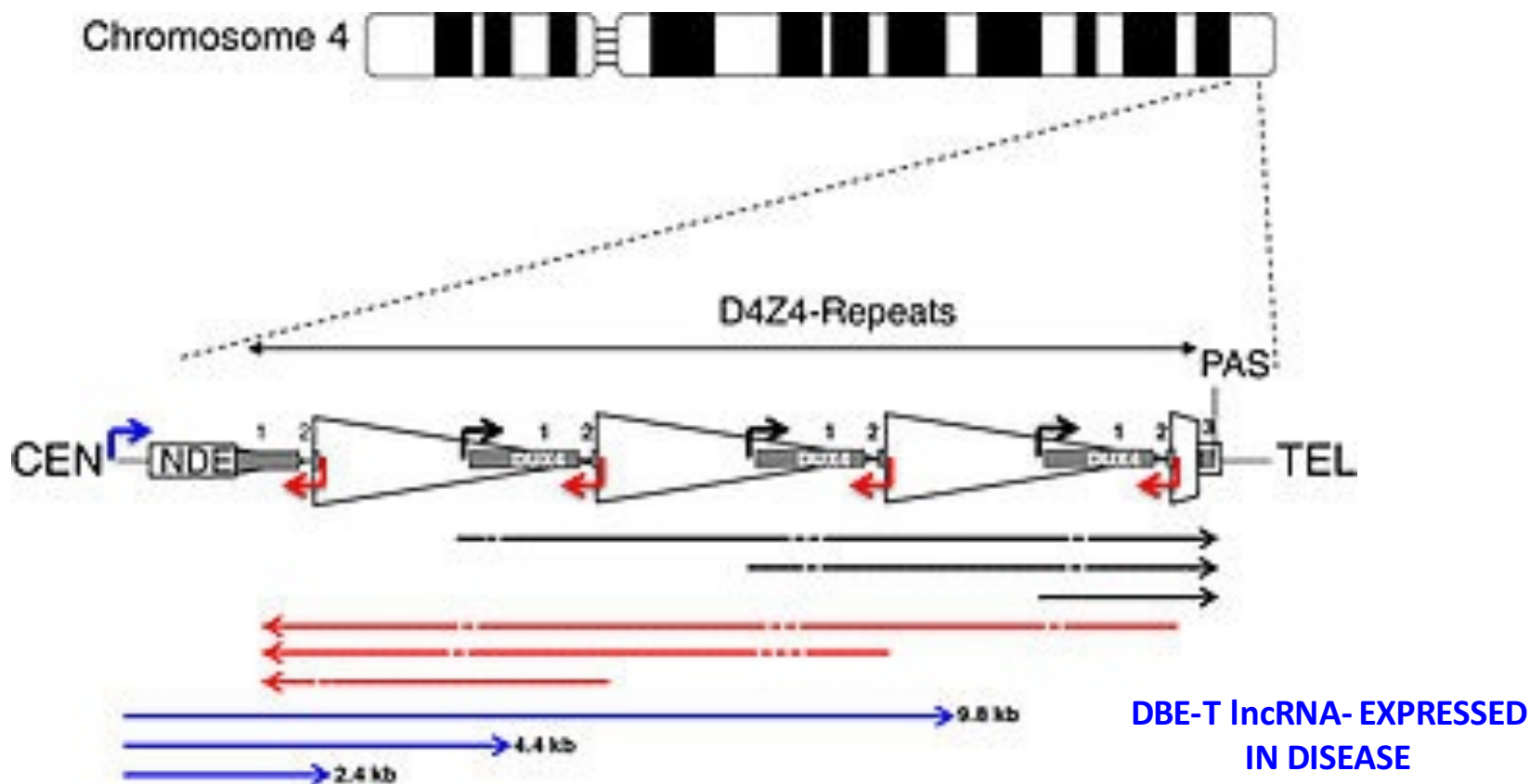

A schematic of D4Z4 locus on chromosome 4: The D4Z4 locus is in the sub-telomeric region of 4q. The figure shows a three repeat D4Z4 array. CEN indicates the centromeric end and TEL indicates the telomeric end. The DUX4 gene is shown as a gray rectangle with exon 1 and exon 2 in each repeat and exon 3 in the pLAM region telomeric to the last partial repeat (numbered 1, 2, and 3). PAS indicates the polyadenylation site on the permissive 4qA allele that is not present on the non-permissive 4qB allele or on chromosome 10. The arrowed lines represent: Blue, DBE-T transcripts (2.4, 4.4, and 9.8 kb) found in FSHD cells and reported to de-repress DUX4 expression; Black and red, transcripts in the sense and antisense direction were detected in both FSHD and control cells and might originate from the mapped sense promoters (black) and anti-sense promoters (red) with dashed lines indicating areas that might be degraded or produce si-like small RNAs. NDE, non-deleted element identified as the transcription start site for the DBE-T transcripts.

LOSS OF PRC2 FUNCTION INCREASES ANT1, FRG1, FRG2 and DUX4 EXPRESSION

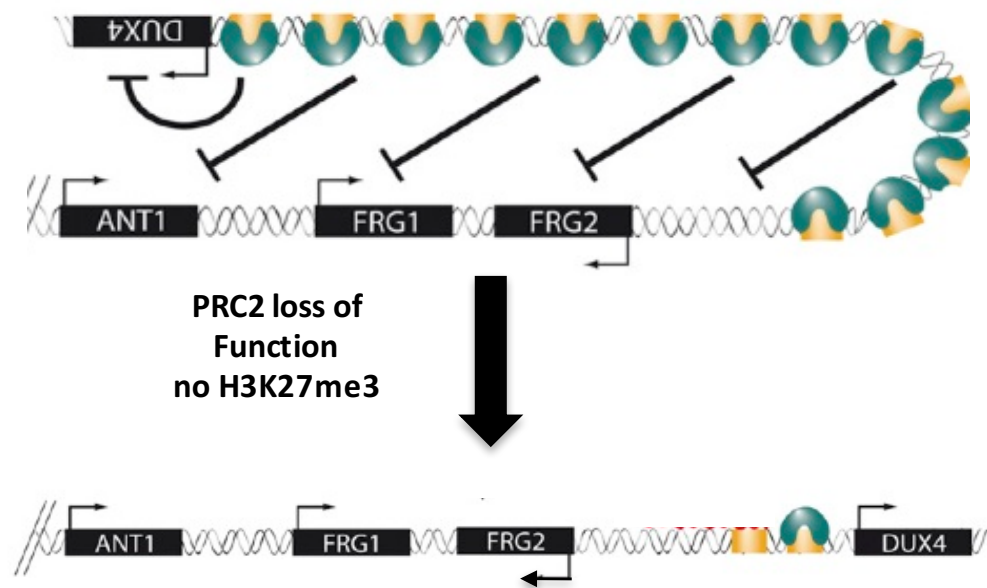
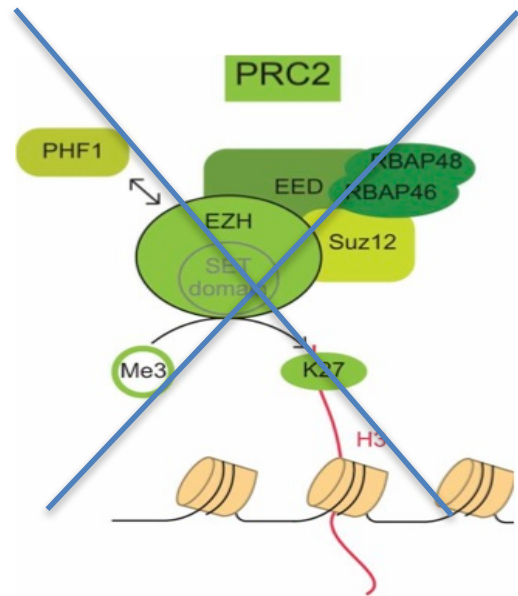
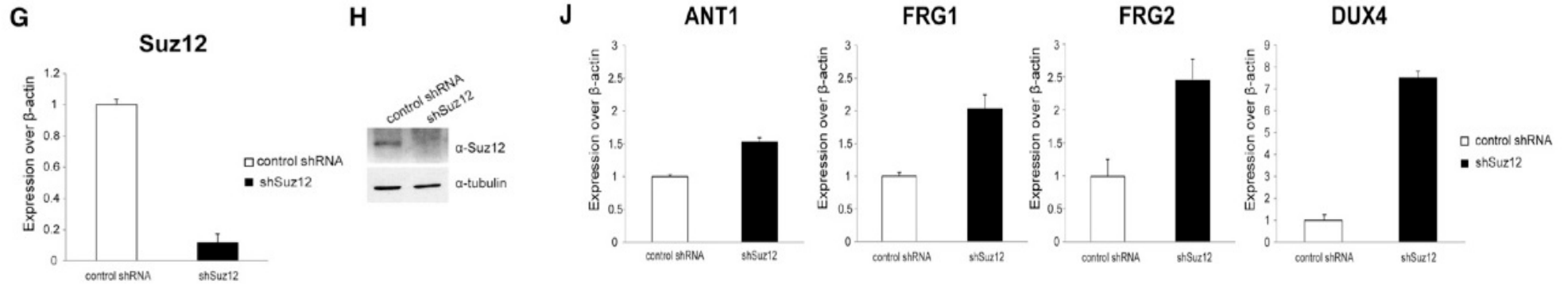

LOSS OF PRC2 FUNCTION CAUSES AN UPREGULATION OF A NOVEL lncRNA – DBE-T

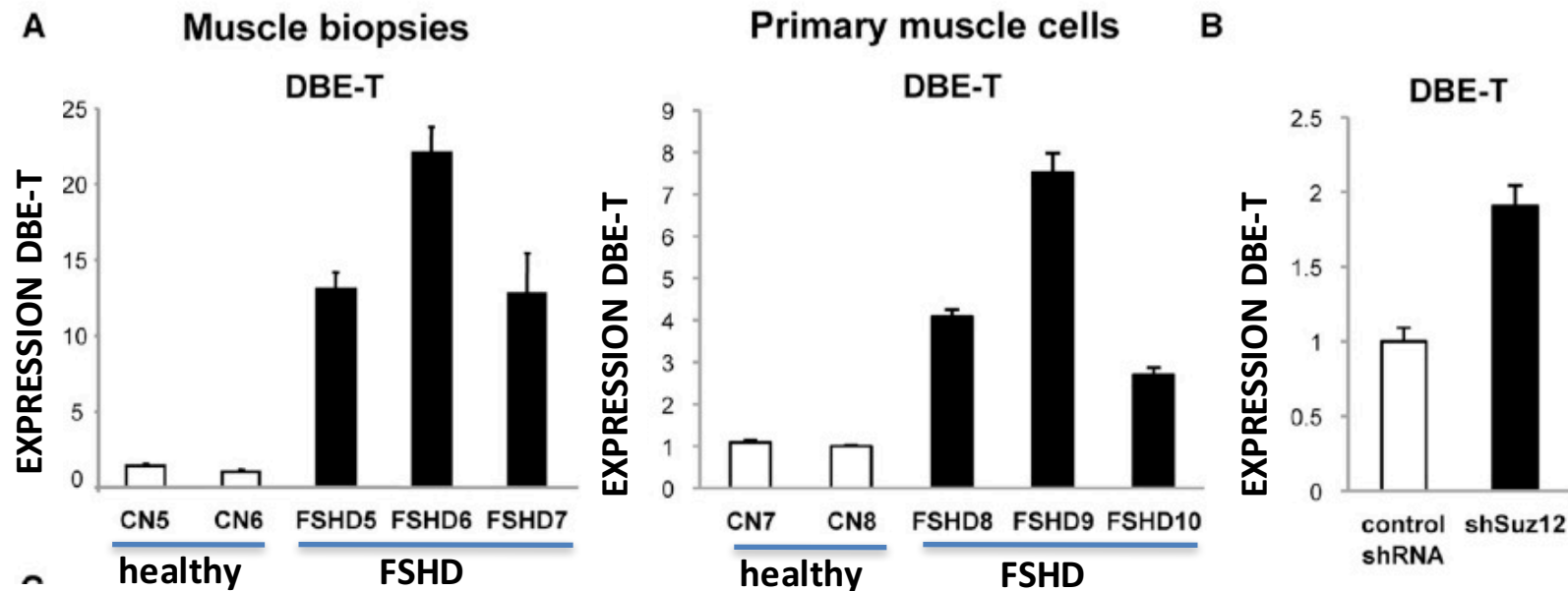
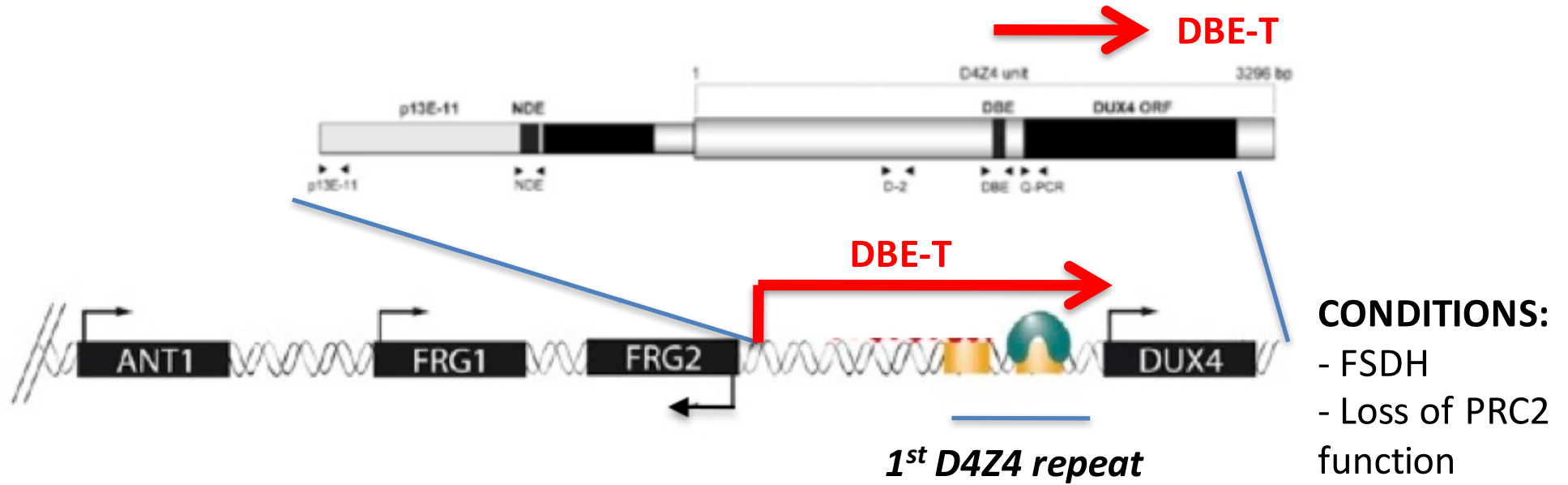

HOW TO SHOW D-BET lncRNA at chromosomes

Fuse ovary hamster cells with FSDH cells

→ Overcome poor proliferation of FSDH cells
→ allows to study FSHD Chr4 in a replicating cell model

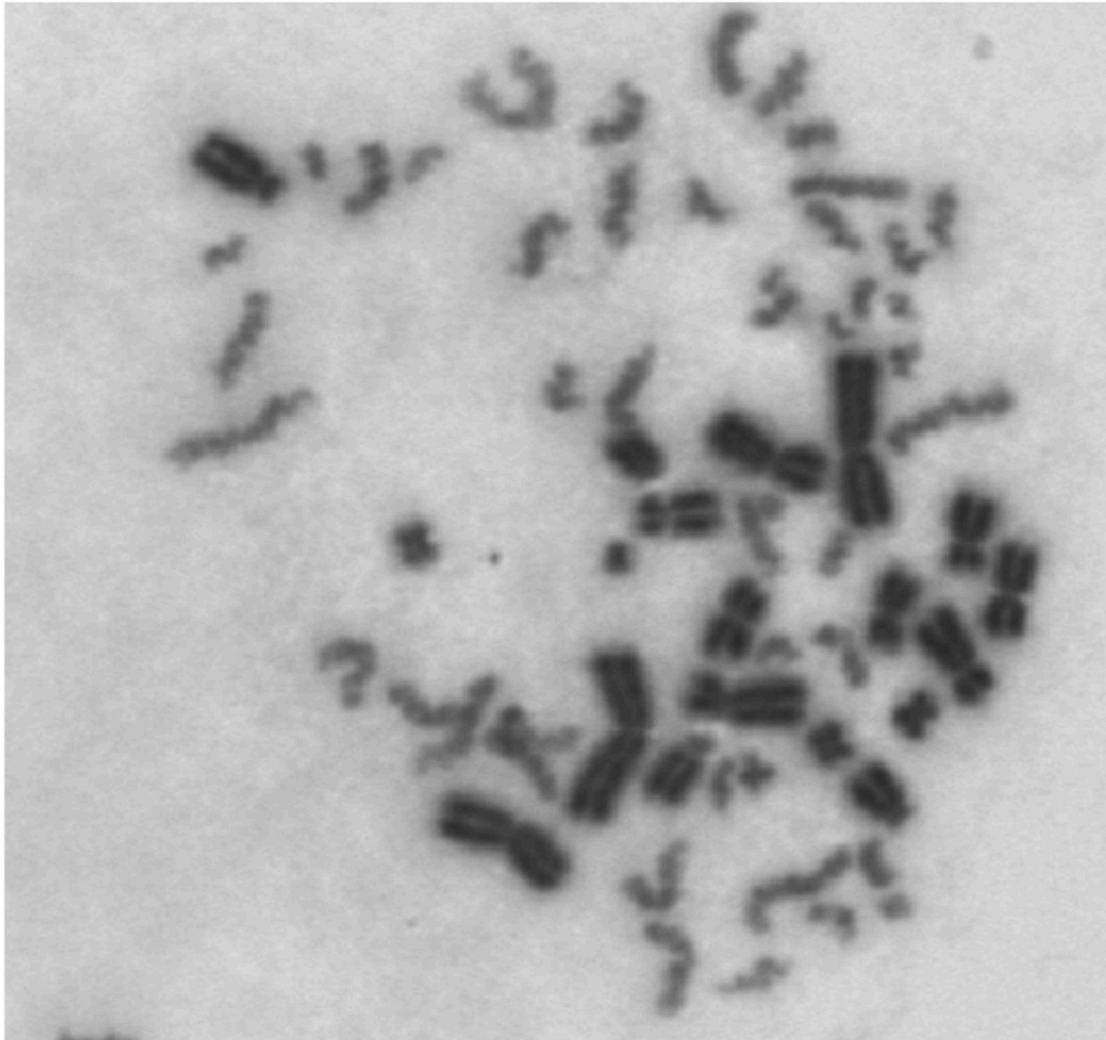

Fusion of a mitotic Chinese hamster ovary cell (large, dark stained chromosomes with visible double chromatids) with an interphase human lymphocyte (smaller, less brightly stained chromosomes).

DBE-T IncRNA COLOCALIZES TO D4Z4 REPEATS

Fuse diseased human cell with hamster cell lines and select cell fusion product that carries human D4Z4 repeats

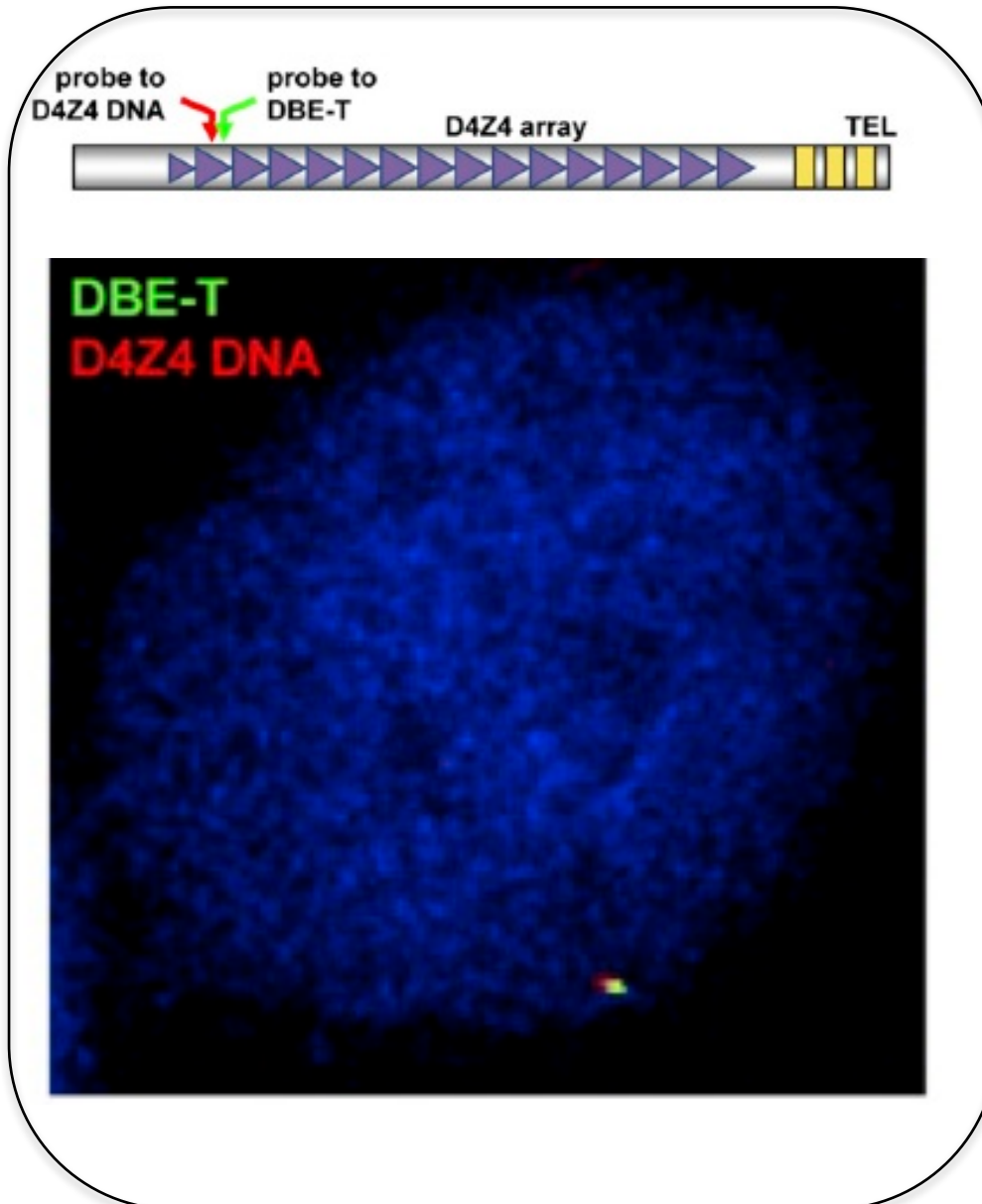

COMBINED DBE-T RNA-FISH AND D4Z4 DNA FISH

1. FIX CELLS
2. HYBRIDIZE A DBE-T PROBE (fluorescently labelled green)
3. CAPTURE IMAGE WITH MICROSCOP
4. Start next staining (DNA-FISH)
5. WASH
6. DENATURE DNA (HEAT)
7. HYBRIDIZE D4Z4 PROBE (fluorescently labelled – red)
8. CAPTURE IMAGE
9. Merge IMAGES

Fluorescence in situ hybridization

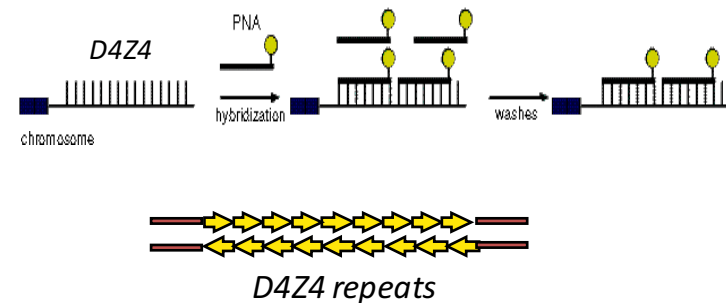

THE HMTase Ash1L localizes to DZ4Z REPEATS

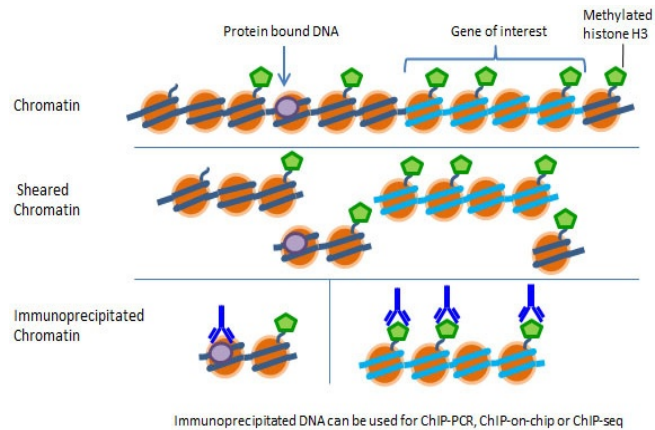

Ash1L: Histone methyltransferase
 → H3K4me3 **ACTIVATES**
 → H3K36m2 **TRANSCRIPTION**

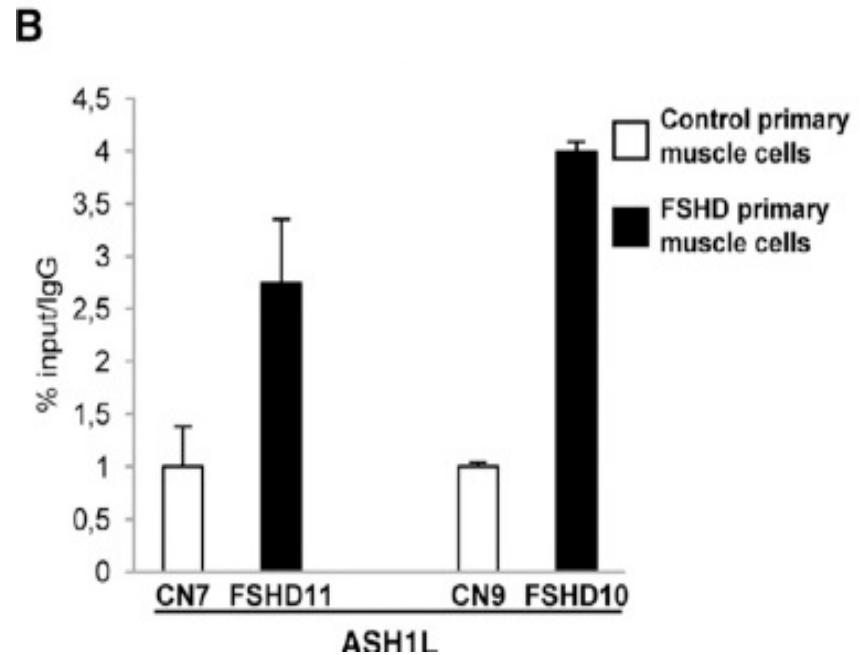

Loss of Ash1L decreases the expression of genes close to D4Z4 repeats

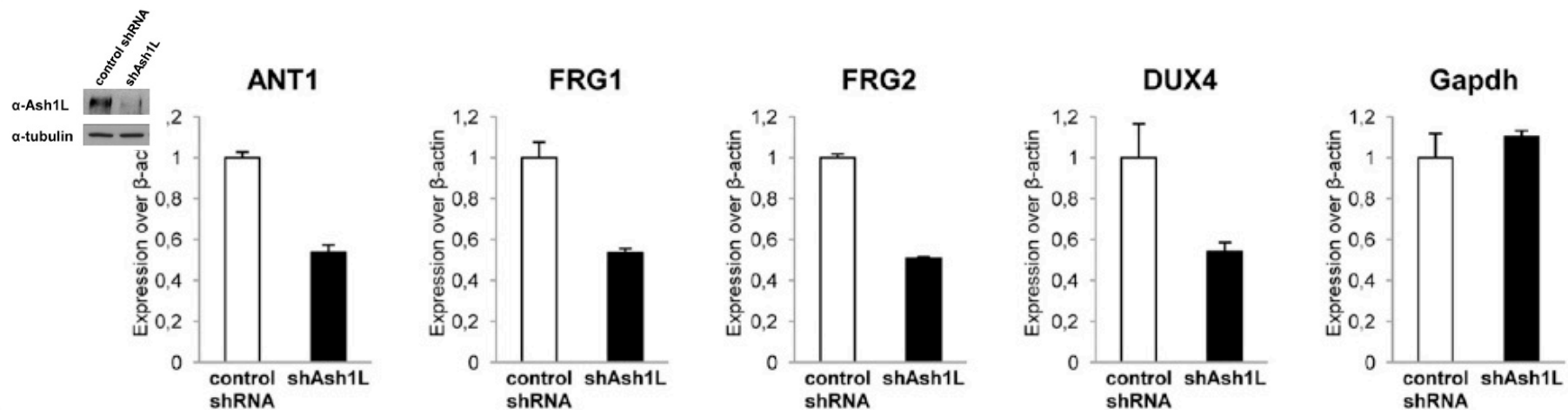

Ash1L shRNA experiments

DBE-T INTERACTS WITH Ash1L

Bead+anti-Ash1L antibody

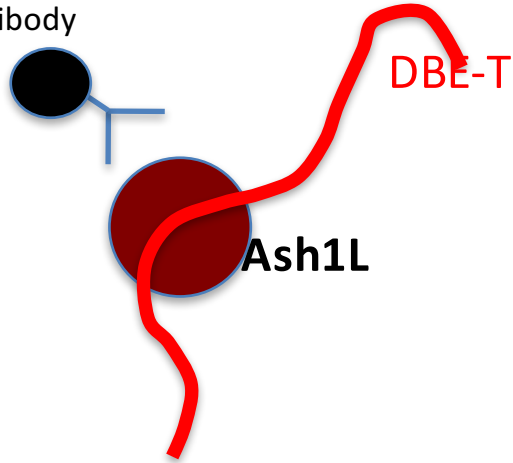

RNA-immunoprecipitation

↓
Elute bound RNA

↓
Reverse transcription

↓
PCR specific for DBE-T and control RNAs (pre-miR19; U1 snRNA)

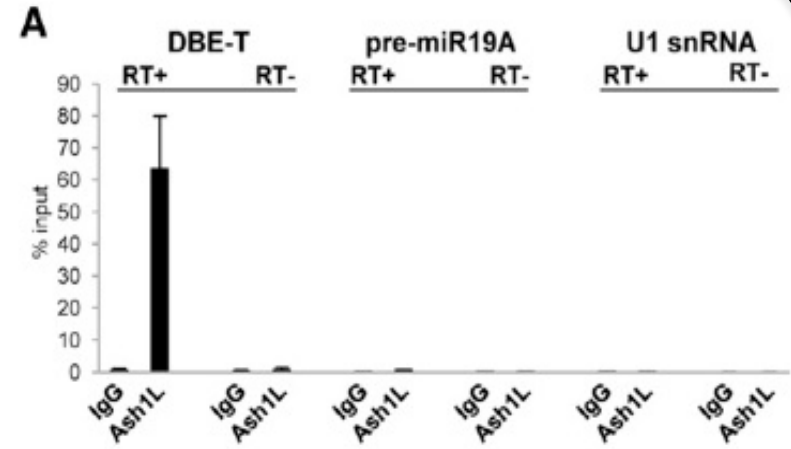

DBE-T BRINGS Ash1L TO D4Z4 REPEATS

ChIP using anti-Ash1L antibodies

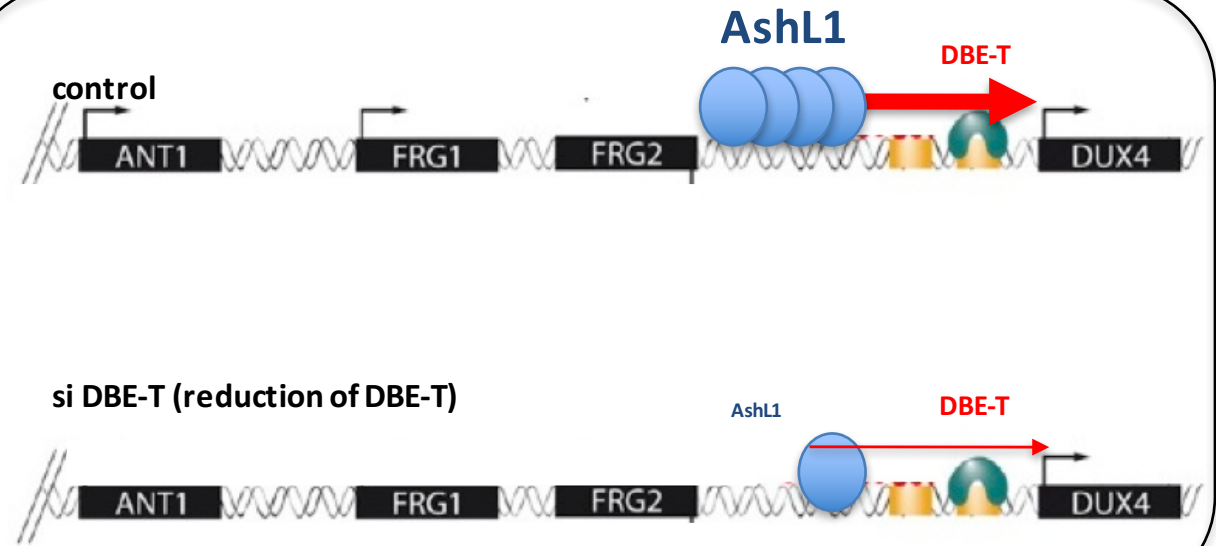
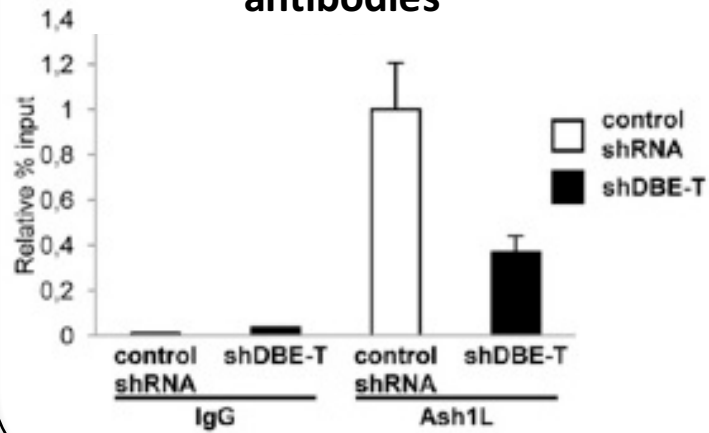

Loss of DBE-T results in increased expression of D4Z4 neighboring genes

Gene expression RT-PCR

control and si DBE-T (reduction of DBE-T)

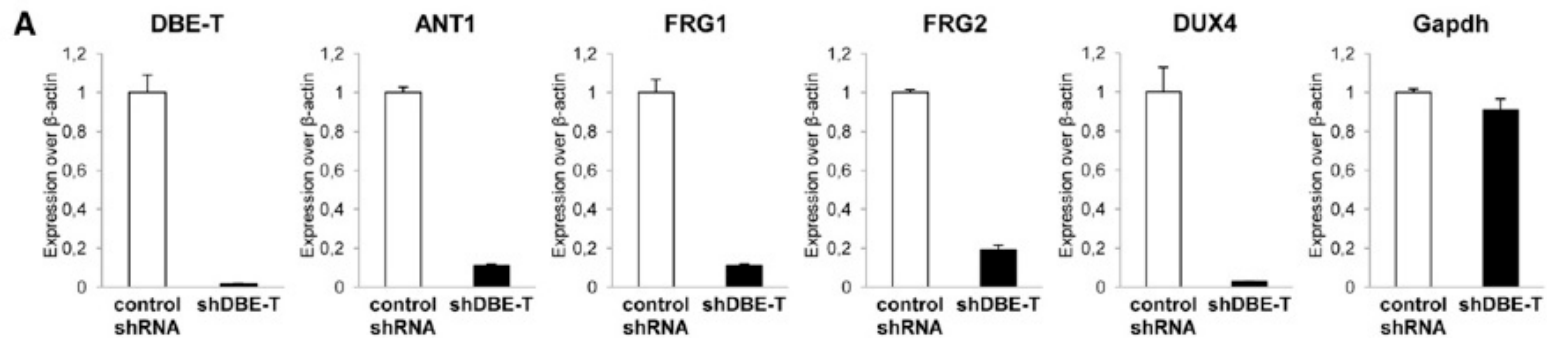

A lincRNA IS USED TO TRANSMIT D4Z4 REPEAT NUMBER INTO A DISEAS RELEVANT MECHANISM

HEALTHY

11 to 100 D4Z4 repeats
4q35 gene **repression**

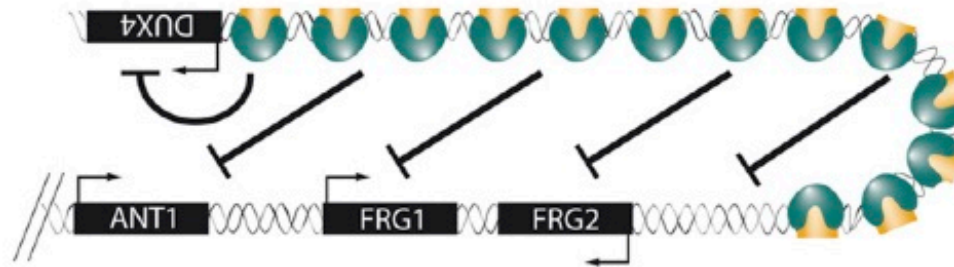

DBE

PcG

ASH1L

ncRNA production



ASH1L recruitment



FSHD

4q35 gene **de-repression**

