

Università di Trieste
Dipartimento di Ingegneria e Architettura

Corso di
Problemi Strutturali dell'Edilizia Storica

ISOLAMENTO SISMICO E DISSIPAZIONE

Prof. Ing. Natalino Gattesco

SISTEMI DI ISOLAMENTO/DISSIPAZIONE

Per migliorare le prestazioni sismiche delle costruzioni, si possono utilizzare opportuni dispositivi:

Isolatori sismici

- *Isolatori in gomma naturale armata*
- *Isolatori a pendolo scorrevole*

Dissipatori energetici

- *Ad attrito*
- *Viscoelastici*
- *Ricentranti*

Spettro d'accelerazione di progetto

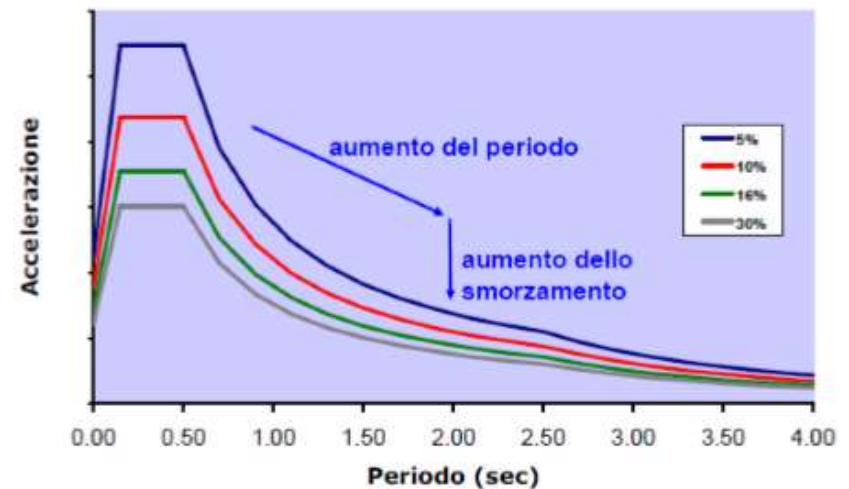

Spettro dello spostamento di progetto

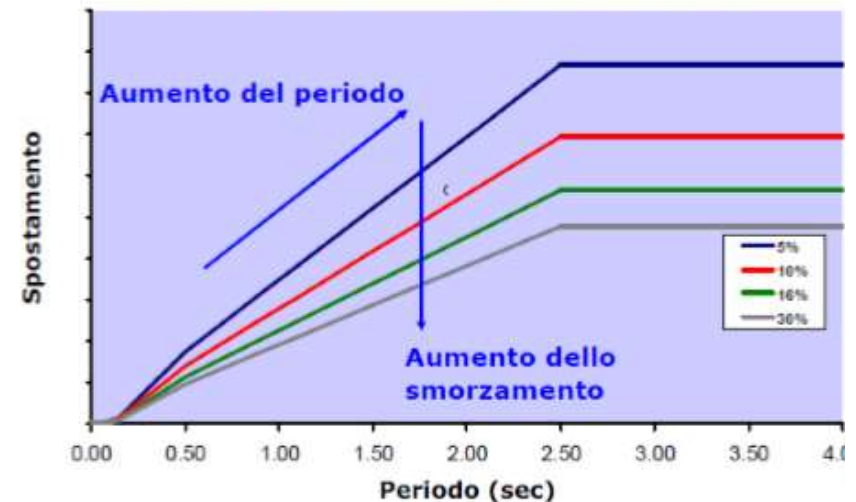

ISOLATORI IN GOMMA ARMATA

Edificio
convenzionale

$$F_{c2} \gg F_{c1}$$

Edificio
isolato

$$F_{i2} \cong F_{i1}$$

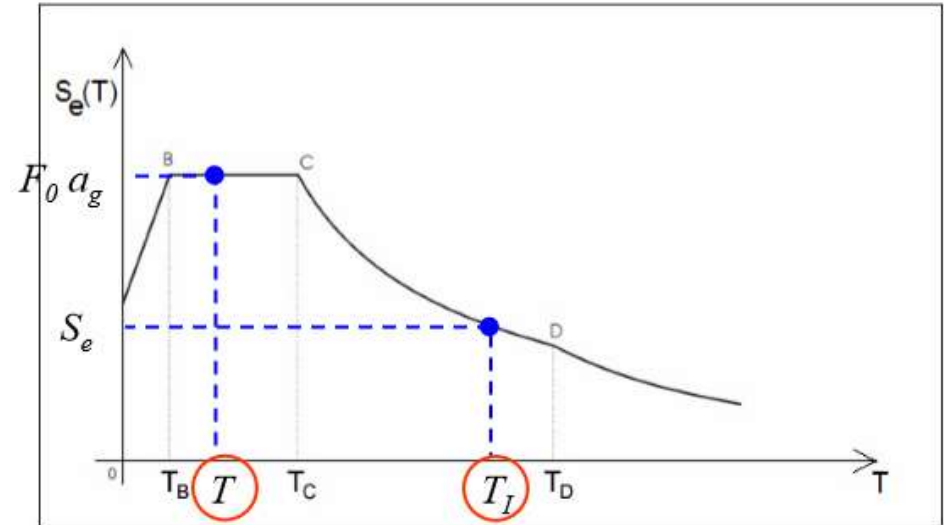
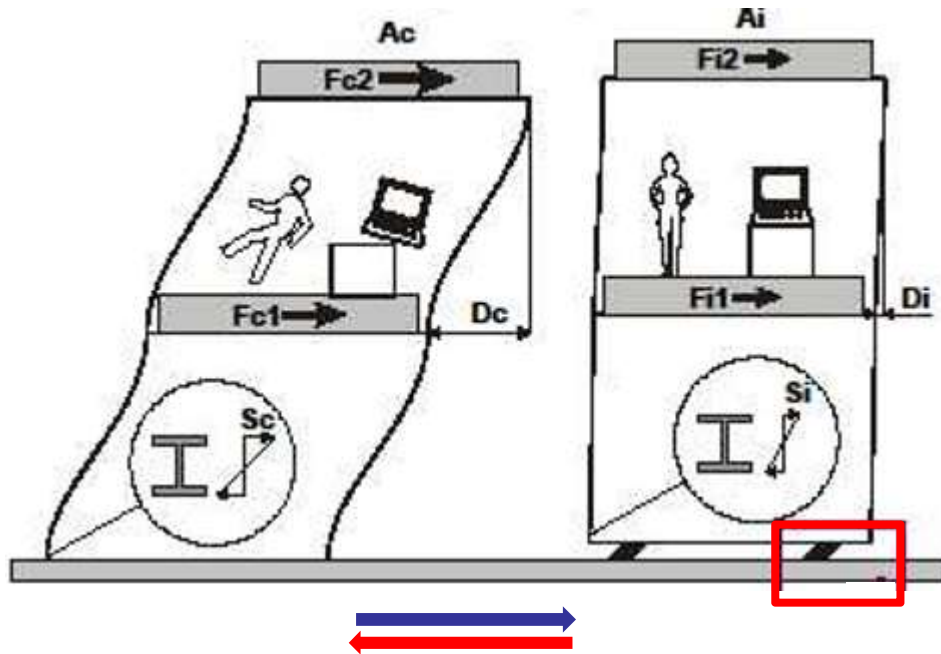

$$S_{a,c} \gg S_{a,i} \quad S_{d,c} \ll S_{d,i}$$

$$F_c \gg F_i \quad D_c \gg D_i$$

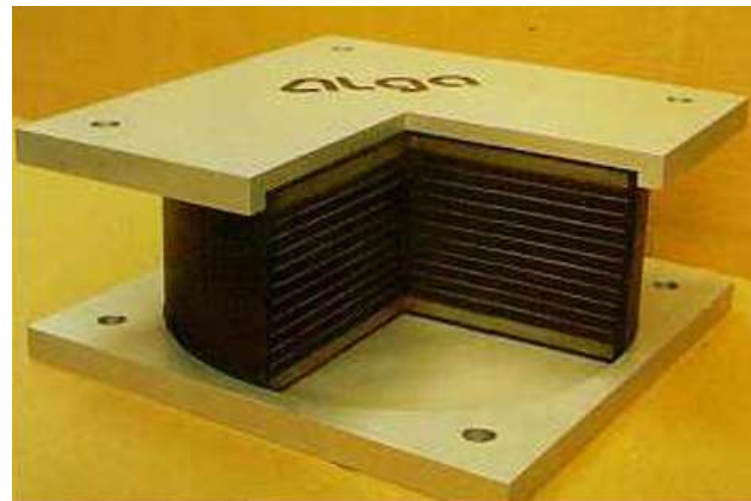

ISOLATORI IN GOMMA ARMATA

Isolamento edificio della Oiles GRP, Fujisawa, Giappone.

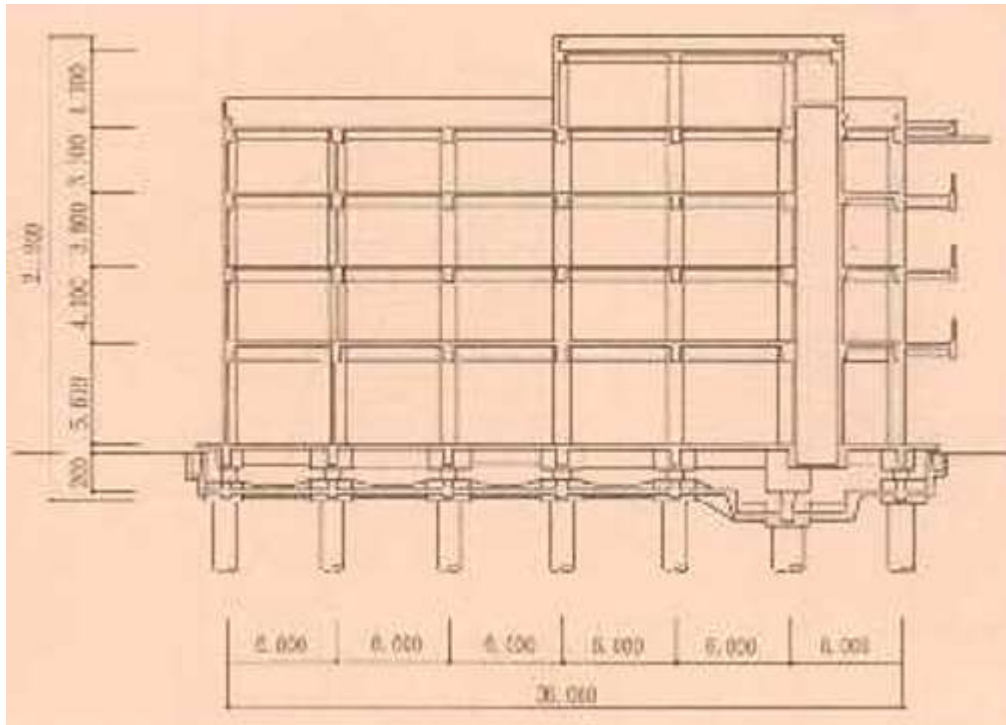

Devono essere facilitate:

- *Ispezionabilità, manutenzione, protezione, sostituzione*

ISOLATORI IN GOMMA ARMATA



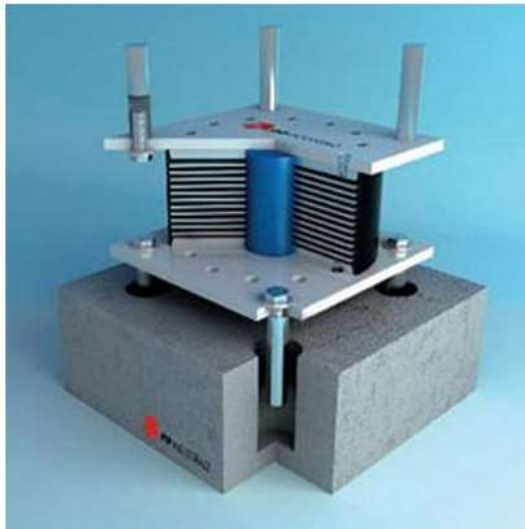

Isolatore in gomma
HDRB (High Damping Rubber Bearings)



Isolatore in gomma e piombo
LRB (Lead core Rubber Bearings)

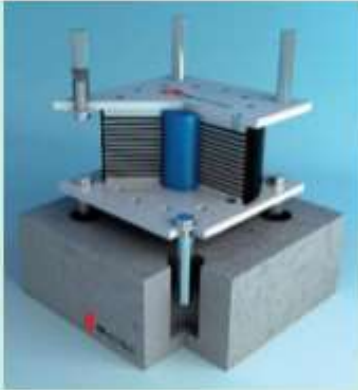

ISOLATORI IN GOMMA ARMATA

	LRB Lead core Rubber Bearings	HDRB High Damping Rubber Bearings	MLRB Multi layer Low damping Rubber Bearings
			
Coeff. di smorzamento viscoso equivalente	25 – 30%	10 – 16%	4%
Rigidezza orizzontale	Alta	Medio – Bassa	Medio - Bassa
Carico verticale	Alta	Alta	Alta
Oscillazione orizzontale	Medio - Alta	Alta	Media
Capacità di ricentraggio	Media	Alta	Alta

INTERVENTI CON ISOLATORI IN GOMMA

Scuola “Jovine” San Giuliano di Puglia



Crollo durante il sisma del 31 ottobre 2012

INTERVENTI CON ISOLATORI IN GOMMA

Nuova scuola "Jovine" San Giuliano di Puglia



**Nuova scuola ricostruita con
isolamento alla base.**

**Utilizzati 61 HDRB (diametri 600-700
mm)**



ISOLATORI A PENDOLO SCORREVOLE

L'attrito si oppone allo scorrimento e la gravità favorisce il ricentraggio, oltre a contribuire a contrastare lo slittamento.

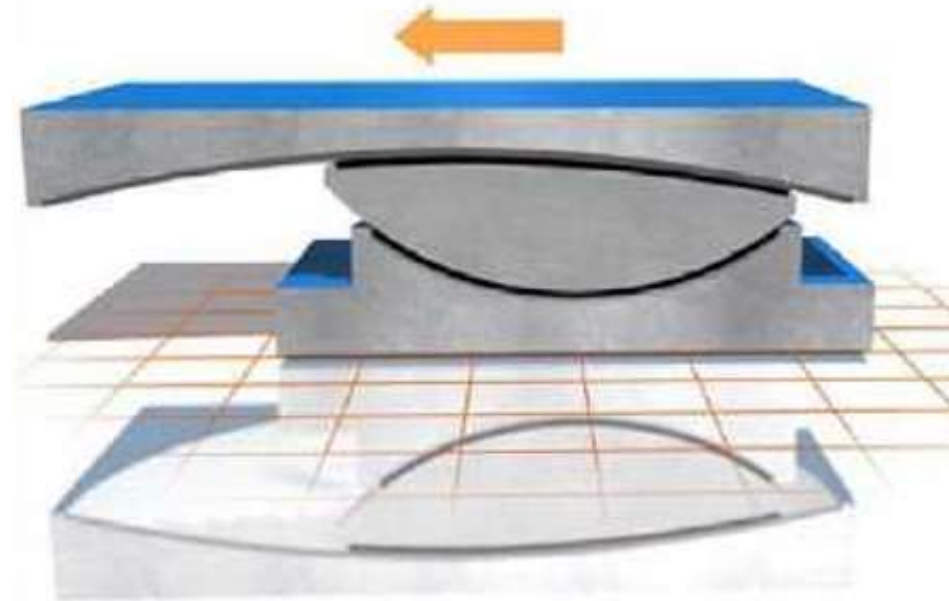

Isolatore a curvatura semplice

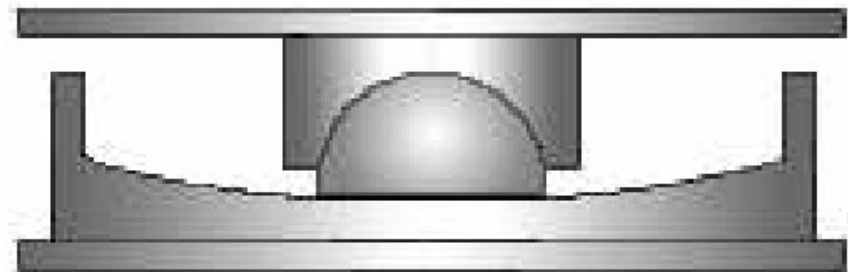

ISOLATORI A PENDOLO SCORREVOLE

Per slittare è necessario il sollevamento dell'edificio. La forza di richiamo dipende dall'angolo di rotazione φ .

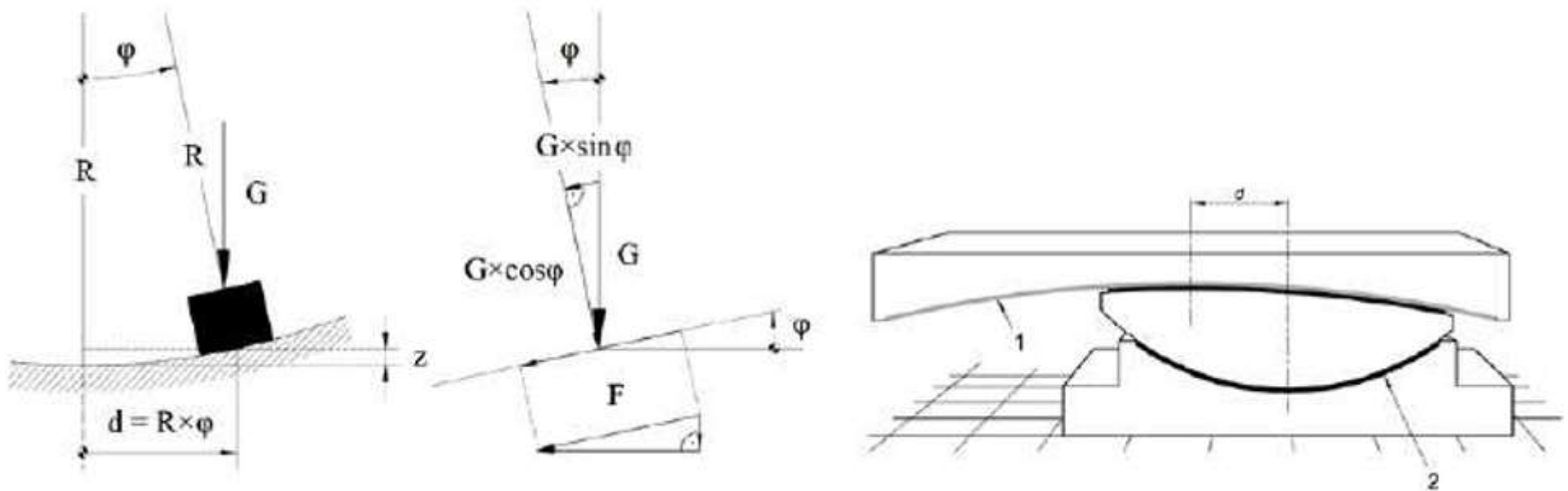

$$T = 2\pi \sqrt{\frac{R}{g}}$$

Periodo di vibrazione edificio isolato

ISOLATORI A PENDOLO SCORREVOLE



ISOLATORI A PENDOLO SCORREVOLE

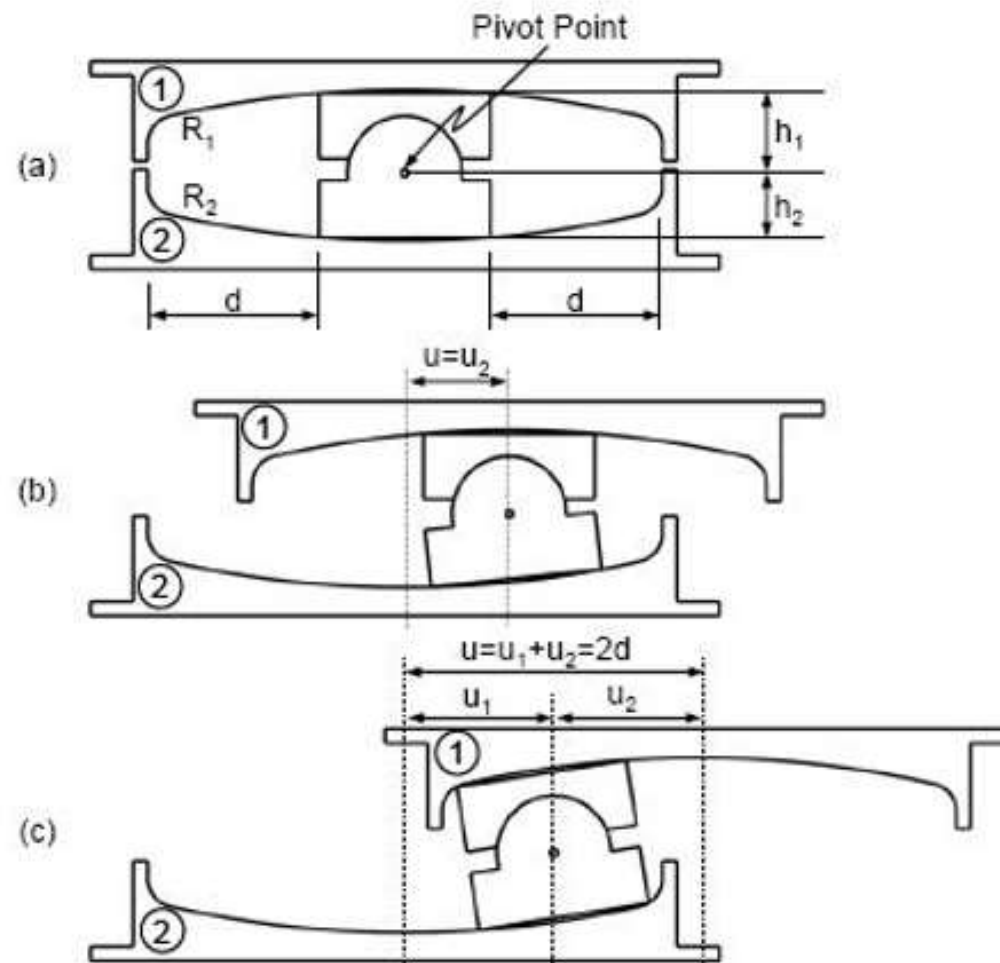

Isolatore a doppia curvatura

DISSIPAZIONE DI ENERGIA

Edificio
convenzionale

$$F_{c2} \gg F_{c1}$$

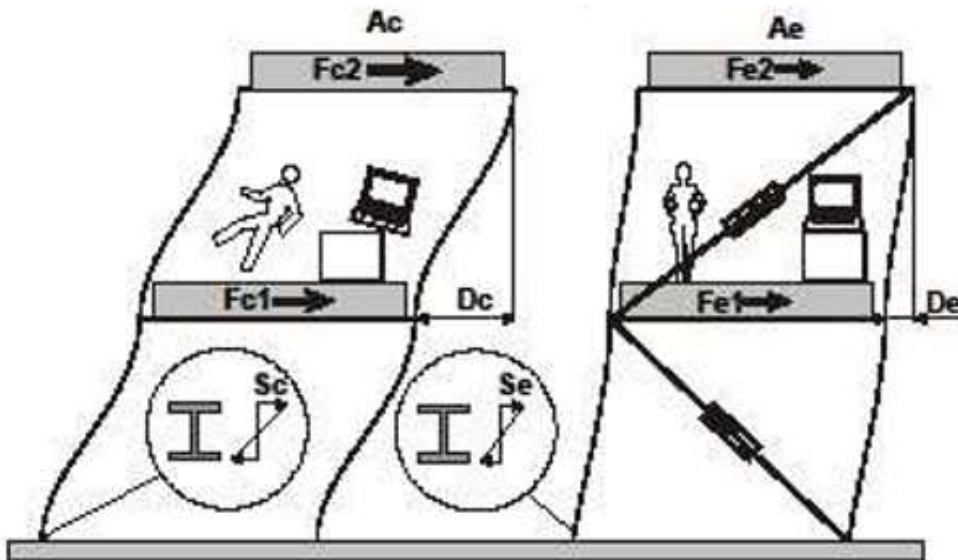

Edificio con
dissipatori

$$F_{e2} > F_{e1}$$

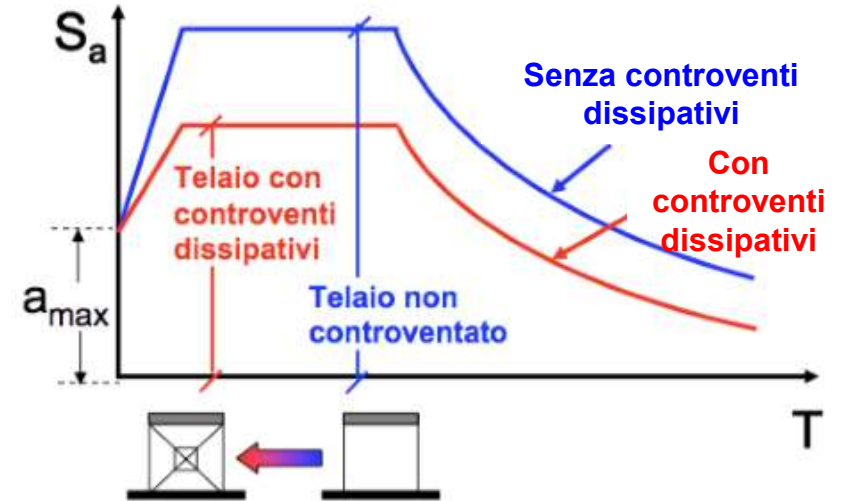

$S_{a,c} > S_{a,e}$	$S_{d,c} < S_{d,e}$
$F_c > F_e$	$D_c > D_e$



INTERVENTO CON DISSIPATORI

Dissipatori ad attrito, viscoelastici, ricentranti, ecc.

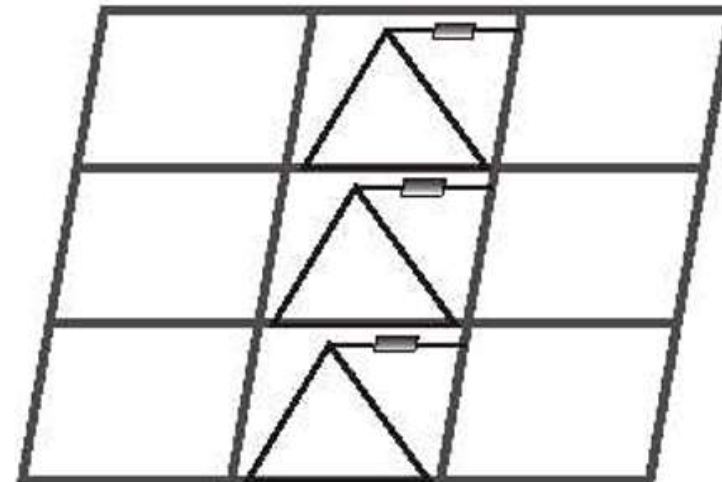
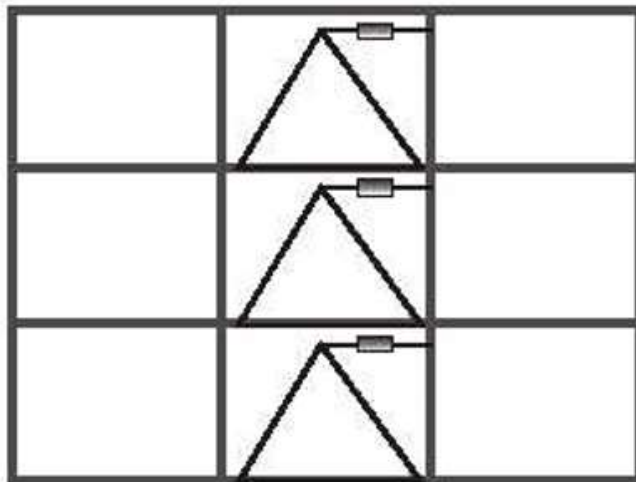
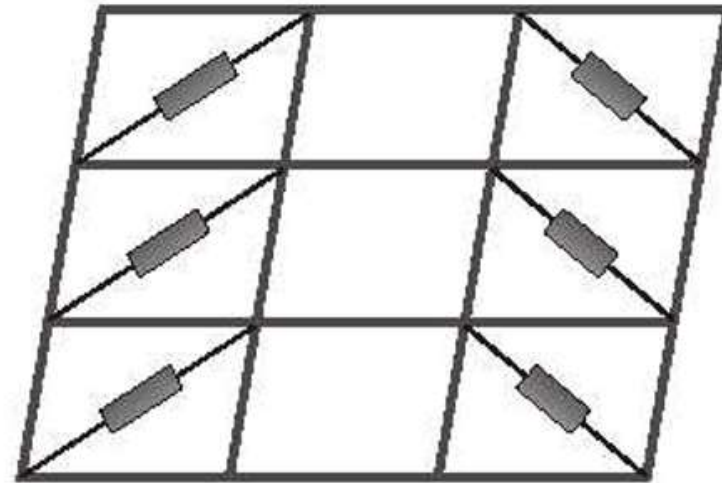
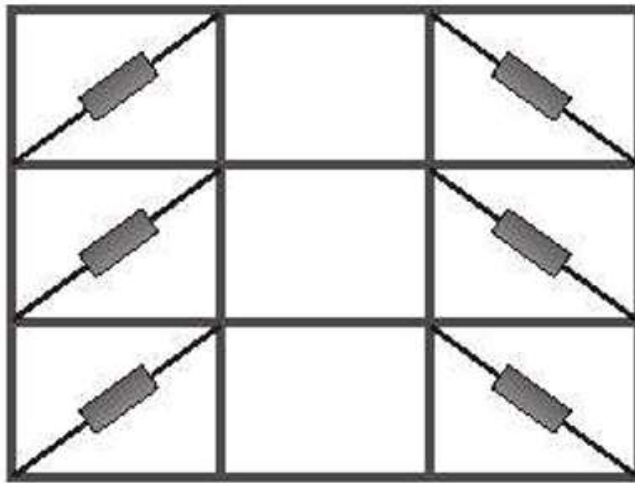

INTERVENTO CON DISSIPATORI

Dissipatori ad attrito, viscoelastici, ricentranti, ecc.

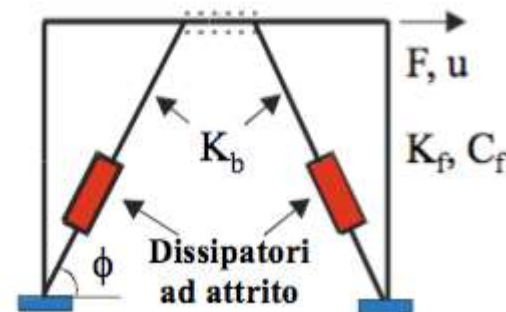
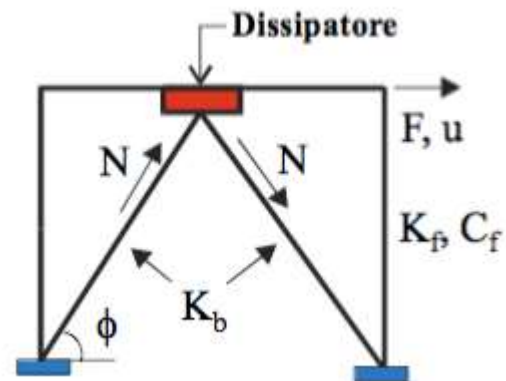
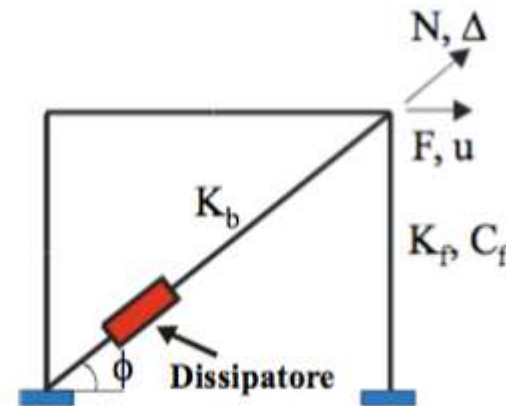
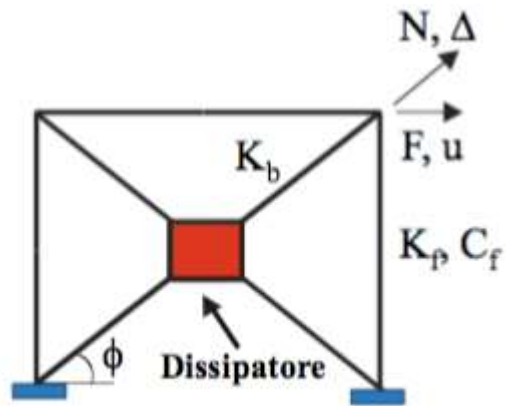

INTERVENTO CON DISSIPATORI

Dissipatori ad attrito

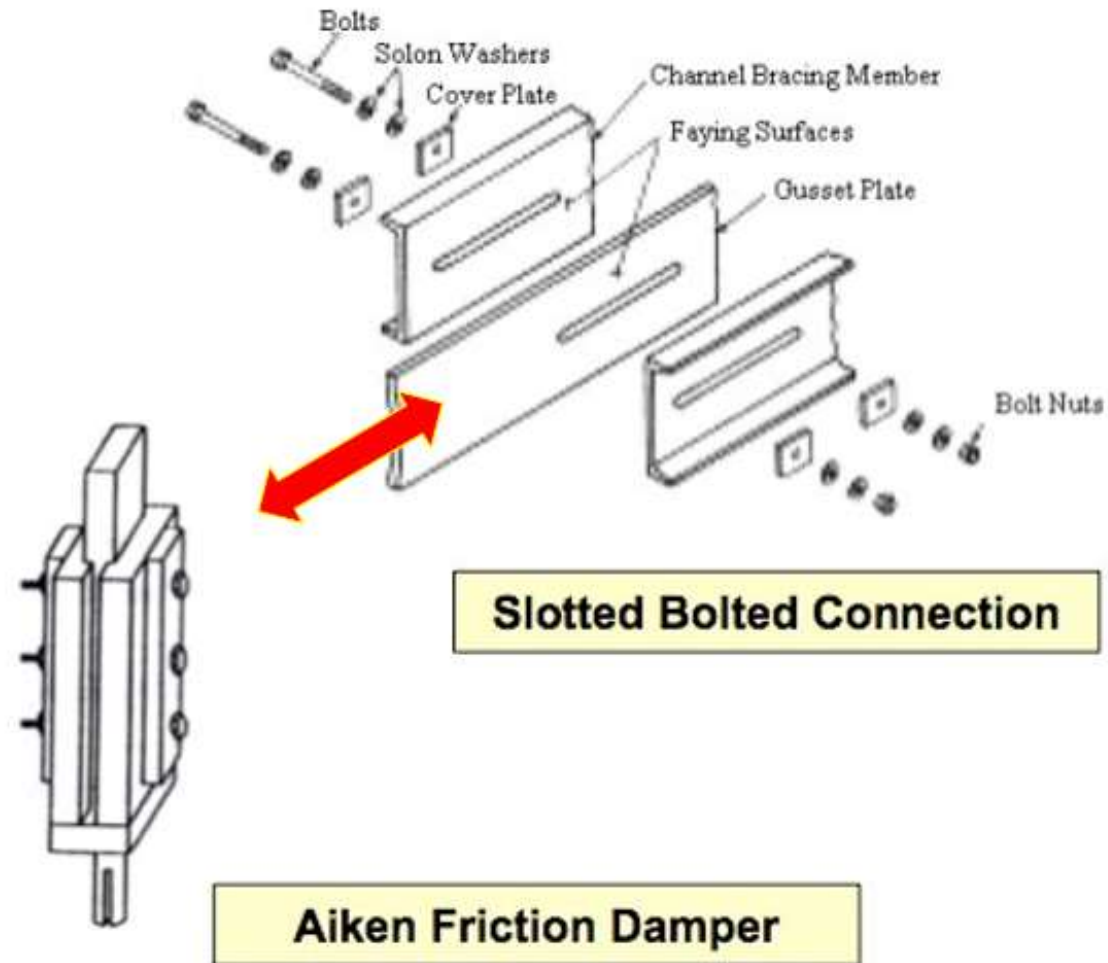

INTERVENTO CON DISSIPATORI

Dissipatori viscoelastici

- Dissipazione di energia per effetto della deformazione subita dagli strati di materiale viscoelastico

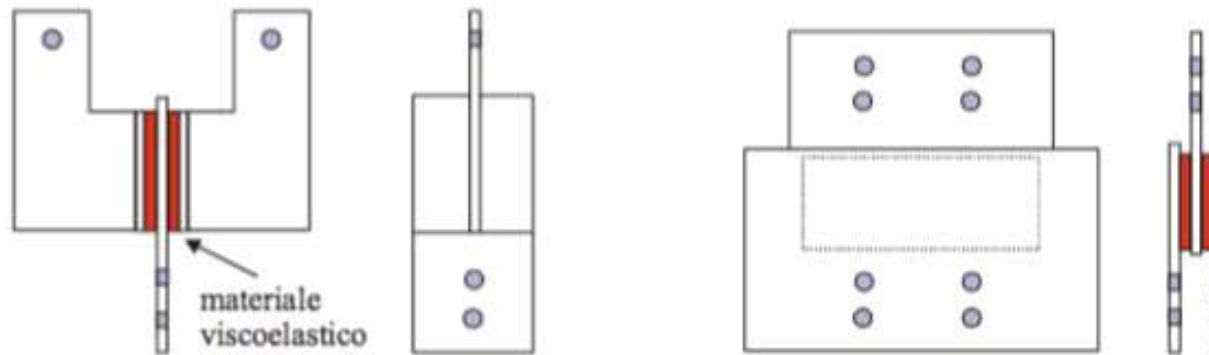

INTERVENTO CON DISSIPATORI

Scuola “Gentile Fermi” a Fabriano. Adeguamento con dissipatori.

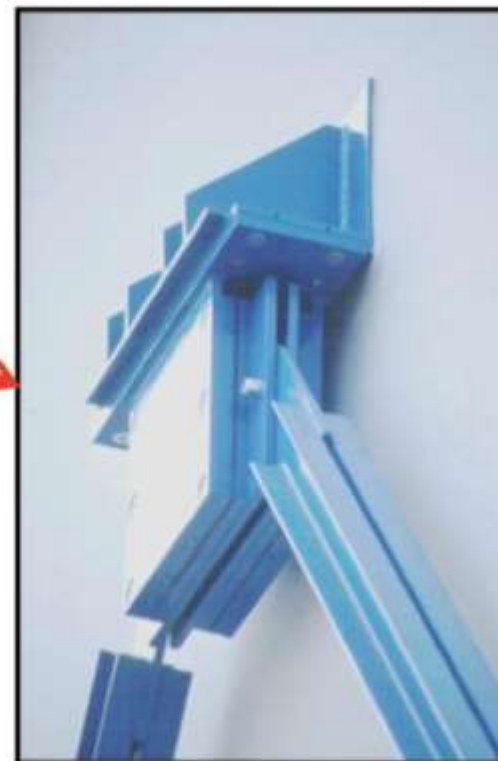

INTERVENTO CON DISSIPATORI

Dissipatori elasto-plastici.



EDIFICI ESISTENTI IN MURATURA

Intervento mediante aggiunta di isolatori in gomma

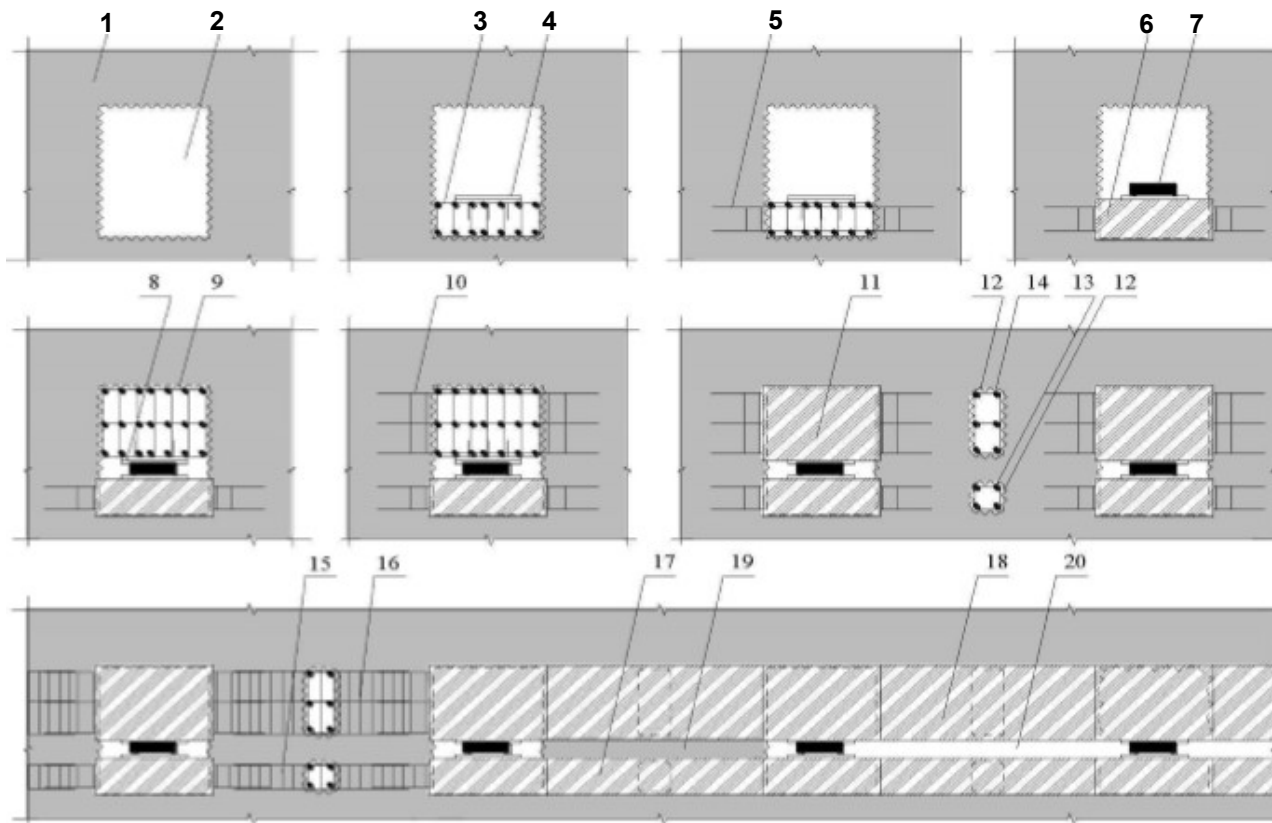

EDIFICI ESISTENTI IN MURATURA

Scavo nella muratura

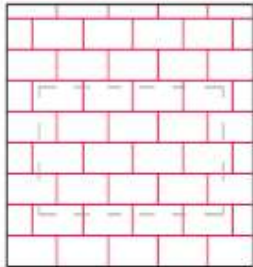

Disposizione delle armature inferiori e della contropietra dell'isolatore



Getto del baggio

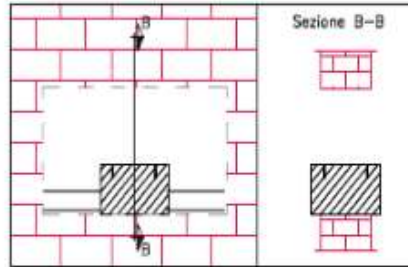

Disposizione dell'isolatore

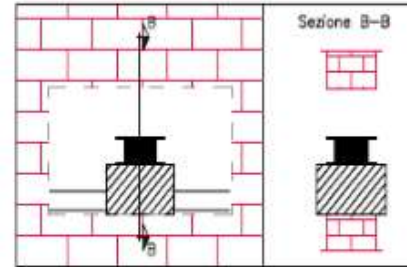

Disposizione della contropietra superiore, delle armature superiori dell'appoggio e delle armature di fasciatura della muratura

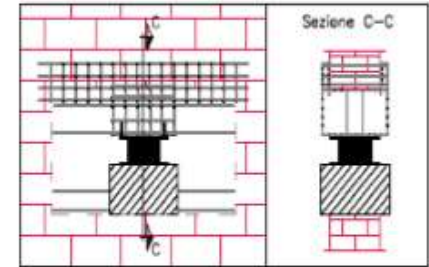

Getto della parte superiore dell'appoggio e delle travi fascianti la muratura

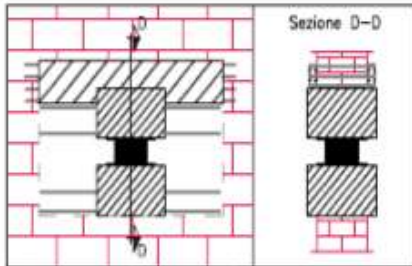

Realizzazione della disconnessione tra due appoggi consecutivi e prosecuzione delle armature della trave

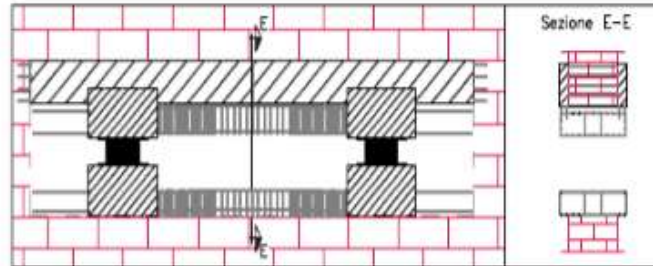

Getto di completamento della trave superiore e del cordolo inferiore

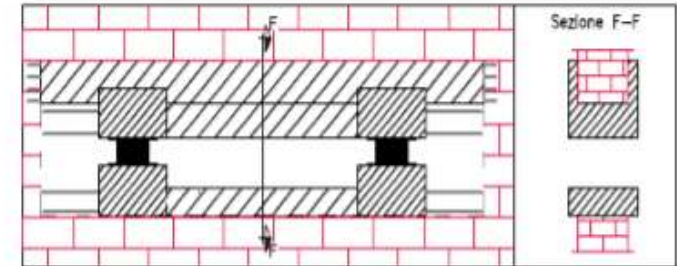

Ripetizione delle fasi precedenti per tratti successivi

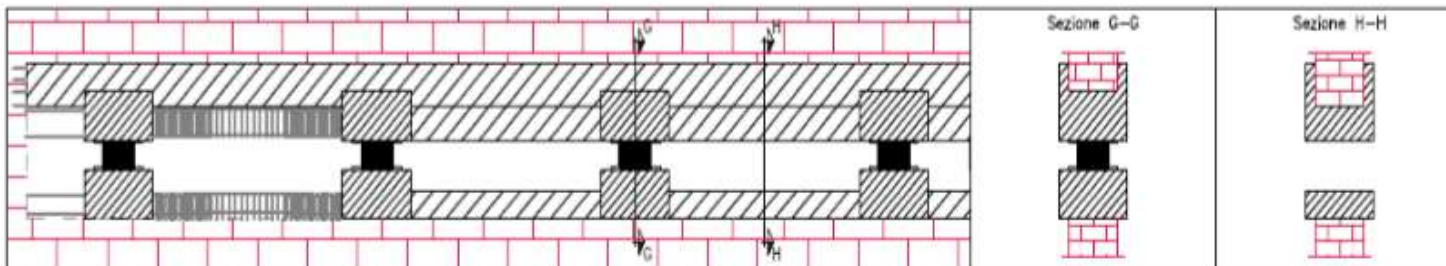

EDIFICI ESISTENTI IN MURATURA

isolated platform under the foundations of the building, without touching the building itself

