

# How to create a subtropical gyre circulation I

Recall that surface winds in the 15-45 degree range consists of easterly trades and midlatitude westerlies.....

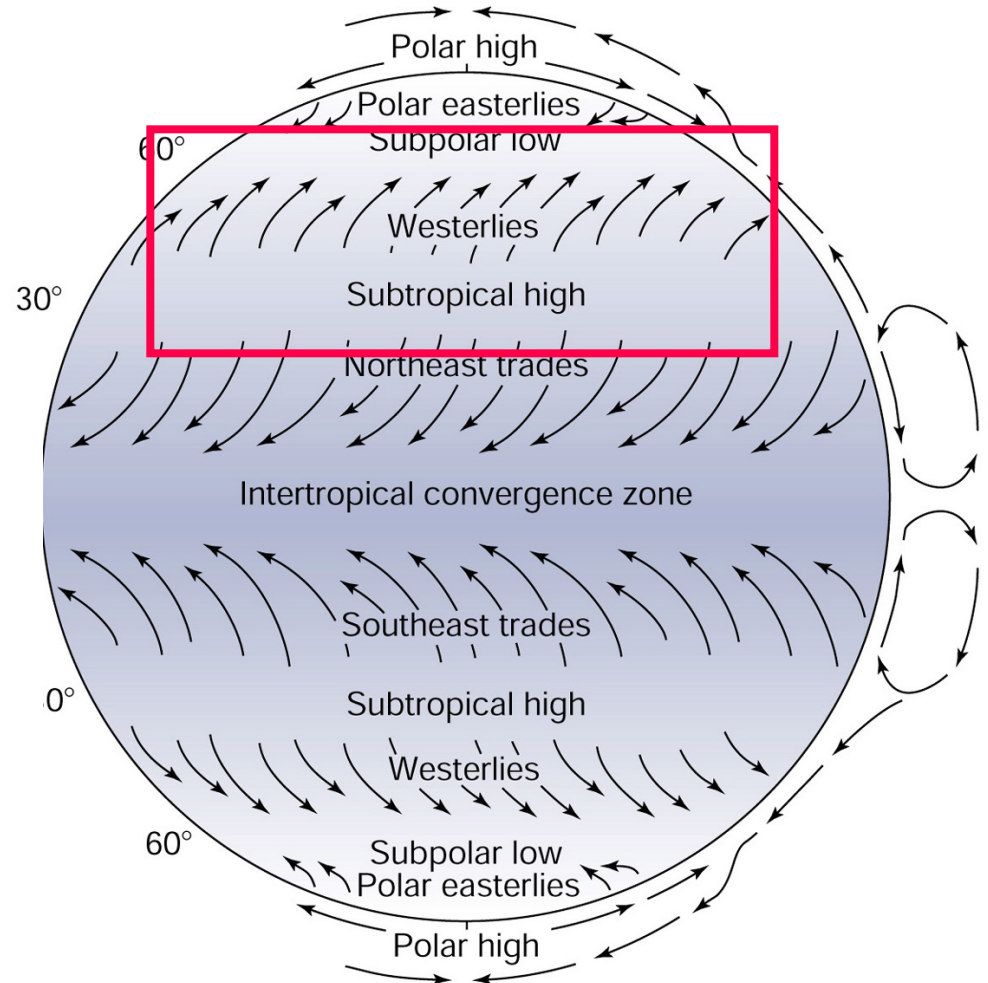

Copyright © 2004 Pearson Prentice Hall, Inc.

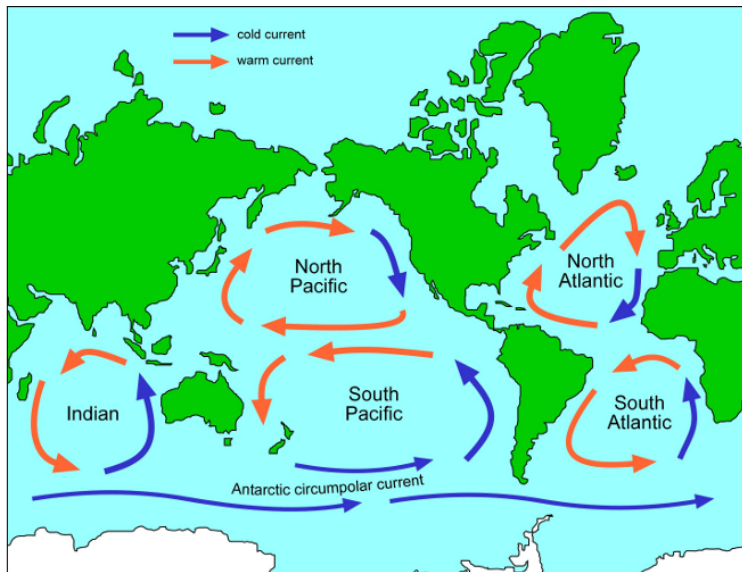
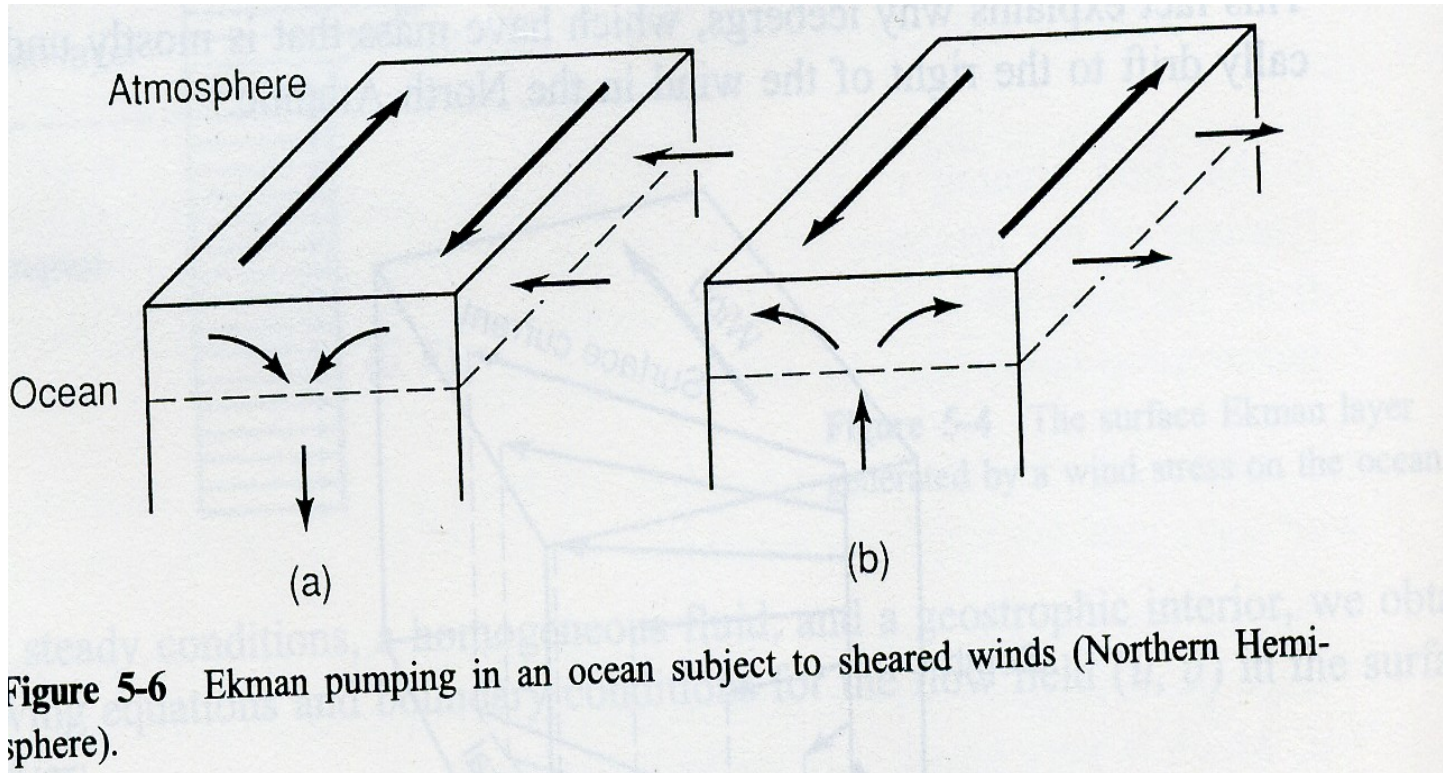

**Figure 5-6** Ekman pumping in an ocean subject to sheared winds (Northern Hemisphere).

# How to create a subtropical gyre circulation III

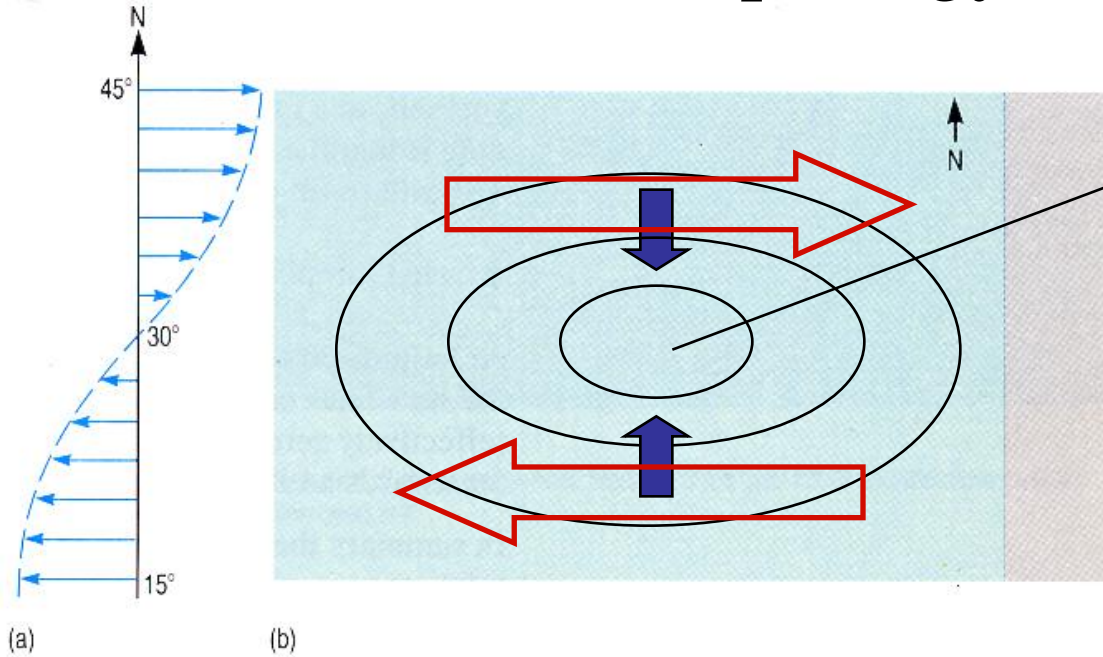

Ocean surface 'domes' up, and a geostrophic ocean current is produced that balances the resulting pressure gradient

Blue: Ekman flow

Red: Geostrophic flow

# Ekman Transport

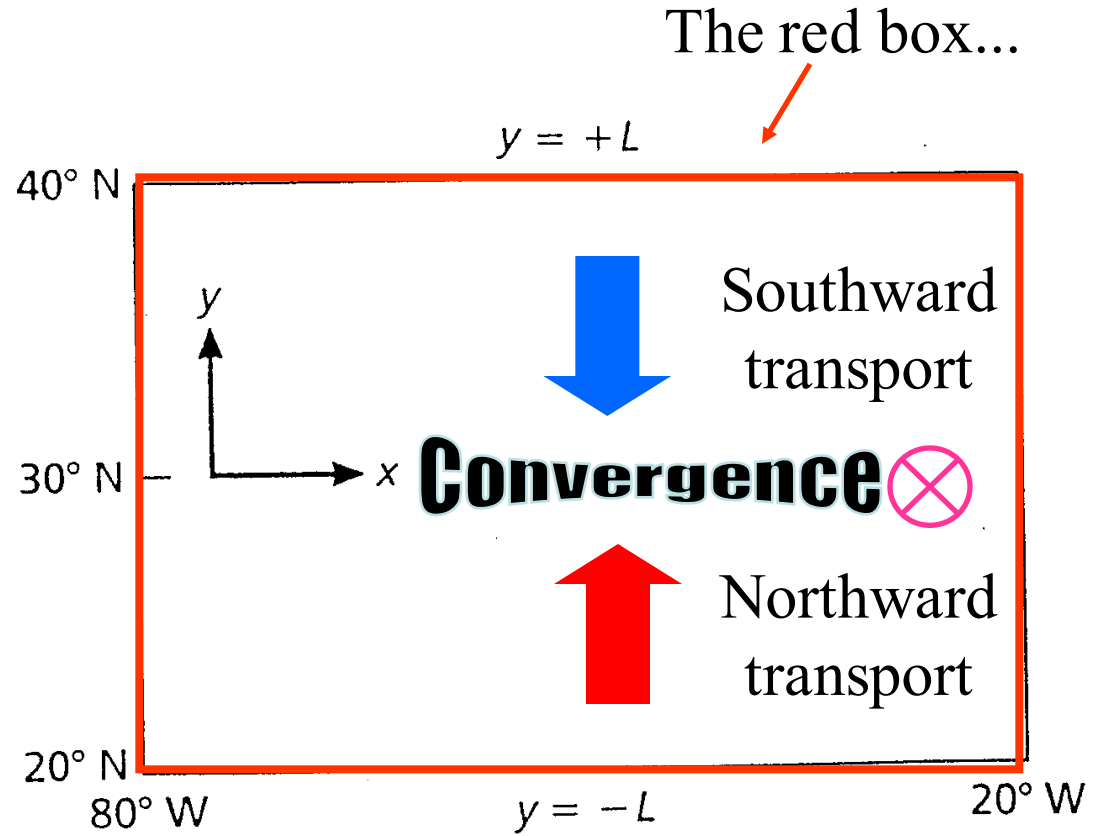
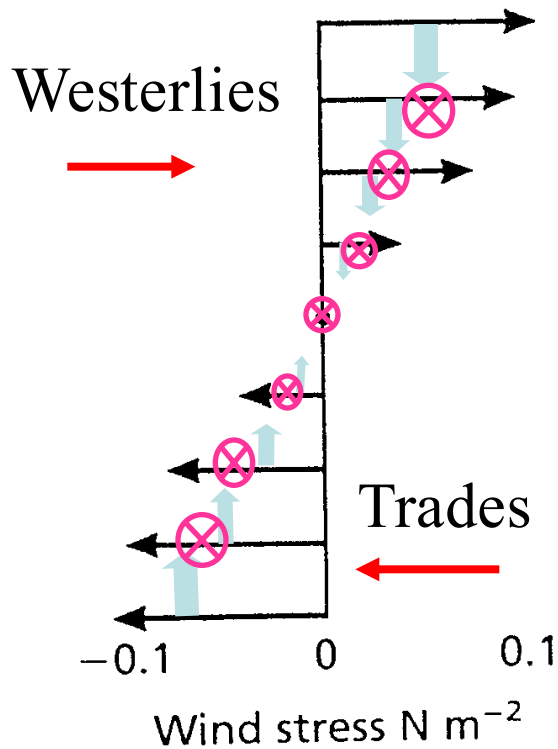

Ekman transport is proportional to wind stress  
 $\Rightarrow$  greater transport for greater wind stress

At the convergence, water piles up and sinks, thus depressing the thermocline and deepening the nutricline!

## Important points to note

- The sea level pile-up is a result of the convergence of the Ekman transport
- The Ekman layer is ONLY 50-100 meters thick
- The resulting pressure gradient is felt throughout the water column
- Thus the geostrophic current occurs over a MUCH greater depth than the depth of the wind-driven layer, as much as the top 200 to 500 meters

# Equatorial upwelling.

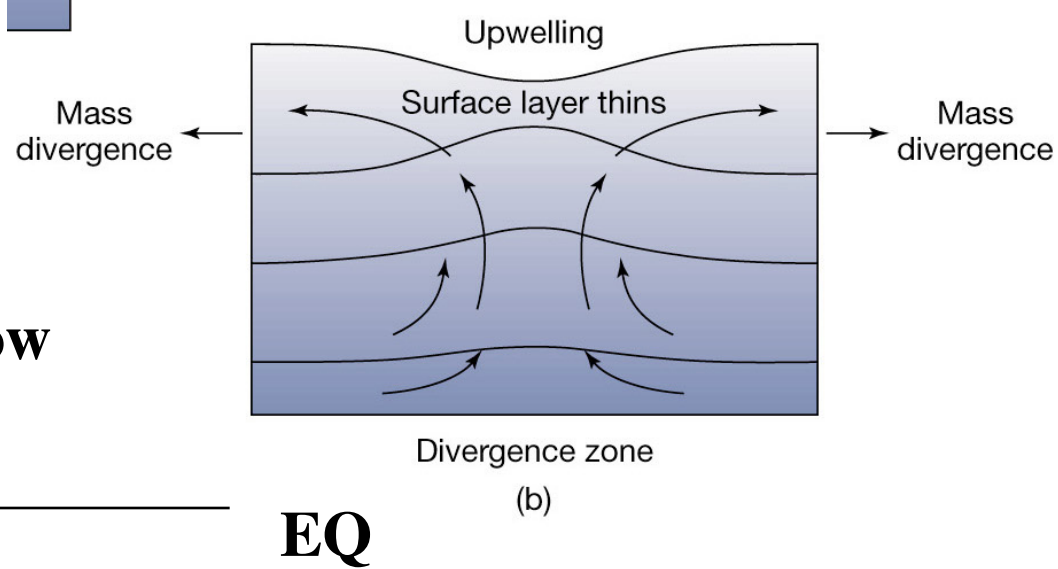
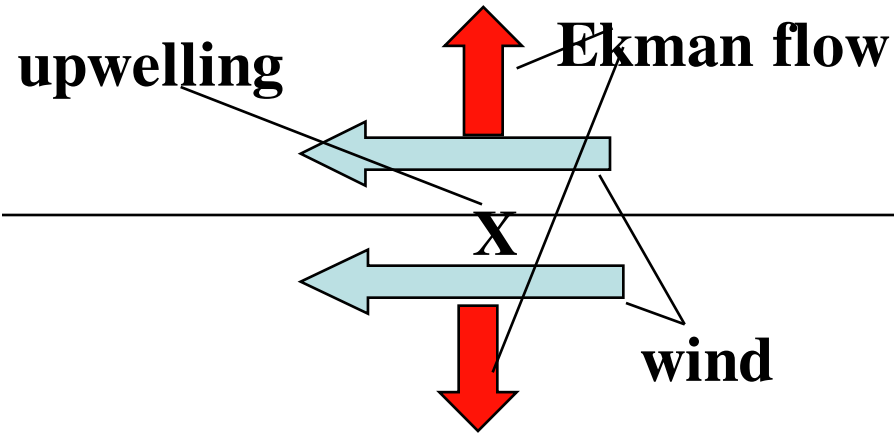

**Equatorial upwelling.** Recall that the winds on the equator are easterly - from the east. Now, consider what the Ekman flow would do north and south of the equator. Because of the reversal in the Coriolis parameter, it turns out that the Ekman flow is polewards in both hemispheres - in other words, the ocean circulation is diverging at the equator. In order to compensate for this divergence, water has to be brought up from below the mixed layer - hence equatorial upwelling. This mechanism is responsible for the *cold tongues* over the eastern equatorial Pacific and Atlantic.

# Wind-driven ocean circulations (cont)

## *Equatorial current and counter-currents*

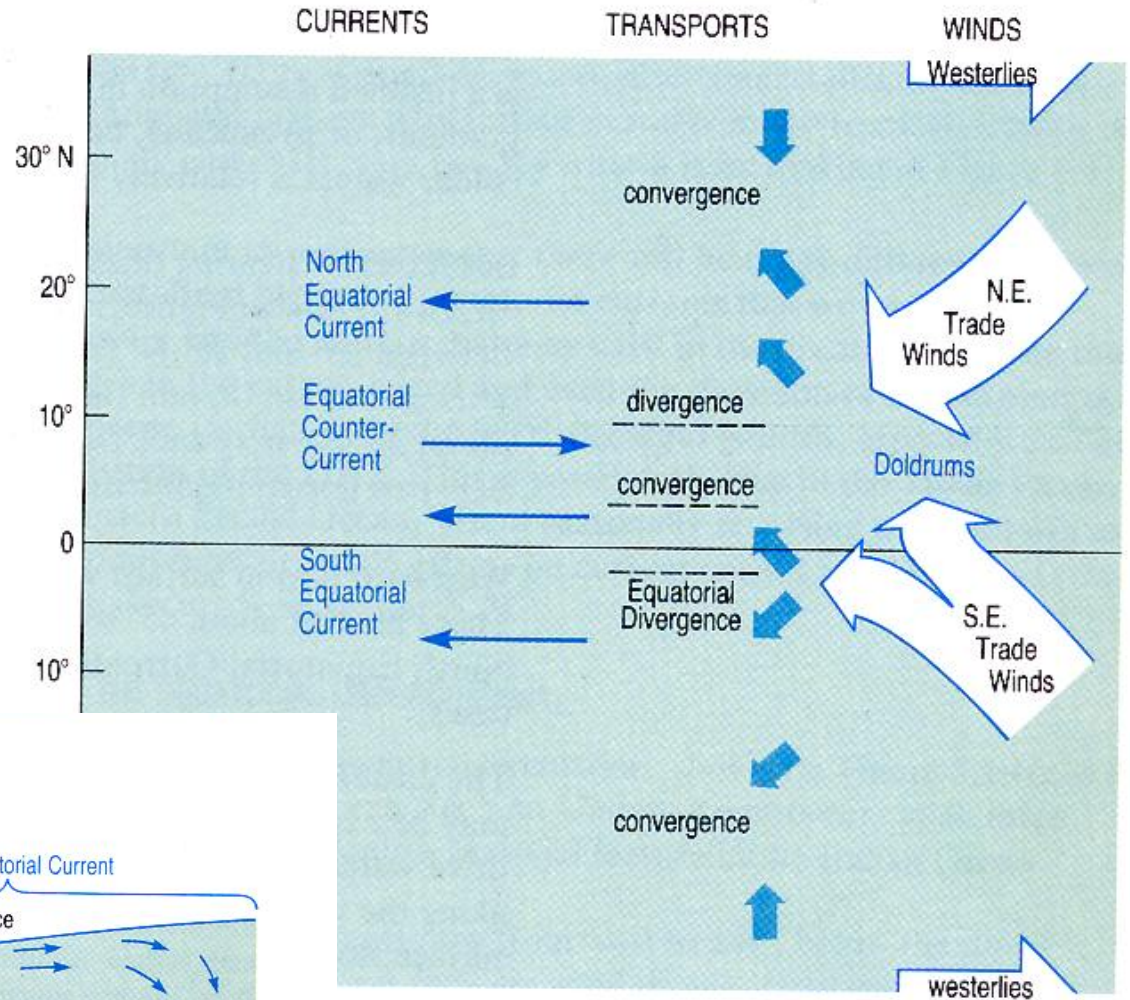

(a)

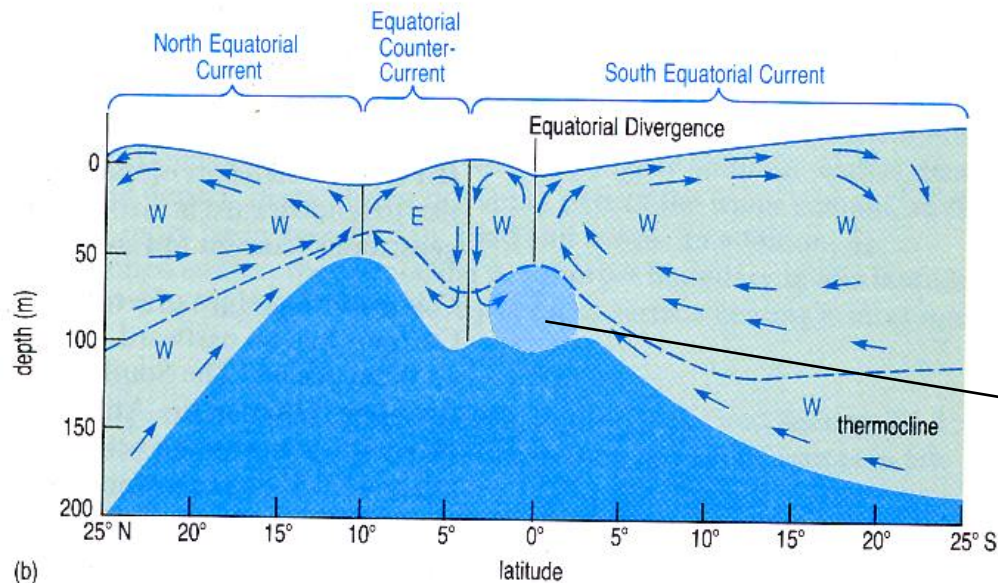

Equatorial undercurrent

(b)

**Coastal upwelling:** suppose this is the northern hemisphere, and the wind is parallel to the coastline as shown below. The Ekman flow as a result will be to the right of the wind - in other words, away from the coastline. But, in order to obey mass continuity, this has to be compensated for by bringing in water from below the mixed layer - i.e. upwelling. Since the upwelled water is cold, the upwelling regions have cold sea surface temperature.

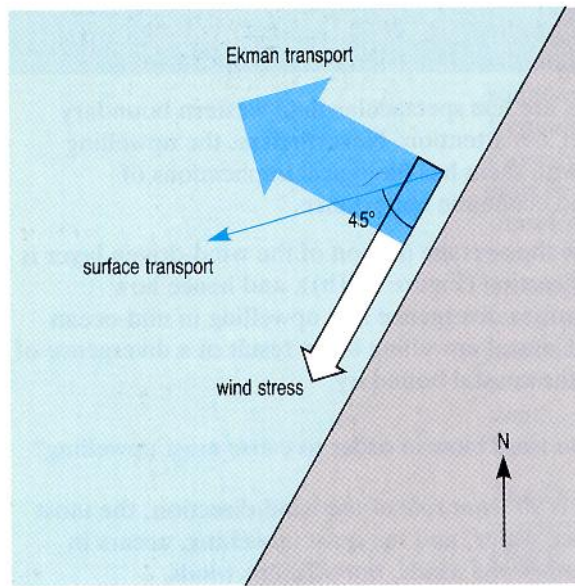

(a)

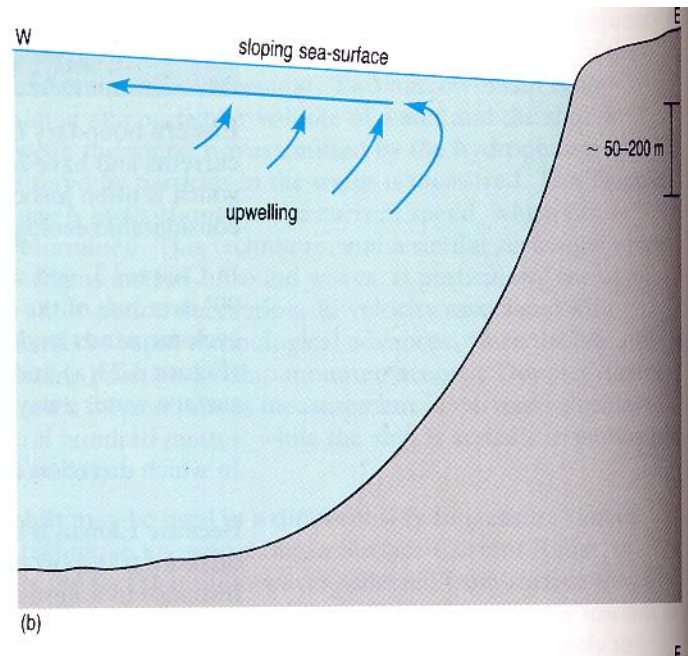

(b)



# Cosa succede nell' "Interior"?

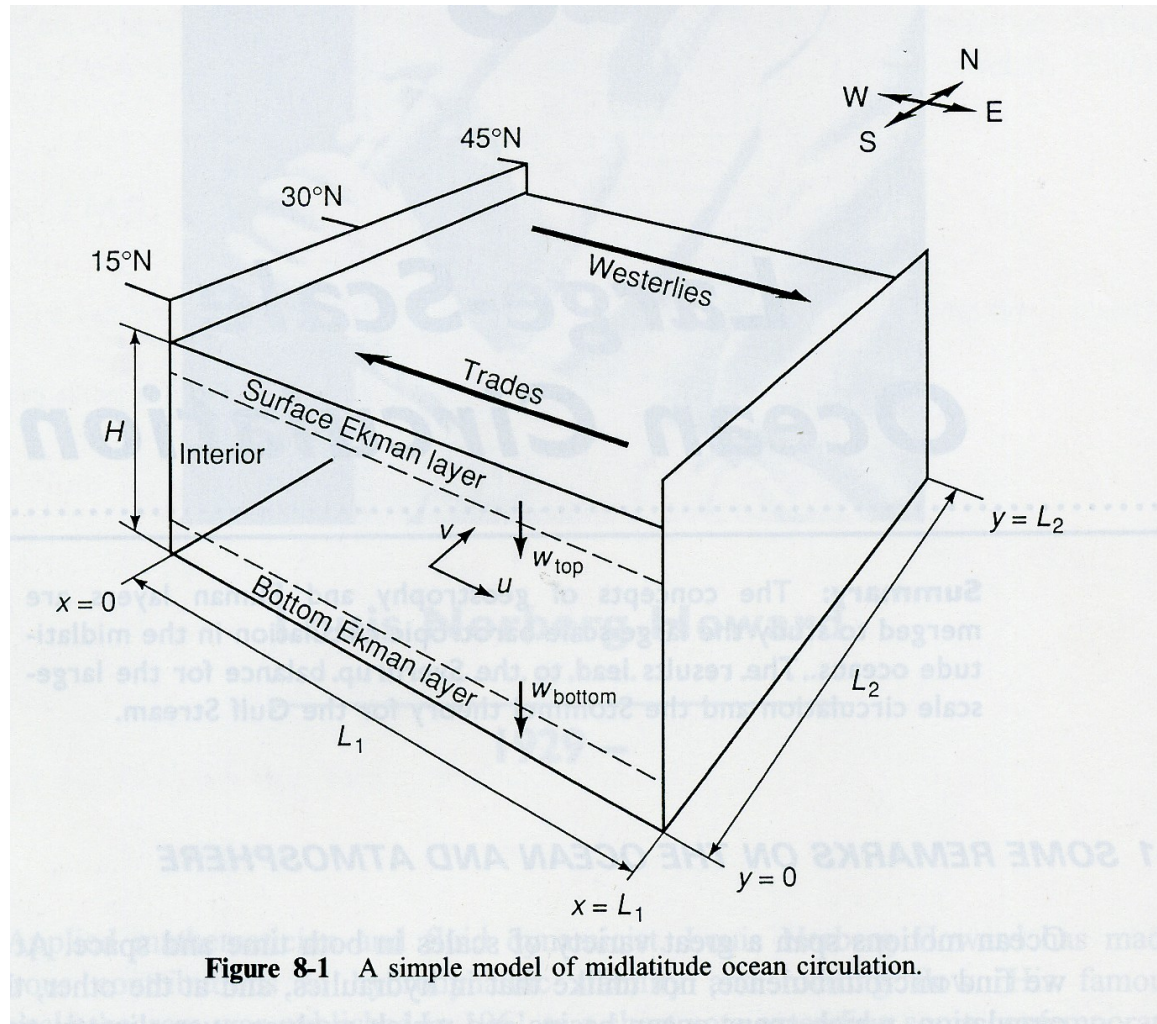

**Figure 8-1** A simple model of midlatitude ocean circulation.

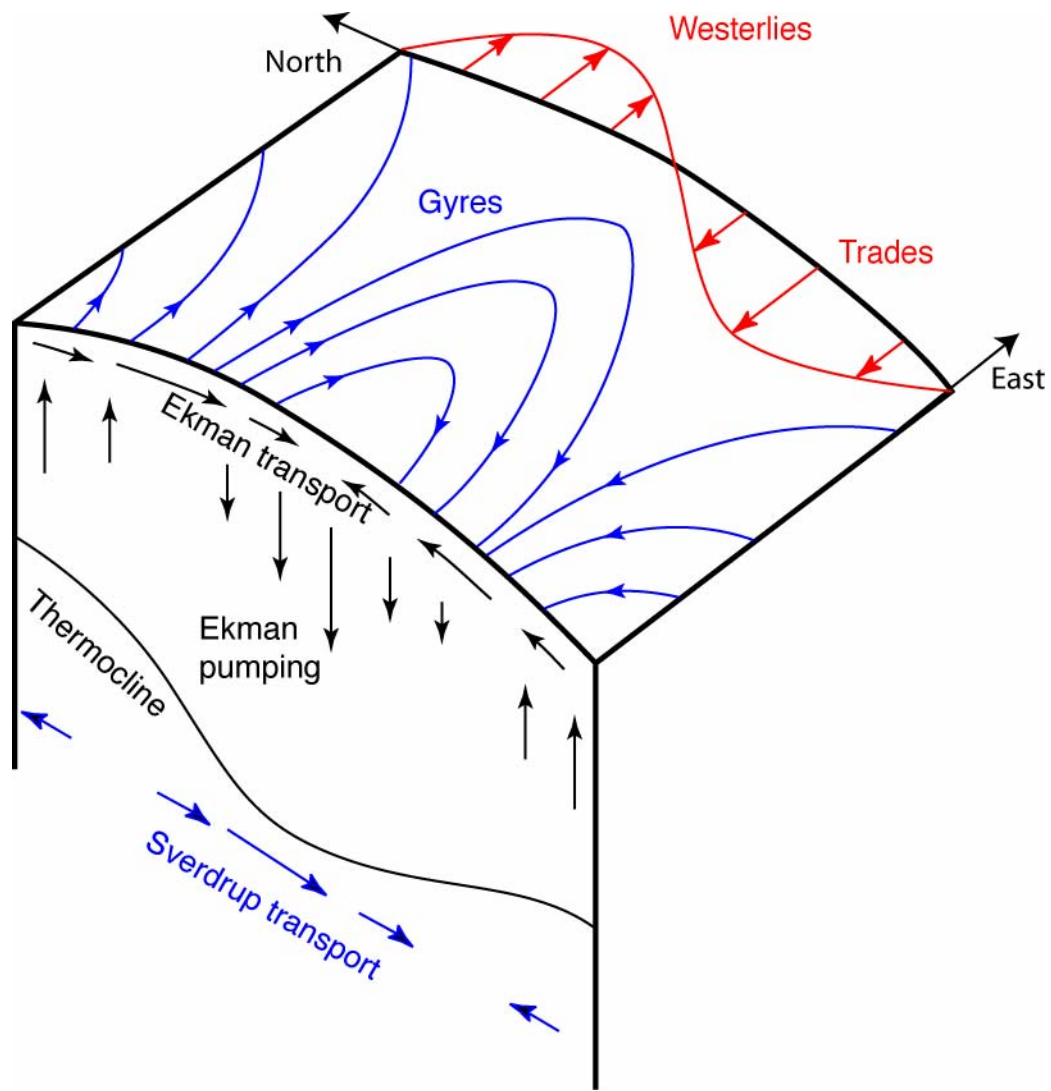

# Sverdrup Transport (Interior)

86

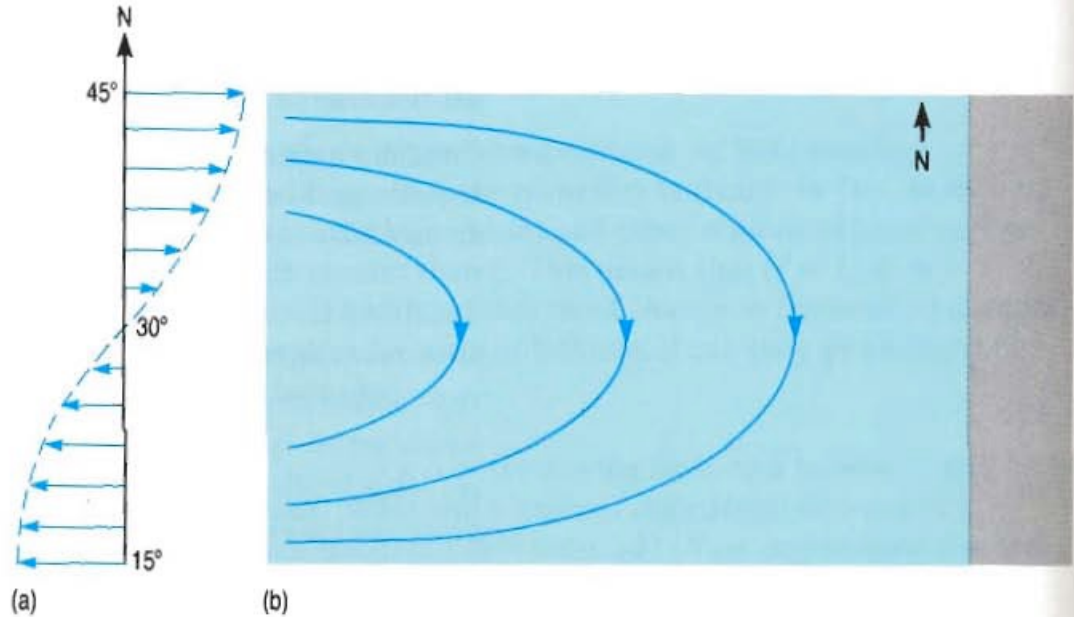
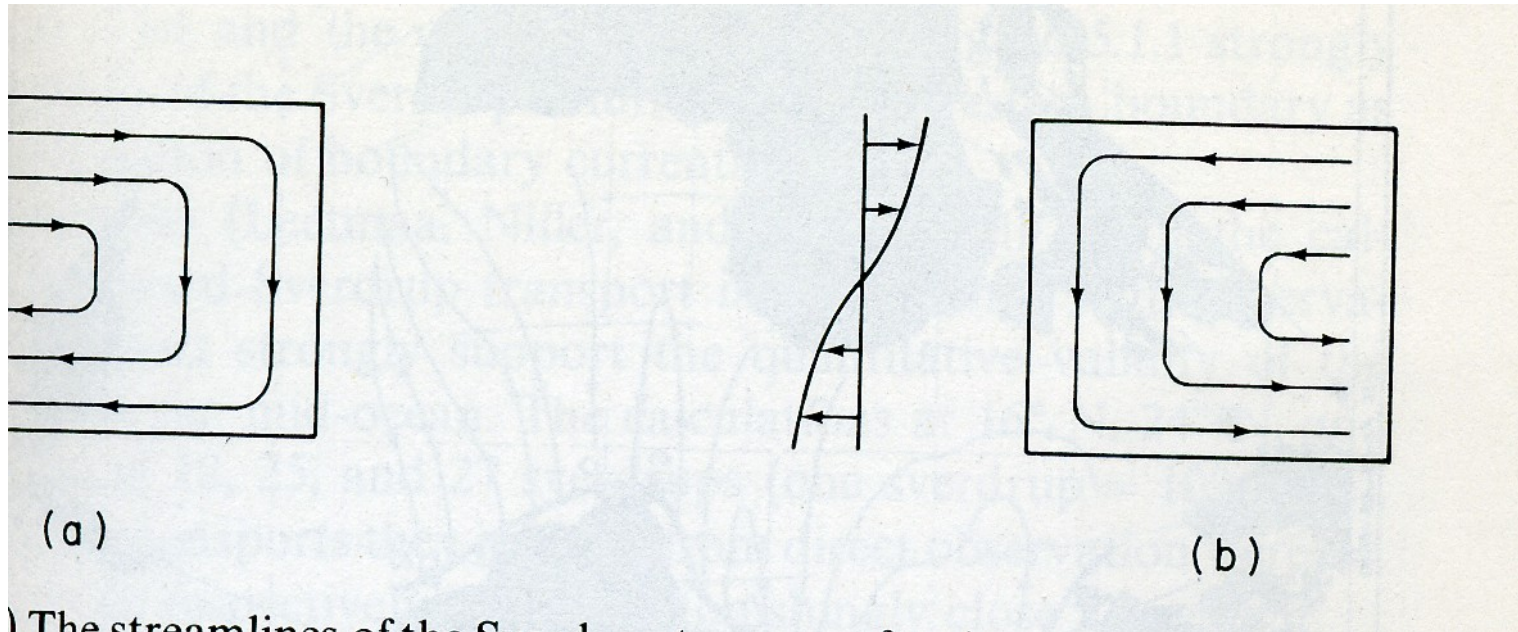
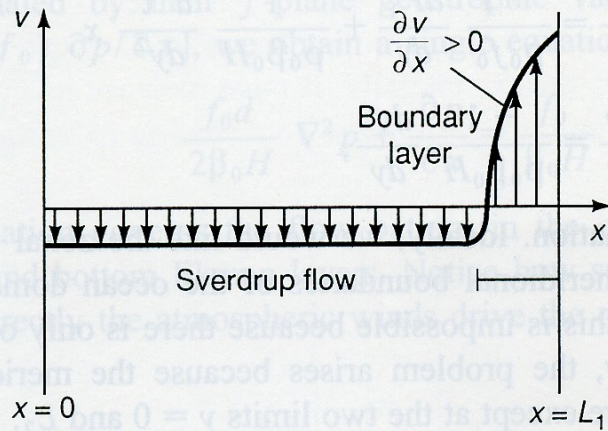

Figure 4.10 (a) As for Figure 4.9. (b) The 'depth-integrated' flow pattern that results from combining Ekman transports at right angles to the wind with geostrophic current flow in response to horizontal pressure gradient forces, according to Sverdrup.

**Tutte e due (a e b) sono consistenti con il wind stress!**

**Qual'è quella reale?**





(a)

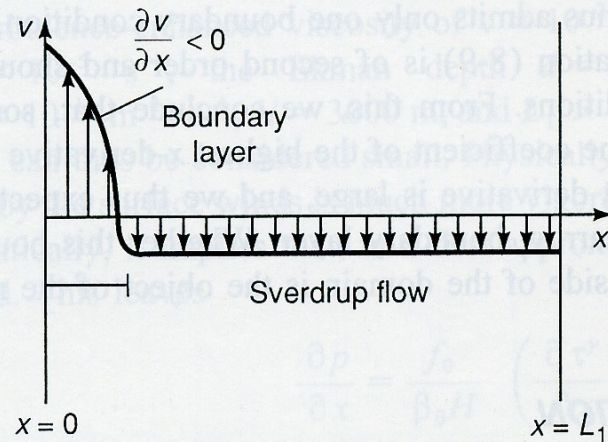

(b)

**Figure 8-3** Possible configurations for a northward boundary current to return the southward Sverdrup flow that exists across most of the ocean basin: (a) boundary current on the eastern side, (b) boundary current on the western side. The former is to be rejected on dynamic grounds, leaving the latter as the correct configuration.



