

CELL MECHANICS

1. Introduction - L1

2. Physical principles

- 2.1. Forces at molecular and cell level - L2
- 2.2. Thermal forces, diffusion, and chemical forces;
and Single molecule experiments – L3, L4, L5, L6

3. Mechanics of the Cytoskeleton and Mechano-transduction

- 3.1. Motor proteins - types, working principle – L8-9
- 3.2. Force generation by the cytoskeleton and cell motility – L10

4. Experimental techniques to study cell mechanics

- 4.1. Cellular mechanotransduction (basic principles and examples) L11
- 4.2. Optical, magnetic and acoustic tweezers L7, L12
- 4.3. Super resolution optical microscopy techniques (STED, PALM) L12**

- Lab visit and experimental optical tweezers cell mechanics session at CNR IOM

4.3. Super-resolution optical microscopy techniques (STED, PALM)

- What is **spatial resolution** of an optical system
- **NANOSCOPY**: increasing the spatial resolution in fluorescence microscopy by **super-resolution** techniques:

STED – Stimulated Emission Depletion microscopy

PALM – Photo Activated Localization Microscopy

Bibliography:

Slides, techniques and experimental examples from literature (papers)

Resolution

Resolution describes the ability of an optical system to **resolve details** of the object that is being imaged.

Due to **the diffraction of light** through an optical system with finite size, a **POINT** object is imaged into a **SPOT** rather than a point.

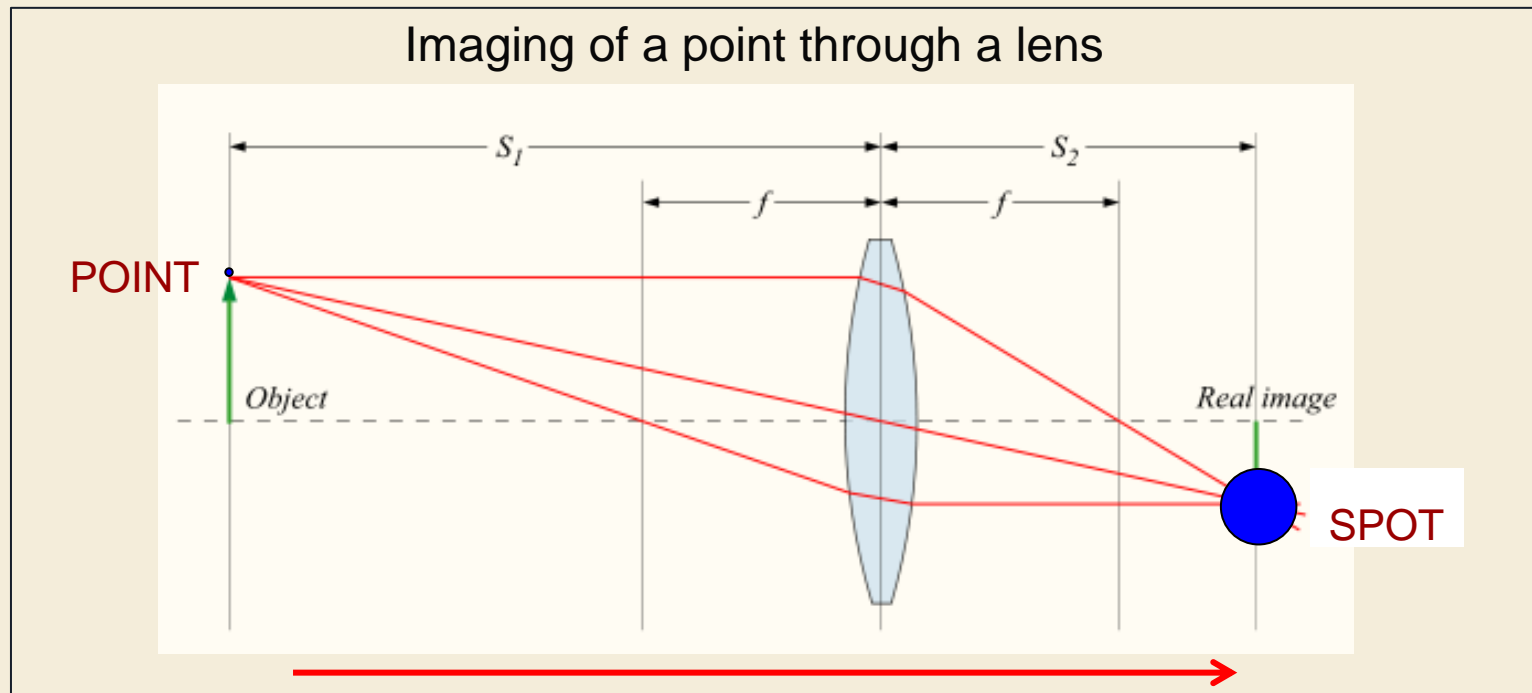

LARGER the LENS, SMALLER the SPOT !
SMALLER the SPOT, BETTER RESOLUTION !

Imaging TWO points through a lens

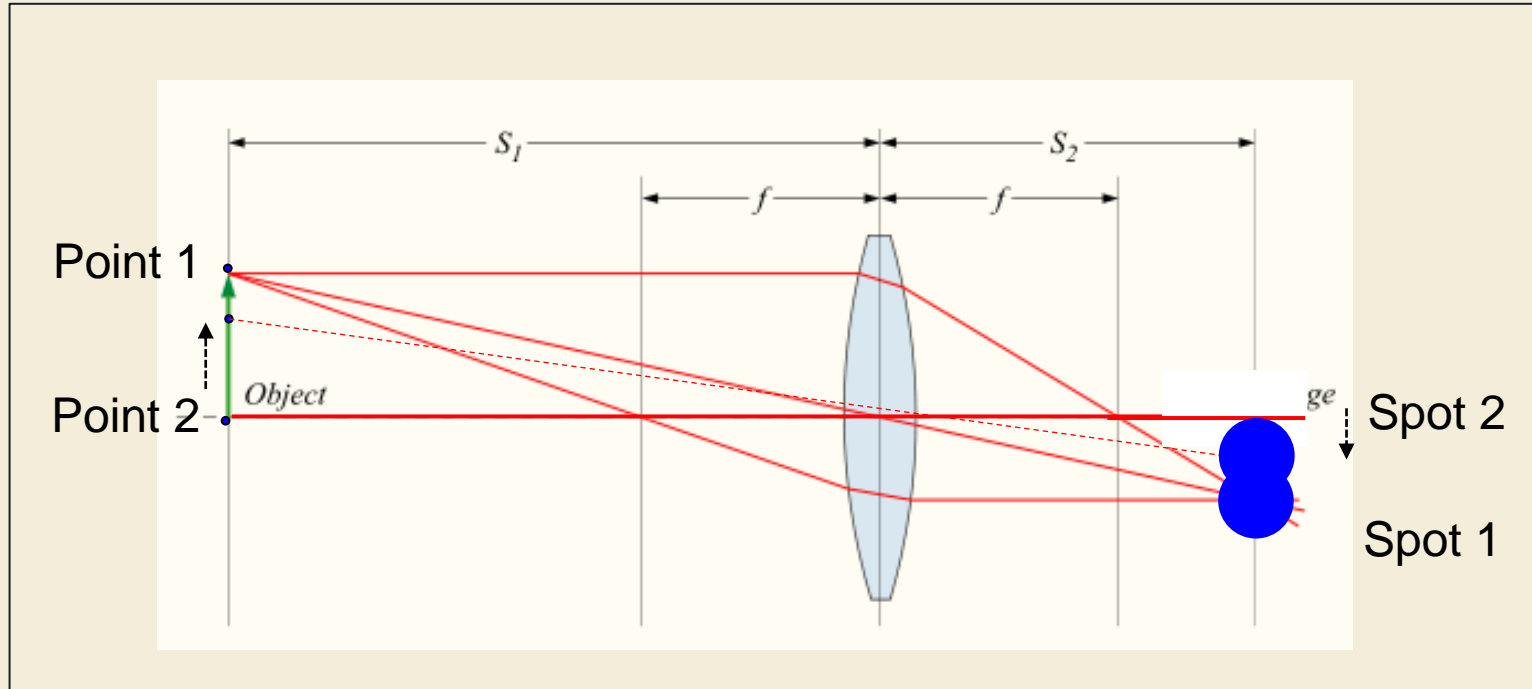

**The two spots overlap and hence they can not be separated
if the point objects are too close !**

Aperture, Numerical Aperture, F number

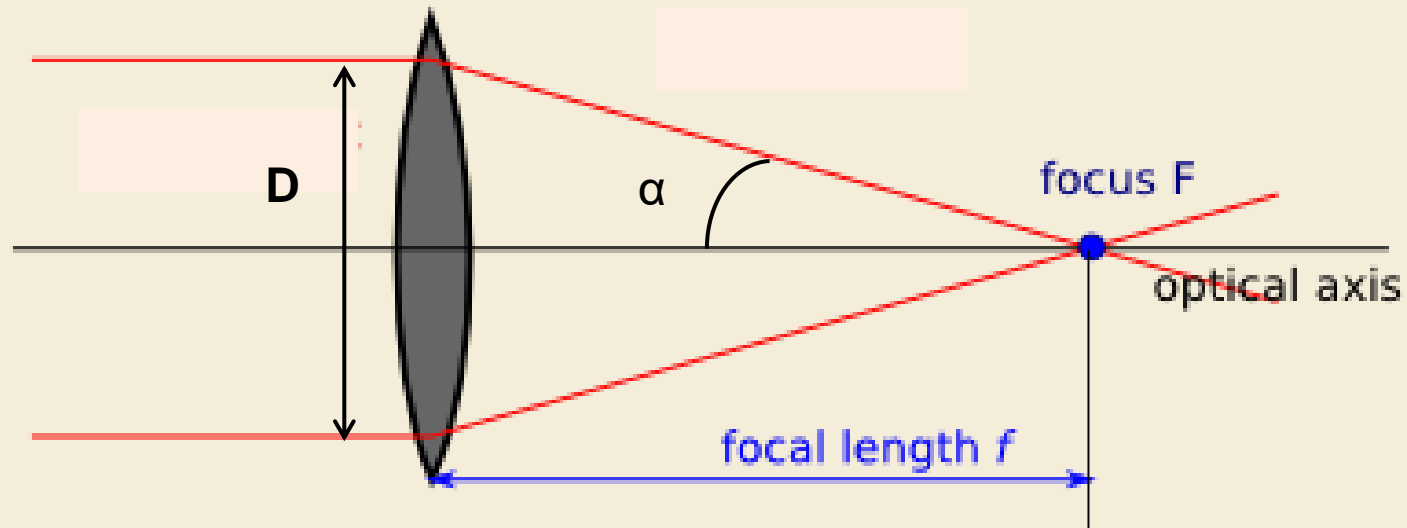

Aperture: diameter of the pupil / lens

D

Numerical Aperture $NA = n \sin(\alpha)$

where n – refractive index of the medium between the lens and focus ($n = 1$ for air)

F number

$f \# = f/D$

NA is used for microscope objectives, $f \#$ for photo objectives :

$$NA \approx \frac{1}{2f\#}$$

Resolution criterion

The resolution, r , is defined as the shortest distance between two points on a specimen that can still be distinguished by the observer or camera system as separate entities.

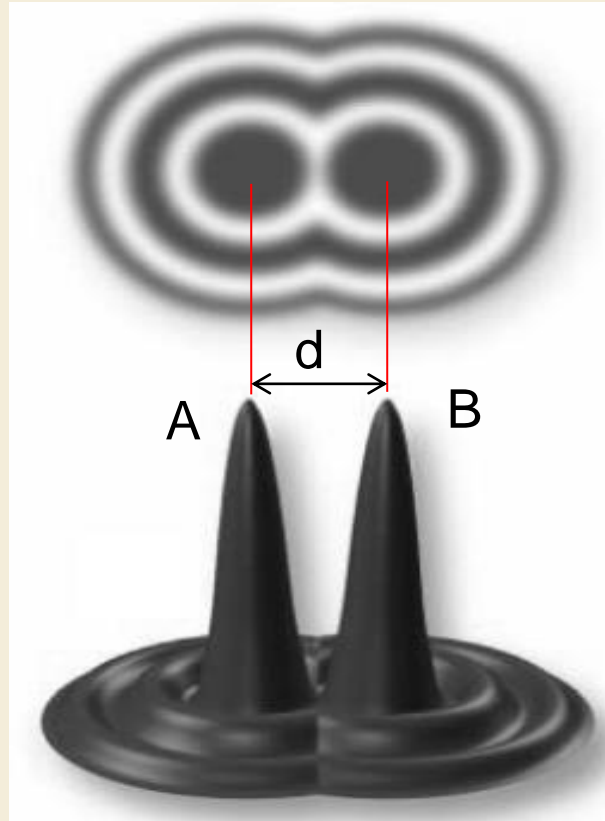

A and **B** are separated if $d > r$

Rayleigh criterion

$$r = 0.61 \frac{\lambda}{NA}$$

Estimating the lateral resolution
of a microscope objective (lens):

$$NA = 1.5, \lambda = 400 \text{ nm}$$

$$\rightarrow r \sim 163 \text{ nm}$$

Depth of field – axial resolution

Depth of field (DoF) is determined by the distance from the nearest object plane in focus to that of the farthest plane simultaneously in focus.

DoF defines the axial resolution $\rightarrow \text{DoF} = \Delta Z$

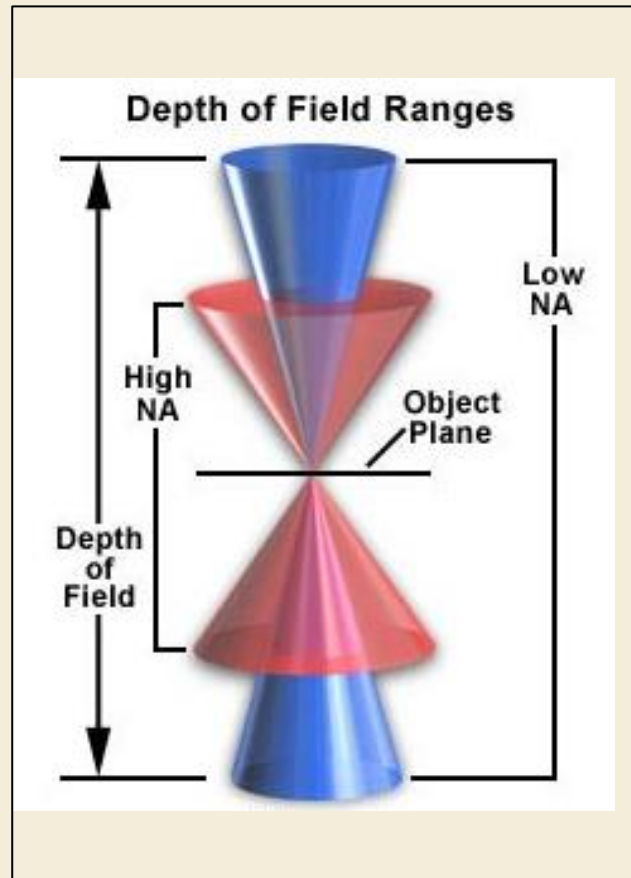

$$\Delta Z \cong 0.5 \frac{\lambda n}{\text{NA}^2}$$

Lateral and axial resolution

Lateral resolution $\Delta x \cong 0.6 \frac{\lambda}{NA}$

Axial resolution $\Delta z \cong 0.5 \frac{\lambda n}{NA^2}$

$$\Delta z \approx \frac{n}{NA} \Delta x \longrightarrow \Delta z > \Delta x$$



Lateral resolution is in general better than the axial resolution

Length scales and spatial resolution limits of

- visual inspection (human eye),
- light (optical) microscopy
- electron microscopy

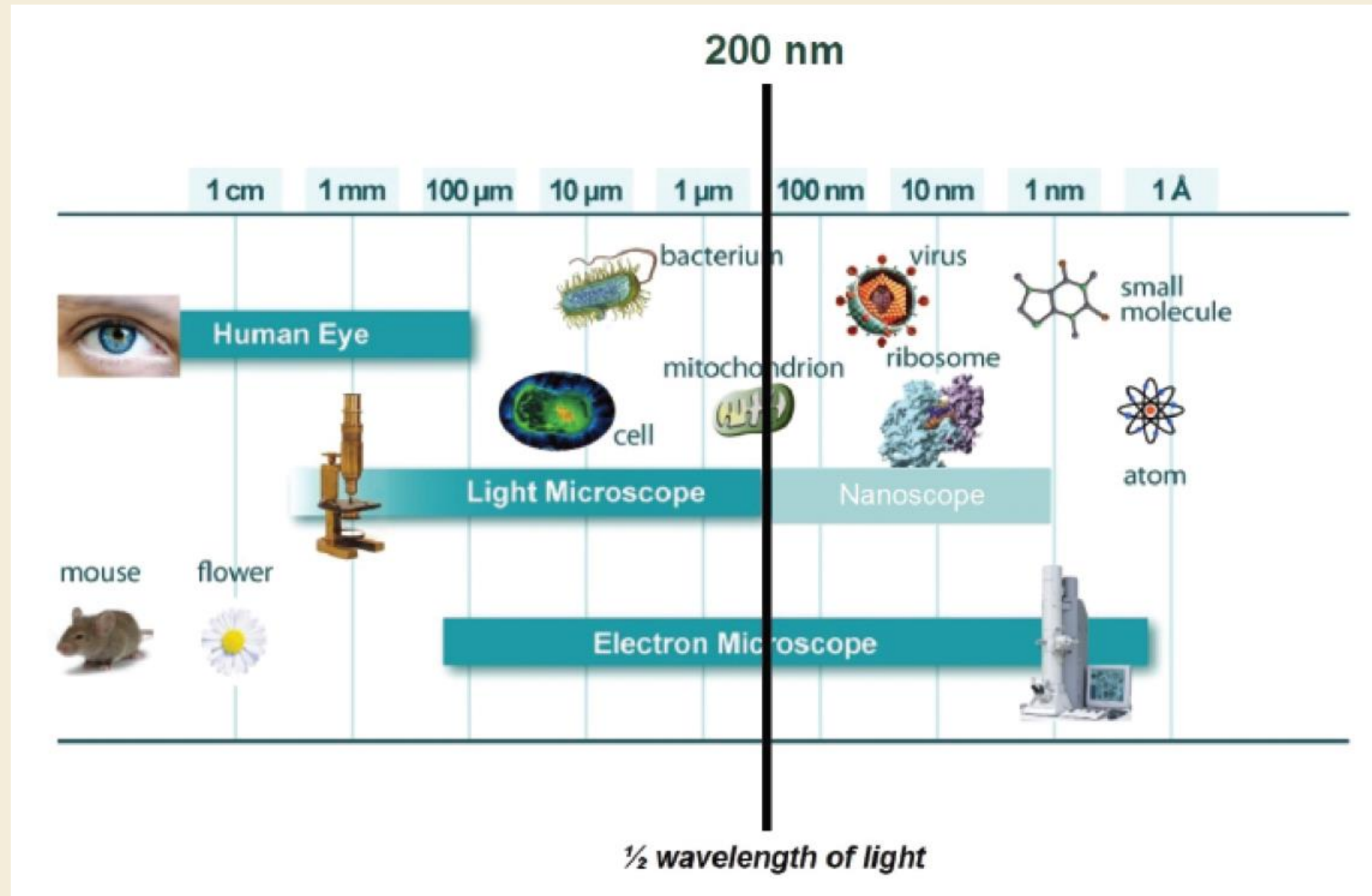

Why to still use the optical microscope and its spatial resolution, now that we have the electron microscope ?

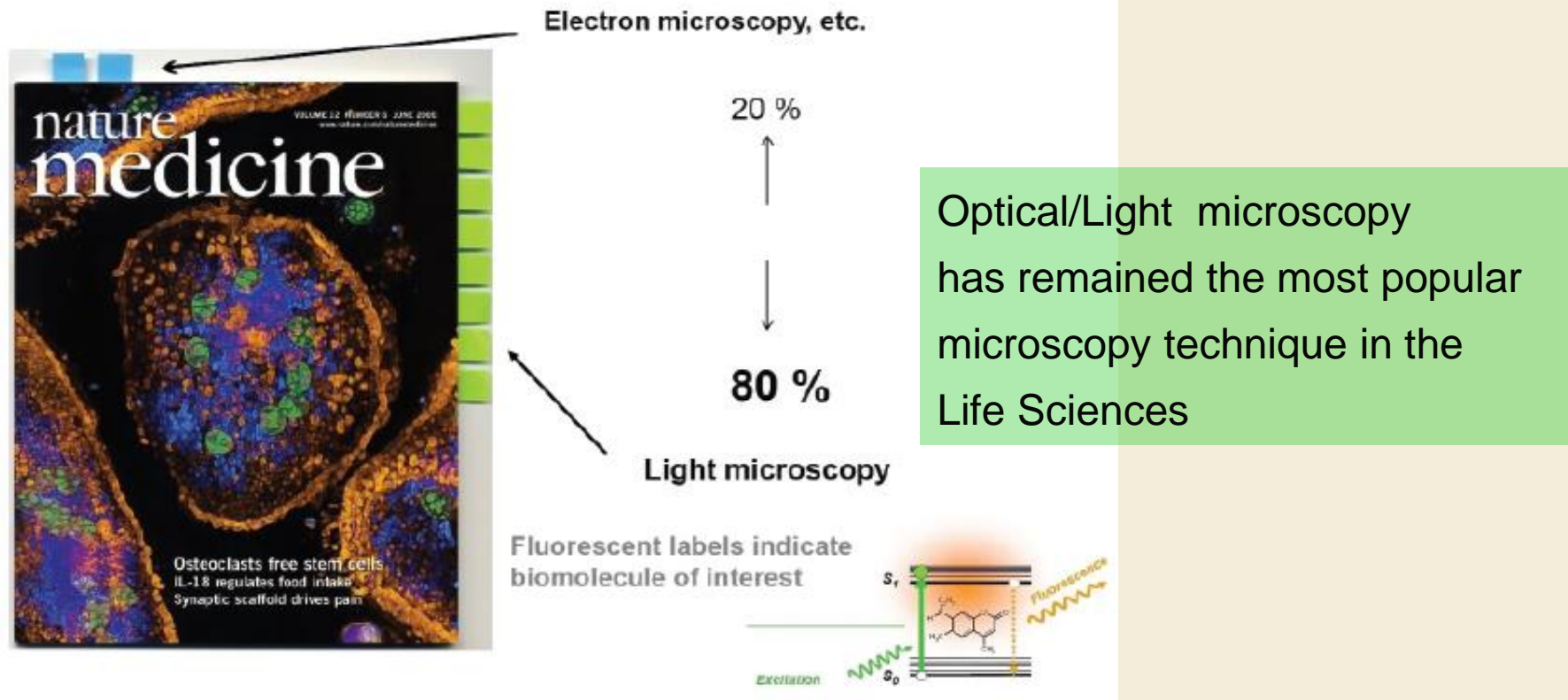

Optical microscopy is the only way in which we can look inside a living cell, or even living tissues, in three dimensions; it is minimally invasive.

When we look into a cell, we are usually interested in a certain species of proteins or other biomolecules, and we have to make them distinct from the rest, we have to “highlight” those proteins → fluorescence.

Confocal Microscopy

Abbe's Criterion

$$\Delta x \approx \frac{\lambda}{2n \sin \alpha}$$

diffraction resolution limit

Two Pinholes ("Laser" and "Detector") are conjugated with respect to the Lens.

Therefore, the rays coming from planes **other** than the Focal plane are **rejected**.

Axial Resolution is enhanced.

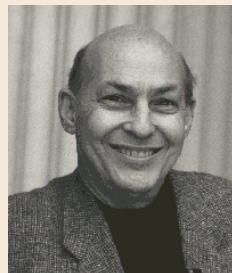
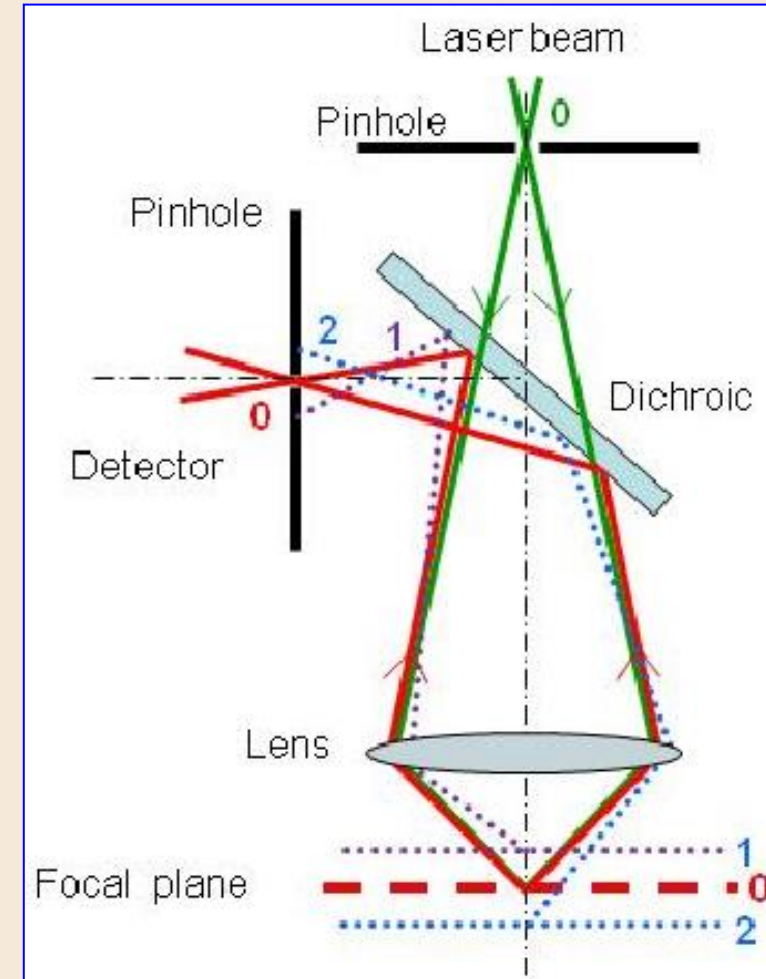

Marvin Minsky -1955

Minsky had the goal of imaging neural networks in unstained preparations of living brains.

Confocal Microscopy : ~2 X gain in Resolution

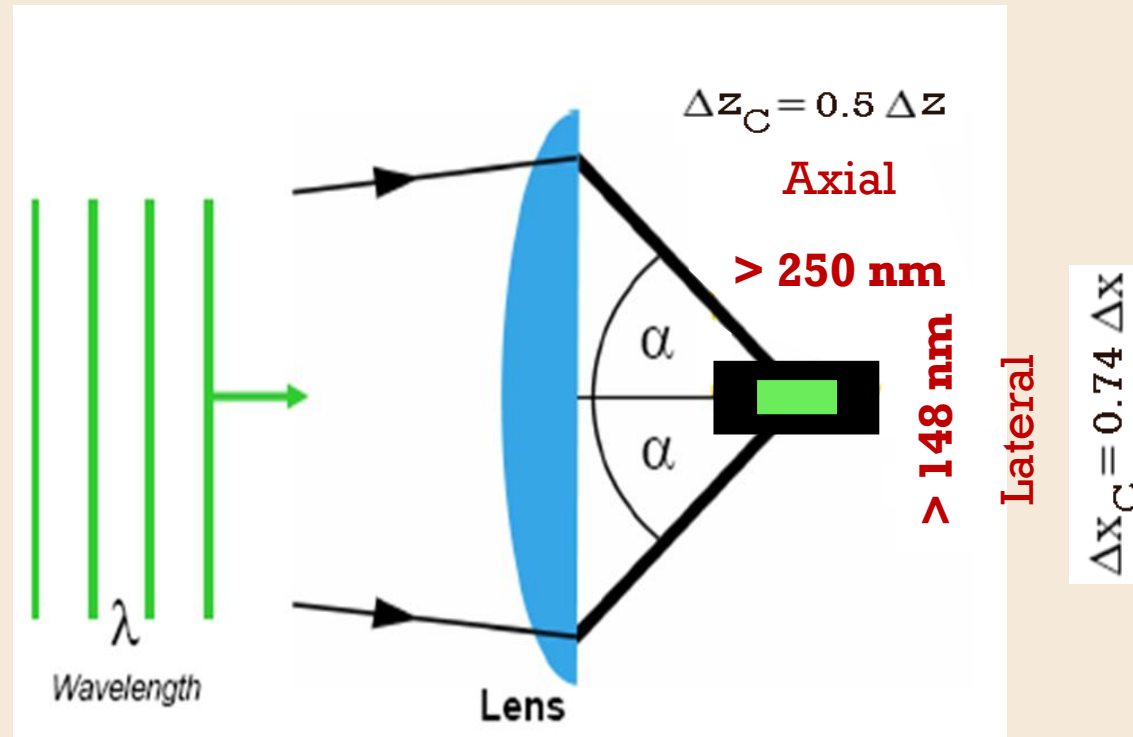

- the gain in resolution is obtained mechanically limiting the size of the excitation and detection spots (by means of pinholes).
- !! fluorescent molecules from planes other than focal plane are excited as well

STED Microscopy ~ 10 X gain in Resolution

"Breaking the diffraction resolution limit by stimulated emission"

Hell & Wichmann, *Opt. Lett.* 19, 11, (1994)

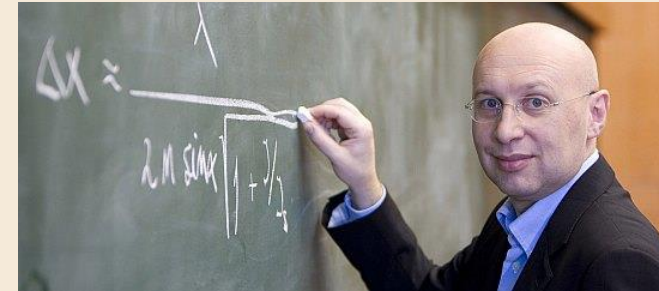
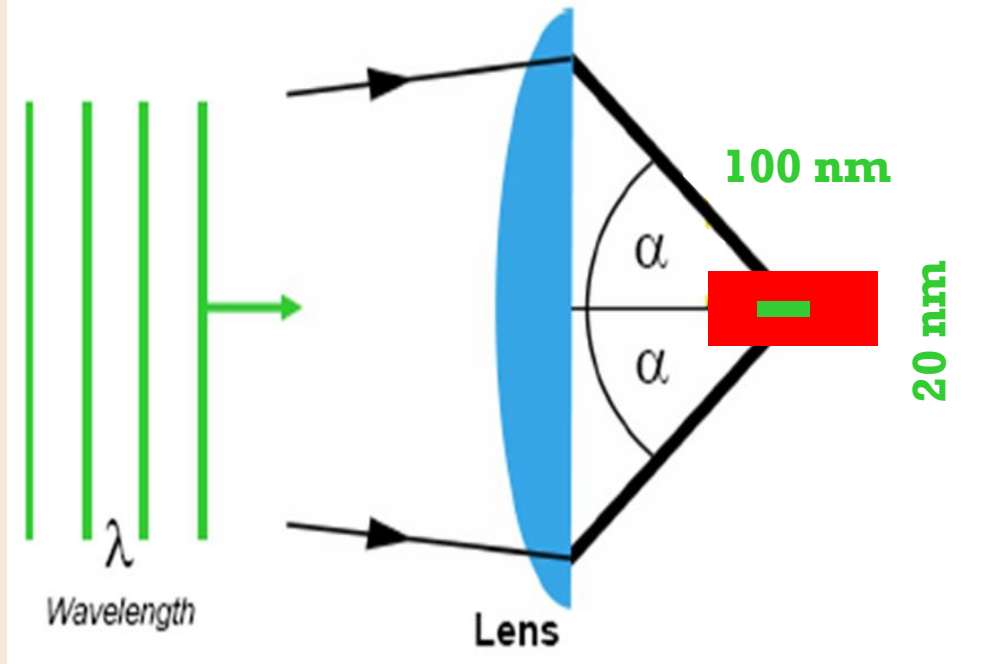

Stefan W. HELL

'Modifying' Abbe's

$$\Delta X = \frac{\lambda}{2n \sin \alpha \sqrt{1 + \frac{I}{I_s}}}$$

diffraction resolution limit

The gain in resolution is obtained **photonicly limiting** the size of the excitation spot, by means of a second laser for **STED – STimulated Emission Depletion**, switching the dye molecule between excitation to ground state

Two main concepts are used in STED:

- Stimulated Emission
- Laser beam shaping ('donut' beam)

And a fundamental IDEA: STATES SWITCHING

**Resolve the image of the object points in the sample
separating them by molecular ON/OFF states rather than
by just focusing the light.**

Stimulated Emission

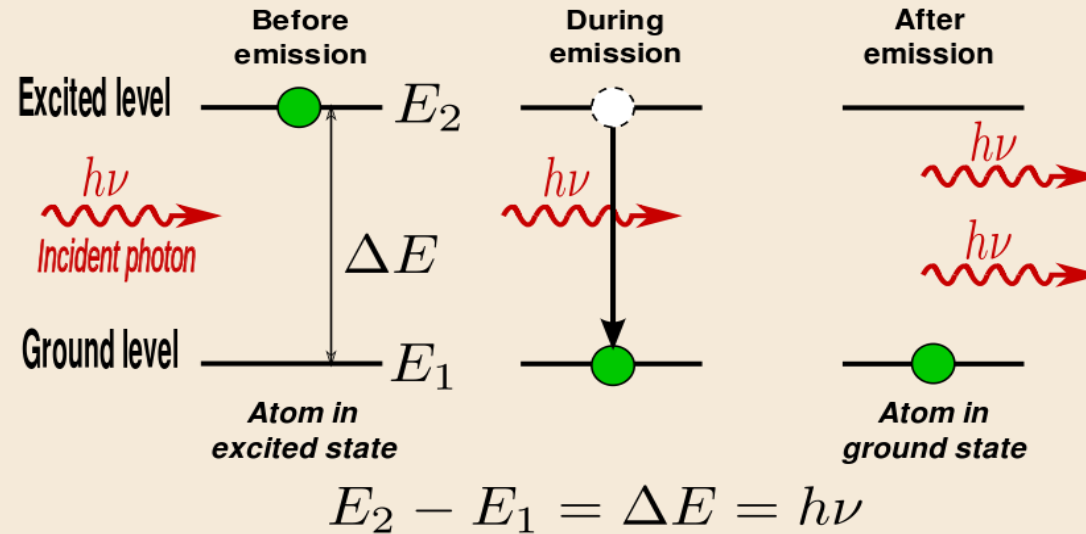

Stimulated emission is the process by which an incoming photon of a specific frequency can interact with an excited atomic electron (or other excited molecular state), causing it to drop to a lower energy level.

The liberated energy transfers to the EM field, creating a new photon with phase, frequency, polarization, and direction of travel that are all **identical** to the photons of the incident wave.

This is in contrast to spontaneous emission, which occurs at random intervals without regard to the ambient electromagnetic field.

Gaussian vs Donut BEAMS

MAX Intensity
In the center

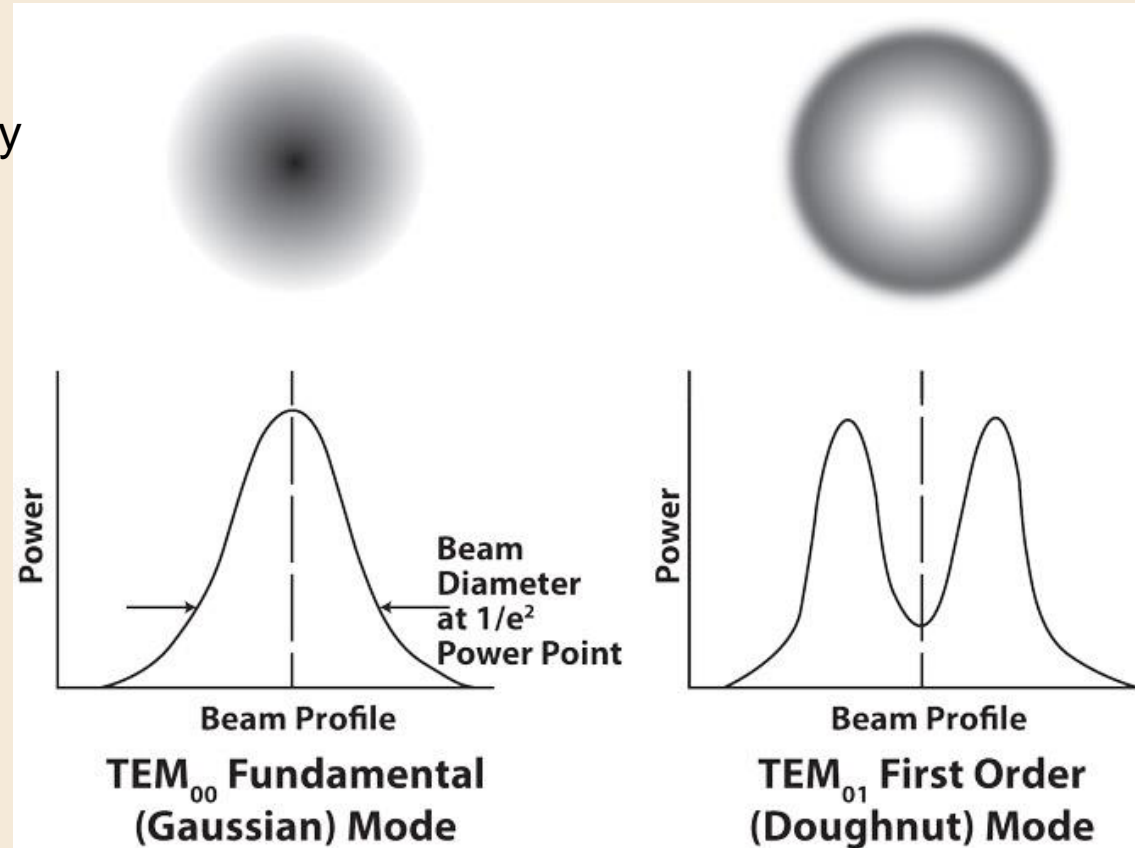

MIN Intensity
In the center

There are different ways to convert a Gaussian beam to a Donut (Helical Beam) beam.

E.g. Using a Spiral Phase Plate

www.thefabricator.com/thefabricator/article/lasercuttin

<https://commons.wikimedia.org/wiki/File:Spiral->

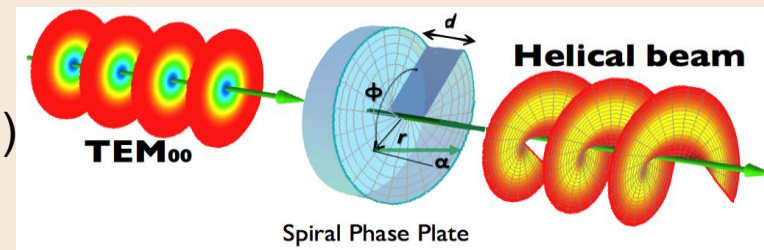

STATES SWITCHING IDEA

we switch off the fluorescence of one point (POINT 1)

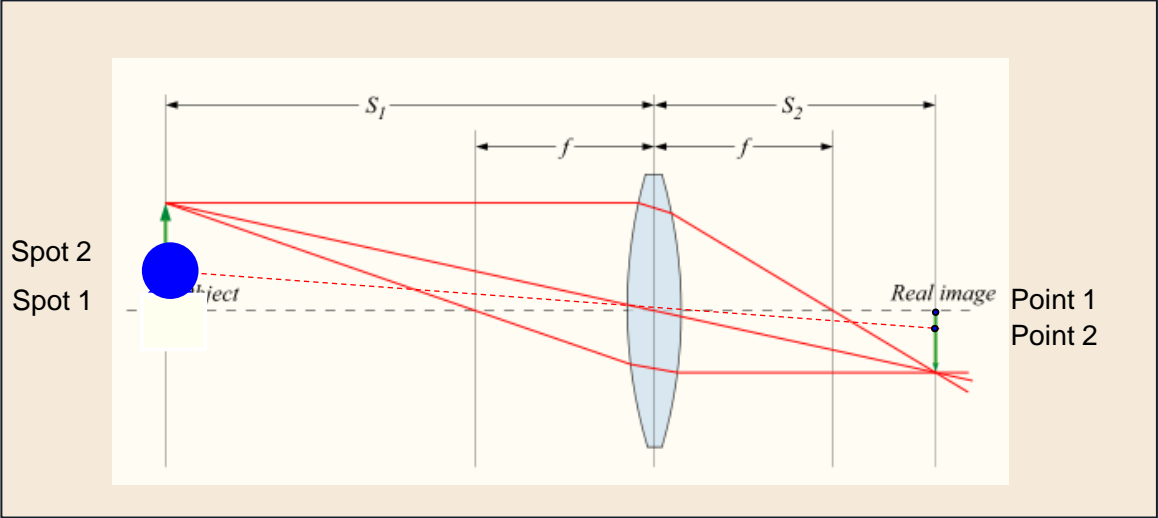

We see the image (spot) of the POINT 2

Since Point 1 does not emit fluorescence light

STATES SWITCHING IDEA

we switch off the fluorescence of POINT 2

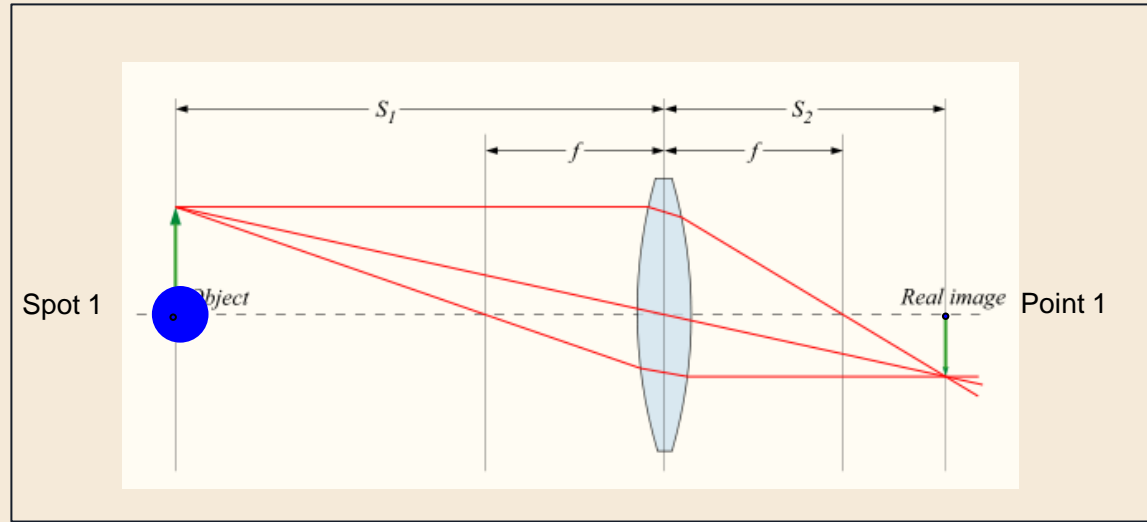

We see the image (spot) of the POINT 1

Since Point 2 does not emit fluorescence light

We resolve the points if we can switch ON/OFF the state of the dye molecules !

Molecular STATES SWITCHING IDEA !!!!!

What does it take to achieve the best resolution ?

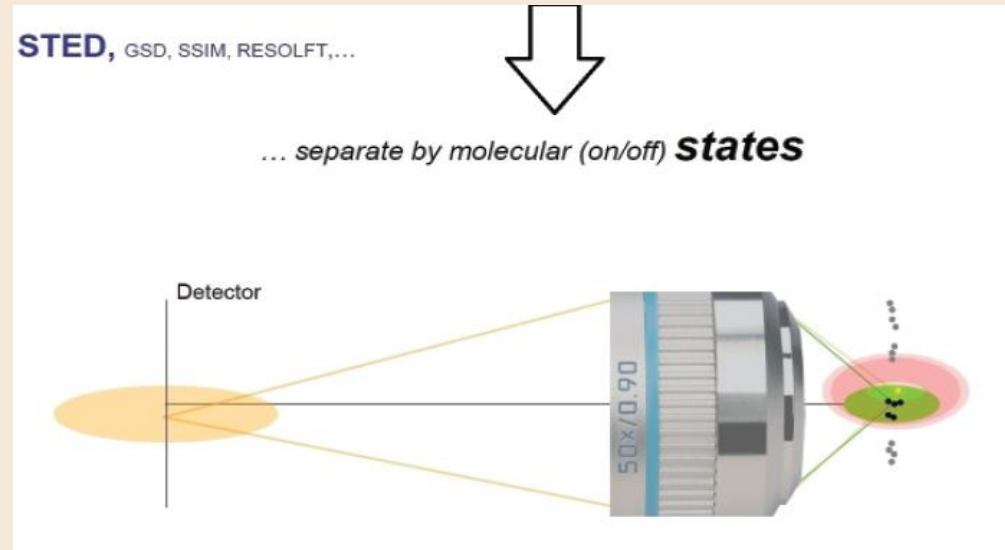
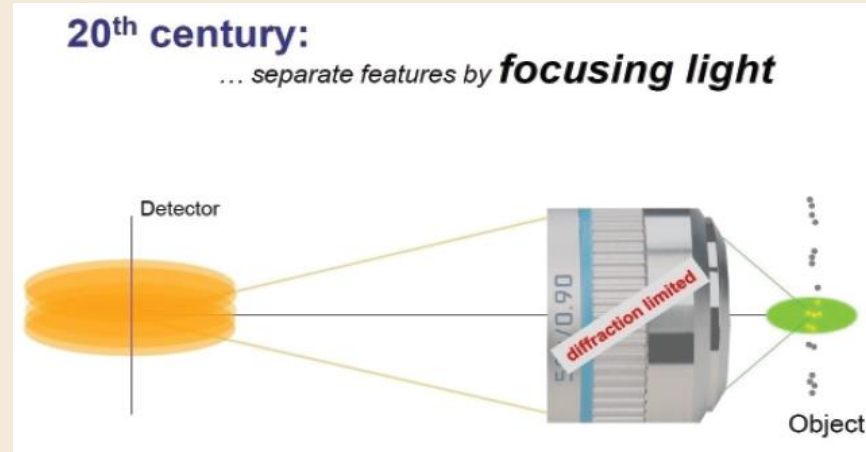

**Do not separate just by focusing the light !
Separate also by switching the molecular states ON/OFF !**

Switching characteristics

To switch a fluorescent molecule ON or OFF requires **two states**:
a **fluorescent (ON)** state and a **dark (OFF)** state,
connected by a transition representing the actual switch.

Several states in a fluorophore are suitable for such transitions:

- S0 (ground state) and S1 (singlet state) represents the basic and obvious pair of ON/OFF states. It is used in **Stimulated Emission-Depletion (STED)** and its versions: Saturated Pattern Excitation M/Saturated Structured Microscopy (SPEM/SSIM), Ground State Depletion (GSD).
- The concept referred to as **Reversible Saturable Optical Fluorescent Transition (RESOLFT)** includes switching isomerization (*cis-trans*) states and other optically bistable transitions in fluorophores, as do the landmark concepts **PhotoActivation Localization Microscopy (PALM)** and **Stochastic Optical Reconstruction Microscopy (STORM)**

STED Principle

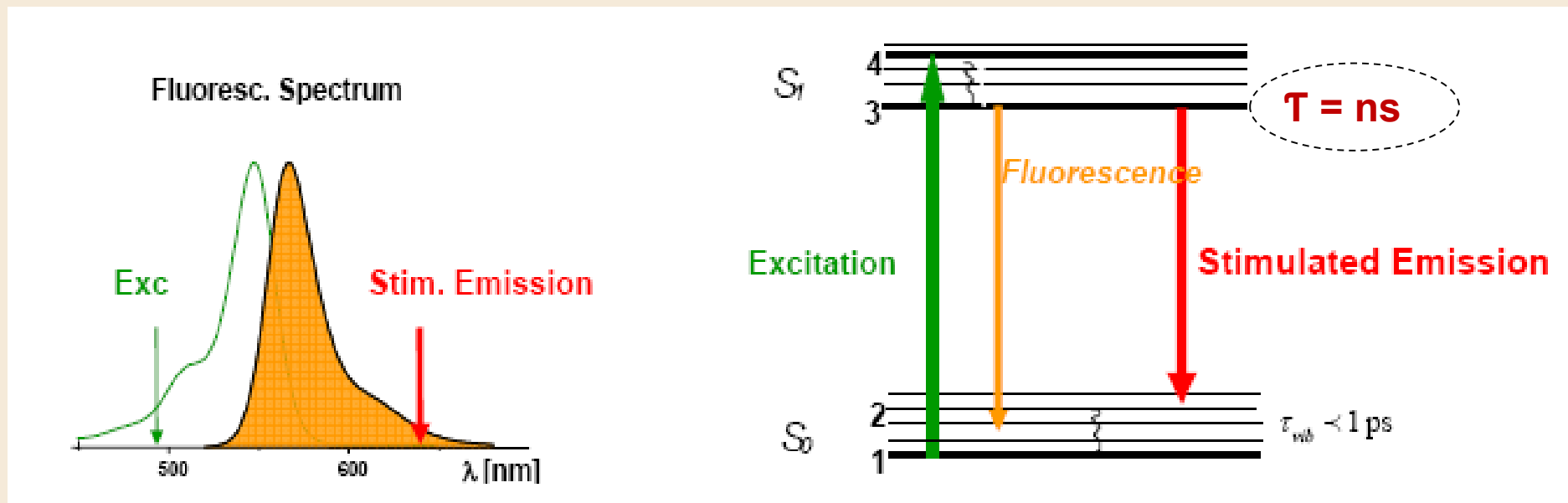

Abbe's

$$\Delta x \approx \frac{\lambda}{2n \sin \alpha}$$

diffraction resolution limit

STED

$$\Delta X = \frac{\lambda}{2n \sin \alpha \sqrt{1 + \frac{I}{I_s}}}$$

- I/I_s , is called “**saturation factor**” and determines the increase in resolution
- I , is the Intensity of the STED Laser;
- I_s , is the saturation intensity, i.e. the intensity of the STED laser at which the fluorescence drops to 1/e of its initial value. **$I_s \sim 1/T$!!!**
- I_s is **characteristic of the dye** used. (10–100 MW/cm² for organic dyes),
- Note that I/I_s can be very big, theoretically infinite → NO Resolution limit !!!

STED Principle

Optional

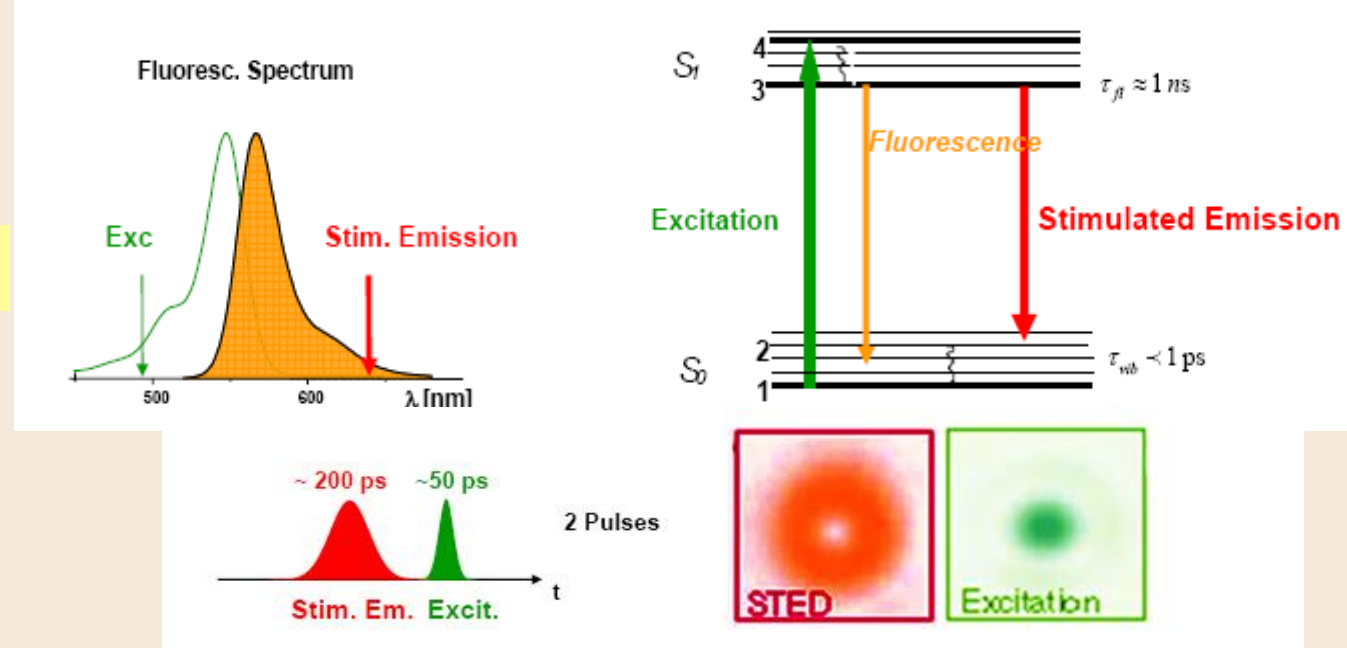

The STED photons act primarily on the excited state S_1 , inducing stimulated emission down to a vibrational sublevel of the ground state S_0 vib.

Subpicosecond vibrational decay empties S_0 vib, so repumping into S_1 is largely ineffective. By the time the STED pulse has vanished, the population of S_1 is:

$$N(h_{STED}) = N_0 \exp(-\sigma h_{STED}),$$

where N_0 is the initial population, $\sigma \approx 10^{-16} [\text{cm}^2]$ the cross-section for stimulated emission, and $h_{STED}(r)$ is the point-spread function (PSF) of the STED pulse in photons/area/pulse.

Hence, the fluorescence is reduced by a factor $\eta(h_{STED}) = \exp(-\sigma h_{STED})$.

Point Spread Function - PSF

Optional

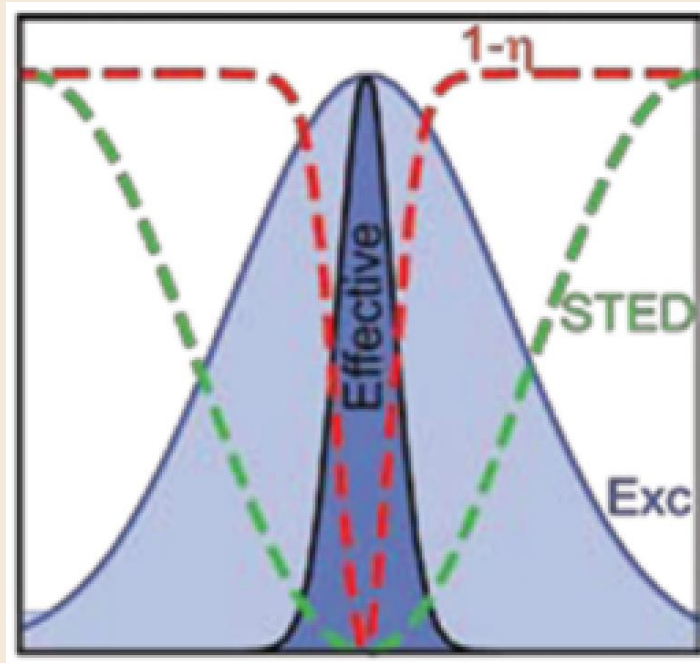

Normalized intensity profiles of the PSF (h) for:

Exc – PSF Excitation (Gaussian)

STED - PSF h_{STED} (Doughnut)

$1-\eta$ - de-excitation probability

Effective PSF:

$$\eta(h_{STED}) = \exp(-\sigma h_{STED}).$$

Potential of STED to resolve 16 nm was demonstrated

Disadvantage: requirement of intense (picosecond) pulses tending to boost multi-photon induced bleaching of the dye. This is due to the high value of the I_s ($100 \text{ MW} / \text{cm}^2$) determined by the saturation of stimulated depletion (σ)

STED Microscopy - Implementation

STED microscope

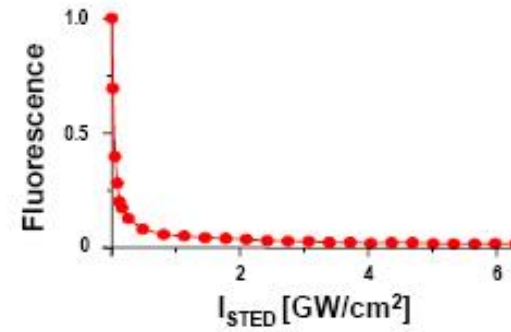
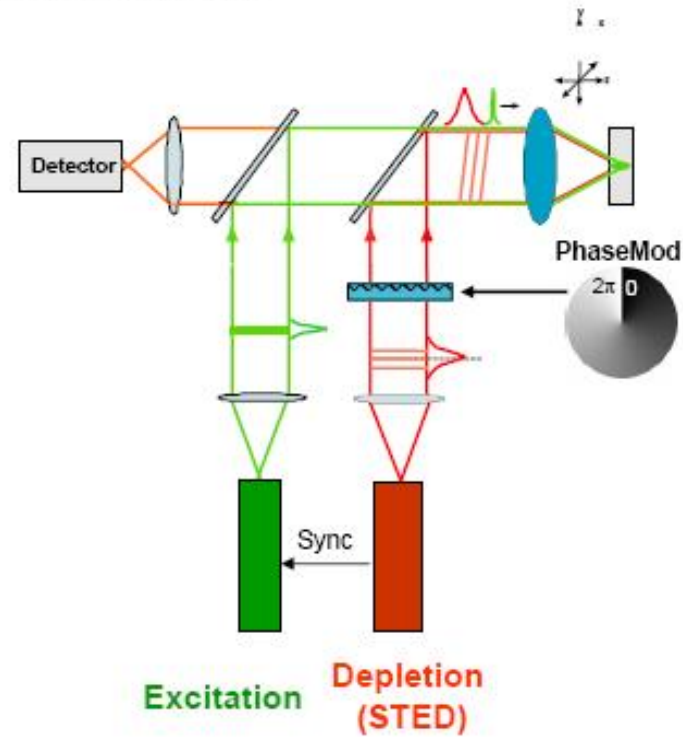

STED microscope

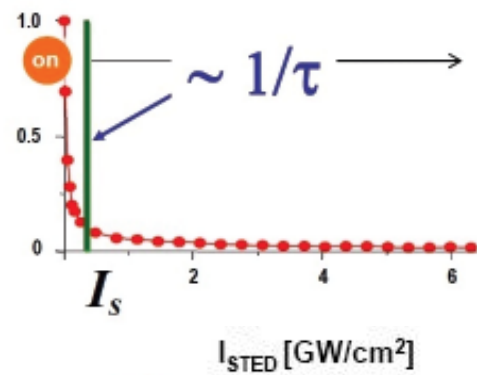
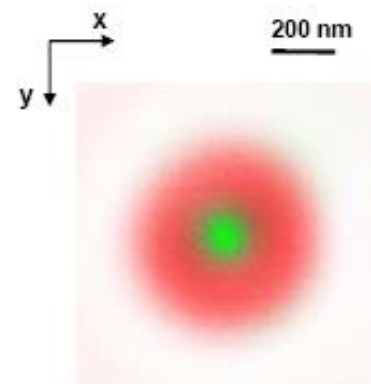
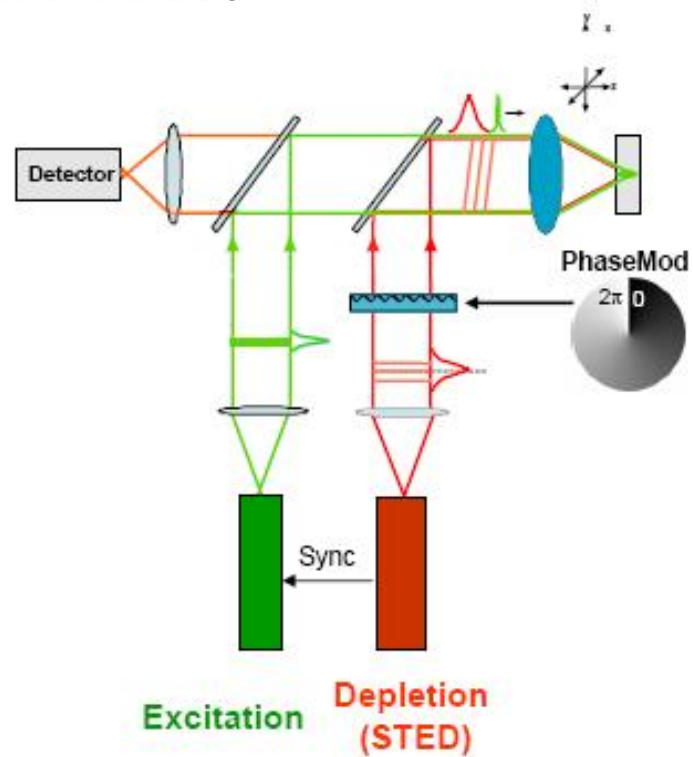

STED microscope

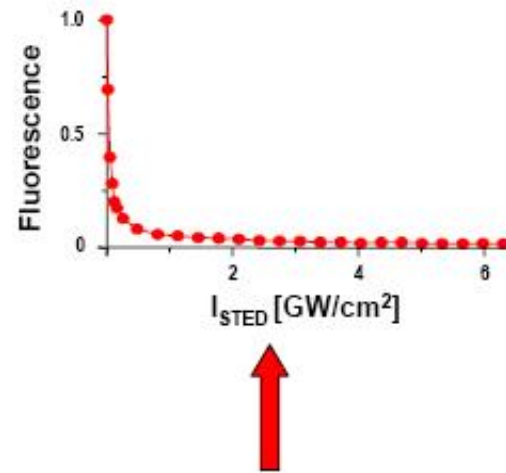
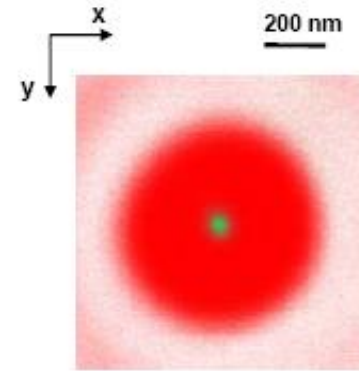
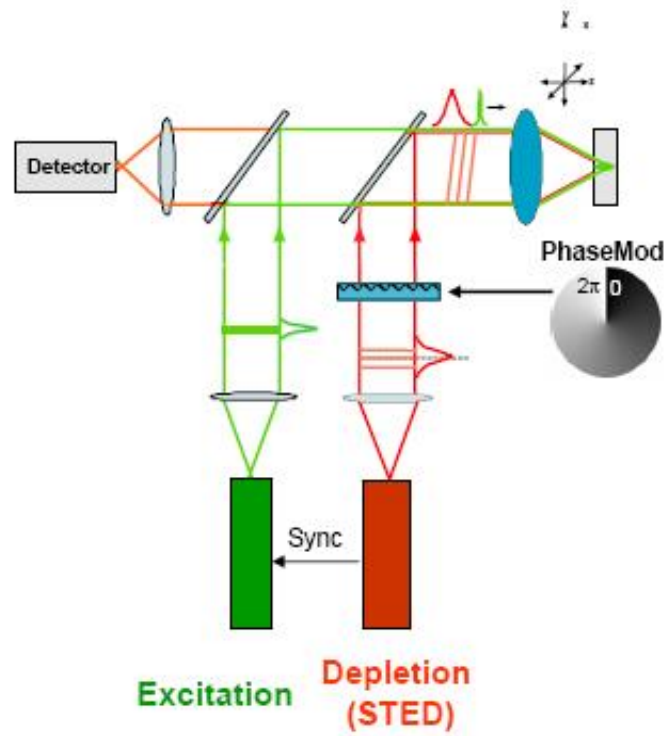

STED microscope

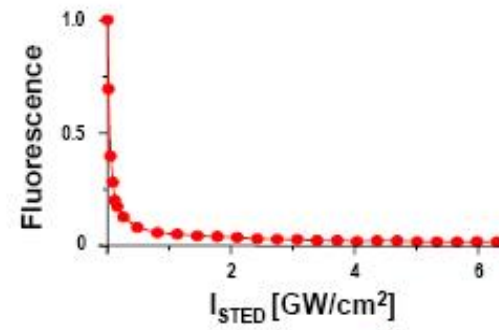
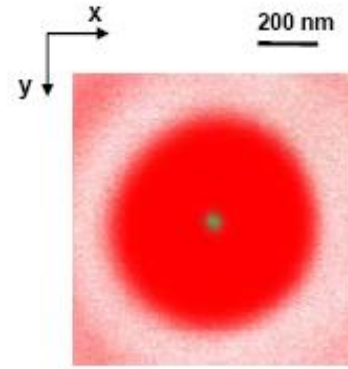
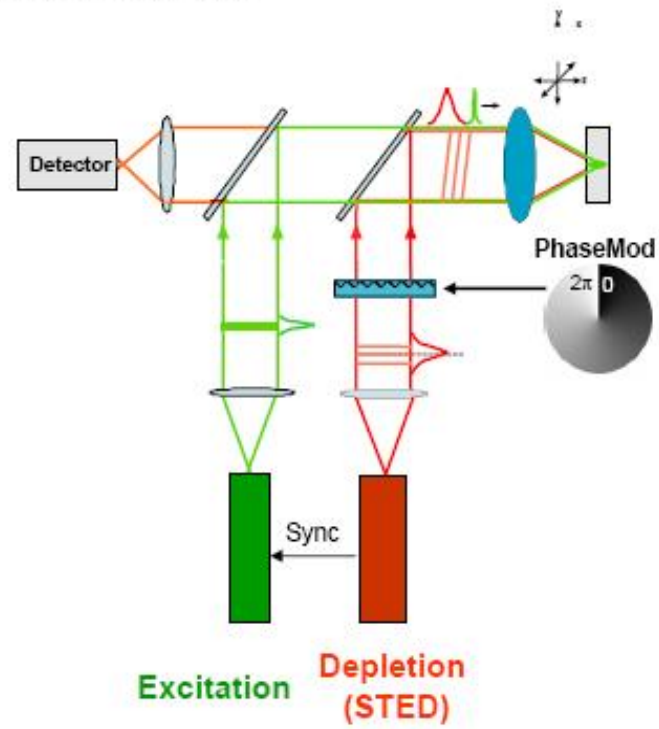

STED microscope

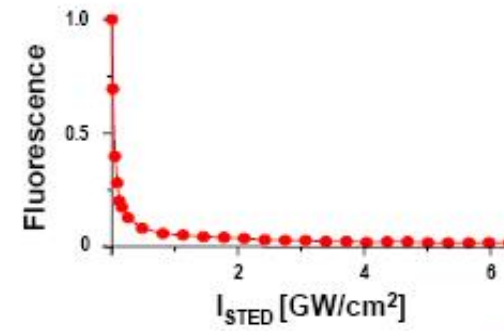
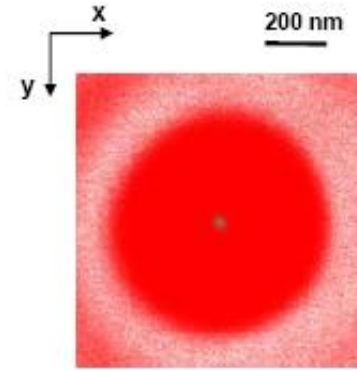
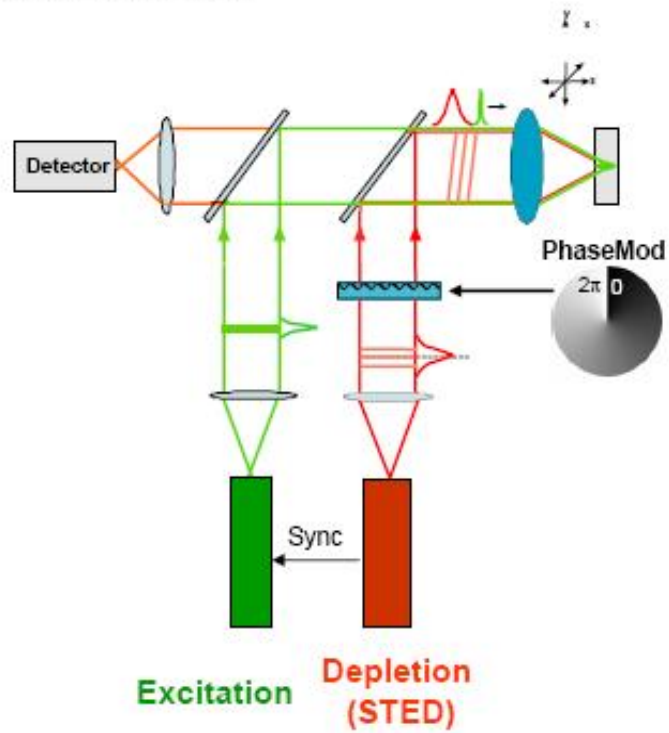

$$\Delta X \approx \frac{\lambda}{2n \sin \alpha \sqrt{1 + \frac{I}{I_s}}}$$

Potential of STED to resolve 15 nm was demonstrated

Disadvantage:

requirement of intense pulses tending to boost multi-photon induced bleaching of the dye. This is due to the high value of the I_s ($100 \text{ MW} / \text{cm}^2$), which is determined by the saturation of stimulated depletion (σ)

Damage of the biological samples !

Solution:

move toward InfraRed (find adequate dyes) !

Another issue is the size of the dye molecules which begin to be of the same value as the resolution |

Potential of STED to resolve 15 nm was demonstrated

Disadvantage:

requirement of intense pulses tending to boost multi-photon induced bleaching of the dye. This is due to the high value of the I_s ($100 \text{ MW} / \text{cm}^2$), which is determined by the saturation of stimulated depletion (σ)

Damage of the biological samples !

Solution:

move toward InfraRed (find adequate dyes) !

Another issue is

the size of the dye molecules which begin to be of the same value as the resolution |

**STED implementation and
some examples of confocal vs STED imaging**

STED microscopy with a **supercontinuum laser source**

One channel setup

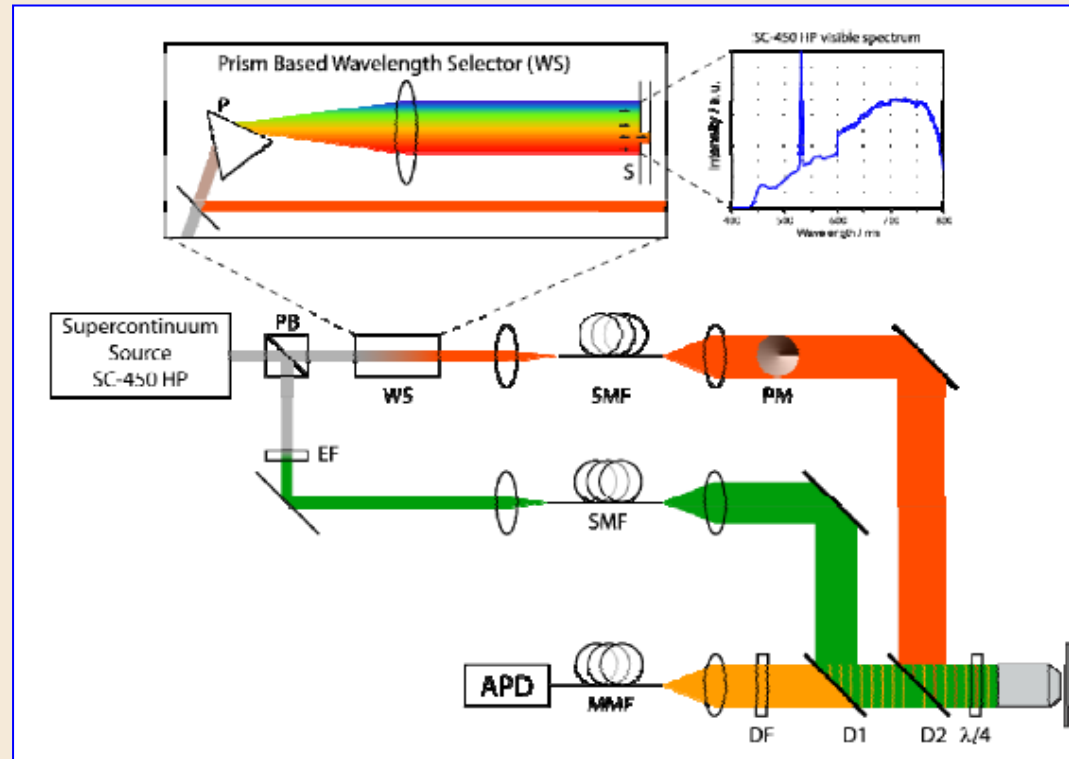

Wildanger et al , 2008

The randomly polarized laser beam is split into two beams using a polarizing beamsplitter cube (PB) from which the excitation and STED wavelengths are extracted by means of an interference filter (EF) and a prism-based wavelength selector (WS), respectively. Both beams are spatially filtered by coupling them into single-mode fibers (SMF), expanded and coupled into a confocal setup using two dichroic beamsplitters (D1, D2). The focal doughnut is created by passing the STED beam through a vortex phase mask (PM). DF: detection filter, MMF: multimode fiber; APD: avalanche photodiode; P: prism; S: slit.

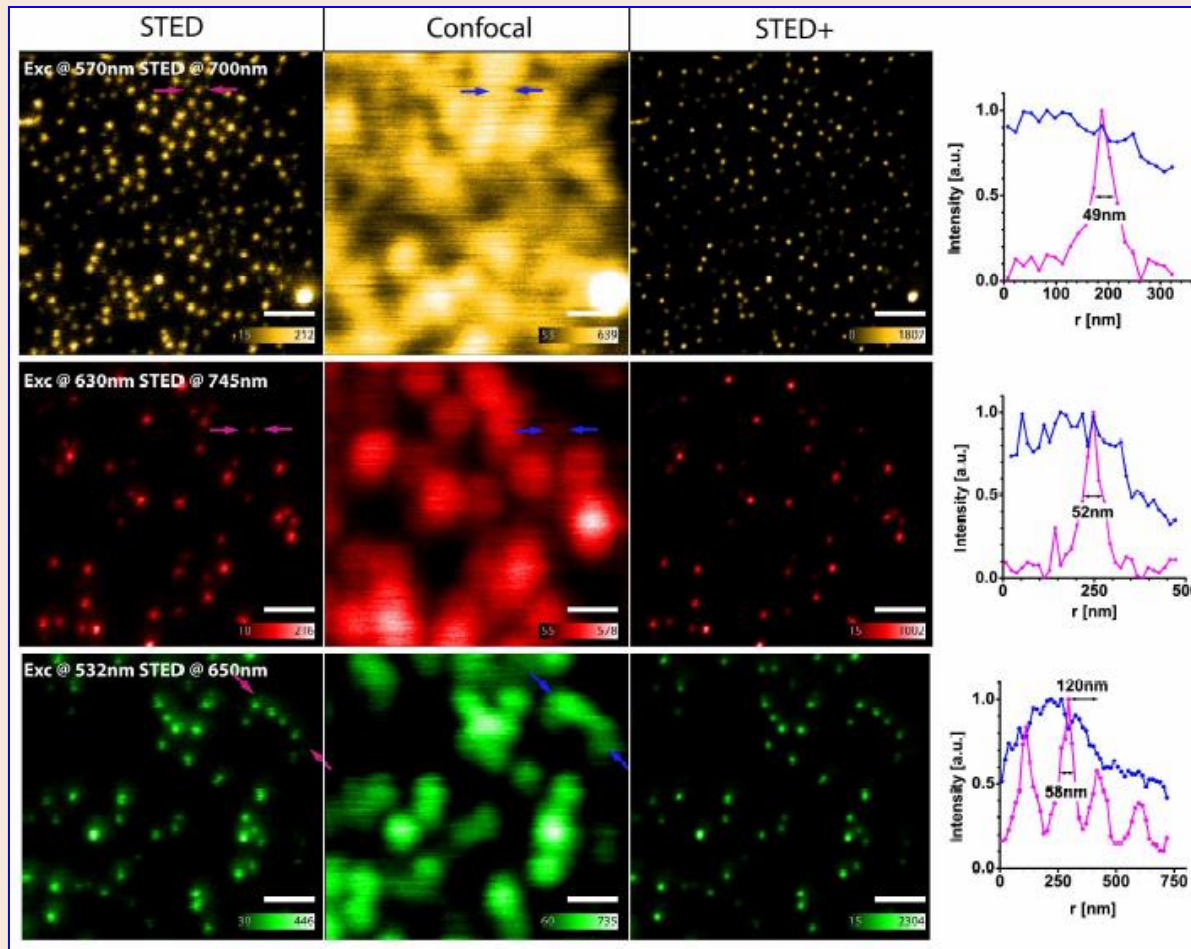

Scale bar: 500 nm.

Wildanger et al , 2008

Comparison between confocal (middle) and STED images (left) of randomly dispersed **40 nm fluorescent beads** at the indicated wavelengths.

The upper, center, and lower row show the data of red, crimson, and orange beads, respectively. Postprocessing the raw data (left) by a deconvolution algorithm further enhances the details (STED+, right).

The line profiles along the traces indicated by blue and purple arrows demonstrate that full-width at- half-maximum values between **49 nm and 58 nm** were achieved in the raw data.

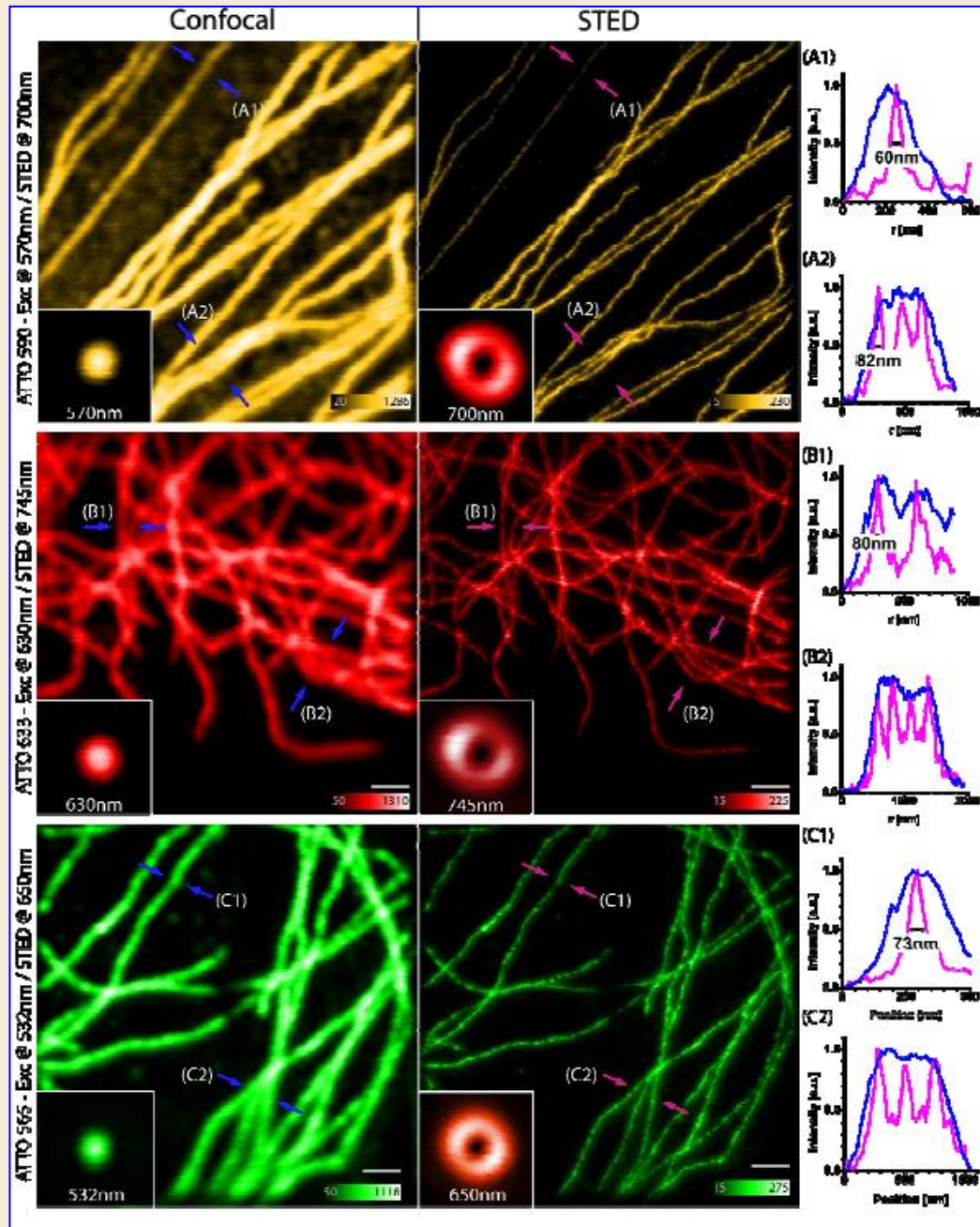

Immunolabeled **tubulin fibers** imaged with an excitation wavelength of 570 nm (top), 630 nm (middle), and 532 nm (bottom).

The comparison between the confocal reference image (left) and the STED image (right) reveals the gain in structural information obtained by STED; note that all images represent raw data.

The line profiles along the traces indicated by the blue and purple arrows highlights details in the STED image (purple) that are not discerned by the confocal microscope (blue).

Scale bar: 1 μm .

STED microscopy with a **supercontinuum laser source**

Multi-lifetime/multi-color STED microscope

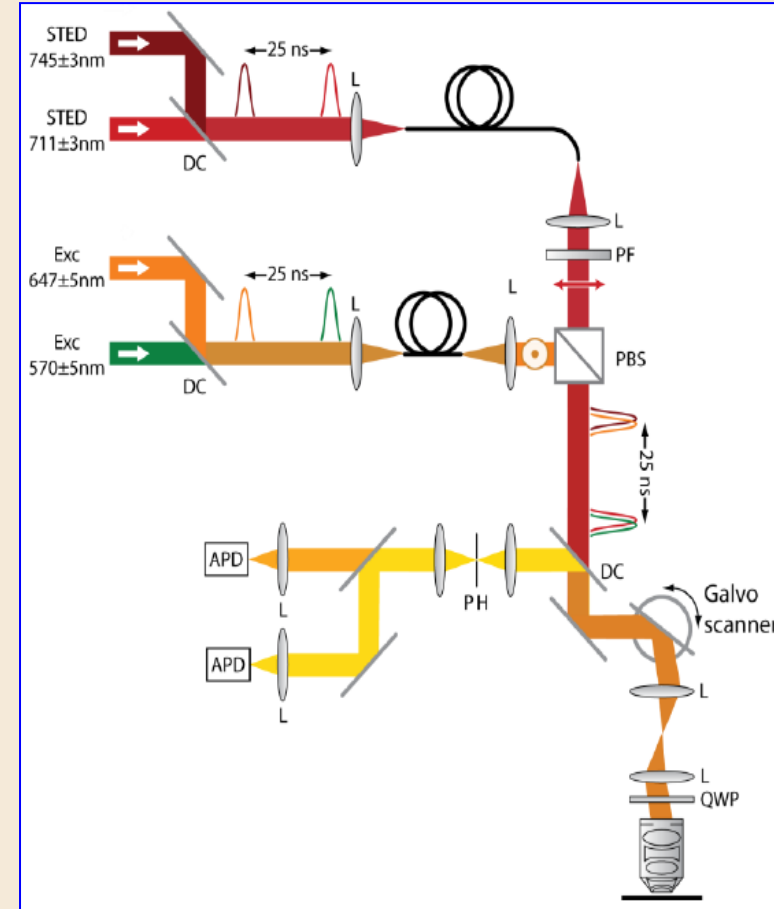
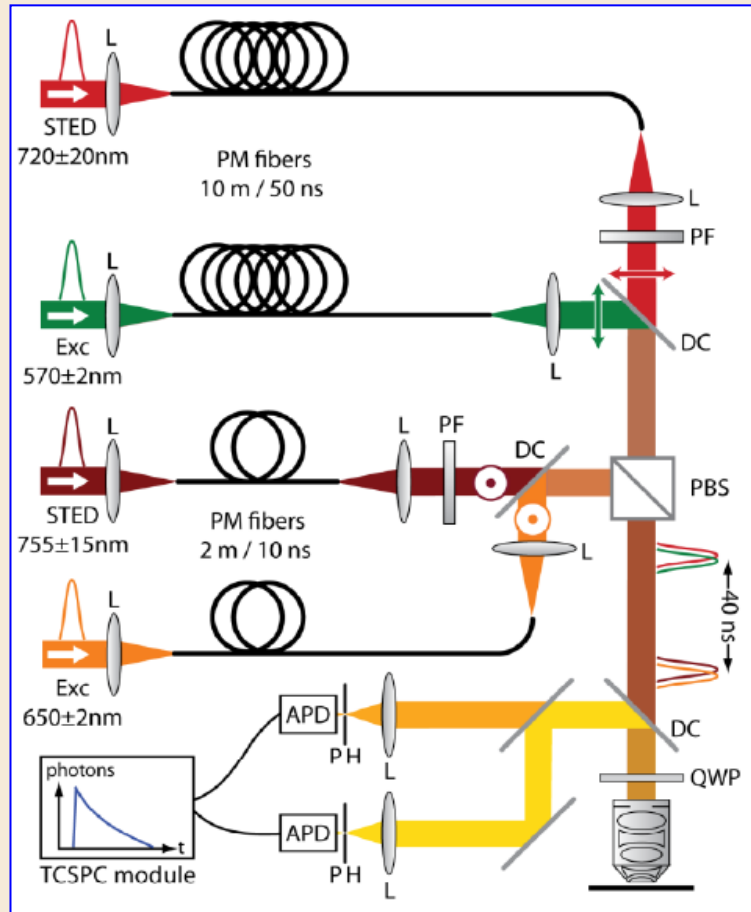

Bückers et al , 2011

Hippocampal neuron – actin and microtubules imaging with STED

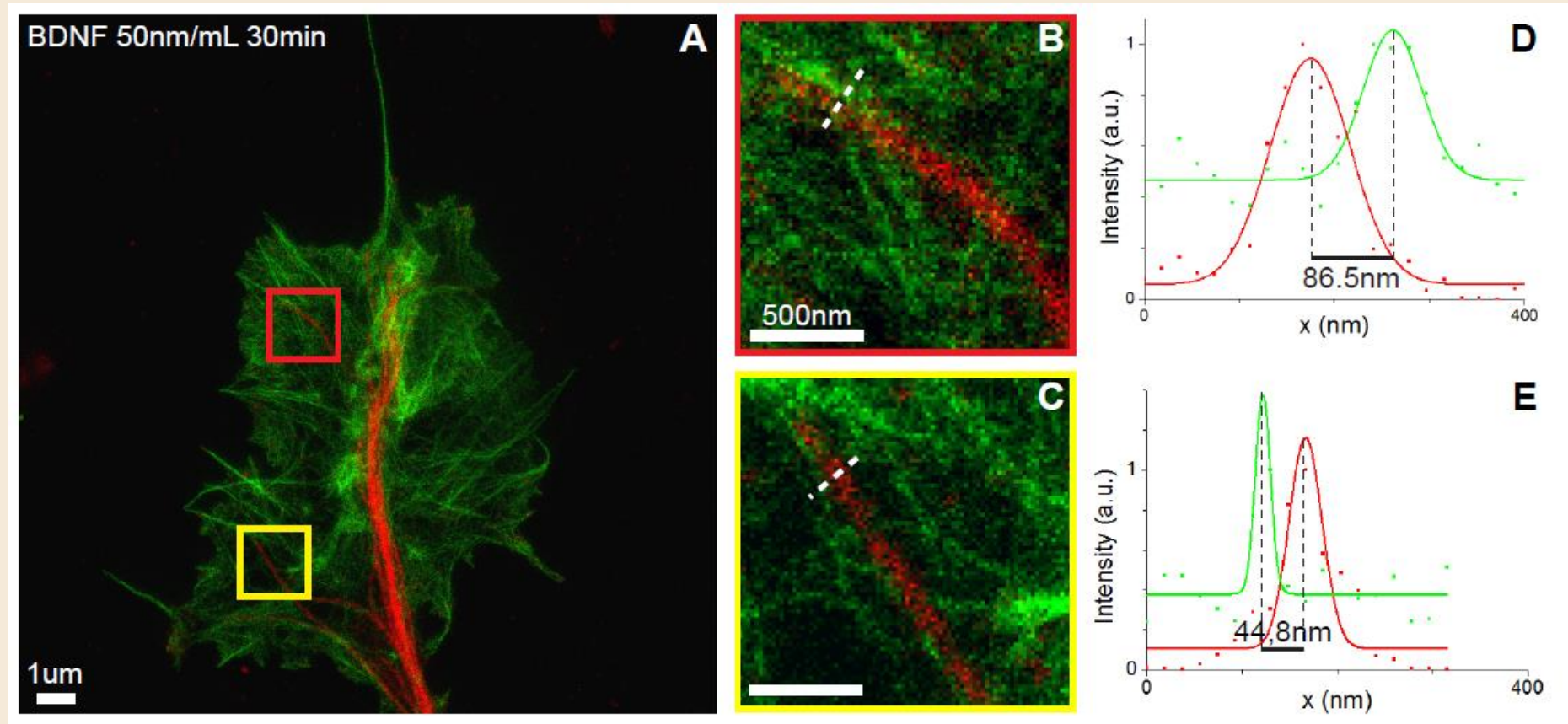

E. D'Este et al 2013

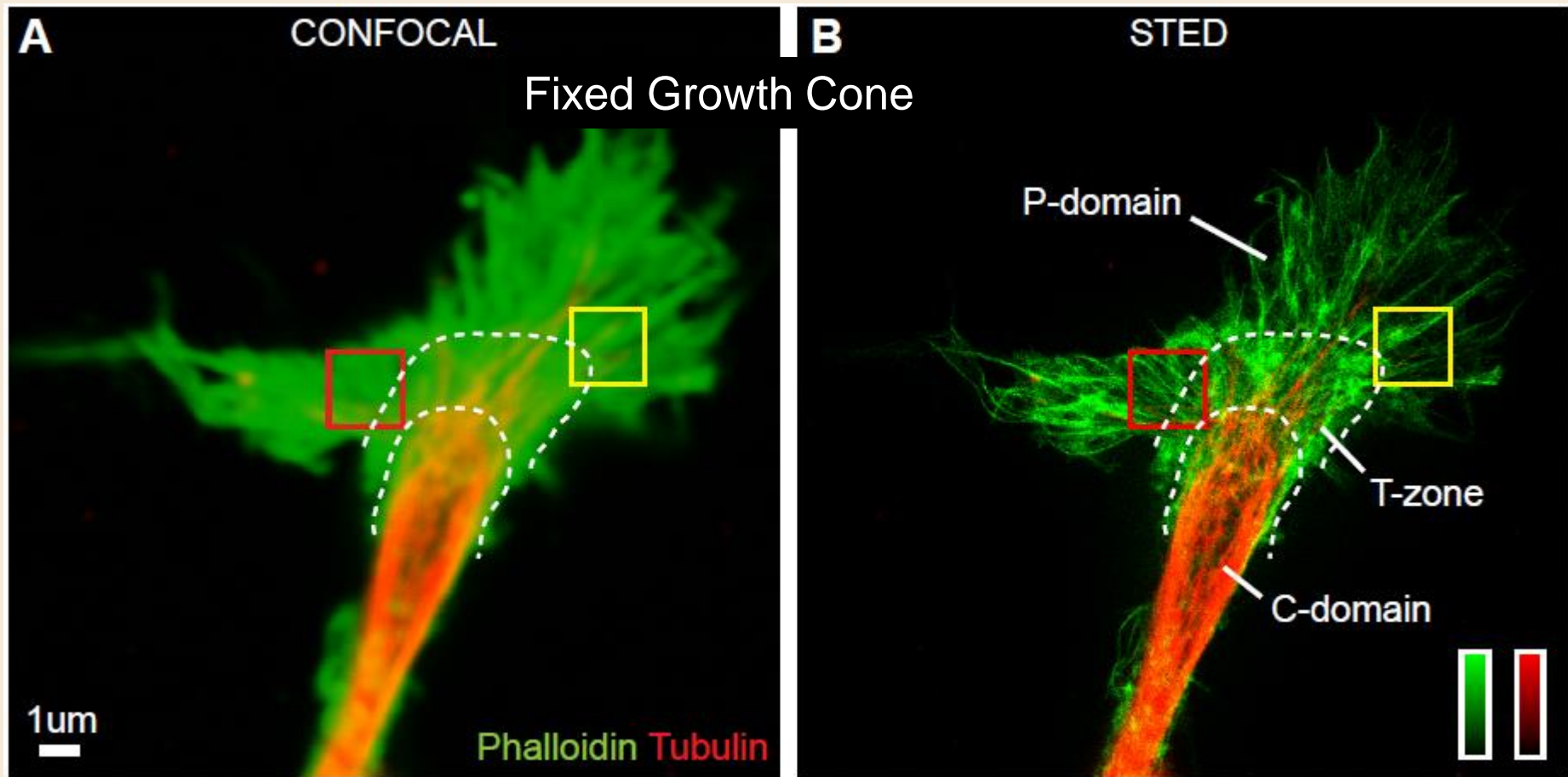

Elisa D'este @ Stefan Hell group in Goettingen – 2013

Since June 2019 Elisa is the Head of Optical Microscopy facility,
MaxPlanck Institute for Medical Research, Heidelberg

STED microscopy with a **supercontinuum laser source**

Two STED for superresolution both lateral and axial (3D)

Resolution: Lateral 40 nm, Axial 100 nm

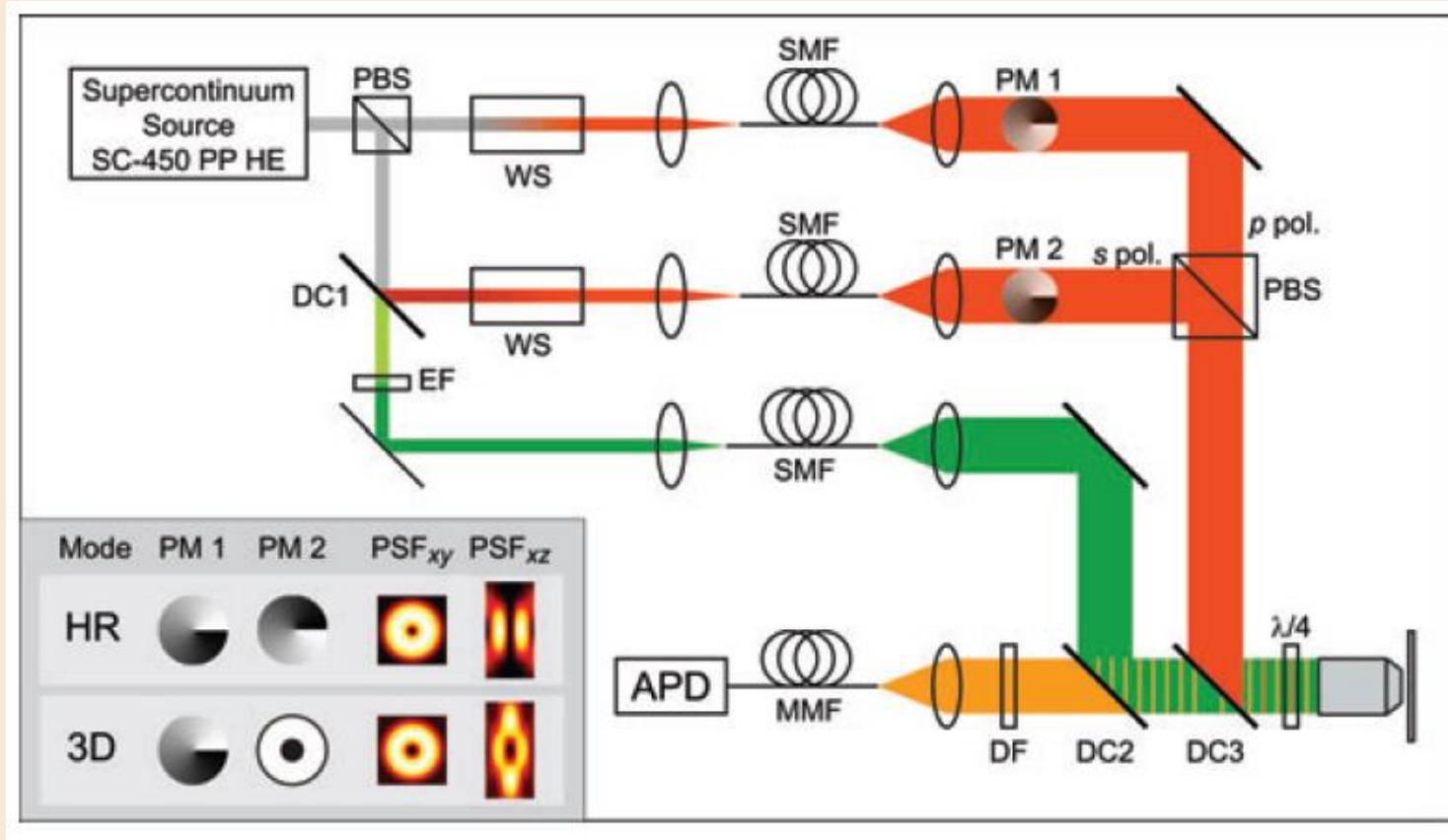

Wildanger et al , 2009

3D imaging of immunolabelled microtubules

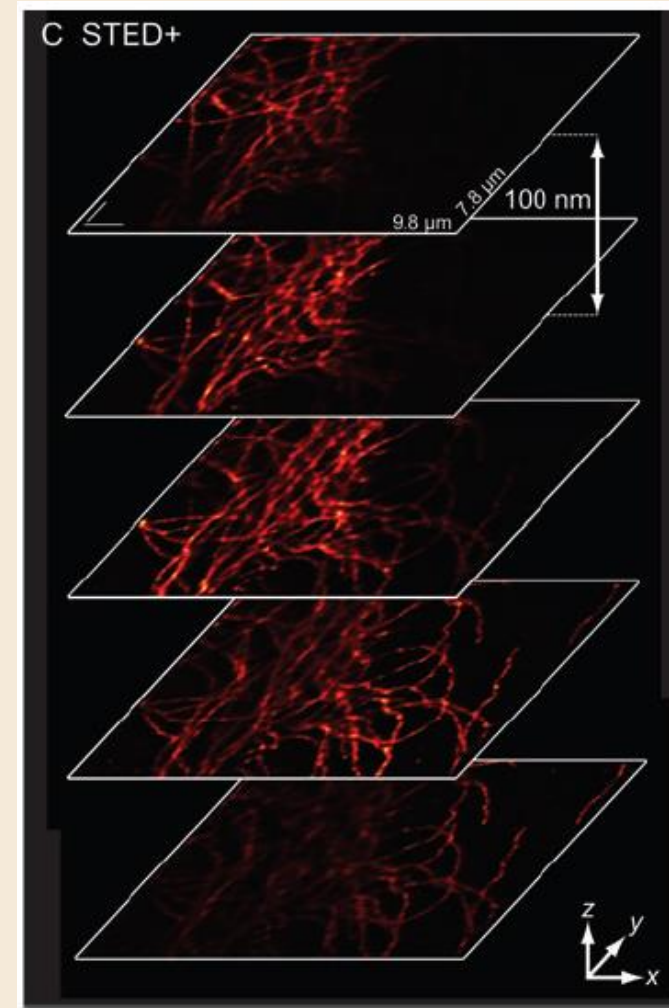
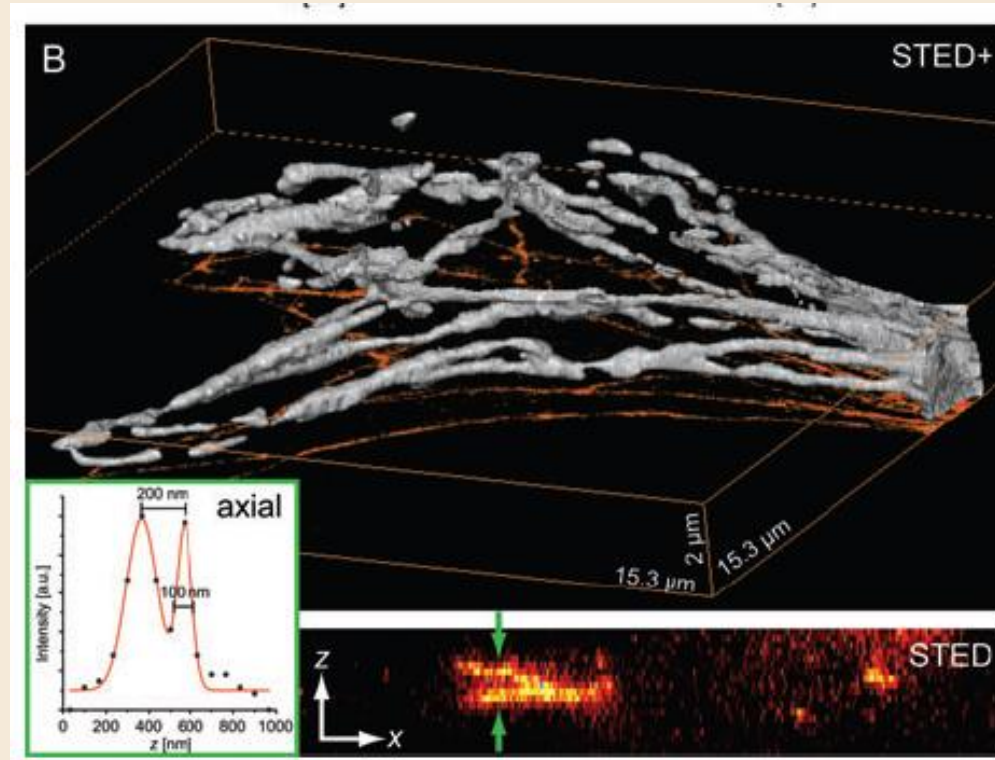

Nanoscopy in a Living Mouse Brain

Sebastian Berning,¹ Katrin I. Willig,^{1*} Heinz Steffens,¹ Payam Dibaj,² Stefan W. Hell^{1*}

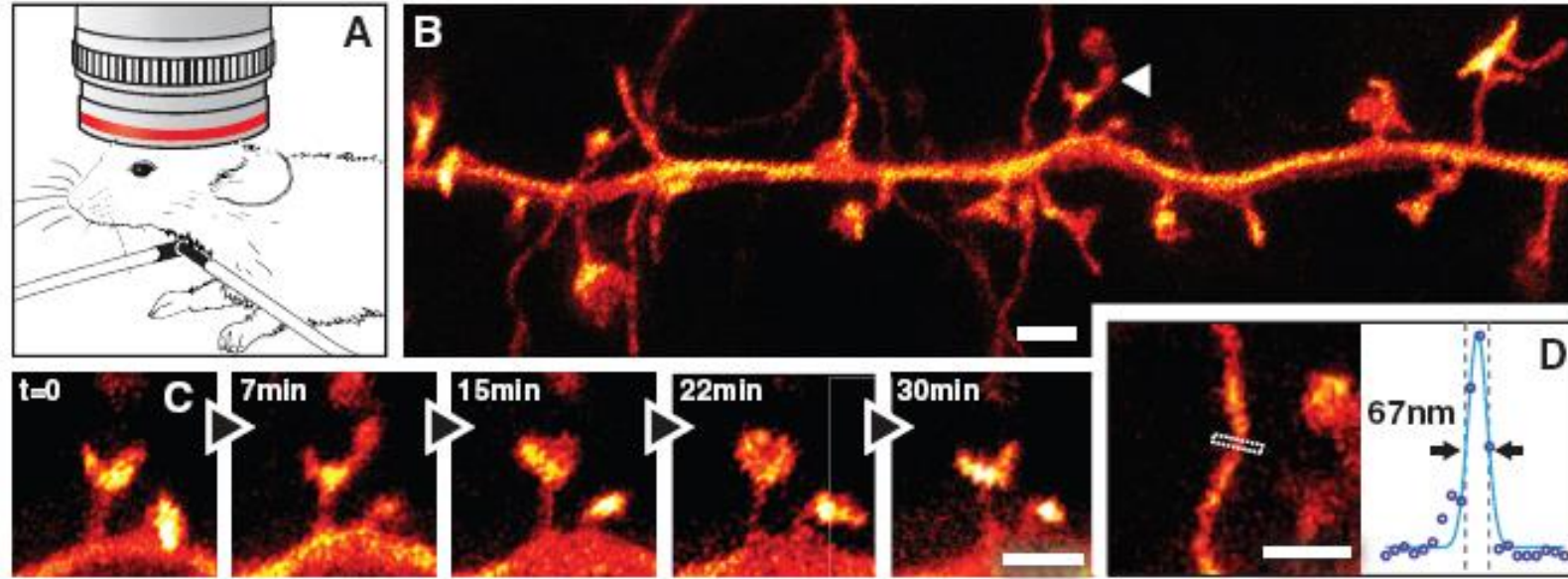

Fig. 1. STED microscopy in the molecular layer of the somatosensory cortex of a mouse with EYFP-labeled neurons. **(A)** Anesthetized mouse under the objective lens (63 \times , NA 1.3, glycerol immersion) with tracheal tube. **(B)** Projected volumes of dendritic and axonal structures reveal **(C)** temporal dynamics of spine morphology with **(D)** an approximately fourfold improved resolution compared with diffraction-limited imaging. Curve is a three-pixel-wide line profile fitted to raw data with a Gaussian. Scale bars, 1 μ m.

RESOLFT – REversible Saturable Optical Fluorescence Transitions

RESOLFT using reversible photoswitchable proteins (Hoffmann PNAS 2005)

asFP595 – features two metastable reversible states: ON (em 605) fluo-activated metastable state – exc yellow (568), and OFF state exc blue (458);

The levels of intensities required to switch from ON to OFF are very low (few W/cm^2 are enough for saturation \rightarrow inhibition requires intensities about

8 orders of magnitudes lower than required for stimulated depletion !

There are also disadvantages as : low quantum yield etc but the idea is this:

To increase the saturation factor I/I_s , we have two options:

increase **I** (STED) or reduce **I_s** (RESOLFT with switchable proteins)

$$\Delta X = \frac{\lambda}{2n \sin \alpha \sqrt{1 + \frac{I}{I_s}}}$$

Categories of fluorescent proteins FP

Examples:

mCherry

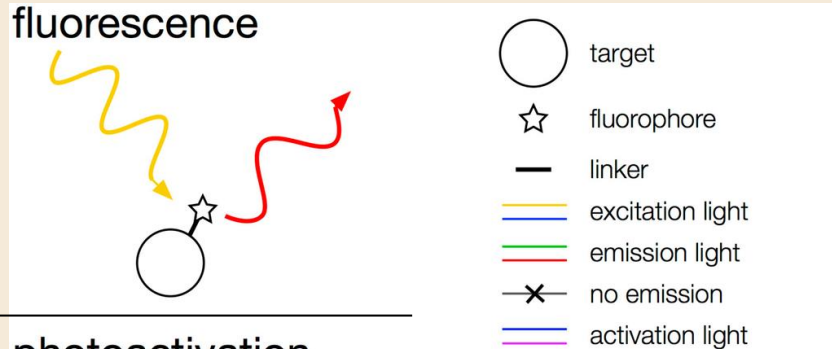

PAmCherry

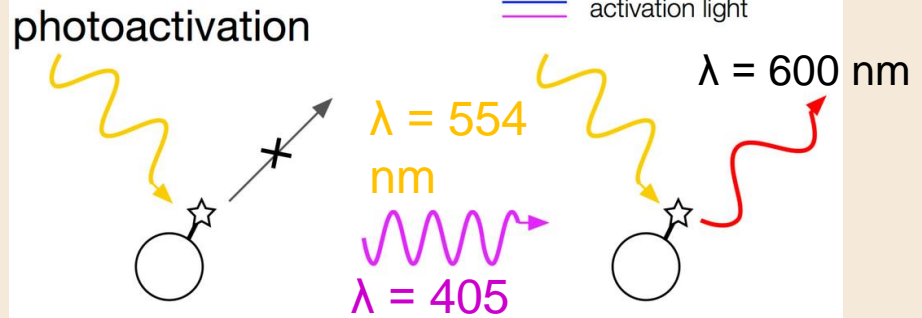

Dendra2

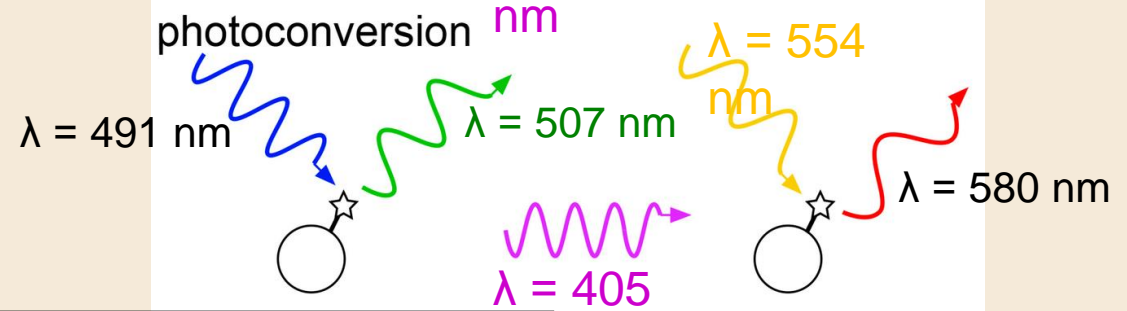

Dronpa

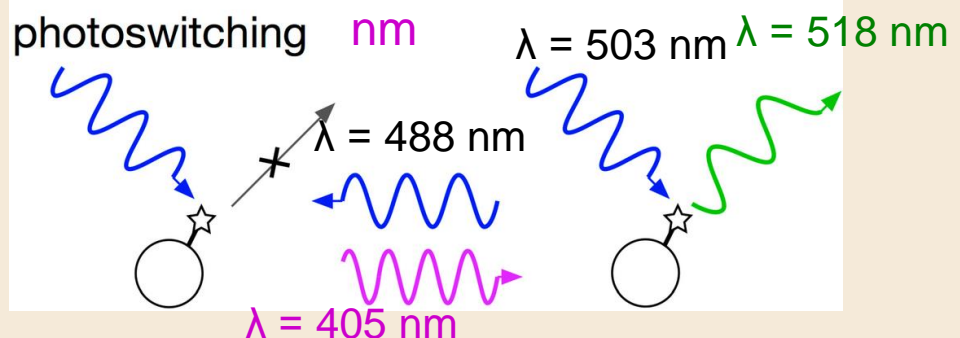

PALM (Photo-Activated Localization Microscopy) Eric Betzig 2006

STORM (STochastic Optical Reconstruction Microscopy) Sam Hess 2006

This technique takes advantage of the new generation of photo-activable and photo-switchable proteins that have been developed in the past few years.

Under irradiation by UV light, these proteins undergo a chemical conversion and switch from one particular state to another.

In the case of photo-activable proteins, they undergo a conversion from a dark 'off' state to a bright 'on' state.

For photo-switchable fluorophores, they will switch from one color to another color; this process may or may not be reversible, depending on the fluorophore in question.

In the examples below, the fluorophore EOS will undergo a conversion from a green state to a red state.

<http://advanced-microscopy.utah.edu/education/super-res/>

PALM (Photo-Activated Localization Microscopy)

Internet References

JENNIFER LIPPINCOTT-SCHWARTZ (NIH) PART 3: SUPER RESOLUTION IMAGING

[HTTPS://WWW.YOUTUBE.COM/WATCH?V=BOM9D-KNZ0W](https://www.youtube.com/watch?v=BOM9D-KNZ0W)

Microscopy: Super-Resolution Microscopy (Xiaowei Zhuang)

<https://www.youtube.com/watch?v=BmRRYPDq4bY>

https://www.youtube.com/watch?v=w2Qo_sppcl

E. BETZIG Nobel Prize lecture 2014

<http://www.nobelprize.org/mediaplayer/index.php?id=2407>

W. MOERNER Nobel Prize lecture 2014

<http://www.nobelprize.org/mediaplayer/index.php?id=2411>

PALM (Photo-Activated Localization Microscopy) - Eric Betzig 2006

STORM (STochastic Optical Reconstruction Microscopy) - Sam Hess 2006

Single molecule detection/localization – Dickson,..., and Moerner, Nature (1997)

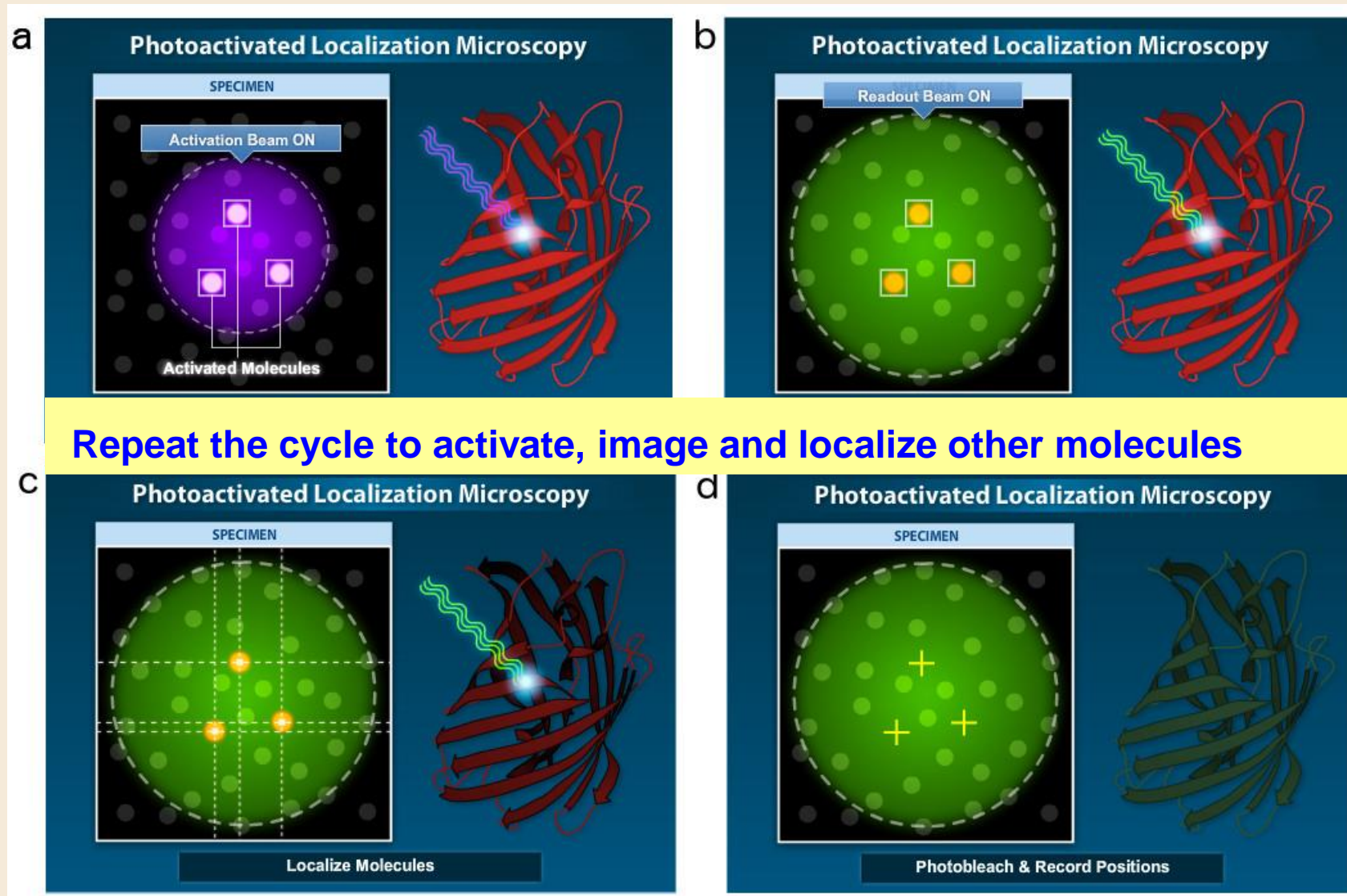

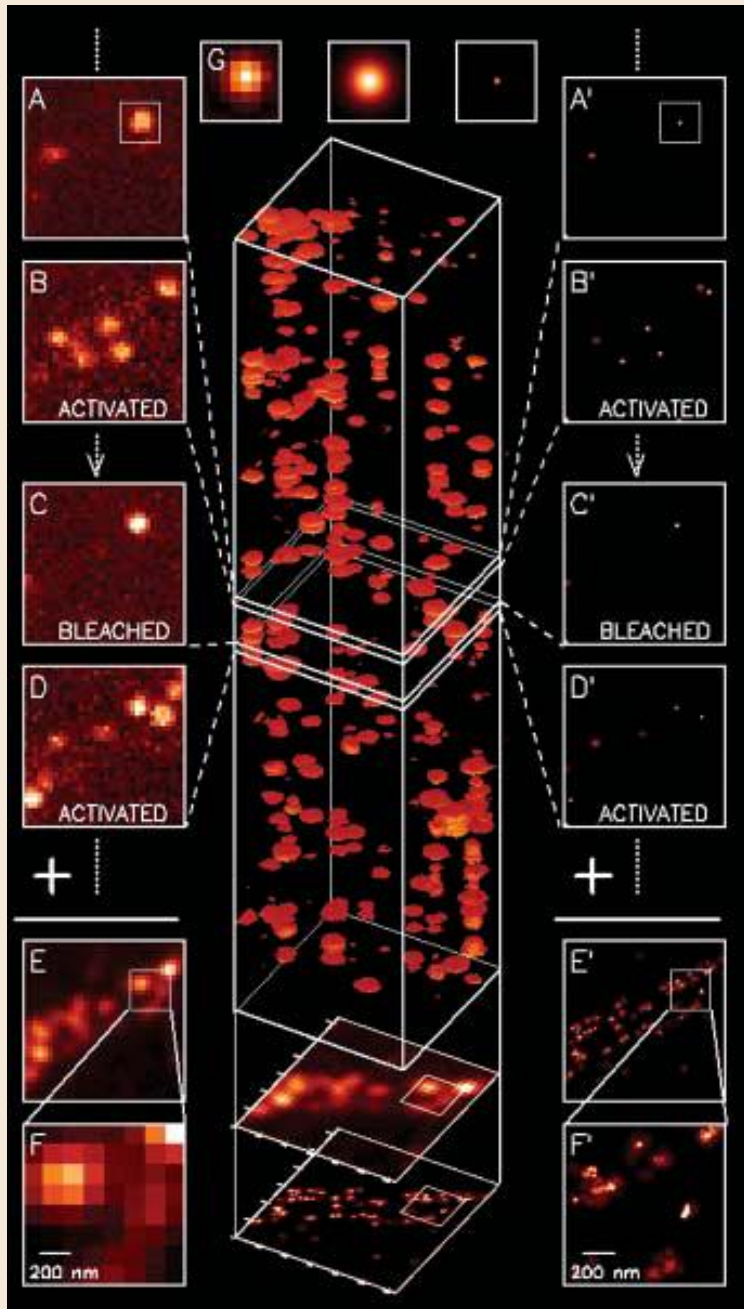

← Cycles sequence involved in creating a PALM image - Betzig et al, Science, (2006)

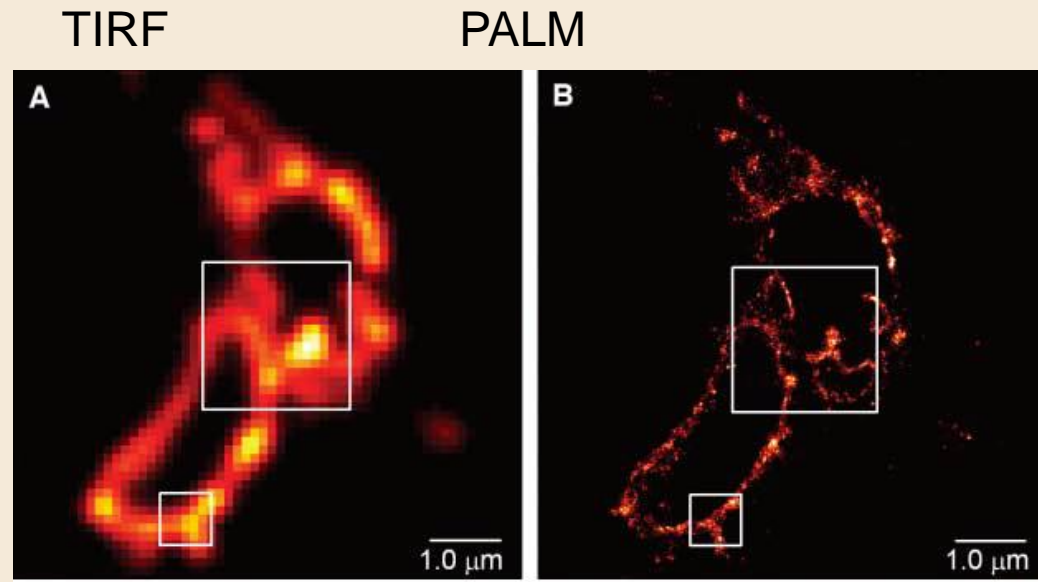

N.B. : The molecules activated in one cycle should be separated by distances bigger than the diffraction limit!

Molecule localization

Central to the performance of PALM is the **precise localization** of single fluorescent molecules. When such localization is performed by a least-squares fit of an assumed 2D gaussian point spread function (PSF) to each single molecule image, the **mean-squared position error** is:

$$\sigma_{x,y} \sim s / (N^{1/2})$$

where s is the standard deviation of the PSF and N is the total number of photons measured from the molecule. (PSF – the image of a molecule)

Ex: If $s \sim 200$ nm, and $N > 10^4 \rightarrow$ **1-2 nm resolution can be achieved**

Betzig, Science 2006:

Here, we developed a method for isolation of single molecules at high densities (up to $\sim 10^5/\mu\text{m}^2$) based on the serial photoactivation and subsequent bleaching of numerous sparse subsets of photoactivatable fluorescent protein (PA-FP) molecules within a sample.

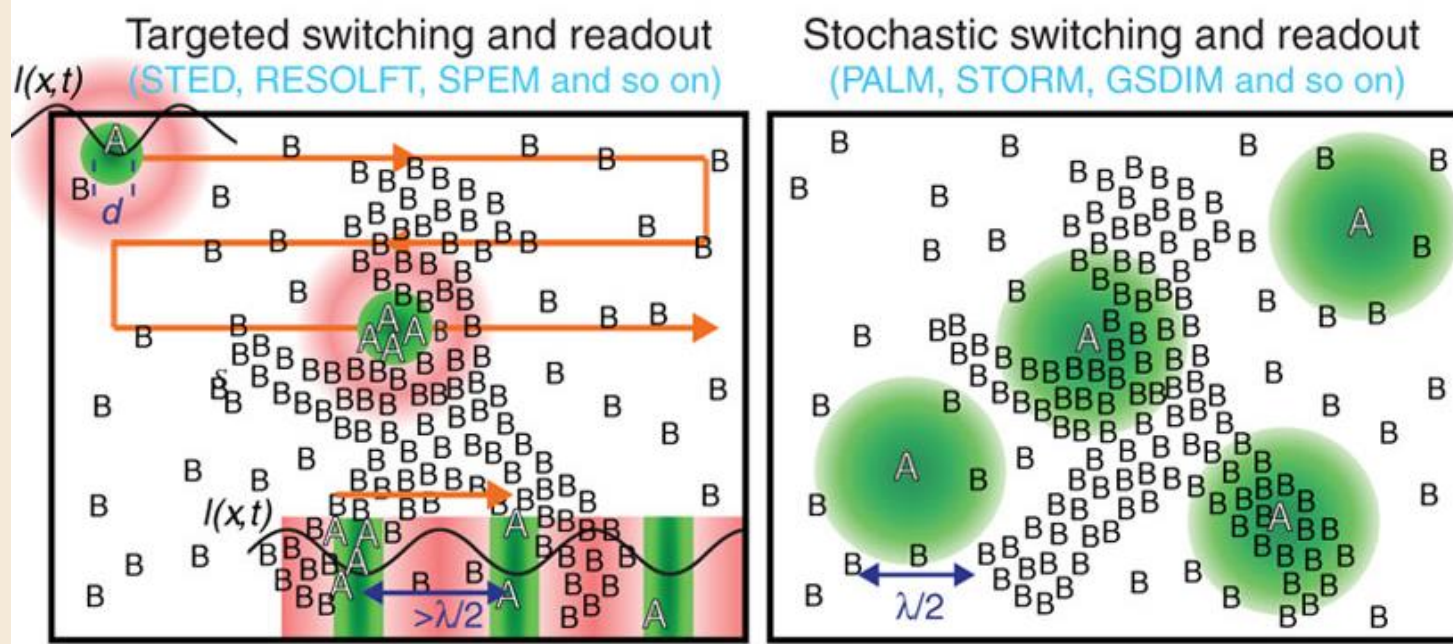

In the **targeted** mode, a spatial light intensity distribution $I(x,t)$ having a zero intensity point in space switches the molecules such that one of the states—here A—is confined to sub-diffraction dimensions d . E.g. in STED microscopy the zero-intensity point is realized by a doughnut-shaped beam $I(x,t)$ for molecular de-excitation (upper left corner) switching off all molecules that are not located at the zero, thus sharply confining a region with diameter $d \ll \lambda/(2n \sin \alpha)$ in which the molecules are on (in state A). The image is assembled by shifting the pattern $I(x,t)$ over the sample (scanning) and recording adjacent features sequentially in time. Several molecules can reside in the same sub-diffraction-sized region. To parallelize the recording procedure (lower right corner), $I(x,t)$ can also feature an array of zero lines or points with pitch $> \lambda/(2n \sin \alpha)$ and implement camera recording. To super-resolve in all directions, the line pattern must be tilted and scanned an appropriate number of times.

In the **stochastic** switching mode, such as in PALM and STORM, individual molecules are switched on (to state A) randomly in space, emitting $m \gg 1$ photons in a row, while the surrounding molecules remain in the dark state. The distance between the 'on' molecules should be $> \lambda/(2n \sin \alpha)$ to facilitate recognition of individual molecules. Their coordinates are gained by calculation of their centroids. In the variant GSDIM, the

Superresolution

separates features using *(at least)* 2 molecular **states**

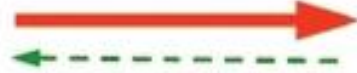

fluorescent

non-fluorescent

*absorbing
scattering
spin up*

*non-absorbing
non-scattering
spin down*

...

...

The Nobel Prize in Chemistry 2014



Photo: A. Mahmoud
Eric Betzig
Prize share: 1/3



Photo: A. Mahmoud
Stefan W. Hell
Prize share: 1/3



Photo: A. Mahmoud
William E. Moerner
Prize share: 1/3

The Nobel Prize in Chemistry 2014 was awarded jointly to Eric Betzig, Stefan W. Hell and William E. Moerner *"for the development of super-resolved fluorescence microscopy"*.

https://www.nobelprize.org/nobel_prizes/chemistry/laureates/2014/

Suggestion: Read the Nobel lectures !!!

(Replacing the) **Conclusions** with recommendation to read the review:

Microscopy and its focal switch

Stefan W Hell

Until not very long ago, it was widely accepted that lens-based (far-field) optical microscopes cannot visualize details much finer than about half the wavelength of light. The advent of viable physical concepts for overcoming the limiting role of diffraction in the early 1990s set off a quest that has led to readily applicable and widely accessible fluorescence microscopes with nanoscale spatial resolution. Here I discuss the principles of these methods together with their differences in implementation and operation. Finally, I outline potential developments.

Most textbooks still assert that a light microscope cannot resolve objects that are closer than about a quarter of a micrometer. However, as this issue of *Nature Methods* highlights, fluorescence microscopy has clearly turned into nanoscopy. And, as with many other leaps in sci-



$$\Delta x \approx \frac{\lambda}{2n \sin \alpha}$$



$$\Delta X = \frac{\lambda}{2n \sin \alpha \sqrt{1 + \frac{I}{I_s}}}$$

24 | VOL.6 NO.1 | JANUARY 2009 | NATURE METHODS

Super-Resolution (Nanoscopy)

New Idea: use a donut beam for molecule excitation and localization

New technique: MINFLUX

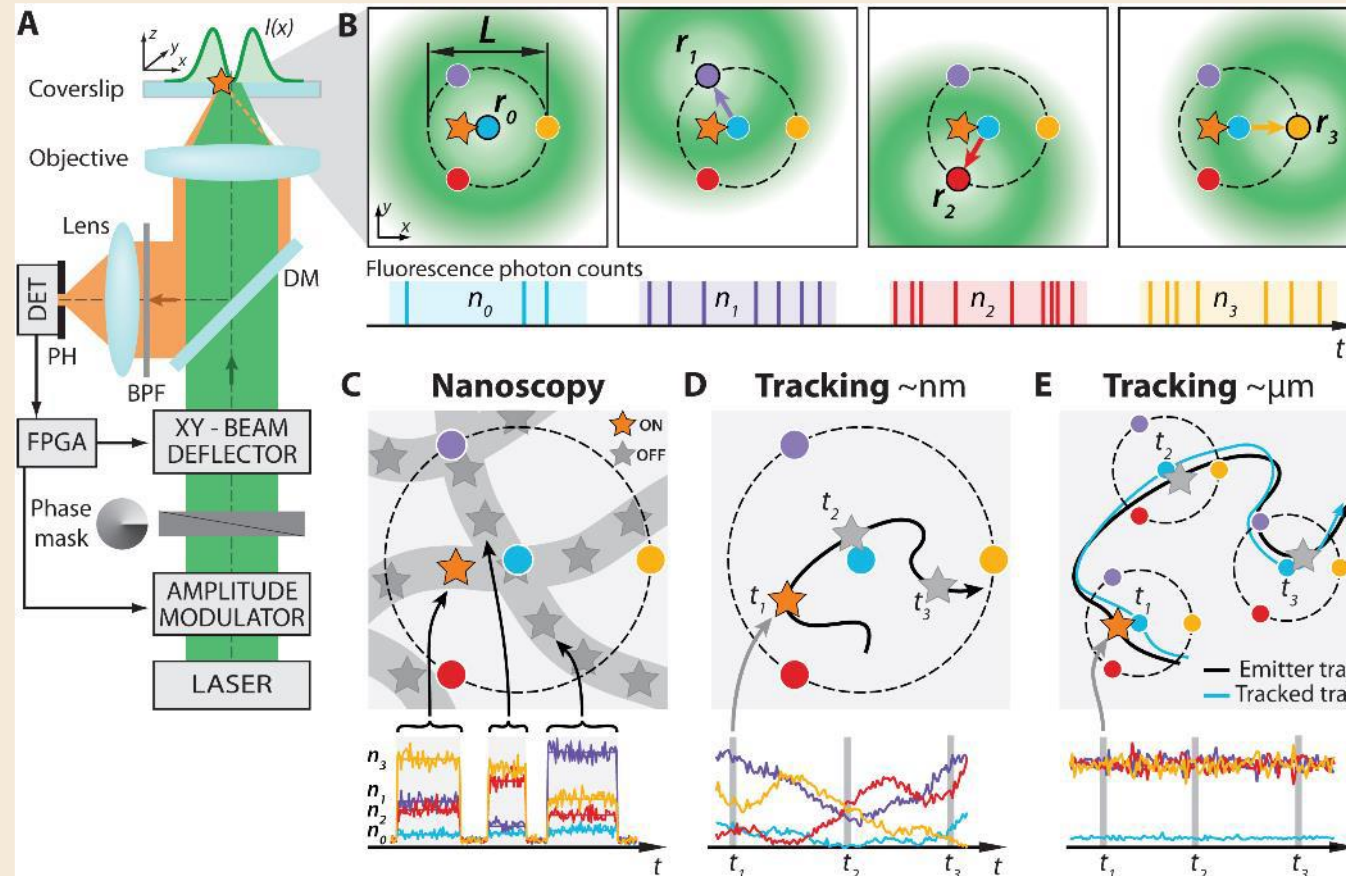

Francisco Balzarotti, ..., Stefan W. Hell, Nanometer resolution imaging and tracking of fluorescent molecules with minimal photon fluxes, *SCIENCE*, 2017
Doi: 10.1126/science.aak9913

New technique: MINFLUX

Commercially available since 2020: <https://www.abberior.com/>