

## **LECTURE 4**

### **DNA METHYLATION**

## DNA methyl transferases methylate DNA

### Maintenance of DNA methylation patterns by DNMTs

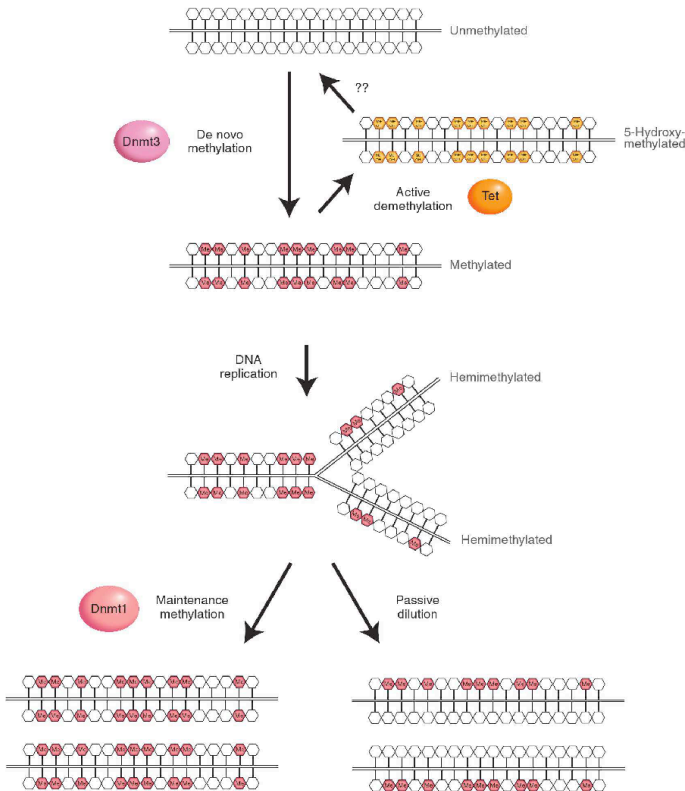

**Figure 2.** De novo methylation and maintenance methylation of DNA. A stretch of genomic DNA is shown as a line with self-complementary CpG pairs marked as vertical strokes. Unmethylated DNA (*top*) becomes methylated “de novo” by Dnmt3a and Dnmt3b to give symmetrical methylation at certain CpG pairs. On semiconservative DNA replication, a progeny DNA strand is base-paired with one of the methylated parental strands (the other replication product is not shown). Symmetry is restored by the maintenance DNA methyltransferase, Dnmt1, which completes half-methylated sites, but does not methylate unmodified CpGs.

### Discovery of function and DNMT family members:

DNMT1: discovered first

Cell extract + DNA containing CpG repeats +  $^{14}\text{C}$  labelled -CH<sub>3</sub> in AdoMet (SAM) → radioactive -CH<sub>3</sub> transferred to DNA

Next step: Purification of enzymatic activity from cell extract → 200kDa complex containing a protein with specific DNA methyl transferase activity: **DNMT1**

### Biochemical characterization of substrate specificity:

This enzyme is 7– to 100-fold more active on hemimethylated DNA as compared with un-methylated substrate *in vitro*

### Discovery of de novo DNMTs:

Sequence of DNMT1 was used to look For genes with similar sequence (sequence homology)

- Discovery of de-novo DNMTs that work efficiently work on un-methylated DNA (DNMT3a, 3b)
- De-novo DNMTs cannot efficiently methylate hemi-methylated DNA

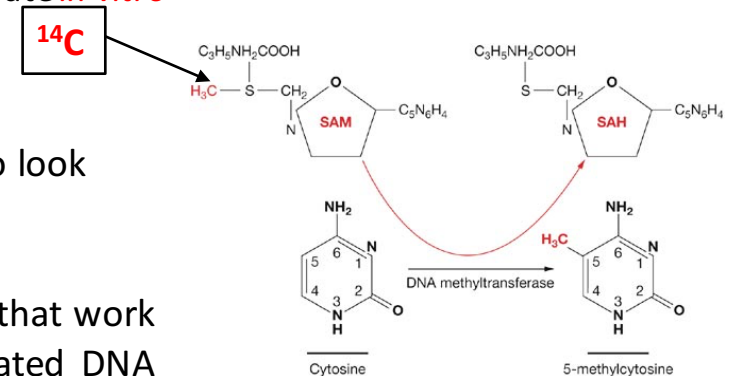

## LOSS OF DNA METHYLTRANSFERASES IS LETHAL DURING EMBRYONIC MOUSE DEVELOPMENT

**Table 1.** Function of mammalian DNA methyltransferases

DNA methyltransferase	Species	Major activity	Major phenotypes of loss of function
Dnmt1	Mouse	Maintenance methylation of CpG	Genome-wide loss of DNA methylation, embryonic lethality at embryonic day 9.5 (E9.5), abnormal expression of imprinted genes, ectopic X-chromosome inactivation, activation of silent retrotransposon. In cancer cell lines, it leads to cell cycle arrest and mitotic defects.
Dnmt3a	Mouse	De novo methylation of CpG	Postnatal lethality at 4–8 wk, male sterility, and failure to establish methylation imprints in both male and female germ cells
Dnmt3b	Mouse	De novo methylation of CpG	Demethylation of minor satellite DNA, embryonic lethality around E14.5 days with vascular and liver defects. (Embryos lacking both Dnmt3a and Dnmt3b fail to initiate de novo methylation after implantation and die at E9.5.)
DNMT3B	Human	De novo methylation of CpG	ICF syndrome: immunodeficiency, centromeric instability, and facial anomalies. Loss of methylation in repetitive elements and pericentromeric heterochromatin.

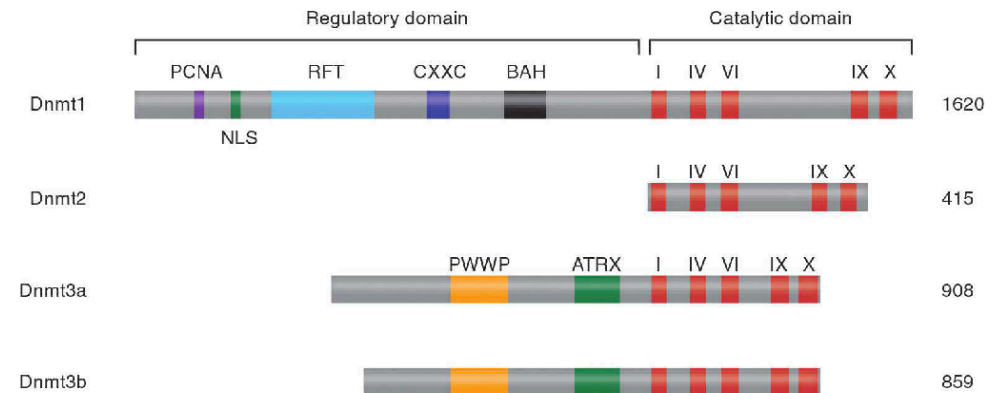

**Figure 4.** Mammalian DNA methyltransferases. The catalytic domains of Dnmt1, Dnmt2, and the Dnmt3 family members are conserved (the signature motifs, I, IV, VI, IX, and X, are most conserved in all cytosine methyltransferases), but there is little similarity among their amino-terminal regulatory domains. Domain abbreviations: PCNA, PCNA-interacting domain; NLS, nuclear localization signal; RFT, replication foci-targeting domain; CXXC, a cysteine-rich domain implicated in binding DNA sequences containing CpG dinucleotides; BAH, bromo-adjacent homology domain implicated in protein–protein interactions; PWWP, a domain containing a highly conserved “proline-tryptophan-tryptophan-proline” motif involved in heterochromatin association; ATRX, an ATRX-related cysteine-rich region containing a C2-C2 zinc finger and an atypical PHD domain implicated in protein–protein interactions.

**ON THE SINGLE GENE LEVEL:**

**CpG islands (CGIs) are short sequences stretches with variable DNA methylation that regulate promoter activity**

**NOTE: single CpGs are generally hyper-methylated (60-90%)**

**CpG islands are differentially methylated, but are generally demethylated**

CpG islands (CGIs) have a length of ca. 1kb

60% of human genes are controlled by CGIs containing promoters that allow tissue/cell specific gene expression

CpG islands can overlap with the first exon (methylation level in 1<sup>st</sup> exon is good predictor of gene expression)

CpG islands located <2kb from promoter: shores

CpG islands located <2-4kb from promoter: shores

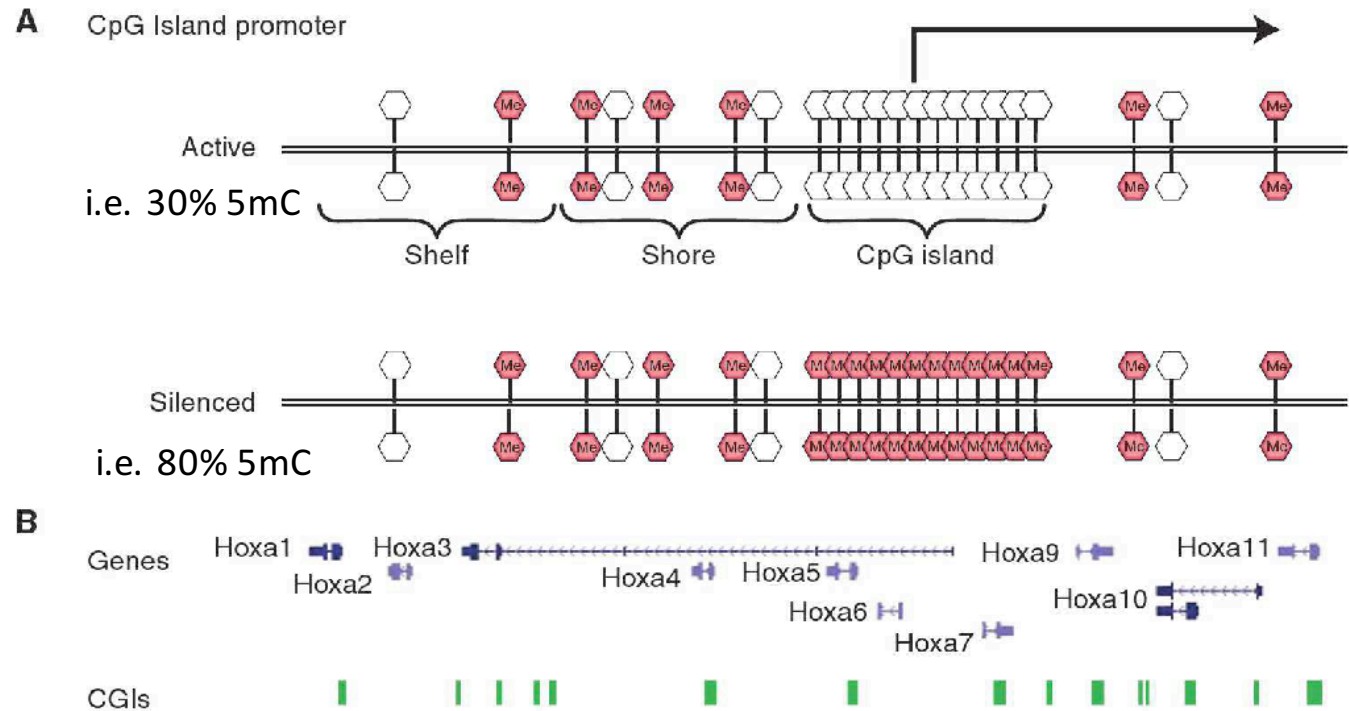

# Mapping DNA methylation at CpG islands BISULFITE SEQUENCING

Genomic DNA

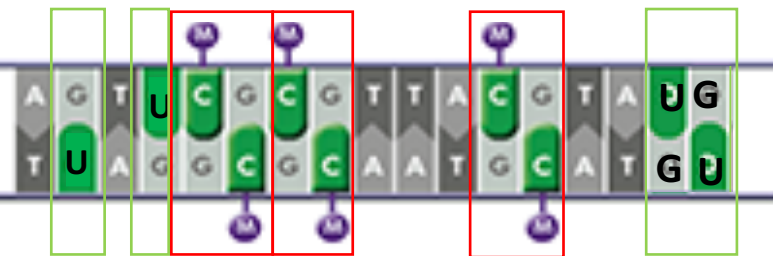
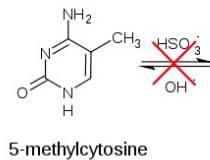
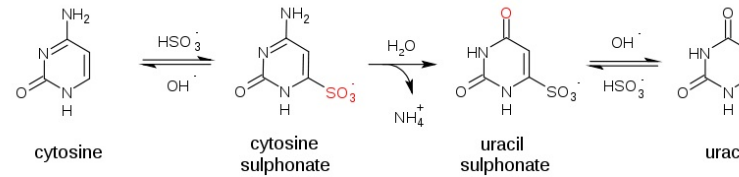
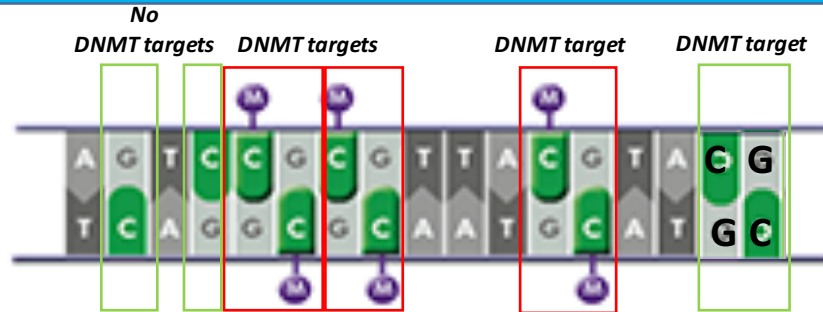

DNA for Sequencing

**Bisulfite conversion**

*Sequencing of both strands reveals C → U (T) transition*

Compare with genomic sequence  
**C → U sequence change = DNA methylation**  
**C → C no sequence change = no DNA methylation**

## Mapping DNA methylation at CpG islands BISULFITE SEQUENCING

### An example:

hTERT encodes the telomerase gene  
hTERT elongates telomeres thereby  
protecting cancer cells from  
replicative senescence

→ Cancer cells do not age and can proliferate  
forever!!

→ Therefore 90% of human cancers express  
telomerase. NOTE: telomerase gene is  
silenced by DNA methylation in  
differentiated cells.

→ Bisulfite sequencing showed that cancer  
cells have a de-methylated CpG island  
located at the hTERT promoter. CpG islands  
can overlap with the 1<sup>st</sup> intron of the  
gene!!!!

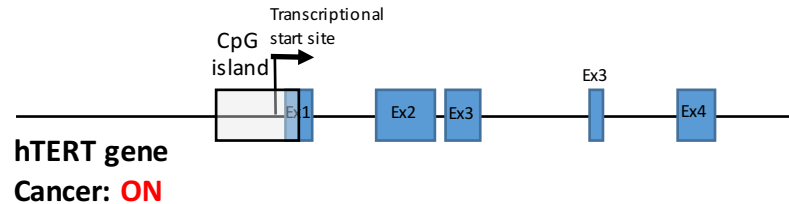

CANCER CELL  
CpG  
island  
not methylated

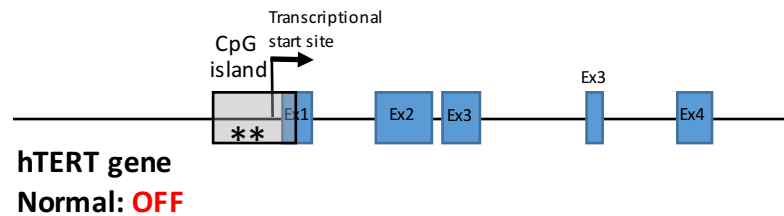

NORMAL CELL  
CpG  
island  
is methylated (\*\*)

## Mapping DNA methylation at CpG islands of individual genes BISULFITE SEQUENCING

Prepare DNA from normal cell and cancer cell

Purify DNA and perform bi-sulfite conversion (DMS)  
(Unmethylated C → U; Methylated C → C)

Amplify your region of interest = CpG islands  
in the TERT promoter

Purify DNA fragment obtained by PCR

Clone fragment into Plasmid

Transform bacteria with plasmid (one bacteria receives only one plasmid!!!)

Purify amplified plasmids from 10-15 individual bacterial cultures

Sequence inserts using a primer that anneals to the vector DNA,  
adjacent to the insertion site of the PCR product

REMEMBER: only a single type of plasmid is sequenced

This refers to a single type of molecule.

To have a good representation, you need to  
sequence at least 10-15 clones

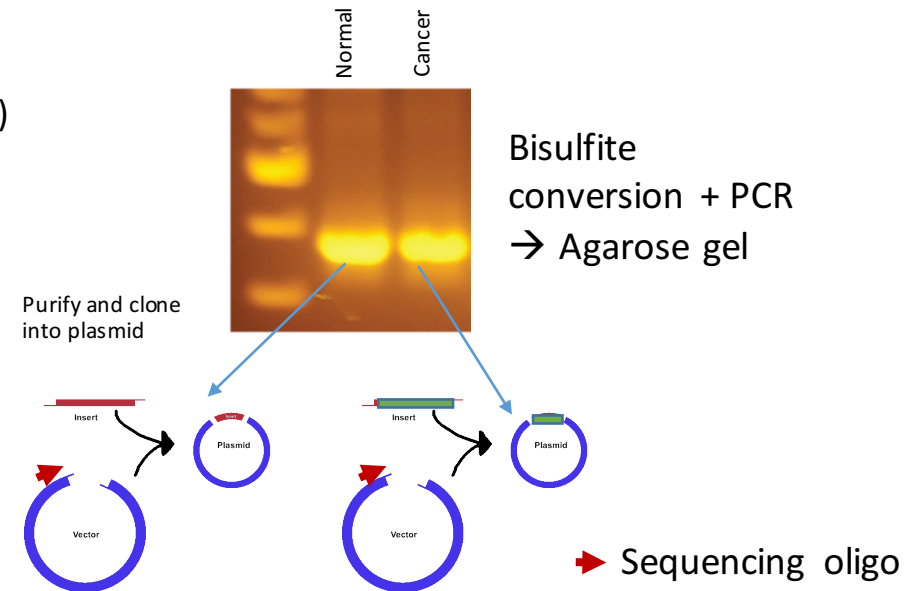
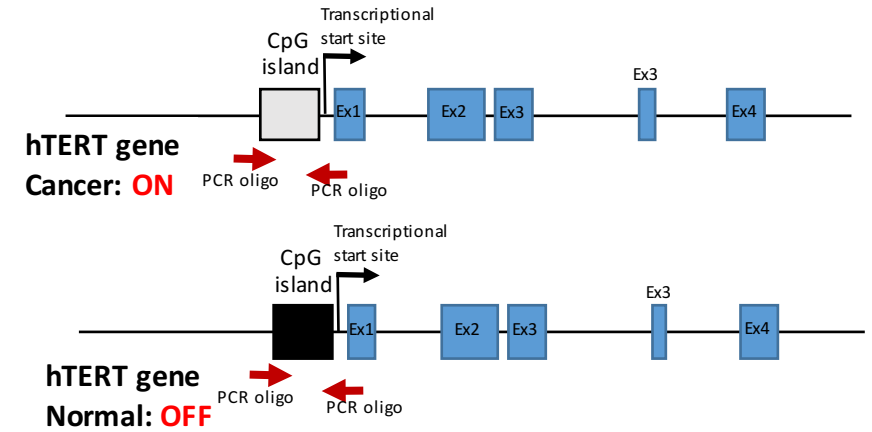

## Mapping DNA methylation at CpG islands BISULFITE SEQUENCING

Prepare DNA from normal cell and cancer cell

Purify DNA and perform bi-sulfite conversion

Amplify your region of interest = CpG islands in the TERT promoter

Purify DNA fragment obtained by PCR

Clone fragment into Plasmid

Transform bacteria with plasmid

Purify amplified plasmids

Sequence inserts using a primer that anneals to the vector DNA, adjacent the insertion site of the PCR product

**REMEMBER:** only a single type of plasmid is sequenced

This refers to the sequence of interest of a single cell!! To have a good representation, you need to sequence at least 10 clones

**IMPORTANT:** Quality control of your bisulfite conversion: ALL C that are not followed by G MUST have been converted to U!!!!

Ref . sequence

C C C C G G G C G G A A G C T G C G G G C G G

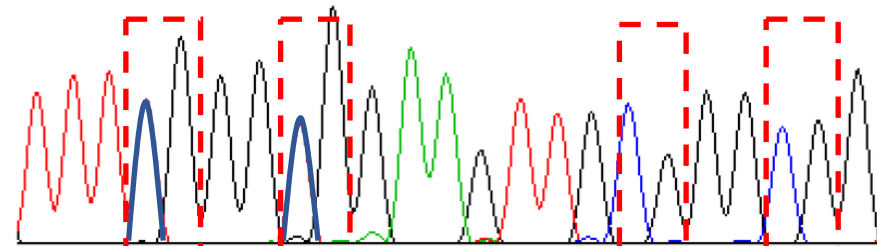

Normal tissue

T T T C G G G C G G A A G T T G C G G G C G G

Tumor tissue

T T T T G G G T G G A A G T T G C G G G C G G

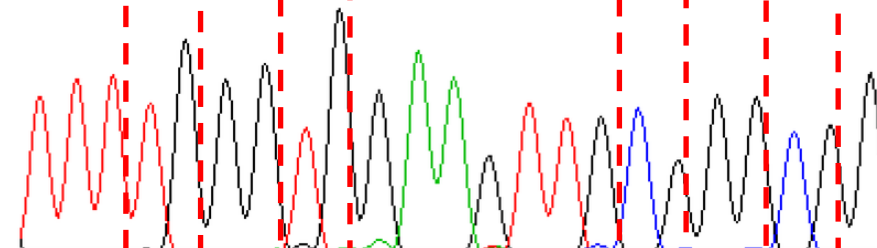

Unmethylated C

Methylated C

C Cytosine not in CpG site C G CpG site

**Compare with genomic sequence**

**Bisulfite conversion: C → U sequence change = DNA methylation**

**C → C no sequence change = no DNA methylation**



## Mapping DNA methylation at CpG islands BISULFITE SEQUENCING

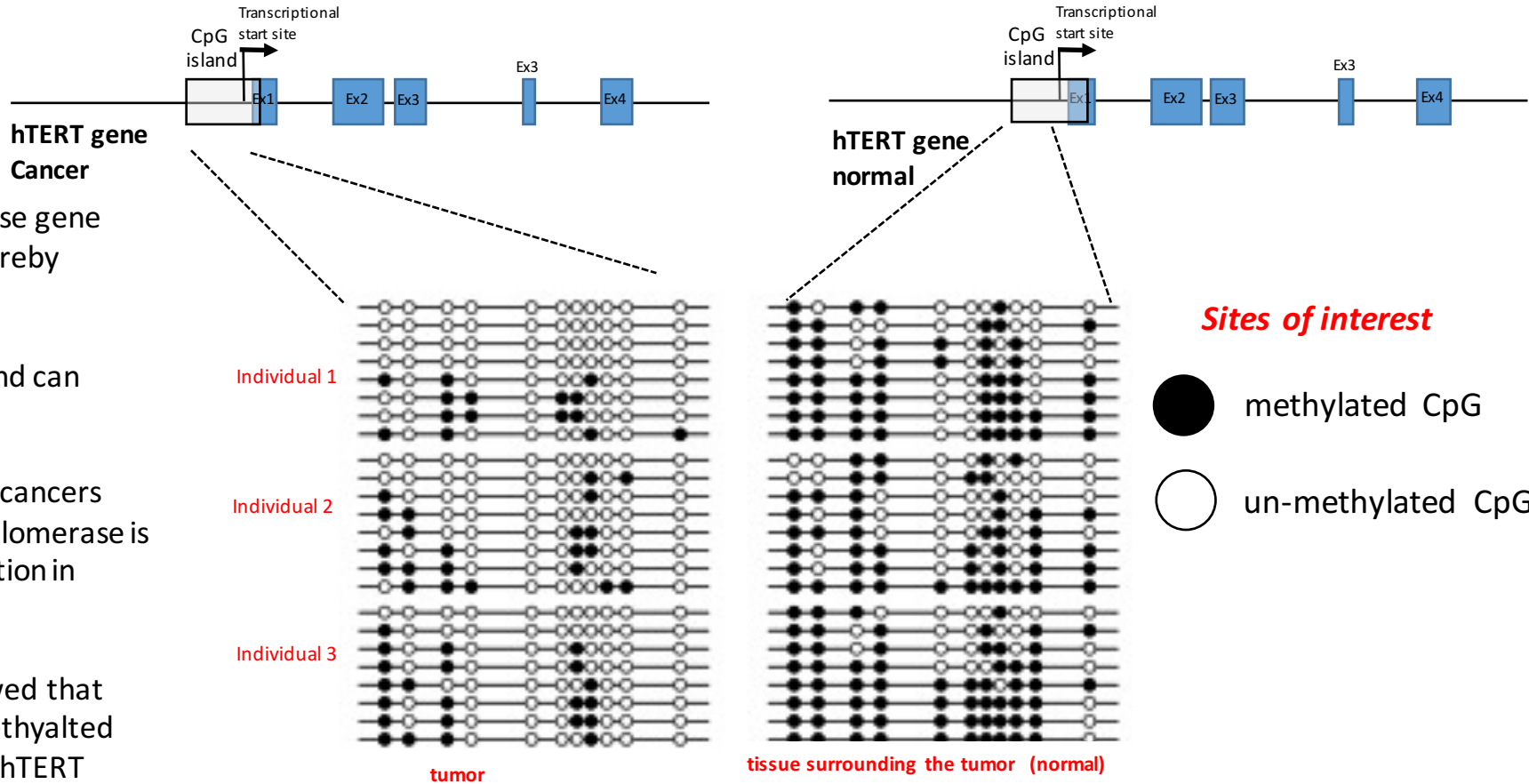

**An example:**

hTERT encodes the telomerase gene  
Tert elongates telomeres thereby protecting cancer cells from replicative senescence

→ Cancer cells do not age and can proliferate forever!!

→ Therefore 90% of human cancers express telomeres; but telomerase is silenced by DNA methylation in differentiated cells.

→ Bisulfite sequencing showed that cancer cells have a de-methylated CpG island located at the hTERT promoter

## Mapping DNA methylation at CpG islands METHYLATED DNA IMMUNOPRECIPITATION: METHYL-DIP

Methyl-DIP works similar to ChIP:

**2 experimental samples:**

- Control (normal cells)
- Experimental sample (cancer cells)

Prepare DNA – carries DNA methylation marks of CpG

Sonicate DNA

Immunoprecipitation using an anti-methyl-CpG specific Antibody (monoclonal, discriminates between CpG and met-CpG)

Washing of precipitate

DATA ACQUISITION

**Main methods to analyse DNA methylation**

1. PCR on specific CpG islands of interest
2. Differential labelling (Cy3-control; Cy5-cancer methyl-DNA) followed by hybridization to genome array
3. Massive parallel sequencing (different approaches)

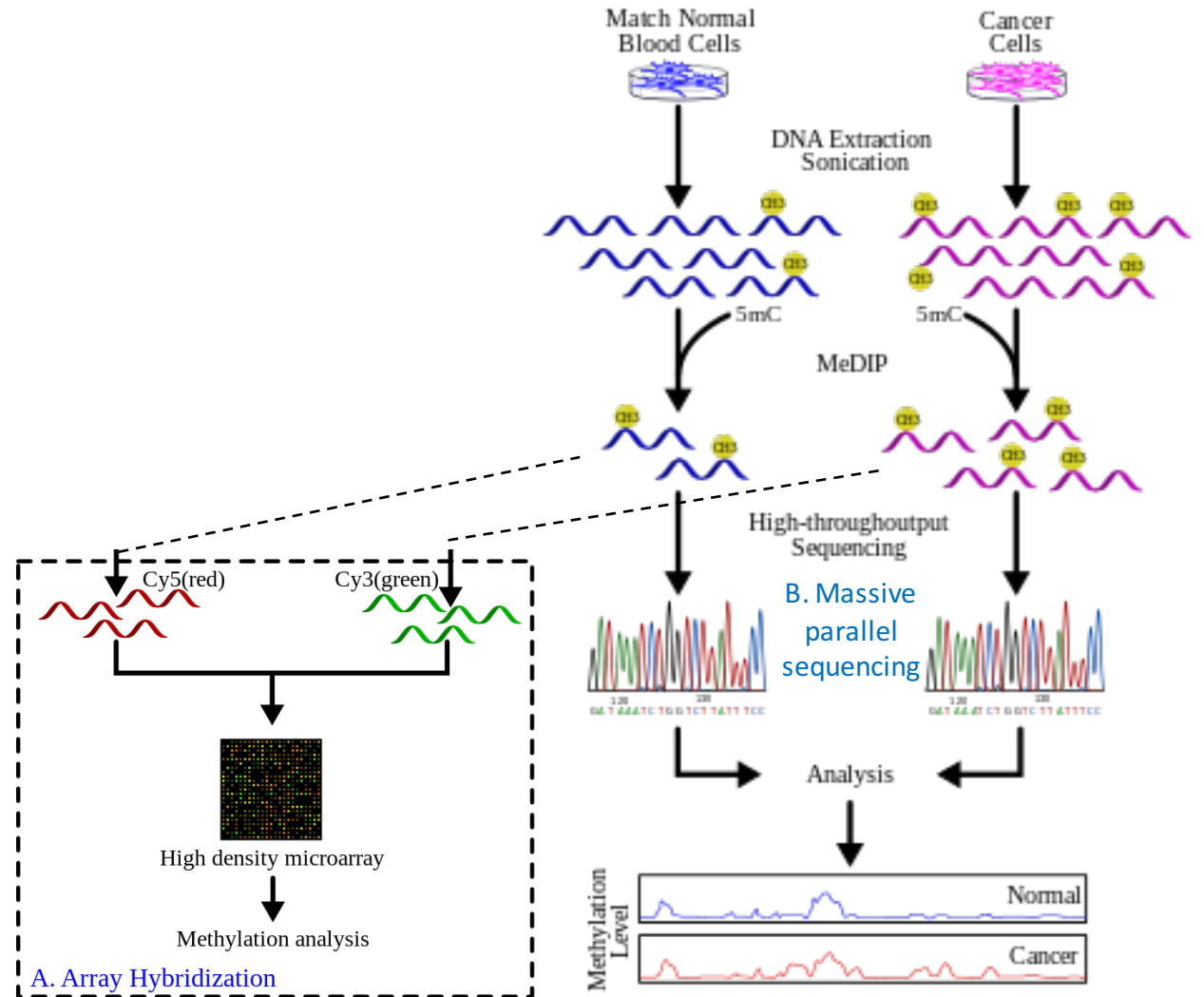

## Mapping DNA methylation genome wide: REDUCED REPRESENTATION BISULFITE SEQUENCING (RRBS)

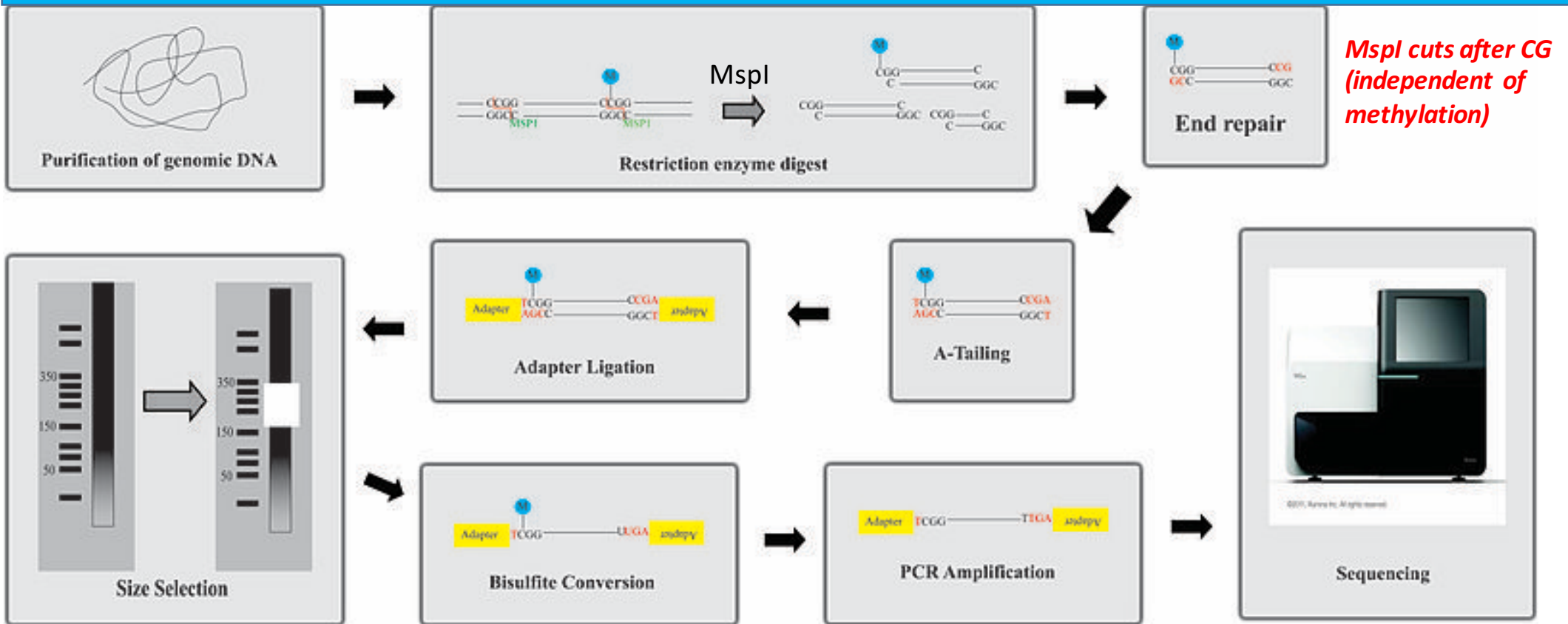

Reduced representation bisulfite sequencing (RRBS) is an efficient and high-throughput technique used to analyze the genome-wide methylation profiles on a single nucleotide level. This technique combines restriction enzymes and bisulfite sequencing in order to enrich for the areas of the genome that have a high CpG content. Due to the high cost and depth of sequencing needed to analyze methylation status in the entire genome. **The fragments that comprise the reduced genome but still includes the majority of promoters, as well as regions such as repeated sequences that are difficult to profile using conventional bisulfite sequencing approaches.**

## Mapping DNA methylation genome wide: REDUCED REPRESENTATION BISULFITE SEQUENCING (RRBS)

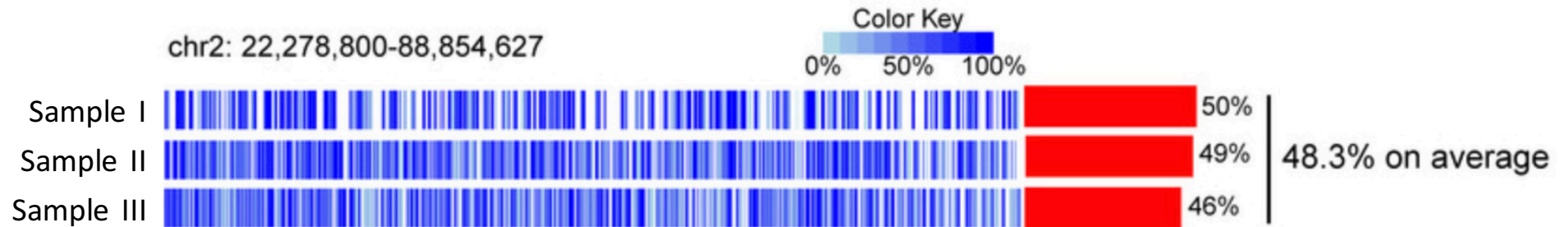

The color key from light blue to dark blue indicates the DNA methylation level from low to high, respectively. The white regions in the left panels indicate a lack of DNA methylation information. The red bars in the right panel represent the average DNA methylation level of the corresponding genomic region. The DNA methylation levels were calculated and presented based on 30 kb windows, only if these windows have more than 5 CpG sites covered.

## TRANSCRIPTIONAL REGULATION BY METHYL-DNA BINDING PROTEINS

### 1. Interference with transcription factor binding

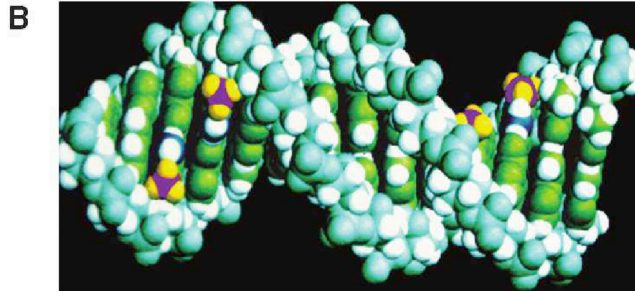

**Figure 1.** Cytosine methylation in DNA. (A) Addition of a methyl group, CH<sub>3</sub> (red), at the five position of the cytosine pyrimidine ring (black arrow) does not sterically interfere with GC base pairing (blue lines). DNA methyltransferases associate covalently with the carbon 6 position (straight green arrow) during methyl group transfer. (B) A model of B-form DNA methylated at cytosines in two self-complementary CpG sequences. The paired methyl moieties (magenta and yellow) lie in the major groove of the double helix.

Methylated DNA obtains different structure:  
Transcription factors cannot bind anymore  
→ DNA methylation sensitive transcription factors

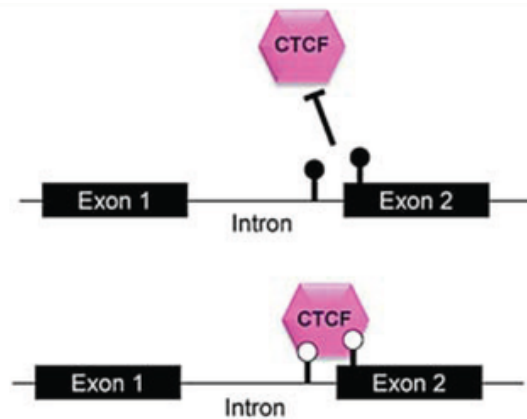

Example: CTCF

Unmethylated DNA CTCF binds → activation of expression

Methylated DNA: CTCF does not bind → no activation

Note: CTCF is a major epigenetic regulator that is involved in controlling genomic imprinting, enhance activation,...

## EPIGENETIC READERS OF DNA METHYLATION

### 2. Transcriptional regulation by methyl-DNA binding proteins

Table 2. Functions of methyl-CpG binding proteins

MBP	Major activity	Species	Major phenotypes of loss-of-function mutations
MeCP2	Binds mCpG with adjacent run AT-rich run Transcriptional repressor	Mouse	Delayed onset neurological defects including inertia, hind-limb claspings, nonrhythmic breathing, and abnormal gait. Postnatal survival ~10 wk.
MECP2	Binds mCpG with adjacent AT run Transcriptional repressor	Human	Heterozygotes suffer from Rett syndrome, a profound neurological disorder characterized by apraxia, loss of purposeful hand use, breathing irregularities, and microcephaly
Mbd1	Binds mCpG via MBD; a major splice form is also able to bind CpG via a CxxC domain	Mouse	No overt phenotype, but subtle defects in neurogenesis detected
Mbd2	Binds mCpG Transcriptional repressor	Mouse	Viable and fertile, but show reduced maternal nurturing behavior. Defective gene regulation in T-helper cell differentiation leading to altered response to infection. Highly resistant to intestinal tumorigenesis.
Mbd3	Core component of NuRD corepressor complex Does not show strong binding to mCpG	Mouse	Early embryonic lethal
Mbd4	DNA repair protein that binds mCpG and T:G mismatches at mCpG sitesThymine DNA glycosylase that excises T from T:G mismatches	Mouse	Viable and fertile. three- to fourfold increase in mutations at CpG sites. Increased susceptibility to intestinal cancer correlates with C to T transitions within the <i>Apc</i> gene. Mbd4 functions to minimize the mutability of 5-methylcytosine.
Kaiso	Binds mCGmCG and CTGCNA Transcriptional repressor	Mouse	No overt phenotype. Small but significant delay in tumorigenesis on Min background.

Several proteins were identified to have affinity to methylated CpG but do not have affinity to unmethylated CpG → mediate transcriptional silencing  
 → CpG METHYL BINDING DOMAIN PROTEIN (MBD) FAMILY : MeCP1, MeCP2, Mbd1, Mbd2, Mbd2, Mbd4  
 → Kaiso (unrelated protein)



Figure 8. Proteins that bind methyl-CpG. Five members of the MBD protein family are aligned at their MBD domains (purple). Other domains are labeled and include TRD; CXXC domains, which are zinc fingers, some of which are implicated in binding to nonmethylated CpG; GR repeats that may bind; a T:G mismatch glycosylase domain that is involved in repair of 5mC deamination. Kaiso lacks the MBD domain, but binds methylated DNA via zinc fingers (orange) and possesses a POB/BTB domain that is shared with other transcriptional repressors. Domain abbreviations: MBD, methyl-CpG binding domain; TRD, transcriptional repression domain; POZ, poxvirus and zinc finger, a protein-protein interacting domain.

# MeCP2 mutations cause Rett syndrome

Methylated CpG is bound by MeCP2

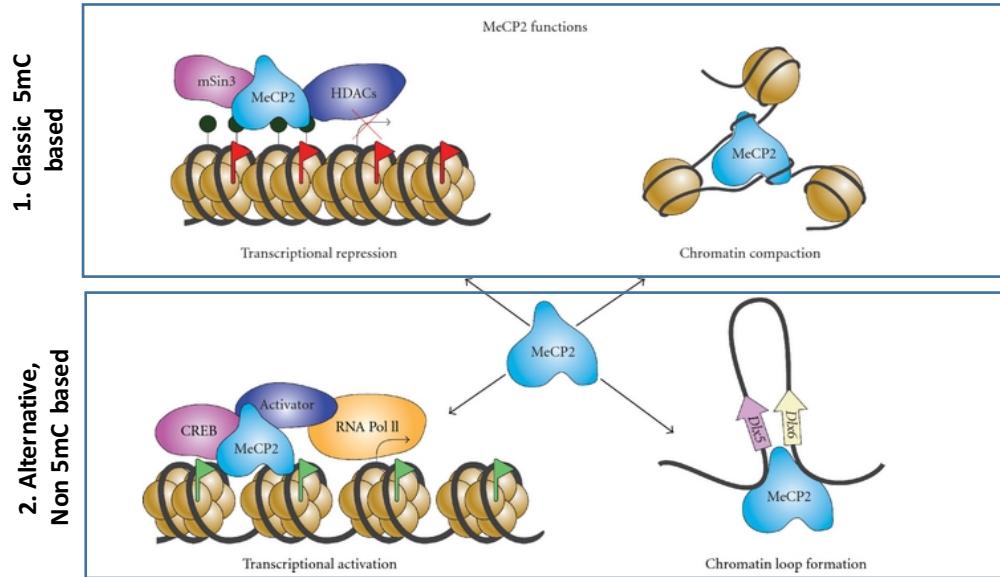

However MeCP2 was also found to be located on active genes

1. MeCP2 function acts as transcriptional repressor by binding methylated DNA and associates with corepressor complexes such as mSin3A and HDACs .
2. Genomewide search for MeCP2 genomic distribution also showed:
  - (i) MeCP2 was found to be associated with transcriptionally active genes
  - (ii) Only 2.2% of the most methylated promoters were bound by MeCP2.

Rett syndrome is caused by mutations in MeCP2



MeCP2 is X-linked  
Mutations that mediate Rett syndrome are dominant (lethal in males)

Affects predominantly neurons

Rett syndrome (RTT), originally termed cerebrotrophic hyperamonemia is a rare genetic postnatal neurological disorder of the grey matter of the brain that almost exclusively affects females but has also been found in male patients. The clinical features include small hands and feet and a deceleration of the rate of head growth (including microcephaly in some). Repetitive stereotyped hand movements, such as wringing and/or repeatedly putting hands into the mouth, are also noted. People with Rett syndrome are prone to gastrointestinal disorders and up to 80% have seizures. They typically have no verbal skills, and about 50% of affected individuals do not walk. Scoliosis, growth failure, and constipation are very common and can be problematic.

Loss of MeCP2 leads to alteration in gene expression → Phenotypic manifestation

# How does MeCP2 effect the brain function?

- Through it's job as a reader of epigenetic bookmarks
- The wide array of functions that MeCP2 performs ALL contribute to Rett syndrome.
- The different mutations have different effects on the presentation of the disease.
- In addition since each person is different based on their personal epigenetics, the disease will be individual as well.

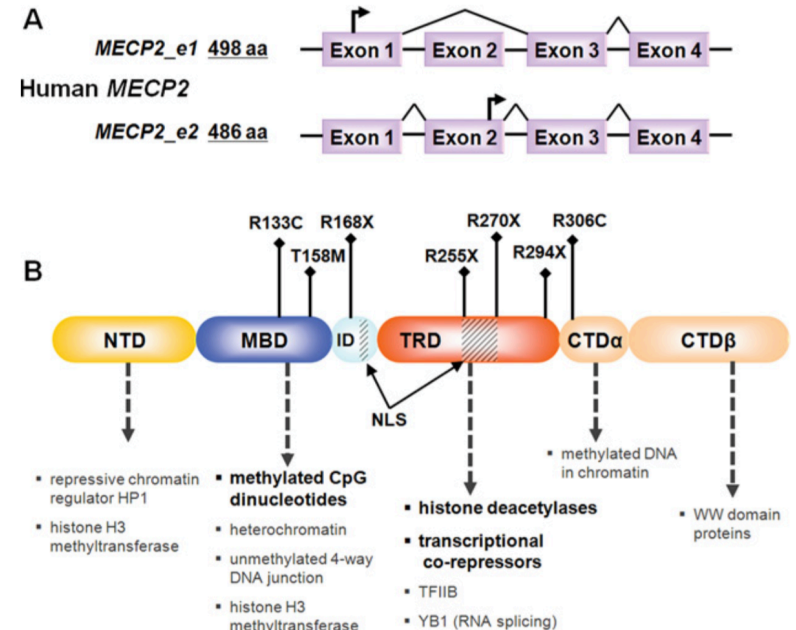
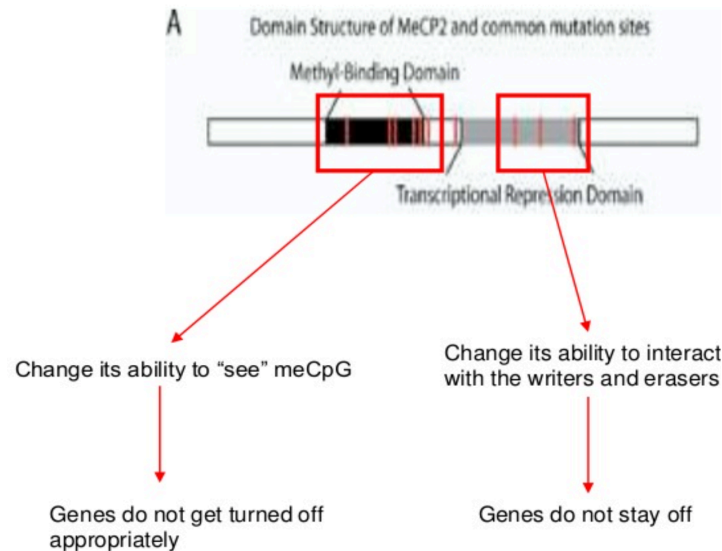

**Figure 1 Composition of MeCP2: gene structure, splicing patterns and putative functional domains**

(A) Splicing patterns generating the two mRNA isoforms of *MECP2*, *\_e1* and *\_e2*. The two isoforms generate two protein isoforms of MeCP2 with differing N-termini due to the use of alternative translation start sites (bent arrows) and the absence or presence of exon 2 in the transcript. (B) Apart from the N-terminus, both MeCP2 isoforms are identical and contain several functionally distinct domains: NTD, N-terminal domain; MBD, methylated DNA-binding domain; ID, interdomain; TRD, transcription repression domain; CTD, C-terminal domain; NLS; nuclear localization signals. Locations of seven of the most common point mutations in RTT are indicated (◆). Below each domain are indicated major (bold) and other (grey) interactors and functions. HP1, heterochromatin protein 1; TFIIIB, transcription factor IIB; YB1, Y-box-binding protein 1.



## EPIGENETIC READERS OF DNA METHYLATION

### Transcriptional regulation by methyl-dna binding proteins

**Table 2.** Functions of methyl-CpG binding proteins

MBP	Major activity	Species	Major phenotypes of loss-of-function mutations
MeCP2	Binds adjacent run mCpG with AT-rich run Transcriptional repressor	Mouse	Delayed onset neurological defects including inertia, hind-limb clasping, nonrhythmic breathing, and abnormal gait. Postnatal survival ~10 wk.
MECP2	Binds adjacent AT run Transcriptional repressor	Human	Heterozygotes suffer from Rett syndrome, a profound neurological disorder characterized by apraxia, loss of purposeful hand use, breathing irregularities, and microcephaly
Mbd1	Binds mCpG via MBD; a major splice form is also able to bind CpG via a CxxC domain	Mouse	No overt phenotype, but subtle defects in neurogenesis detected
Mbd2	Binds mCpG Transcriptional repressor	Mouse	Viable and fertile, but show reduced maternal nurturing behavior. Defective gene regulation in T-helper cell differentiation leading to altered response to infection. Highly resistant to intestinal tumorigenesis.
Mbd3	Core component of NuRD corepressor complex Does not show strong binding to mCpG	Mouse	Early embryonic lethal
Mbd4	DNA repair protein that binds mCpG and T:G mismatches at mCpG sites <u>Thymine DNA glycosylase</u> that excises T from T:G mismatches	Mouse	Viable and fertile. three- to fourfold increase in mutations at CpG sites. Increased susceptibility to intestinal cancer correlates with C to T transitions within the <i>Apc</i> gene. Mbd4 functions to minimize the mutability of 5-methylcytosine.
Kaiso	Binds mCGmCG and CTGCNA Transcriptional repressor	Mouse	No overt phenotype. Small but significant delay in tumorigenesis on Min background.

Methyl-CpG binding proteins are present in transcriptional co-repressor complexes

- MeCP2: component of the Sin3A HDAC complex
- MBD3: component of the NuRD HDAC complex
- MBD1: interacts with HDAC3. Mbd1 and HDAC3 are recruited by the PML-RARalpha hybrid protein to silence gene expression in Acute promyelocytic leukemia
- MBD1: interacts with the H3K9 HMTase SETDB1

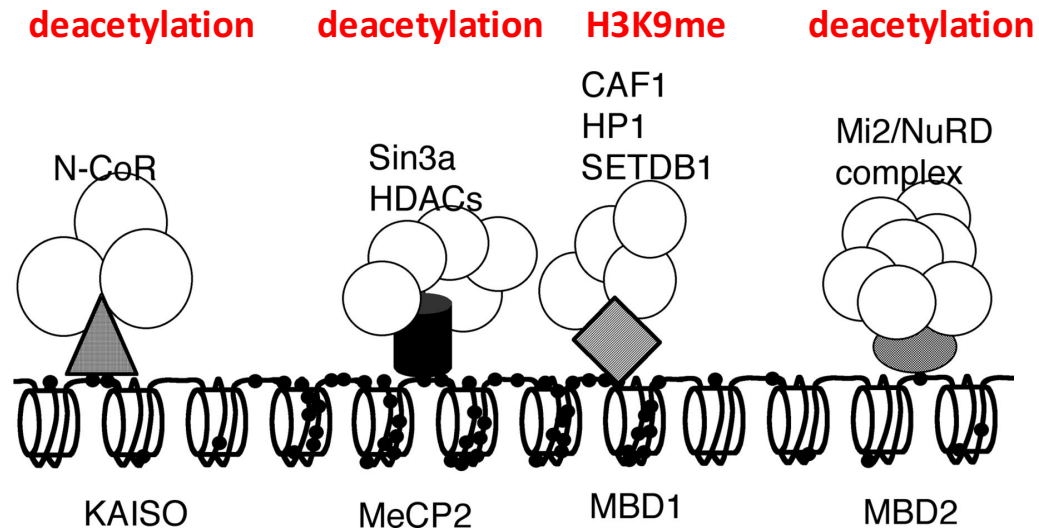

Collaboration to repress genes

## TRANSCRIPTIONAL REGULATION BY METHYL-DNA BINDING PROTEINS RECRUITMENT OF Methyl-CpG binding proteins and co-repressor complexes

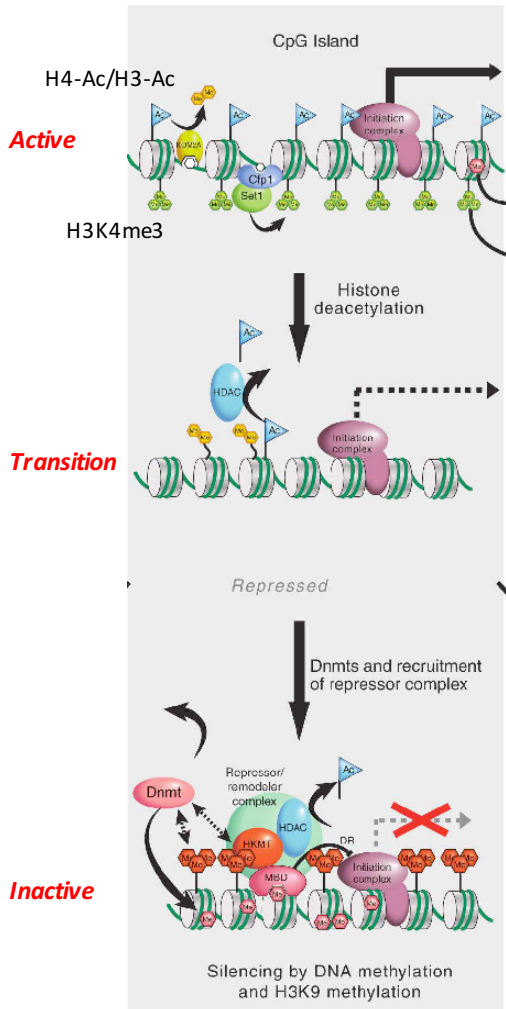

**Example: MBD1 and HDAC3 are recruited by the PML-RARalpha hybrid protein (specialized transcription factor) to silence gene expression in cancer**

**MBD1: interacts with the H3K9me3 HMTase SETDB1**

DNA methylation collaborates with other chromatin modifying complexes to repress gene expression

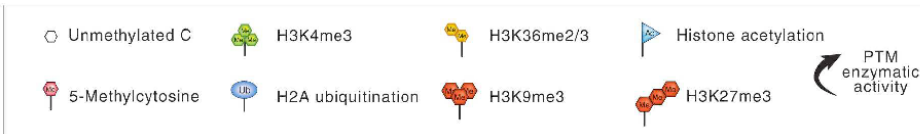

**Figure 9.** Recruitment of corepressors by methyl-CpG binding proteins. A hypothetical transition between an active, nonmethylated gene promoter and a repressed promoter whose silence is attributable to DNA methylation, as mediated by complexes containing an MBD protein such as MeCP2 (gray shading). The transition phase represents an intermediate step during which transcription is silenced and DNA methylation occurs. MeCP2 is envisaged to recruit the NCoR histone deacetylase (HDAC) complex and histone lysine methyltransferase (HKMT) activity to the methylated sites. I

**ON THE SINGLE GENE LEVEL:**

**CpG islands (CGIs) are short sequences stretches with variable DNA methylation that regulate promoter activity**

**NOTE: single CpGs are generally hyper methylated (60-90%)**

**CpG islands are differentially methylated, but are generally demethylate**

CpG islands (CGIs) have a length of ca. 1kb

60% of human genes are controlled by CGIs containing promoters that allow tissue/cell specific gene expression

CpG islands can overlap with the first exon (methylation level in 1<sup>st</sup> exon is good predictor of gene expression)

CpG islands located <2kb from promoter: shores

CpG islands located <2-4kb from promoter: shores

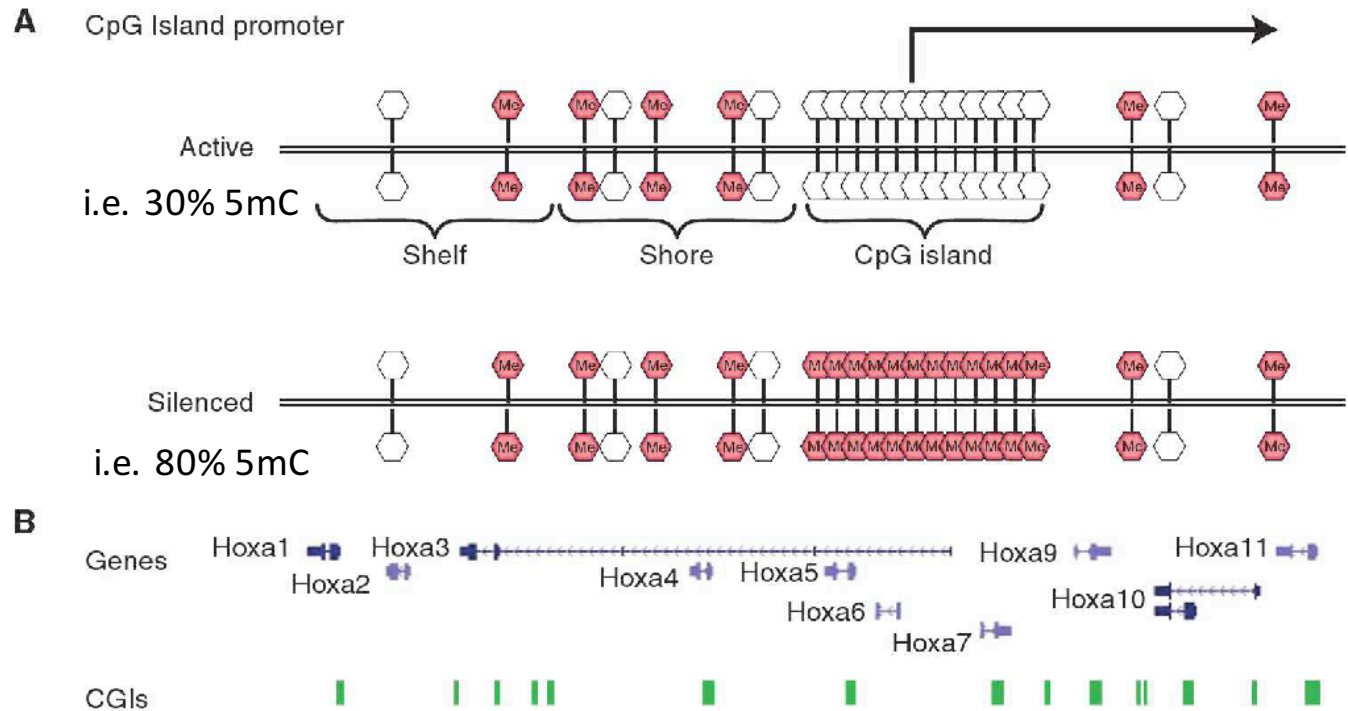

# DYNAMICS OF DNA METHYLATION

DNA METHYLATION IS ABUNANT IN THE GENOME AND ISSUBJECTED TO DRAMATIC ALTERATIONS DURING EMBRYOGENESIS

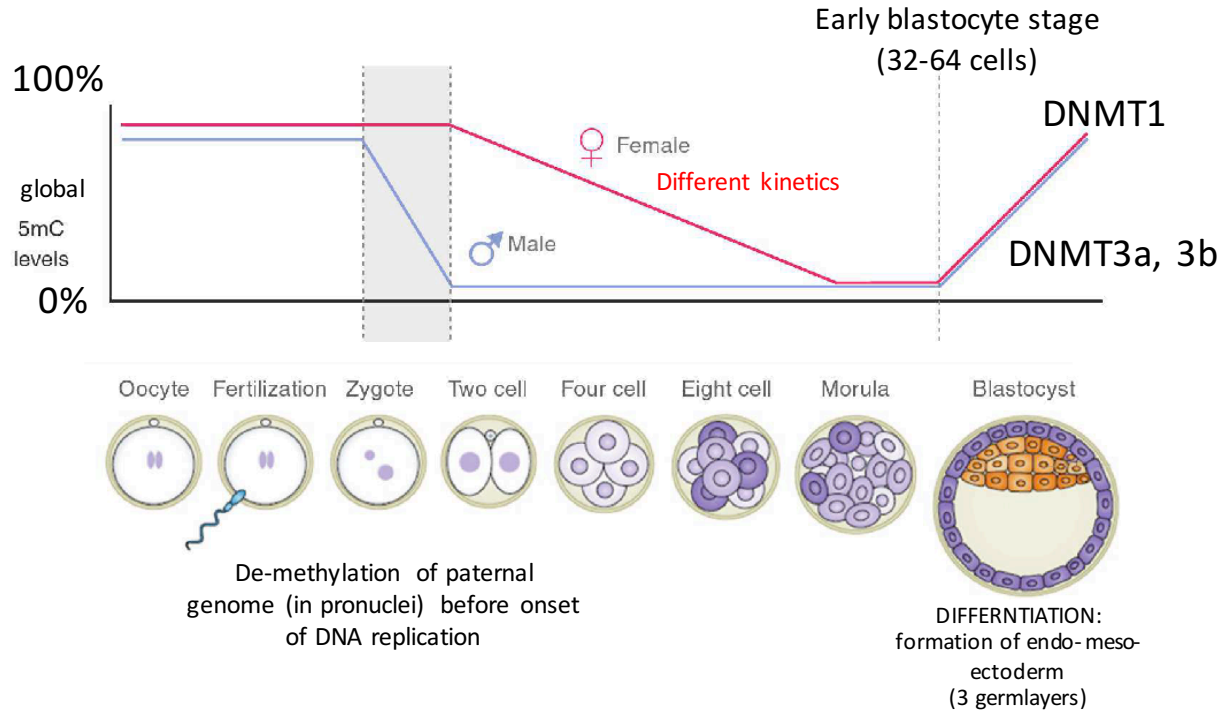

DNA methylation levels are high in fertilized Oocytes that contain the paternal and maternal genome (carries characteristic methylation patterns)

Paternal and maternal methylation patterns are rapidly erased (exception: imprinted genes maintain paternal and maternal methylation information). → the paternal and maternal methylation epigenome is cancelled

DNA methylation levels remain low during the first cell division events until the blastocyst stage

In the blastocyst stage cell differentiation programs are activated and genes need to be regulated on the epigenetic level (repression/activation) → DNA methylation is increasing (loss of DNMT1, DNMT3a or DNMT3b is lethal) → establishment and maintenance of DNA methylation is impaired)

**70%- 80% of CpG di-nucleotides are methylated in the human genome!**  
**Remember only 2% of the genome encode for mRNAs**  
**CpG islands are differentially methylated**

# DNA METHYLATION IS REVERSIBLE – by OXIDATION: DNA DEMETHYLATION BY Tet-family proteins

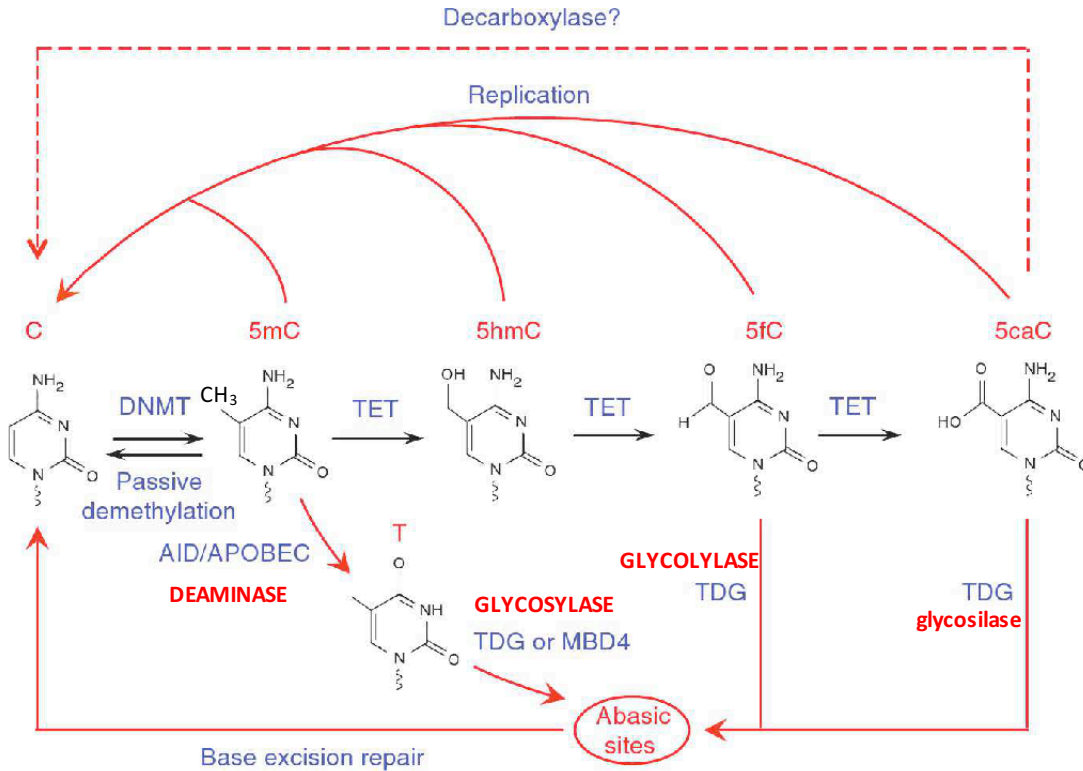

**Figure 6.** Model of Tet-initiated DNA demethylation pathways. DNA methylation (5mC) is established and maintained by DNMT. 5mC can be oxidized by Tet family of dioxygenases to generate 5hmC, 5fC, and 5caC. Because the oxidized 5mC derivatives cannot serve as substrates for DNMT1, they can be lost by replication-dependent passive demethylation. 5hmC can be deaminated by AID/APOBEC to become 5hmU, which together with 5fC and 5caC can be excised by glycosylases such as TDG, followed by DNA repair to generate C. Alternatively, a putative decarboxylase may convert 5caC to C.

## Tet-family proteins mediate DNA demethylation

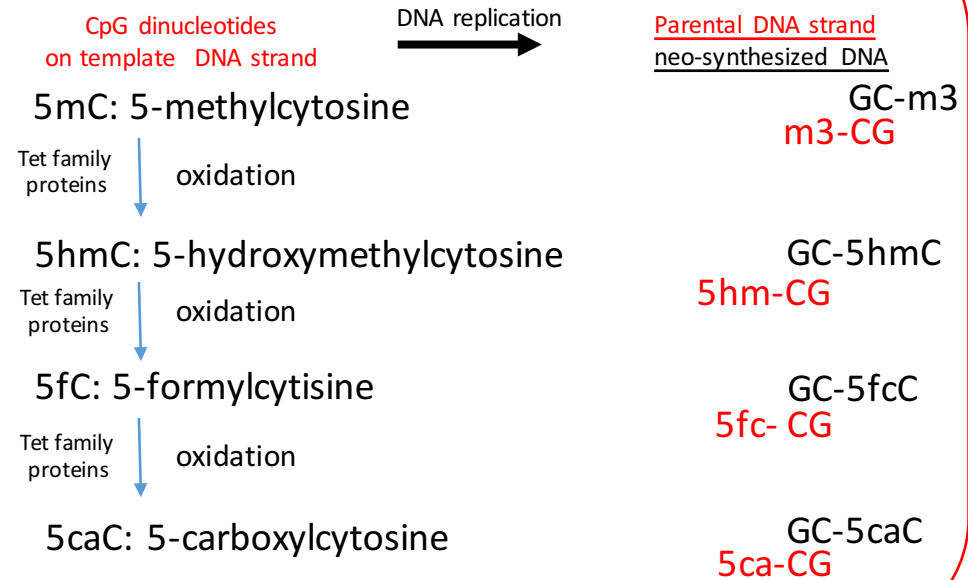

5mC, 5hmC and 5fC are abundant in the cell  
5caC is present only at very low abundance

**DNMT1 has exclusive specificity for 5mC  
→ 5hmC, 5fC, 5caC no substrate for DNMT1**

# DNA METHYLATION IS REVERSIBLE: DNA DEMETHYLATION BY Tet-family proteins

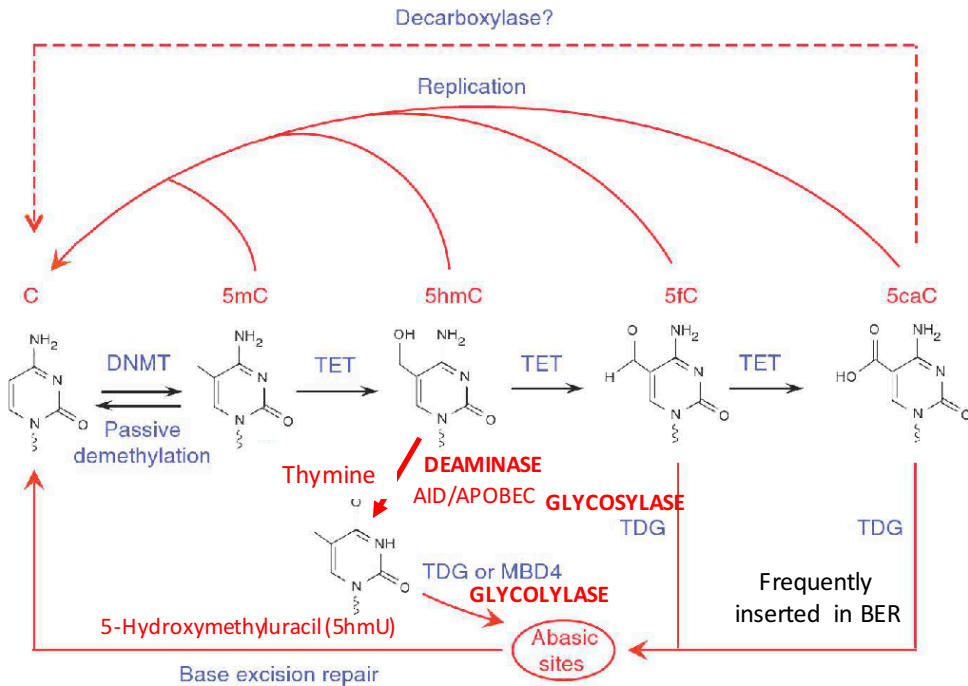

**Figure 6.** Model of Tet-initiated DNA demethylation pathways. DNA methylation (5mC) is established and maintained by DNMT. 5mC can be oxidized by Tet family of dioxygenases to generate 5hmC, 5fC, and 5caC. Because the oxidized 5mC derivatives cannot serve as substrates for DNMT1, they can be lost by replication-dependent passive demethylation. 5hmC can be deaminated by AID/APOBEC to become 5hmU, which together with 5fC and 5caC can be excised by glycosylases such as TDG, followed by DNA repair to generate C. Alternatively, a putative decarboxylase may convert 5caC to C.

### Methyl-CpG Domain Protein 4 (MBD4) and Thymine DNA Glycosylase (TDG):

Major G:T glycosylases - remove thymine generated by the deamination of 5-methylcytosine.  
- Remove 5hmU produced by AID/AOPEC activity

**AID/APOBEC ("apolipoprotein B mRNA editing enzyme, catalytic polypeptide-like")** is a conserved cytidine deaminases. Members of this family are C-to-U editing enzymes → convert Cytosine to Uracil by deamination at position 4 of C  
Generation of mismatch!!

### Thymine-DNA glycosylase (TDG)

Clear involvement in gene expression control

- **Thymine-DNA glycosylase (TDG)** removes thymine moieties from G/T mismatches by hydrolyzing the carbon-nitrogen bond between the sugar-phosphate backbone of DNA and the mispaired thymine.
- With lower activity, this enzyme also removes thymine from C/T and T/T mispairings.
- TDG can also remove uracil and 5-bromouracil from mispairings with guanine.

Interestingly, TDG knockout mouse models showed no increase in mispairing frequency suggesting that other enzymes, like the functional homologue MBD4, may provide functional redundancy.

- Human thymine DNA glycosylase (hTDG) was reported to **efficiently excise 5-Hydroxymethyluracil (5hmU), 5-formylcytosine (5fC) and 5-carboxylcytosine (5caC)**, the key oxidation products of 5-methylcytosine in genomic DNA.

→ Activation of BER pathway  
→ Insertion of unmethylated C

Check textbooks: glycosilases cleave off bases from sugar → apyrimidic/apurinic site → BER pthway

# DNA METHYLATION IS REVERSIBLE: DNA DEMETHYLATION BY Tet-family proteins

## Base excision pathway and loss of DNA methylation

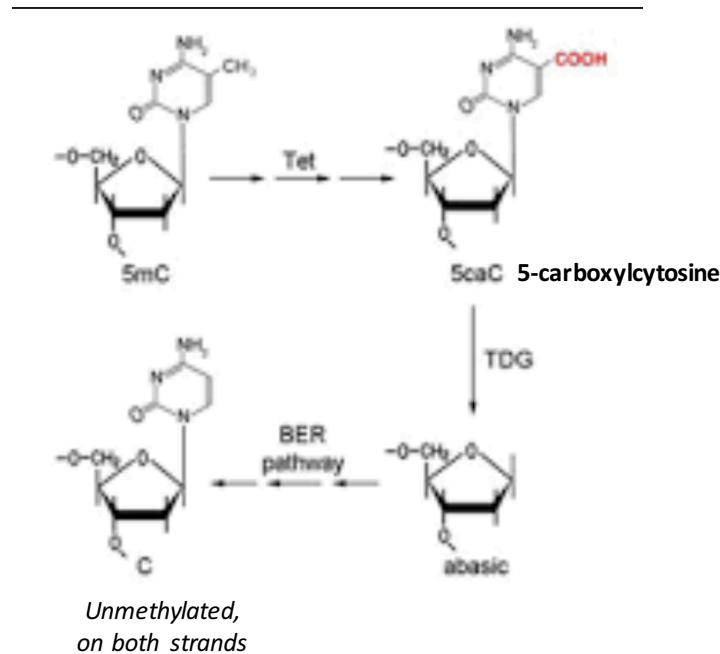
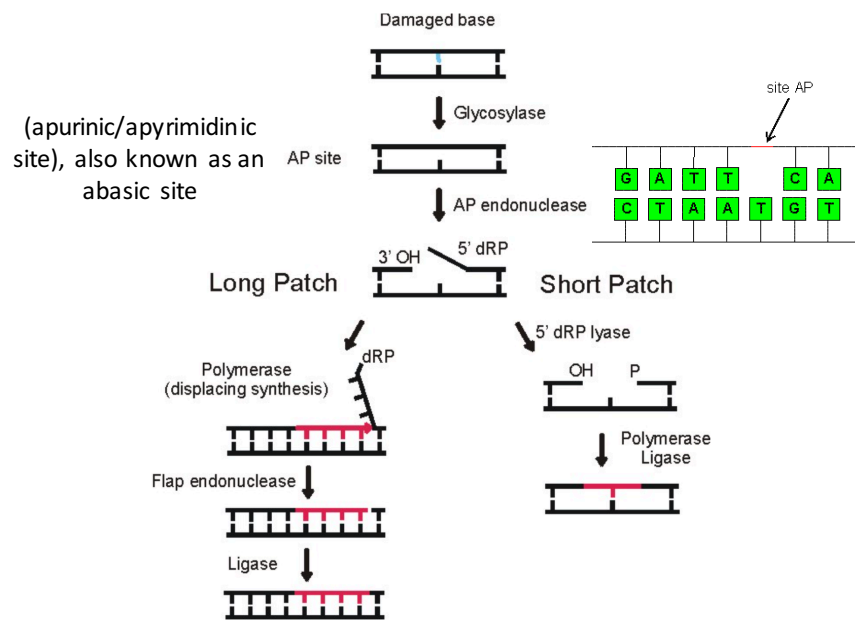

**AID/APOBEC ("apolipoprotein B mRNA editing enzyme, catalytic polypeptide-like")** is a conserved cytidine deaminase. Members of this family are C-to-U editing enzymes → convert Cytosine to Uracil by deamination at position 4 of C. Generation of mismatch!!

### Thymine-DNA glycosylase (TDG)

Clear involvement in gene expression control

- **Thymine-DNA glycosylase (TDG)** removes thymine moieties from G/T mismatches by hydrolyzing the carbon-nitrogen bond between the sugar-phosphate backbone of DNA and the mispaired thymine.
- With lower activity, this enzyme also removes thymine from C/T and T/T mispairings.
- TDG can also remove uracil and 5-bromouracil from mispairings with guanine.

Interestingly, TDG knockout mouse models showed no increase in mispairing frequency suggesting that other enzymes, like the functional homologue MBD4, may provide functional redundancy.

- Human thymine DNA glycosylase (hTDG) was reported to **efficiently excises 5-Hydroxymethyluracil (5hmU), 5-formylcytosine (5fC) and 5-carboxylcytosine (5caC), the key oxidation products of 5-methylcytosine in genomic DNA.**

- Activation of BER pathway
- Insertion of unmethylated C

## DNA METHYLATION IS ABUNANT IN THE GENOME AND IS SUBJECTED TO DRAMATIC ALTERATIONS DURING EMBRYOGENESIS

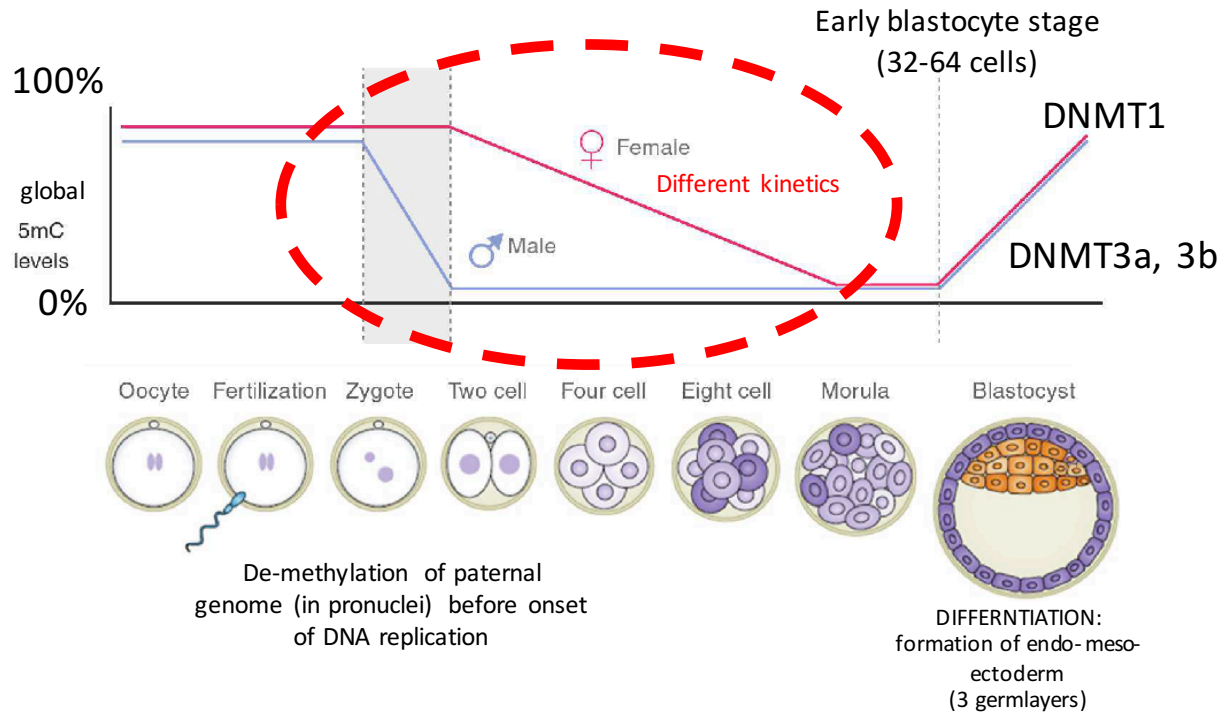

DNA methylation levels are high in fertilized Oocytes that contain the paternal and maternal genome (carries characteristic methylation patterns)

Paternal and maternal methylation patterns are rapidly erased (exception: imprinted genes maintain paternal and maternal methylation information). → the paternal and maternal methylation epigenome is cancelled

DNA methylation levels remain low during the first cell division events until the blastocyst stage

In the blastocyst stage cell differentiation programs are activated and genes need to be regulated on the epigenetic level → DNA methylation is increasing (loss of DNMT1, DNMT3a or DNMT3b is lethal → establishment and maintenance of DNA methylation is impaired)

**70%- 80% of CpG di-nucleotides are methylated in the human genome!**

**Remember only 2% of the genome encode for mRNAs**

**98% is noncoding DNA that contains a large proportion of transposable elements, repeat sequences, etc...**



# DNA METHYLATION IS REVERSIBLE: ACTIVE AND PASSIVE DNA DEMETHYLATION

## DNA de-methylation of the paternal and maternal genome has different kinetics

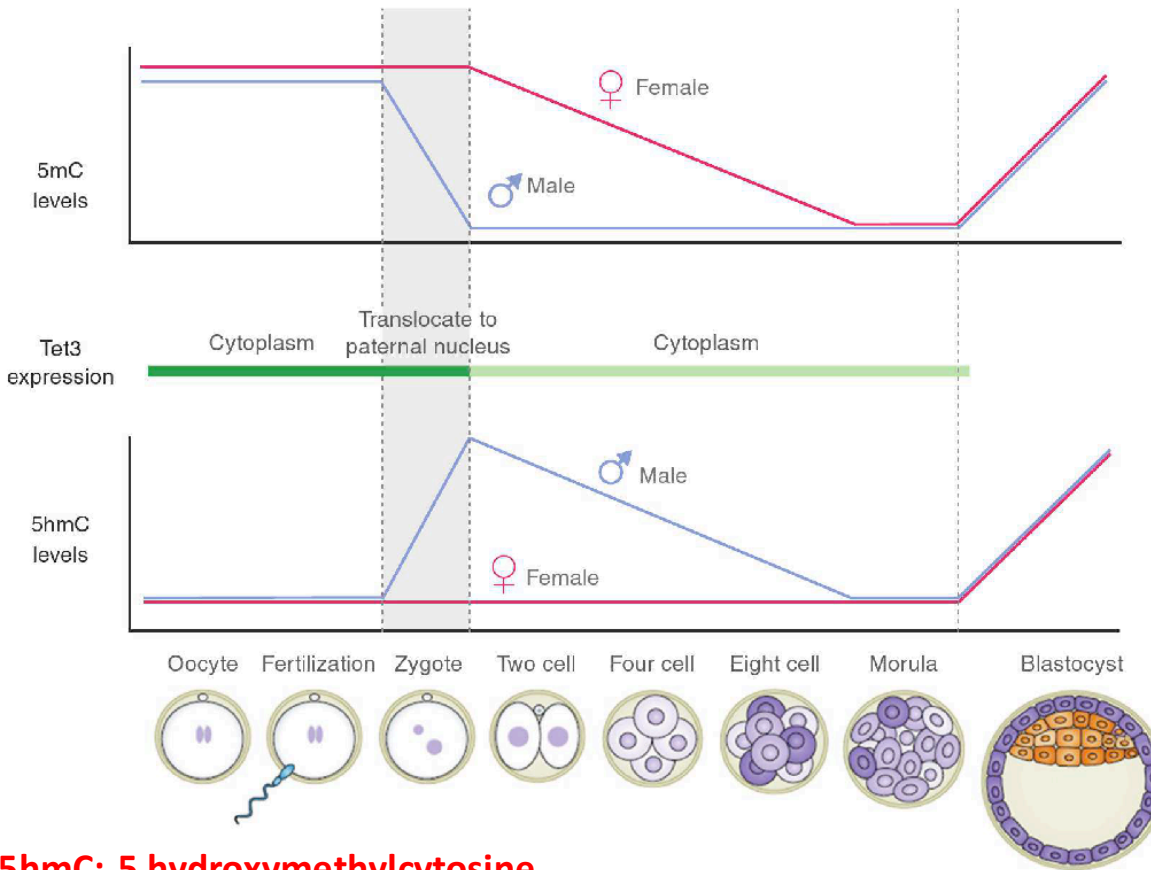

**5hmC: 5 hydroxymethylcytosine**

## PASSIVE DNA DEMETHYLATION – MATERNAL GENOME

Successive rounds of DNA methylation reduce the amount of 5mC.

**In this situation DNMT1 and Tet3 are excluded from the Nucleus by maternally deposited factor!**

**MATERNAL GENOME:** slow de-methylation of DNA

## ACTIVE DNA DEMETHYLATION – PATERNAL GENOME

Enzymatic activity rapidly de-methylates 5mC

**PATERNAL GENOME:** fast de-methylation of DNA

- ***In zygotes Tet3 is localized to the PATERNAL nucleus***
- ***Paternal DNA is demethylated***
- ***High levels of 5hmC: 5-hydroxymethylcytosine, 5fc: 5-formylcytosine and 5caC: 5-carboxylcytosine were detected at high levels in the paternal nucleus***
- ***BER machinery concentrated in pronucleus***

# DNA METHYLATION IS REVERSIBLE: ACTIVE AND PASSIVE DNA DEMETHYLATION

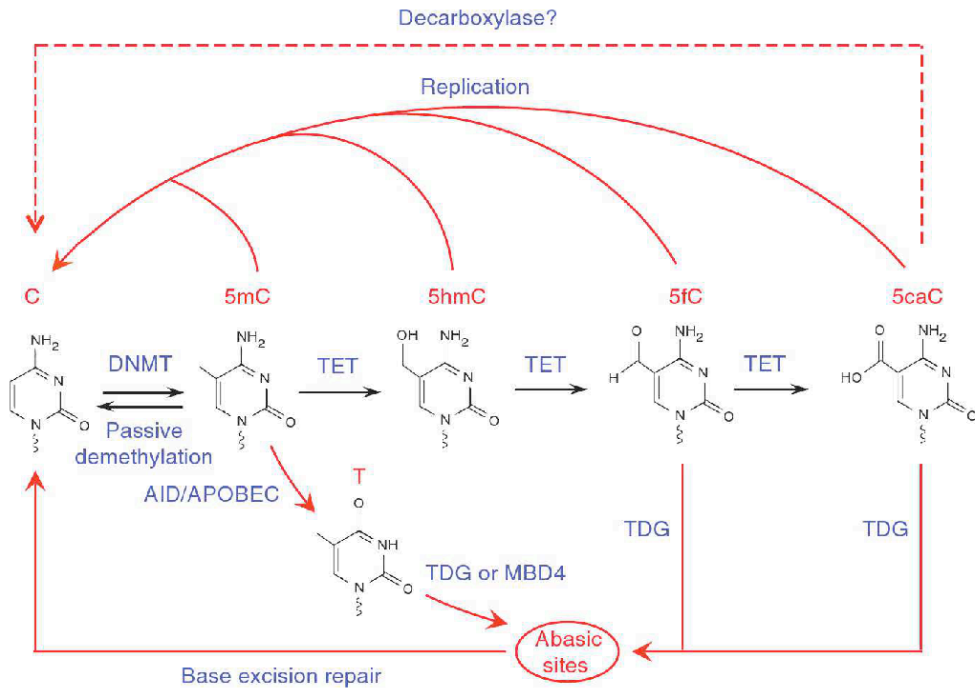

**Figure 6.** Model of Tet-initiated DNA demethylation pathways. DNA methylation (5mC) is established and maintained by DNMT. 5mC can be oxidized by Tet family of dioxygenases to generate 5hmC, 5fC, and 5caC. Because the oxidized 5mC derivatives cannot serve as substrates for DNMT1, they can be lost by replication-dependent passive demethylation. 5hmC can be deaminated by AID/APOBEC to become 5hmU, which together with 5fC and 5caC can be excised by glycosylases such as TDG, followed by DNA repair to generate C. Alternatively, a putative decarboxylase may convert 5caC to C.

## ACTIVE DNA DEMETHYLATION – PATERNAL GENOME

- Enzymatic activity rapidly de-methylates 5mC
- PATERNAL GENOME:** fast de-methylation of DNA
- *In zygotes Tet3 is localized to the PATERNAL nucleus*
- *Paternal DNA is demethylated*
- *High levels of 5hmC: 5-hydroxymethylcytosine, 5fC: 5-formylcytosine and 5caC: 5-carboxylcytosine were detected at high levels in the paternal nucleus*
- *BER machinery concentrated in pronucleus*

