

ESPERIENZA 1

Gli acetilacetonato complessi sintetizzati

Complesso	[Cr(acac)₃]	[Mn(acac)₃]	[Fe(acac)₃]	[Co(acac)₃]	[Cu(acac)₂]
Stato di ox	+ 3	+ 3	+ 3	+ 3	+ 2
Config. Elettr.	d^3	d^4	d^5	d^6	d^9
Geometria	Ottaedr.	Ottaedr.	Ottaedr.	Ottaedr.	Plan. Quadr.
Magnetismo	Param.	Param.	Param.	Diam.	Param.
	[Al(acac) ₃]	+ 3	d^0	Ottaedr.	Diam. beige

Effetto Jahn-Teller

Per molecole non lineari in uno stato elettronicamente degenere deve avvenire una distorsione per abbassare la simmetria, togliere la degenerazione e abbassare l'energia.

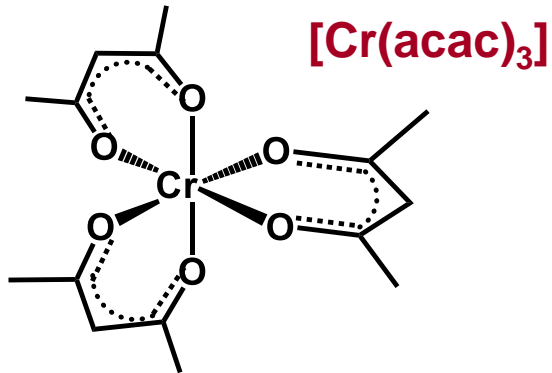

Ottaedro, d^3

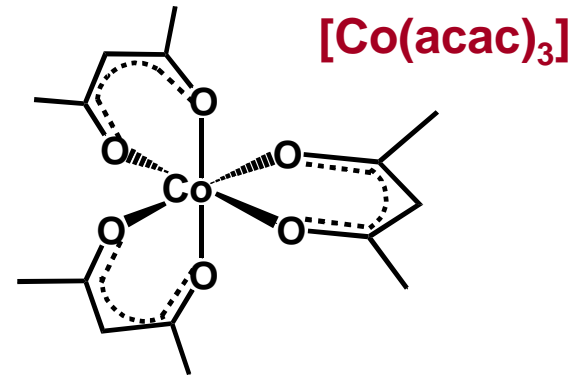
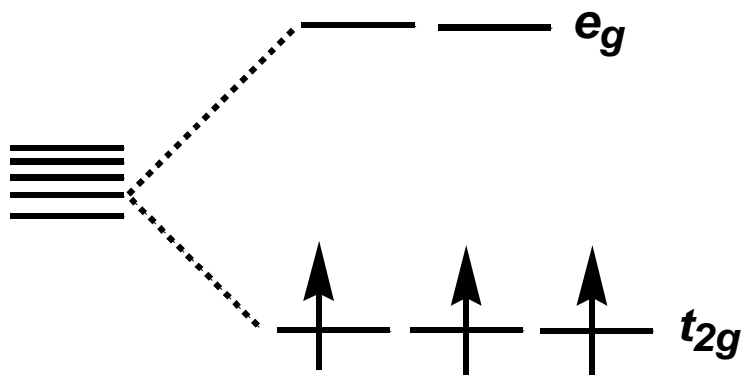

Ottaedro, d^6

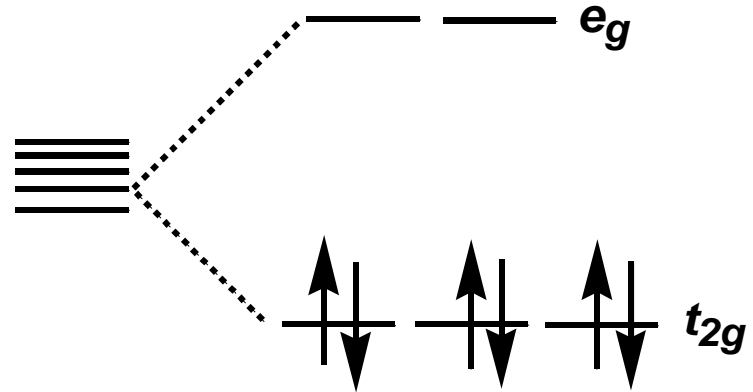

NO effetto Jahn-Teller

[Co(acac)₃]

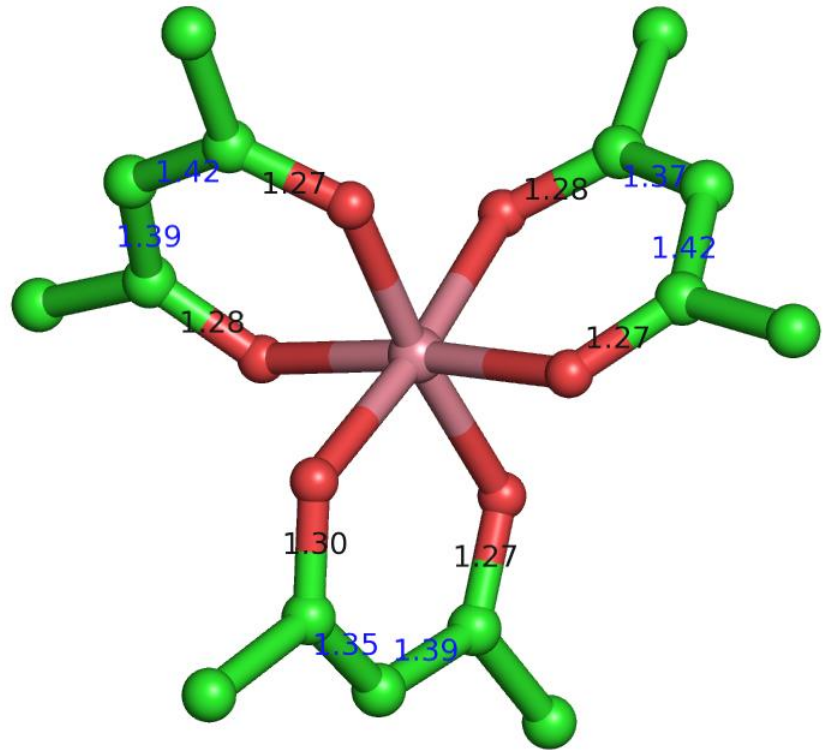
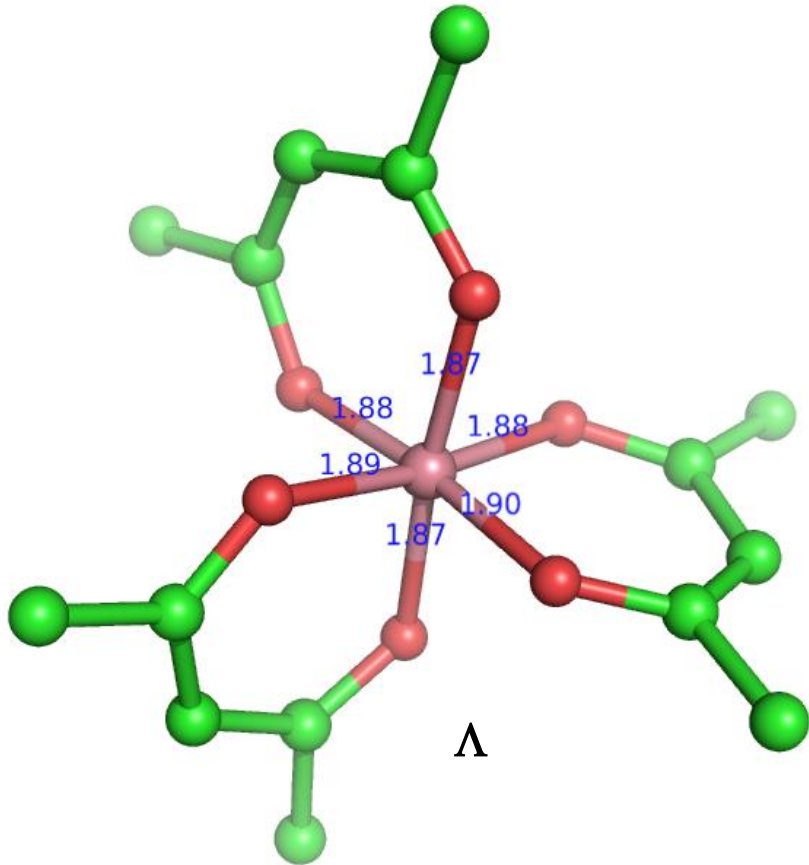
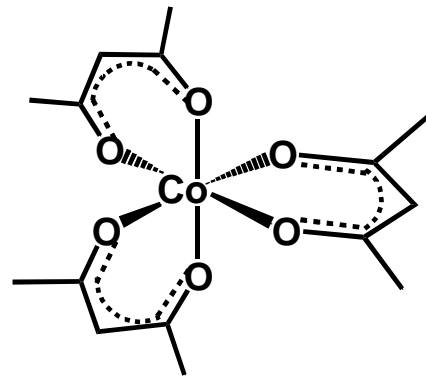

[Co(acac)₃]

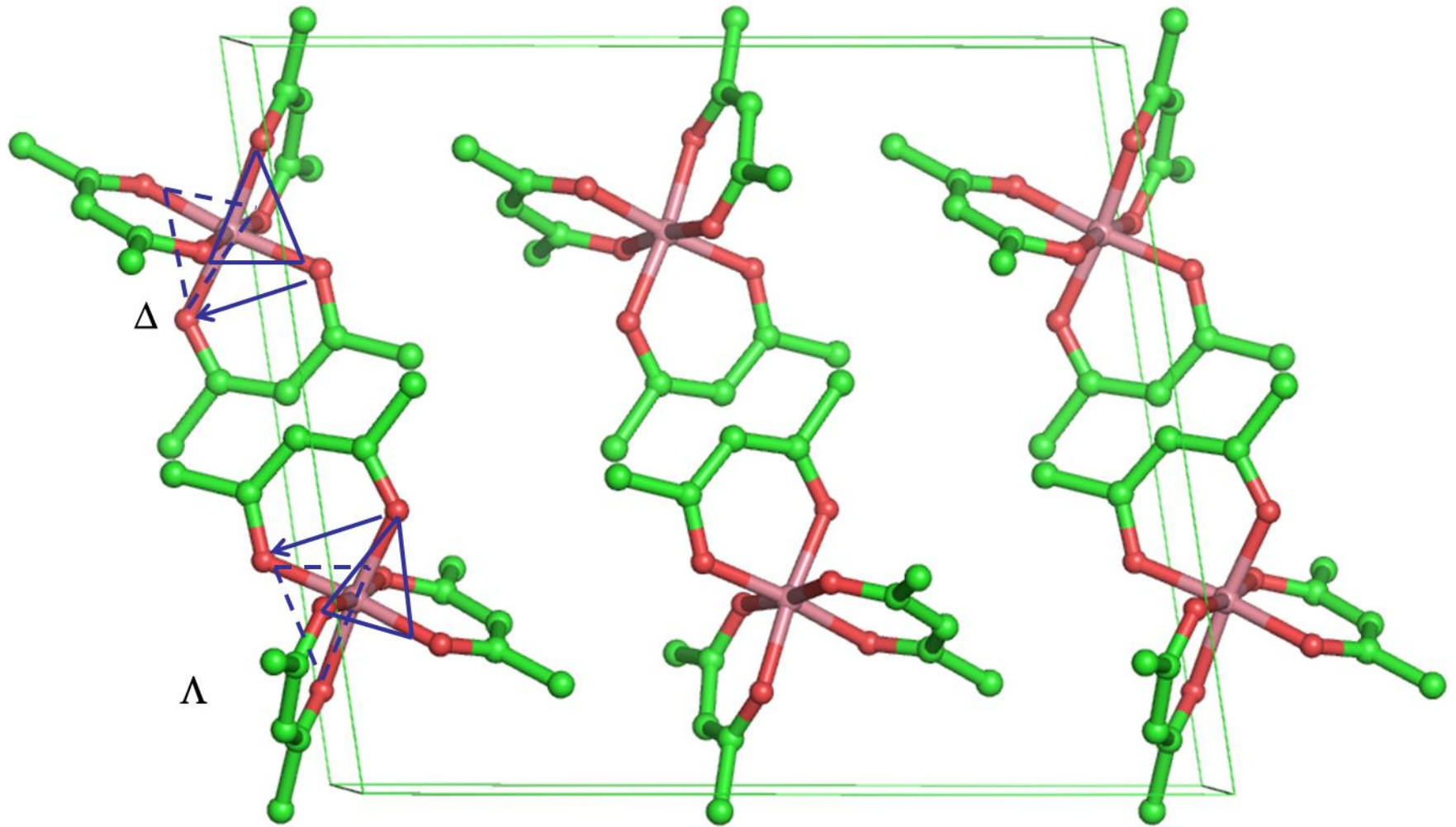

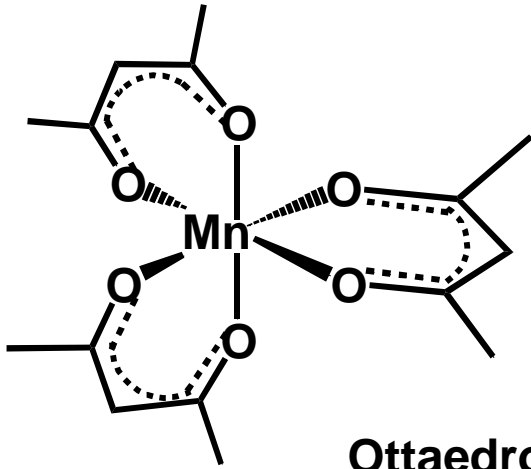

Ottaedro, d^4

Distorsioni per effetto Jahn-Teller:

Allungamento: 2 Mn-O 2.12 Å;
4 Mn-O 1.93 Å;

Compressione: 2 Mn-O 1.95 Å;
4 Mn-O 2.00 Å.

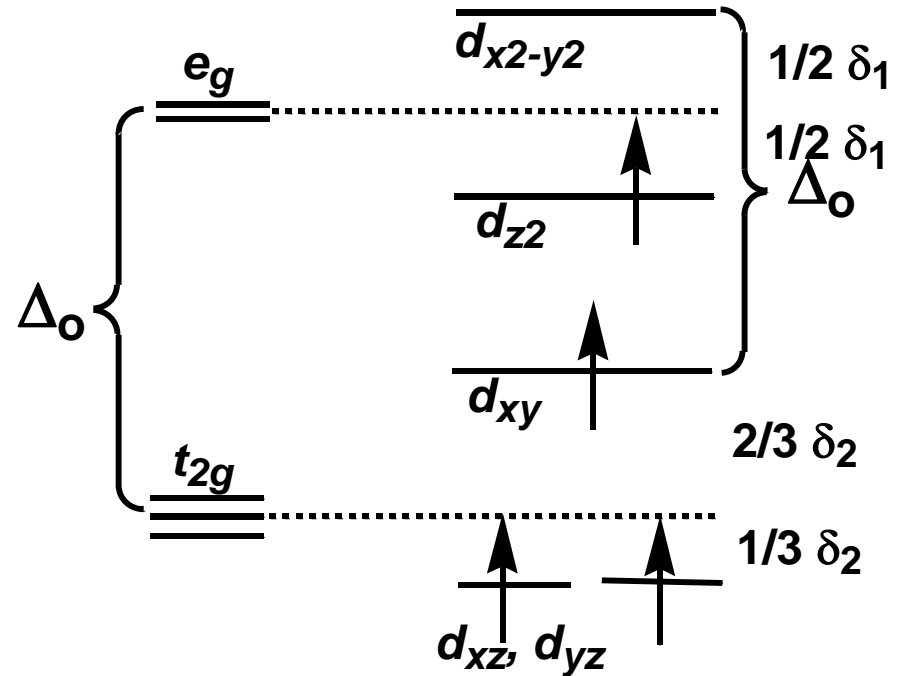
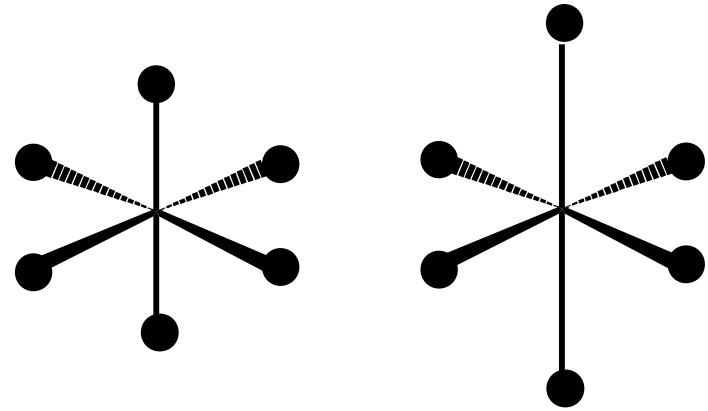

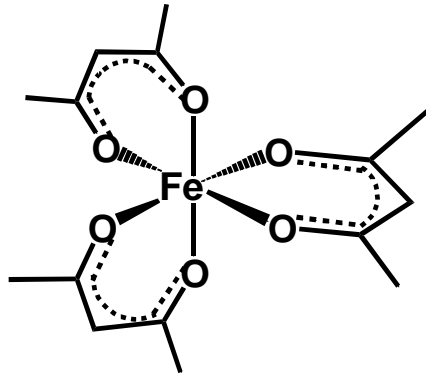

Ottaedro, d^5

alto spin

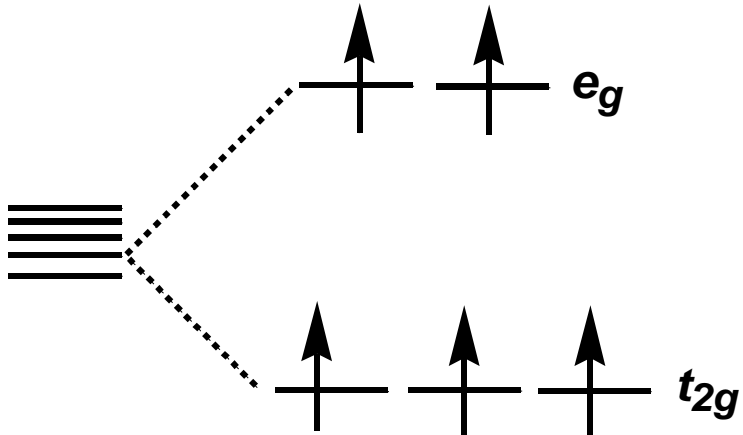

NO effetto Jahn-Teller

basso spin

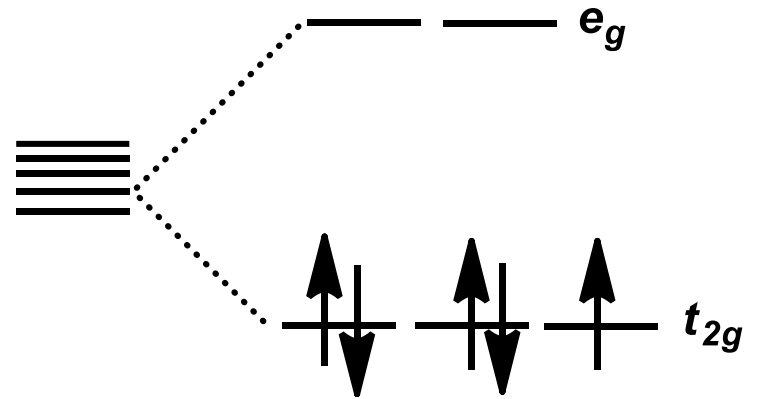

SI' effetto Jahn-Teller

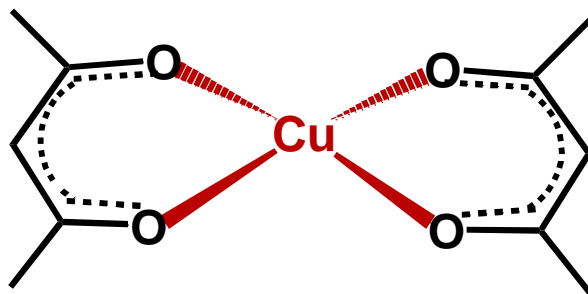

planare quadrato, d^9

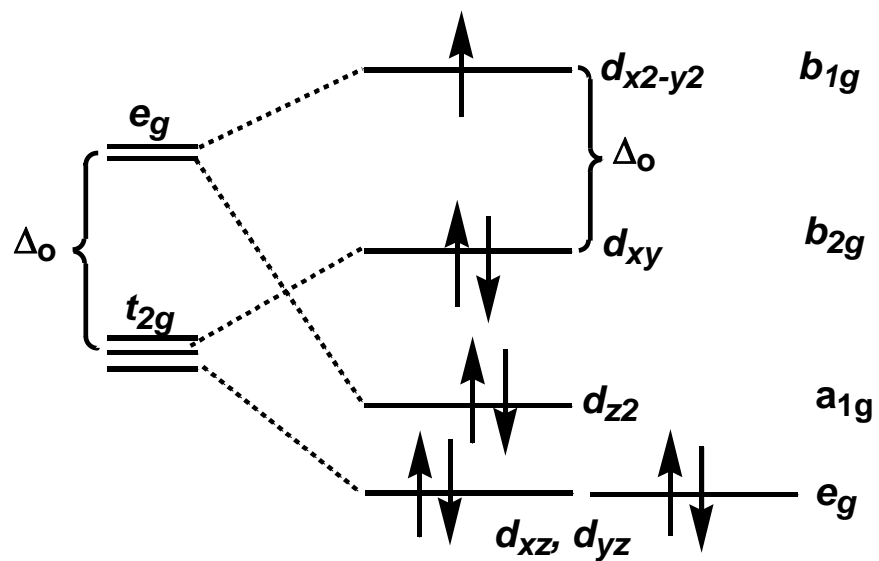
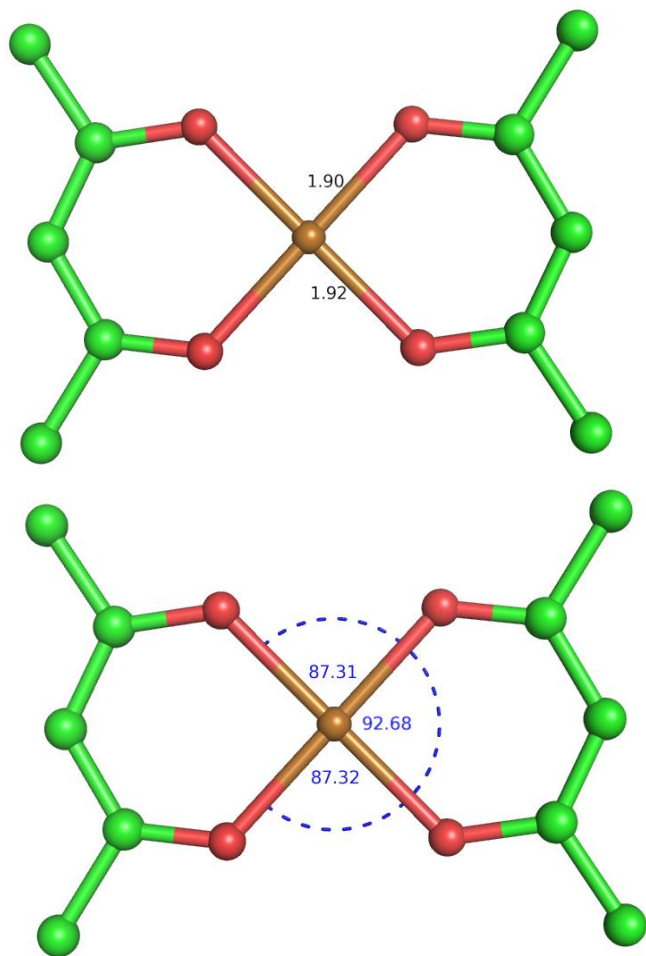

paramagnetico

ESPERIENZA 1

Cromatografia su strato sottile degli acetilacetonato complessi

Complesso	Colore	r_F
$[\text{Cr}(\text{acac})_3]$	viola
$[\text{Mn}(\text{acac})_3]$	nero
$[\text{Fe}(\text{acac})_3]$	Rosso
$[\text{Co}(\text{acac})_3]$	Verde scuro
$[\text{Cu}(\text{acac})_2]$	Azzurro verde

Spettro ^1H NMR in CDCl_3 , a t.a. di 2,4-pentandione

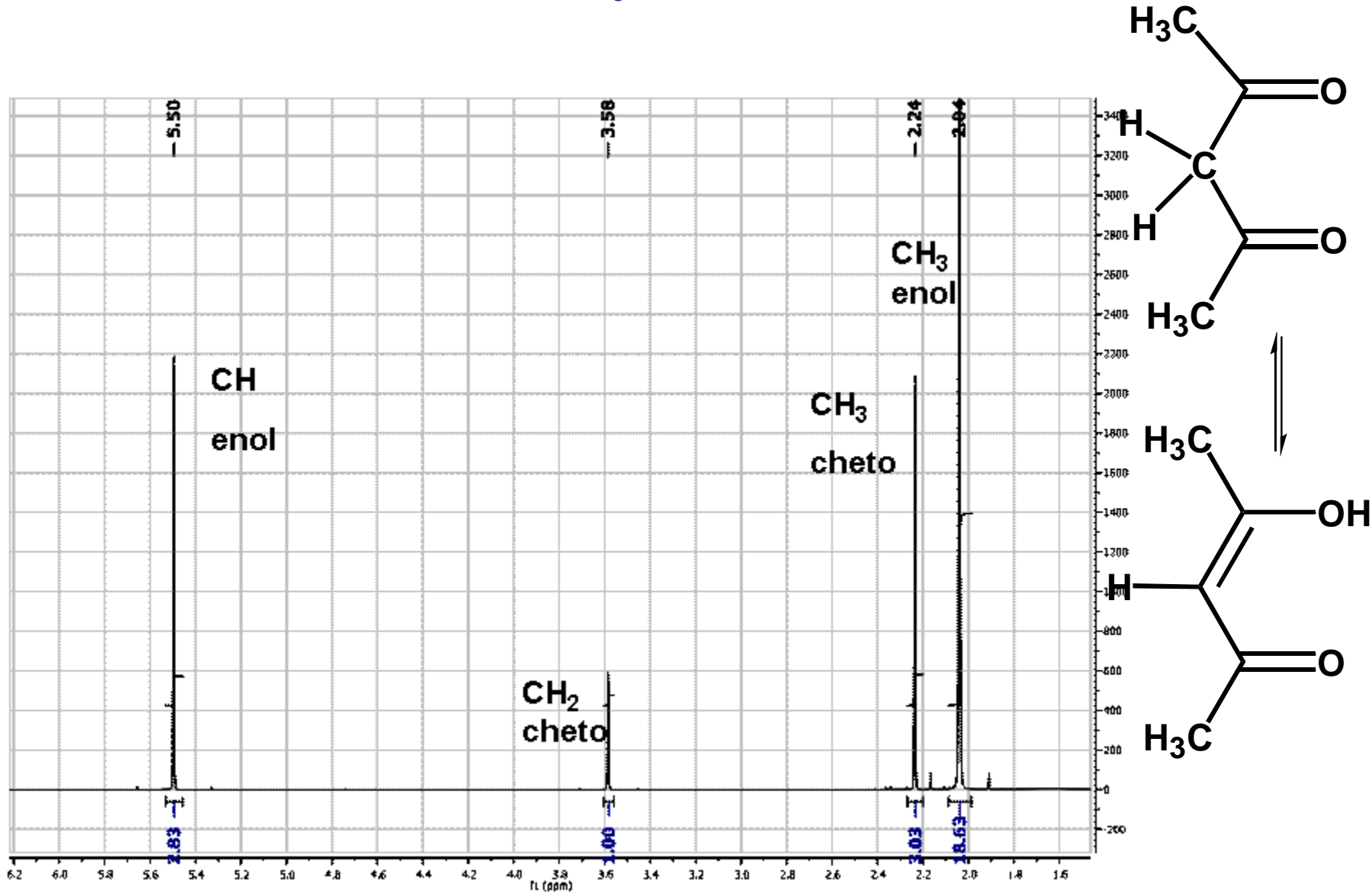

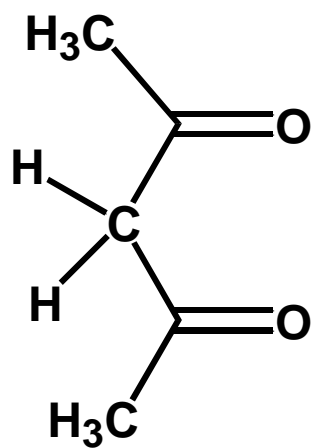

forma cheto

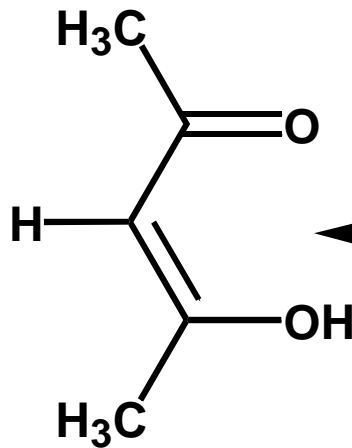
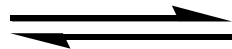

forma enolica

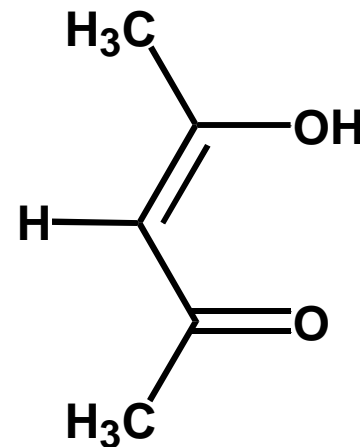

Spettro ^{13}C NMR in CDCl_3 , a t.a. di 2,4-pentandione

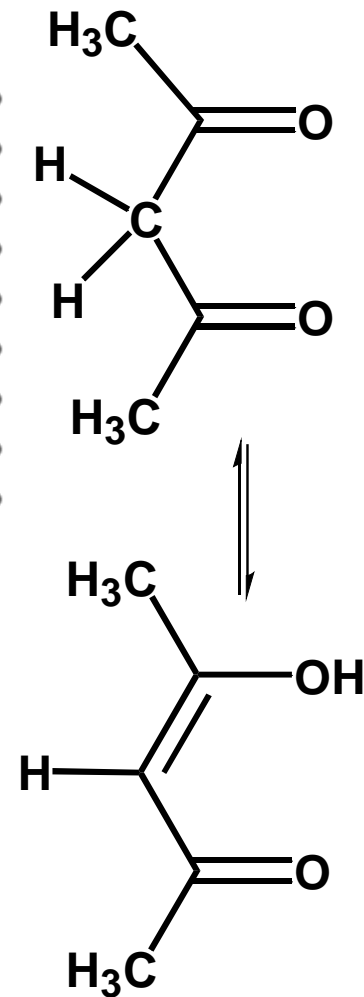
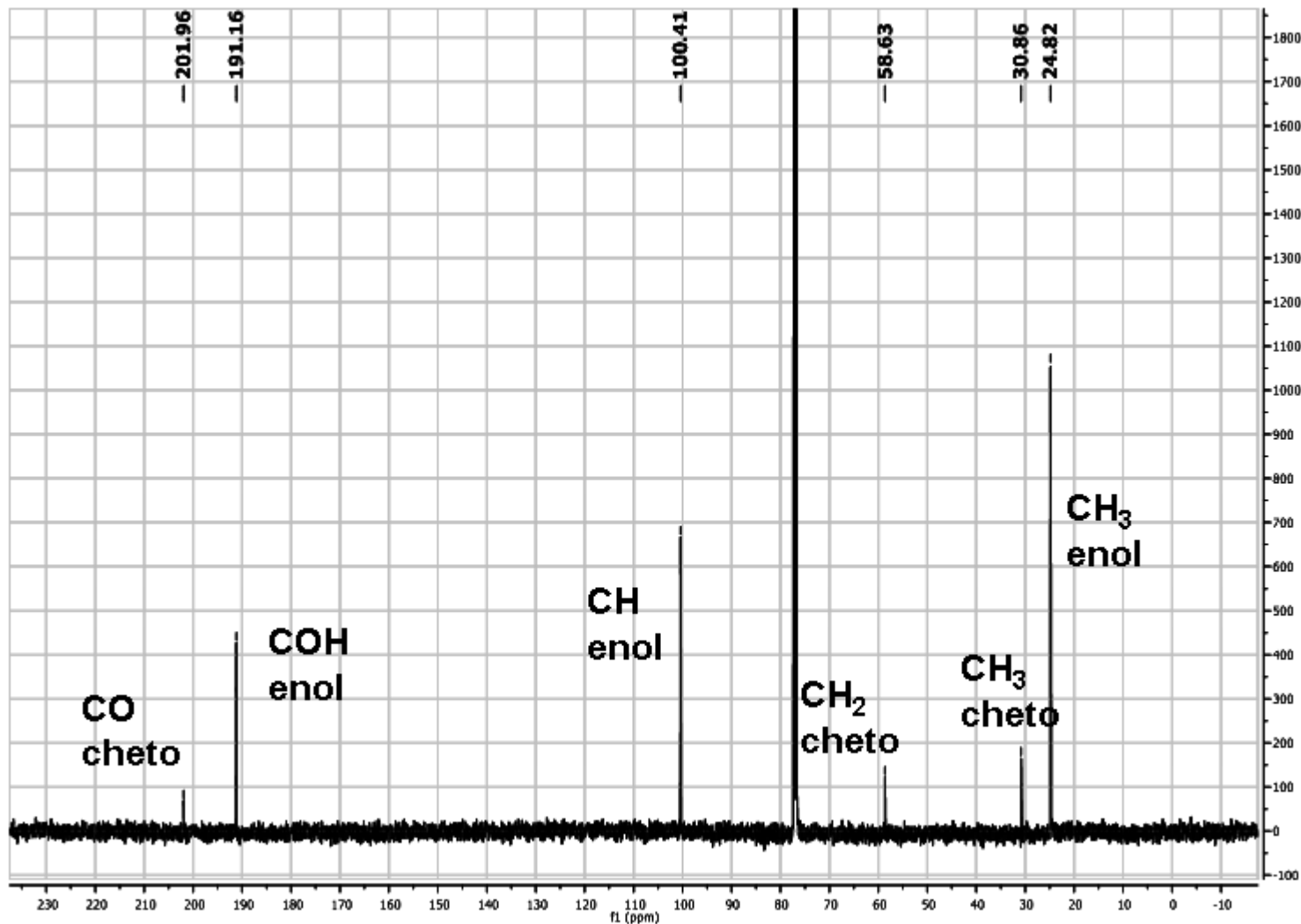

Spettro HC COSY (HSQC) NMR in CDCl_3 , a t.a. di 2,4-pentandione

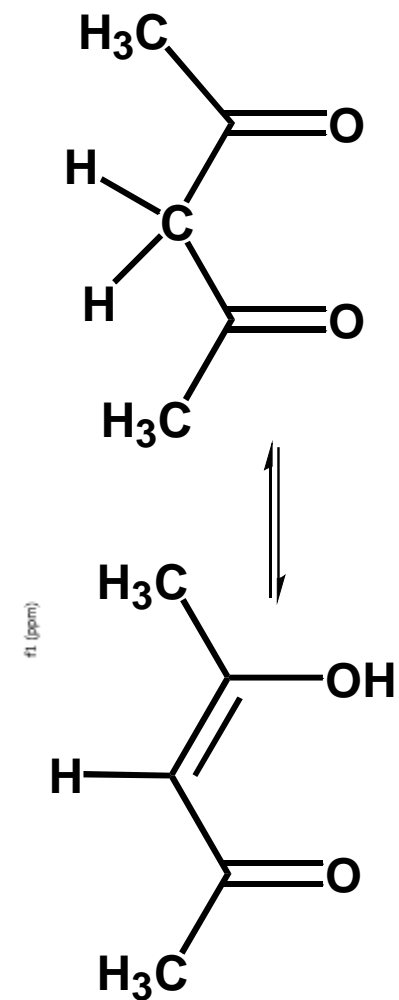
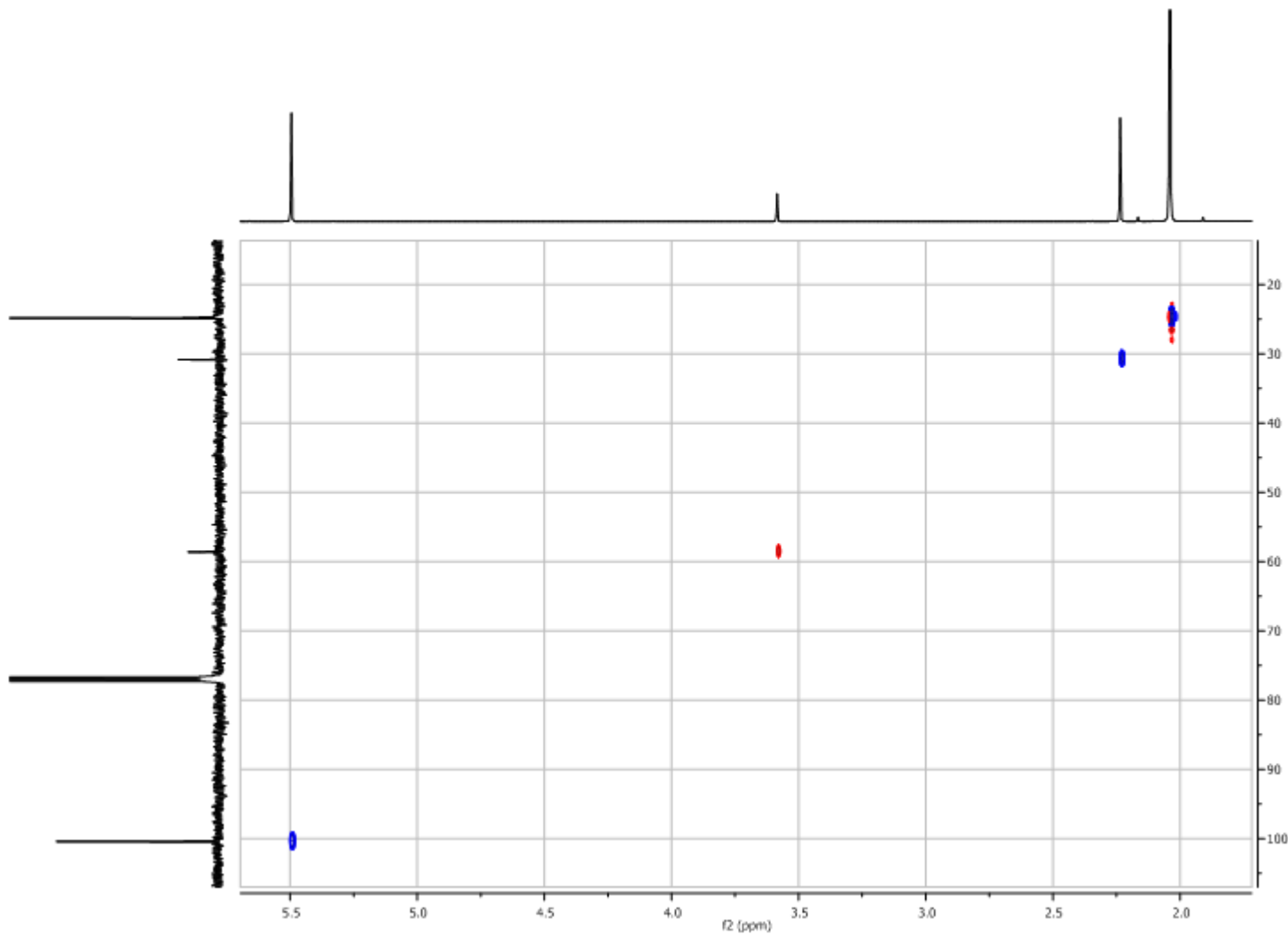

Spettro ^1H NMR in CDCl_3 , a t.a. di $[\text{Al}(\text{acac})_3]$

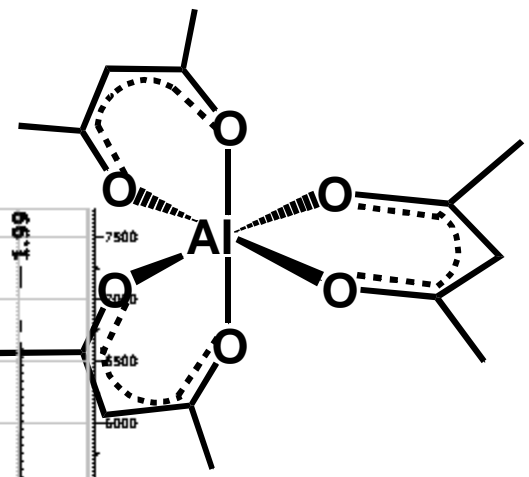
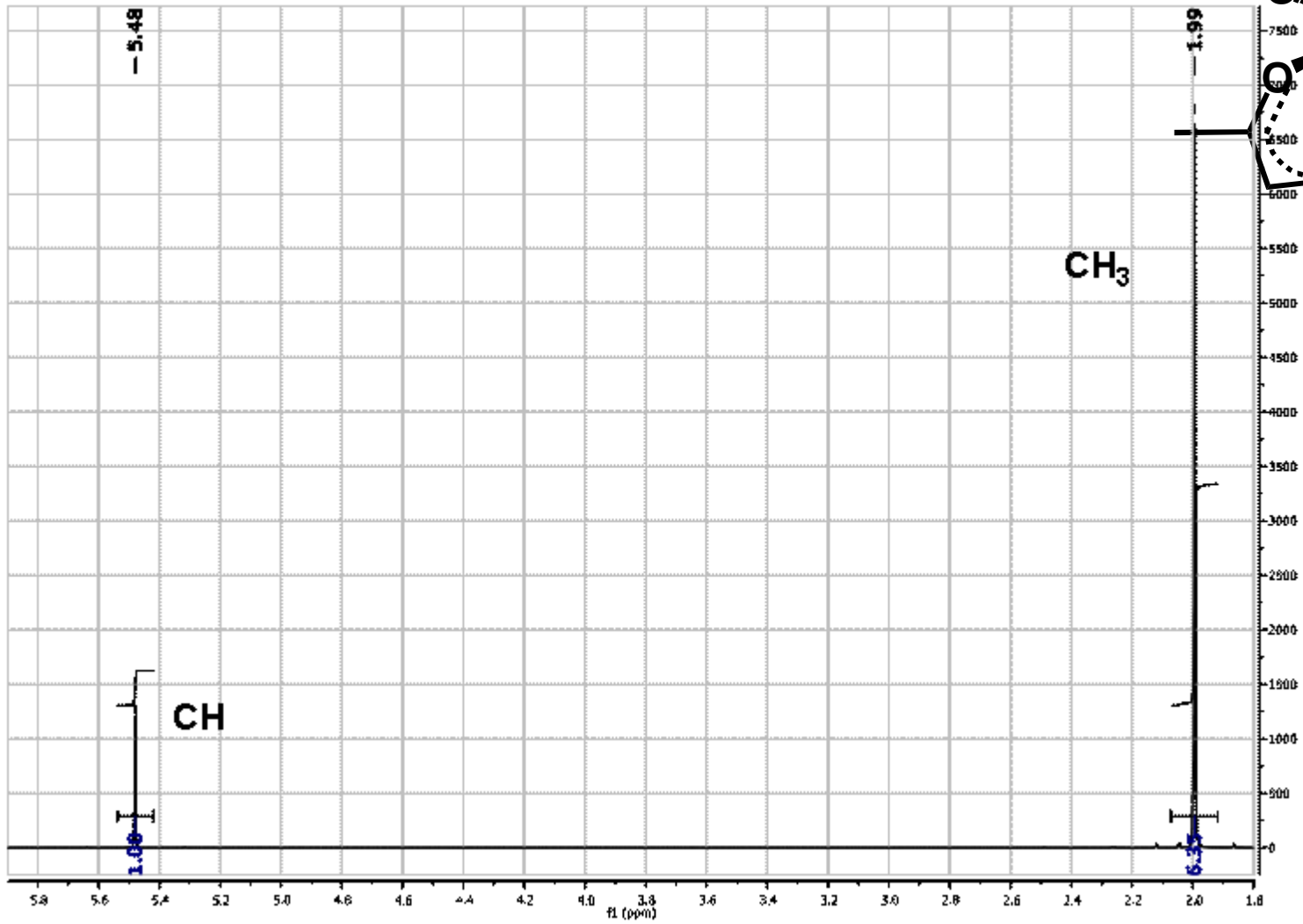

Spettro ^{13}C NMR in CDCl_3 , a t.a. di $[\text{Al}(\text{acac})_3]$

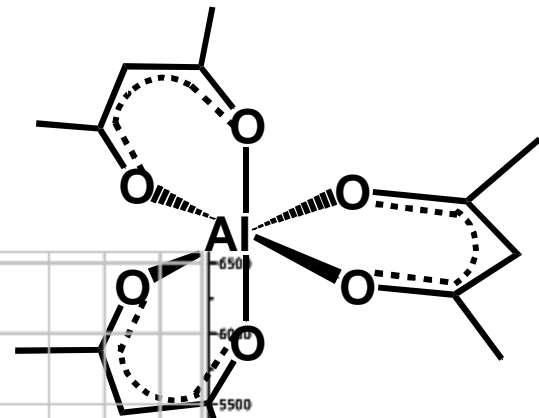
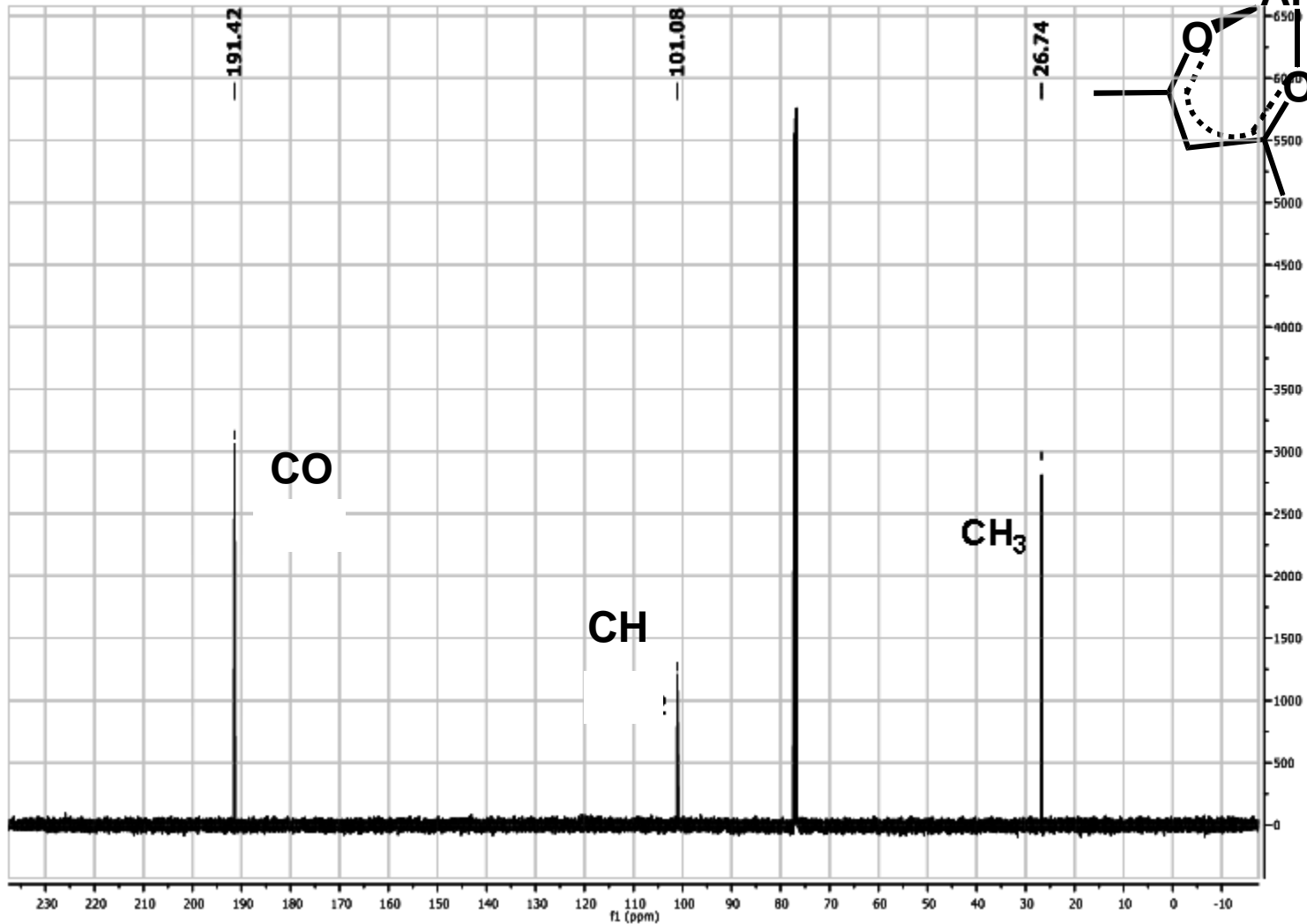

Spettro HC COSY (HSQC) NMR in CDCl_3 , a t.a.

di $[\text{Al}(\text{acac})_3]$

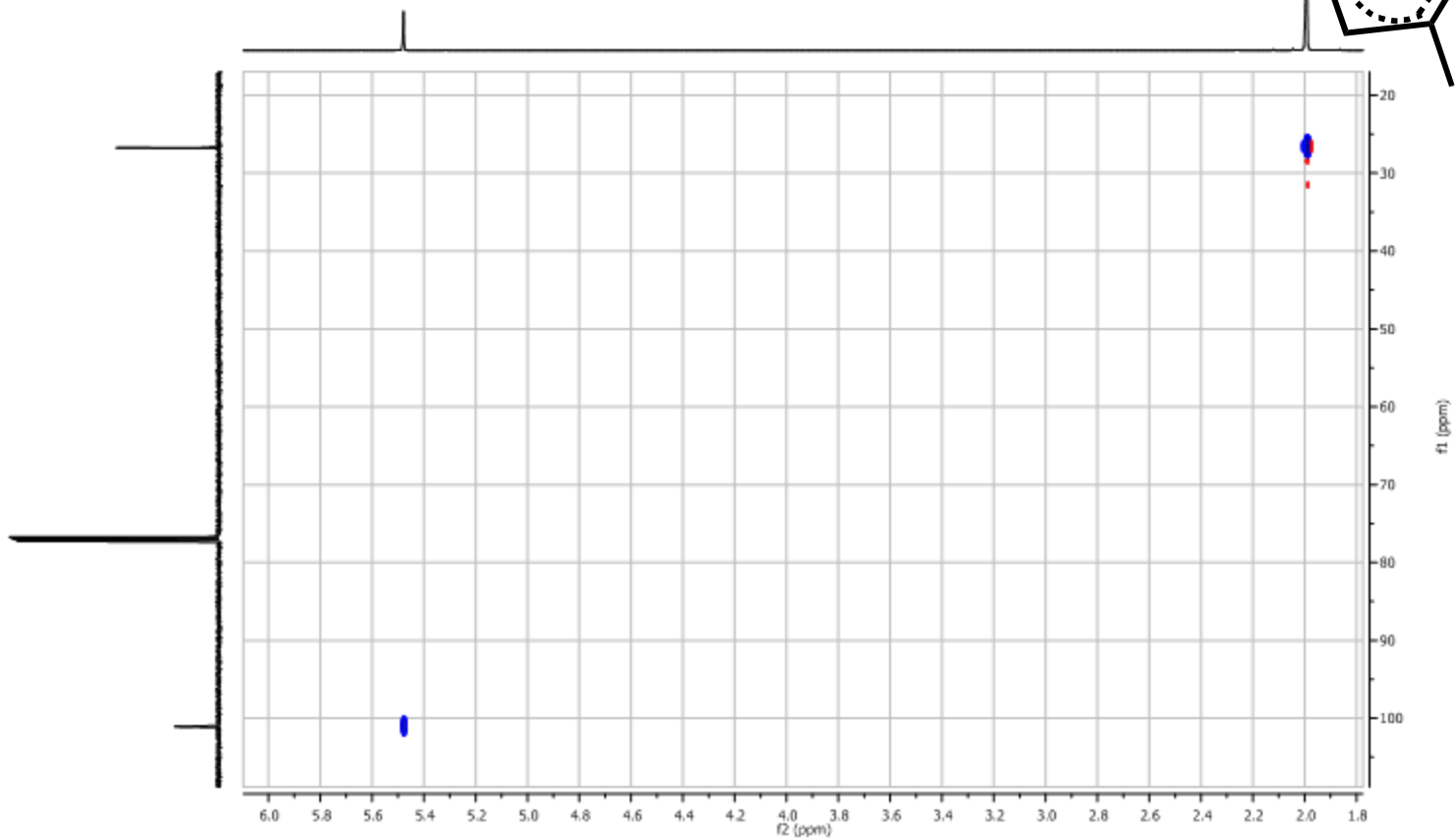
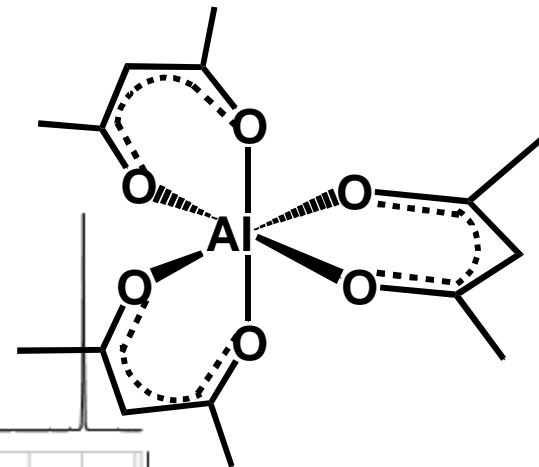

Spettro ^1H NMR in CDCl_3 , a t.a. di $[\text{Co}(\text{acac})_3]$

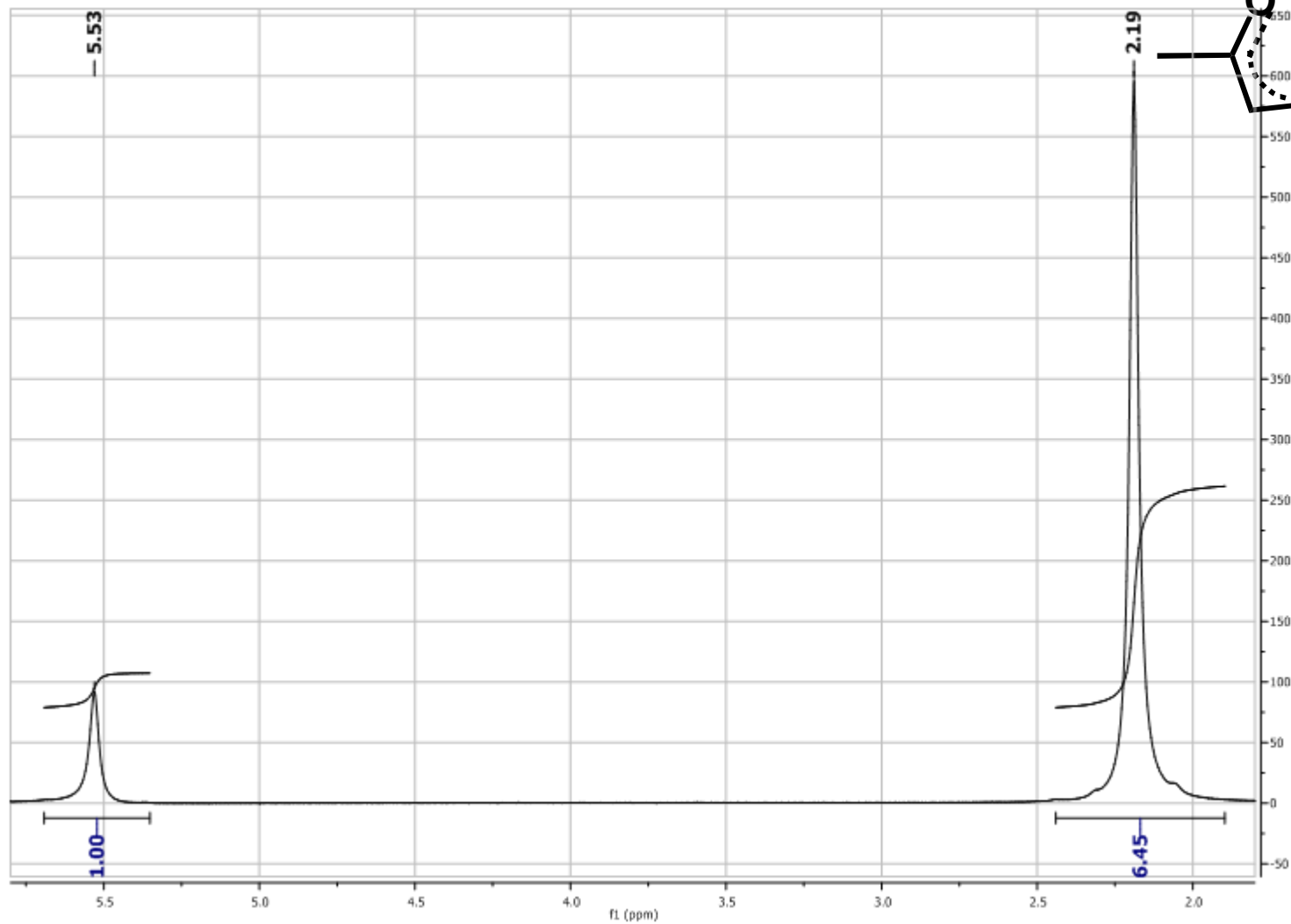
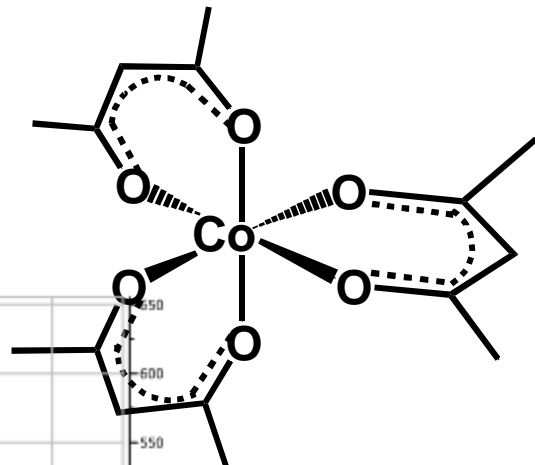

Spettro HC COSY (HSQC) NMR in CDCl_3 , a t.a.
di $[\text{Co}(\text{acac})_3]$

