

# Course of Geodynamics

Dr. Magdala Tesauro

## Course Outline:

1. Thermo-physical structure of the continental and oceanic crust
2. Thermo-physical structure of the continental lithosphere
3. Thermo-physical structure of the oceanic lithosphere and oceanic ridges
4. Rheology and mechanics of the lithosphere
5. Plate tectonics and boundary forces
6. Hot spots, plumes, and convection
7. Subduction zones systems
8. Orogens formation and evolution
9. **Sedimentary basins formation and evolution**

# SEDIMENTARY BASINS

A sedimentary basins is an **accumulation of sediments**. They can be several kms thick

- ❑ Most of the population of the world lives on sedimentary basins
- ❑ Most of the world resources come from sedimentary basins
- ❑ Sedimentary basins contain the record of geological and climatic events taking place in and around the basin

To make a sedimentary basin you need

- a place where to dump sediments = **ACCOMODATION SPACE**
- sediments

To make sediments it is fairly easy:

- you need a continental relief which you can erode (climate plays a big role)

# Sedimentary Basins

- Most of the thickest sedimentary basins were formed in intracontinental seas because they: (1) are surrounded by source regions, favoring collection of huge amounts of sediments; (2) contain water in sedimentary pores which facilitates the bending of rocks in folds (e.g., South Caspian Depression, surrounded by orogenic belts, such as the Greater Caucasus).
- Thickness of sedimentary rocks is usually greater in the middle of a basin (e.g., the South Caspian Depression), but in some cases the thickness can vary from one side to the opposite one (e.g., in the Dniepr–Donets Basin the max thickness of the sediments ranges from 2–6 km in the northwest to 15–19 km in the southeast).

## Sediment thickness distribution

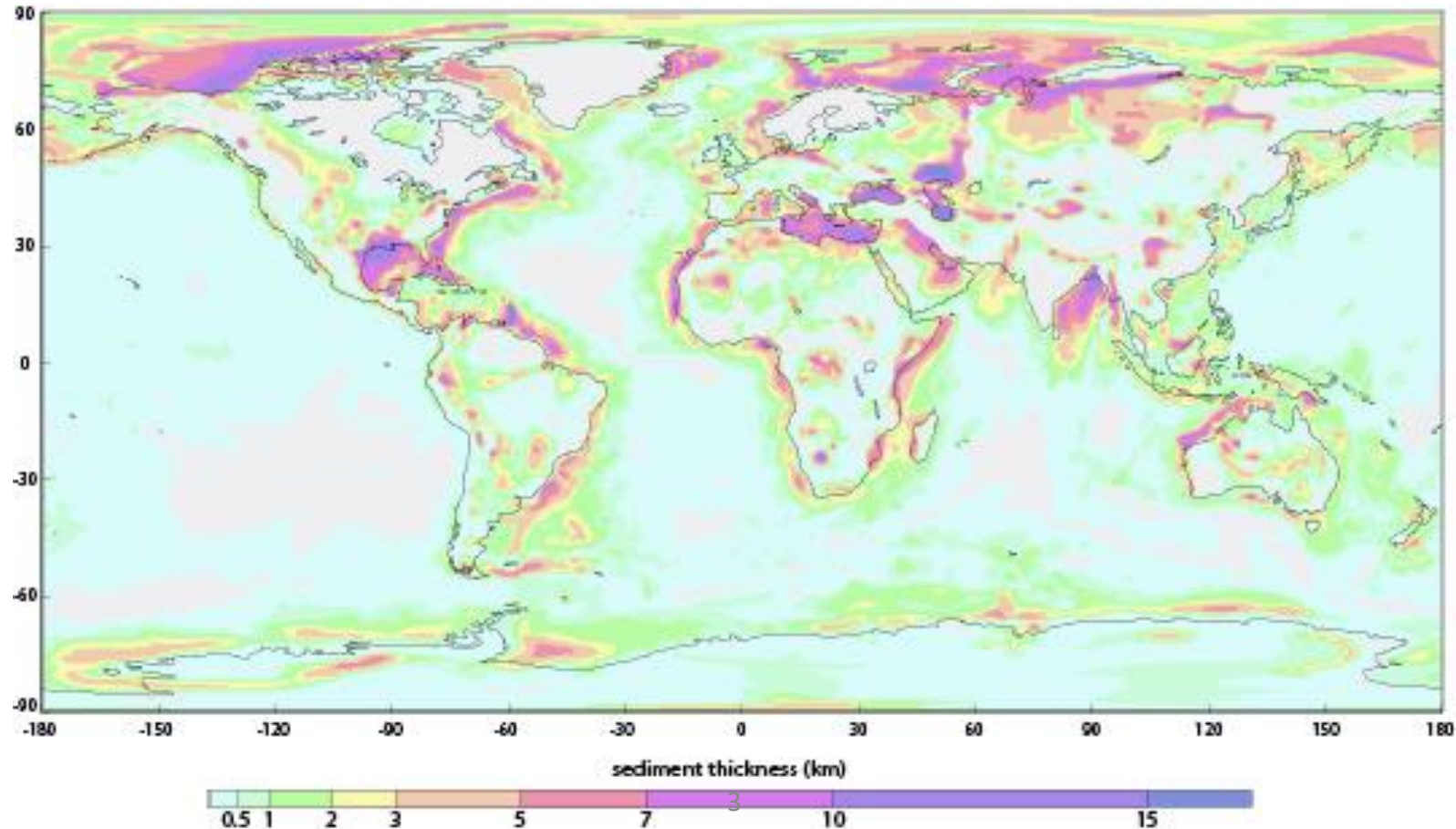

# How does it create a depositional space?

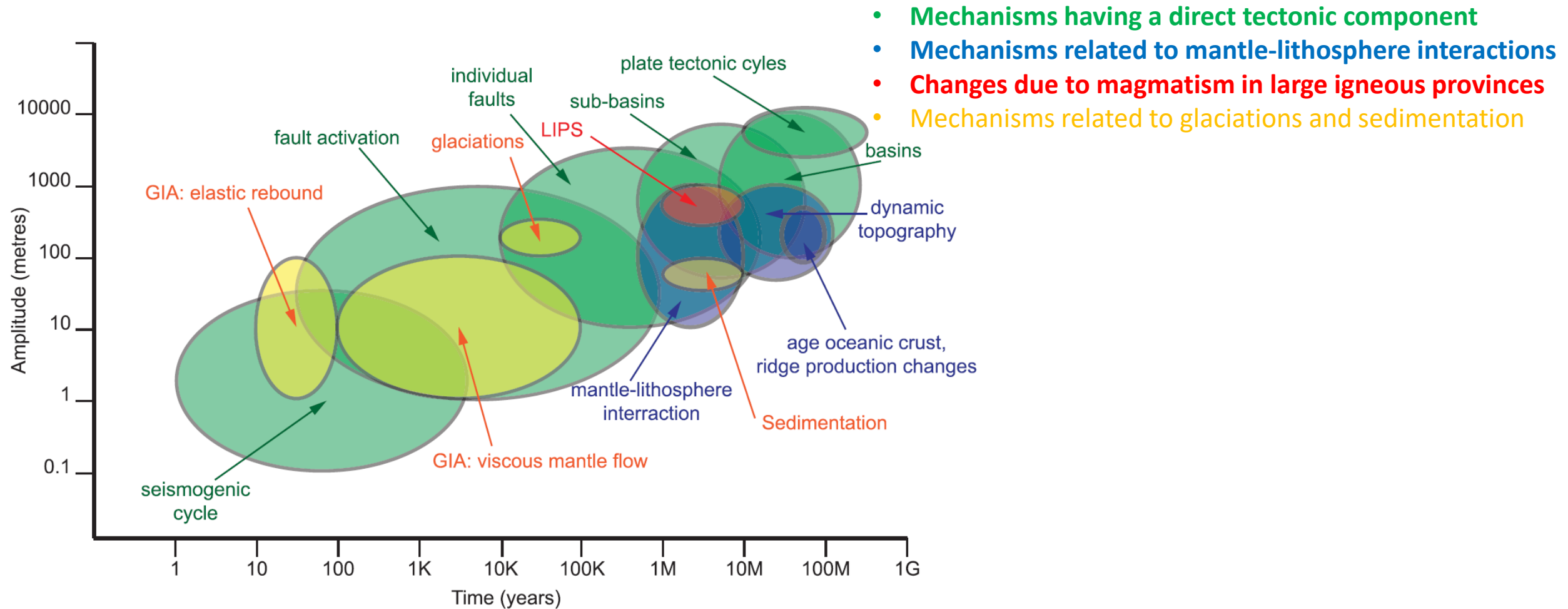

Temporal and spatial variability of the mechanisms that drive sea-level variations and create depositional space

- Sedimentary infill is affected not only by erosion and sediment supply, but also by the system's response to lithospheric flexure, rheology, thermal evolution, glacial isostatic adjustment, mantle-lithosphere interaction, rate of formation of oceanic lithosphere and dynamic topography.



# Sediments

**Sedimentation during basin evolution causes several physical/chemical changes to the basin-fill**

Compressibility: elastic response of a solid material allowing reduction of a volume caused by an increase in pressure or stress.

Consolidation: decrease in volume by a loss of water under static loading (usually applied to soils and young sediments).

Compaction: change in dimensions of a volume of sediment by a reduction of the pore space between a solid framework as a result of loading due to *mechanical compaction* (dominating in the cool upper portions of sedimentary basins) and *physical-chemical compaction* (e.g., pressure solution in the carbonates).

Porosity loss: loss of pore volume that accompanies burial due to compaction and cementation (filling of the pore space by chemical precipitation).

# Porosity of sediments

Porosity-depth relationships are affected by different factors:

- Gross lithology (shales compact quickly compared to sandstones)
- Depositional facies, controlling grain size, sorting, and clay content.
- Composition of framework grains, e.g., pure quartz arenite is different from lithic arenites.
- Temperature affects chemical diagenesis (quartz cementation, clay mineral growth, and pressure solution)
- Time: porosity loss may require sufficiently long periods of time.

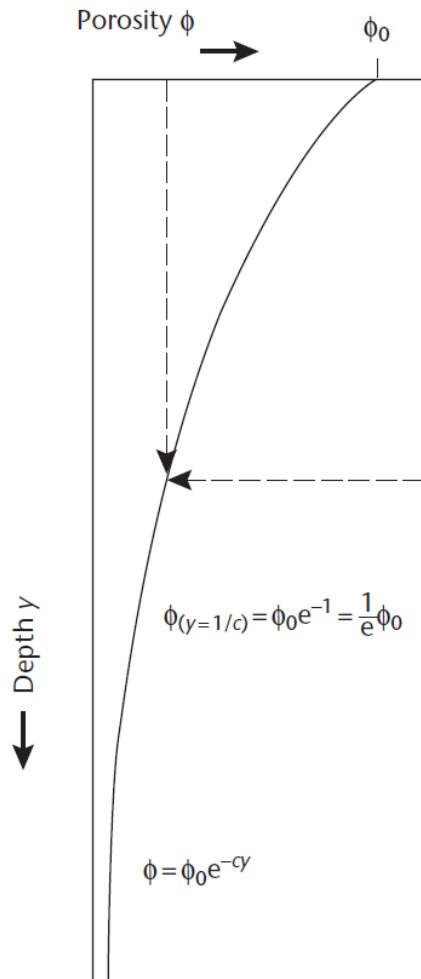

There are many porosity-depth relations, based on a principle of porosity destruction as a consequence to burial effect:

$$\phi = \phi_0 - ay \quad \phi(y) = \phi_0 \exp(-cy) \quad \phi(y) = \phi_0 \exp(-y/y_0)$$

$y_0$  = the depth at which the porosity has decreased to 1/e of its surface value

Lithology	$\phi_0$	$y_0$ (m)	$c$ ( $\text{km}^{-1}$ )
Shale	0.63 (0.71)	1960 (1961)	0.51 (0.51)
Sandstone	0.49	3703	0.27
Chalk	0.70	1408	0.71
Shaly sandstone	0.56	2464	0.40

# Porosity and permeability of sediments

$$\phi(y) = \phi_0 \exp(-cy) \quad \phi(y) = \phi_0 \exp(-y/y_0)$$

$y_0$  = the depth at which the porosity has decreased to 1/e of its surface value

## Permeability of rocks

Rock	$k$ (m <sup>2</sup> )
Fractured rocks	$10^{-7} - 10^{-10}$
Fresh granite	$10^{-17} - 10^{-18}$
Sandstone	$10^{-14}$
Limestone	$10^{-16}$

$$1 \text{ Darcy} = 10^{-12} \text{ m}^2$$

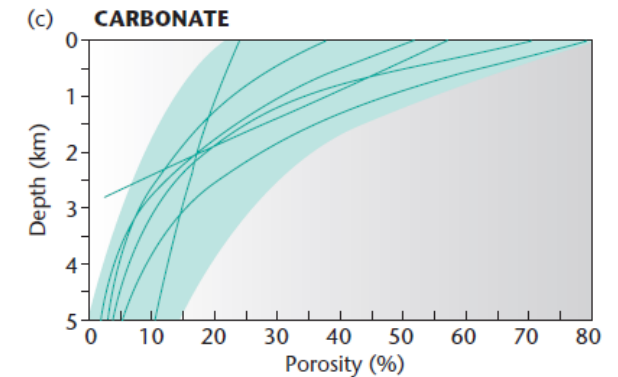
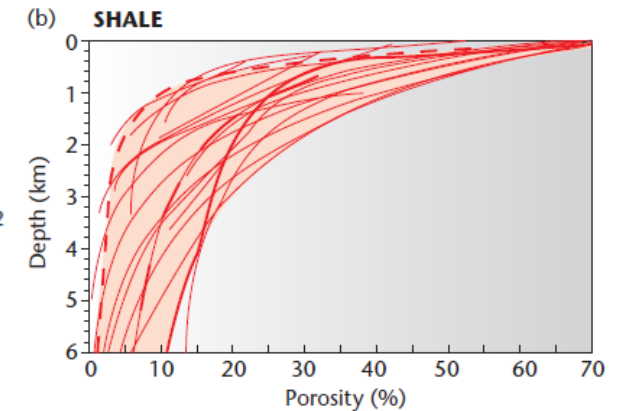
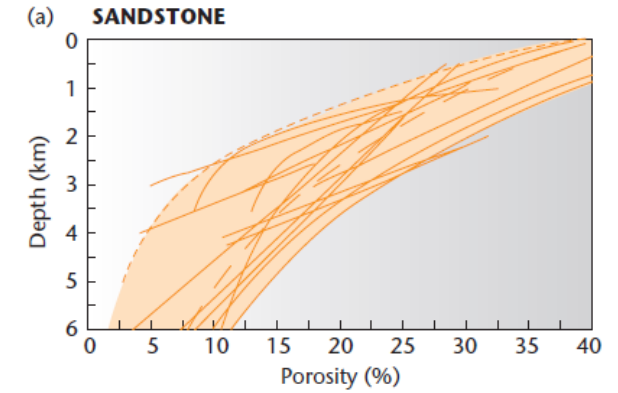
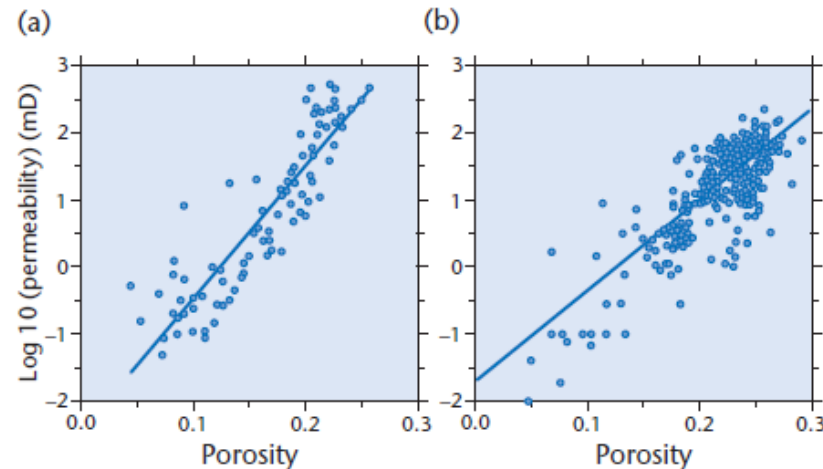
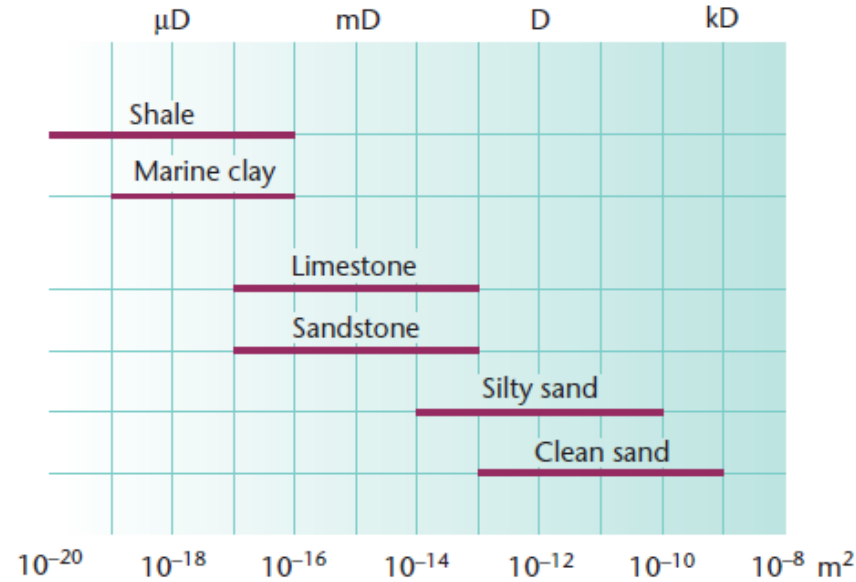

# Sediments of the European basins

## Depth of the basement

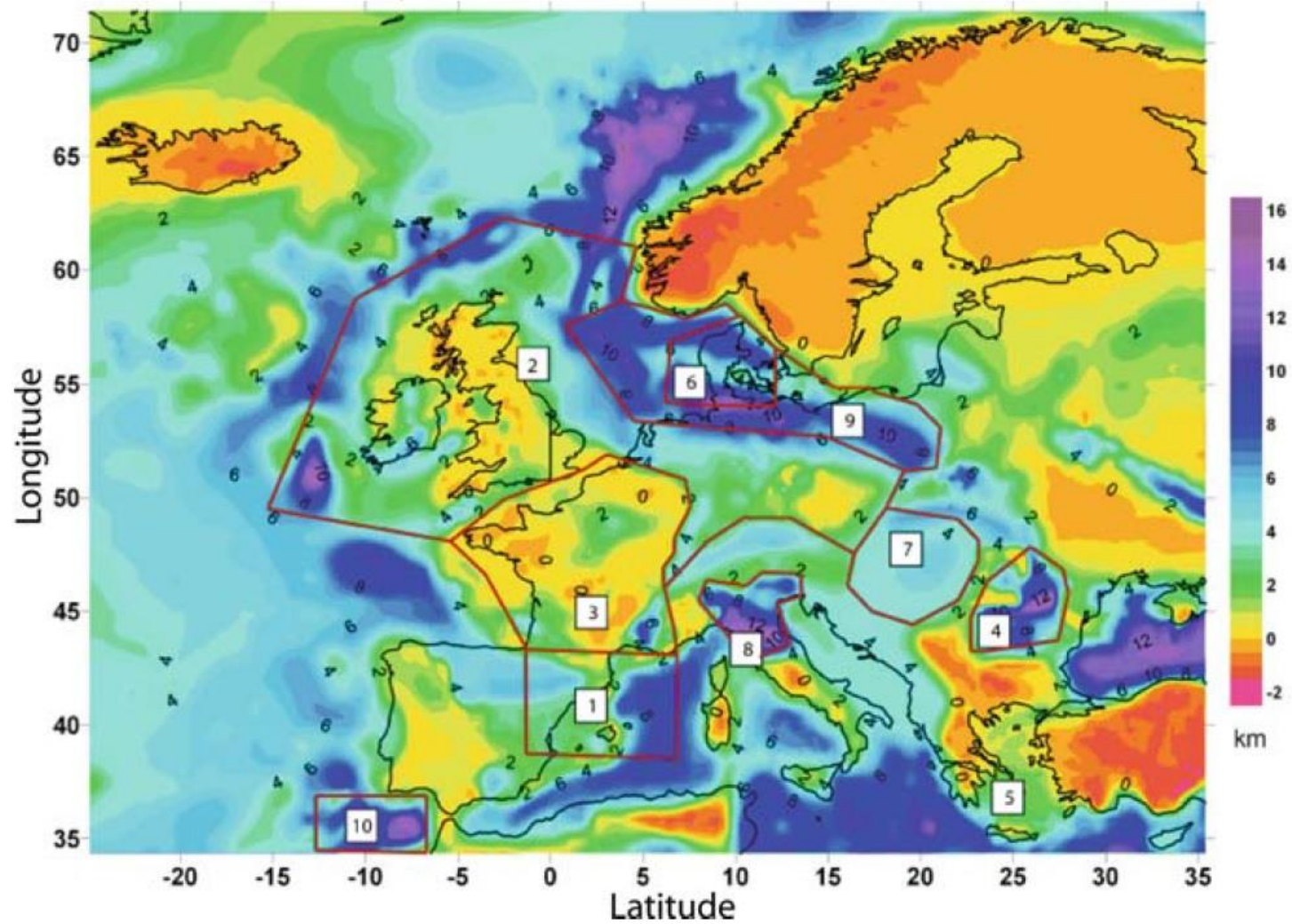



# Sediments of the European basins

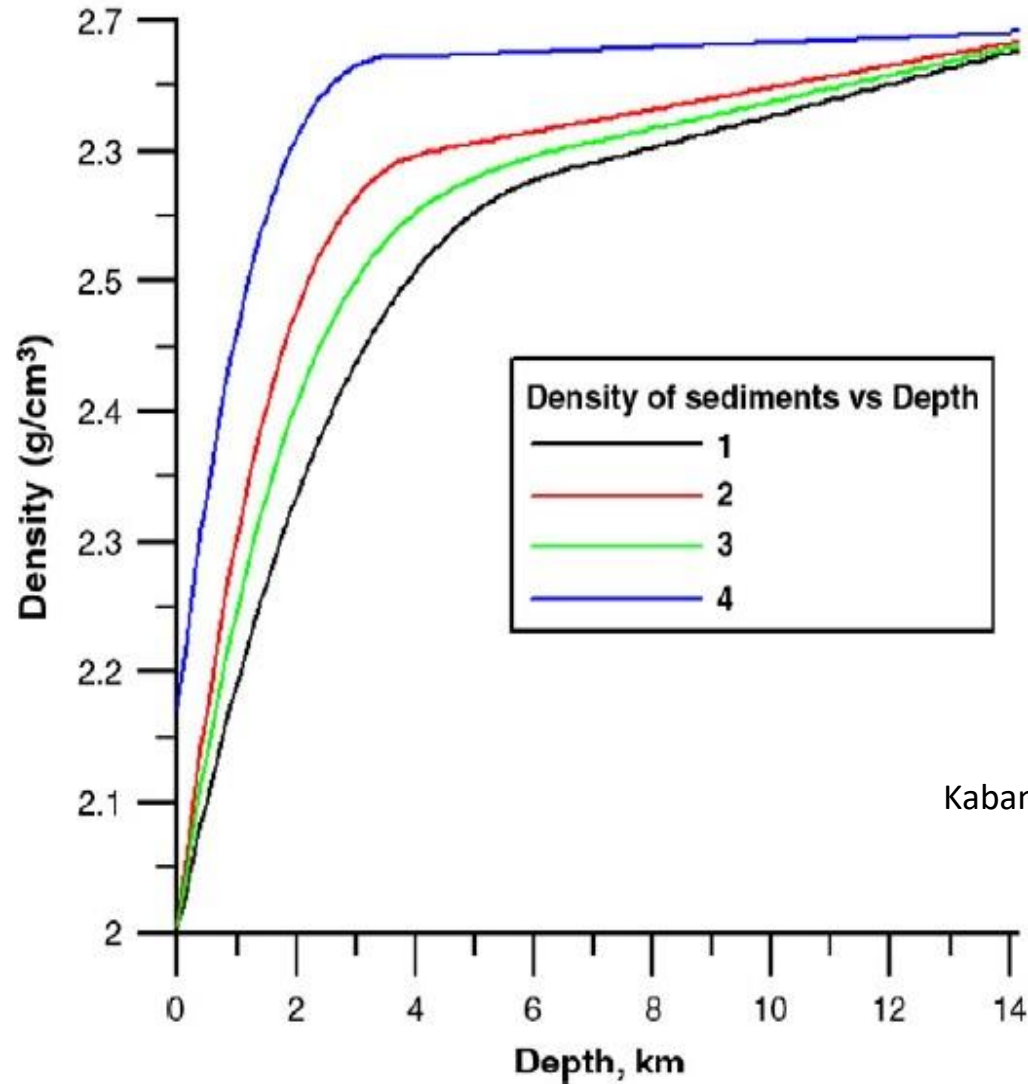

Kaban et al. (2010), EPSL, 296

1. basins of Iberia, 2. Central European basins, 3. Pannonian basin, 4. marine deposits

Geological feature	Age	Mean density (g/cm <sup>3</sup> )	<sup>a</sup> Max thickness (km)
Central European Basin System	Paleozoic–Tertiary	2.40–2.45	10
Møre and Vøring Margin	Pre-Cretaceous–Quaternary	2.45–2.50	15
Lofoten Margin	Pre-Cretaceous–Quaternary	2.40–2.45	8
Upper Rhine Graben	Late Paleozoic–Quaternary	2.45	4
Cantabrian–Pyrenees	Mesozoic–Tertiary	2.50–2.55	5
Aquitaine Basin	Mesozoic–Tertiary	2.45–2.50	10
Duero Basin	Mesozoic–Tertiary	2.50–2.55	6
Ebro and Tajo Basin	Mesozoic–Tertiary	2.50–2.55	6
Balearic Sea	Tertiary–Quaternary	2.35	5
Gulf of Cadiz	Tertiary–Quaternary	2.30–2.35	4
Bay of Biscay	Mesozoic–Quaternary	2.25–2.35	2
Iberian Abyssal Plain	Tertiary–Quaternary	2.10–2.20	2
Provençal–Corsica margin	Tertiary–Quaternary	2.30	5
Gulf of Lyon	Tertiary–Quaternary	2.20–2.25	2
Tyrrhenian Sea	Tertiary–Quaternary	2.25–2.30	5
Ionian Sea	Mesozoic–Quaternary	2.30–2.35	6
Eastern Mediterranean Sea	Tertiary–Quaternary	2.35	8
Aegean Sea	Tertiary–Quaternary	2.05–2.15	2
Po Plain	Tertiary–Quaternary	2.45–2.50	15
Molasse Basin	Tertiary–Quaternary	2.45	6
Adriatic Sea	Mesozoic–Quaternary	2.25–2.30	4
Ligurian Sea	Tertiary–Quaternary	2.30–2.35	5
South Rockall Basin	Late Paleozoic–Quaternary	2.30–2.35	5
Lousy and Rosemary Bank	Mesozoic–Quaternary	2.25–2.30	2
North Rockall Basin	Mesozoic–Quaternary	2.30–2.35	6
Iceland–Faeroe Ridge	Mesozoic–Quaternary	2.20–2.25	2
Porcupine Basin	Mesozoic–Quaternary	2.45–2.50	12
Edoras Bank	Mesozoic–Quaternary	2.20–2.25	2
Hatton Basin	Mesozoic–Quaternary	2.30	4
Focşani Basin	Late Mesozoic–Quaternary	2.45–2.50	16
Transylvania Basin	Paleozoic–Quaternary	2.25	5
Foredeep Carpathians	Tertiary–Quaternary	2.45–2.50	7
Pannonian Basin	Mesozoic–Quaternary	2.35–2.40	5
Black Sea	Mesozoic–Quaternary	2.45–2.50	12
Dnieper–Donets Rift	Paleozoic–Quaternary	2.40–2.50	10
Russian Rift	Paleozoic–Quaternary	2.40–2.45	3

# Thermal conductivity of sediments

Bulk thermal conductivity of sediments depends on the mineralogy of the framework grains, type and amount of material in the matrix, and porosity (increases with decreasing porosity) and fluid content. It ranges between  $1.5 \text{ Wm}^{-1} \text{ K}^{-1}$  (shales) and  $4.5 \text{ Wm}^{-1} \text{ K}^{-1}$  (sandstones).

(a) SANDSTONES WITH VARIABLE CLAY CONTENTS

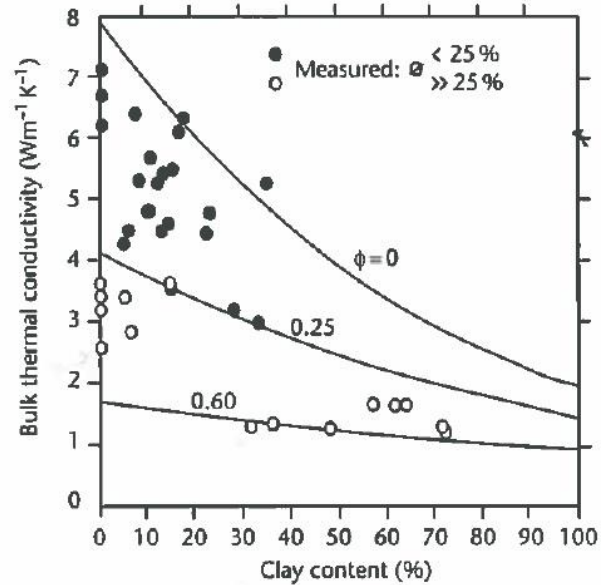

(b)

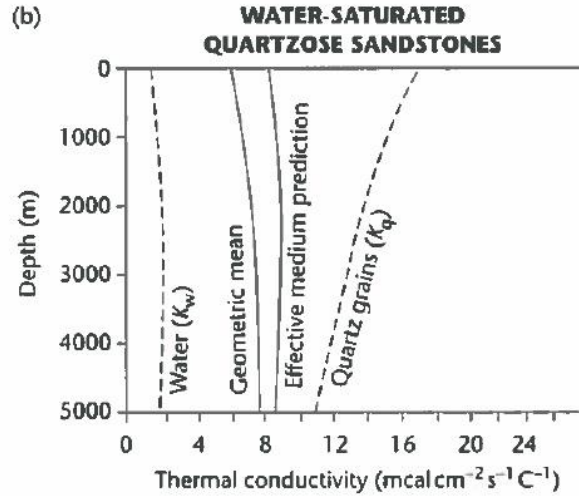

(c)

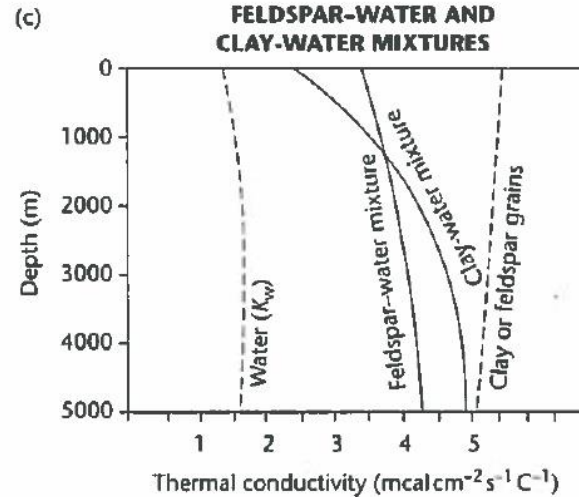

$$K_{\text{bulk}} = K_s^{(1-\phi)} K_w \phi$$

$K_s$  and  $K_w$  = thermal conductivities of sediments grains and water

$\phi$  = porosity (filled with water)



# Heat Generation of sediments

Heat generation of sediments changes with lithology: lowest in evaporites and carbonates, low to medium in sandstones, higher in shales and silstones, and very high in black shales.

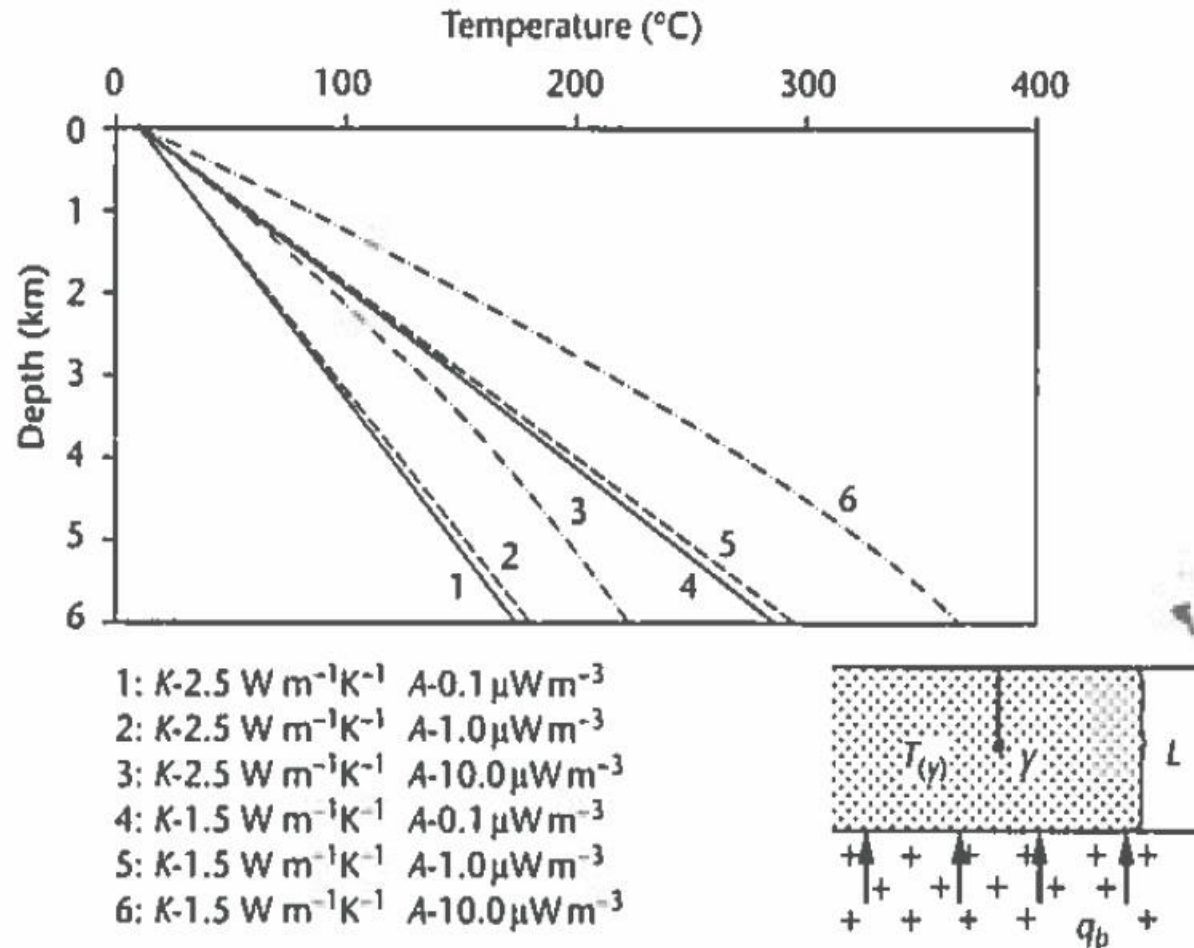

$$q_b = 70 \text{ mW m}^{-2}$$

# Temperature in sedimentary basins (transient effects)

Transient effects are due to: (1) advective flow of heat through regional aquifers: low surface heat flow at regions of recharge and high surface heat flow at regions of discharge (2) blanketing effects of sediments.

## Blanketing effect of sediments

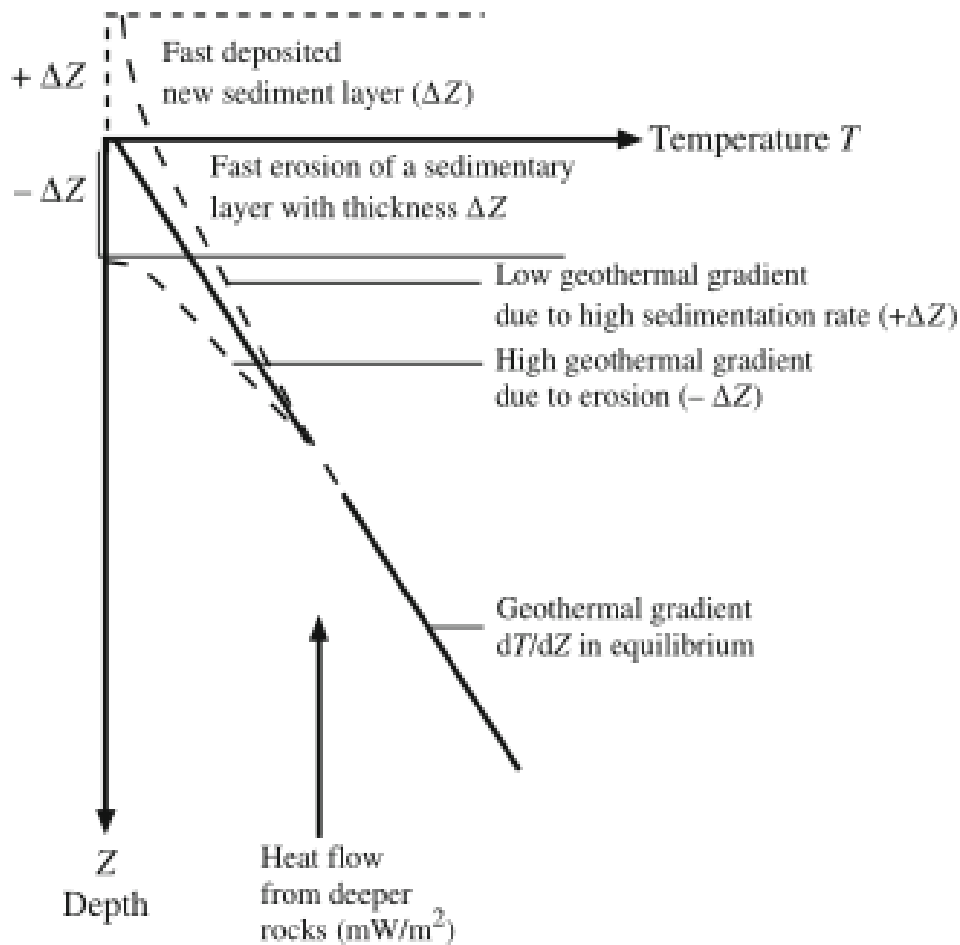

Departure from the steady-state thermal conditions (transient effects) depends on:

- (i) Deposition rate, transient effects if  $> 0.1$  mm/yr (thermal response of instantaneous deposition of 1km of sediments is  $> 1$ Myr).
- (ii) Thermal conductivity of sediments (highly porous, uncompacted marine shales act as strong insulators).

Deposition of sediments produce:

- 1) A transient cooling and reduction in the surface heat flow.
- 2) A possible long-term warming, depending on the thermal conductivity and internal heat generation.

# Subsidence in the sedimentary basins

**Accommodation space** = a space generally between the water level (sea, lake, river...) and the base of the water column (continental sediments non considered here)

Because of isostatic reasons, the normal position of the top of the crust is at sea level.

This means that if we do not push it down, we cannot dump sediments and we cannot get sedimentary basins. You need to have subsidence.

- *Total* subsidence is the total amount of vertical change of the former surface.
- The *rate* of downward motion of the former surface is called the subsidence *rate*.
- The *tectonic* subsidence is only the component of total subsidence that is caused by tectonic mechanisms.
- In isostatically compensated basins, sedimentary loading of tectonically formed basins will cause additional subsidence, which in turn makes room for additional sediment loads.
- In order to interpret the tectonic processes that lead to sedimentary basin formation, it is then necessary to subtract the influence of sedimentary loading from the total subsidence to determine the tectonic contribution to subsidence.

**What are the processes causing subsidence?**

A) Vertical loads

B) Horizontal loads

# Basin Subsidence Mechanisms

The subsidence of the sedimentary basins is caused by one or more of the following three processes, which may be intimately related:

- **Isostatic subsidence:** it is caused by physical changes in the thickness of the lithosphere (e.g., if physical stretching of the lithosphere causes thinning, then isostatic compensation will generally lead to subsidence).
- **Flexural subsidence:** It relies on elastic bending of the lithosphere. Then, if the lithosphere is loaded, it bends and a basin forms near the load. For very strong plates, such basins are wide and shallow, while for less competent plates such basins are narrow and deep.
- **Thermal subsidence:** It occurs if the density structure of the lithosphere is thermally changed by cooling (after that the lithosphere was heated). Thus, thermal subsidence is also a type of isostatic subsidence, except that the thickness change is caused thermally and not mechanically. Everything else being equal, the amount of thermal subsidence during cooling is exactly as large as the amount of thermal uplift during the heating phase.

# Sedimentary Basin Types

## ***Passive margins and rift basins:***

- Rift basins (e.g., Red Sea, East African Rift, Upper Rhine Graben) form as the consequence of continental extension and ultimately rifting. The extensional process during the formation of rift basins may be symmetrical or asymmetrical about the rift axis.
- The subsidence associated with the isostatic compensation of the rifting (called '*rift phase*') during which the sedimentation is rapid and highly energetic is usually followed by a later phase of thermal subsidence (called '*post-rift phase*') during which the mechanically rifted mantle lithosphere thickens by cooling and the sedimentation is slow and static.

## ***Transform basins:***

- Transform- or pull-apart basins (e.g., Vienna basin and intramontane basins within the European Alps) form as consequence of continental extension, but they are smaller than rift basins, since their extensional phase terminated much earlier (they never get to a rifting stage).
- They are bound on at least two sides by strike slip faults and they are usually rectangular or diamond shaped.
- Thermal thinning of the mantle lithosphere is limited (they lack of post-rift phases) and thus subsidence of transform basins is usually short-lived and is largely a linear function of time.

## ***Foreland basins (on continental lithosphere):***

- Foreland basins form during the collision of two continental plates, due to the elastic flexure of the plate in response to the loading by external and internal loads and are the continental analogue to fore-arc and back-arc basins.
- According to their location relative to the lower plate, foreland basins may be divided in: *Peripheral foreland basins* (e.g., molasses basins near the Alps), forming near subduction zones in collisional environments as a consequence of loading of the lower plate by the upper plate and *Retroarc foreland basins* (e.g., basins east of the Andes), forming on the upper plate in the hinterland of a subduction zone.

## ***Fore-arc and Back-arc basins (on oceanic lithosphere):***

- Fore-arc-basins form in front of an island arc. Models of their formation include: **1.** Subduction of an oceanic plate underneath another leads to a doubling of the plate thickness, leading to subsidence. **2.** Subduction of a cold plate underneath a hot plate may cause cooling of the upper plate, leading to thermal subsidence. **3.** Loading of the plate from above by an island arc and from below by the buoyancy of the accretionary wedge may lead to elastic back-bending of the plate.
- Back-arc-basins form behind a subduction zone, usually as a consequence of upwelling asthenospheric material in the mantle wedge.

## ***Intracratonic basins:***

- Intracratonic basins are large sedimentary basins (area of millions km<sup>2</sup>), characterized by slow subsidence rate (30 m Myr<sup>-1</sup>), as a consequence of thermal subsidence or other mechanisms.

# Tectonic subsidence curves

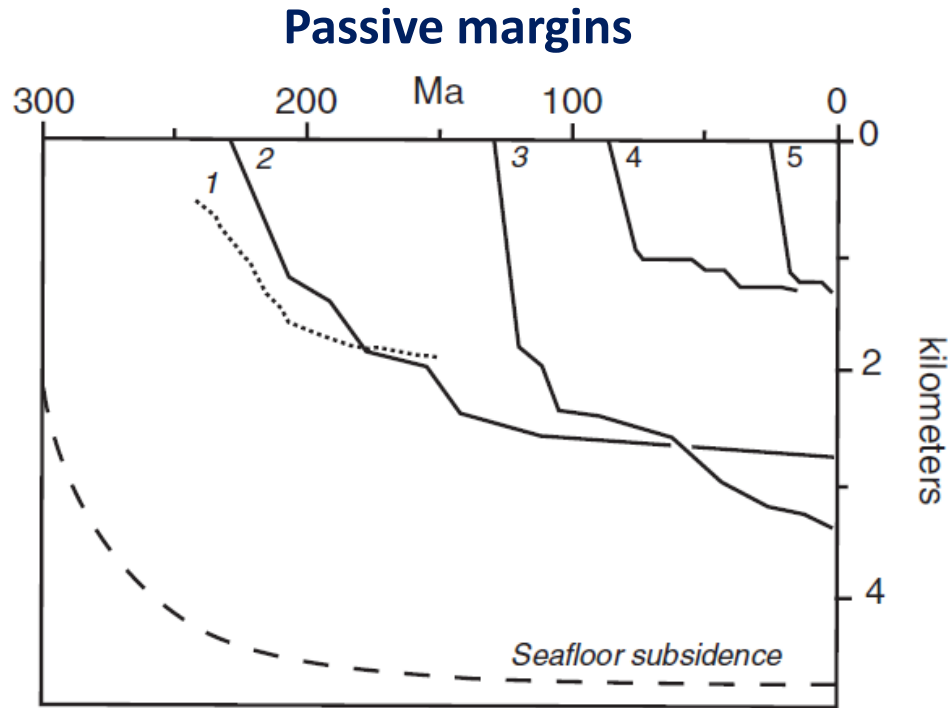

1—Paleozoic Miogeocline, southern Canadian Rocky Mountains (Bond and Kominz, 1984); 2—Moroccan Basin (Ellouz et al., 2003); 3—Campos Basin (Mohriak et al., 1987); 4—Gippsland Basin (Falvey and Mutter, 1981; P. Yin, 1985, personal commun.); 5—Gulf of Lion (Benedicto et al., 1996).

**Duration:** 10-100 Myr

**Subsidence rates (syn-rift):** < 0.2 mm/yr

**Subsidence rates (post-rift):** < 0.05 mm/yr

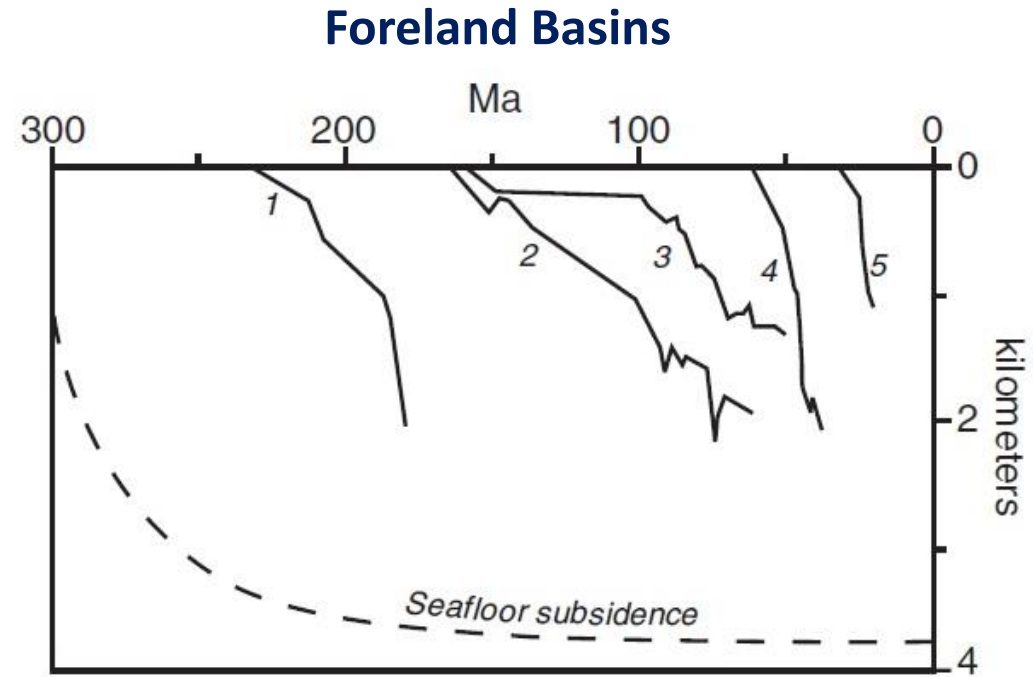

1—Eastern Avalonia, Anglo-Brabant fold belts (van Grootel et al., 1997); 2—Southern Alberta Basin (Gillespie and Heller, 1995); 3—San Rafael Swell, Utah (Heller et al., 1986); 4—Pyrenean foreland basin, Gombren (Vergés et al., 1998); 5—Swiss Molasse basin (Burkhard and Sommaruga, 1998).

**Duration:** 20-40 Myr (Pro-foreland basin ) 40-80 Myr (Retro-foreland)

**Subsidence rates:** 0.2-0.5 mm/yr (Pro-foreland) <0.05 mm/yr (Retro-foreland)



# Tectonic subsidence curves

## Intracratonic Basins

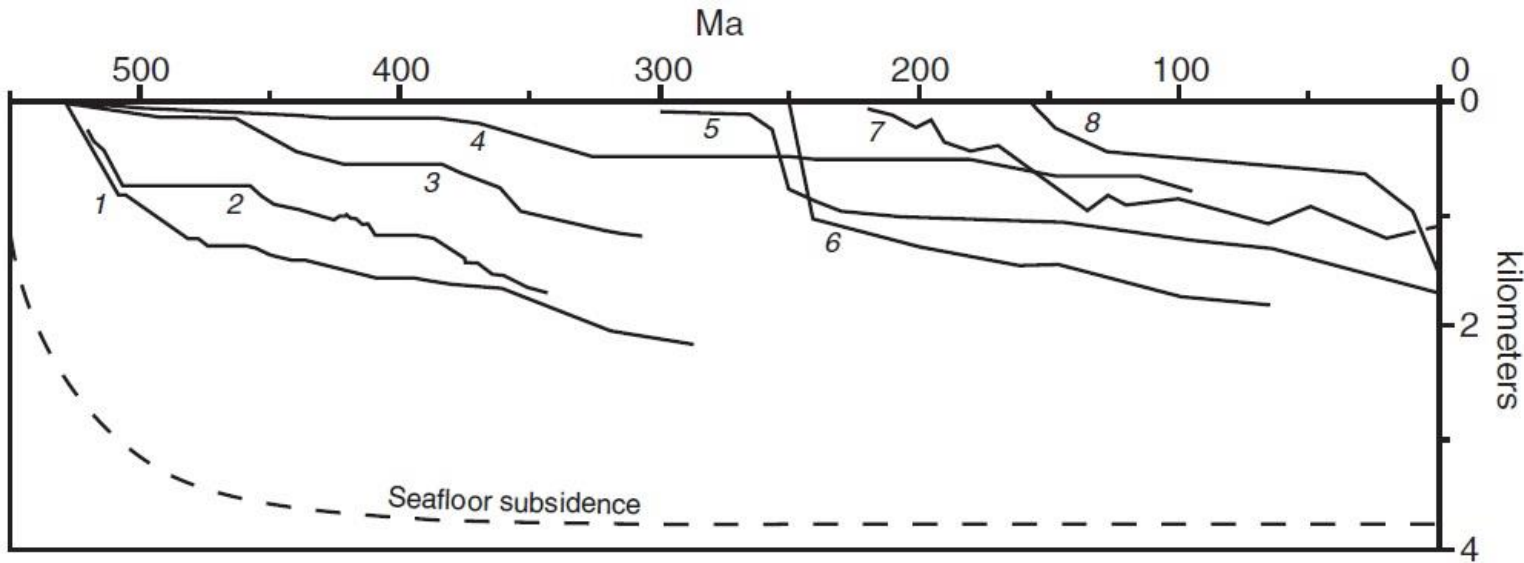

1—Illinois Basin, Farley well (Bond and Kominz, 1984); 2—Michigan Basin (Bond and Kominz, 1984); 3—Williston Basin, North Dakota (Bond and Kominz, 1984); 4—Williston Basin, Saskatchewan (Fowler and Nisbet, 1985); 5—Northeast German Basin (Scheck and Bayer, 1999); 6—Southwest Ordos Basin (Xie, 2007); 7—Paris Basin (Prijac et al., 2000); 8—Parana Basin (Zalan et al., 1990).

**Duration:** >100 Myr

**Subsidence rates :** 0.01-0.04 mm/yr

**Thermal decay Constant  $\sim L^2$**

Xie and Heller, 2009, GSA

## Strike-slip basins

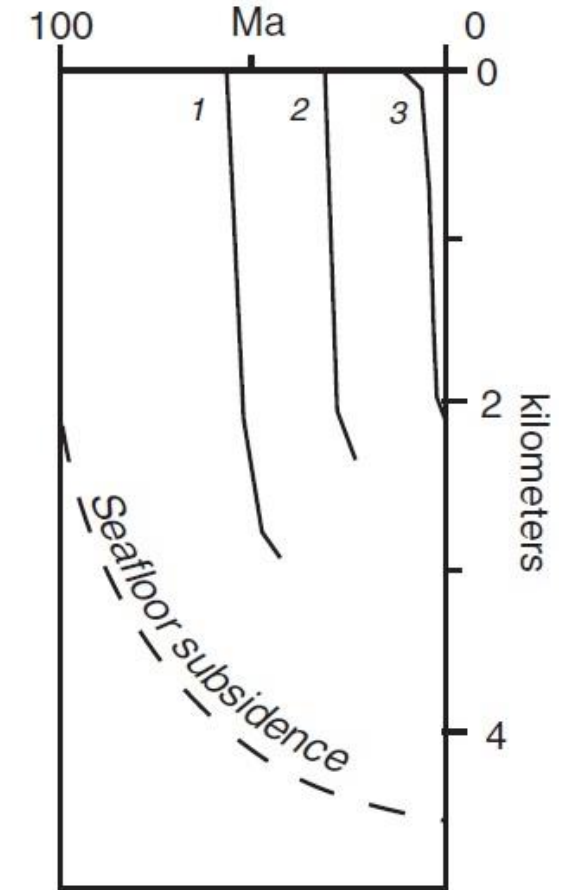

1—Chuckanut Basin (Johnson, 1984, 1985); 2—Ridge Basin (Crowell and Link, 1982; Karner and Dewey, 1986); 3—Death Valley (Hunt and Mabey, 1966).

**Duration:** 10 Myr

**Subsidence rates :** >0.5 mm/yr

# Basins of the rift-drift suite

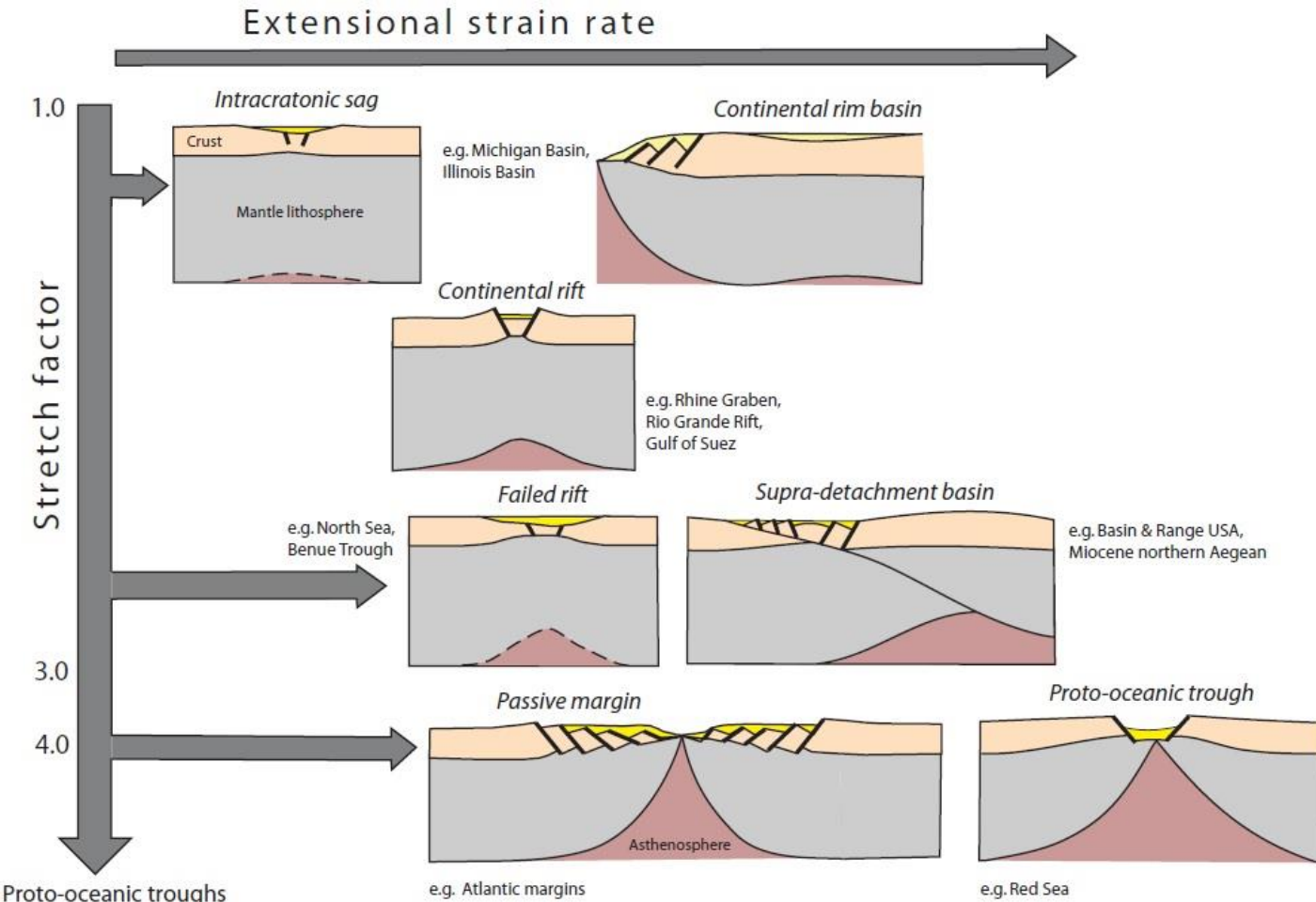

- *Cratonic basins:* lack evidence for widespread extensional faulting but experience long-lived sag-type subsidence.
- *Continental rim basins:* are located on essentially unstretched continental lithosphere and experience slow sag-type subsidence, coeval with the late syn-rift and drift phases of the adjacent passive margin.
- *Rifts:* are characterized by well-developed extensional faulting (narrow-slow, localised rifts, to wide-fast, diffuse extensional provinces and *Supradetachment Basins*).
- *Failed rifts:* occur where the brittle stretching stops before reaching a critical value necessary for the formation of an ocean basin, and subsequent subsidence takes place due to cooling.
- *Proto-oceanic troughs* occur where the stretching has rapidly attenuated the lithosphere to allow a new ocean basin to form (typical sediments: evaporites and black-organic-rich shales).
- *Passive margins* are dominated by broad regional subsidence due to cooling following complete attenuation of the continental lithosphere.

# Rim Basins

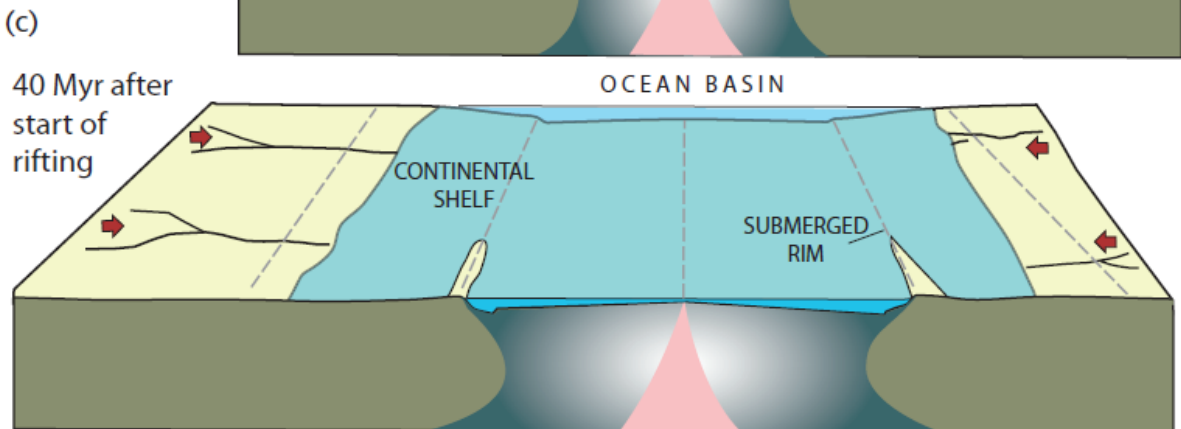
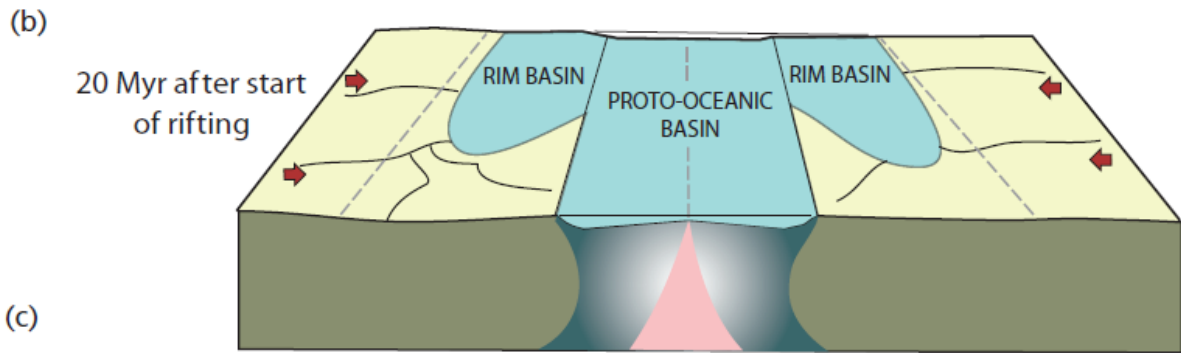
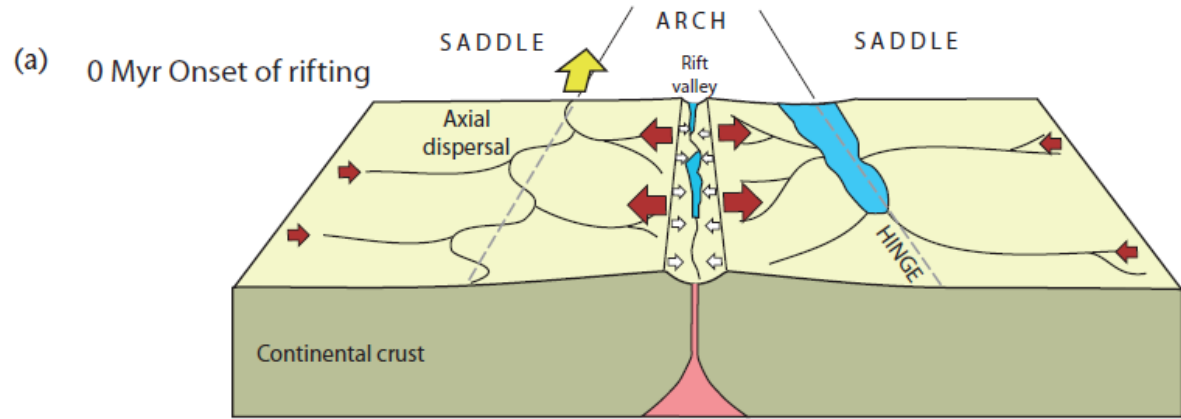

- Rim basins evolve over unstretched to slightly stretched continental lithosphere at the same time as passive margin development, their subsidence rates are low, their continental basement is typified by minimal amounts of brittle faulting, and magmatism is absent.
- The broad sag-type subsidence is suggested to be due to cooling following plume activity driving continental rifting, as well as thermal relaxation of upwelled asthenosphere.

# Basins of the rift-drift suite

Extensional basins differentiated according to their extension, total extension rate, and the dip of the master faults

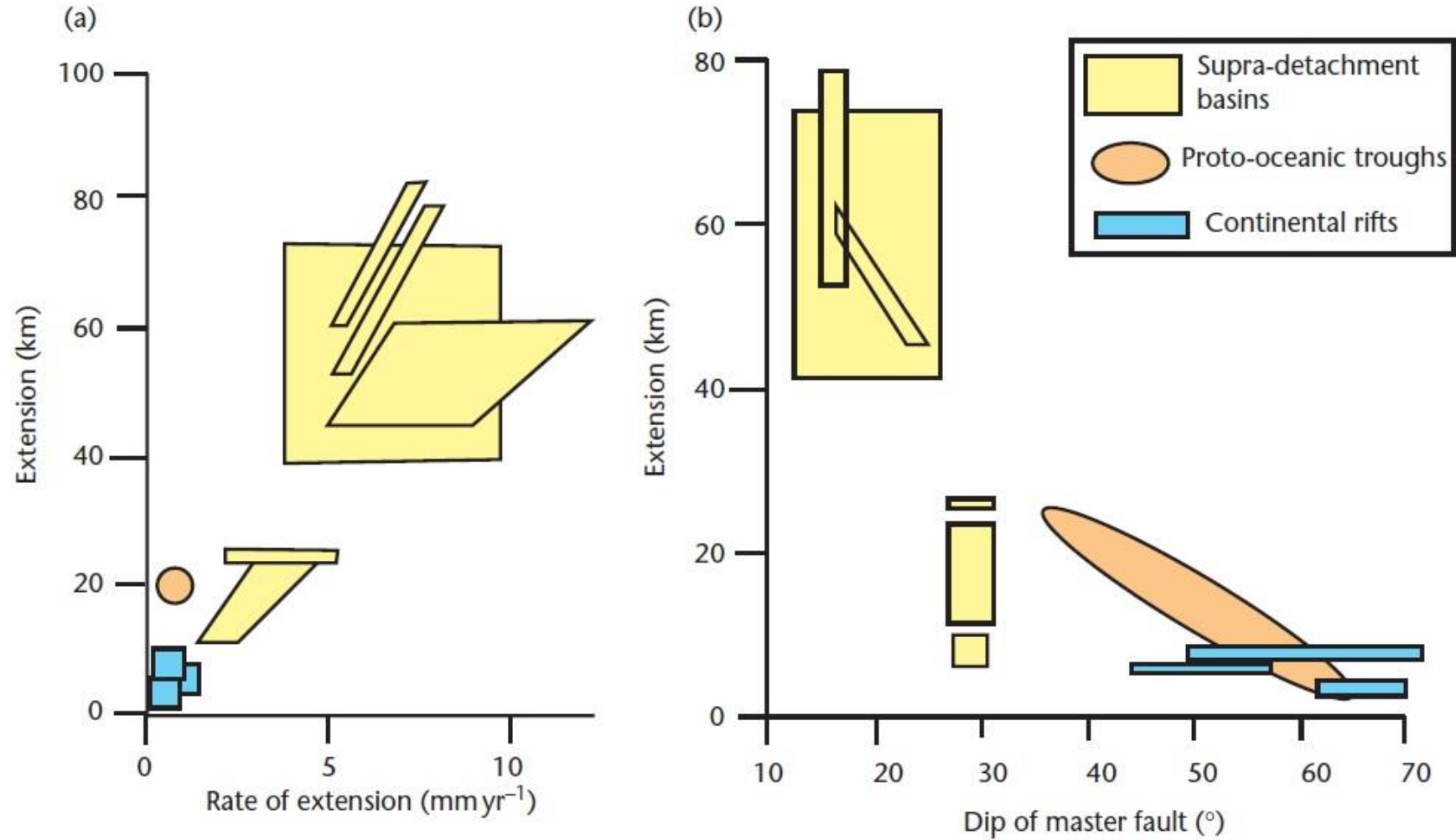

# Main characteristics of rift basins

## Lithospheric extension results in the formation of grabens, rift basins, and passive margins

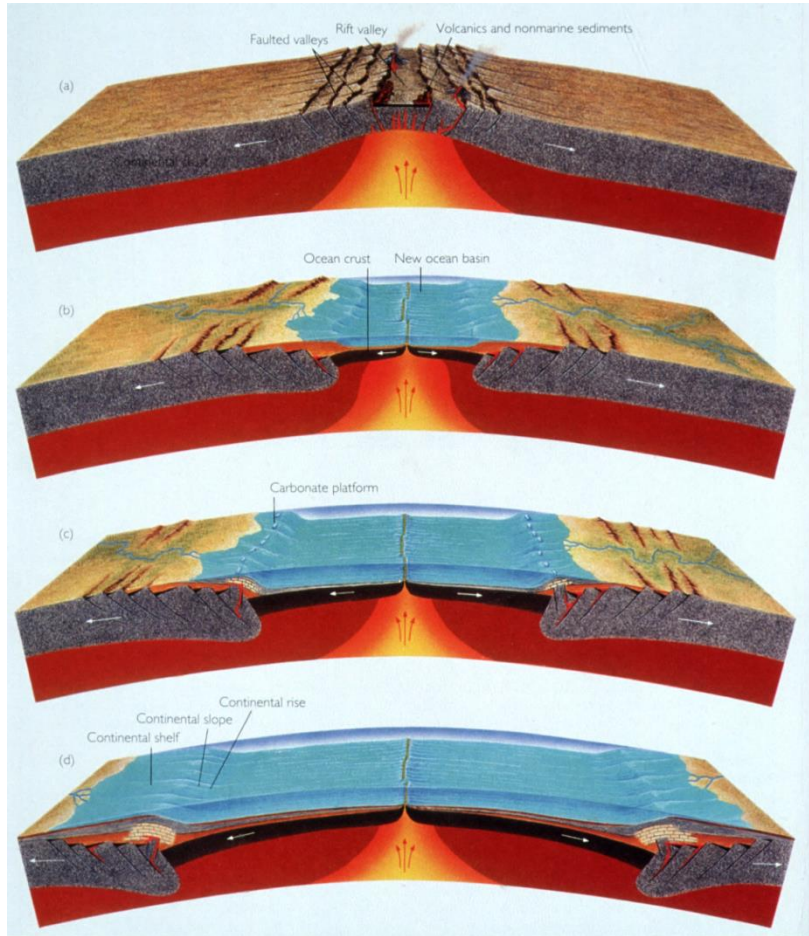

- Rifts are regions of extensional deformation, where the entire lithosphere has deformed under deviatoric tension.
- Extension may lead to lithospheric rupture and formation of a new oceanic basin and a rifted continental margin or aborted rifts (alauco gens).
- High surface heat flow ( $90-110 \text{ mWm}^{-2}$ ).
- High level of earthquake activity mainly concentrate in the crust ( $< 30 \text{ km}$ ) and  $M_w < 6$ .
- Moho elevated (e.g., Upper Rhine Gaben).
- Crust and mantle lithosphere moderately or largely thinned
- Normal dip-slip faults and strike-slip faults.
- Rift zones have typically a long-wavelength Bouguer gravity low (mass deficit) with sometimes a secondary high (mass excess) located in the centre of the rift zone.



# Surface Heat Flow in Continental Rifts

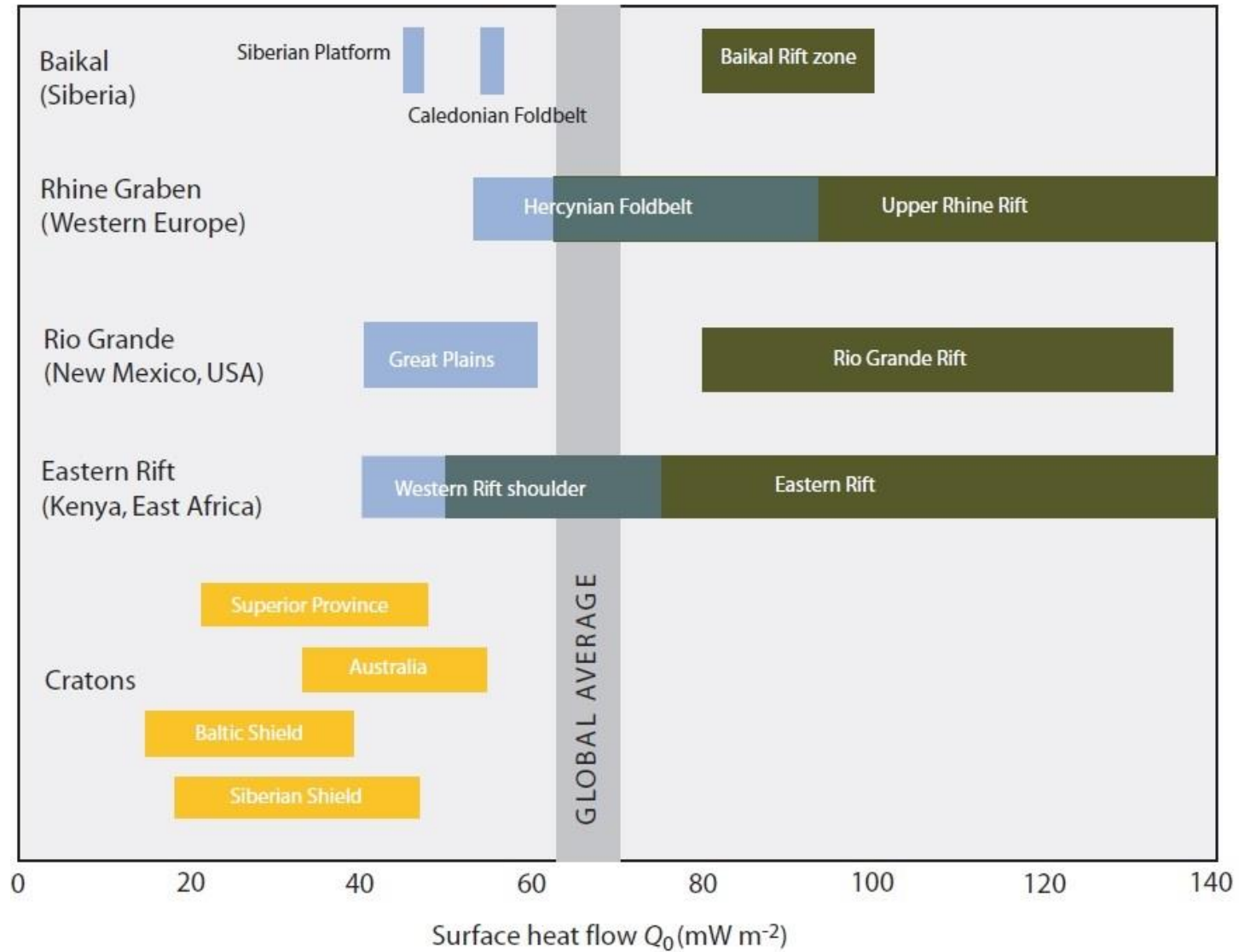



# Thermal subsidence effects as a consequence of extension

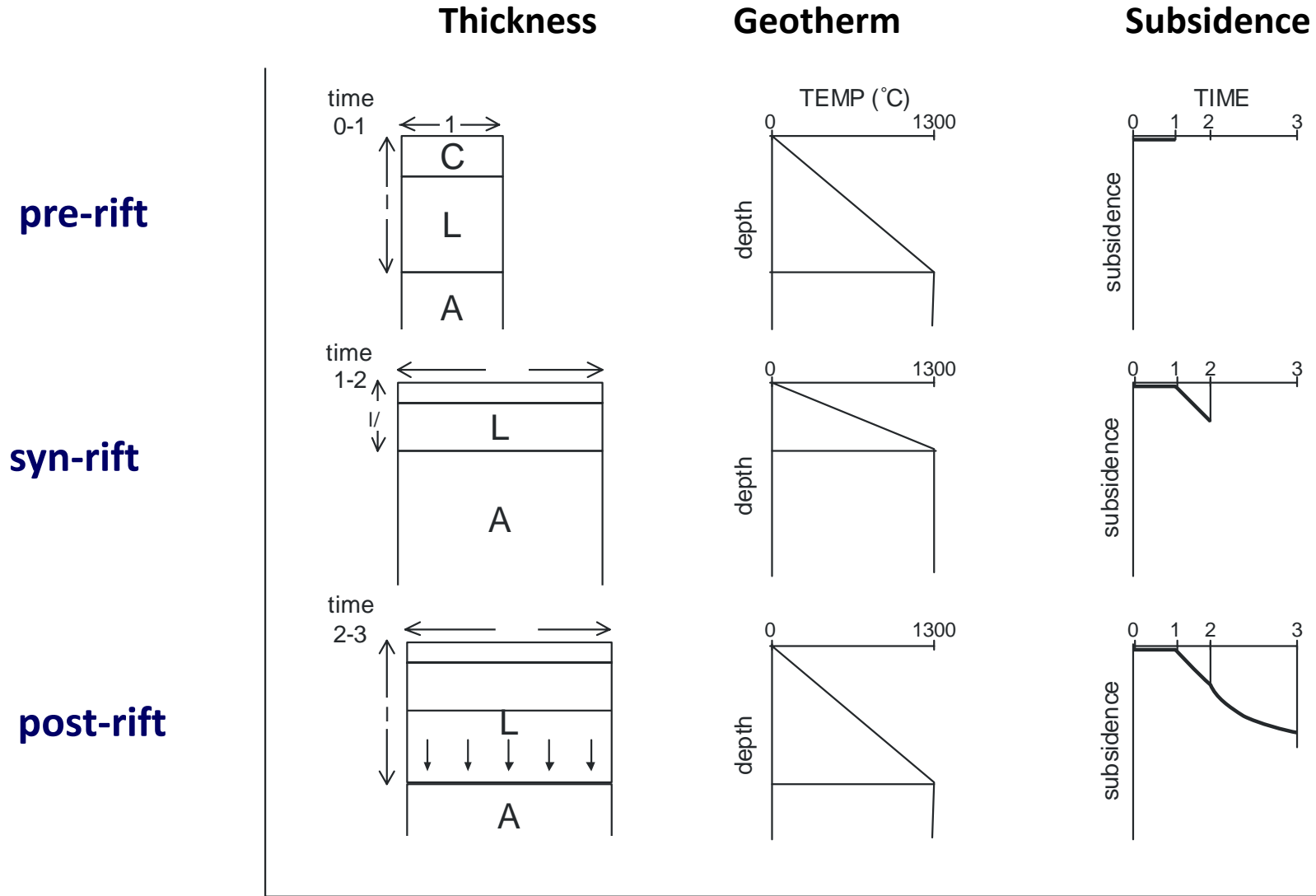

# Rift Basins Formation and Types

## Case A: Active Rifting

It develops in response to mantle upwelling (impingement on the base of the lithosphere of a thermal plume, as in the East African Rift).

## Case B: Passive rifting

It develops in response to lithospheric extension driven by far-field stress (e.g., Basin and Range). Volcanic activity and crustal doming are secondary process, which may follow but not precede it.

## Old classification, still valid?

- A rift can become tectonically inactive at all stages of its evolution if lithospheric extension ends.
- Extrusion of large volumes of subalkaline tholeiites must be related to a mantle thermal anomaly.

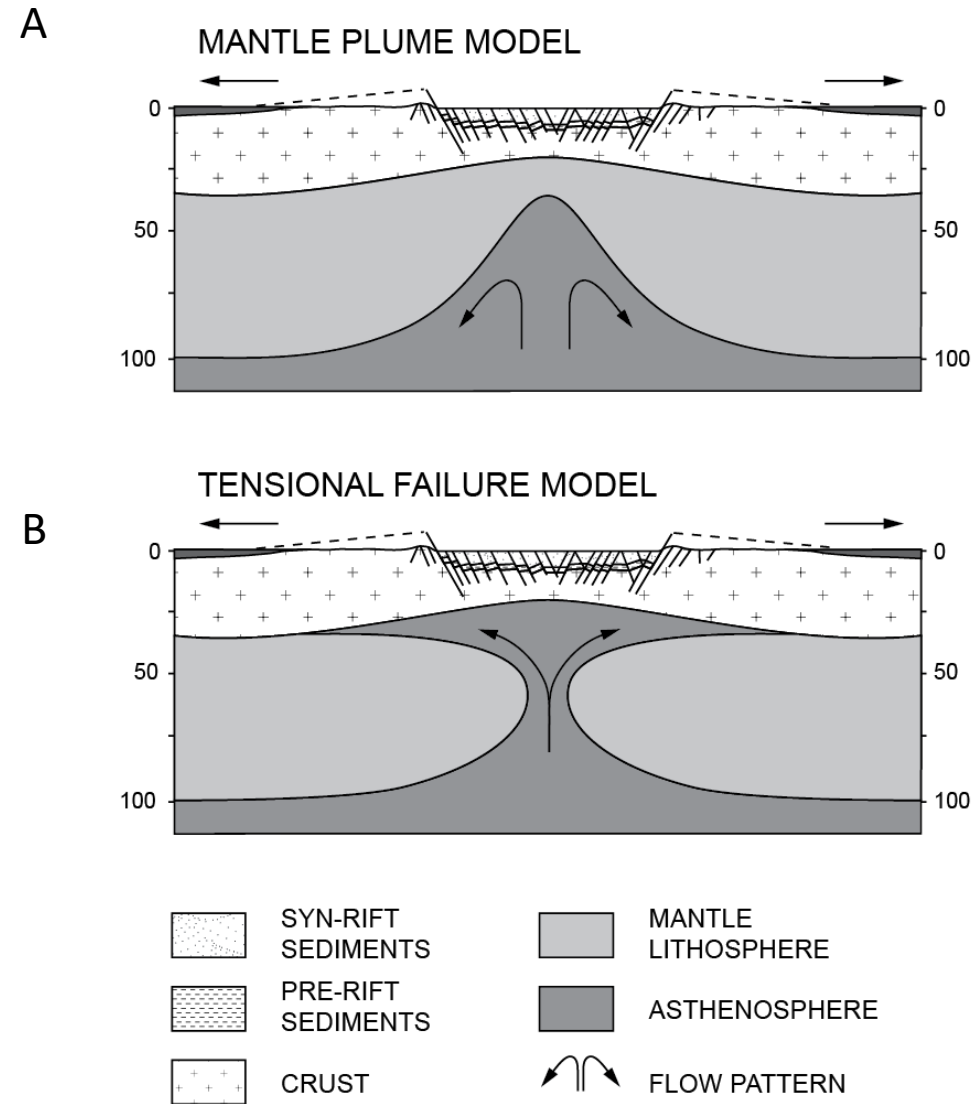

Many rifts start with an initial “passive” phase and evolve in a more “active” stage when magmatic processes increase

# Rift Basins formation and types

Rifting activity is governed by plate boundary forces: slab pull, slab roll-back, ridge push, trench suction, basal drag (exerted if plate velocity and direction of movement differs from velocity and direction of mantle flow)

**Atlantic-type rifts:** it evolves during the break-up of major continental masses, likely related to reorganization of mantle convection system .

**Back-arc rifts:** they evolve in response to a decrease in convergence rates and/or even a temporary divergence of colliding plates. They can lead to the opening of small oceanic basins (e.g., Sea of Japan, Black Sea), but are prone to destruction when convergence rates increase again.

**In addition, to plate boundary forces, there is an additional set of buoyancy forces set up by crustal thickness contrasts:**

**Syn-orogenic rifts:** they evolve consequently to an indenter effects and ensuing escape tectonics or to lithospheric overthickening in orogenic belts, resulting in uplift and extension of its axial parts (e.g., European Cenozoic Rift System in the Alpine foreland and Baikal rift in the hinterland of Himalayas).

**Post-orogenic extension:** Extensional disruption of young orogenic belts is likely related to their post-orogenic uplift and the development of deviatoric tensional stresses inherent to orogenically overthickened crust (e.g., West Siberian Basin and Basin and Range province).

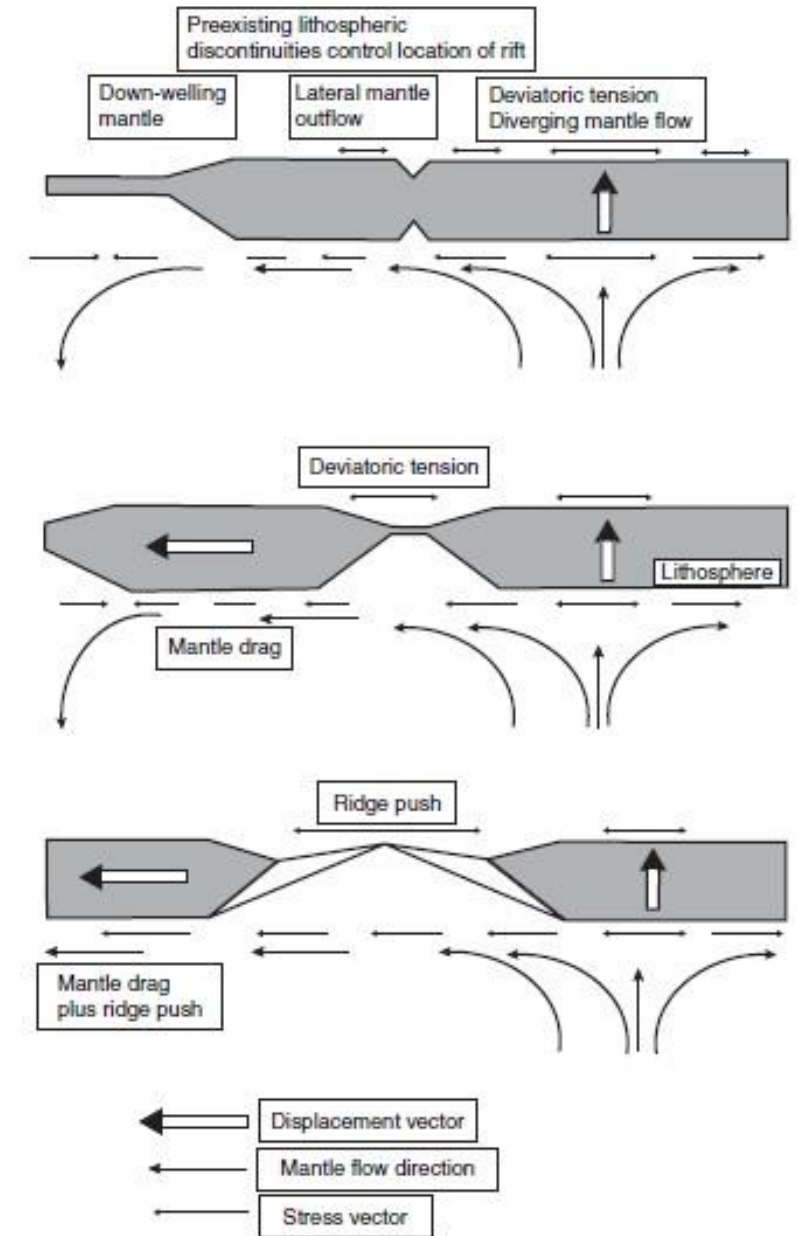

# Rift Basins Formation

## EXTENSIONAL BASINS

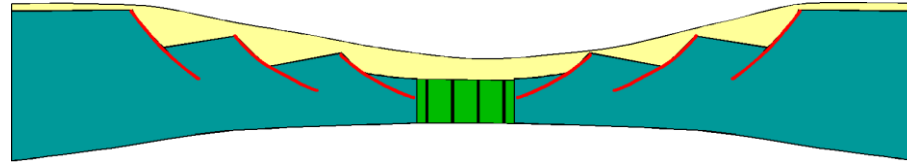

Two main time intervals

- **During rifting** normal faults develop. Accommodation space is created by two processes, A) the movement of fault blocks, B) the thinning of the crust and lithospheric mantle
- **Following rifting**, no faults are active. Accommodation space is created by the decay of the thermal anomaly present at the end of rifting

### Extension will end

- when the lithospheric plate is broken
- when extension at the plate boundaries ends

We enter the **post-rift or drifting stage**

- The system will cool down
- Subsidence will take place, with a magnitude depending on the available thermal anomaly

# Rift Basins Formation

## EXTENSION TECTONICS

If you stretch a body, this will **thin** and eventually **break**.

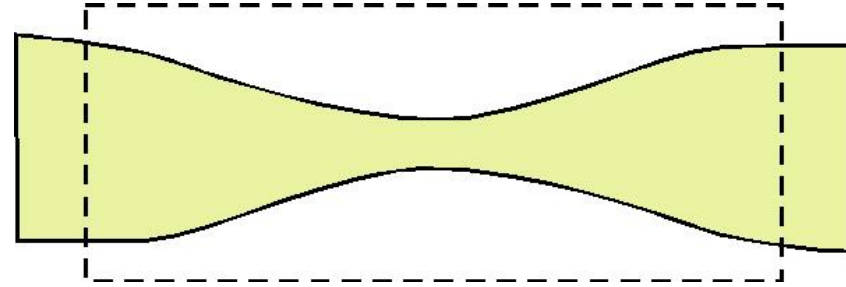

Because of their different rheological behaviour of the lithosphere at each moment some layers will be **broken (faults)** some others will be **thinned**

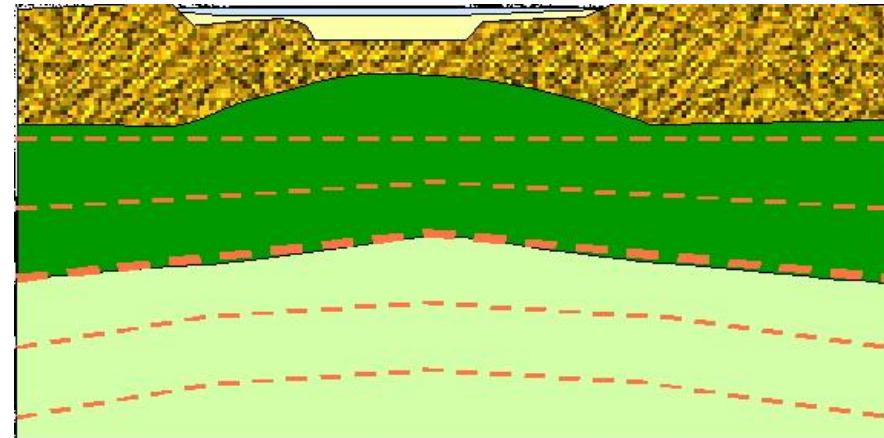
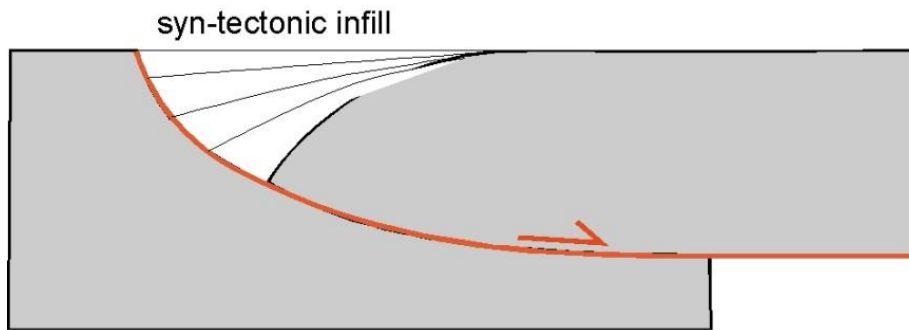

Depending on these factors, extension can create large or small basins

# Rift Basins Formation

## Some terminology issues

Forces/stresses	Dimension changes
Tension ( <i>rek</i> )	Extension (stretching)
Compression	Shortening contraction

2) The distinction between thinning and breaking (faulting) is very much **scale-dependent**

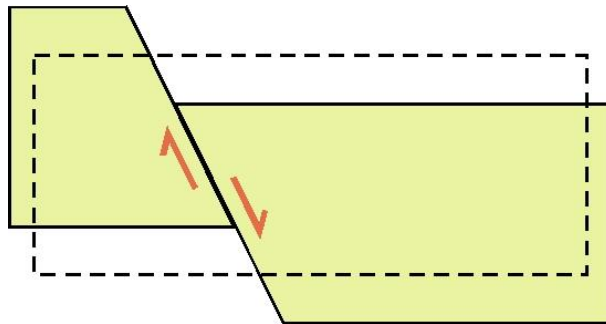

*Localized = discrete*

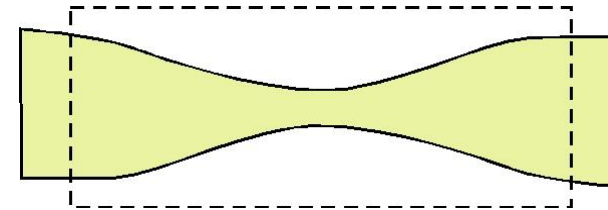

*Distributed = ductile*



# Rift Basins Formation

## Summary of lithosphere behaviour

- The lithosphere is composed of two main layers with different densities
- the Moho and the LAB are two fundamentally different boundaries. This means that the processes controlling changes in crustal and lithospheric thickness are also (partly) different

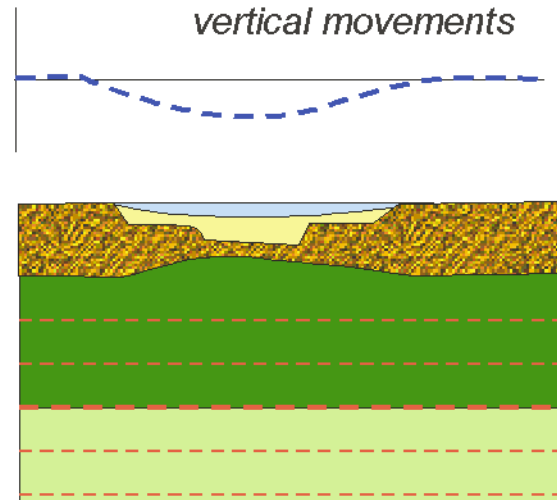
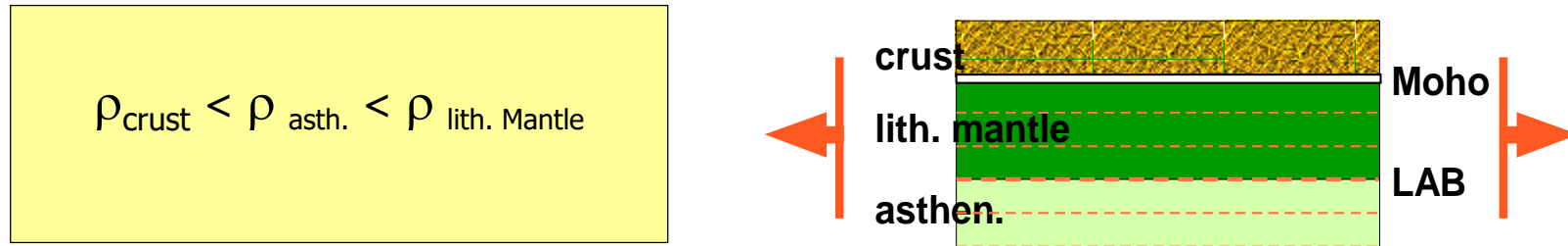

# Rift Basins Formation

## NORMAL FAULTS

A normal fault accommodates **extension**

The essential elements of a fault are the **fault plane** and the **displacement vector**

It is a **dip slip** fault because the displacement is presently parallel to the dip of the plane

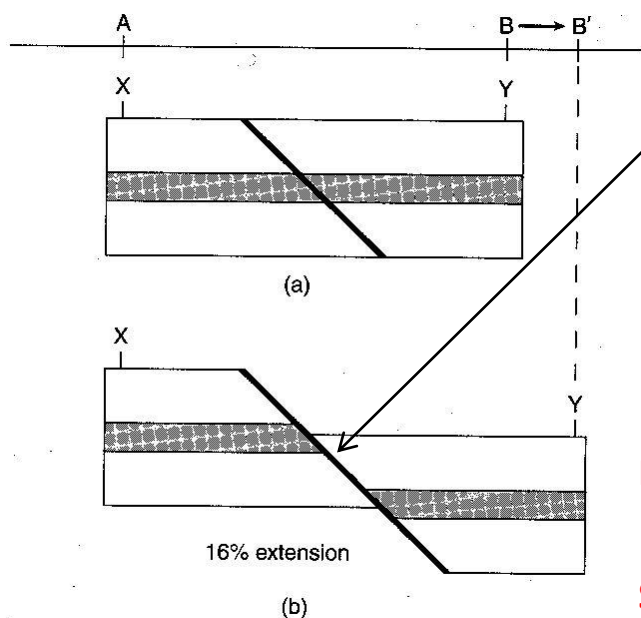
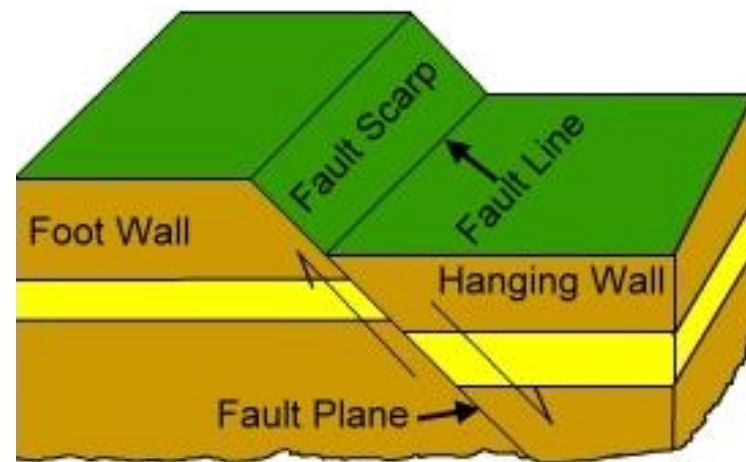

Normal faults can be **planar** or **listric**.  
Their symbol is

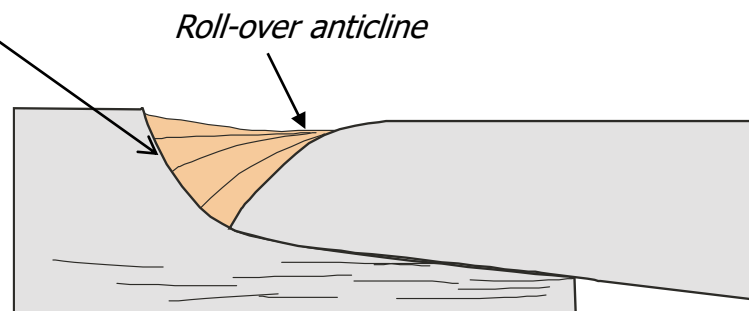

**Extension:**  $L_f - L_i$

**Strain** =  $\frac{L_f - L_i}{L_i}$

Stretching factor ( $\beta$  lithosphere/mantle lithosphere) =  $L_i/L_f$

Stretching factor ( $\delta$  crust) =  $C_i/C_f$

# Rift Basins Formation

## How to date the activity of a fault?

Faults are obviously younger than the rocks they affect; but can we say more?

One can try to date fault rocks or identify **pre-, syn- and post-tectonic sediments**

Basically two sets of criteria:

- **geometry** of layers and faults
- **sedimentology/stratigraphy**

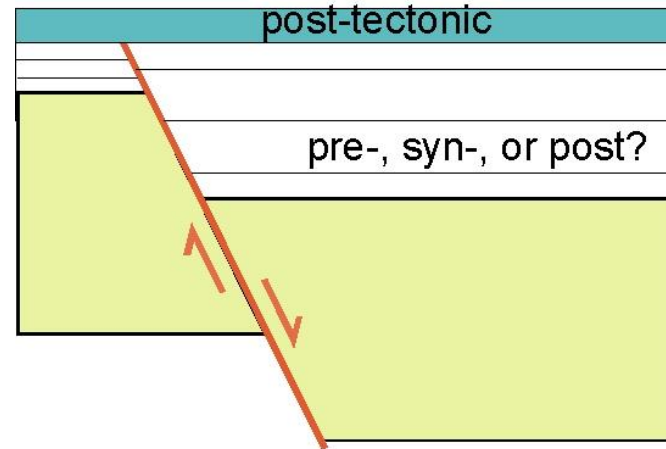

**Pre-tectonic** sediments are cut by the fault and show no variation (thickness or facies) across it

**Syn-tectonic** sediments are cut by the fault but do show significant variations

**Post-tectonic** sediments seal the fault and are not displaced/affected by them

# Rift Basins Formation

## Pre-rifting stage

Pre-tectonic layers are

- parallel to the basement top
- parallel to each other
- same kind of rocks on both sides of the fault

In the case of a listric normal fault

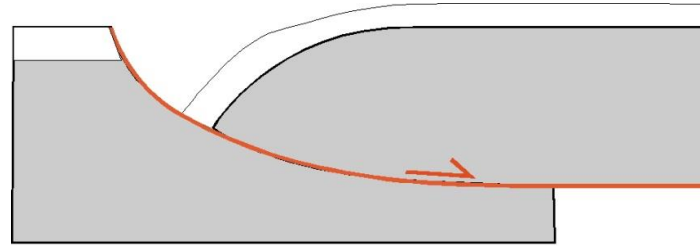

**SYN-TECTONIC** layers are cut by the fault and feel the activity of the fault (thickness and/or geometry and/or facies).

**POST-TECTONIC** layers are not rotated.

They adapt to the morphology existing at the end of deformation: they seal the faults if everything is flat, they can onlap the fault and or the block if this is not the case.

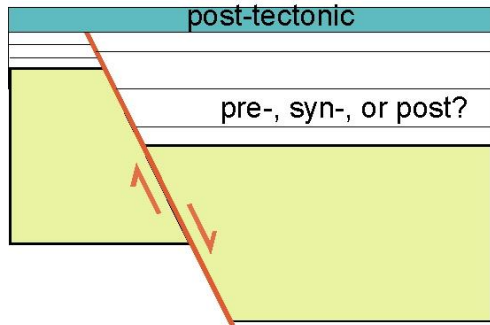

Sediments on the HW are thicker than those on the FW

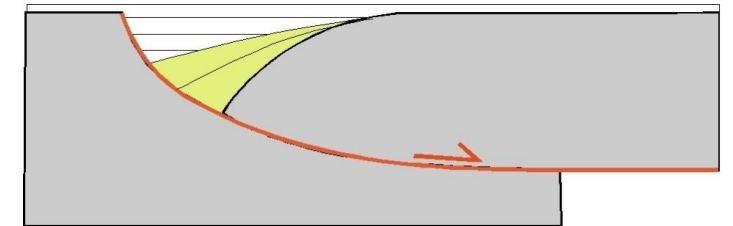
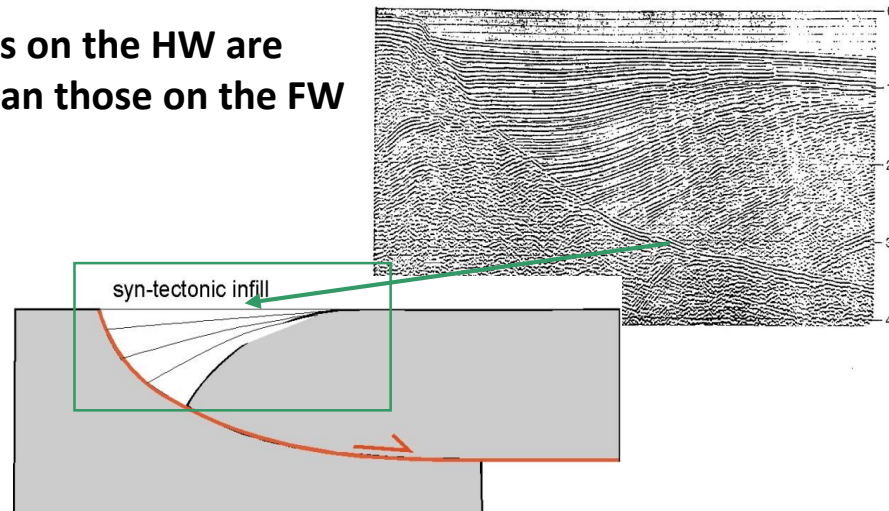

If the fault is rotational (for instance listric) layers have a **fan-like** arrangement

# Uniform Stretching Model (McKenzie, 1978)

- Stretching is instantaneous and uniform with depth (the base of the plate remains at the same  $T$  during the stretching and subsequent cooling)
- Stretching occurs by pure shear, is symmetrical (no solid body rotation occurs), which results in steepening of the thermal gradient.
- Initial fault-controlled subsidence depends on the initial ratio crustal/lithospheric thickness and amount of stretching  $\beta$ .
- Thermal subsidence depends on the amount of stretching alone.
- Necking depth (the depth in the lithosphere that remains horizontal during thinning if the effects of sediment and water loading are removed or the level of no vertical motions in the absence of isostatic force) is zero.
- Airy isostasy is assumed to operate during the syn-rift phase (no rigidity of the lithosphere).
- There is no radiogenic heat production and no magmatic activity.
- Asthenosphere has a uniform temperature at the base of the lithosphere.

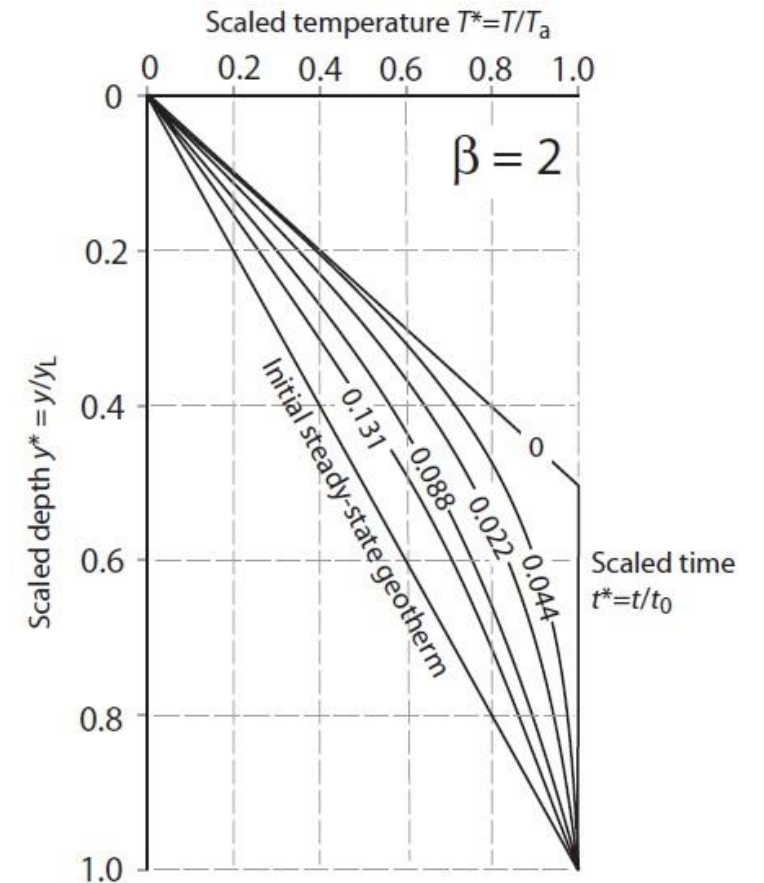
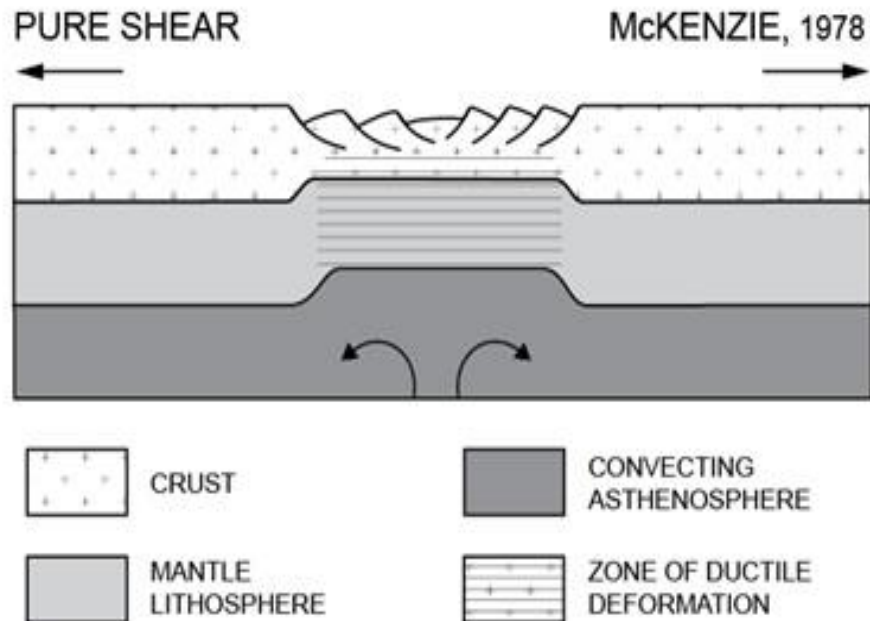

# Uniform Stretching Model (McKenzie, 1978)

1-D kinematic model for instantaneous, uniform extension of continental lithosphere:

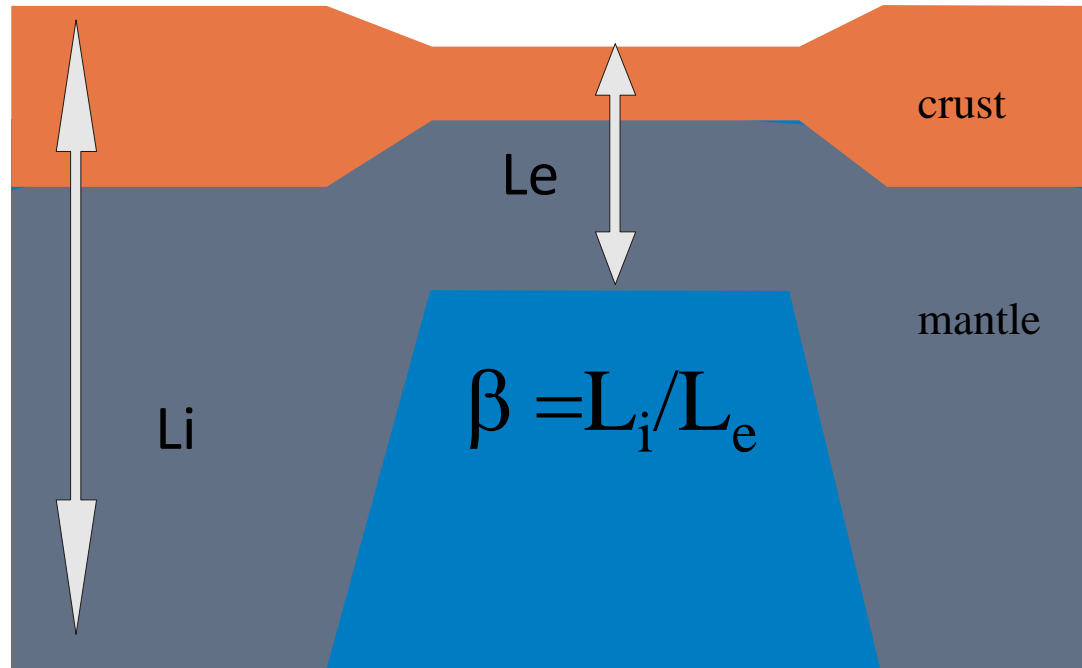

- High heat flow just after extension
- Crustal thinning
- Lithospheric thinning

$$1 \leq \beta \leq \infty$$

$\beta$  = stretching factor

- Syn-rift subsidence caused by isostasy is instantaneous
- Post-rift subsidence caused by cooling is gradual:  $t = L^2 / \kappa$

# Uniform Lithosphere Extension

Surface heat flow scaled by the surface heat flow prior to stretching/  
time scaled by the diffusive time constant of the lithosphere

The heat flow decreases exponentially with time after the cessation of rifting, and thus the dependency of the heat flow on  $\beta$  is insignificant.

Crustal thinning causes a reduction of the reduced heat flow (heat flow at the base of the crust)  $q_r$ :

$$q_r = 43.2e^{-0.39\beta}$$

Taking into account also the radiogenic heat contribution in the continental margins  $q_r$  is:

$$q_r = 29.6 + 26.8(1 - 1/\beta)$$

(Pasquale et al., 1996)

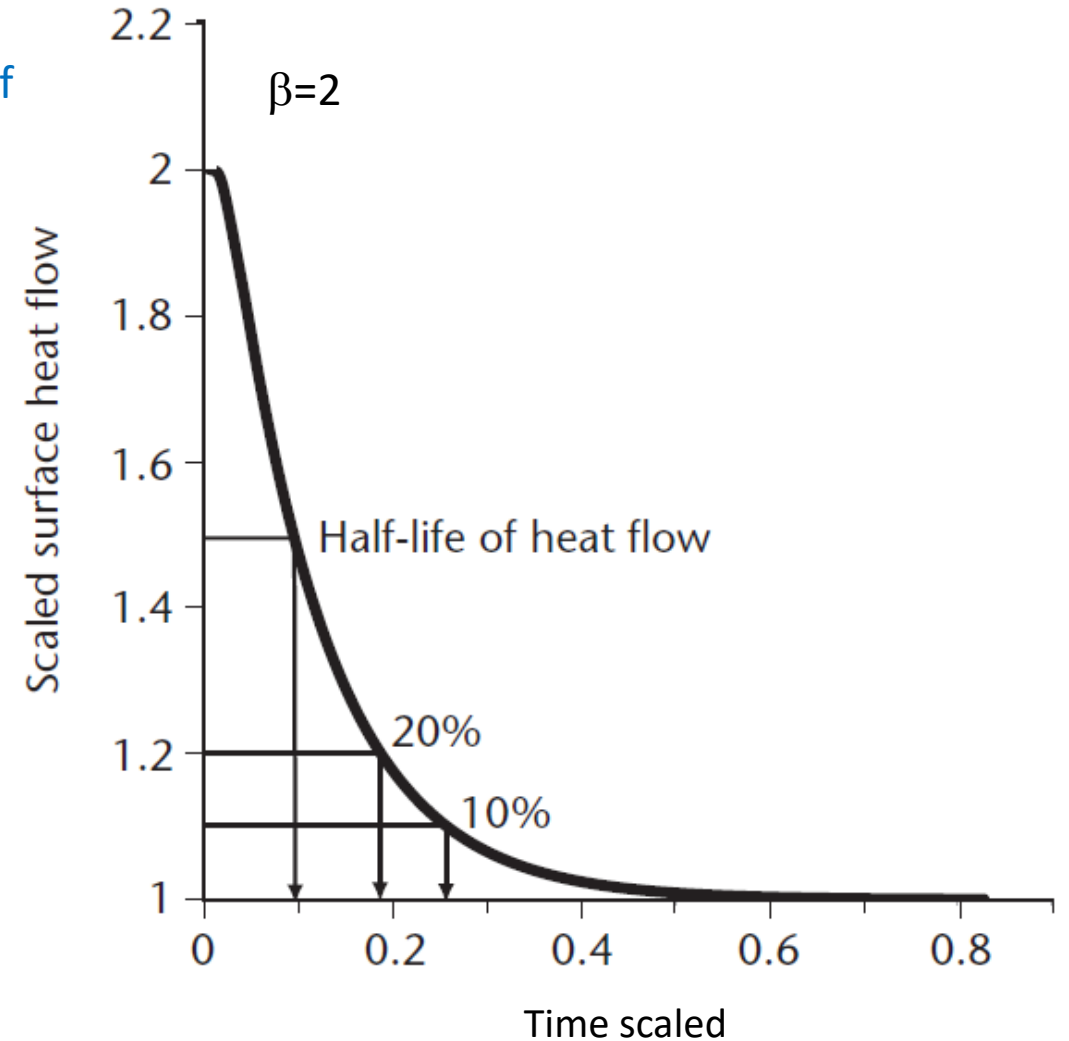



## Topography variations in the rift basins

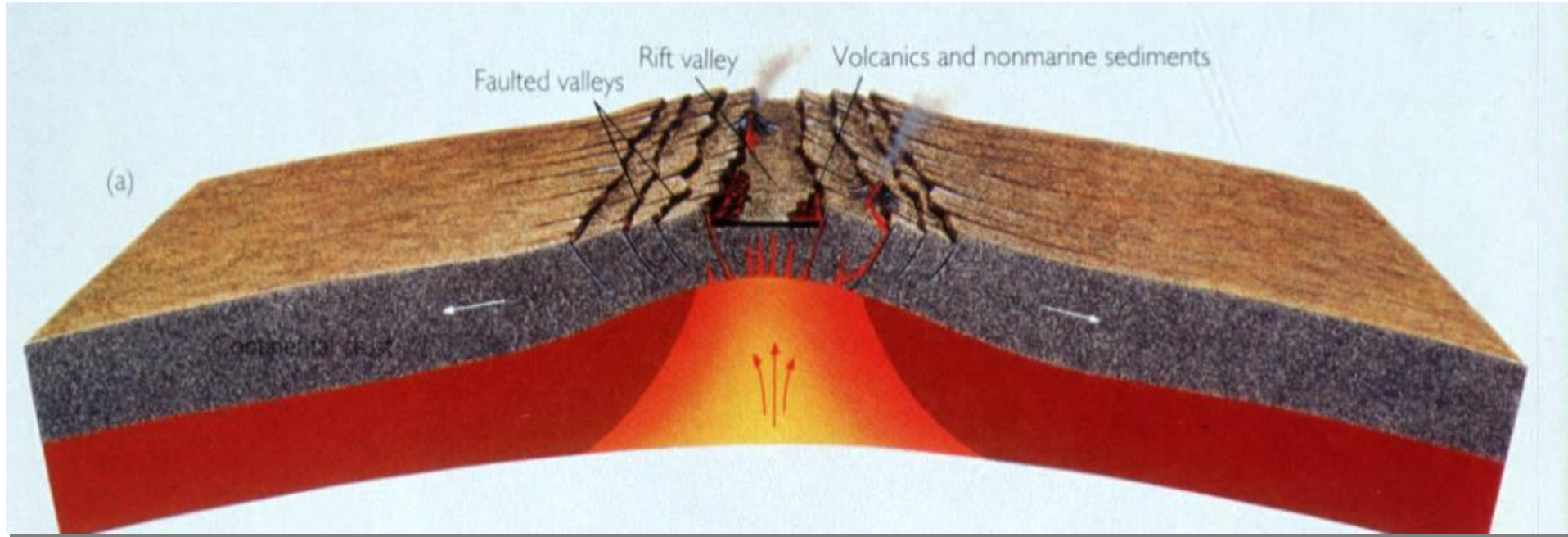

### **Subsidence and uplift in the rift basins depend on the loads variation during the basins evolution:**

- Loads promoting surface uplift are generated by increases in the geothermal gradient beneath a rift, which leads to density contrasts.
- Loads promoting subsidence may be generated by the replacement of thinned crust by dense upper mantle and by conductive cooling of the lithosphere (during the post-rift subsidence or during the synrift, if thermal diffusion is faster than heat advection).



# Uniform Lithosphere Extension

The topography variation at the time of the onset of stretching is a trade-off between the effect of crustal stretching (causing subsidence by faulting) and the effect of the stretching of the subcrustal lithosphere (causing uplift by thermal expansion).

Syn-rift subsidence as a function of the crustal/lithosphere thickness ratio  $y_c/y_L$

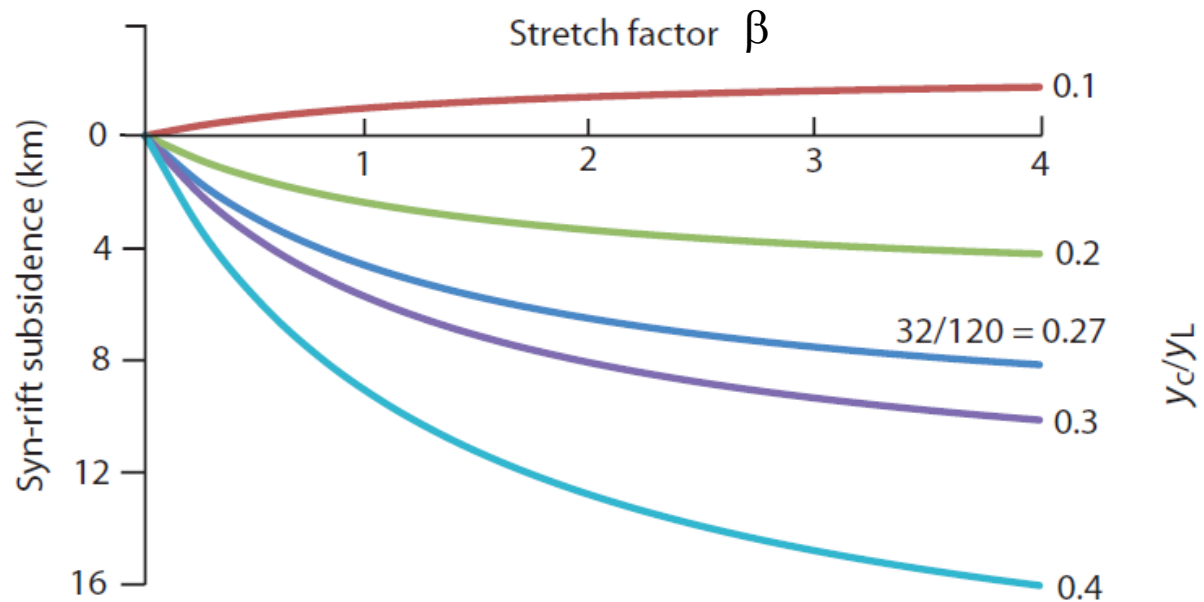

Crust, mantle and sediment densities:  $2700 \text{ kg m}^{-3}$ ,  $3300 \text{ kg m}^{-3}$ , and  $2000 \text{ kg m}^{-3}$

Subsidence due to the cooling effect

Water-loaded subsidence for different stretch factors

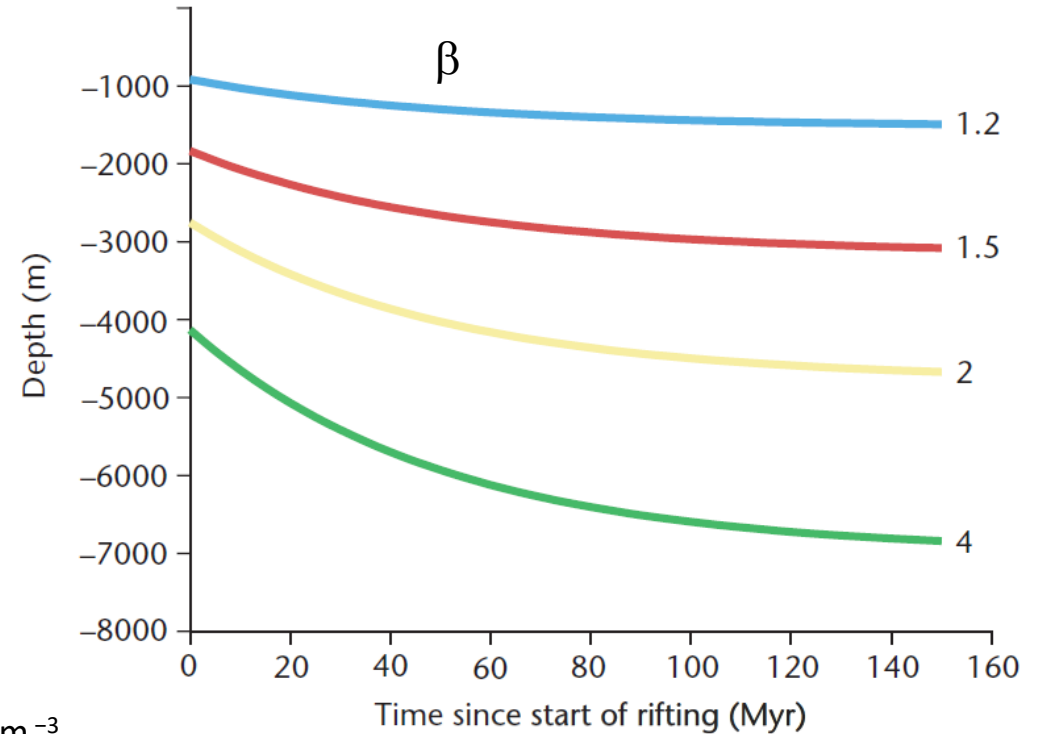

- At a crust/lithosphere thickness ratio of 0.12 (corresponding to  $y_c=15 \text{ km}$  and  $y_L=125 \text{ km}$  thick), there is neither uplift nor subsidence during rifting.
- For thinner crusts, uplift occurs and for thicker crusts, subsidence occurs. Since crustal thicknesses are typically 30–35 km, the syn-rift phase should be characterized by subsidence.

# Heat Advection vs Heat Conduction: Péclet Number

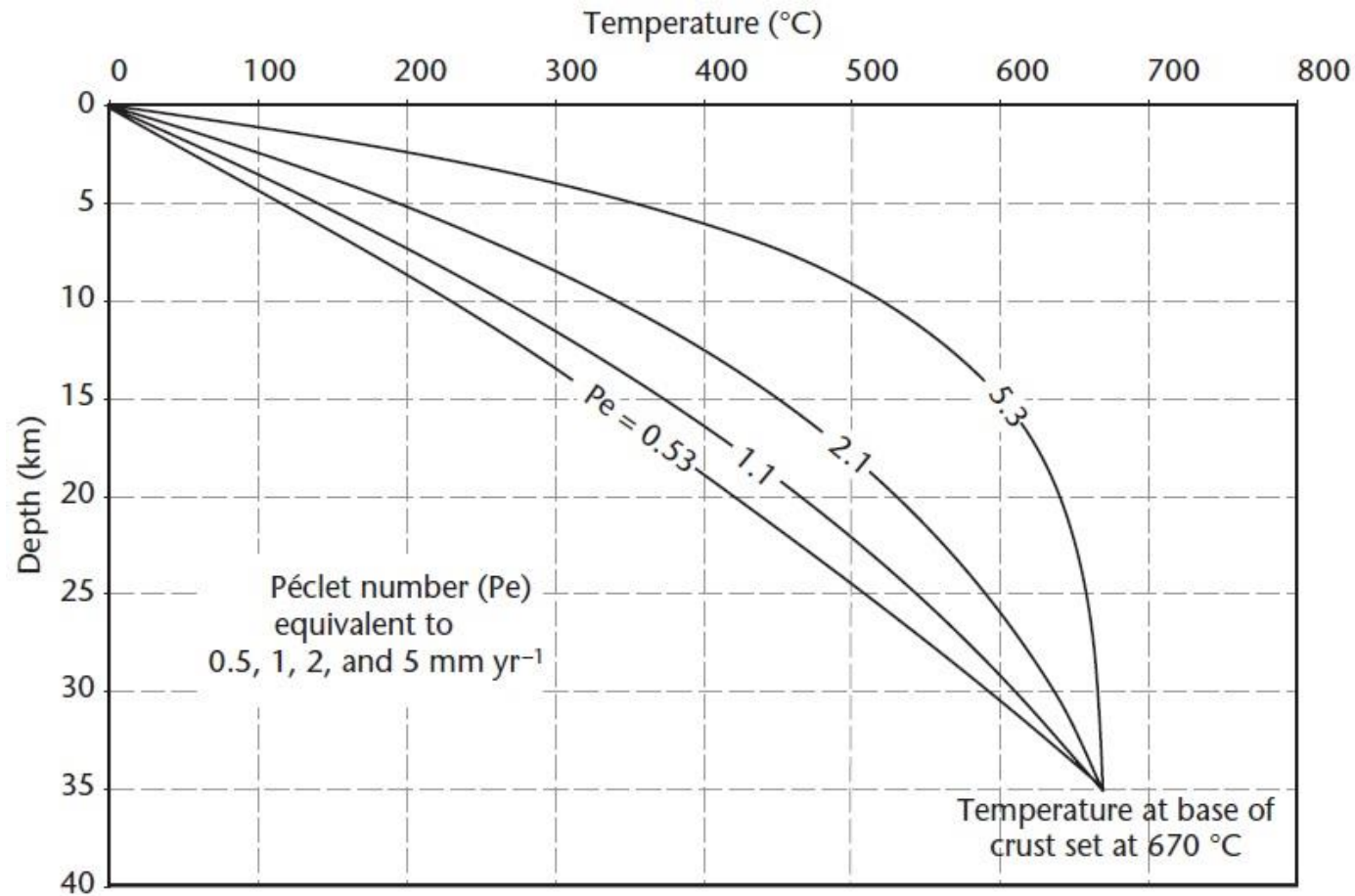

$$Pe = \frac{EL}{\kappa}$$

$E$ =Exhumation rate

$L$ =depth to a lower boundary (e.g., base of the crust)

- At high exhumation rates, the upward advection of hot rock towards the surface outweighs the conductive cooling, causing highly curved geotherms.
- In the case of high exhumation rate, the geothermal gradient changes from 40–60 °C km<sup>-1</sup> in the upper 5 km of the crust to <10 °C km<sup>-1</sup> in the lower crust.

# Extensional Strain Rate and Stretching Factor

$$v = \frac{\Delta l}{t} \quad \text{Velocity of extension averaged over a time interval } t$$

$$\beta = \frac{l_0 + \Delta l}{l_0} \quad \text{Extended length compared to the initial length}$$

- The stretching factor  $\beta$  increases exponentially for a constant strain rate over time: the total stretching factor resulting from a constant strain rate over a time interval  $t$  is given by

$$\dot{\epsilon} = \frac{\ln \beta}{t} \quad \text{or} \quad \dot{\epsilon} = \frac{v \ln \beta}{\Delta l}$$

$$\dot{\epsilon}_y(t) = -\frac{1}{y} \frac{dy}{dt}$$

$$v_y = -\dot{\epsilon}_y y$$

$$v_x = \dot{\epsilon} (x - x_{ref})$$

$x_{ref}$ : arbitrary reference position where  $v_x = 0$

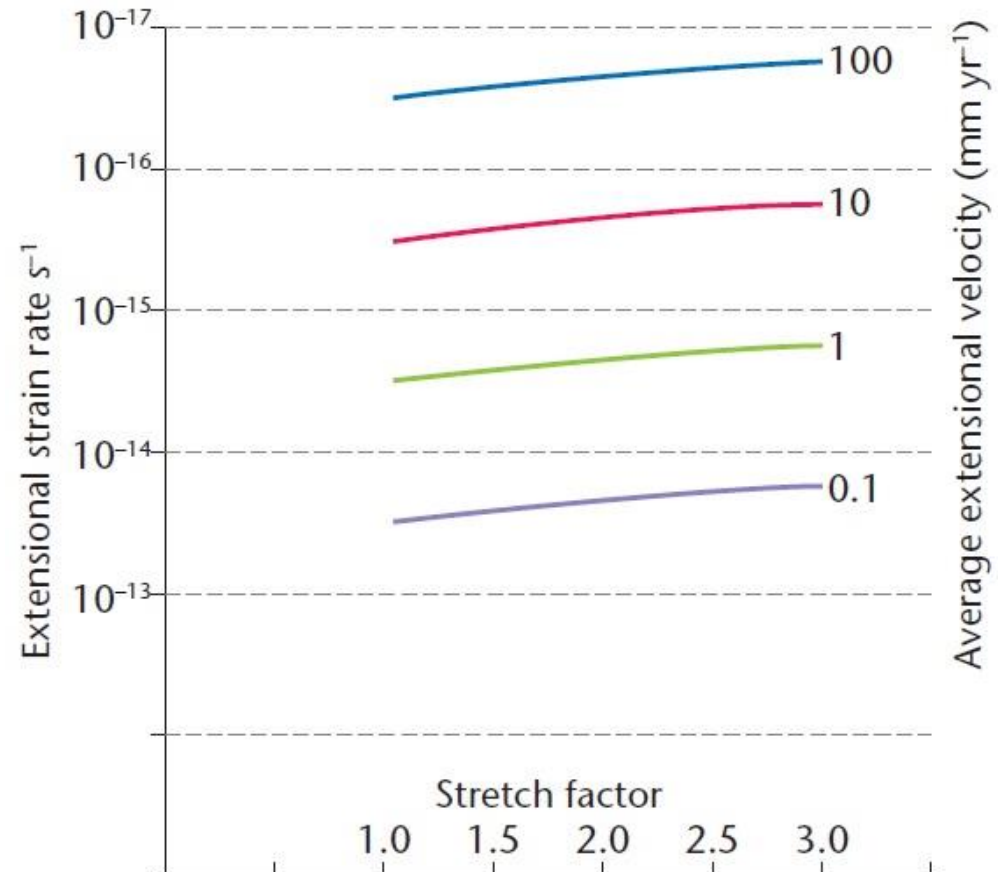

## Modifications of the uniform stretching model

- ***Protracted periods of stretching***: cause slowly extending lithosphere to cool during the phase of stretching.
- ***Non-uniform (depth-dependent) stretching***: the mantle lithosphere may stretch by a different amount to the crust.
- ***Pure versus simple shear***: the lithosphere may extend along trans-crustal or trans-lithospheric detachments by simple shear.
- ***Elevated asthenospheric temperatures***: the base of the lithosphere may be strongly variable in its temperature structure due to the presence of convection systems such as hot plumes.
- ***Magmatic activity***: the intrusion of melts at high values of stretching modifies the heat flow history and thermal subsidence at volcanic rifts and some passive margins.
- ***Induced mantle convection***: the stretching of the lithosphere may induce secondary small-scale convection in the asthenosphere.
- ***Radiogenic heat production***: the granitic crust provides an additional important source of heat, which affects the paleotemperature estimations.
- ***Depth of necking***: necking may be centred on strong layers deeper in the mid-crust or upper mantle lithosphere.
- ***Flexural compensation*** (particularly important in narrow rifts and passive margins, where the sedimentary load is high): the continental lithosphere has a finite elastic strength and flexural rigidity, particularly in the post-rift thermal subsidence phase, when it cools.
- ***Phase changes***: Decompression may cause mantle rocks to cross the transition from garnet to plagioclase, which results in reduction in density and thus uplift.

# Modifications of the uniform stretching model

- Protracted periods of stretching:**

- If stretching duration (10-50 Myr) is large compared with the diffusive time scale of the lithosphere ( $\tau=L^2/\pi^2k$ ), some of the heat diffuses away before stretching is completed.
- At low strain rates ( $10^{-16} \text{ s}^{-1}$ ) the heat loss by conduction and the upward advection of warm lithosphere have similar value. Then, syn-rift subsidence is longer and larger, while subsequent thermal subsidence is less (the overall subsidence profile has a more constant slope).

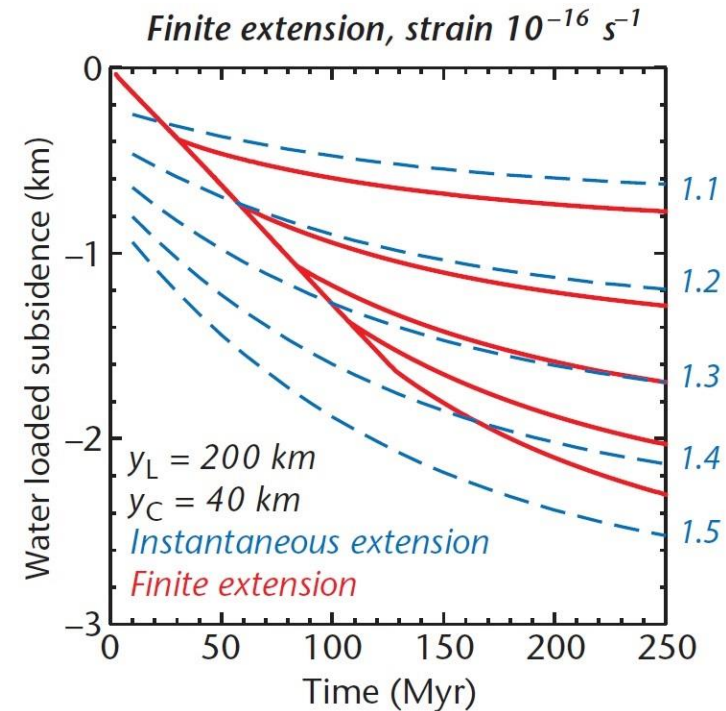
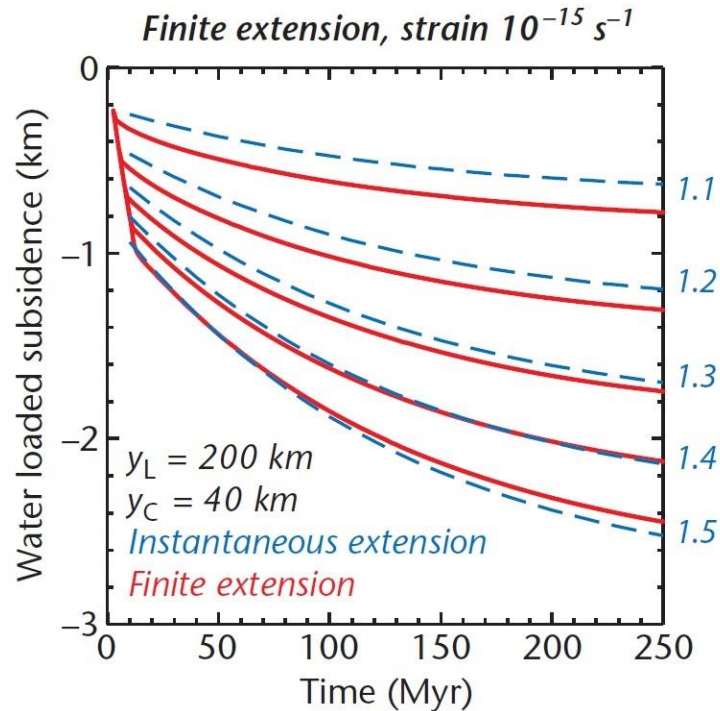

**Peclet number ( $Pe$ ): competing effects of advection and diffusion**

$Pe > 10$  upward advection dominates ( $Pe = 20$  for strain rates  $10^{-15} \text{ s}^{-1}$ )

$Pe < 1$  diffusion dominates ( $Pe = 0.2$  for strain rates  $10^{-17} \text{ s}^{-1}$ )

$$Pe = \frac{vy_L}{\kappa} \quad Pe = \frac{\dot{\epsilon}y_L^2}{2\kappa}$$

$\kappa$ =thermal diffusivity

$v$ =upward advection of material

$y_L$ =lithospheric thickness

# Non-uniform stretching

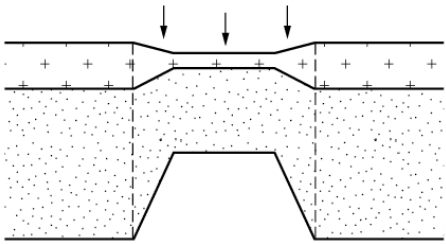

UNIFORM STRETCHING MODEL

$$\delta \text{ CRUST} = \beta \text{ MANTLE LITHOSPHERE}$$

McKENZIE, 1978

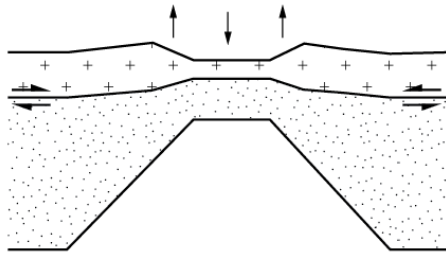

DISCONTINUOUS, DEPTH - DEPENDENT STRETCHING MODEL

$$\delta \text{ CRUST} < \beta \text{ MANTLE LITHOSPHERE}$$

ROYDEN AND KEEN, 1980  
BEAUMONT ET AL., 1982

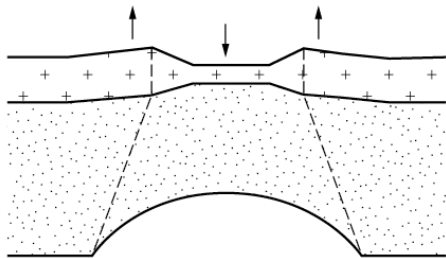

CONTINUOUS, DEPTH - DEPENDENT STRETCHING MODEL

$$\delta \text{ CRUST} = \beta \text{ MANTLE LITHOSPHERE}$$

ROWLEY AND SAHAGIAN, 1986



CRUST



MANTLE LITHOSPHERE

**Discontinuous model:** Decoupling between two layers with different values of stretching factor ( $\beta$ )  
Decoupling depth approximate crustal thickness

**Continuous Model:** there is a smooth transition in the stretching through the lithosphere. Mantle responds to extension as a function of depth (the strain rate decreases as the extension is diffused over a wider region) and extends over a wider region than the crust (but with equal total amounts of extension).

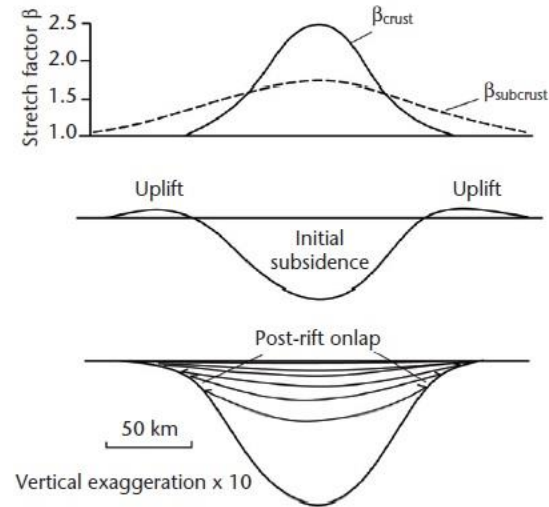

Taper angle  $\phi$  = angle between the vertical and the boundary of the stretched region in the mantle lithosphere  
 $\phi = \tan^{-1}$  (width of the region over which the topography uplift occurs/thickness of SubCrustalLithosphere)  
 For large values of  $\phi$ , the initial subsidence is increased but the amount of post-extension thermal subsidence is decreased.



# Pure Shear vs Simple Shear

Symmetrical and asymmetrical geometry depends on the rheological structure and lithospheric layers

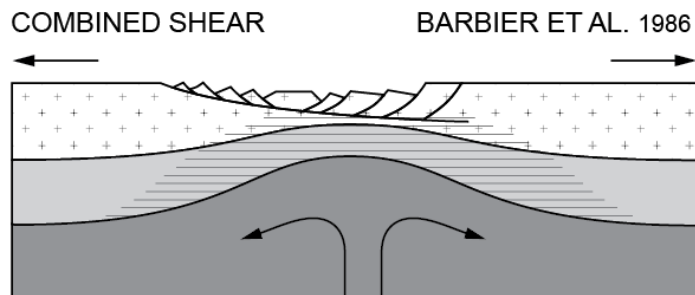
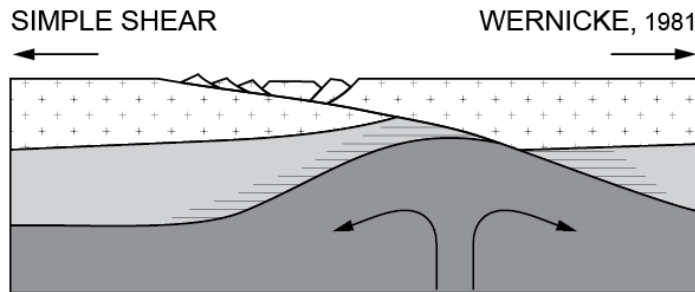
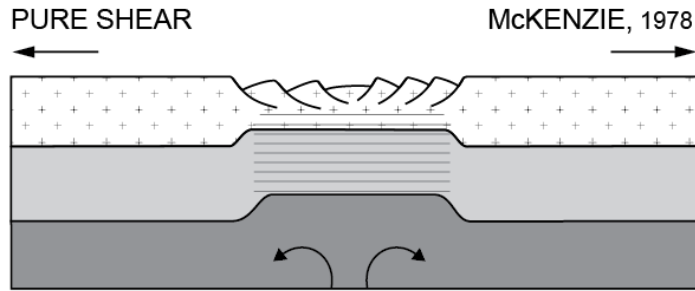

- Fully symmetric rifting of hot upper and lower lithospheric layers takes place at a high rifting velocity for both decoupled and coupled cases.
- Fully asymmetric rifting of both layers is produced at a low rifting velocity with coupled upper and lower lithospheric layers. The asymmetry causes a little crustal thinning over places where the lithosphere is greatly thinned (thermal subsidence  $\gg$  tectonic subsidence).
- Asymmetric upper lithosphere rifting and symmetric lower lithospheric rifting are produced at a low rifting velocity, where the upper and lower lithospheric layers are decoupled. Subsidence is observed in the region of crustal thinning and uplift in the region overlying the mantle thinning.

# Simple Shear

- Simple shear and isostatic compensation can lead to the development of flat detachment faults, tilted listric fault blocks and metamorphic core complexes.

Wernicke and Axen, 1988

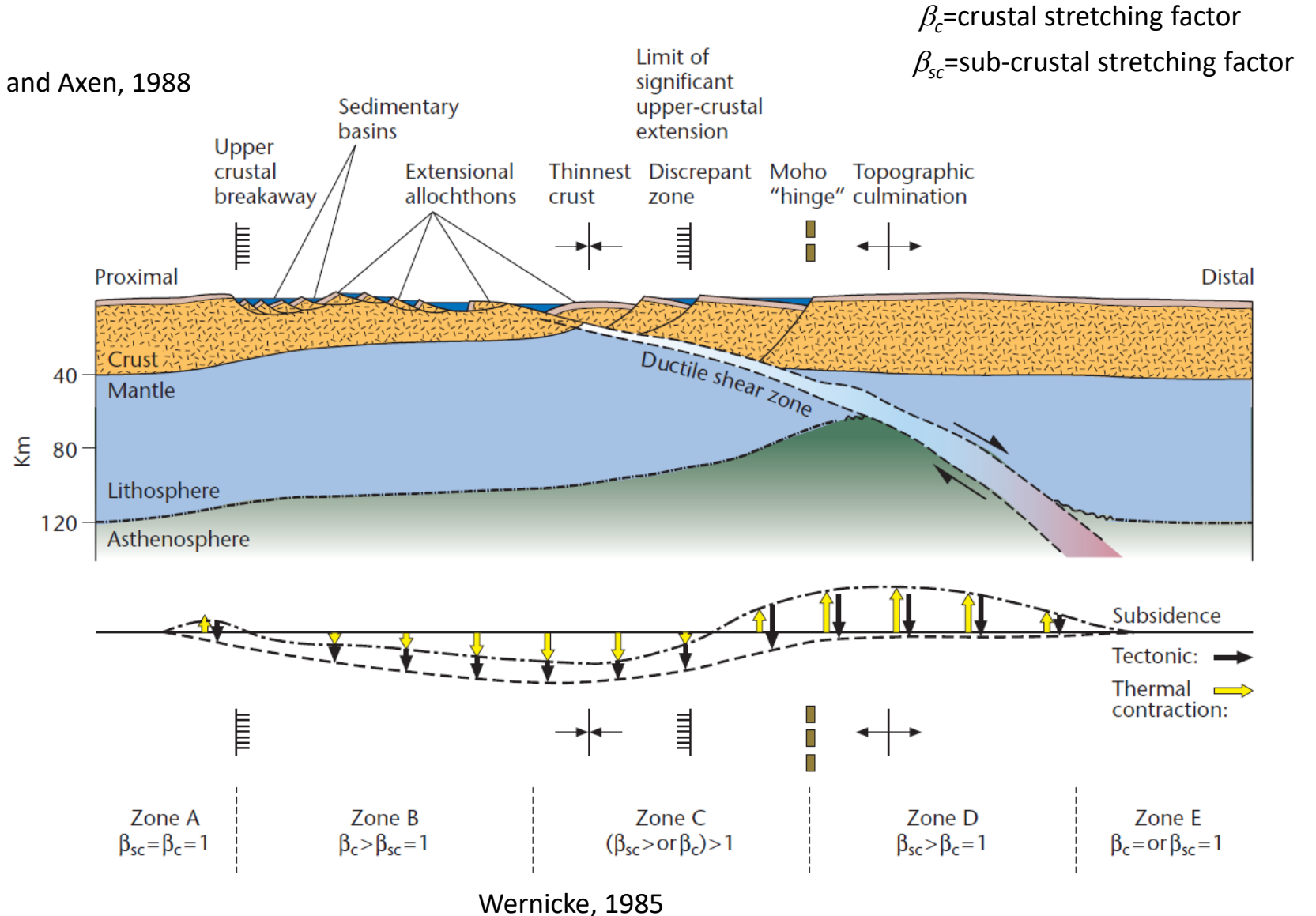
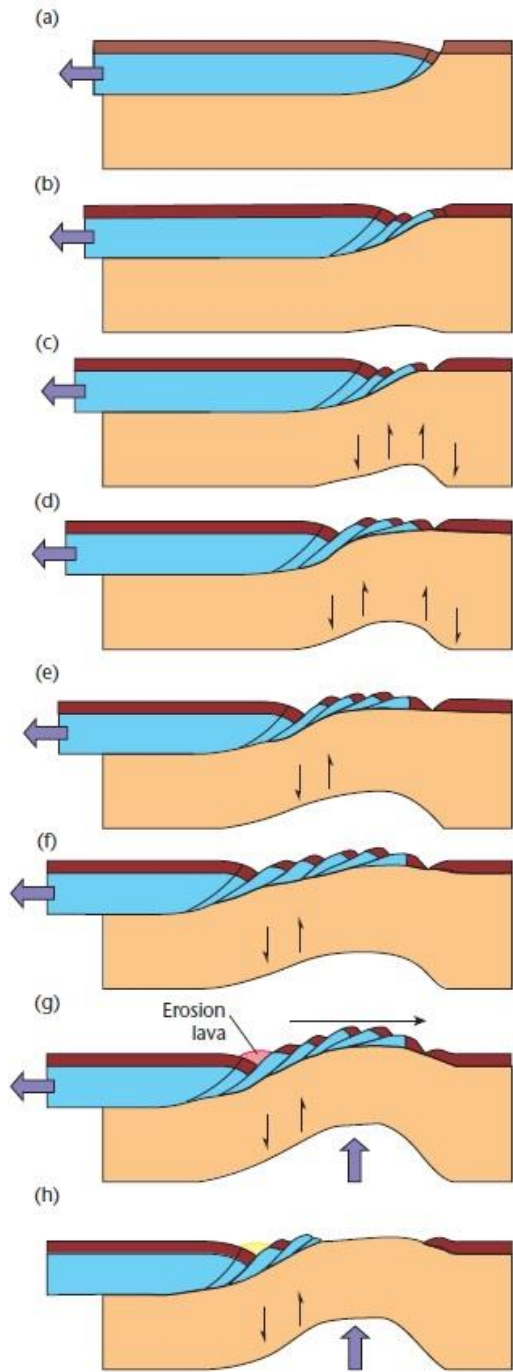



# Simple Shear/Pure Shear

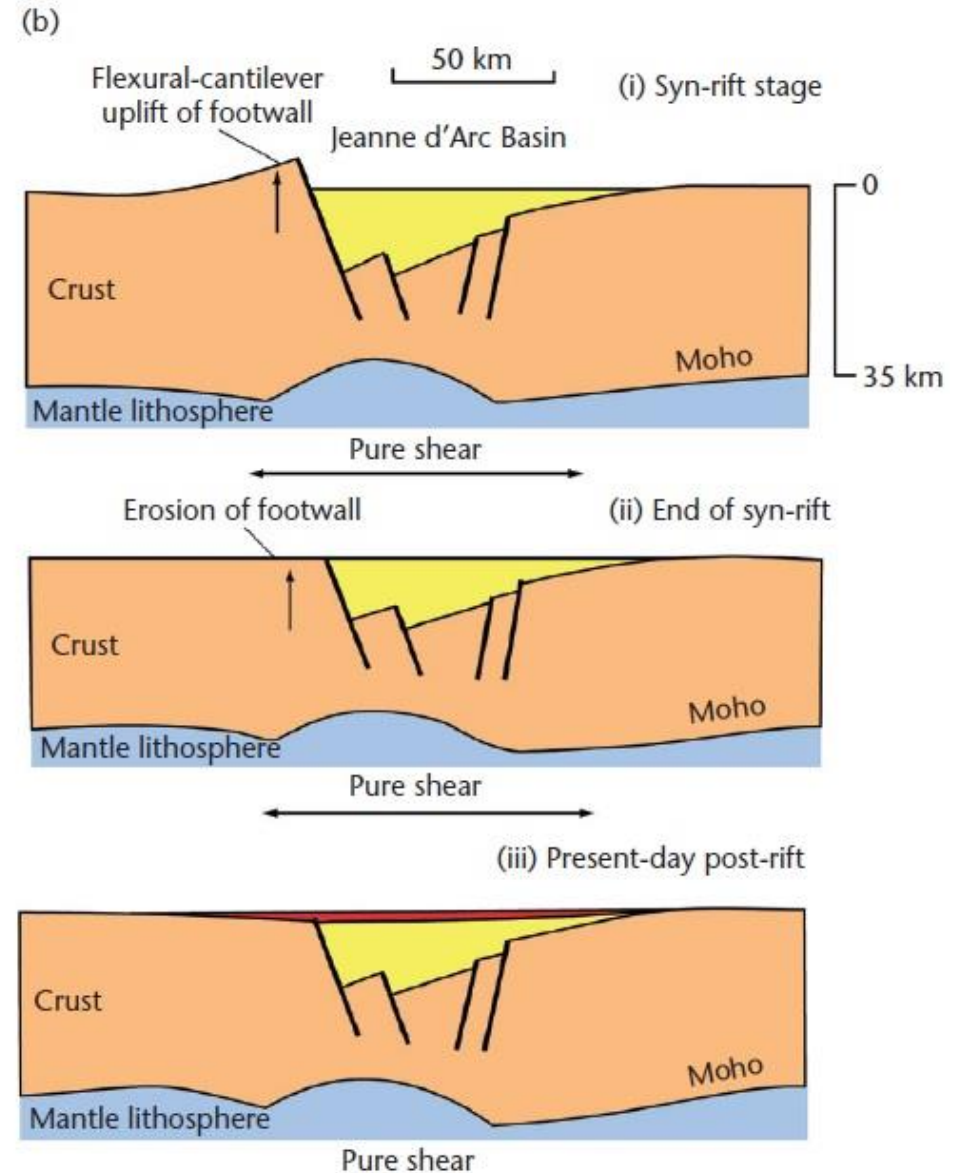
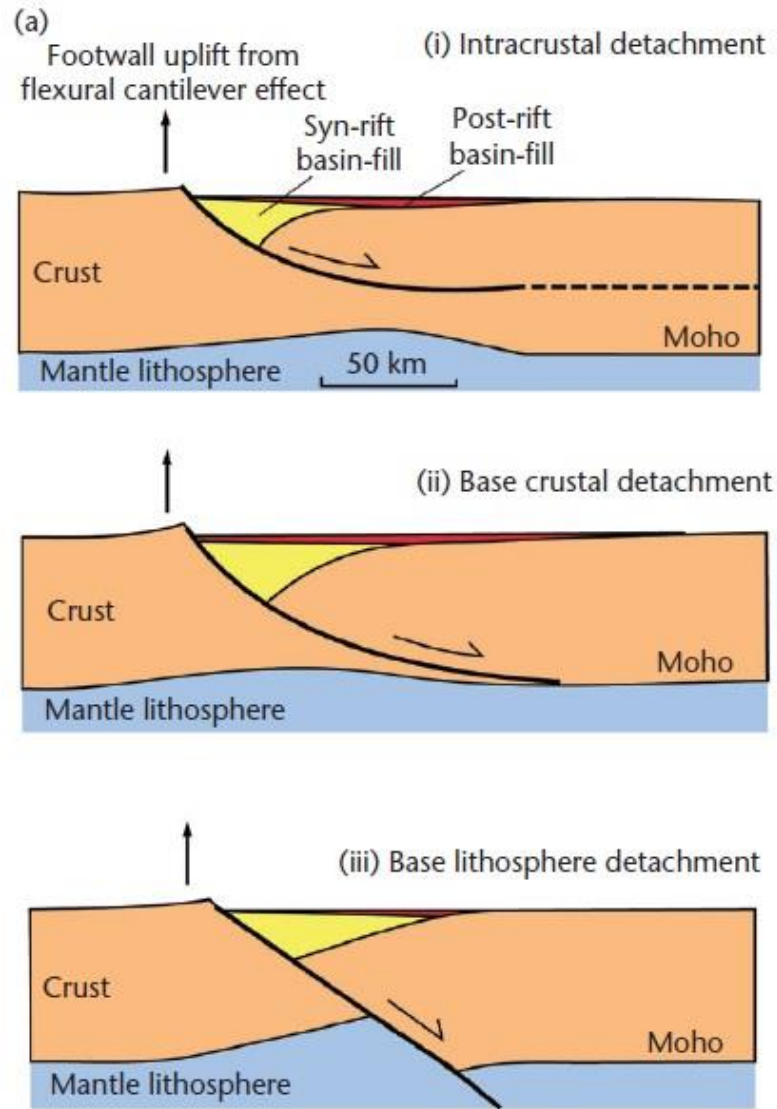

Tectonic unloading may also result in flexural uplift of adjacent footwall areas along major detachment faults

# Lithospheric rheology

## Kinematic model for extension of rheologically layered lithosphere

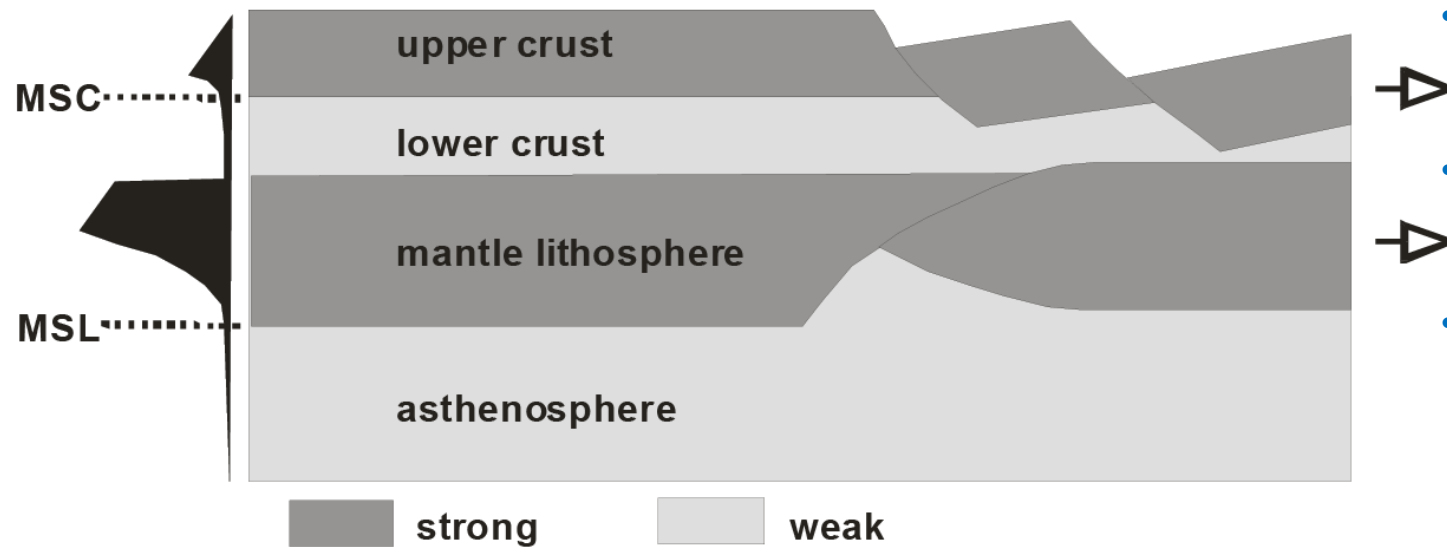

- In the presence of a weak lower crustal layer, decoupling of the mechanically strong upper crust from the even stronger upper lithospheric mantle occurs.
- The zone and symmetry of upper crustal extension, does not necessarily coincide with the zone and symmetry of lithospheric mantle extension.
- This is particularly the case if the upper crust is weakened by preexisting discontinuities favouring its simple shear extensional deformation.

- A strong lower crust causes extension occurring with widely distributed, densely spaced faults.
- A weak lower crust causes extension to localize onto relatively few faults that accommodate large displacements, may dissect and dismember the upper crust causing lower crust exhumation (core complex formation).
- A weak lower crust promotes the localization of strain into narrow zones and when it flows transfer stress into the upper crust, which may control the number of fault zones that are allowed to develop.

# Lithospheric rheology

## Lithospheric rheology influences the fault types and basins evolution

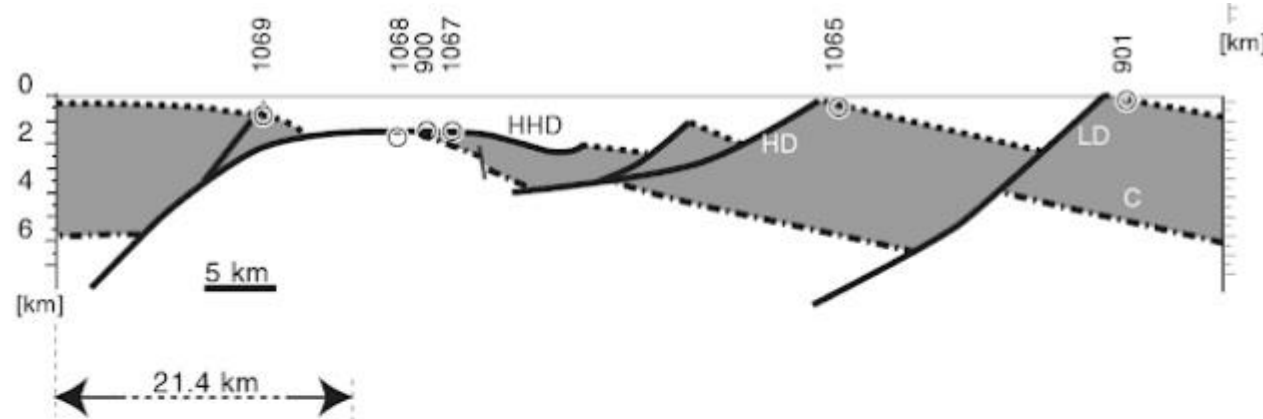

Low-angle normal faults whose dips increase with depth (i.e. concave downward faults, HHD) may unroof the deep crust efficiently if faulting is accompanied by a thinning of the middle crust and formation of serpentinite beneath it.

- pre-rift and crust
- mantle peridotite (variably serpentinized)
- top acoustic basement
- crust-mantle boundary (C)

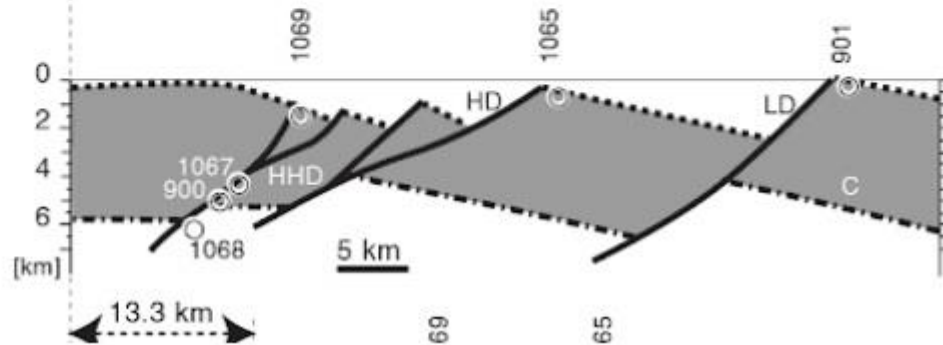

Listric fault surfaces whose dip angle decreases with depth (i.e. concave upward faults, HD, LD, HHD) are unable to accommodate displacements large enough (>10 km) to unroof the deep crust.

# Elevated asthenospheric temperatures (Plume)

Plume activity (common during oceanic opening and supercontinental break-up) causes surface uplift and magmatic activity

- Amount of melt generated depends on the potential temperature of the asthenosphere and amount of stretching
- Magmatic underplating of the base of the crust can cause uplift of the surface

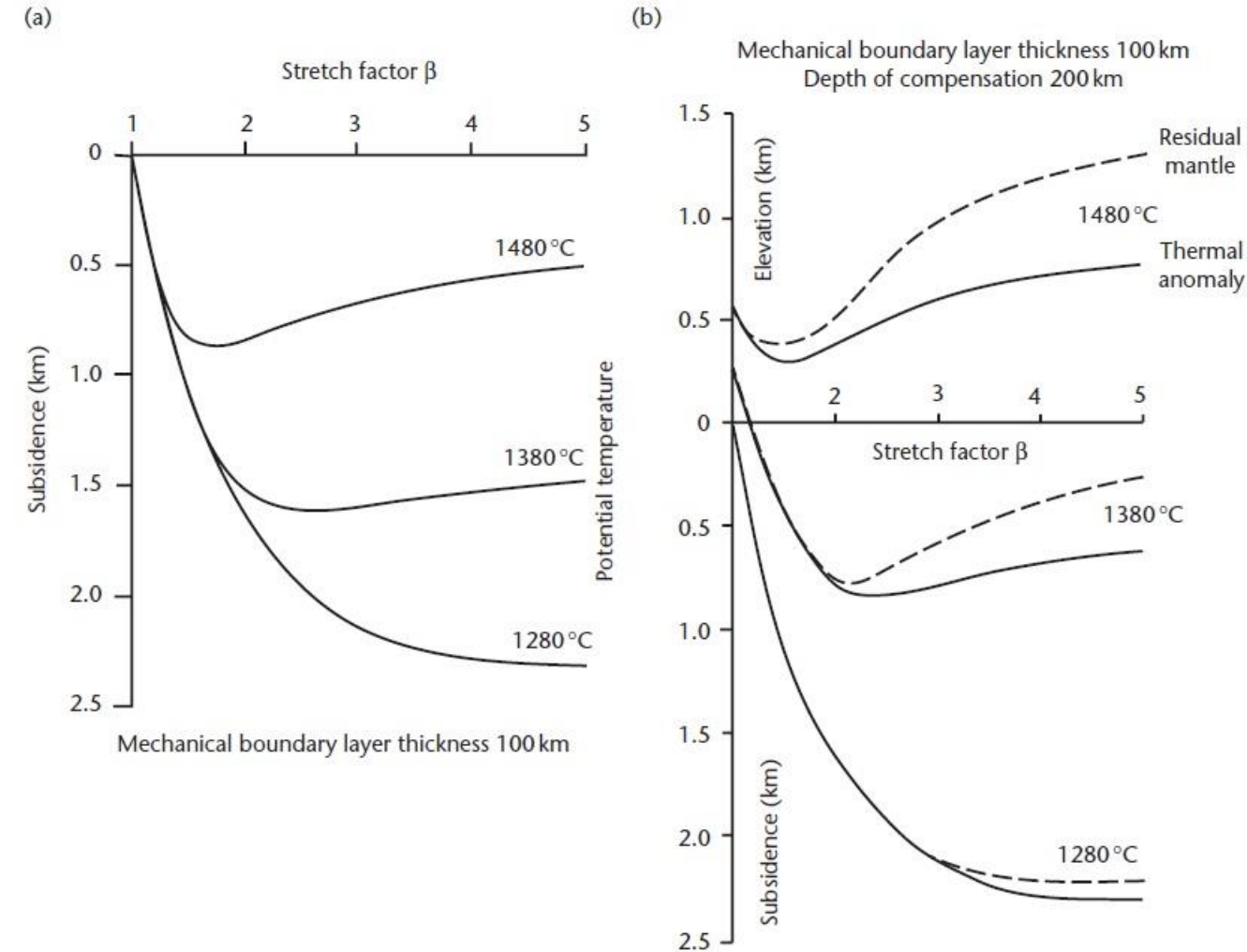

The curves incorporate the effects of lithospheric thinning and crustal additions of melts caused by decompression of the mantle.

Residual mantle curves show the effects of the reduced density of the depleted mantle from which melt has been extracted.

# Elevated asthenospheric temperatures (mantle convection)

Development of small-scale convection beneath rifts is likely induced by the large temperature gradients set up by rifting

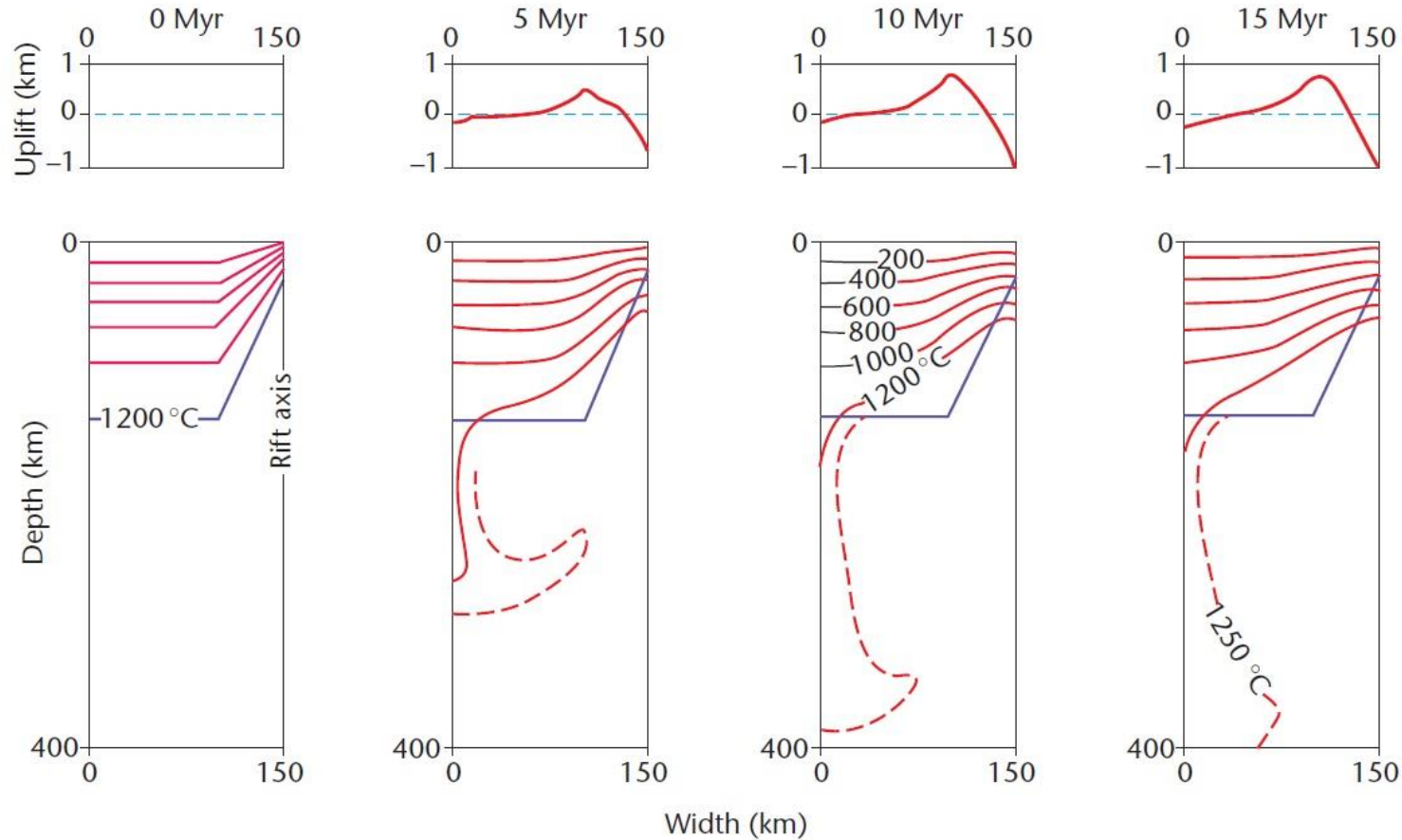

$\beta=1.6$   $T_m=1300^\circ\text{C}$

Buck, 1984

- The rift flank is progressively heated through time, causing rift shoulder uplift.
- Convecting transport heats the lithosphere bordering the rift, causing uplift of rift shoulders and extension within the rift itself.

# Basaltic melts beneath the rifts

The mantle may melt to produce basaltic liquids beneath rifts:

1. melting may be accomplished by heating the mantle above the normal geotherm.
2. The ascent of hot mantle during lithospheric stretching causes a reduction in  $P$  that leads to decompression melting at a variety of depths, with the degree of melting depending on the rate of ascent, the geotherm, the composition of the mantle, and the availability of fluids.
3. Addition of volatiles lowers the solidus  $T$ .

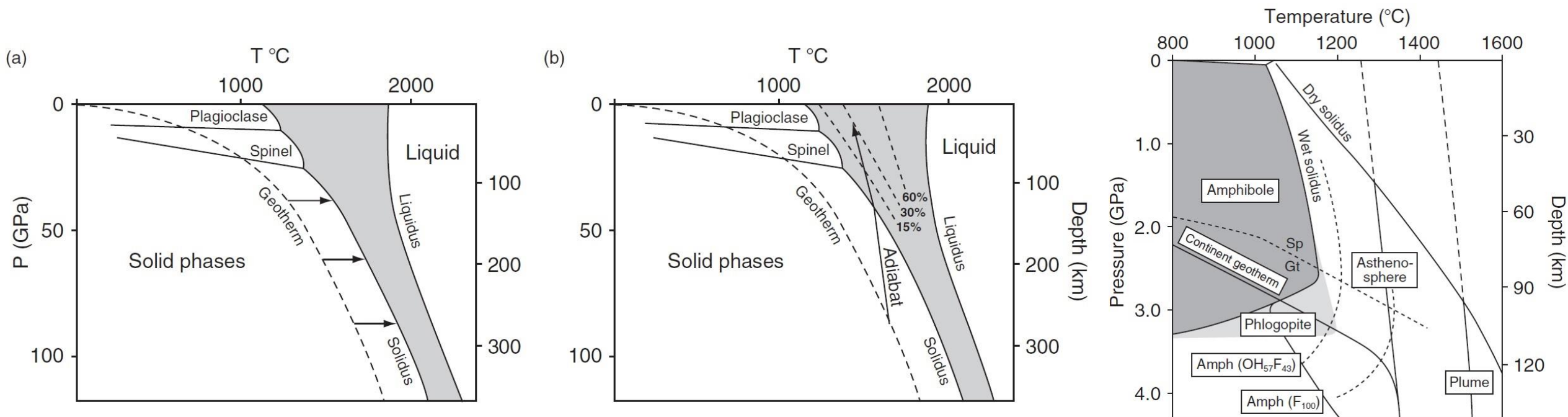

- The magmatic budget depends on  $T$ , strain rates, and strength of the lithosphere.
- Rift basalts are similar to those of oceanic islands, enriched in incompatible trace elements, indicating a heterogeneous magma source (in the lithosphere, asthenosphere or deeper) and different amount of melting (it decreases from tholeiitic to alkaline basalts).
- In southern Kenya, the presence of amphibole in some mafic lavas implies a magma source in the subcontinental lithosphere.



# Magmatic activity

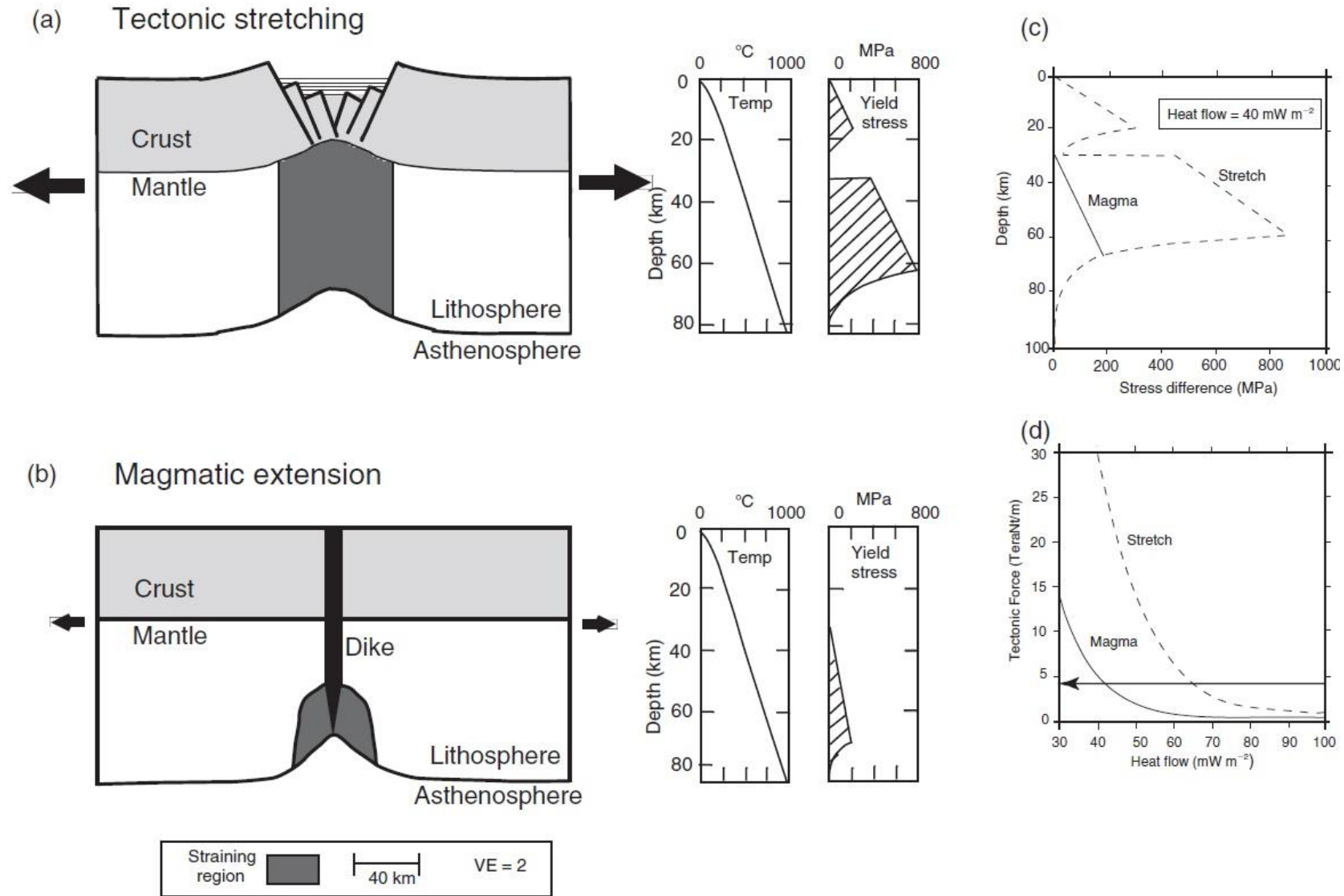

- When a magma source is available, the intrusion of basalt in the form of vertical dikes could permit the lithosphere to separate at much lower stress levels than is possible without the diking.



# Magma influence on rifting

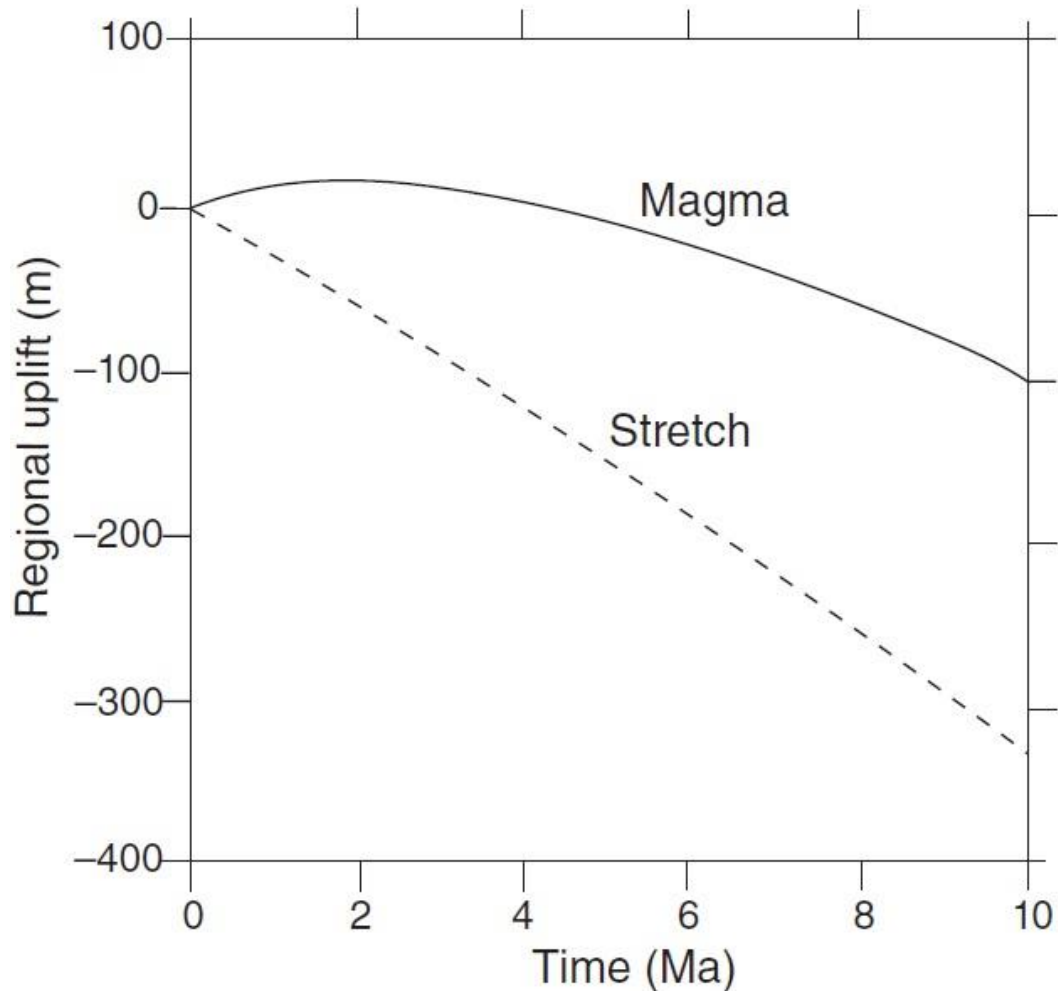

- Mafic magmatism reduces the strength of the lithosphere and influences its thickness, temperature, density, and composition.
- The presence of hot, partially molten material beneath a rift valley produces density contrasts that result in thermal buoyancy forces.
- As the two sides of the rift separate, magma also may accrete to the base of the crust where it increases in density ( $\sim 3000 \text{ kg/m}^3$ ) as it cools and may lead to local crustal thickening.
- The emplacement of large quantities of basalt in a rift can accommodate extension without crustal thinning.
- If enough material intrudes, the crustal thickening that can result from magmatism can lessen the amount of subsidence in the rift and may even lead to regional uplift.
- The uplift or subsidence result from changes in density related to the combined effects of crustal thinning, basalt intrusion and temperature differences over a limited horizontal distance (e.g., 100 km).

# Lithospheric strength and necking depth

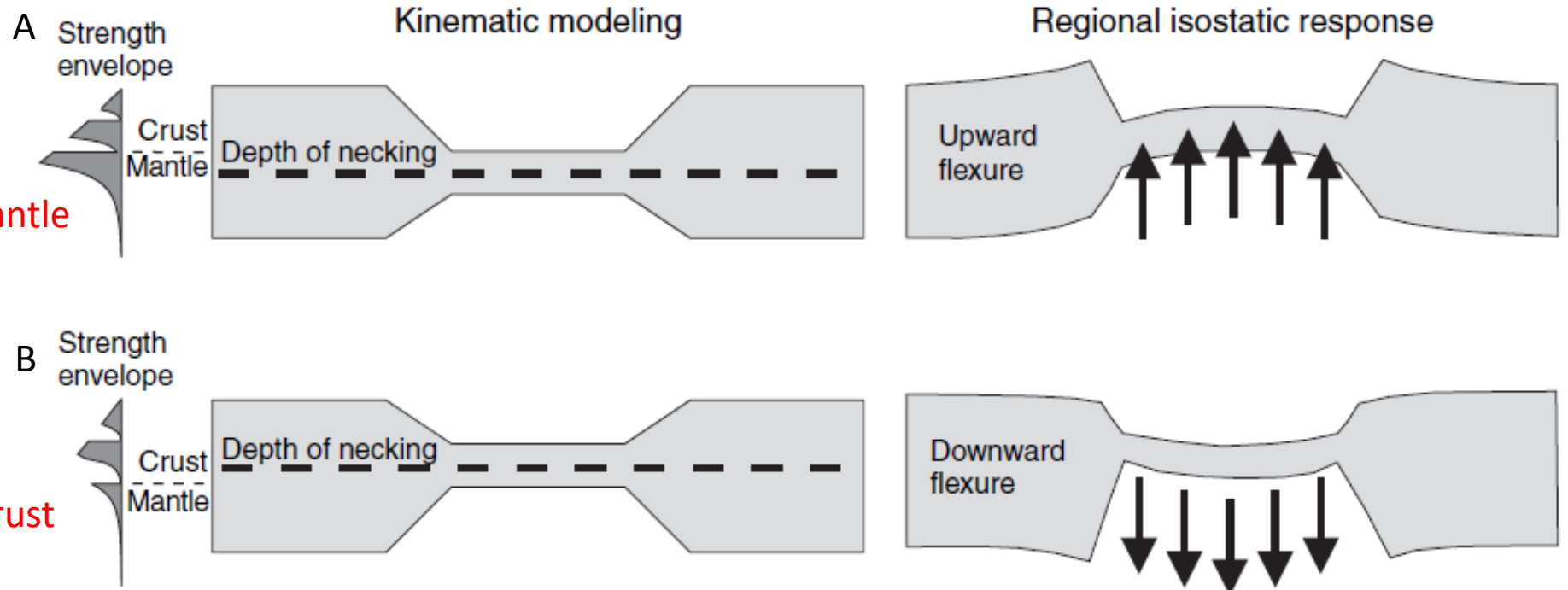

A: Strong layer in lithospheric mantle  
(e.g., Res Sea basin)

B: Weak lithosphere with thick crust  
(e.g., Pannonian basin)

- A strong layer in the subcrustal mantle, the level of lithospheric necking is deep, inducing pronounced rift-shoulder topography.
- For basins developed on a weak lithosphere with a thickened crust, the necking level is generally located at shallower depths.

**Width and height of the uplift of flanks** depend on **strength and  $T_e$**  + minor factors (crustal stretching factor, and density of sediments).

**Strong plates** results in a narrow deformation zone with long wide basins, and long border faults.

**Weak plates** result in a very broad deformation zone with many short, narrow basins, and short border faults.

# Rift flank uplift

Flank uplift as a result of lateral heat flow

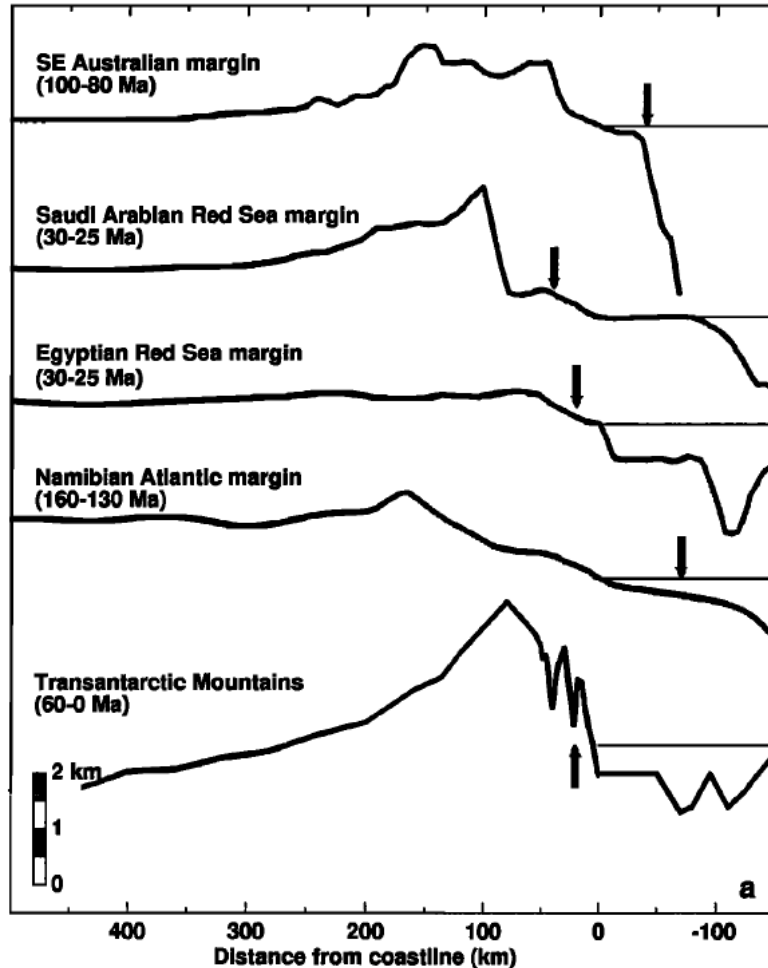

Flexural isostatic compensation following the mechanical unloading of the lithosphere by normal faulting and crustal thinning leads to uplift of the rift flanks:

The width and height of the uplift depend on:

- (1) Strength of the elastic lithosphere,
- (2) Stretching factor ( $\beta$ )
- (3) Density of the basin infill
- (4) Other minor factors: erosion and small-scale mantle convection

- **Strong plates result in a narrow deformation zone** with long, wide basins and long border faults that penetrate deeper into the crust.
- **Weak plates result in a very broad zone of deformation** with many short, narrow basins and border faults that do not penetrate very deeply.

# Influence of phase changes on uplift/subsidence

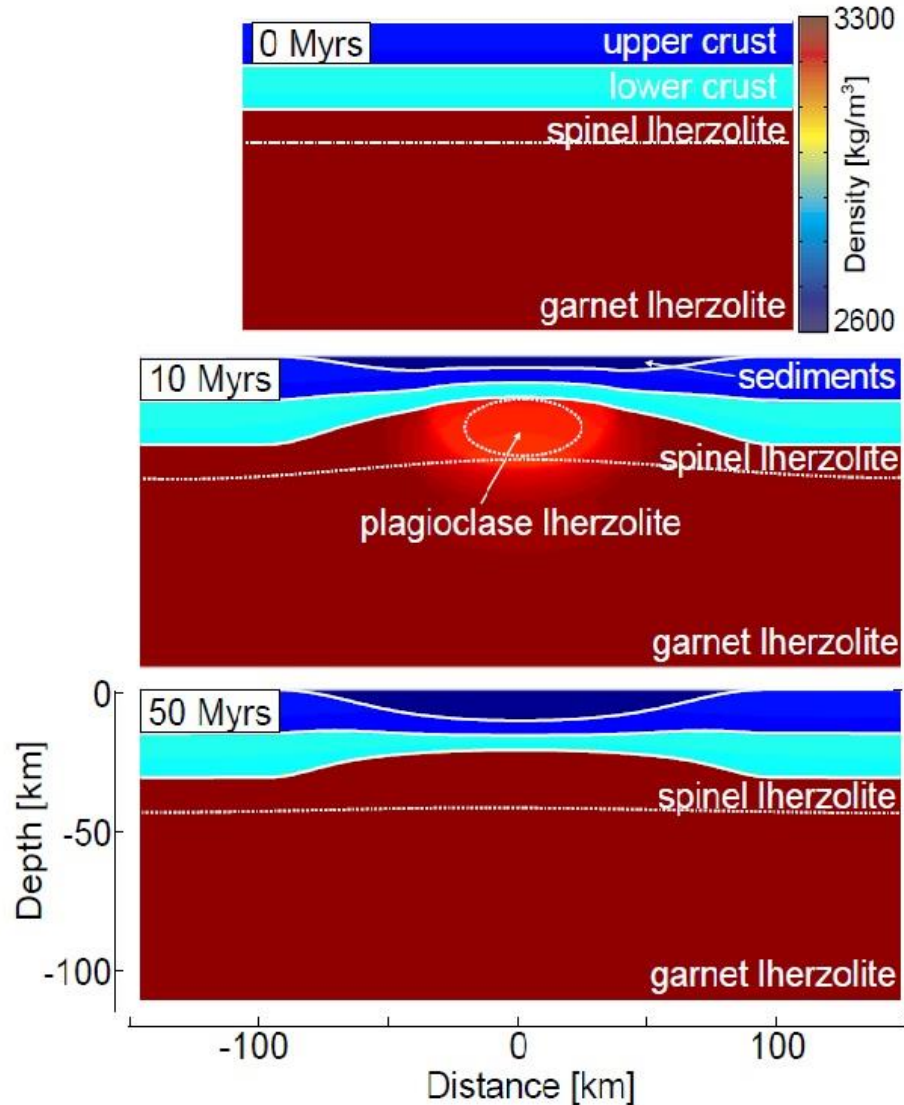

- The spinel–garnet–plagioclase–lherzolite transitions are responsible for the most significant effects on subsidence.
- Phase transitions have the effect of increasing post-rift subsidence and decreasing syn-rift subsidence.

- Upper crust has a T-dependent density with  $\rho_0=2700 \text{ kgm}^{-3}$ .
- Lower crust has T-dependent density with  $\rho_0=2900 \text{ kgm}^{-3}$ .
- Initial crustal thickness = 35 km;
- Stretching is active for 10 Myr
- $T_e=0 \text{ km}$ .

# Post-rift Subsidence

Subsidence during postrift stages follows an asymptotic curve, reflecting the progressive decay of the rift-induced thermal anomaly (magnitude of anomaly and stretching factor) + flexural response of the lithosphere to loads due to water, sedimentation and vulcanism.

## North Sea Tectonic Subsidence

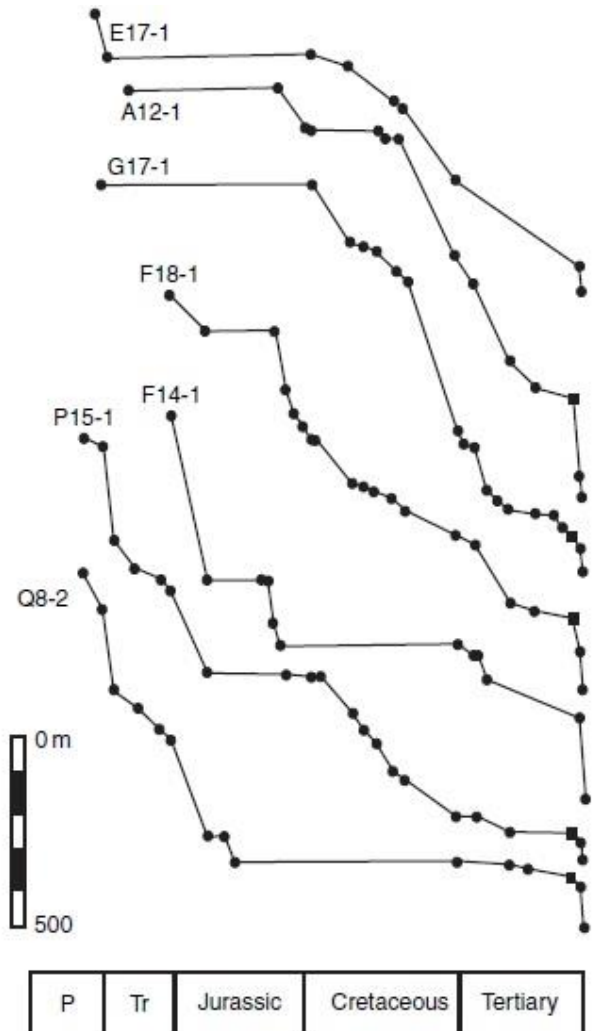

## The North Sea graben:

### Geological section and subsidence curves

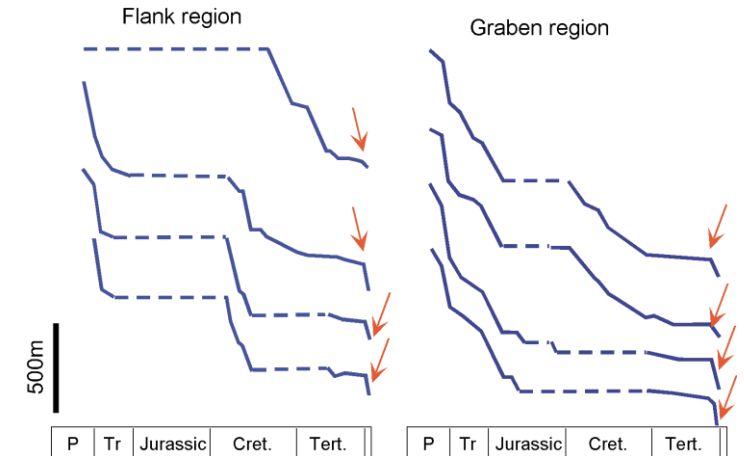
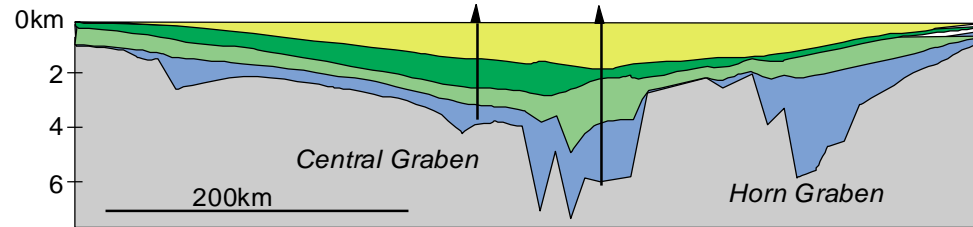

### Other factors influencing postrift subsidence:

- Phase transformation of the lithospheric rocks into eclogite and crustal rocks into granulite.
- Intraplate stress, which can cause deflection of the lithosphere (e.g., post-rift stage in the North Sea starts during Cretaceous and accelerates during Plio-Pleistocene likely due to a regional compressional stress) and strongly affect the development of salt diapirism.
- Late rifting pulse or regional magmatic events may interrupt and reverse cooling processes (e.g., northern part of Viking graben).
- Climatic effects: glacial loading and unloading.

# Strain Rate and rheology in the rift systems

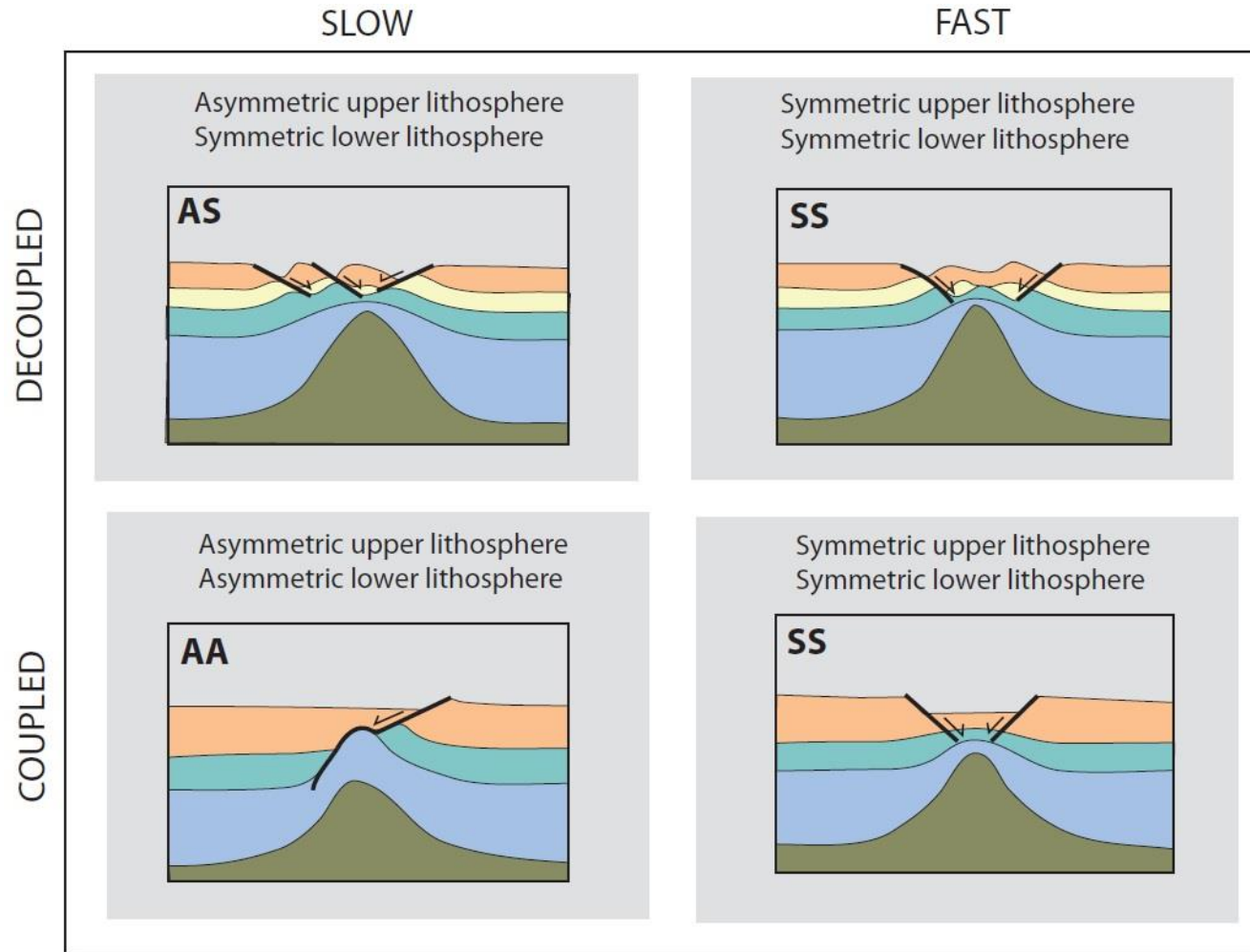

- **AS** – asymmetric upper lithosphere rifting and symmetric lower lithospheric rifting were produced at a *low* rifting velocity where the upper and lower lithospheric layers were *decoupled*.
- **AA** – fully asymmetric rifting of both layers was produced at a *low* rifting velocity with *coupled* upper and lower lithospheric layers.
- **SS** – fully symmetric rifting of both upper and lower lithospheric layers took place at a *high* rifting velocity, for both *decoupled* and *coupled* cases.



# Lithospheric stretching

**Mantle uprising causes two competitive effects: (1) *heat advection*, weakening the lithosphere (2) *heat diffusion* away from the zone of thinning, strengthening the lithosphere:** if heat advection is faster the lithosphere is weakened, while if heat diffusion is faster the lithospheric weakening is inhibited.

**Lithospheric weakening or strengthening depends on:**

- (1) strain rates: large values ( $10^{-13}\text{s}^{-1}/10^{-14}\text{s}^{-1}$ ) favour heat advection (weakening of the lithosphere), allowing deformation to focus on a narrow zone, while low values ( $10^{-16}\text{s}^{-1}$ ) favour heat diffusion (strengthening of the lithosphere) and strain delocalization because efficient cooling strengthens the lithosphere and cause deformation to migrate towards areas more easily deformable.**
- (2) Initial lithospheric strength.**
- (3) Total amount of extension.**

# Fast rifting versus slow extension: thermal evolution

## Fast extension

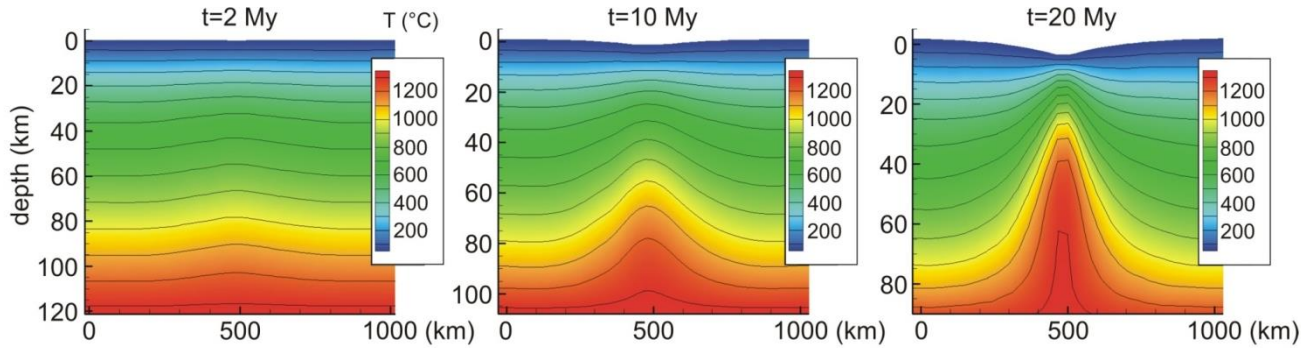

## Fast extension (16 mm/yr)

- Heating by thermal advection outpaces thermal diffusion, resulting in increased temperatures below the rift and strain localization in the zone of thinning.
- As the crust thins, narrow rift basins form and deepen.

## Slow extension

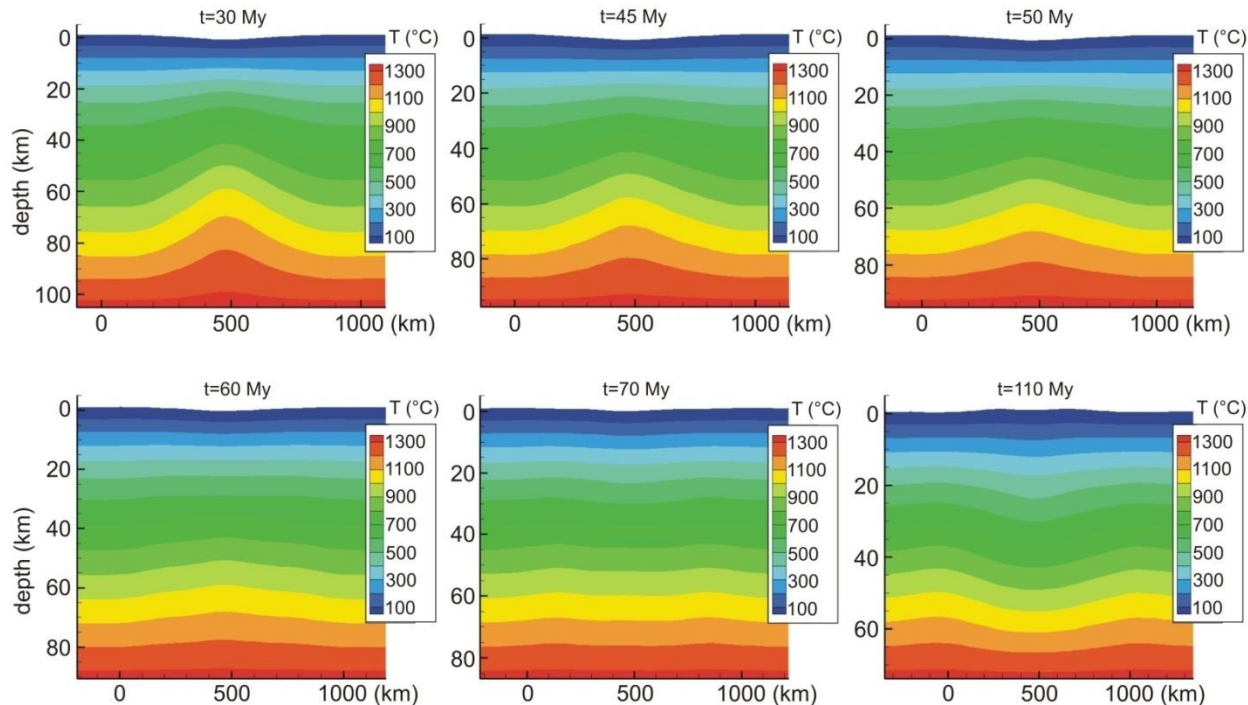

## Slow extension (6 mm/yr)

- As lithosphere stretching proceeds (after 30 Myr),  $T$  begins to decrease with time due to the efficiency of conductive cooling at slow strain rates.
- Mantle upwelling in the zone of initial thinning ceases and the lithosphere cools as  $T$  on both sides of the central rift increase.
- The locus of thinning shifts to both sides of the first rift basin, which does not thin further as stretching continues.

# Fast rifting vs slow extension: crustal thinning

**Fast extension**  
(16 mm/yr)

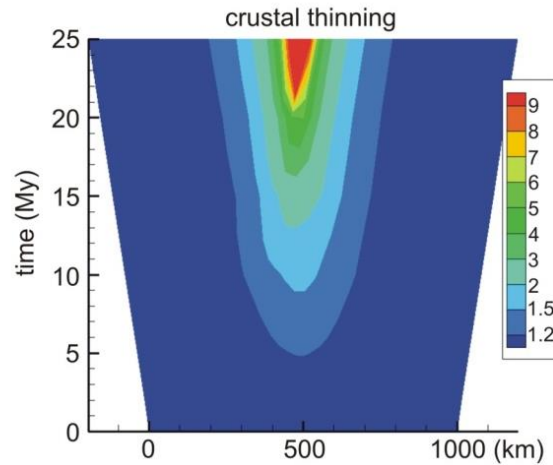

**Slow extension**  
(6 mm/yr)

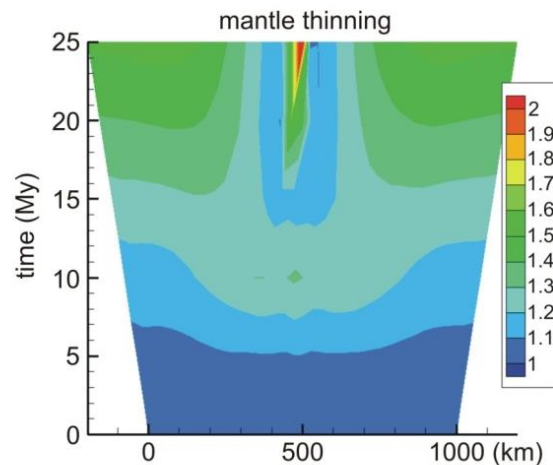
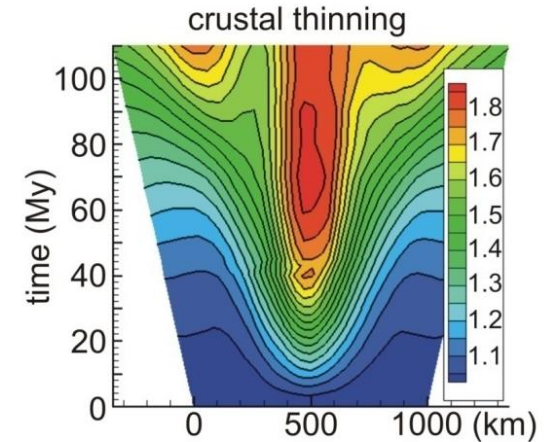

- Rift migration may produce a region of rifting that is wider than lithosphere thickness.
- After 65 Myr mantle thinning factor decreases in the central part of the rift, as mantle upraises at the sites.

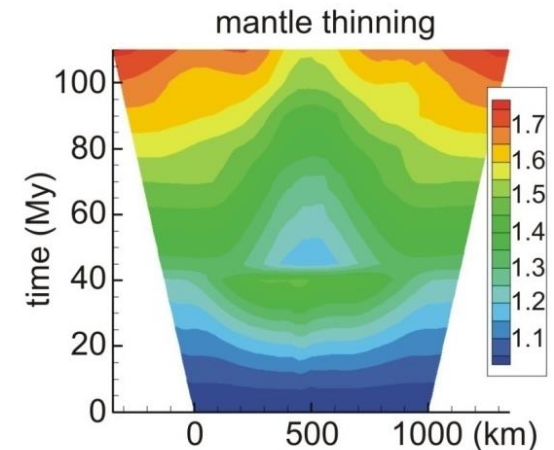

↳ Thinning remains localized: break up

↳ Thinning distributed: rift migration

# Evolution of lithospheric strength

## Fast rifting

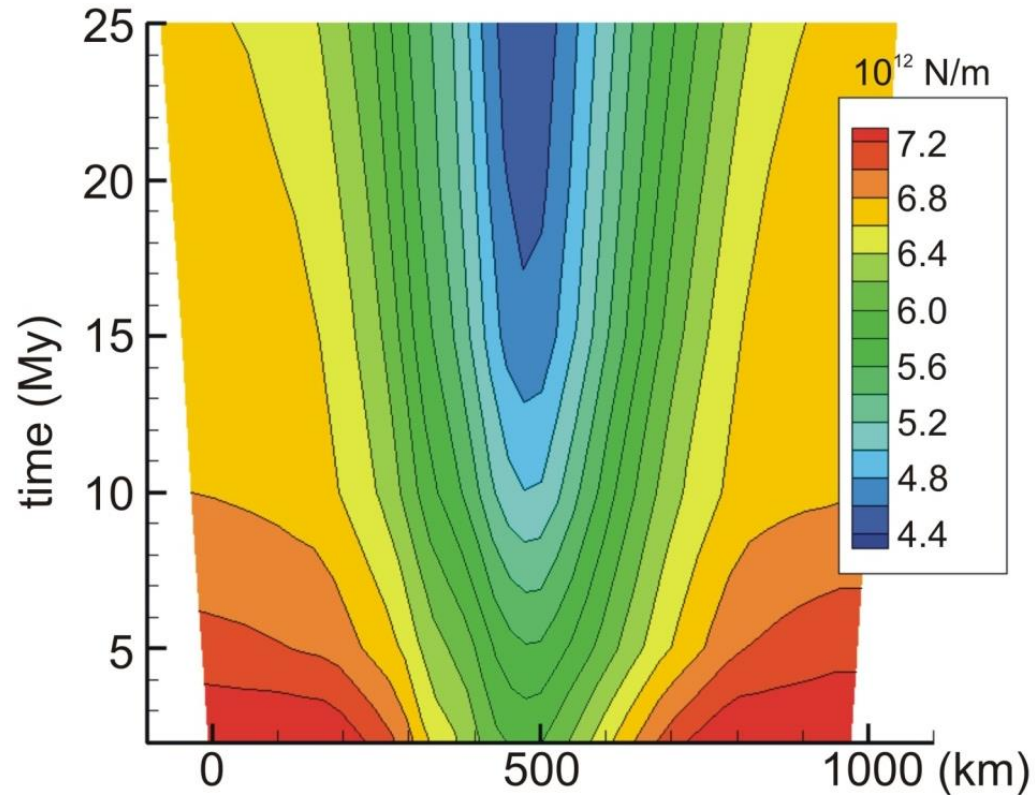

Increasing weakening of the rift zone → Break up

## Slow extension

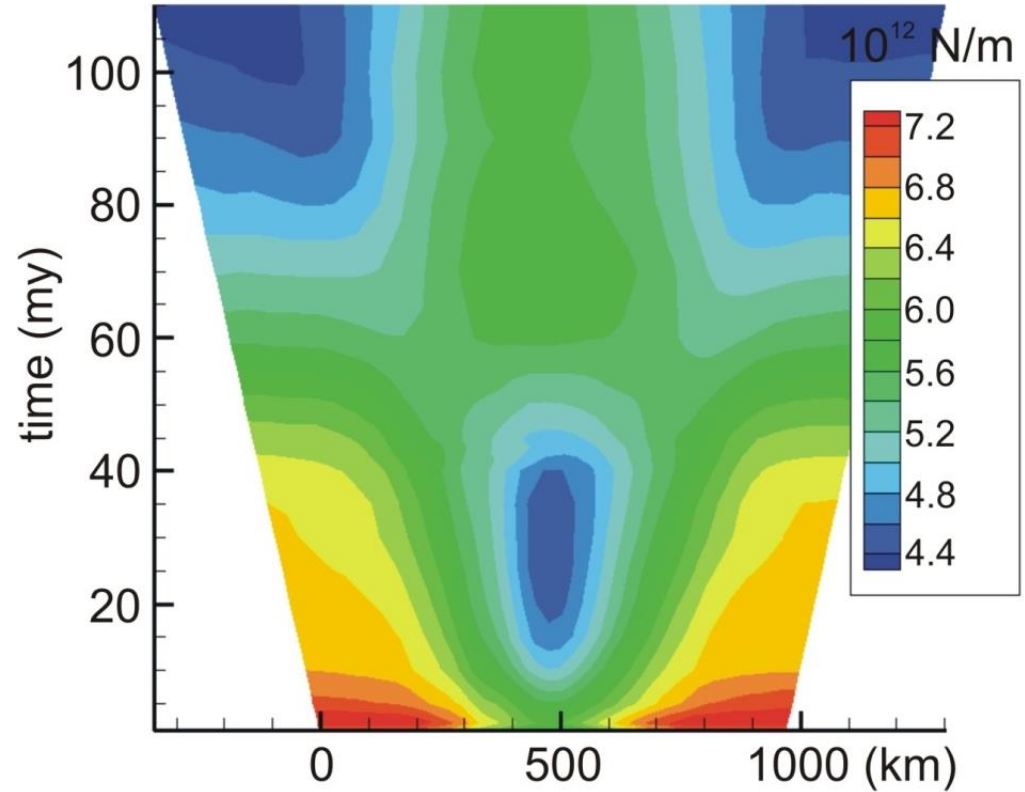

Lateral migration of rift zone and healing of initial rift

Slow delocalization and formation of wide rifts composed of multiple rift basins occurs at slow strain rates

## Rift Duration

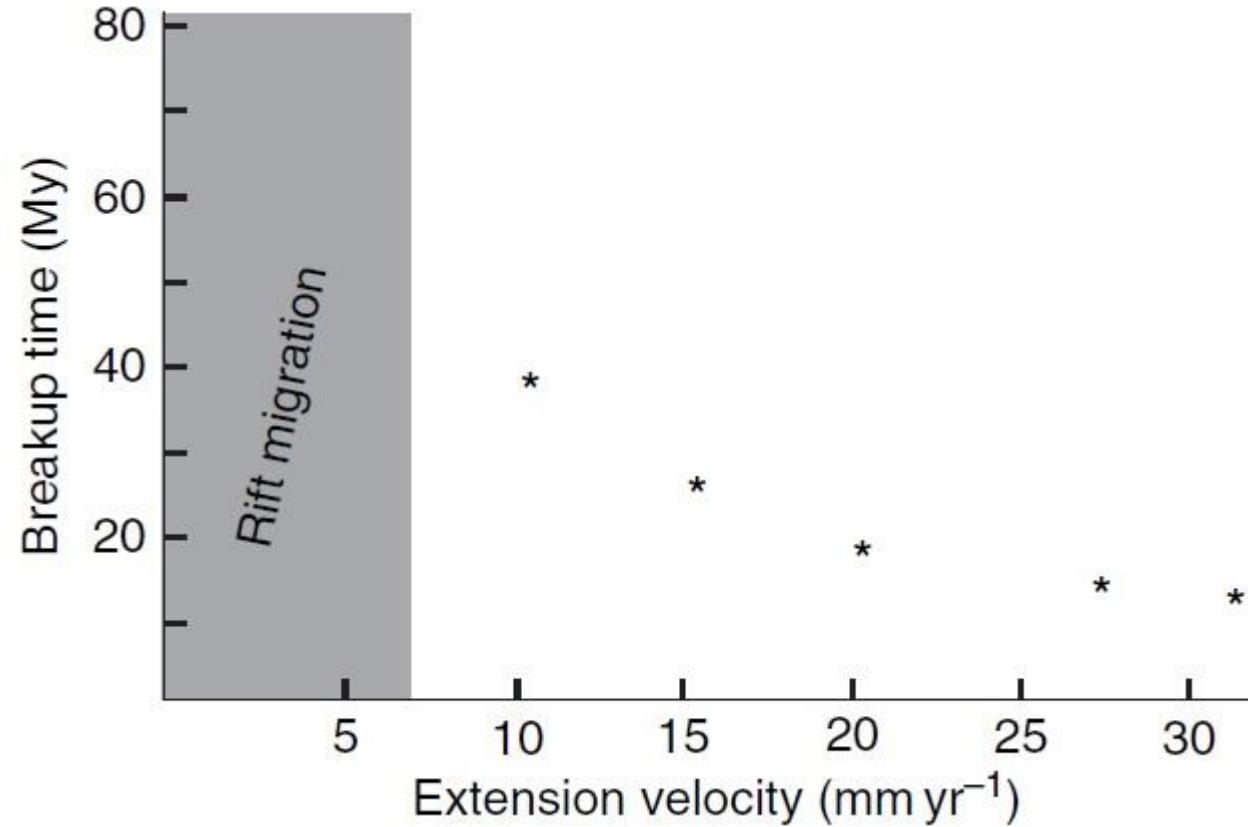

Van Wijk and Cloetingh, 2002, EPSL, 198

- Rifting at larger extension rates eventually results in breakup, while at lower rates syn-tectonic cooling prevails causing rift migration before breakup is achieved.



# Boundary Conditions for Lithospheric Stretching

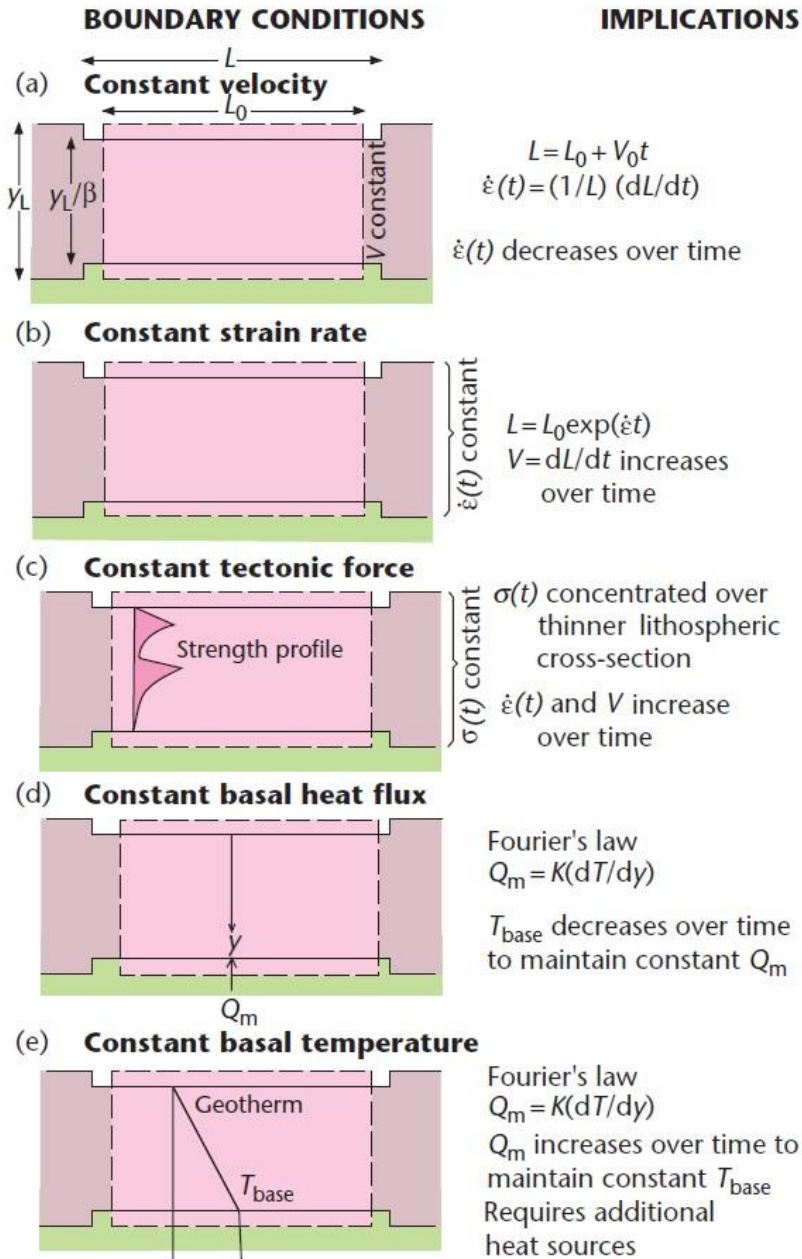

**1. Constant velocity boundary condition:** if  $L_0$  is the initial width and  $v_0$  is the initial (constant) extension velocity, the width of the extending zone after time  $t$  is:

$$L = L_0 + v_0 t \quad \text{Extensional strain rate: } \dot{\epsilon}(t) = (1/L)(dL/dt)$$

- The extensional strain rate clearly decreases with time for a constant velocity boundary condition.

**2. Constant strain rate boundary condition:** the width of the extending zone must vary in time as:  $L = L_0 \exp(\dot{\epsilon} t)$

and the extension velocity  $dL/dt$  must increase as a function of time.

**3. Constant force boundary condition:** the result of a constant tectonic force boundary condition is to concentrate the stress on a progressively thinner lithosphere.

- Tensile deviatoric stresses would increase with time at the site of lithospheric necking, leading to accelerating strain rate, unless a 'hardening' (cooling) process prevents it.

**4. Constant basal heat flux boundary condition:** if it assumed that there are no additional heat sources in the asthenosphere, the heat flux at the base of the lithosphere can be assumed to be constant as extension proceeds.

- In this case, the thickness of the lithosphere decreases by extension, the temperature at the base of the lithosphere should decrease by the stretching factor  $\beta$  with time.

**5. Constant basal temperature boundary condition:** a constant basal temperature implies that the basal heat flow increases (by a factor  $\beta$ ) through time.



## Strain rate and duration of extension

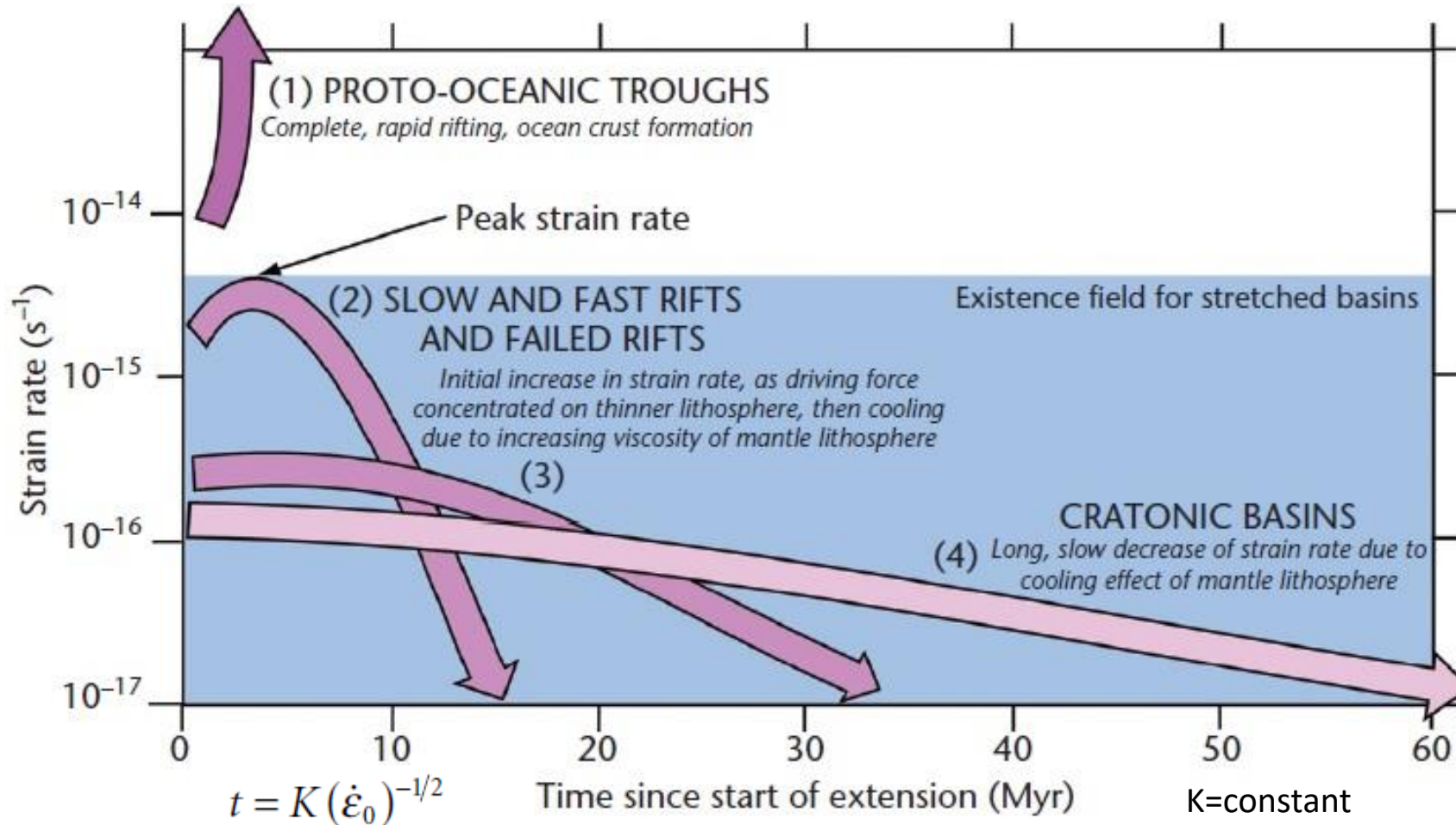

- At high strain rate ( $\geq 10^{-14} s^{-1}$ ), rifting of the lithosphere takes place before any significant heat loss: the strain rate increases through time because the driving force acts on progressively thinner lithosphere.
- At lower initial strain rate ( $10^{-15} s^{-1}$ ), strain rate rises at first because of the same lithospheric thinning effect and reduces as soon as mantle cooling (increase of viscosity) becomes important.
- Time of reduction of strain rates due to the mantle cooling is short for high initial strain rates and viceversa: it depends on the negative inverse square root of the initial strain rate (it takes  $\sim 60$  Myr for the extension to stop for initial strain rate  $< 10^{-16} s^{-1}$ ).

# Mechanisms of rift initiation

## Forces on the continental lithosphere:

- **Horizontal tensile stresses result from:** (1) Plate boundary forces and (2) Potential energy differences arising from buoyancy contrasts in the continental lithosphere, (3) thermal buoyancy forces due to asthenospheric upwellings (4) Shear stresses at the base of the lithosphere (occurring above a divergent flow of a convection cell).

Tectonic forces available for rifting are in the range  $3-5 \times 10^{12} \text{ Nm}^{-1}$

## Deformation styles:

- **At any depth, deviatoric tension can cause yielding by faulting, ductile flow, or dike intrusion, depending on which of these processes requires the least amount of stress:** if a magma source is available, then the intrusion of basalt in the form of vertical dikes could allow break-up of the lithosphere at much lower stress levels than is possible without the diking, while high Moho temperatures ( $\sim 700 \text{ }^\circ\text{C}$ ) increase the importance of gravitational forces.
- **The location and distribution of strain at the start of rifting may be influenced by the presence of pre-existing weaknesses in the lithosphere:** Contrasts in lithospheric thickness or in the strength and temperature of the lithosphere may localize strain or control the orientations of rifts (e.g., Tanzania Craton alters the rift geometry).

# Effects of buoyancy force on the rifts evolution

- Effects of thermal buoyancy forces: promotion of horizontal extension.
- Effects of buoyancy forces caused by difference in elevation and crustal thickness variations: where the crust is thick, buoyancy forces assist the distant force to promote extension, but where the crust is thin buoyancy forces resist extension.

## Buoyancy forces vs Plate boundary forces Argand Number ( $Ar$ )

$$Ar = \rho g h^2 / \mu V_p$$

$Ar \ll 1$  plate boundary forces prevail  
 $Ar \gg 1$  buoyancy forces prevail

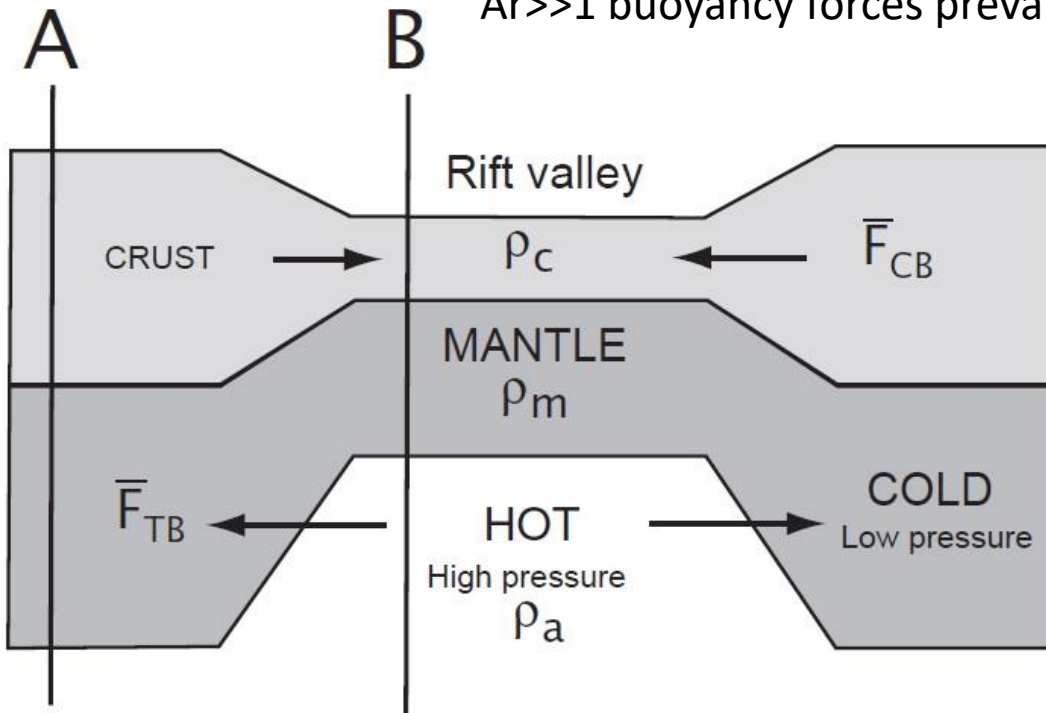

$h$ =thickness of the plate  
 $V_p$ =horizontal velocity  
 $\mu$ =viscosity

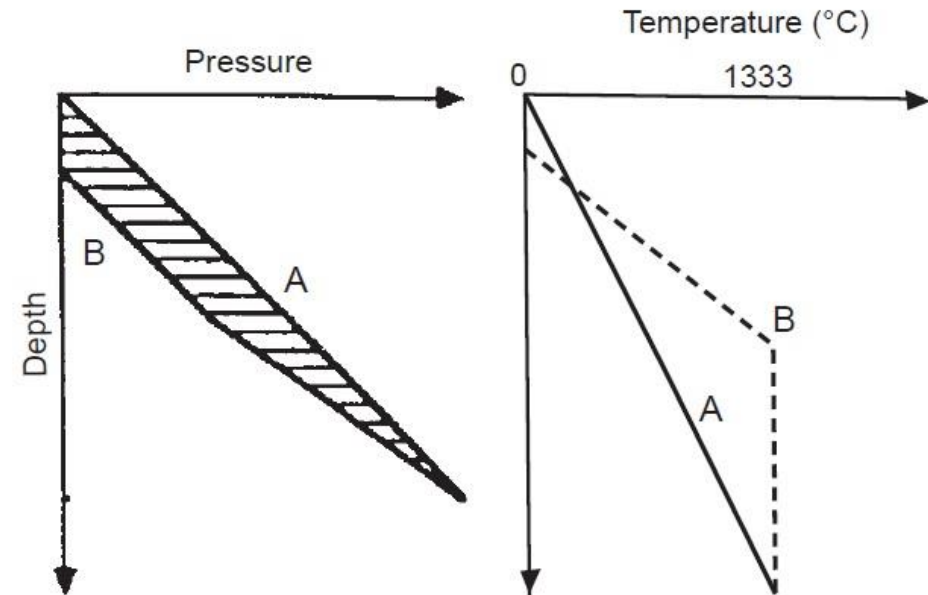

Crustal thinning lowers surface elevation, placing the rift into compression and causing delocalization of strain

# Basin Inversion

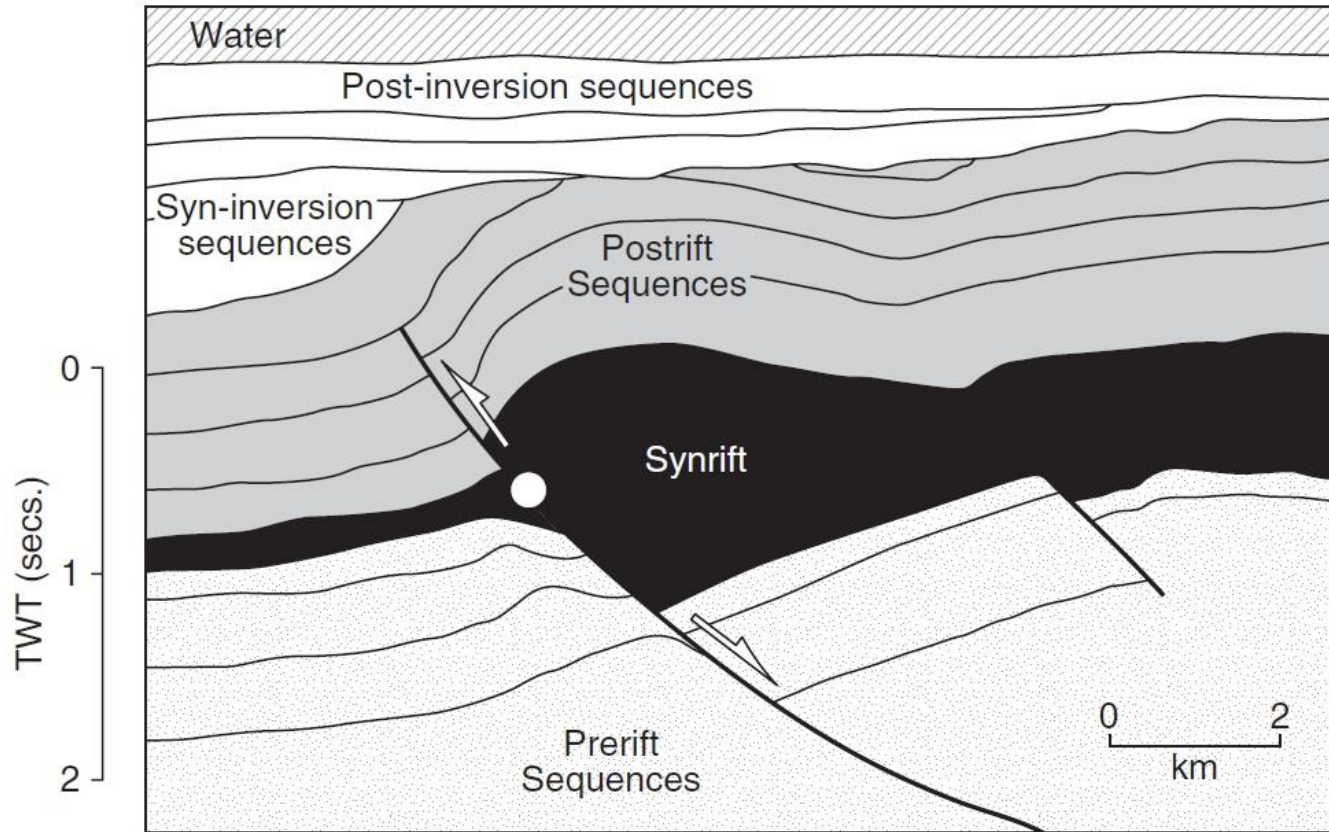

**An inversion of a sedimentary basin can be identified from:**

- A reactivated fault along which the net displacement changes from normal at its base to reverse near its top (presence of a null point).
- The uplift and folding of synrift and postrift sediments.

White point=null point. A null point occurs where the net displacement along the fault is zero and divides the area displaying reverse displacement from that displaying normal displacement.



# Effects of crustal thickness and lithospheric thermal conditions on the rifts evolution

(a) Narrow rift mode

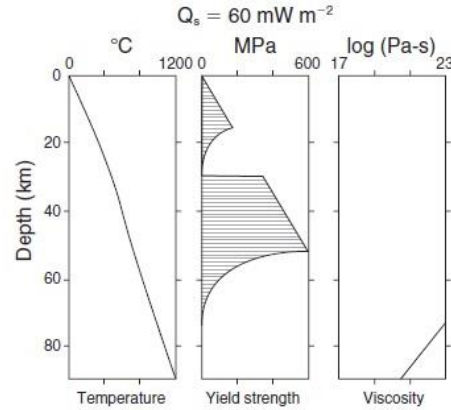
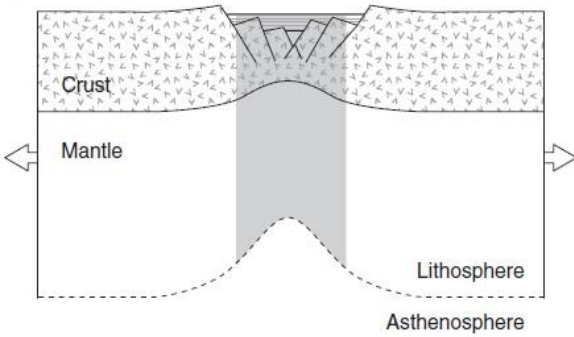

(b) Wide rift mode

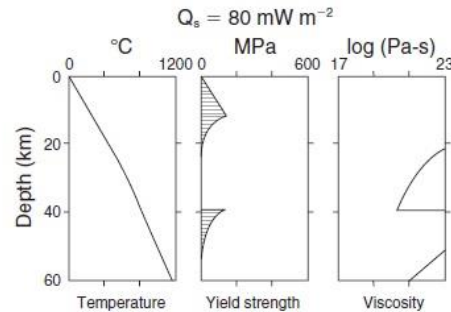
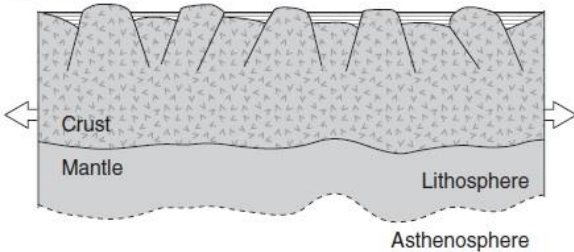

(c) Core complex mode

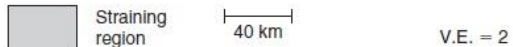
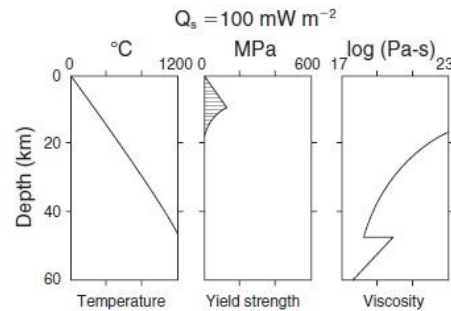
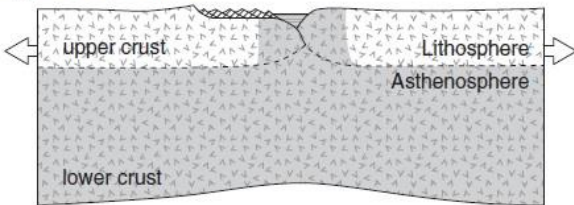

- Where the crust is initially thin and cool and the mantle lithosphere is relatively thick, the overall strength (the effective viscosity) of the lithosphere remains relatively high under conditions of constant strain rate.
- Narrow rifts result because changes in the strength and thermal buoyancy forces that accompany lithospheric stretching dominate the force balance, causing extensional strains to remain localized.
- Where the crust is initially thick and hot and the mantle lithosphere is relatively thin, the overall strength of the lithosphere remains relatively low.
- In this case, crustal buoyancy forces dominate, resulting in strain delocalization and the formation of wide zones of rifting.
- Where the hot, ductile lower crust flows, the effects of crustal buoyancy are alleviated and the zone of crustal thinning can remain fixed (since high strains build up near the surface), producing core complex-mode extension.

- Shifts in the mode of extension are expected as continental rifts evolve through time (thermal diffusion becomes efficient after a long period of time) and balance of thermal and crustal forces within lithosphere changes.

# Effects of the crustal rheologies and $T$ on rift morphology

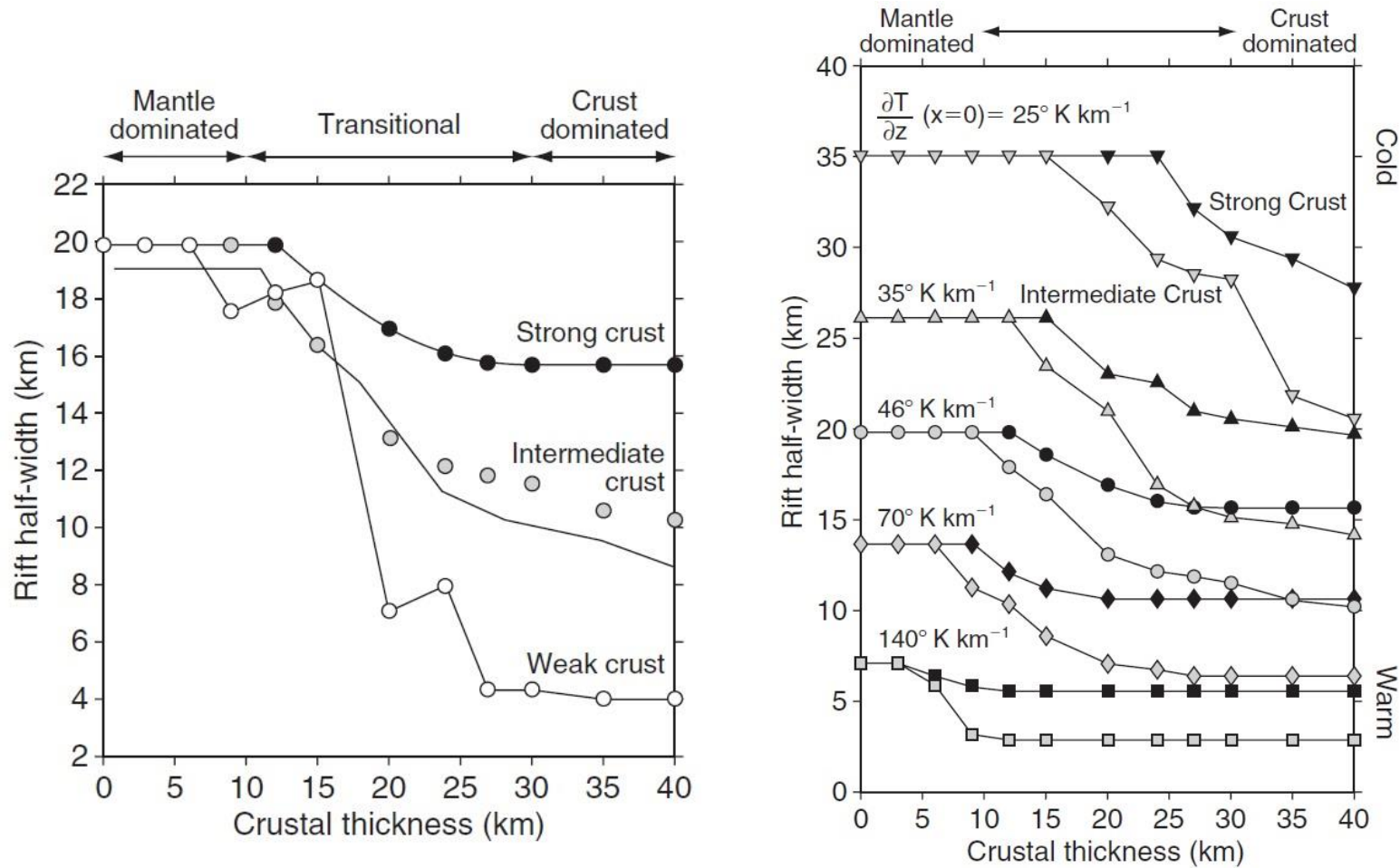

- When crustal thickness is small (~10 km), so that no ductile layer develops in the lower crust, deformation occurs mostly in the mantle and the width of the rift is controlled primarily by the vertical geothermal gradient.
- When the crustal thickness is large (~30 km) the stress accumulation in the upper crust becomes  $\gg$  than the stress accumulation in the upper mantle. In these cases the deformation becomes crust-dominated and the width of the rift is a function of both crustal rheology and vertical geothermal gradient.



# Effects of the sedimentary cover on the long-term subsidence and flexural strength

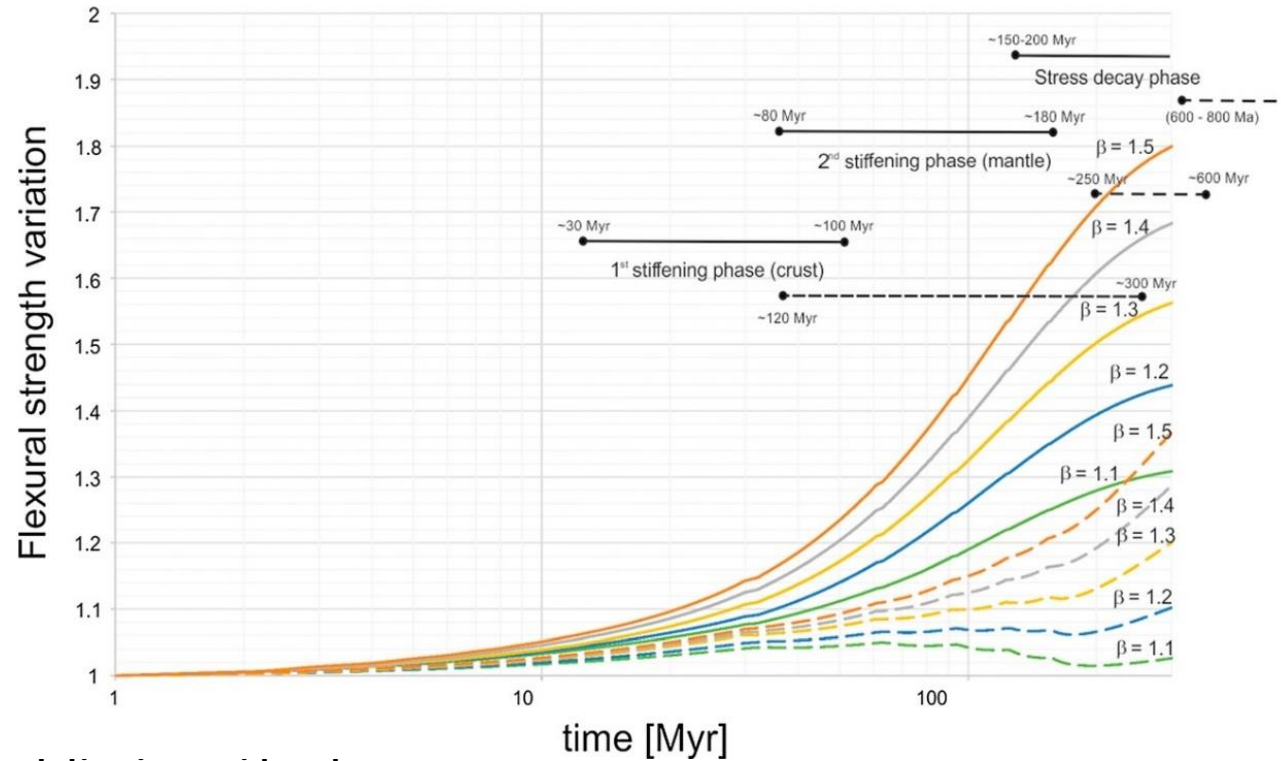
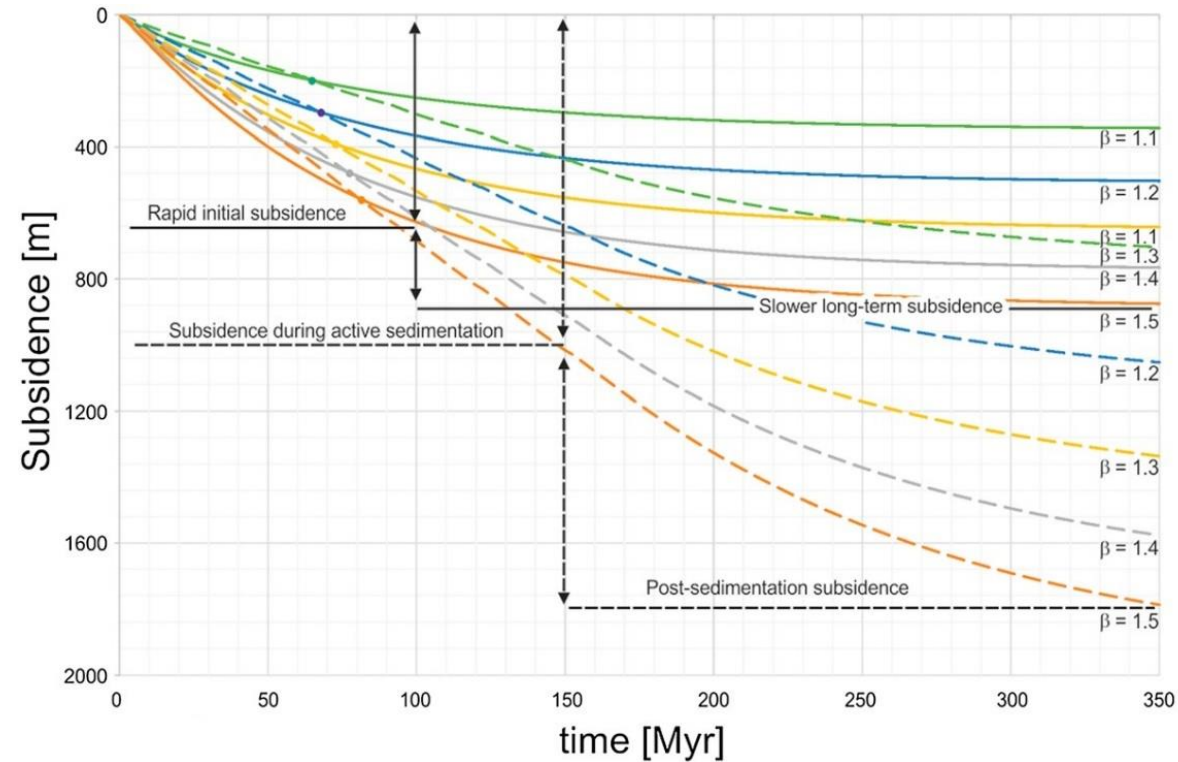

Cacace and Scheck-Wenderoth, 2016, JGR, 121

**Dashed curves: sedimentation is considered**  
**Continuous curves: sediments are neglected**

- Thermal subsidence curves show an exponential decay in time, similar to the pattern predicted by a plate-cooling model.
- The presence of sediments induced a prolonged in time and slower thermal subsidence, thus resembling the first-order characteristics as observed in intracontinental settings and results in overall relatively smaller flexural rigidities.
- The presence of the sedimentary cover affects the subsidence pattern even long after active sedimentation ceases and weakens the lithosphere as a result of thermal blanketing that leads to increased lithospheric temperature and possible decoupling at lower crustal level.
- Sedimentation delays lithospheric stiffening, causing differences in the flexural strength of the plate under loading and unloading conditions.

# Duration of rift stages

## Successful Rifts

Ziegler and Cloetingh, 2013

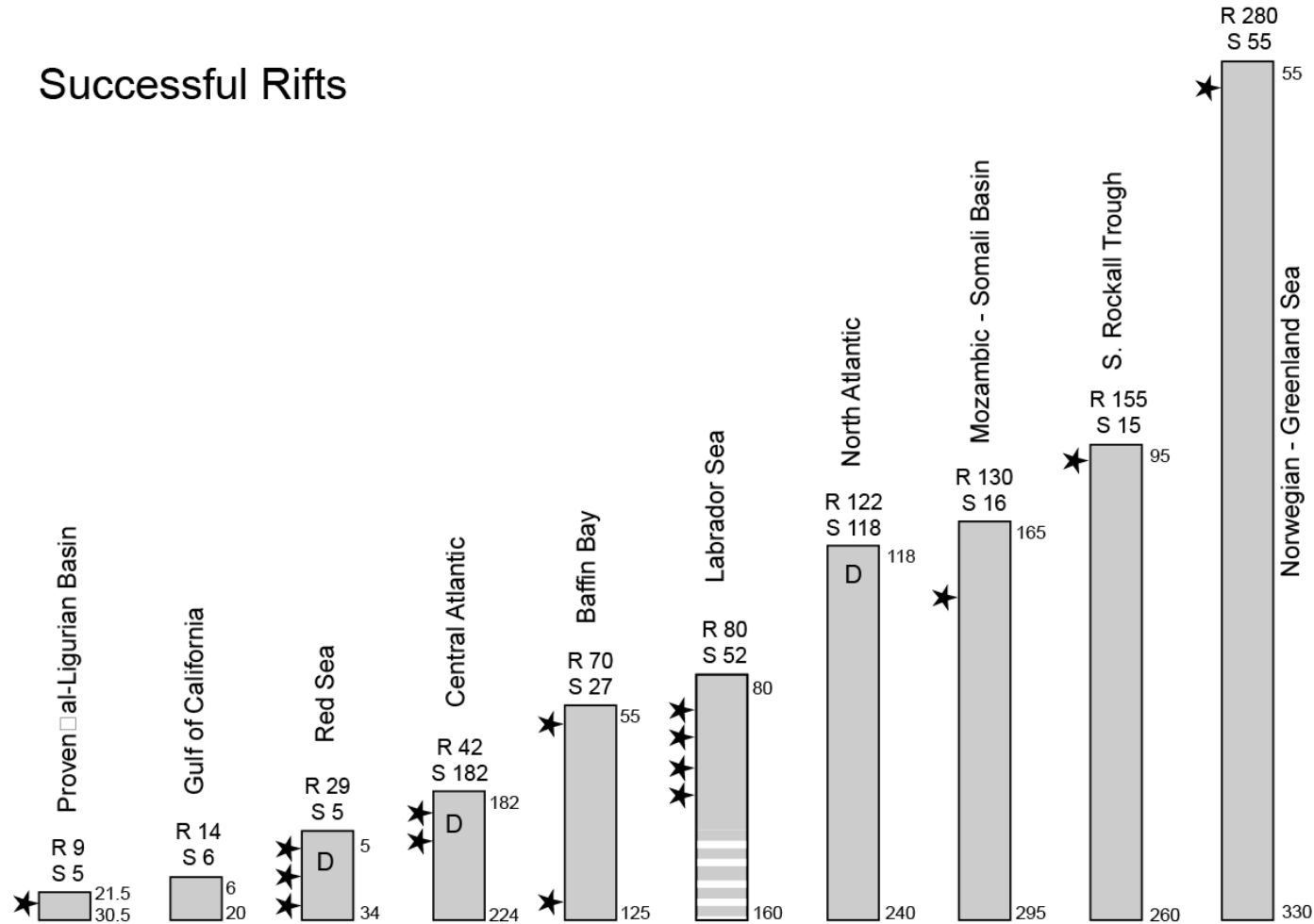

- Duration of rifting stage depends on the persistence of the controlling stress field, no correlation with the duration of the rifting stage ( $R$ ), which can be superimposed on orogenic belts and on cratonic lithosphere.
- Time required to achieve crustal separation is a function of the lithospheric strength, magnitude and persistence of the extensional stress field, constraints on lateral movements of the diverging blocks.
- Crustal heterogeneity does not influence the rift duration, but influence localization and distribution of crustal strain.

# Failed Rifts

Ziegler and Cloetingh, 2013

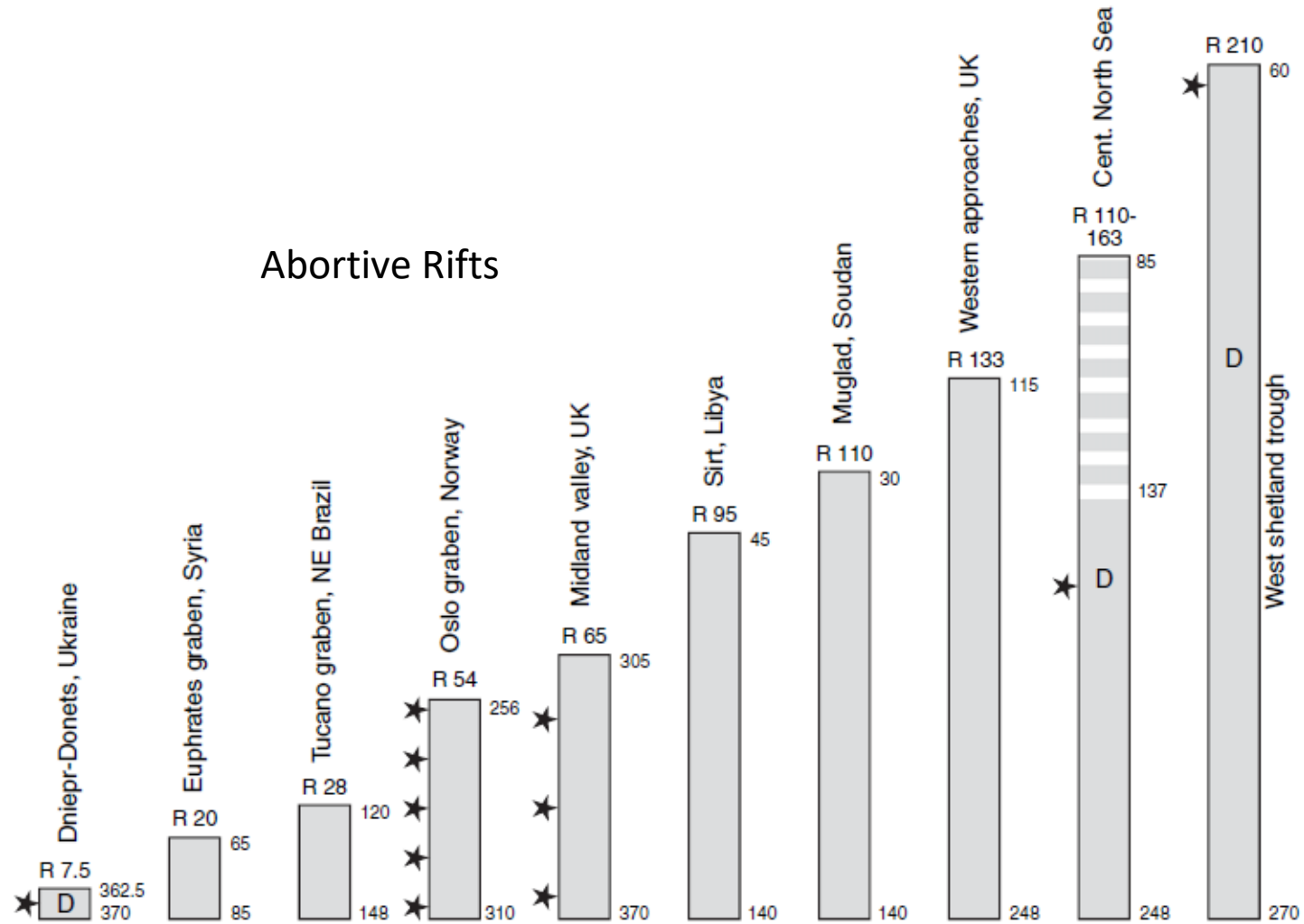

- Reason of rift failure: (1) Rift orientation, (2) competence between two rift system, (3) rheology (hardening), (4) change of the stress field from extension to compression.
- After that a rift fails crust thickens, the sediments deposited start to be eroded and the extensional faults become inactive before reversing.

# Total Subsidence Evolution

$$\phi = \phi_0 e^{-cz} \quad \int_0^{L_0} (1 - \phi) dz = \int_{z_L}^{z_L+L} (1 - \phi) dz \quad L_0 + \frac{\phi_0}{c} e^{(-cz_0)} (e^{(-cL_0)} - 1) = L + \frac{\phi_0}{c} e^{(-cz_L)} (e^{(-cL)} - 1) \quad L_0 = L \frac{(1 - \phi)}{1 - \phi_0}$$

- To estimate the original thickness of a layer  $L_0$  from that measured for this layer in the field,  $L$  (assuming compaction), we must solve an integral.
- Assuming that the thickness was only changed by changing the porosity (no cementation or dissolution occurred) the rock volume without the pore space ( $1 - \phi_0$ ) remains a constant, regardless of the depth reached by the upper surface ( $L$  is at a depth  $z = z_L$  or  $z = 0$ ).
- The same equations can be applied to determine the thickness of a layer at any other stage of the decompaction process  $L^*$  and not only the fully decompacted thickness  $L_0$  (It is needed to use the porosity and depth at the right stage of the analysis  $\phi^*$  instead of the original porosity  $\phi_0$ ).

**Note:** If the water depth in a sedimentary basin changes over time, then the water depth (usually constrained by sedimentary structures and fossil records) must be added to the subsidence curve to obtain the subsidence evolution relative to a fixed reference level.

**Sedimentation with compaction and sedimentation rate decreasing from  $t_1$  to  $t_4$**

**Sedimentation with no compaction and constant sedimentation rate**

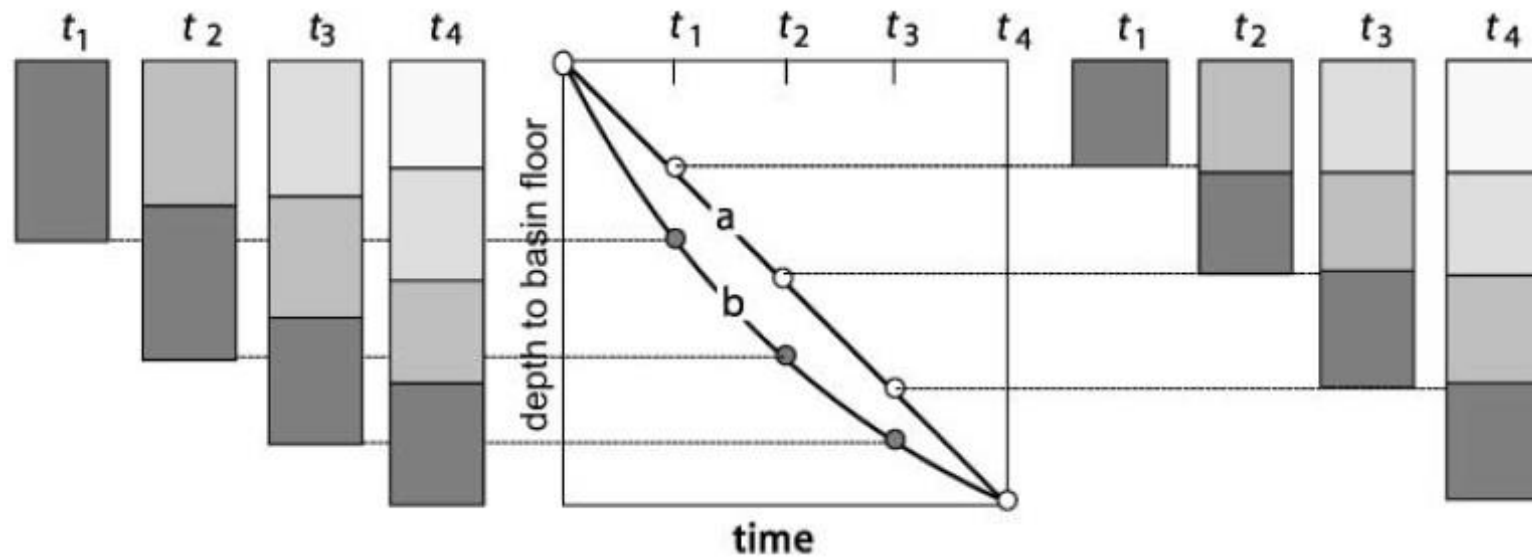

# Tectonic Subsidence

- The *tectonic* contribution to subsidence is obtained by subtracting from the *total* subsidence the *sedimentary loading* through backstripping analysis.
- Backstripping consists in successively removal of layers from the sedimentary column of a basin. During each step of removal, the hypothetical depth of the basin floor *without* being loaded is calculated.

## Backstripping assuming hydrostatic isostasy:

Example: a marine basin was created by a single tectonic process, which started when the surface was at sea level and caused a tectonic subsidence of the amount  $z_T$ . Today, the basin is filled by water of the depth  $w$  and a single sedimentary layer of thickness  $L$  and density  $\rho_L$ . The tectonic subsidence ( $z_T$ ) can be written as the sum of the water depth at present  $w$  and the basin depth change due to sedimentary loading:  $z_T = w + z_s$

The depth of the basin floor prior to the sedimentary fill below sea level is estimated from isostatic balance (assuming that no variation of crustal thickness occurred during sedimentation):

$$z_s = L \left( \frac{\rho_m - \rho_L}{\rho_m - \rho_w} \right)$$

without change in the sea level

$$z_T = L \left( \frac{\rho_m - \rho_L}{\rho_m - \rho_w} \right) + w - \Delta SL \frac{\rho_m}{\rho_m - \rho_w}$$

with change in the sea level  $\Delta SL$

$$\Delta SL = \left( \frac{\rho_m - \rho_w}{\rho_m} \right) (h_2 - h_1)$$

$h_1$ =initial water depth  
 $h_2$ =sea-level rise

$$\rho_L = \phi \rho_w + (1 - \phi) \rho_g$$

$\rho_g$ =grain density,  $\rho_w$ = pore fluid density,  $\rho_c$ =crustal density,  $\rho_m$ =mantle density

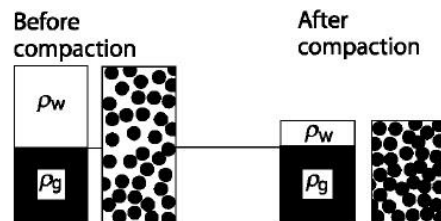

- The complete evolution of tectonic subsidence is obtained by stepwise removal of the top layer at any one stage during the analysis.
- For the remaining column mean densities and thicknesses must be used at each time step.
- The value  $z_T$  is the tectonic amount of subsidence during sedimentation of the top most layer only.

$$L^* = \sum_{j=1}^i L_j$$

$$\rho_{L^*} = \frac{\sum_{j=1}^i L_j (\phi_j \rho_w + (1 - \phi_j) \rho_g)}{L^*}$$

$L^*$  = thickness and  $\rho^*$ = density of the entire remaining sedimentary column after removal of the top layer  $i$

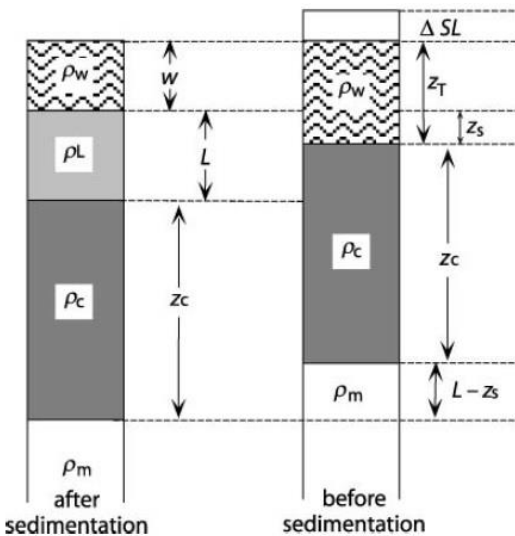

# MODES OF RIFTING

Lithosphere from various areas can differ substantially as to their thickness, compositions, rate of extension, etc.

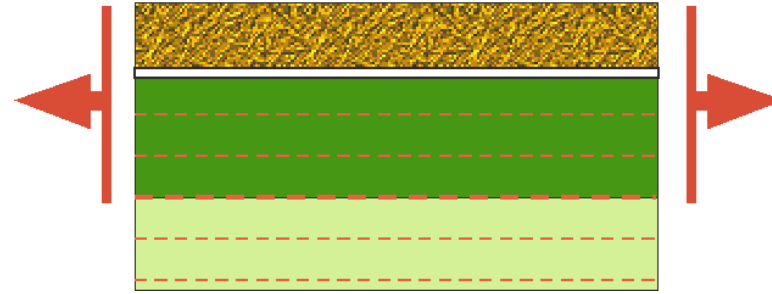

Depending on a number of factors, the result of the extension can be tectonically very different.

## NARROW RIFTS

- Discrete continental rifts located on normal thickness crust (e.g., the Rhine Graben, Baikal Rift, Rio Grande Rift) extend slowly ( $<1 \text{ mm yr}^{-1}$ ) over long periods of time (10–>30 Myr), with low total extensional strain (generally  $<10 \text{ km}$ ).
- Master fault angles are steep (45–70 degrees), while seismicity suggests that crustal extension takes place down to mid-crustal levels.

## WIDE RIFT

- Supra-detachment basins occur within wide extended domains with previously thickened crust. They typically extend quickly ( $<20 \text{ mm yr}^{-1}$ ) over short periods of time (5–12 Myr) with a high amount of total extensional strain (10–80 km).
- Master faults (detachments) are shallow in dip (10 to 30 degrees), but may have originated at higher angles.



# MODES OF RIFTING

## NARROW RIFTS

- Are generated by thick, cool, and strong lithosphere
- Are long (>1000 km), narrow (10s of kms) and have mostly steep planar faults
- Examples: Baikal Rift, Eastern Africa Rift system, Rhine Graben
- Large lateral gradient in topography and crustal thickness

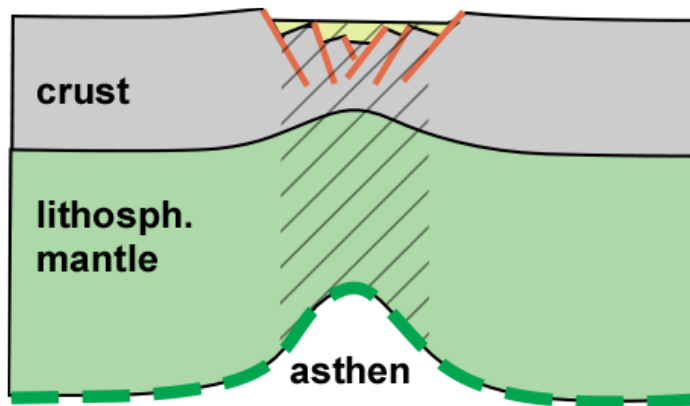

## CORE COMPLEXES

- Local zones of exhumed ductile lower crust. Intracontinental extensional zones controlled by one major low-angle normal fault
- Very strong footwall exhumation
  - very strong extension
  - little crustal thinning

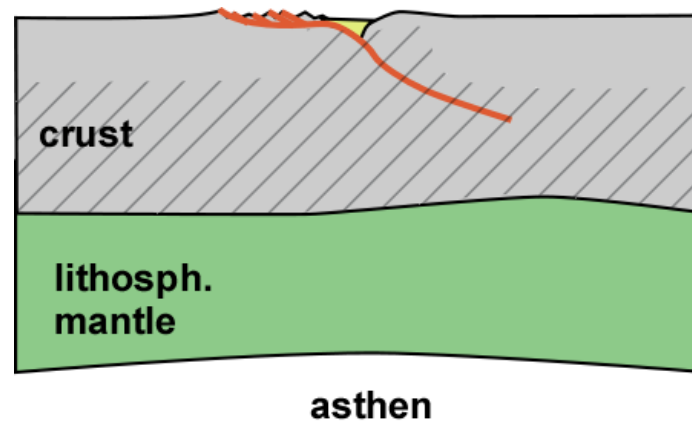

## WIDE RIFTS

- Are generated by thin, hot, and weak lithosphere, which undergone strong extension
- 100s kms wide and have mostly listric faults
- generalized subsidence (not concentrated in the central part)
- Small lateral gradient in crustal thickness

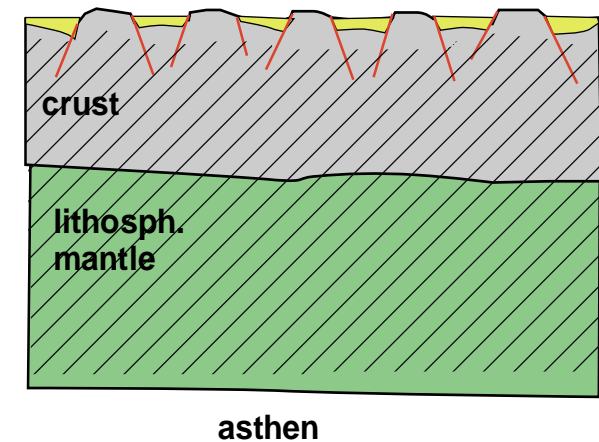

# Narrow Rift

(e.g., Rhinegraben, East African rift, Baikal rift, Rio Grande rift)

## Key Features

- They are characterized by relatively small amounts of extension ( $\beta < 2$ ) and may evolve into passive margins.
- **Asymmetric rift basins flanked by normal faults:** the majority of the strain is accommodated along border faults having high angles (45-70 degree).
- **Extension occurs slow** (<1 mm/yr) **over long periods of time** (10-30 Myr).
- **Shallow seismicity and regional tensional stress:** along rift axis seismicity is confined in the uppermost 12-15 km (thin seismogenic layer).
- **Local crustal thinning modified by magmatic activity:** Igneous intrusions directly below the rifts or the rifts flanks causing anomalous high velocity, seismic reflectivity, and gravity anomaly.
- **Anomalous high heat flow and low seismic velocity:** 70-90 mWm<sup>-2</sup> suggesting temperature gradients of 50-100 C°/km. Low seismic velocity can be localized only in the shallow mantle (< 160 km), like in the Rio Grande Rift or extended to large depth and connected to a broad zone of anomalously hot mantle, like in the East African Rift.

# Lithospheric structure of narrow rifts

## East African Rift

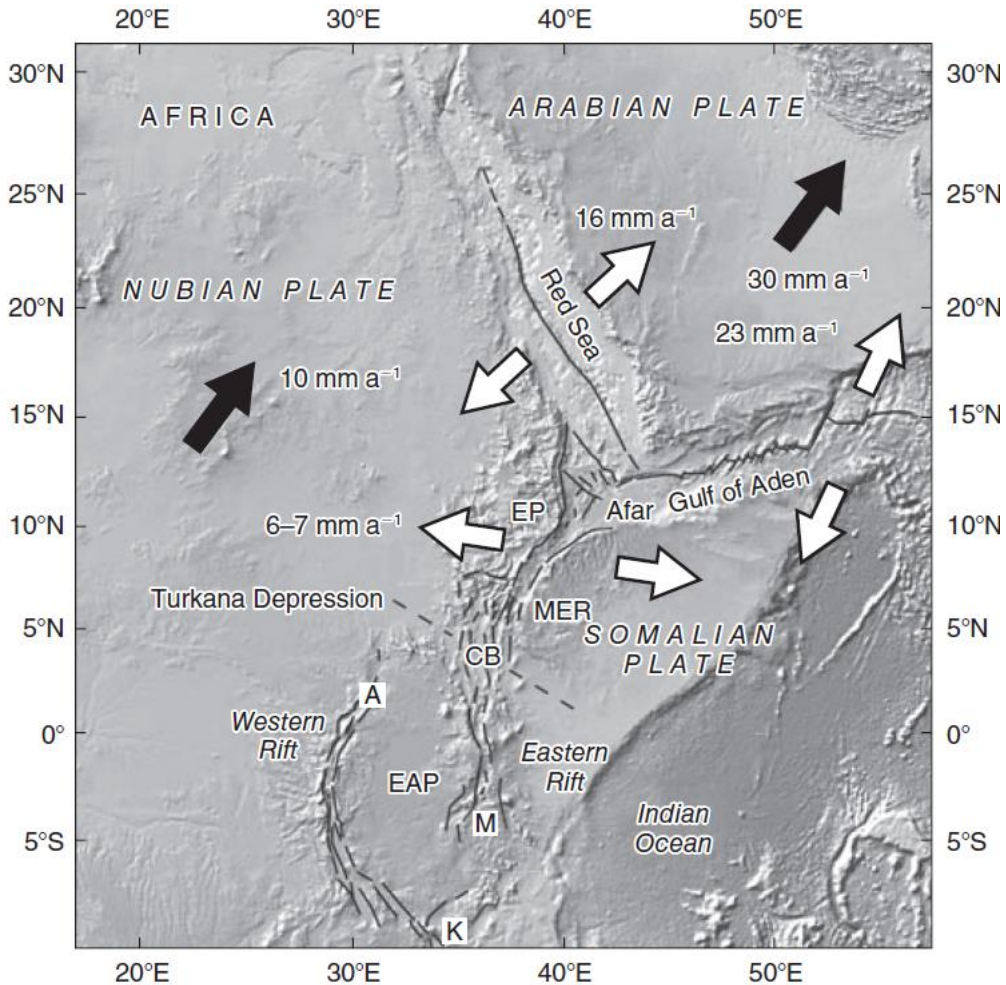

- Southwest of the Afar triple junction, the Nubian and Somalian plates are moving apart at a rate of  $\sim 6\text{--}7 \text{ mm yr}^{-1}$ , producing a discrete rift segments of variable age: Western Rift, the Eastern Rift, the Main Ethiopian Rift, and the Afar Depression.
- Some of these rifts (Kenya, Ethiopia, and Afar) are characterized by voluminous magmatism and the eruption of continental flood basalts, while others (Western Rift) are magma starved and characterized by very small volumes of volcanic rock.

**White arrows** = relative plate velocities.

**Black arrows** = absolute plate motion in a geodetic, no-net-rotation (NNR) framework.

**M**, Manyara basin (from Foster et al., 1997); **K**, Karonga basin (from van der Beek et al., 1998); **A**, Albert basin (from Upcott et al., 1996); **CB**, Chew Bahir basin (from Ebinger & Ibrahim, 1994); **EAP**, East African Plateau; **EP**, Ethiopian Plateau; **MER**, Main Ethiopian rift; **L**, the length of the border fault.



# Lithospheric structure of narrow rifts

## East African Rift

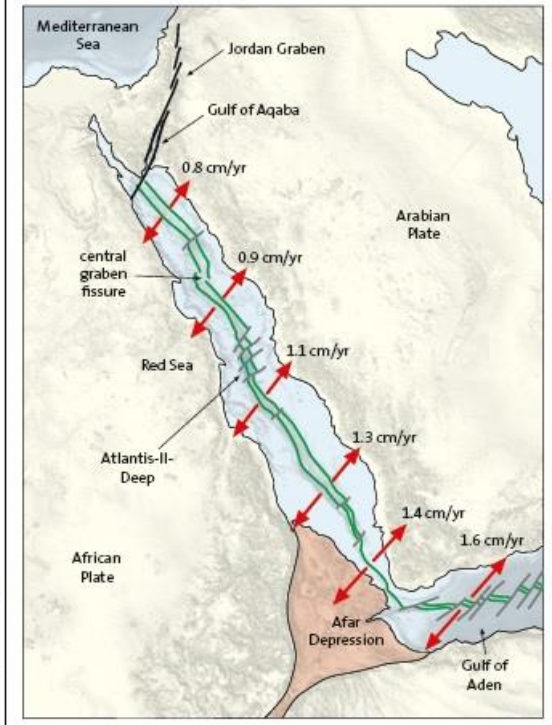
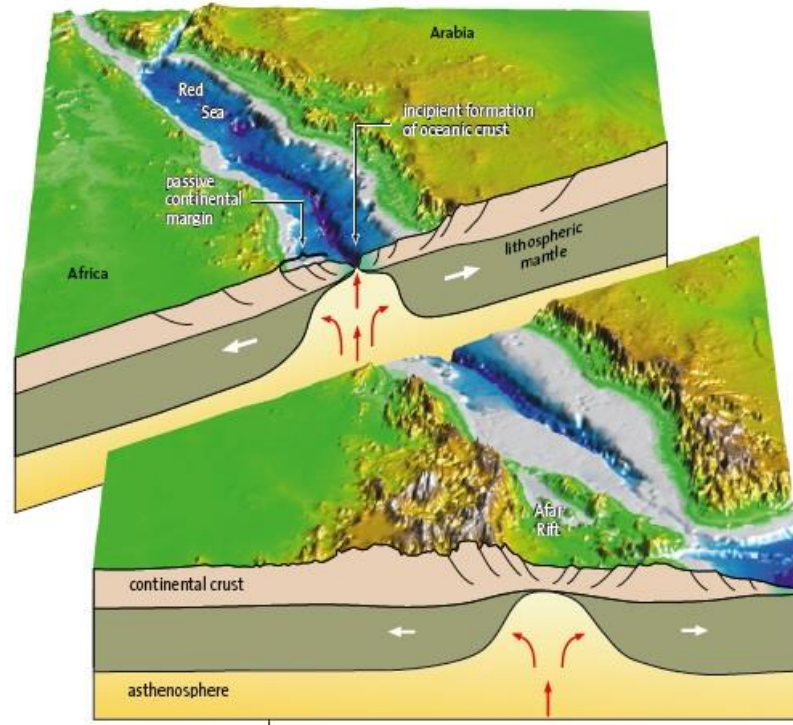
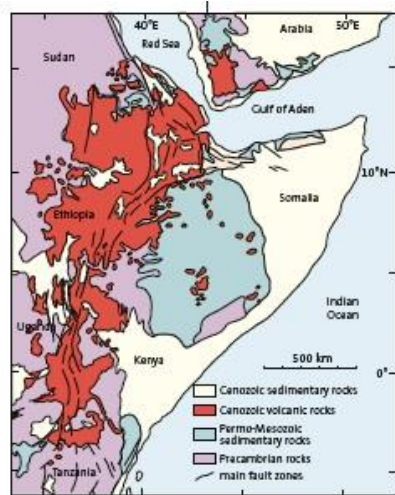
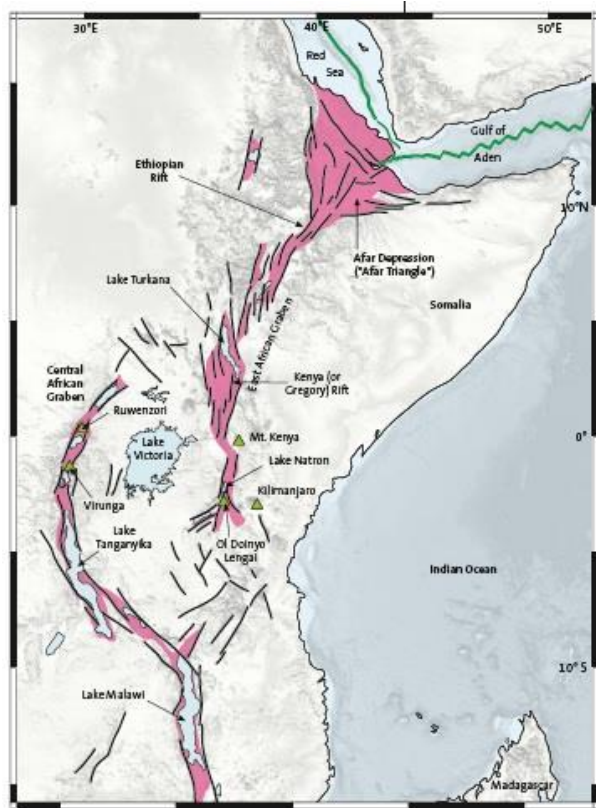

- The average extension rates in the East African graben system, 0.4–1 mm/yr.
- Total crustal extension in Ethiopia approaches 60 km, but in contrast, much lower rates, 35–40 km in northern Kenya, 5–10 km in southern Kenya, and less than 5 km in northern Tanzania.
- Sea floor spreading with a rate of 1–2 cm/yr started in the southern Red Sea in the Pliocene at approximately 5 Myr.

# Lithospheric structure of narrow rifts

## East African Rift

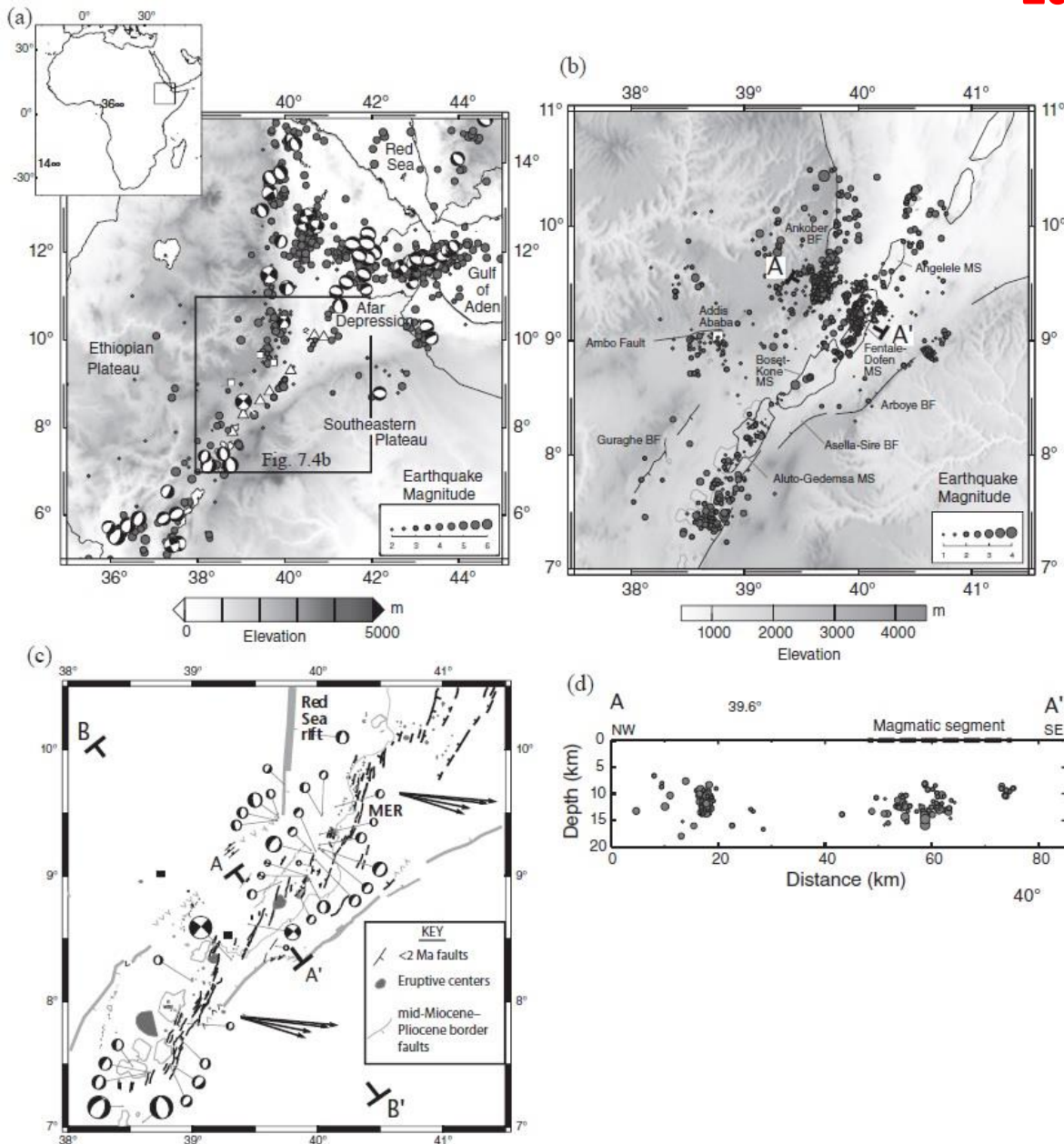

- Earthquakes are confined to the uppermost 12–15 km of the crust, while away from the rift axis, earthquakes may occur to depths of 30 km or more.
- Most of the large earthquakes occur between Afar Depression and the Red Sea. More than 50% of extension across the Main Ethiopian Rift is accommodated aseismically.
- Inside the rift, earthquake clusters parallel faults and volcanic centers. Up to 80% of the total extensional strain is localized within these magmatic segments.
- Earthquakes are concentrated around volcanoes, probably reflecting magma movement in dikes. In the rift flanks, seismic activity may reflect flexure of the crust as well as movement along faults.



# Lithospheric structure of narrow rifts

## East African Rift

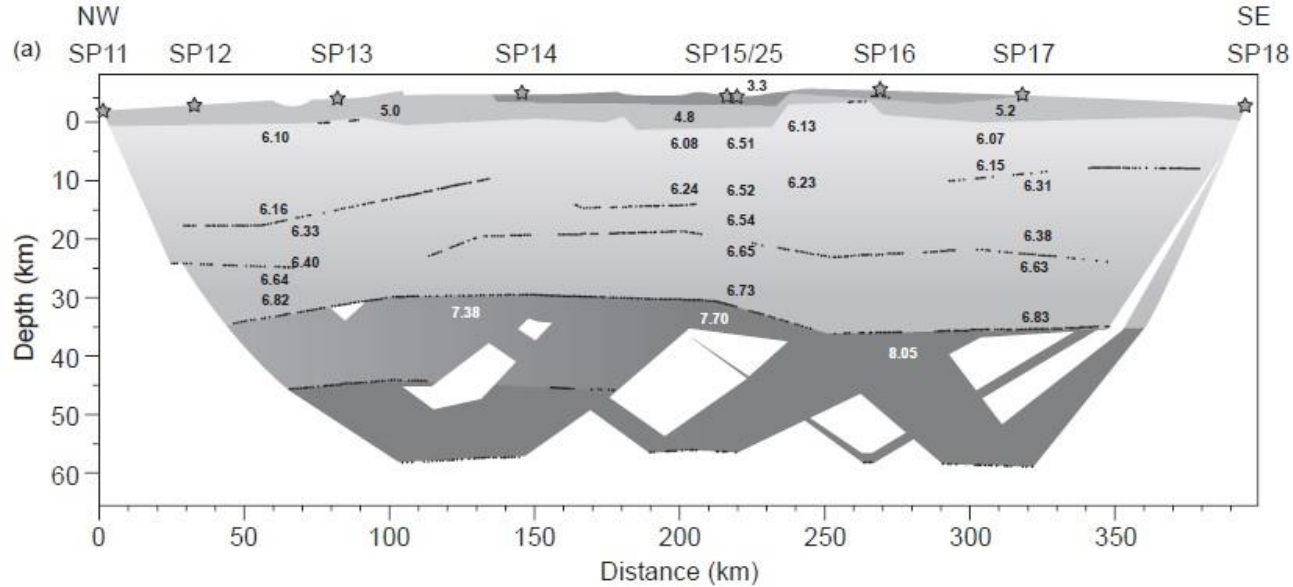

- Continental rifts are characterized by thinning of the crust beneath the rift axis, but crustal thicknesses, like the fault geometries in rift basins, are variable and may be asymmetric.
- In the northern Main Ethiopian Rift, the upper and middle crust are characterized by high conductivity, seismic velocity, and high density, indicating the presence of a mafic intrusion.

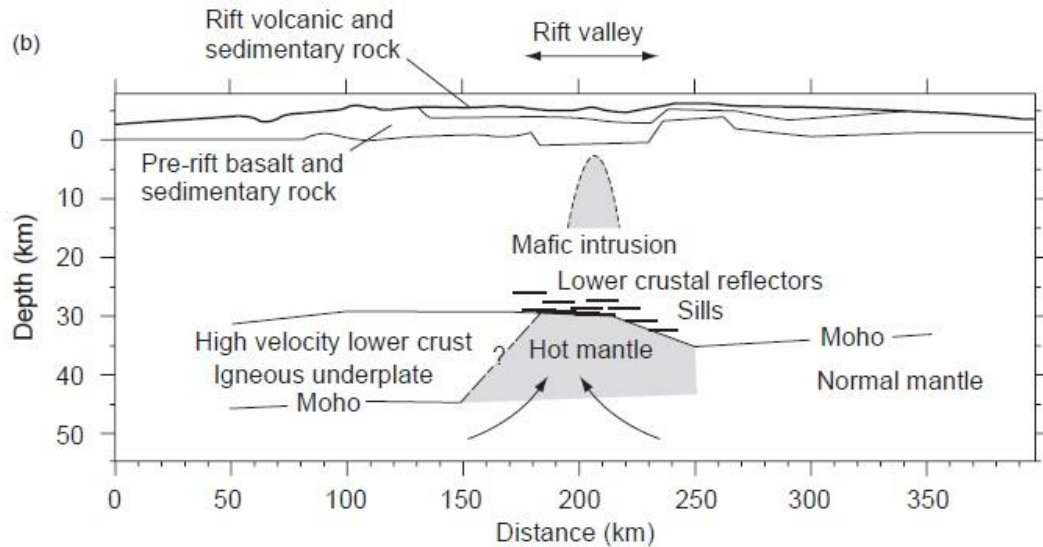

- Pn velocities are 5–10% higher than those outside the rift, due to the presence of mafic intrusions associated with magmatic centers.
- The western flank of the Main Ethiopian rift is underlain by a ~45 km thick crust and displays a ~15 km thick high velocity ( $7.4 \text{ km s}^{-1}$ ) lower crustal layer. This layer is absent from the eastern side, where the crust is some 35 km thick.



# Lithospheric structure of narrow rifts

## East African Rift

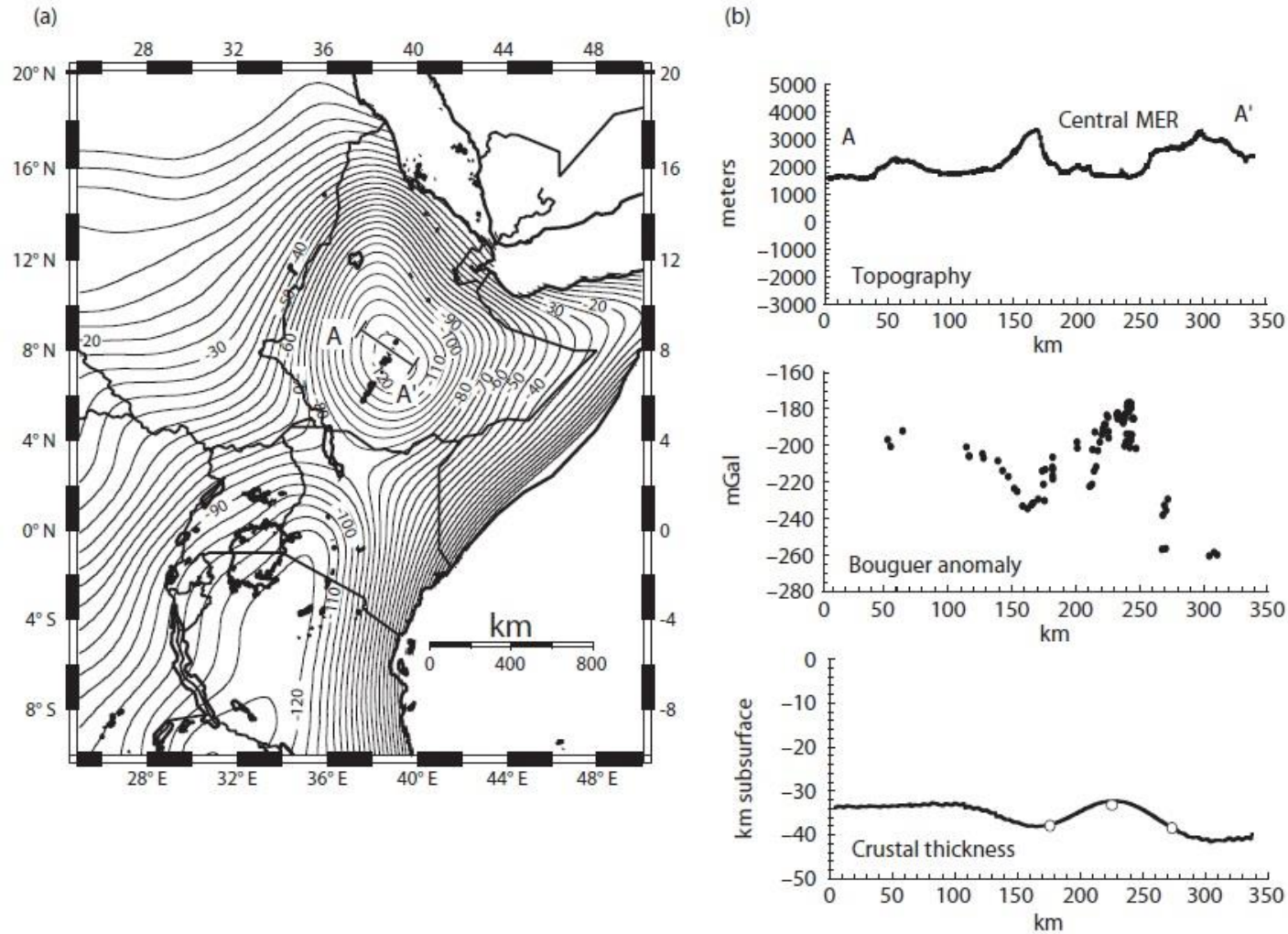

- In Ethiopia and Kenya, two longwavelength (>1000 km) negative Bouguer gravity anomalies coincide with two major ~2 km high topographic uplifts, resulting from the eruption of a large volume of continental flood basalts: the Ethiopian Plateau and the Kenya Dome.
- The negative gravity anomalies reflect the presence of anomalously low density upper mantle and elevated geotherms.

# Lithospheric structure of narrow rifts

## East African Rift

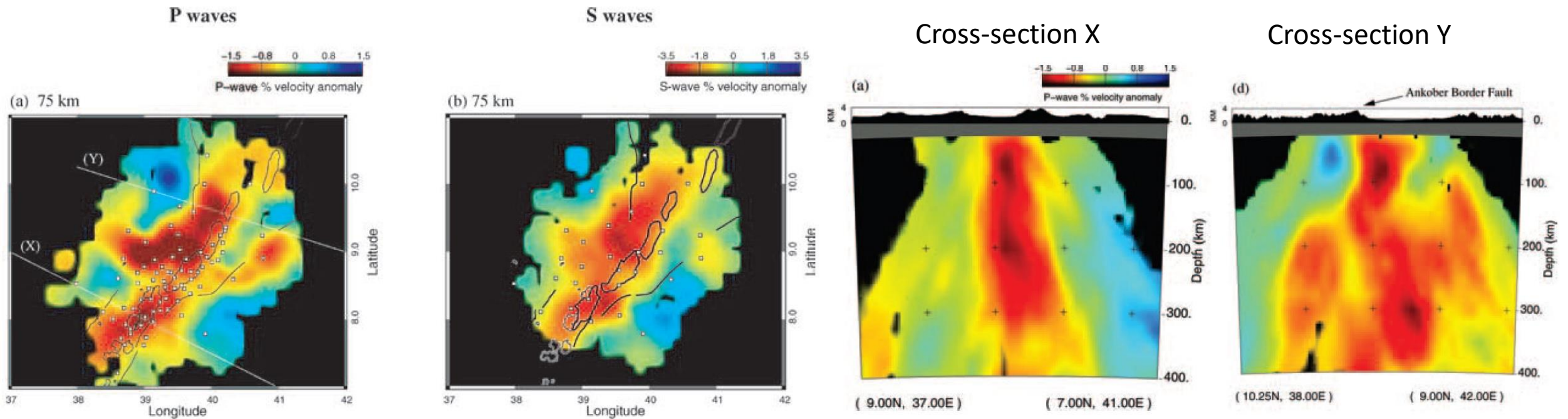

Bastow et al., 2005, Geophys. J. Int.,162

- In the southern, less extended parts of the rift, the low-velocity anomaly is narrow ( $\sim 75$  km wide) and tabular in shape. In contrast, further north, the low-velocity anomaly broadens laterally below 100 km. Along strike, the depth extent of low-velocity structure increases from  $\sim 250$  km south of  $9^\circ\text{N}$  to more than 300 km towards Afar.
- The upper mantle at 75 km beneath the rift is characterized by a low-velocity anomaly of up  $-4\%$ , which are likely the result of high temperatures and partial melt, while the flanks are faster (up to  $1.5\%$ ).

# Variscan orogen disruption

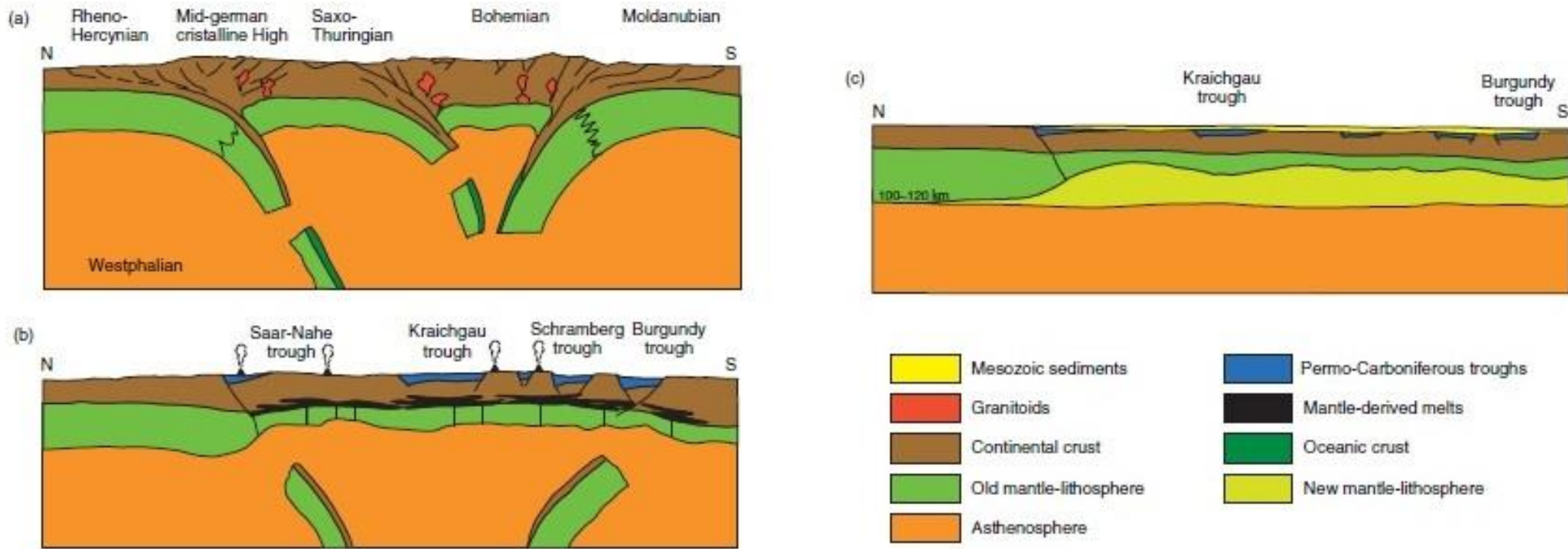

**Development of the Variscan Orogen involved major crustal shortening and subduction of substantial amounts of continental and oceanic crust and lithospheric mantle, which lead to a significant thickened crust and lithosphere.**

- Processes controlling postorogenic modification of the Variscan lithosphere (a), resulting in the Mesozoic subsidence of an intracontinental basin system, may be due to: **Permo-Carboniferous slab detachment, delamination of the lithospheric mantle, crustal extension, and plume activity with subsequent thermal relaxation of the lithosphere.**
- At the end of Early Permian (b), crust was thinned from 45-60 km to 27-35 km by magmatic processes and the lithosphere thinned to 9-40 km in areas that evolved into Late Permian to Mesozoic depocentres, whereas it retained a thickness of 40–90 km beneath slowly subsiding areas and persisting highs.
- During the Mesozoic started the subsidence of a system of intracontinental basins and at the end of Cretaceous (c), the lithosphere re-equilibrated with the asthenosphere at depths of 100-120 km.
- In the Early Paleocene, the lithosphere–asthenosphere system of the ECRIS area became destabilized in conjunction with a phase of major intraplate compression (early phase of Alpine orogeny) and impingement of mantle plumes and in the late Eocene increased plume activity, caused further destabilization of the lithosphere.



# European Cenozoic Rift System (ECRIS)

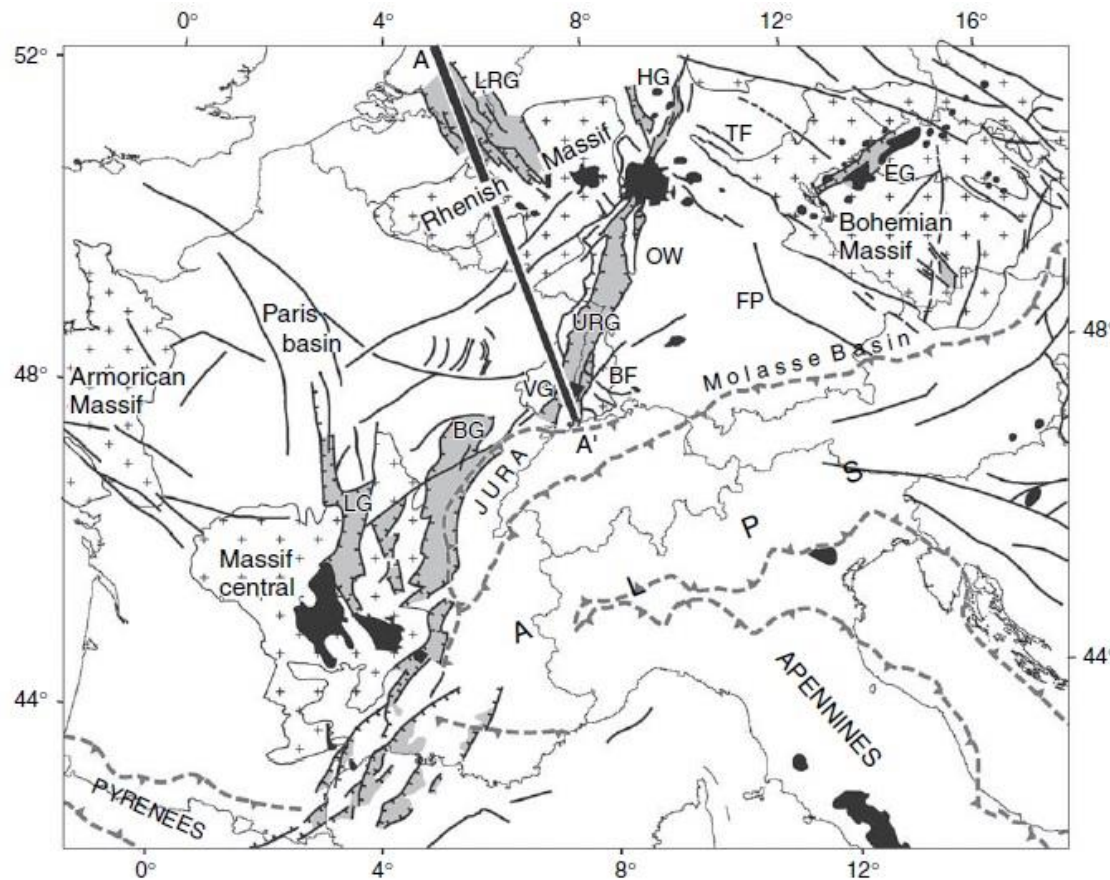

BF Black Forest, BG Bresse Graben, EG Eger (Ore) Graben, FP Franconian Platform; HG Hessian grabens, LG Limagne Graben, LRG Lower Rhine (Roer Valley) Graben, URG Upper Rhine Graben, OW Odenwald; VG Vosges.

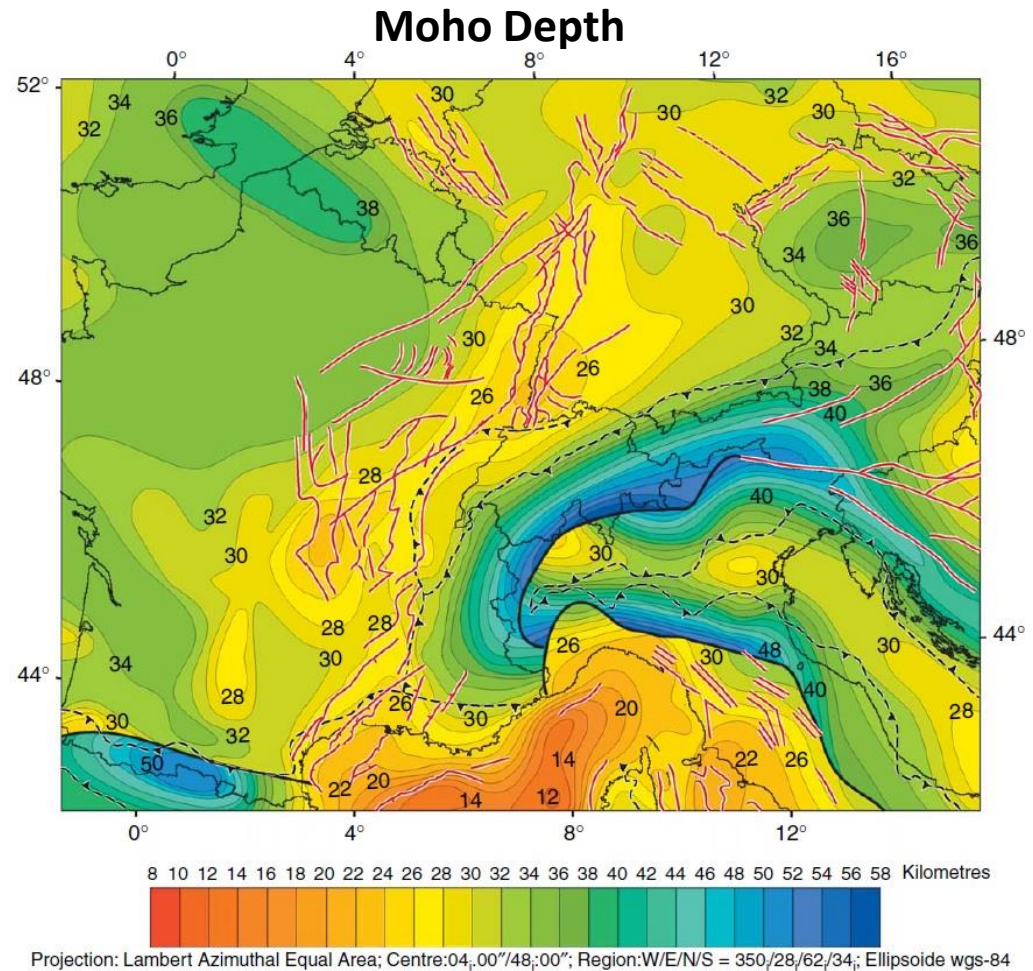

Projection: Lambert Azimuthal Equal Area; Centre:04,00°/48,00°; Region:W/E/N/S = 350/28/62/34; Ellipsoide wgs-84

- ECRIS transects the suture between the Rheno-Hercynian foreland and the Saxo-Thuringian terrane, and the more internal sutures between the Saxo-Thuringian and Bohemian, and the Bohemian and Moldanubian terranes.
- Disruption of the Variscan orogen (Paleozoic) occurred during the evolution of the ECRIS, owing to rift-related uplift of the Rhenish and Bohemian Massifs, the Vosges-Black Forest Arch, and the Massif Central.
- ECRIS developed from mid-Eocene in the foreland of the evolving Alpine and Pyrenean orogens, with crustal extension and continued plume activity causing destabilization of the lithosphere–asthenosphere system.

# Tectonic subsidence in the European Cenozoic Rift System (ECRIS)

## Upper Rhine Graben and Lorraine area

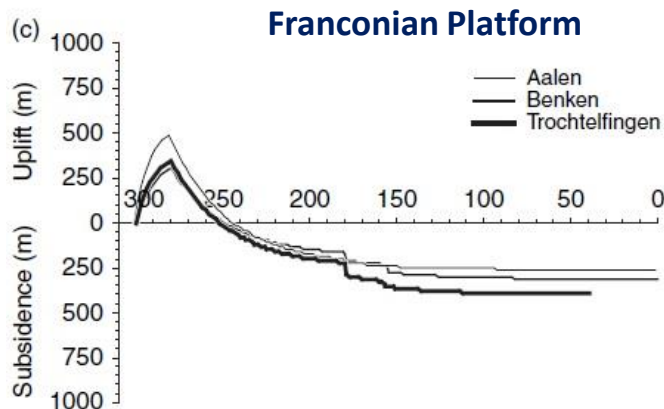
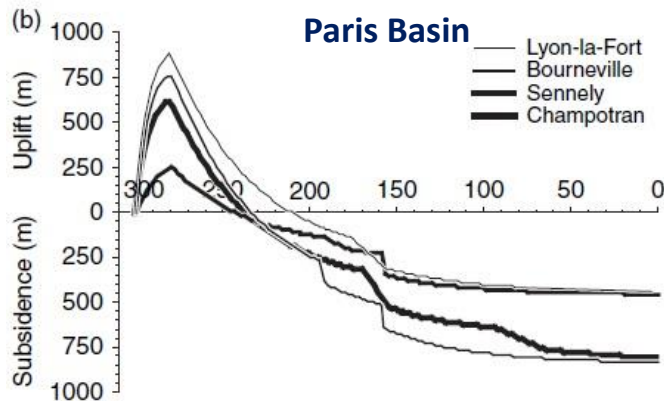
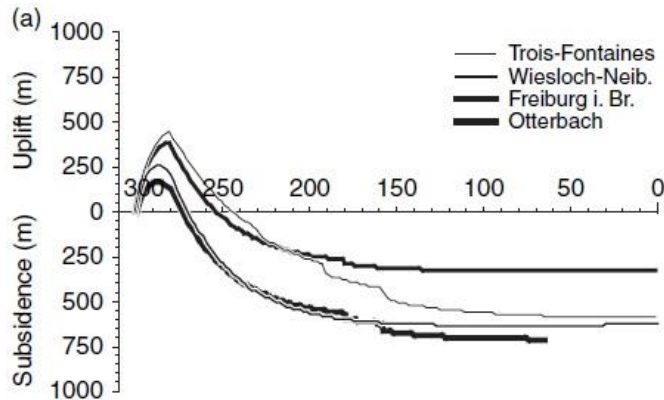

- During the Permo-Carboniferous tectonomagmatic cycle, the lithospheric mantle was significantly attenuated with  $\beta$  in the range of 1.8–10 (large lateral variations of attenuation: some areas such as Bohemian and Armonican massifs were not affected by thinning).
- Re-equilibration of the lithosphere with the asthenosphere commenced during the late Early Permian (280 Myr) and continued throughout Mesozoic times.
- On the long-term thermal subsidence trends intermittent and generally local Mesozoic subsidence accelerations are superimposed.
- These phases of acceleration likely reflect either tensional reactivation of Permo-Carboniferous fault systems or compressional deflection of the lithosphere.

The positive part of the modeled subsidence curve reflects uplift of the crust in response to thermal thinning and/or delamination of the mantle-lithosphere.

The negative part reflects thermal subsidence of the crust during re-equilibration of the lithosphere/asthenosphere system.



# Lithospheric structure of narrow rifts

## Rhine graben

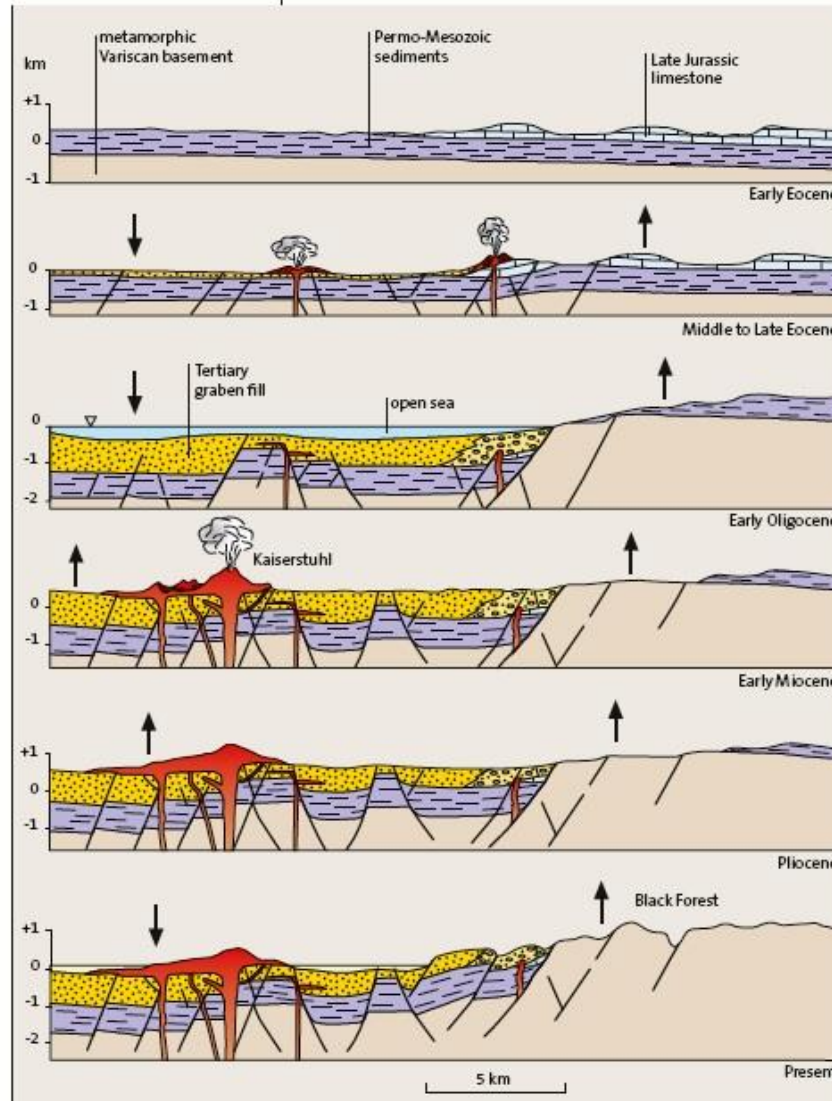
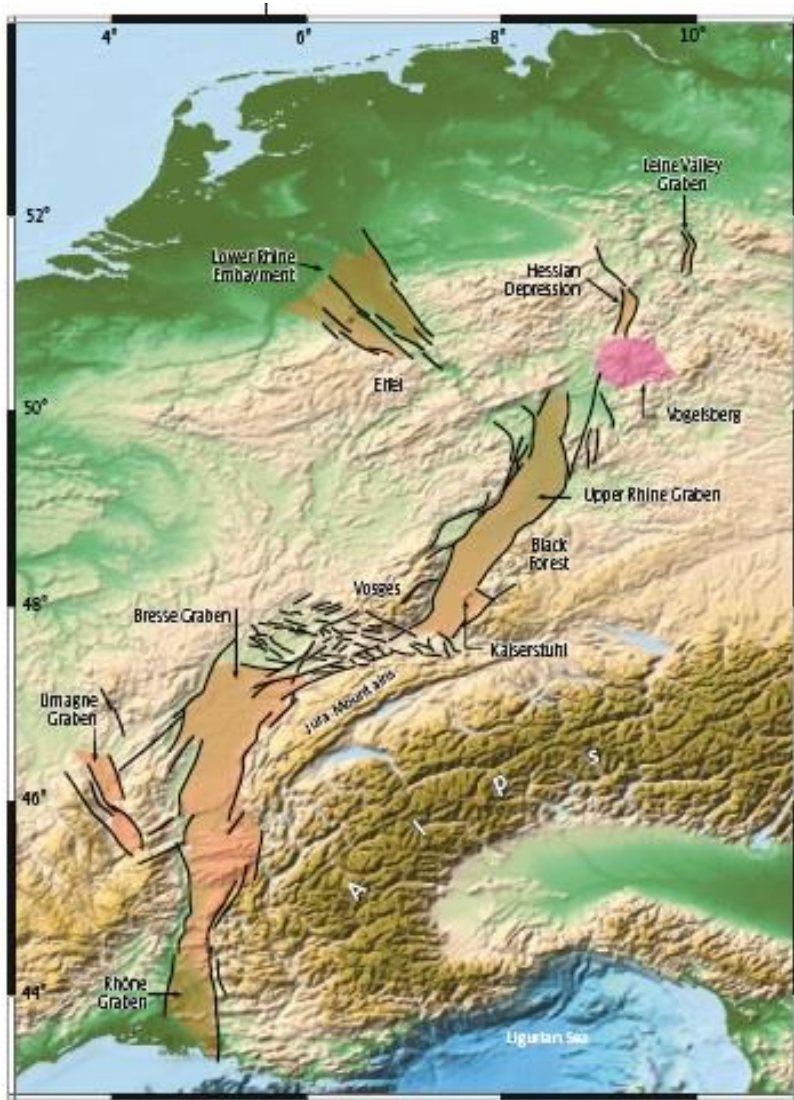

- 20000 km<sup>3</sup> of Tertiary sediments
- Subsidence started in the south in the Eocene and lasted till Late Oligocene.
- Subsidence continued in the north (Lower Rhine Embayment) in the Early Miocene and lasted till Early Pliocene.
- High heat flow in the Upper Rhine graben (80-120 mWm<sup>2</sup>).
- Differently from the Upper Rhine Graben, in the Lower Rhine Embayment is not present a mantle bulge, neither graben shoulders, indicating a passive rift structure.



# Stress conditions and seismicity in the Rhine graben

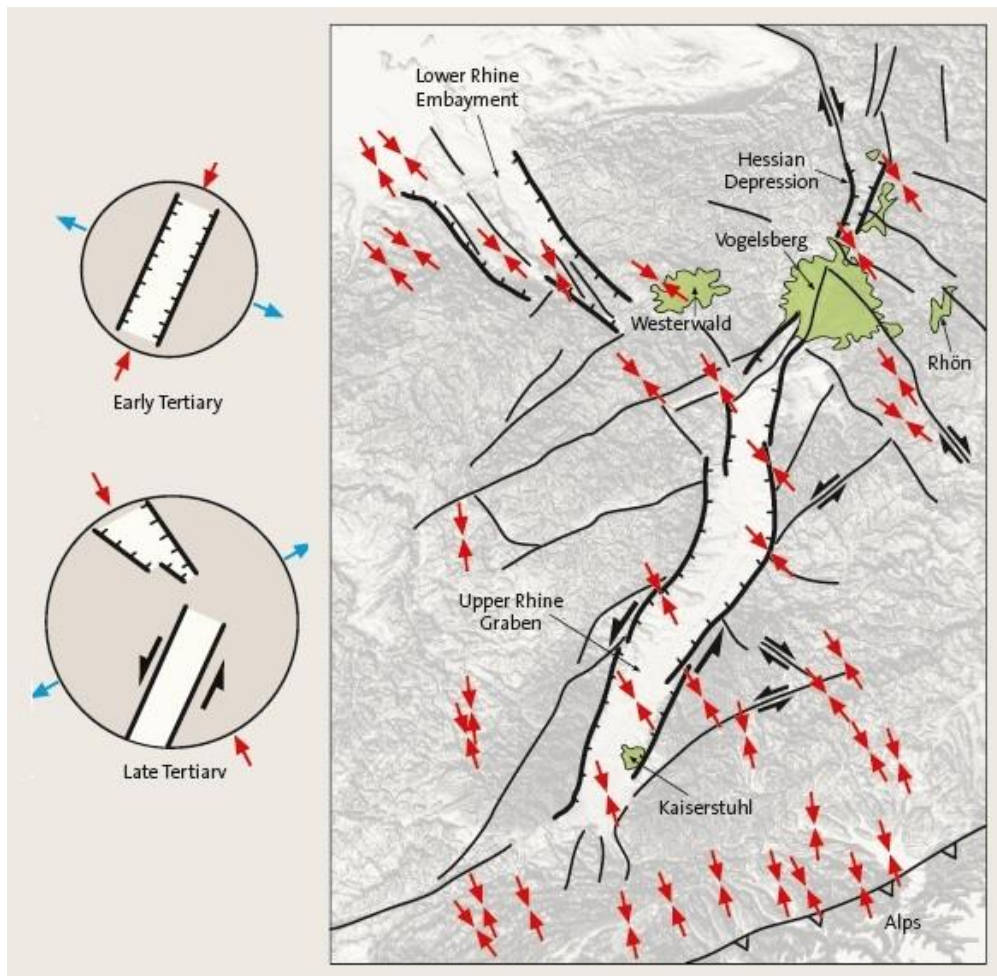

Anticlockwise rotation of stress axis during time

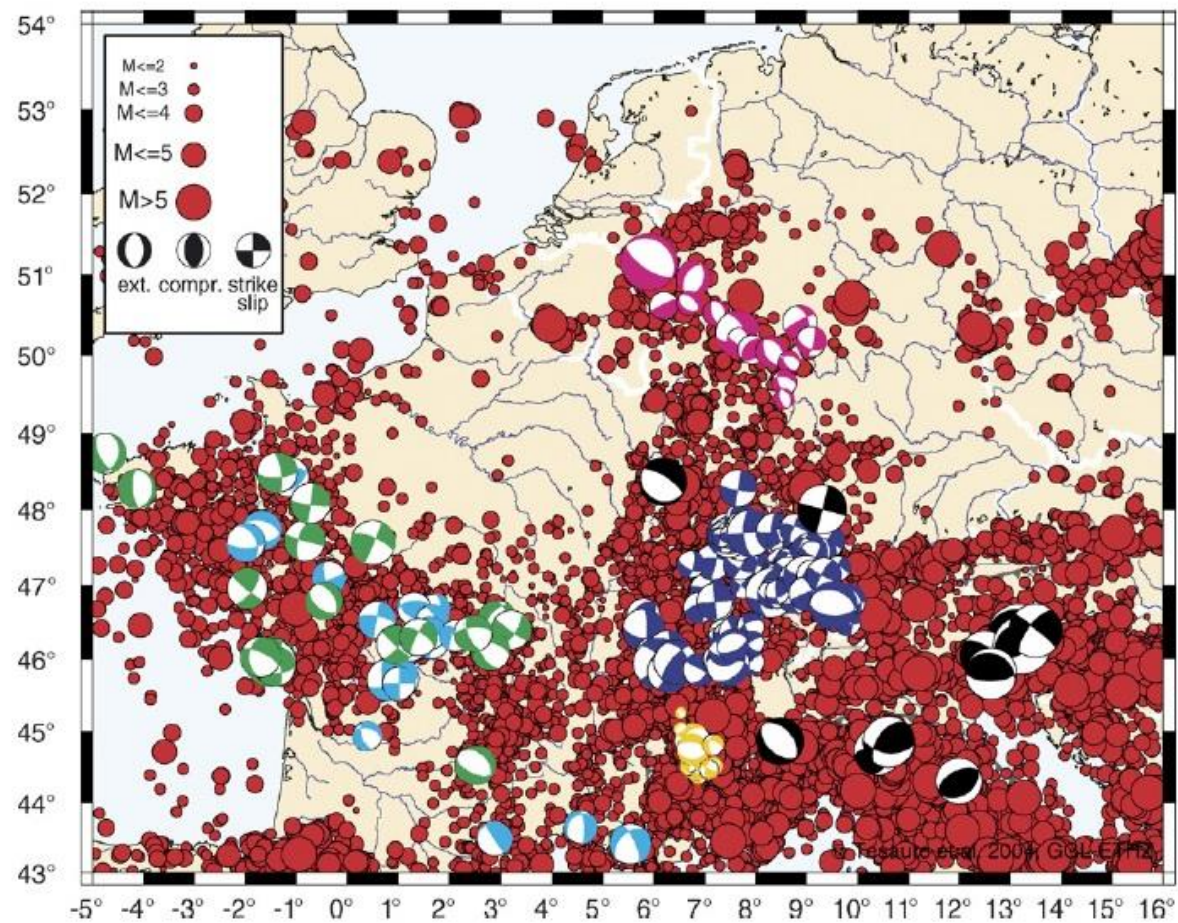



# Lithospheric structure of narrow rifts

## Rhine graben

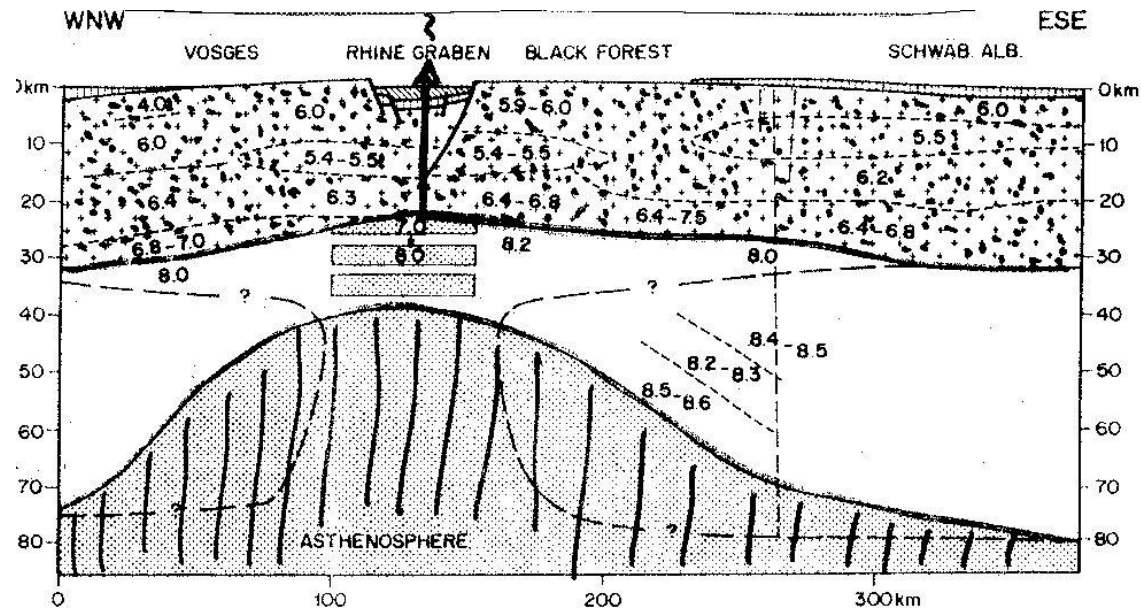

Neugebauer et al., 1981, Tectonicphysics 73

- Lithospheric thinning is  $\gg$  the crustal thinning (5-7 km)
- Asthenospheric dome corresponds to strong heat flow and volcanism

- faults are steep
- extension is small

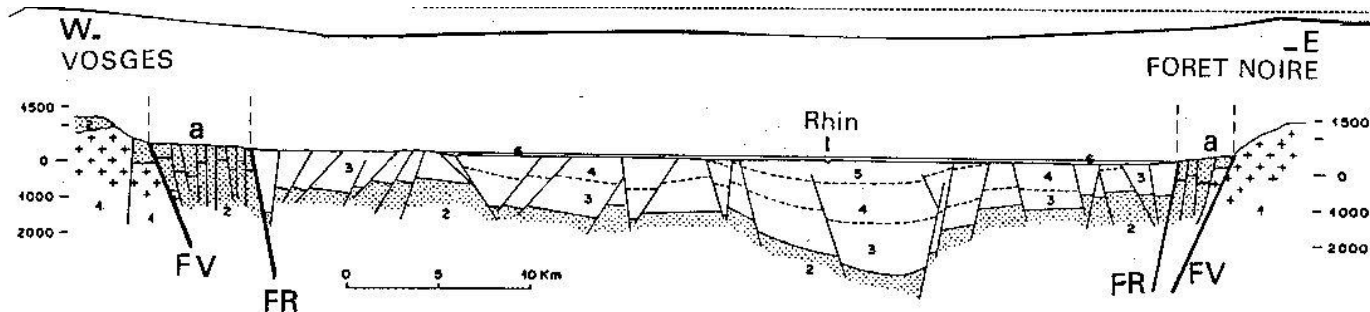
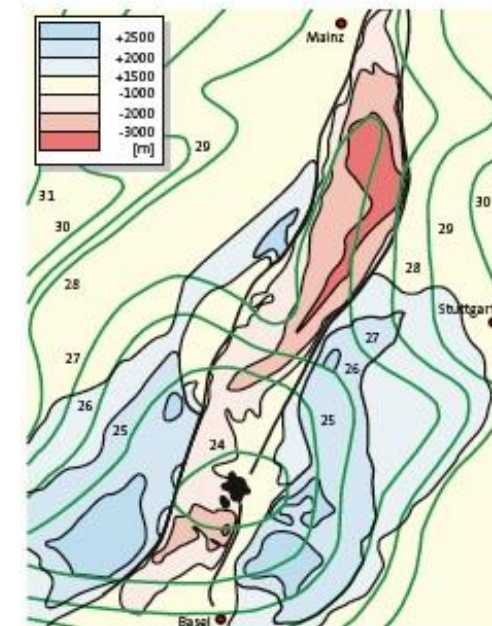
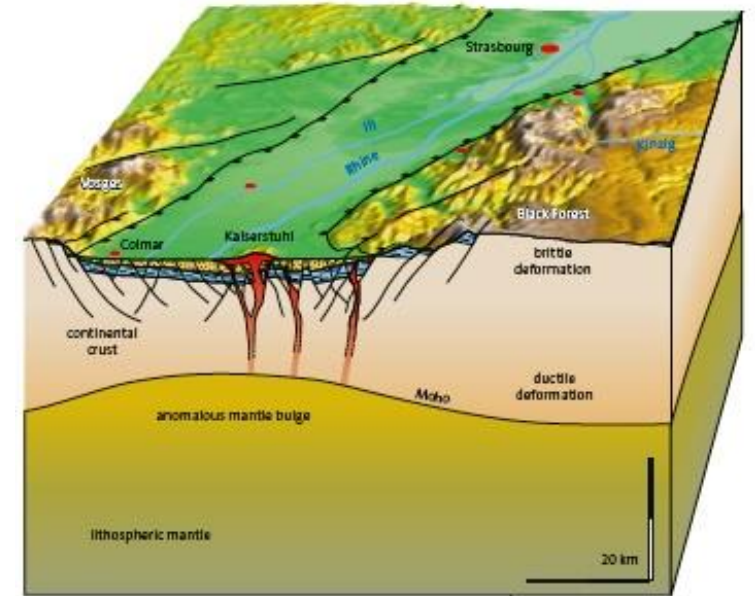



# Lithospheric structure of narrow rifts

## Baikal Rift

- The Baikal rift developed during the last 35 Myr, producing only small volumes of volcanic products. Its surface expression is a curved series of 40–80-km-wide graben structures, more than 2,000 km long, at the edge of the Siberian craton.
- The Baikal rift can be considered as an example of passive rift, being characterized at depths between 50 km and 300 km by fast upper mantle velocity.
- The crust of the Baikal rift is about 40–42 km thick and it is characterized by high density and high velocity zone in its deep levels.
- The expected Moho uplift in reply to the crustal thinning was compensated by magmatic intrusion into the lower crust, producing the observed high-velocity zone.

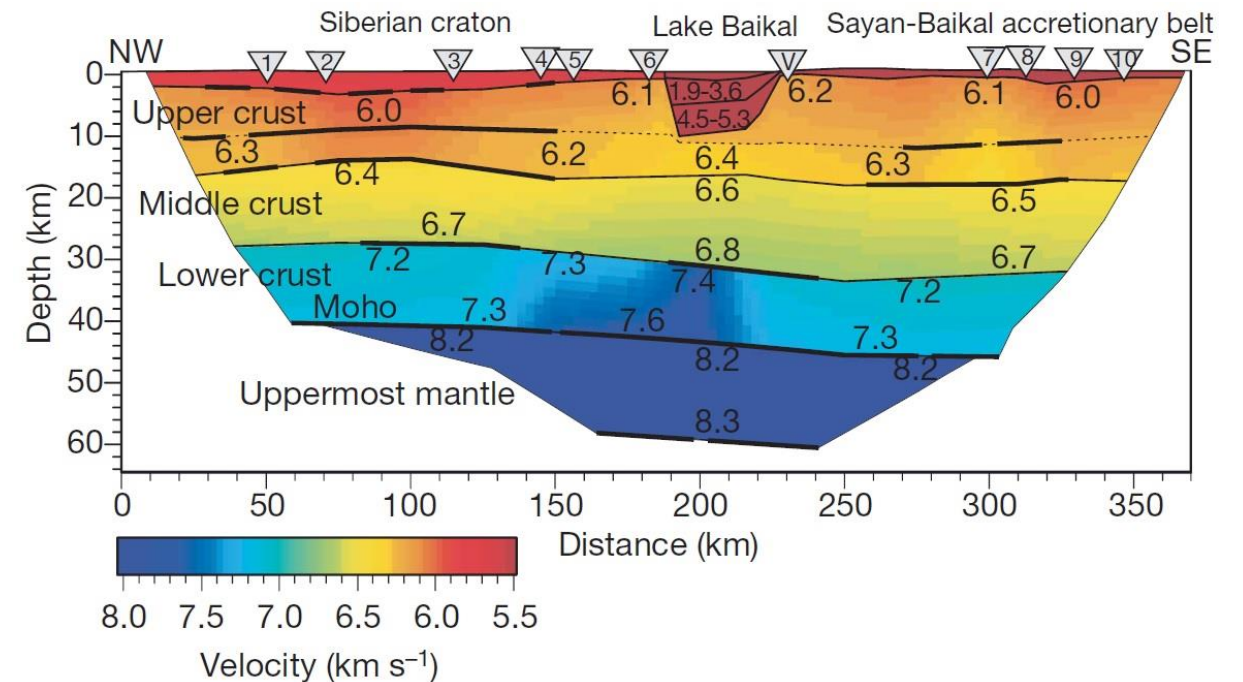
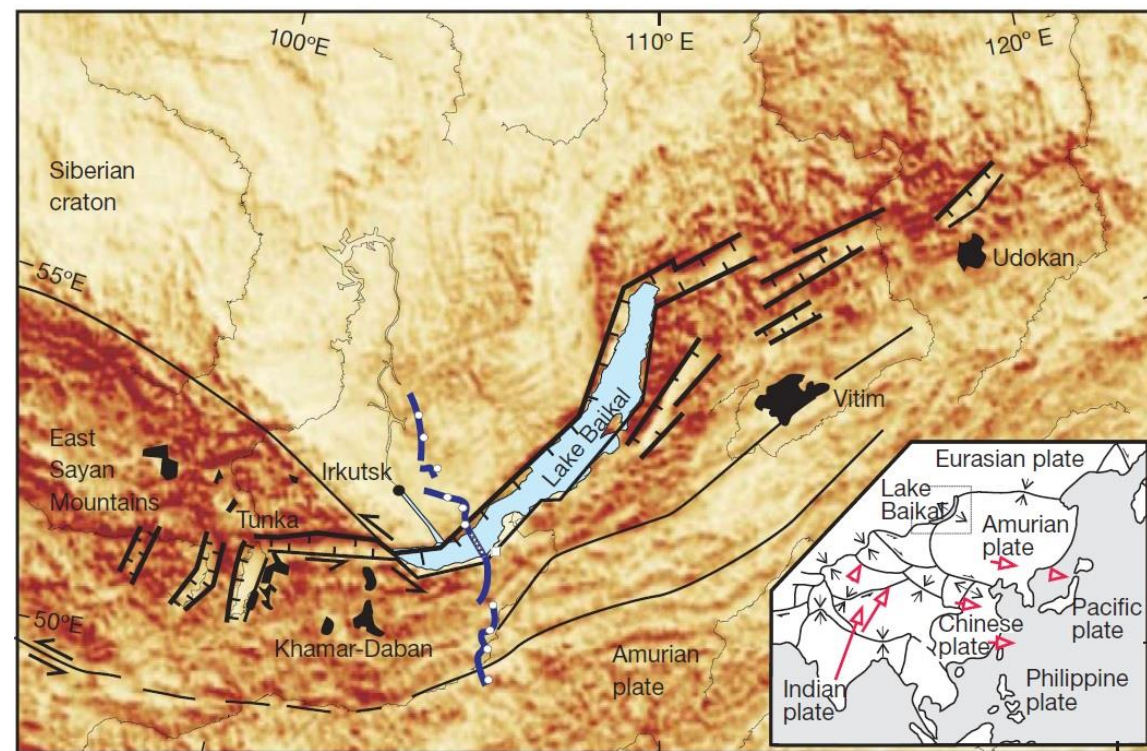

# Lithospheric structure of narrow rifts

## Baikal Rift

### Models for formation of the Baikal Rift Zone (BRZ)

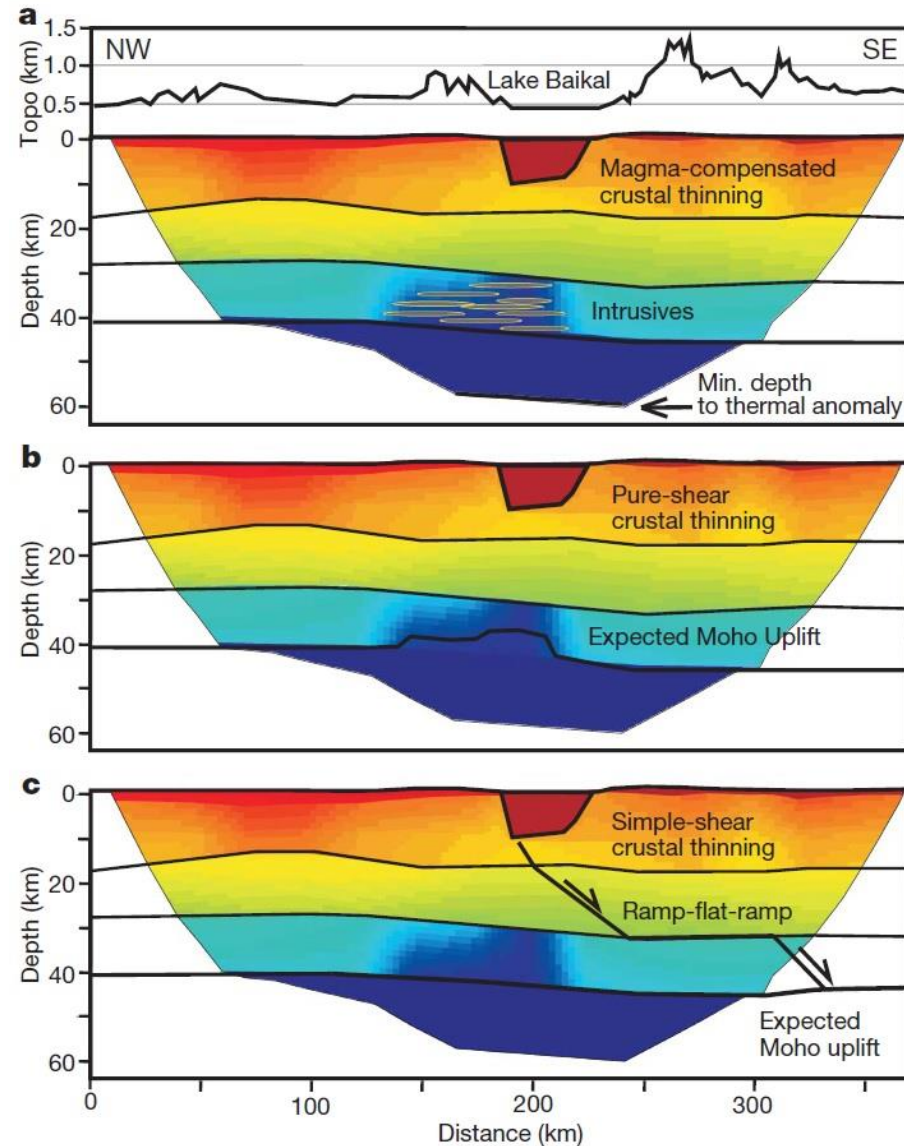

**Model a:** the high-velocity, reflective zone in the lower crust includes 50% of intrusive material, which explains the flat Moho. The deepest reflector indicates the minimum depth to the asthenosphere (or significant positive thermal anomaly).

**Model b:** Pure shear, which predicts uplift of Moho below the BRZ, which is not observed in the seismic model.

**Model c:** Simple shear predicts uplift of Moho outside the BRZ, which is not observed to a distance of 200 km.

#### Main Characteristics:

- No mantle thermal anomaly has reached close to the base of the crust, and that the rifting processes are not driven by a mantle plume.
- Significant volume of magmatic intrusions, balancing the expected crustal thinning, explains the apparent lack of crustal thinning beneath the BRZ.



# Lithospheric structure of narrow rifts

## Rio Grande Rift

- Extension within the Rio Grande rift occurred during different periods, a first period from about 30 to 20 Myr and a second one from 10 to 3 Myr and was accompanied by volcanism.
- The Rio Grande rifts may be considered as an example of active rifts, since large mantle upwellings occurring beneath its central part and downwelling occurring beneath its margins control its tectonic evolution

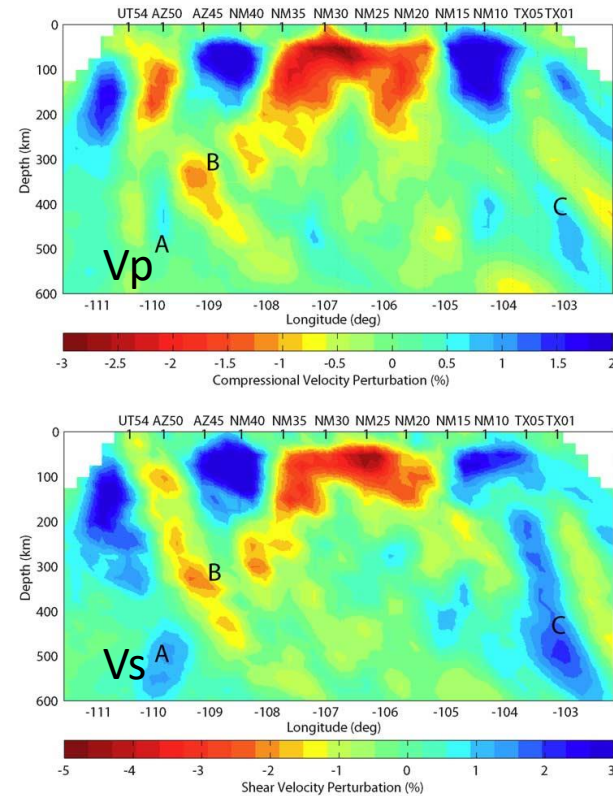
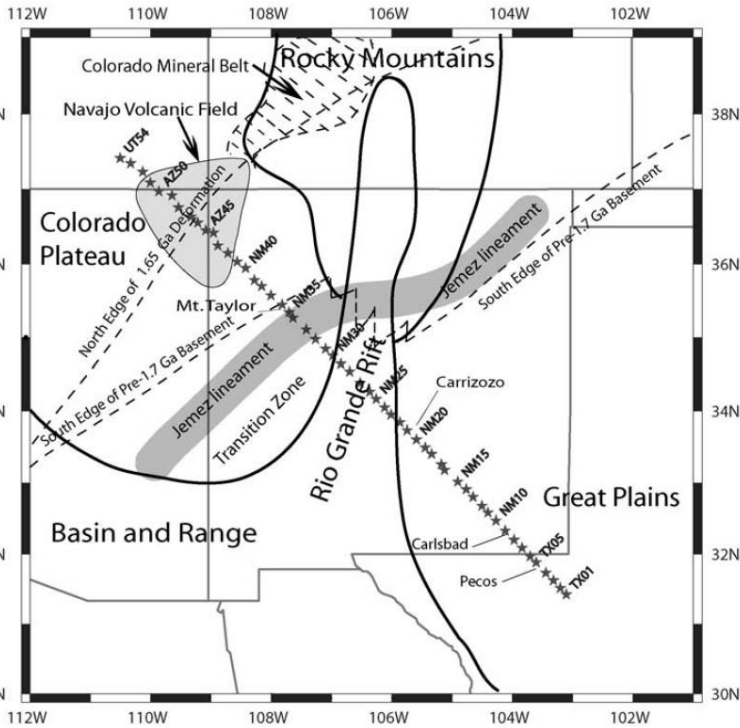

## Mantle structure beneath the Rio Grande rift

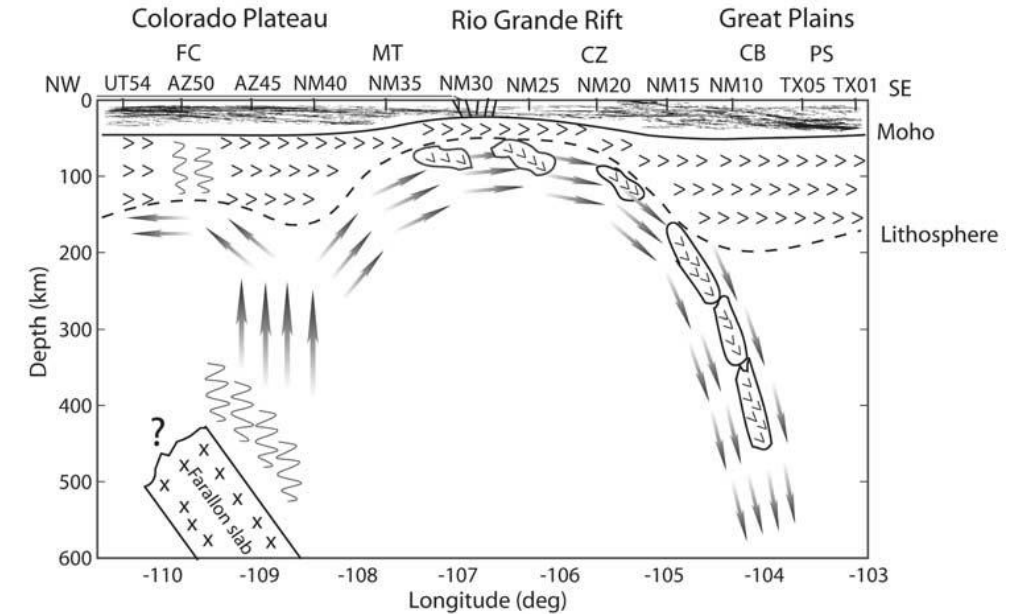

Gao et al., 2004, JGR, 109

- Upwelling from the deeper upper mantle is rising near the location of remnants of the sinking Farallon slab, which likely disrupted about 40 Myr ago, while downwelling of mantle is occurring beneath the thicker lithosphere of the Great Plains.
- Lithosphere under the Rio Grande rift has been mechanically removed to the east by the convective flow indicated by the Great Plains downwelling.

# Wide Rift Basin and Range

Gravitational collapse mechanisms: when thick crust and high heat flow make the lithosphere weak

Extension follows earlier crustal thickening by ~20 Myr or more, so that the thickened brittle crust has sufficient time to spread gravitationally under its own weight over a weak layer in the lower crust.

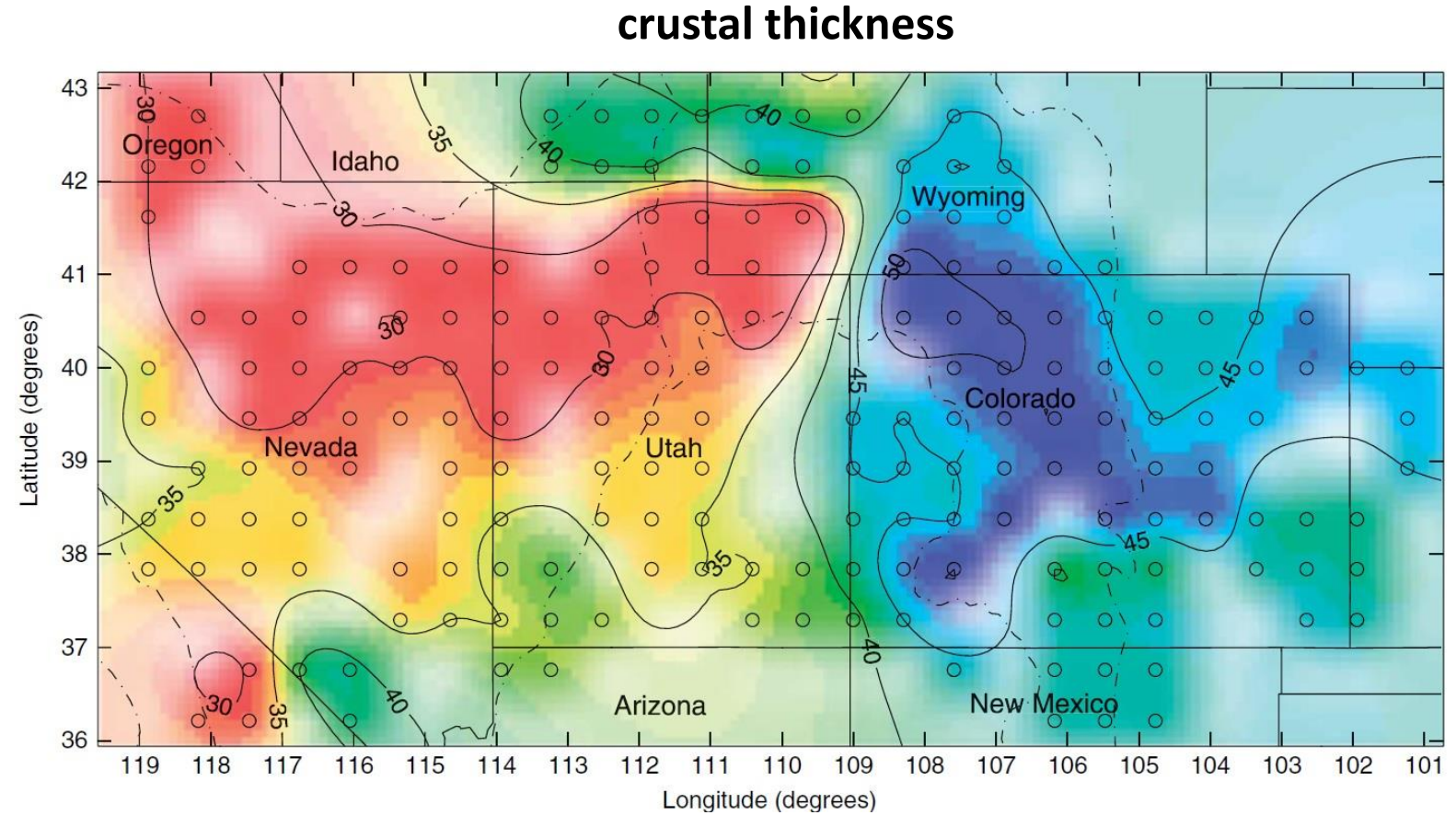
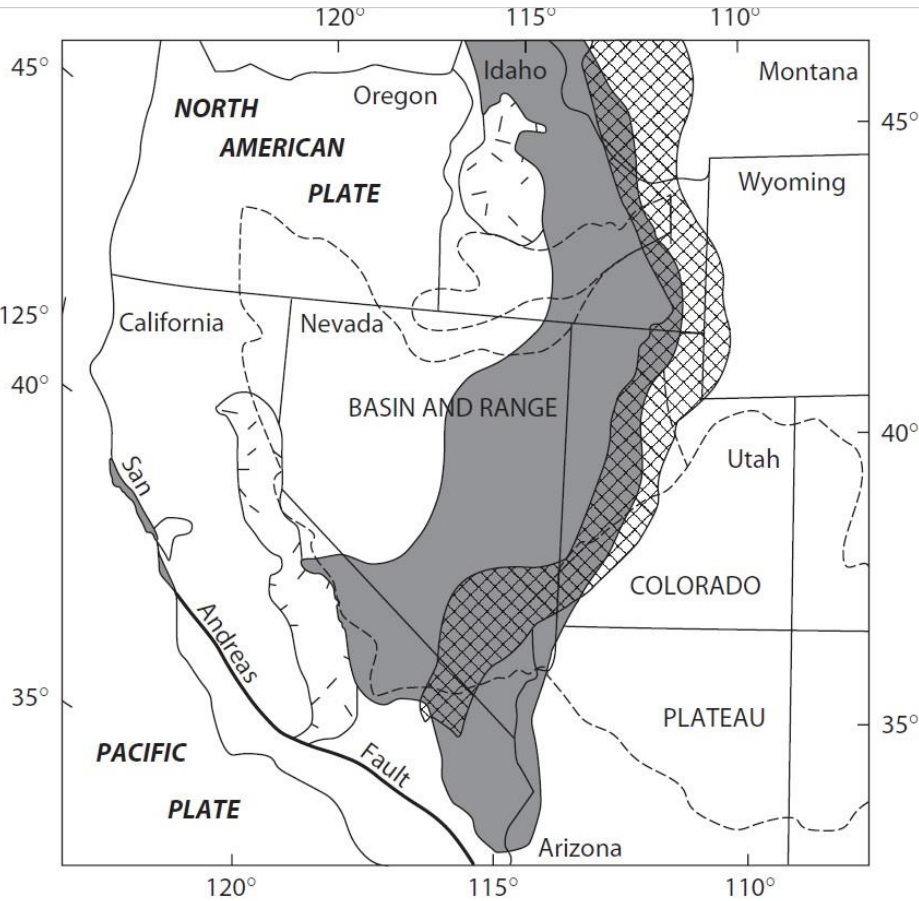

- |                                        |                         |
|----------------------------------------|-------------------------|
| Extent of the Paleozoic passive margin | Mesozoic Batholiths     |
| Sevier Thrust Belt                     | Physiographic Provinces |



# Wide Rift Basin and Range

- **The Basin and Range is characterized by an extended crust** (typically only 30 km thick), with a lower crust almost always missing (removed during the extension). As a consequence, the flat Moho is marked by a sharp jump in seismic velocities.
- **Mantle lithosphere and anomalously high heat flow:** Basin and Range is characterized by high surface heat flow ( $>92 \pm 9$  mW/m<sup>2</sup> in the presently active Northern Basin and Range and  $82 \pm 3$  mW/m<sup>2</sup> in the Southern Basin and Range Province), thin lithosphere (50 km), and magmatism due to mantle uplift.
- **Enhanced electrical conductivity in the uppermost 100–150 km of the Southern Basin and Range Province** can be explained by partial melting of the mantle.
- **Small- and large-magnitude normal faulting:** Low-angle normal faults (evolved from high-angle faults by flexural rotation) are common and accommodate very large displacements (10-50 km).

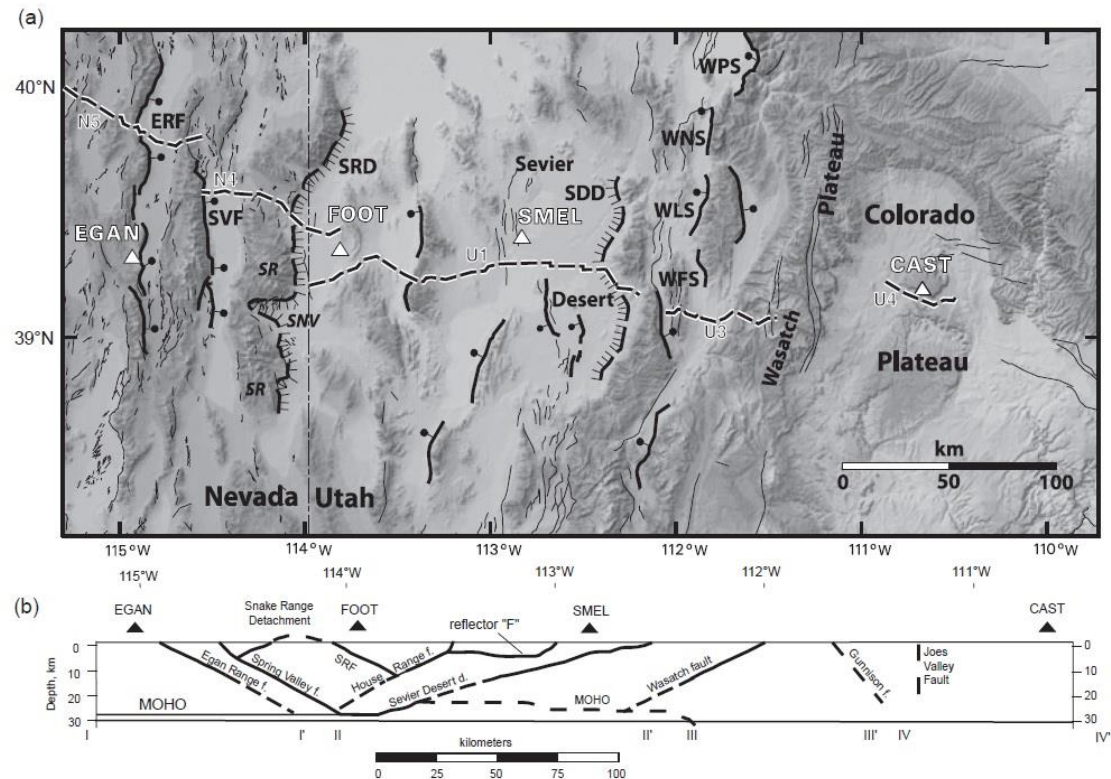

# Wide rift lithospheric structure

## Basin and Range

### Key features:

- Basin and Range province is extended in E-W direction across 600 km, covering an area of 550,000 km<sup>2</sup>.
- It is oldest in the south (southern Arizona) and youngest to the NW in Nevada and Oregon (still active).
- Rocks are from Precambrian to Cenozoic and topography ranges between 3000-4000 m (peaks) to few 100s-2000 m (basins).
- Crust is about 30 km thick and underwent strong extension being originally about 50 km.
- Crustal extension is still on-going in the Northern Basin and Range and has roughly doubled its area in the Cenozoic, the Southern Basin and Range Province has been relatively inactive during the past 10–15 Myr.
- The topographic elevation (> 1 km) in the Basin and Range province, despite stretching can be explained by lithosphere delamination at the early stages of tectonism.
- The collapse of the orogen started in the Late Oligocene after an initial phase of back-arc extension (Eo-Oligocene magmatism has a subduction signature).
- From the Miocene, the magmatism bears a lithosphere/asthenosphere signature, likely due to the opening of asthenospheric windows in the Farrallon slab during its detachment from in the lithosphere.

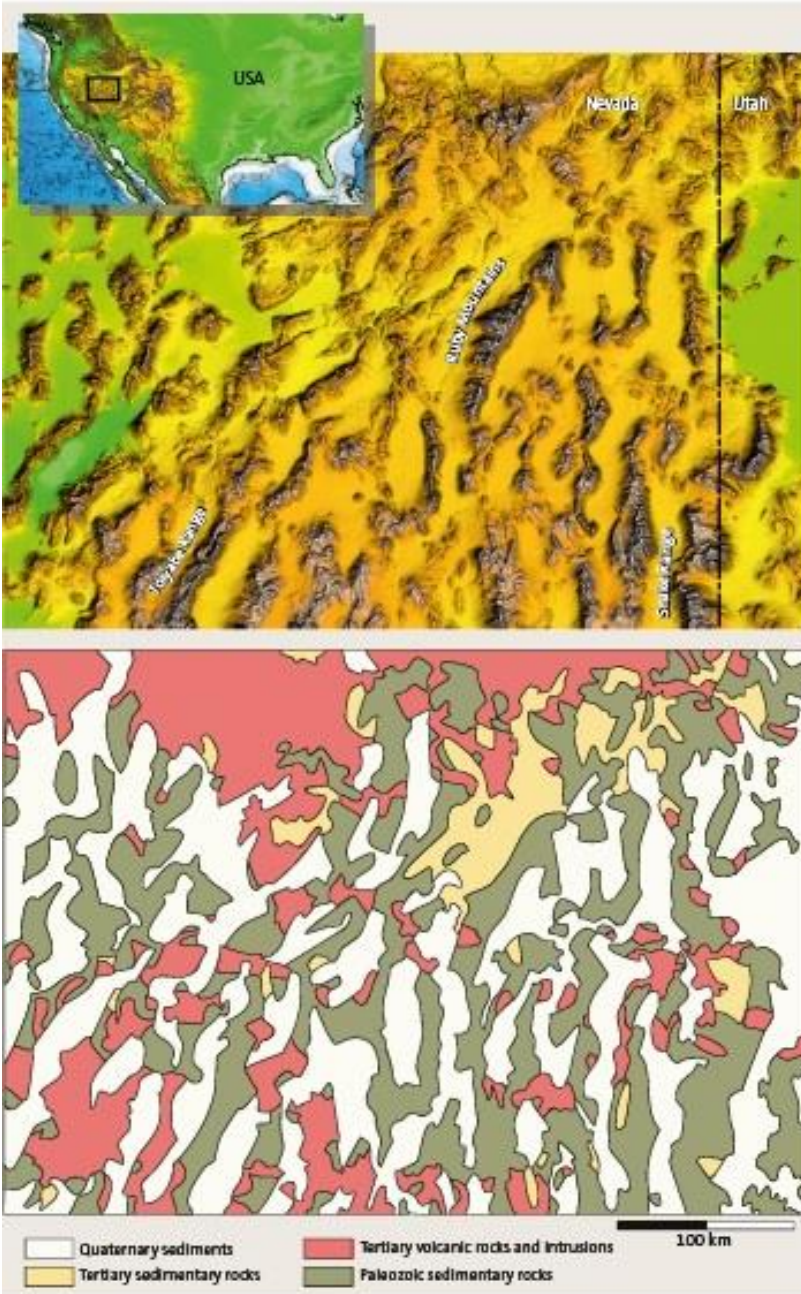



# Wide Rift Basin and Range

## Key Features

- **Broadly distributed deformation:** The Basin and Range is bounded by two rigid blocks, Colorado Plateau and Sierra Nevada-Great Valley. Seismicity occurs along the borders of these blocks, since the high geothermal gradients have weakened the lithosphere of the basin.
- **Heterogeneous crustal thinning in previously thickened crust:** The western margin of North America was subjected to compressional orogenesis during the Mesozoic, which cause thickening of the crust up to 50 km. Extension during the Cenozoic caused variable thinning of the crust of the basin, depending on its pre-exting structure.
- **Thin mantle lithosphere and anomalously high heat flow:** The Basin and Range is characterized by high surface heat flow, negative long-wavelength Bouguer gravity anomalies, and low crustal Pn and Sn velocities (mantle temperature at a depth of 50 km).
- **Small- and large-magnitude normal faulting:** Large extensional strains and thinning of the crust in wide rifts is partly accommodated by slip on normal faults. Low-angle ( $< 30^\circ$ ) extensional detachment faults accommodate very large displacements (10-50 km) and penetrate tens of km into the lower crust.

## Upper crustal thinning

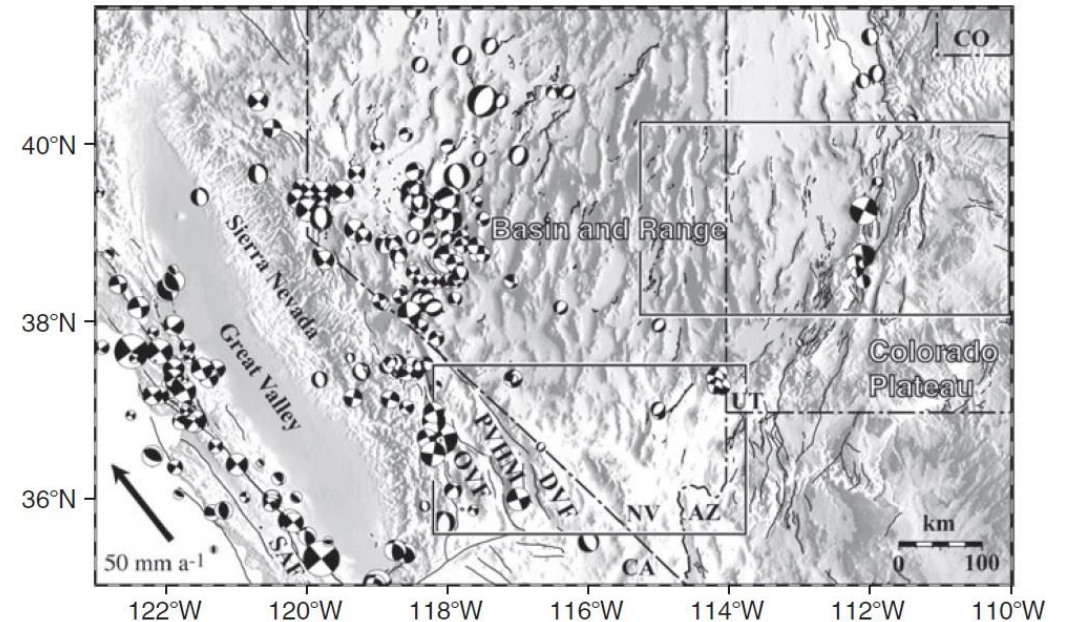
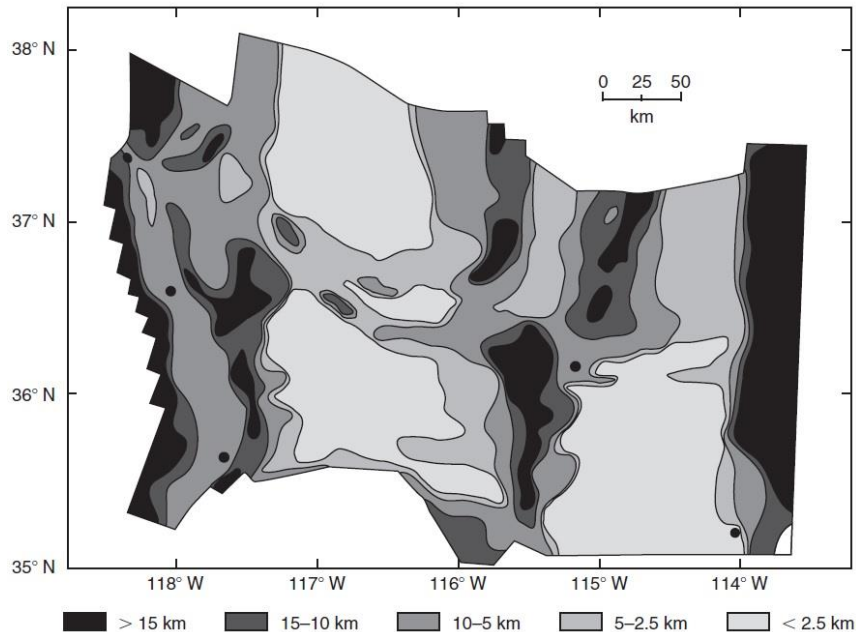

# Deep structure of core complexes

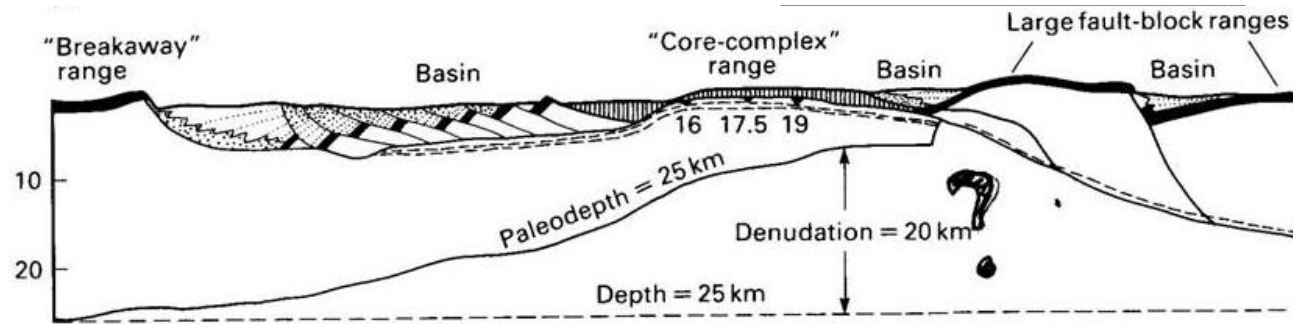

- extension is compensated by flow of material towards the core complex

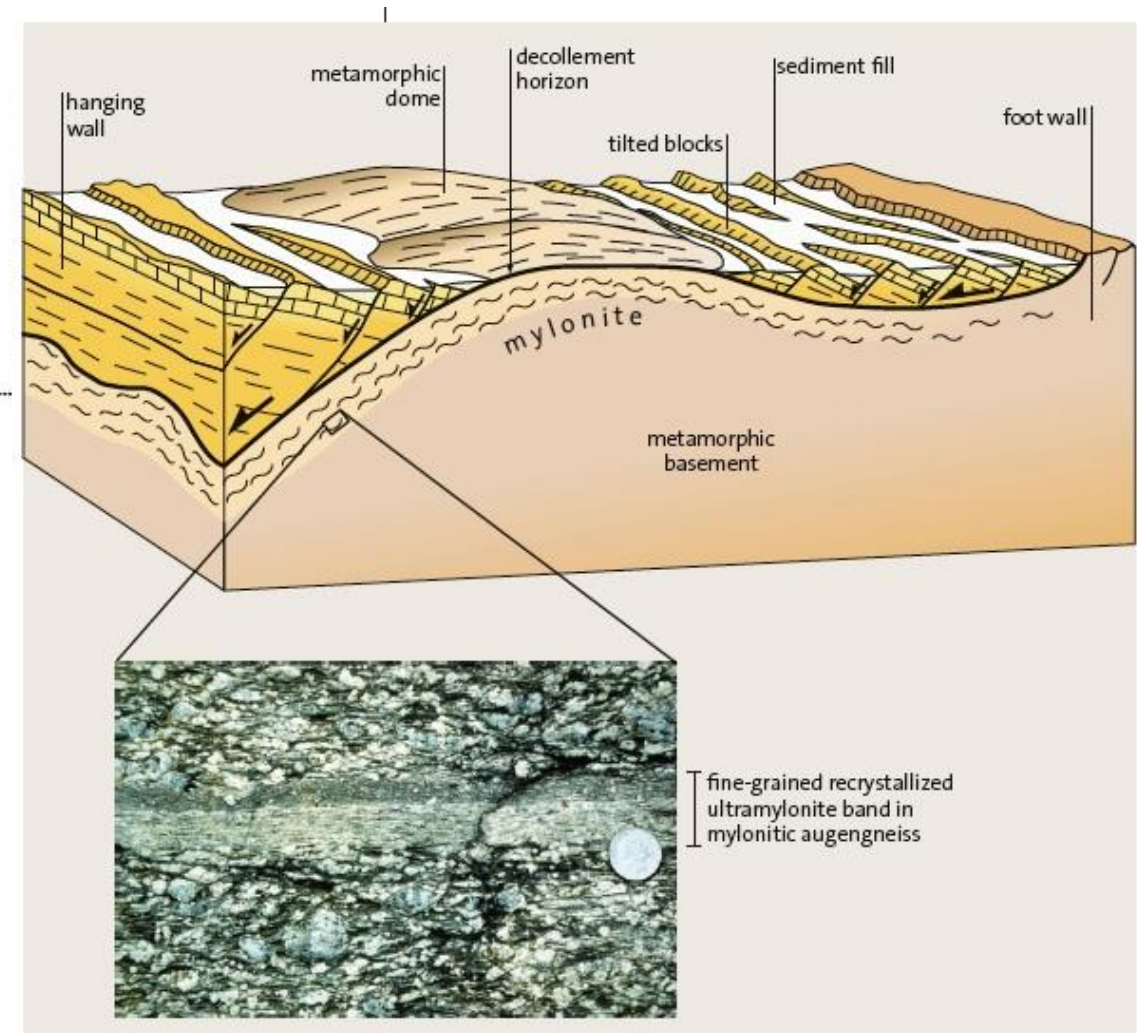

# Lithospheric strength and necking depth

## Black Sea Basin

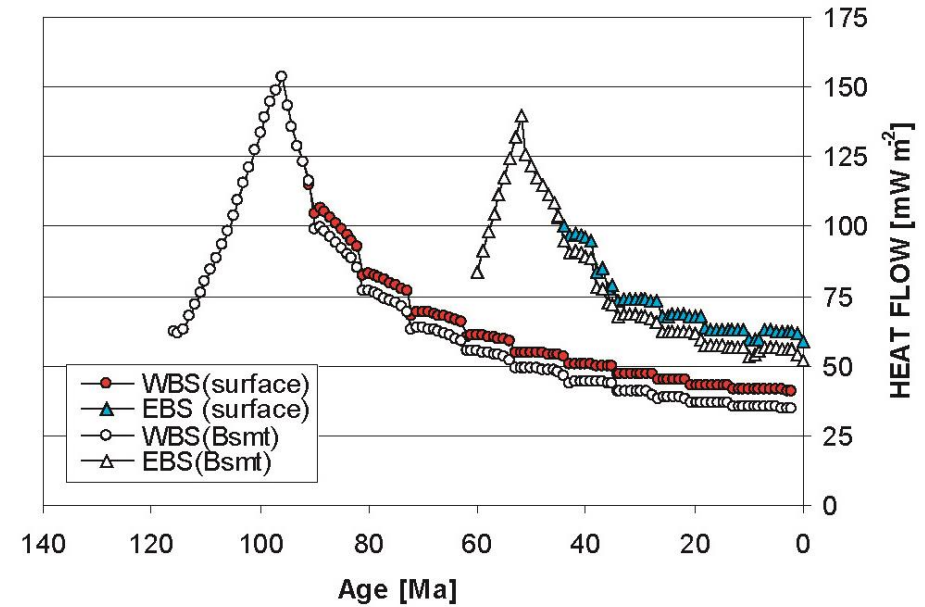

Cloetingh et al., 2003

- The western basin is floored by oceanic and transitional crust and contains up to 19 km of Cretaceous to recent sediments.
- The eastern basin is floored by strongly thinned continental crust and contains up to 12 km of Cretaceous and younger sediments.
- Black Sea evolved in response to Late Cretaceous and Eocene back-arc extension and afterwards was subjected to regional compression in conjunction with the evolution of its flanking orogenic belts.
- The present stress regime of the Black Sea (based on earthquake focal mechanisms, structural, and GPS data) is compression dominated, reflecting continued collisional interaction of the Arabian and the Eurasian plates that controls ongoing crustal shortening in the Great Caucasus.
- During the Pliocene and Quaternary accelerated subsidence of the Black Sea Basin is attributed to stress-induced downward deflection of its lithosphere.



# Lithospheric strength and necking depth

## Black Sea Basin

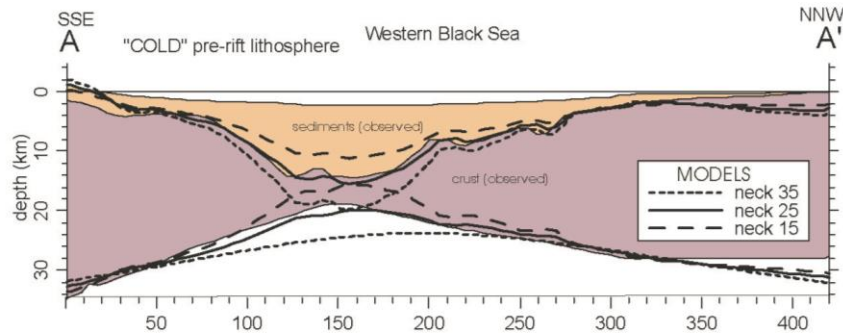

**Western Black Sea Basin:** best fit for a "cold" pre-rift lithosphere with a 25 km deep necking level.

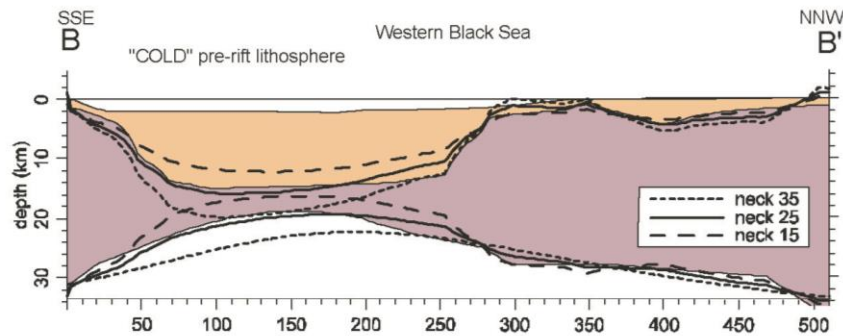

Cloetingh et al., 2003

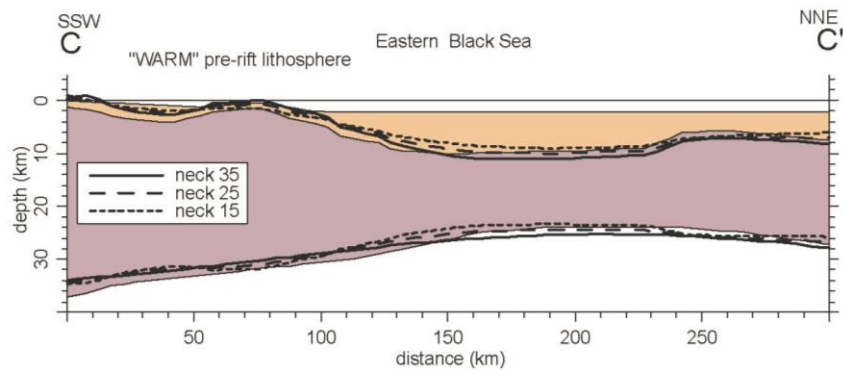

**Eastern Black Sea Basin:** best fit for a "warm" pre-rift lithosphere with a 15 km deep necking level.

- The western Black Sea appears to be in a state of isostatic undercompensation and upward flexure, consistent with a deep level of lithospheric necking.
- The eastern Black Sea gravity data appears to be in isostatic overcompensation and a downward state of flexure, compatible with a shallow necking level.



# Lithospheric strength and necking depth Black Sea Basin

The best fit crustal models also give good predictions of basin stratigraphy

Predicted WBS

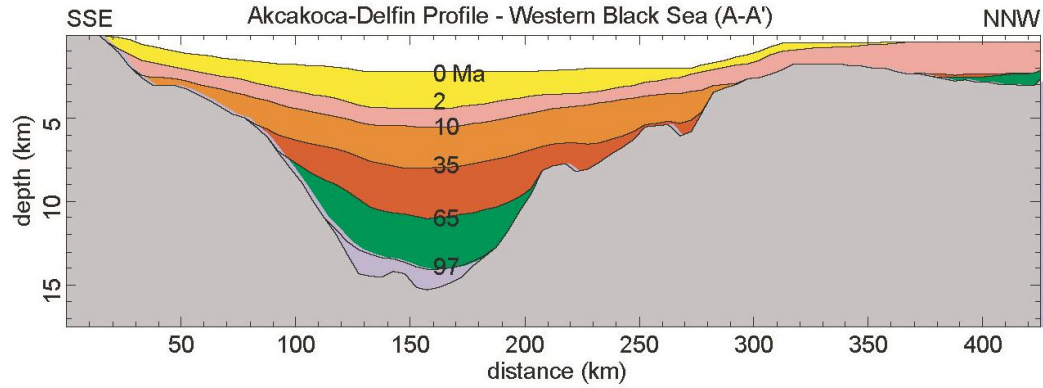

Predicted EBS

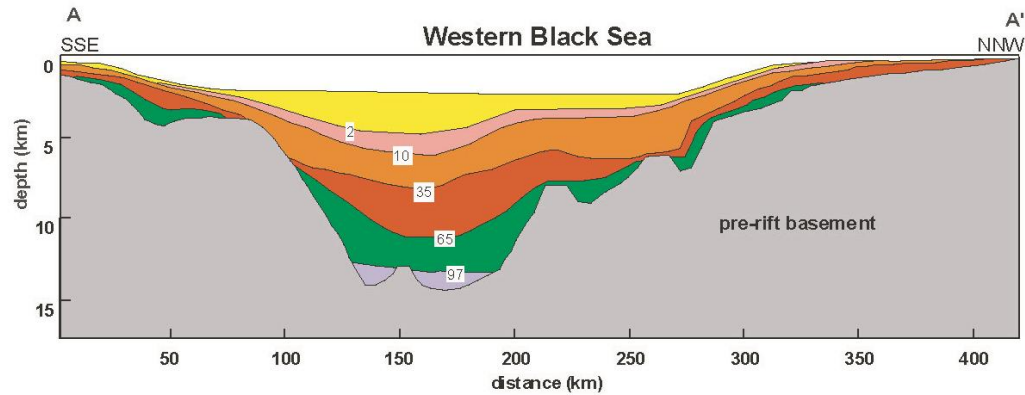
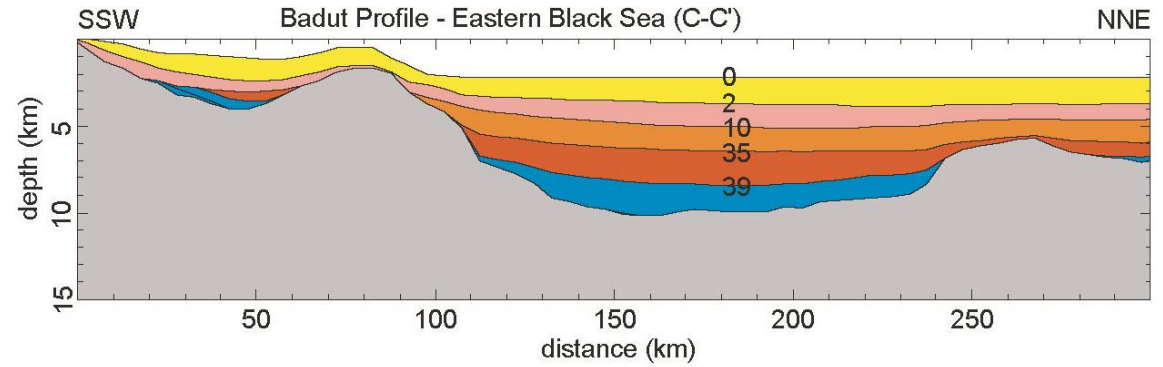

Observed WBS

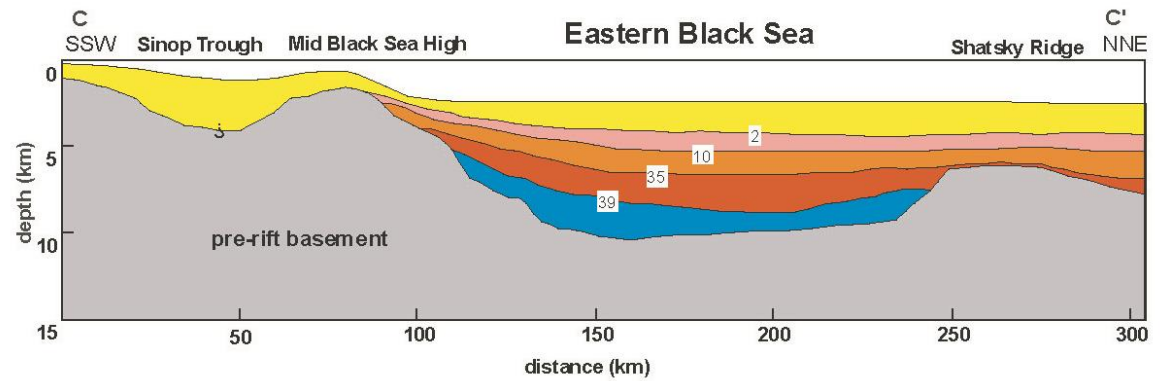

Observed EBS

# Lithospheric strength and necking depth

## Black Sea Basin

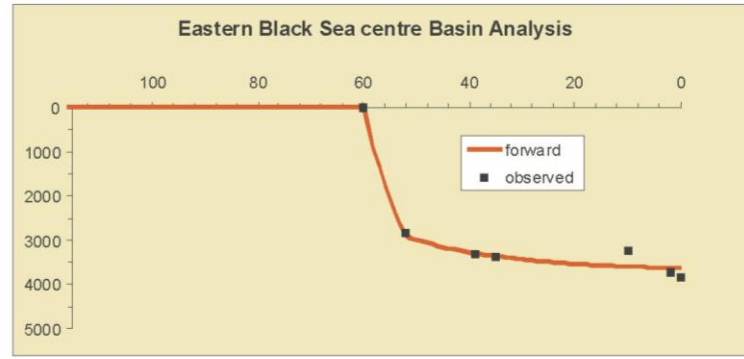
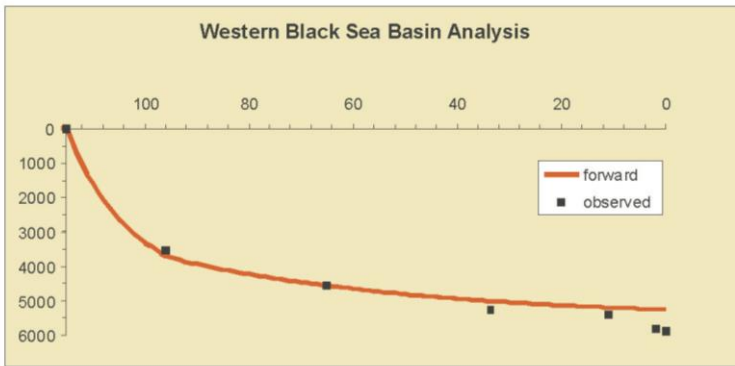

**Predicted and observed basement subsidence: Eastern Black Sea rifting is younger than Western Black Sea rifting.**

Syn-rift weakening, followed by post-rift strengthening.

❑ Eastern Black Sea is weaker than Western Black Sea

❑ Margins are weaker than the rifted basin centres

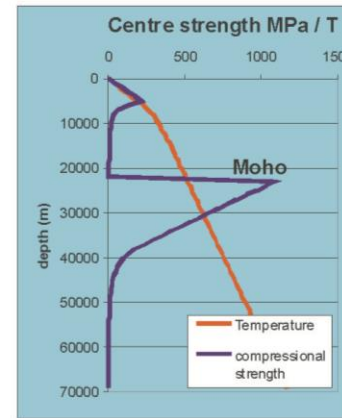
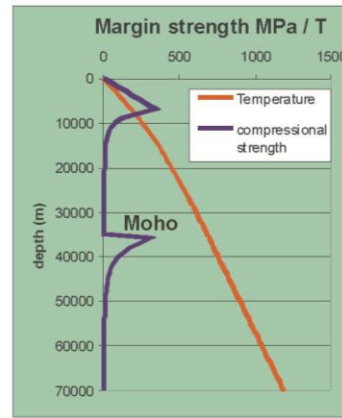
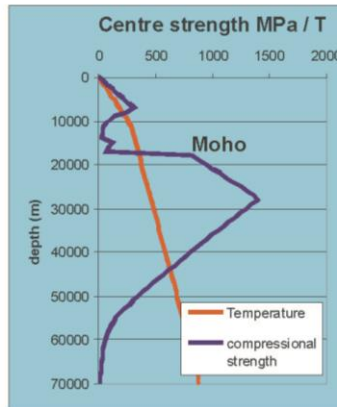
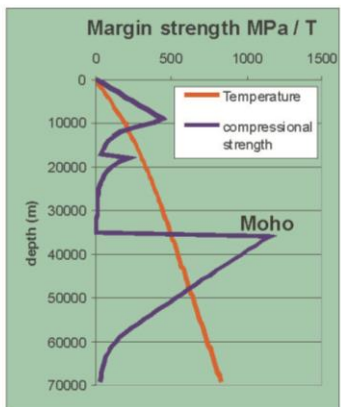
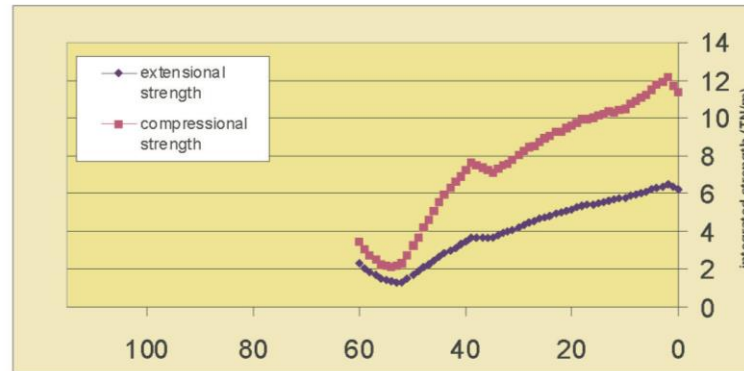
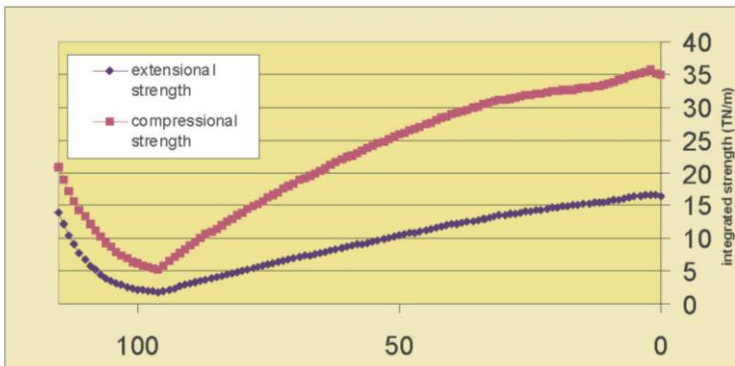

- The presence of relatively strong lithosphere in the basin center and weaker lithosphere at the basin margins favours deformation of the latter during late-stage compression.
- This may explain why observed compressional structures appear predominantly at the edges of the Black Sea Basin and not in its interior.



# The Alps-Carpathians-Pannonian Basin System

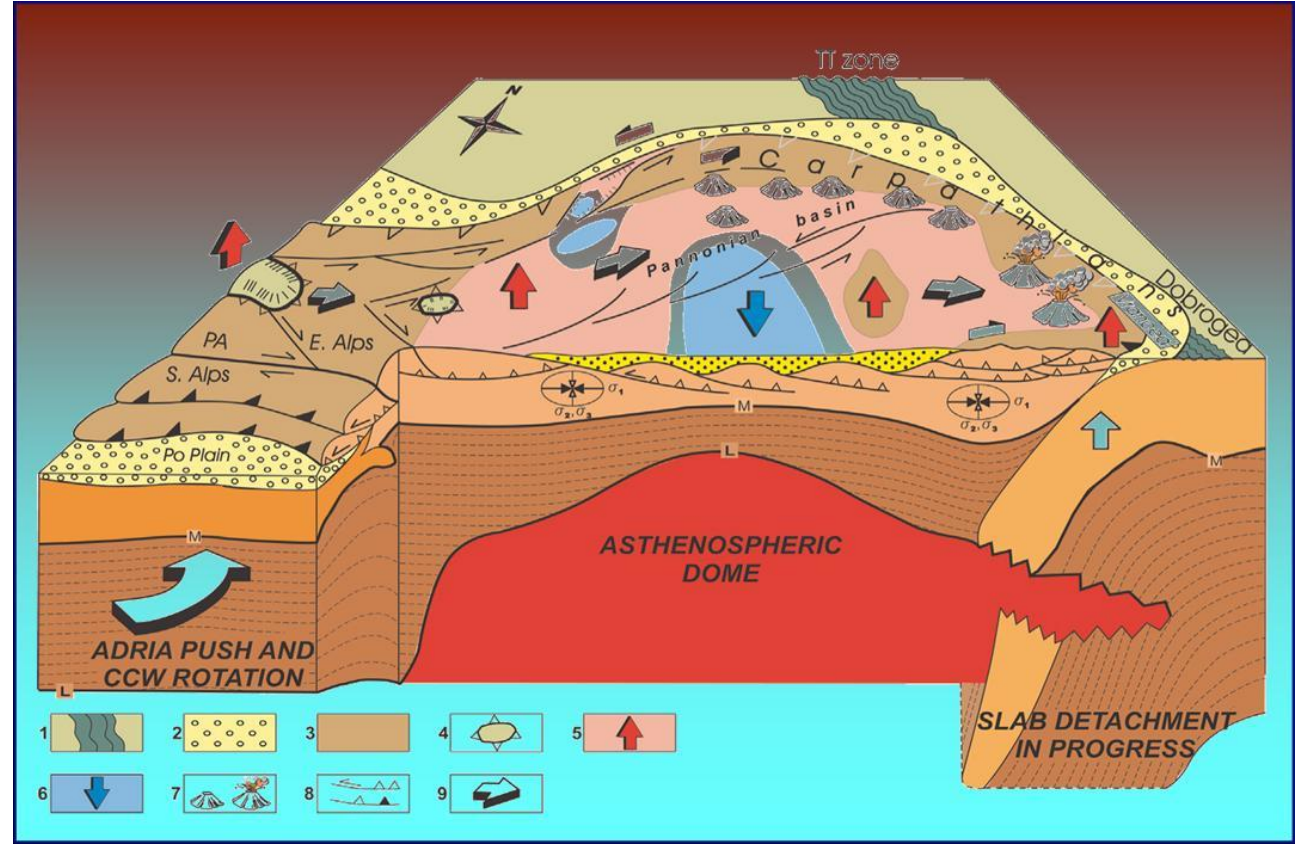
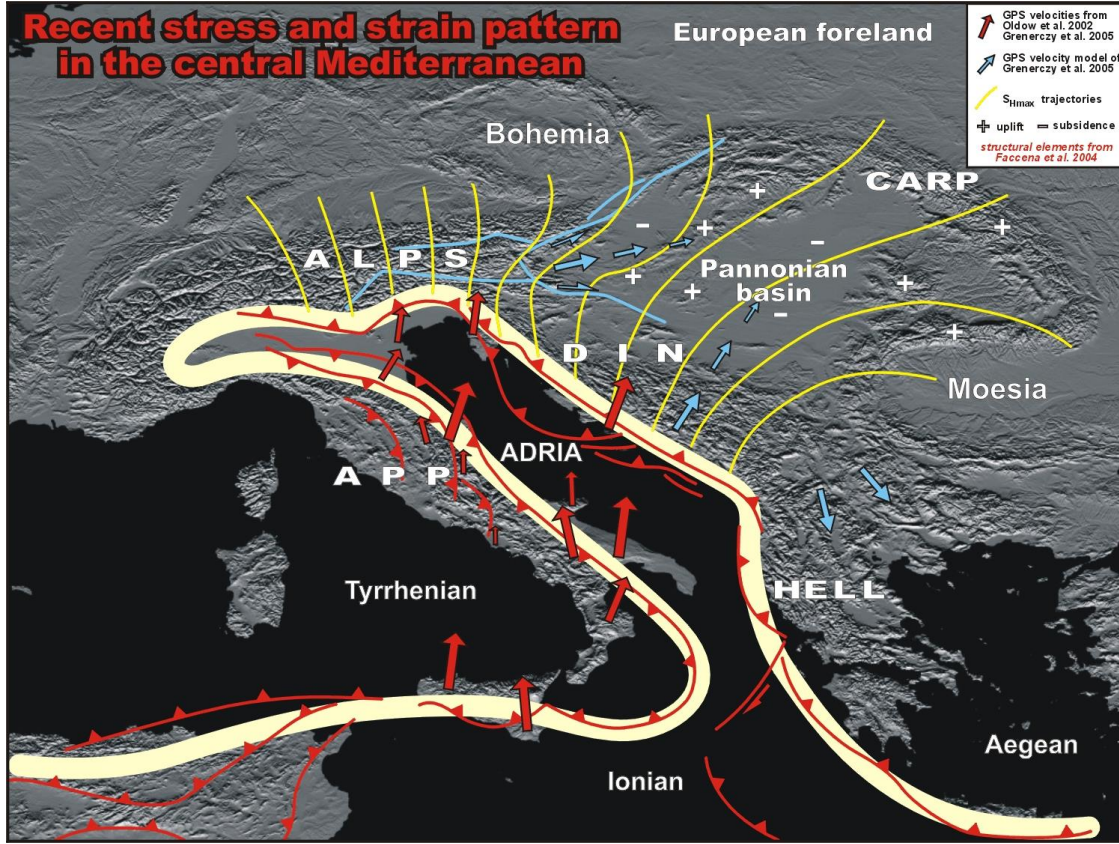

- The Pannonian basin is a backarc basin, whose formation, started at the beginning of the Miocene, likely with a simple shear phase, followed by a pure shear lithospheric deformation and was accompanied by intensive calc-alkaline magmatism.
- The basin developed from extensional disintegration of orogenic terranes and subsequent events of basin inversion, which resulted in variable basin, characterized by deep half grabens and relative basement highs.



# The Alps-Carpathians-Pannonian Basin System

## Depth of the Basement

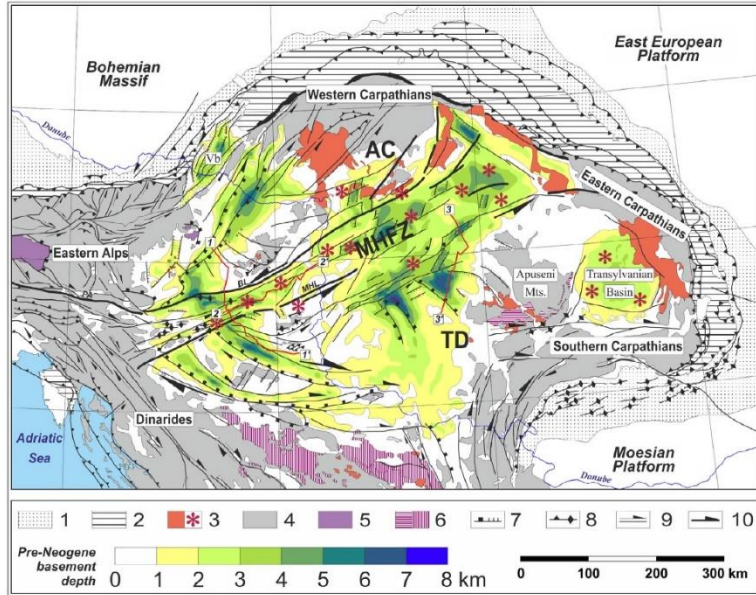

## Moho depth

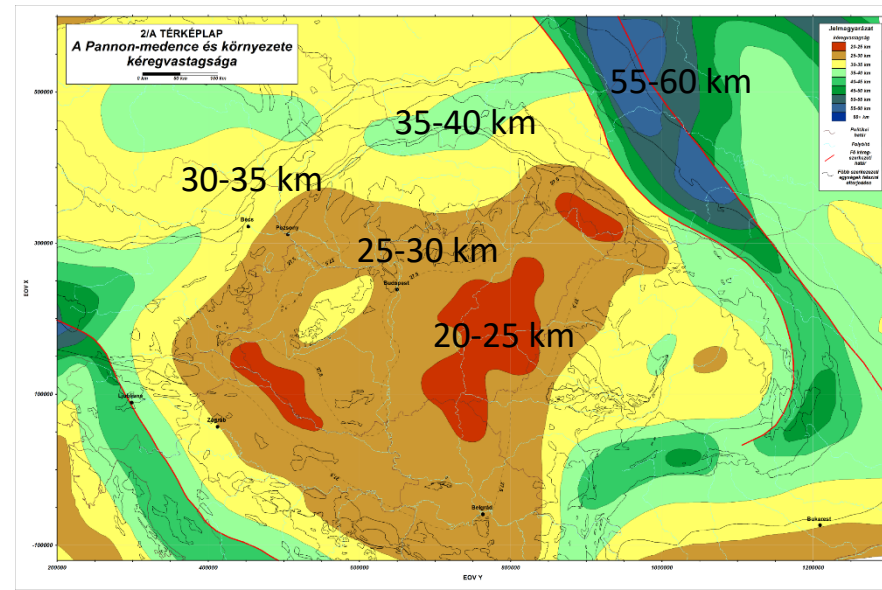

## LAB

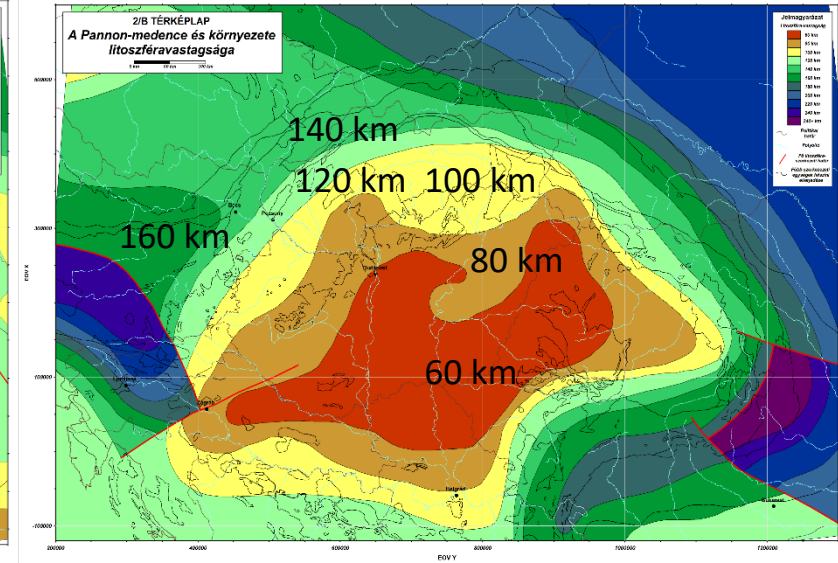

## Crustal thinning

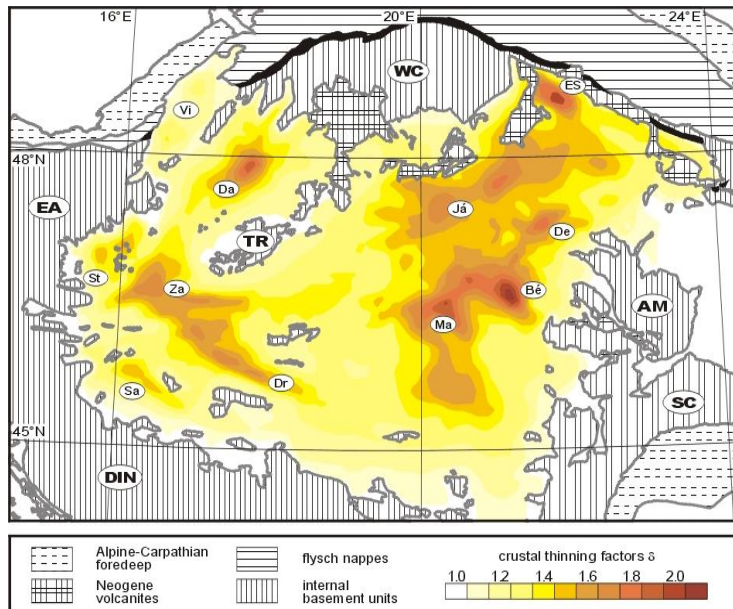

- Lithospheric thickness in the Pannonian Basin is ~50-60 km, while the depth of Moho varies in the range of 32–22 km, mirroring the first order pattern of the basement subsidence.
- In the Early and Middle Miocene during the retreat of the Carpathian slab, there was crustal extension and subsidence in the Pannonian region. From the Late Miocene, the whole lithosphere of the Pannonian basin extended in a uniform way.
- Moderate crustal extension was accompanied by large attenuation of the mantle lithosphere during the syn-rift phase, which lead to felsic magmas formation between 21 and 11 Myr.



# Thermal Conditions of the Pannonian Basin

## Geothermal Gradient

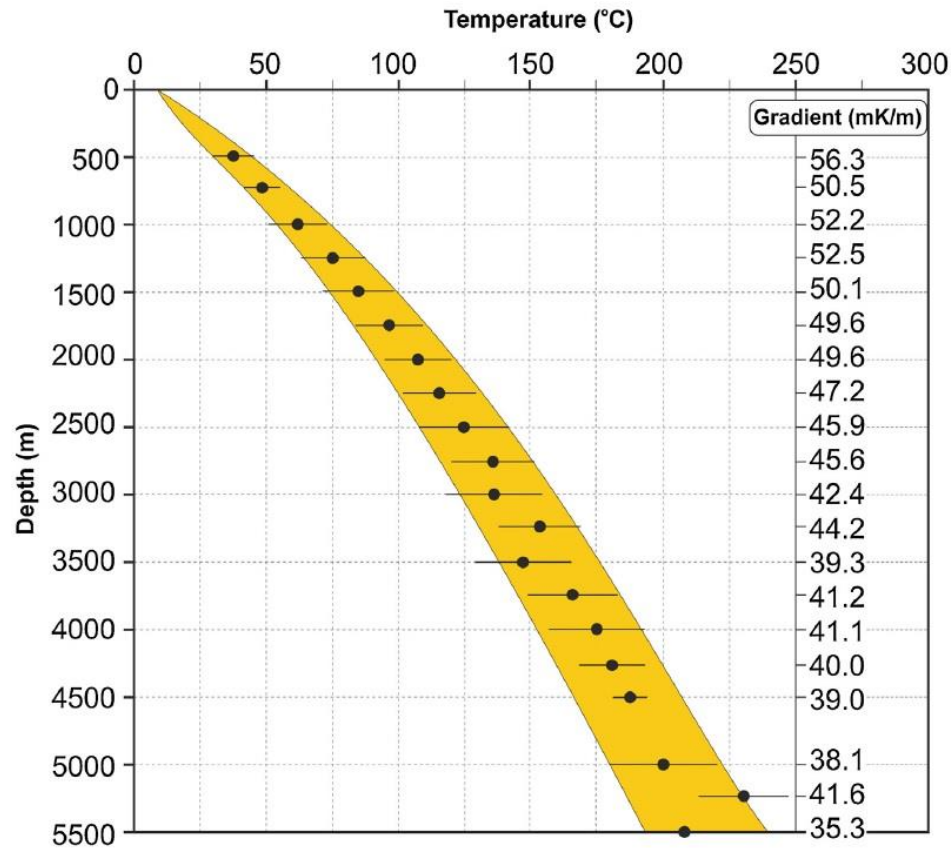

Horváth et al., 2015, Geothermics, 53

## Surface Heat Flow

(corrected for the variation in the sedimentation rate and the change in the thermal properties of sediments due to compaction)

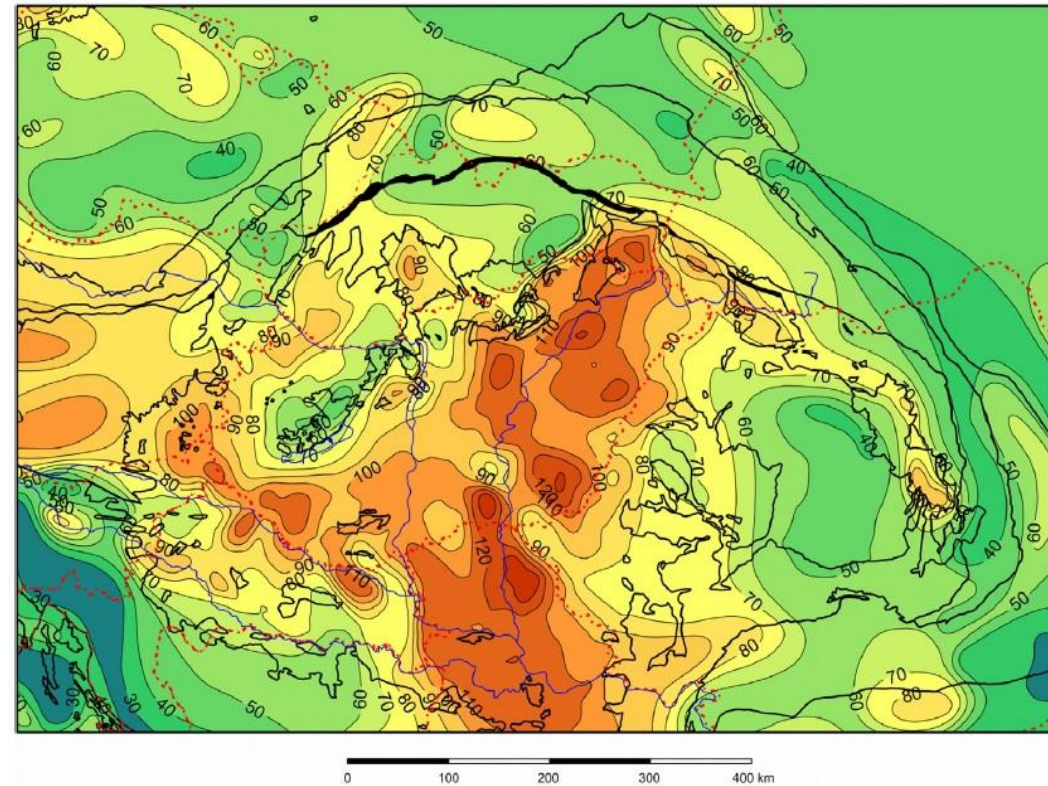

- Temperature gradient in the Pannonian basin varies between 40 and 50 mK/m (200°C at ~5 km).
- The heat flow distribution in the Pannonian basin shows values ranging from 50 to 130 mW/m<sup>2</sup>, with a mean value of about 100 mW/m<sup>2</sup>. The Carpathians and the Bohemian Massif show heat flow values of 50–70 mW/m<sup>2</sup>, while the Outer Dinarides exhibit extremely low heat flow (about 30 mW/m<sup>2</sup>) due to cooling by meteoric water inflowing at the high karst plateau (Mesozoic carbonate).

# The Alps-Carpathians-Pannonian Basin System

## Models of evolution

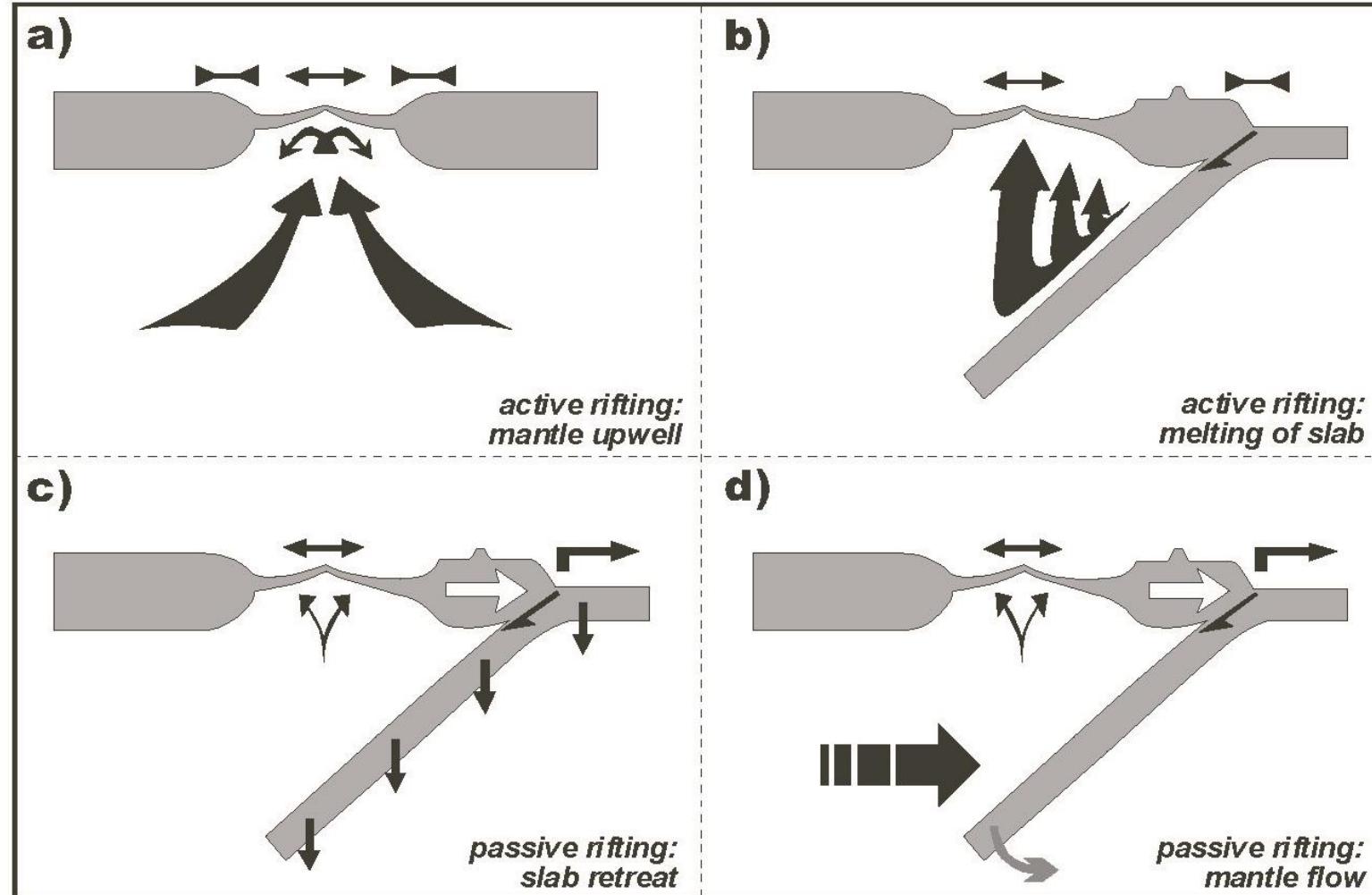

Bada and Horváth (2001)

- A first phase of passive rifting due to extensional stresses generated by slab rollback was followed by an active mantle lithosphere thinning as a result of buoyancy induced asthenospheric uprise beneath the rift.



# The Alps-Carpathians-Pannonian Basin System

## Lithospheric strength and EET variations

### EET variations

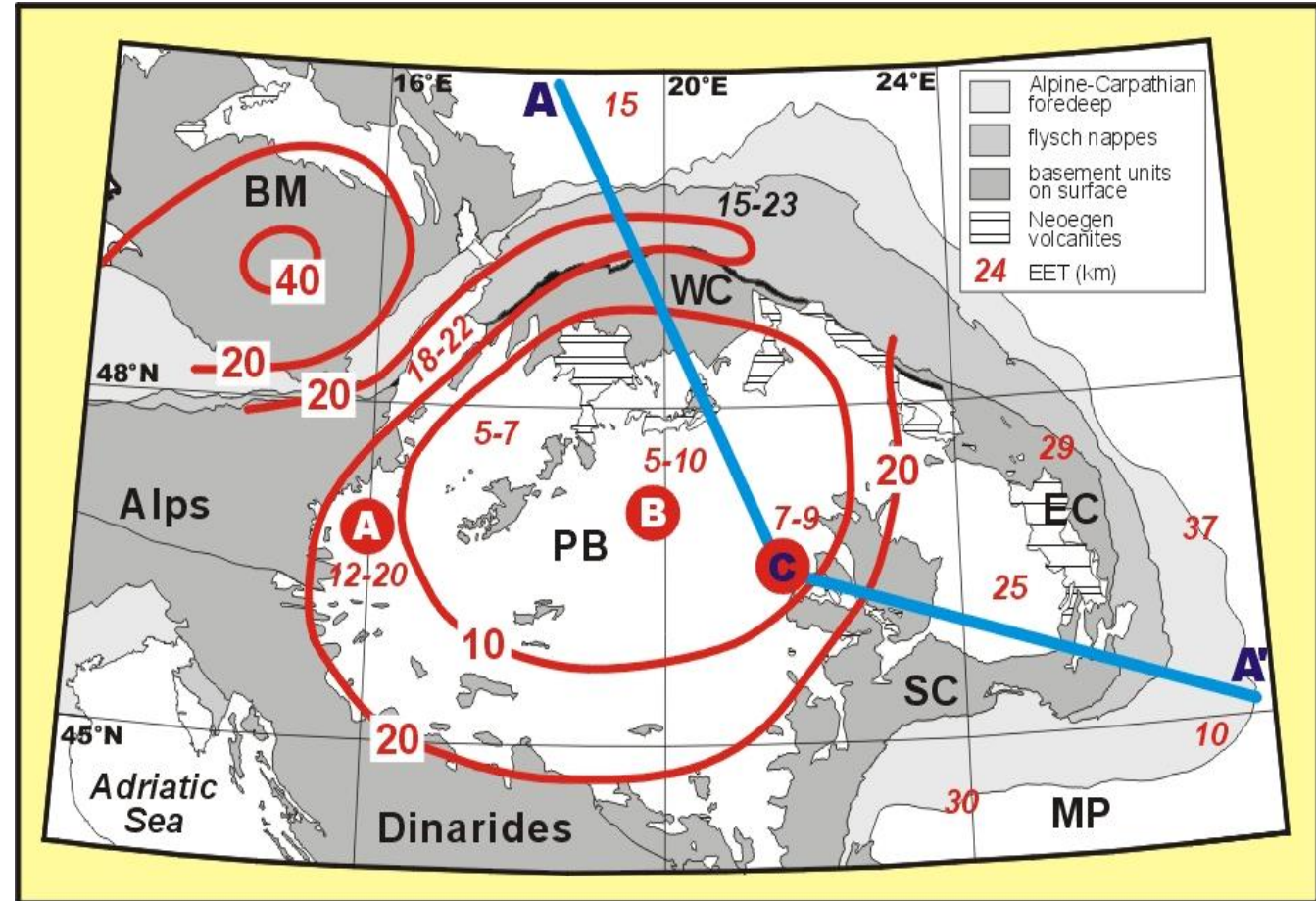
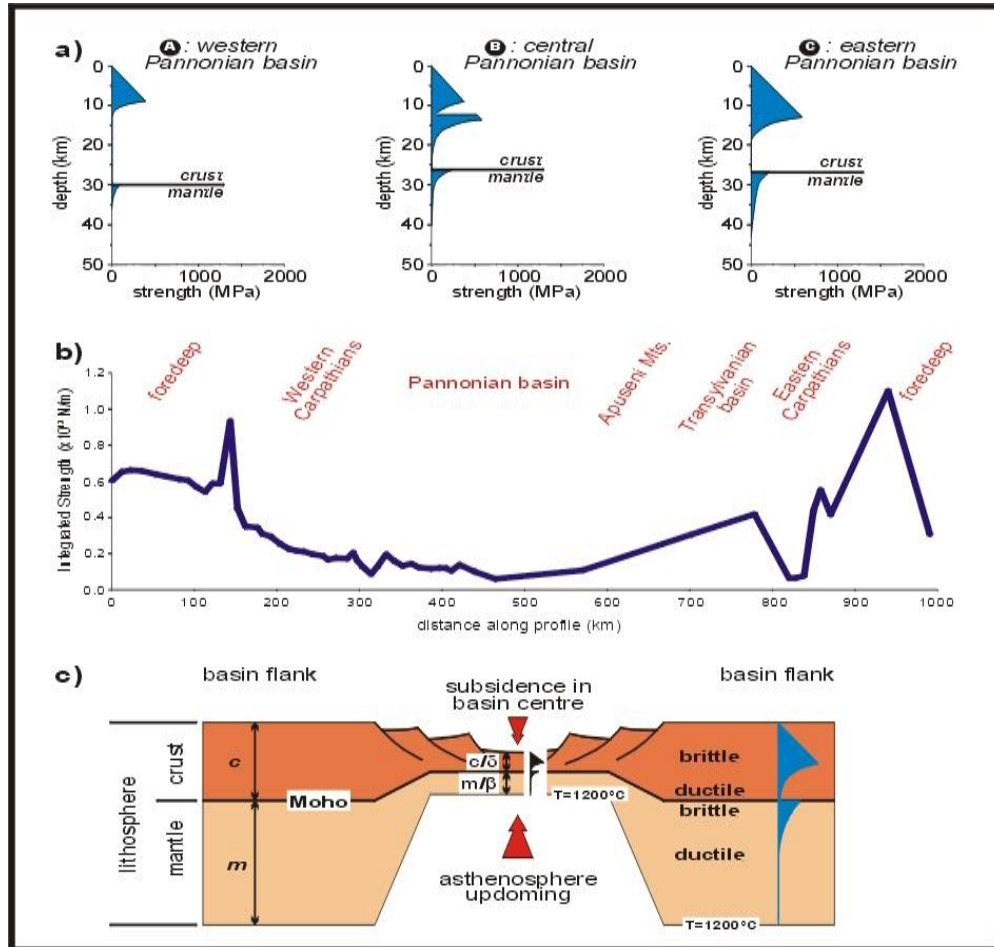

- Strength and elastic thickness variations reflect distinct mechanical characteristics and response of the different domains forming part of the Pannonian–Carpathian system to the present-day stress field.

# The Alps-Carpathians-Pannonian Basin System

## From extensional to compressional deformation

- Present stress state of the Pannonian– Carpathian system, is controlled by the **interplay between plate boundary** (counterclockwise rotational northward motion of the Adriatic microplate and its indentation into the Alpine-Dinaridic orogeny) and **intraplate buoyancy forces** associated with the elevated topography and related crustal thickness variation of the Alpine–Carpathian–Dinarides belt.
- Currently, the attenuated crust is under compression, which generates differential vertical movements.

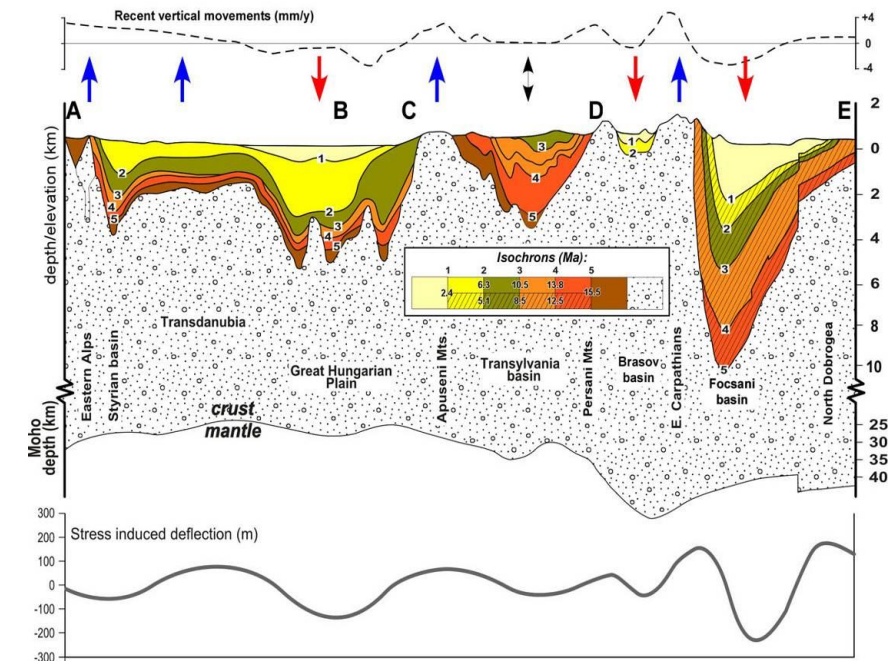
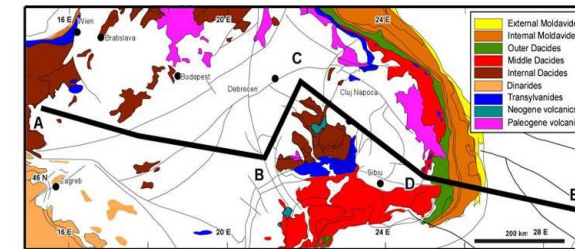
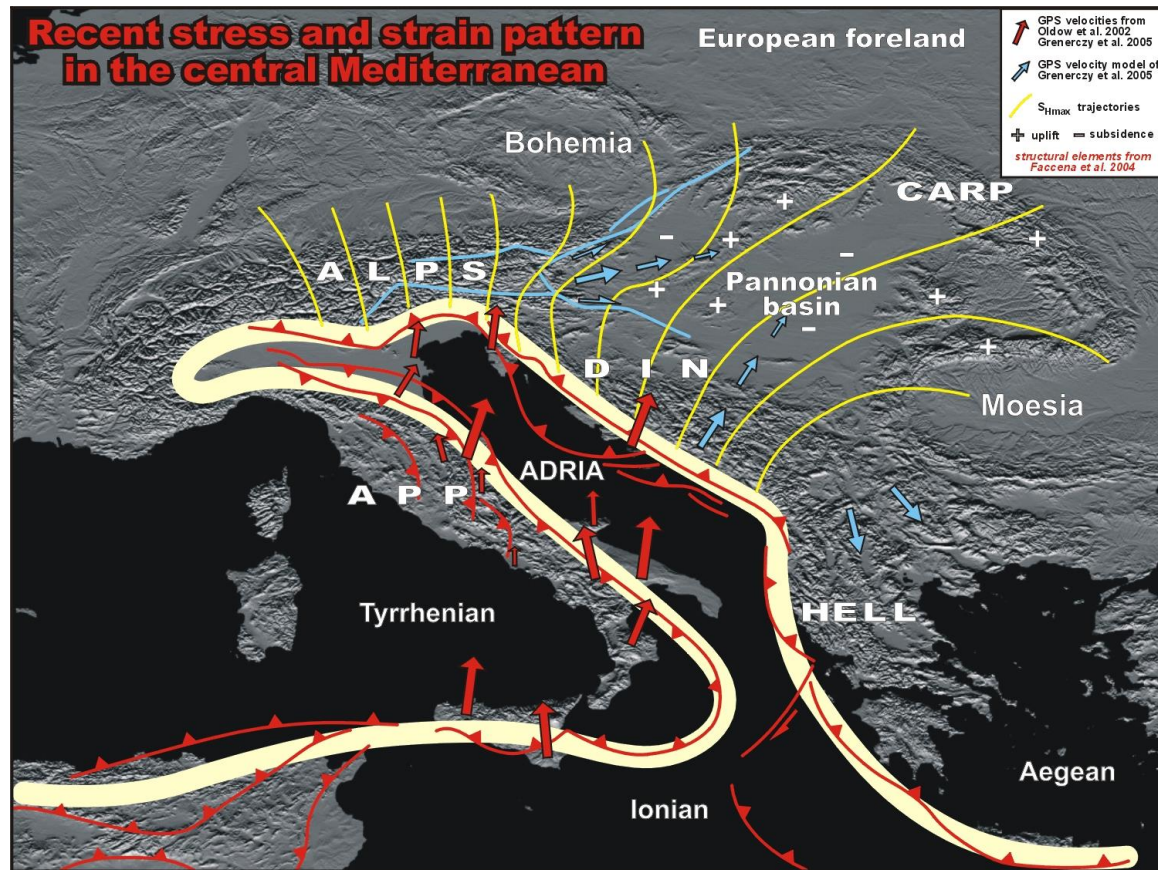



# The Alps-Carpathians-Pannonian Basin System

## From extensional to compressional deformation

- The initial syn-rift phase is characterized by rapid tectonic subsidence, starting synchronously at about 20 Myr in the entire Pannonian Basin.
- During the subsequent postrift phase much broader areas began to subside, the subsidence is particularly evident in the central parts of the Pannonian Basin (where the mantle lithosphere was greatly thinned).
- The final phase of basin evolution is characterized by the gradual structural inversion of the Pannonian Basin system during the Late Pliocene–Quaternary, which was associated with late stage subsidence anomalies and differential vertical motions.

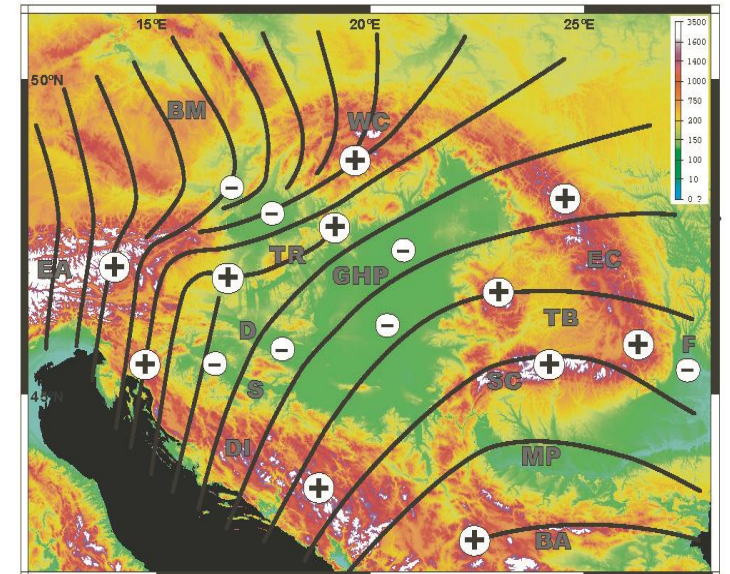
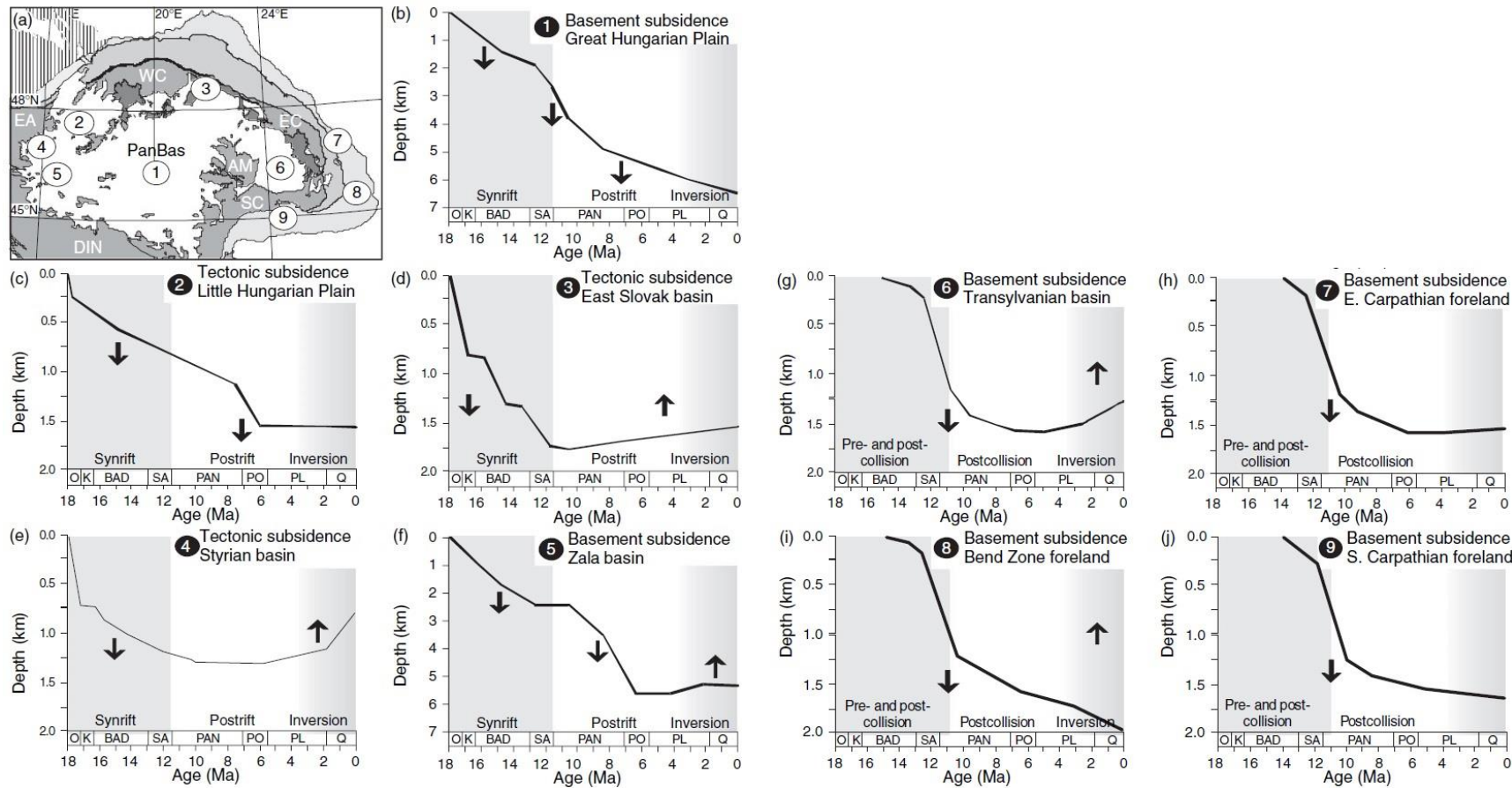

# Passive continental margins

**Transition from rifting to sea floor spreading include:**

- Post-rift subsidence and stretching
- Detachment faulting, mantle exhumation, and ocean crust formation

**Passive continental margins involve:**

- 1) Attenuated continental crust stretched over a region of 50-150 km (or more).
- 2) Seismically inactive and normal heat flow.
- 3) Seaward-thickening prisms of marine sediments overlying a faulted basement with syn-rift sedimentary sequences of continental origin.

**Differences between volcanic and non-volcanic margins:**

- Abundance of volcanic products
- Thickness of sediments
- Presence/absence of salt tectonics in the post-rift phase

# Passive continental margins

(a) Symmetric (pure shear)

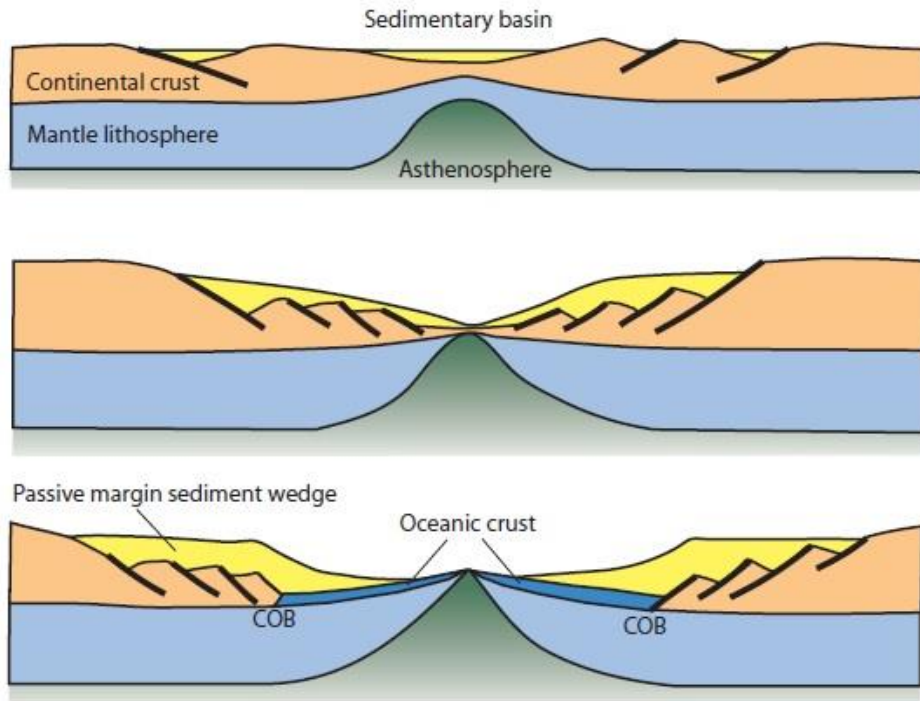

Simple shear deformation can lead to the development of asymmetric passive margins:

- The **upper plate margin** is less structured and preserves a continued pre-rift stratigraphic section (lithospheric mantle is more extended than crust).
- The **lower plate margin** is formed from highly structured exhumed rocks overlain by tilted crustal blocks, as a result of movements on listric normal faults (crust is more extended than lithospheric mantle).

(b) Asymmetric (simple shear)

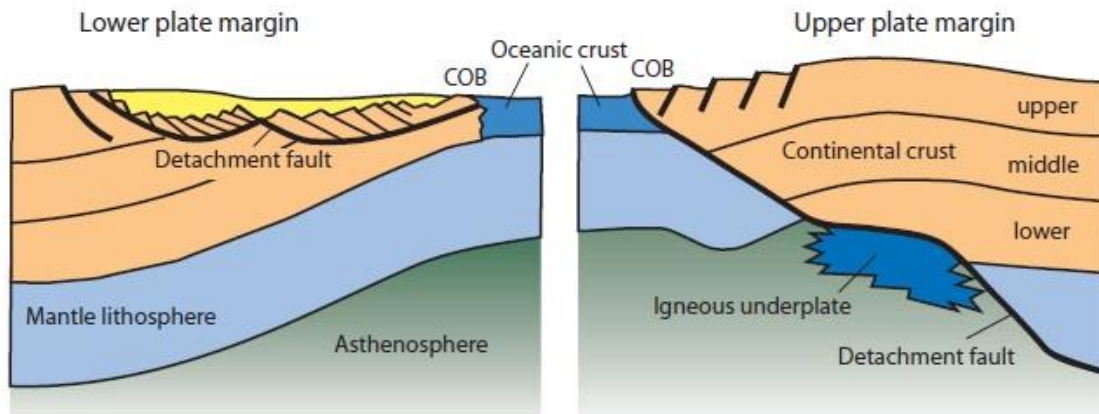

# Passive continental margins

Strength (MPa)/temperature

## Upper Plate Passive Margins

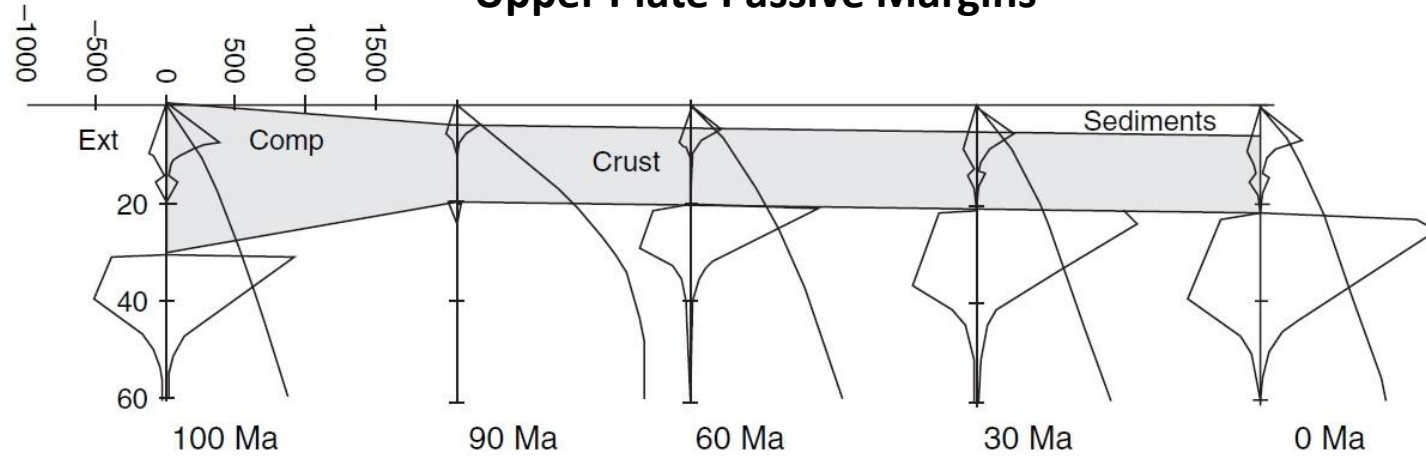

$$\delta=2 \quad \beta=10$$

## Lower Plate Passive Margins

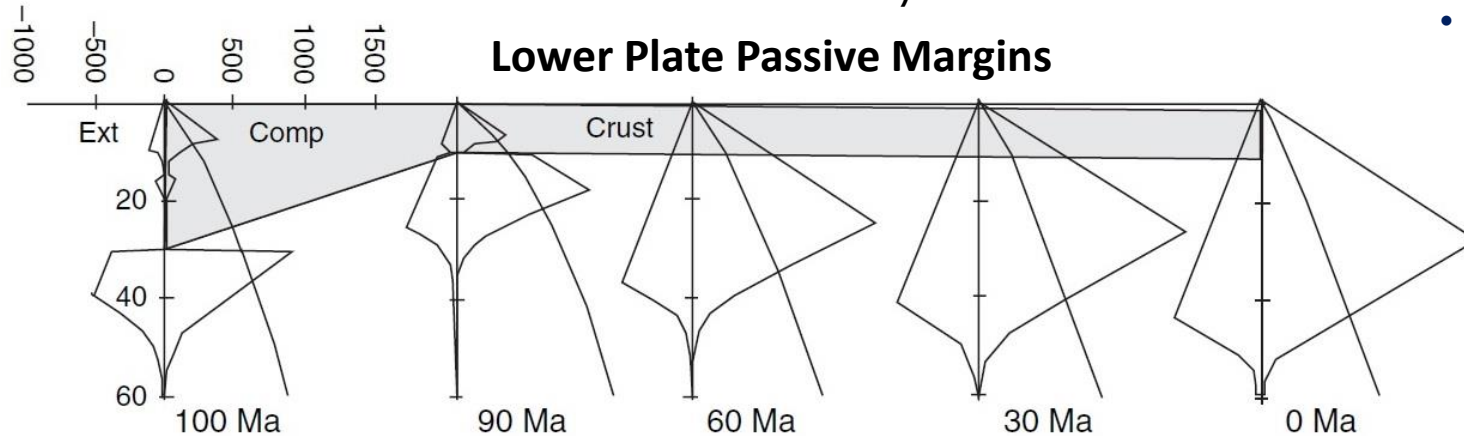

$$\delta=3 \quad \beta=1.1$$

- At the moment of crustal separation, **upper plate margin** is very weak due to strong attenuation of the mantle-lithosphere and the ascent of the asthenospheric material close to the base of the crust.
- During the post-rift evolution of upper plate margin, the strength of the lithosphere is controlled by the youthfulness of its lithospheric mantle and its thicker crust, and later by the thermal blanketing effect of sediments infilling the available accommodation space.
- Thus, the strength of the lithosphere increases gradually as new mantle is accreted to its base and cools during the re-equilibration of the lithosphere with the asthenosphere.

Cloetingh and Ziegler, 2009

- The evolution of a sediment starved **lower plate margin** with a crustal thickness of 10 km is characterized by a syn-rift and post-rift stage strength increase.



# Passive continental margins

## Comparison with the strength of an oceanic plate

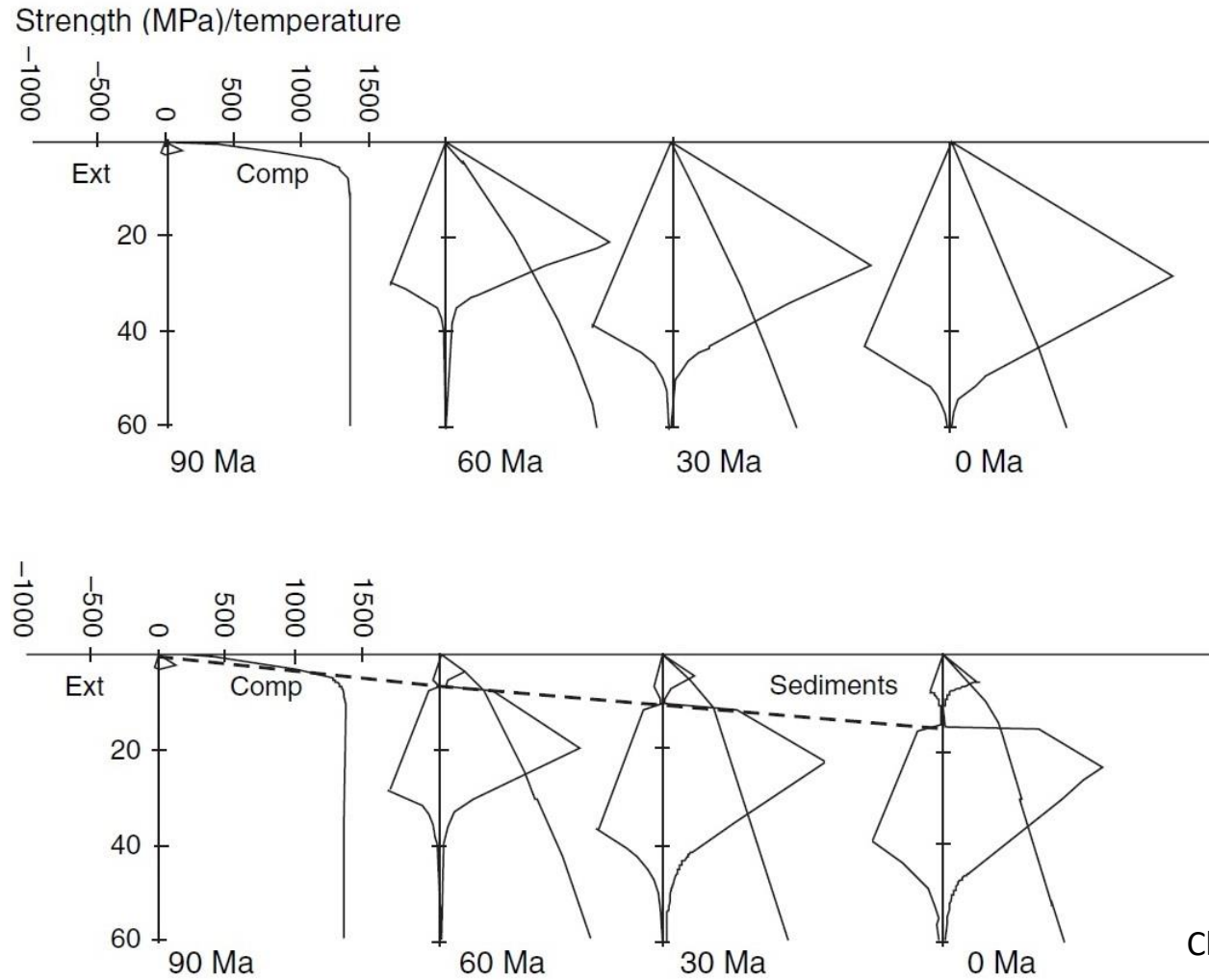

Cloetingh and Ziegler, 2009

- The strength of oceanic lithosphere, that is covered by thin sediments only, increases dramatically during its 90 Myr evolution and ultimately exceeds the strength of both margins, even if these are sediment starved.
- The strength of 90 Myr old oceanic lithosphere that has been progressively covered by very thick sediments is significantly reduced.

# Passive continental margins

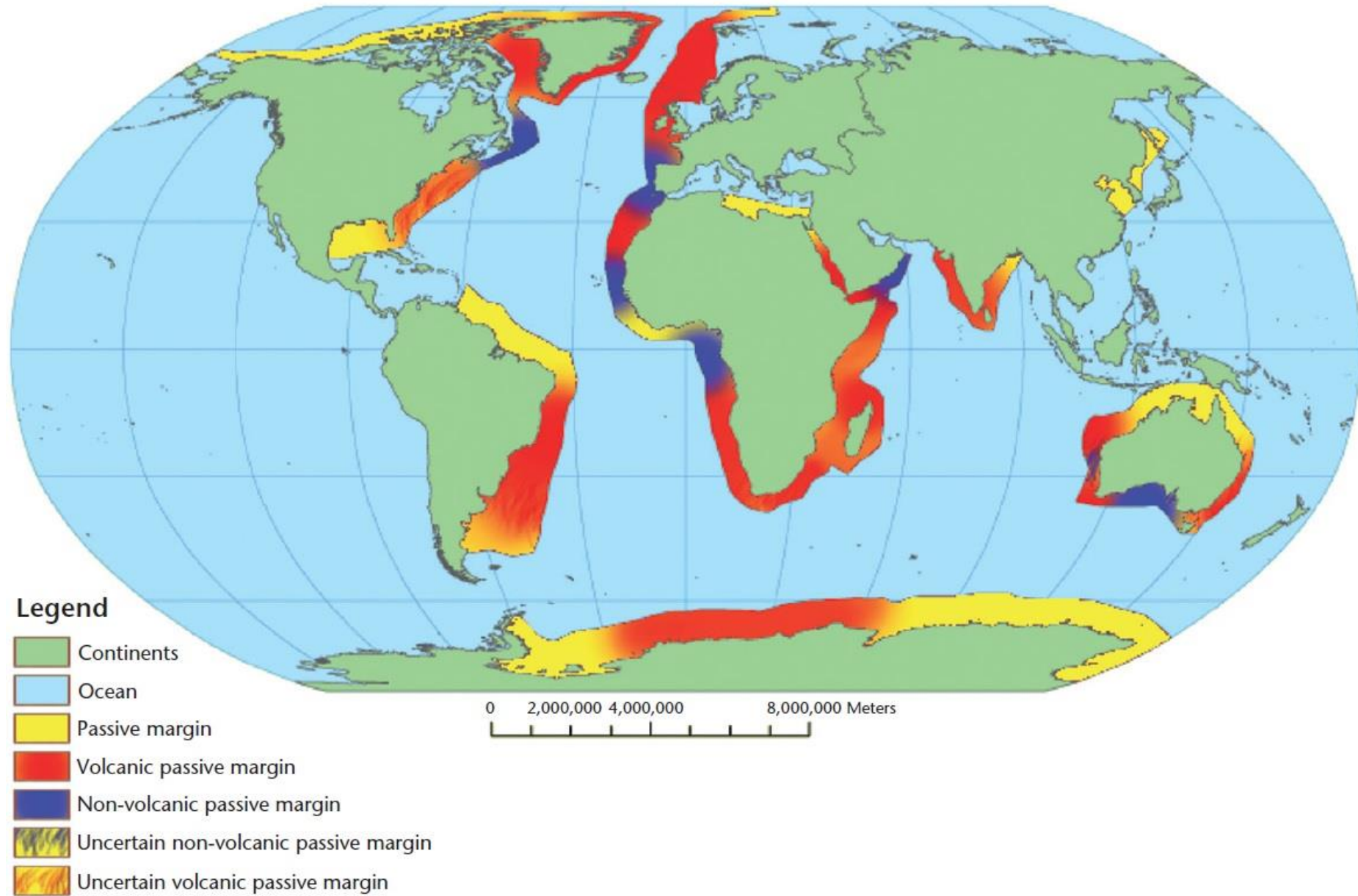

# Magmatic and Amagmatic Passive Margins

**a Mode 1 normal-magmatic margins**

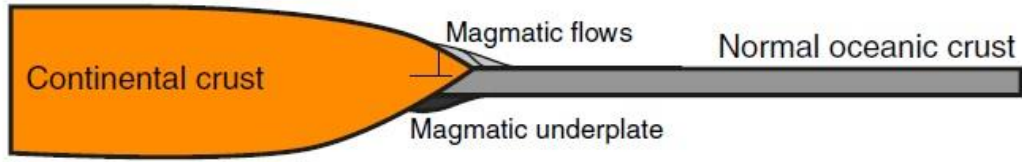

**b Mode 2 excess-magmatic margins**

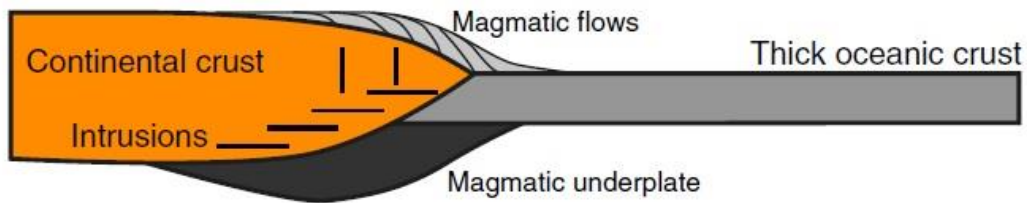

**c Mode 3 a-magmatic margins**

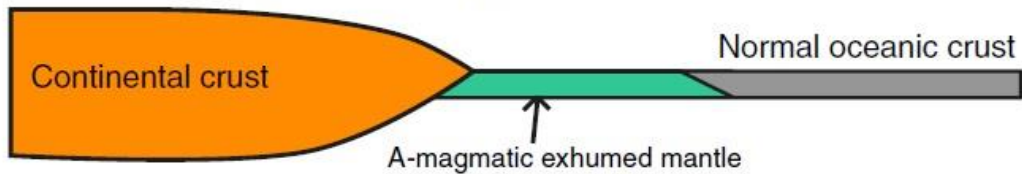

**d N Lofoten**

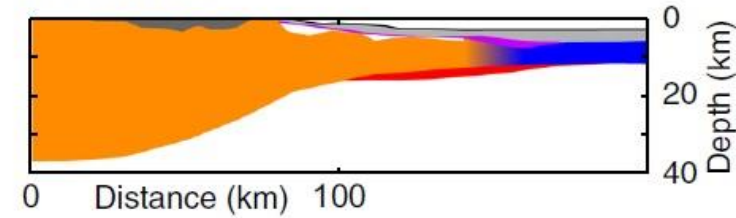

**e Walvis**

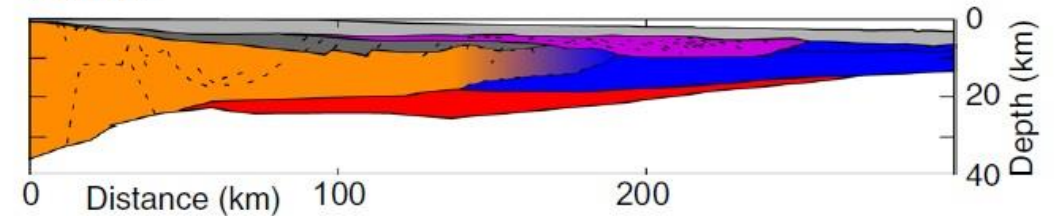

**f S Newfoundland**

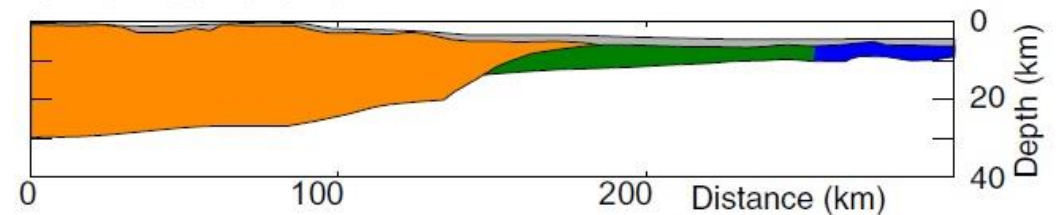

Lu and Huisman, 2021, Nature Communications, 12

**Normal-Magmatic margins:** Margins with a sharp transition from the continent-ocean boundary (COB) to normal thickness (4–8 km) magmatic oceanic crust.

**Excess-magmatic margins:** Margins where magmatic productivity exceeds that expected from decompression melting at normal mantle temperature (presence of high volumes of magmatic underplating)

**Magma-poor (a-magmatic) margins:** Margins having little syn-rift magmatism, in some cases exhibiting a broad zone of exhumed mantle with little to no magmatism at the sea floor preceding formation of mature oceanic crust.

# Magmatic and Amagmatic Passive Margins

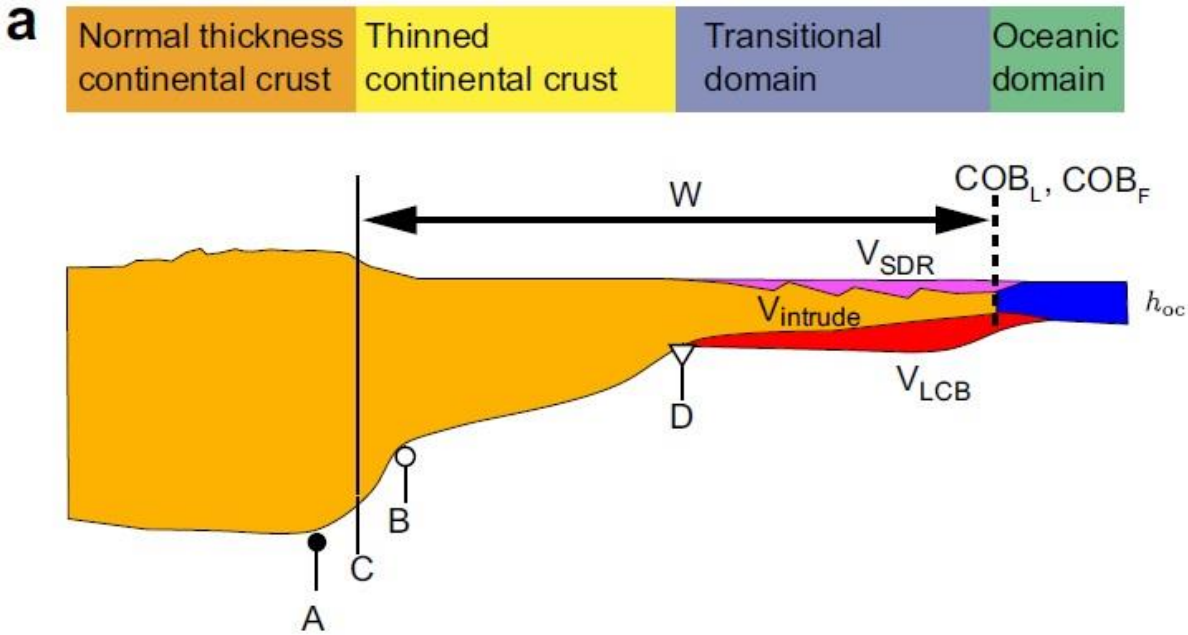

- Margin width is defined by the distance between the termination of unthinned continental crust and the continental ocean boundary (COB).
- The termination of unthinned continental crust is defined at the mid point of taper zone that starts from the first crustal thinning (point A) and stops at the location where the Moho reaches a depth of 20 km or flattens after rapid thinning (point B).

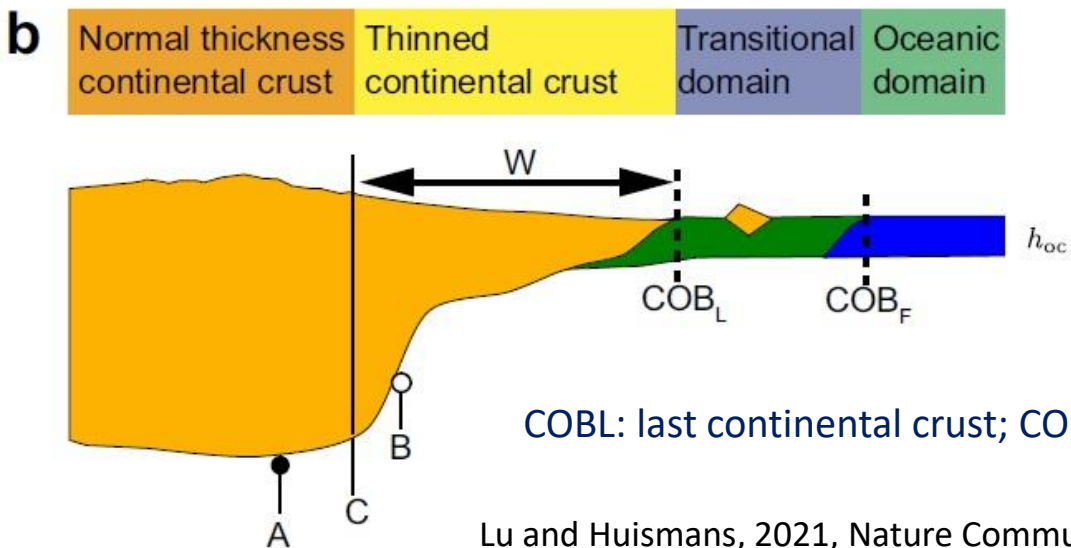



# Magmatic and Amagmatic Passive Margins

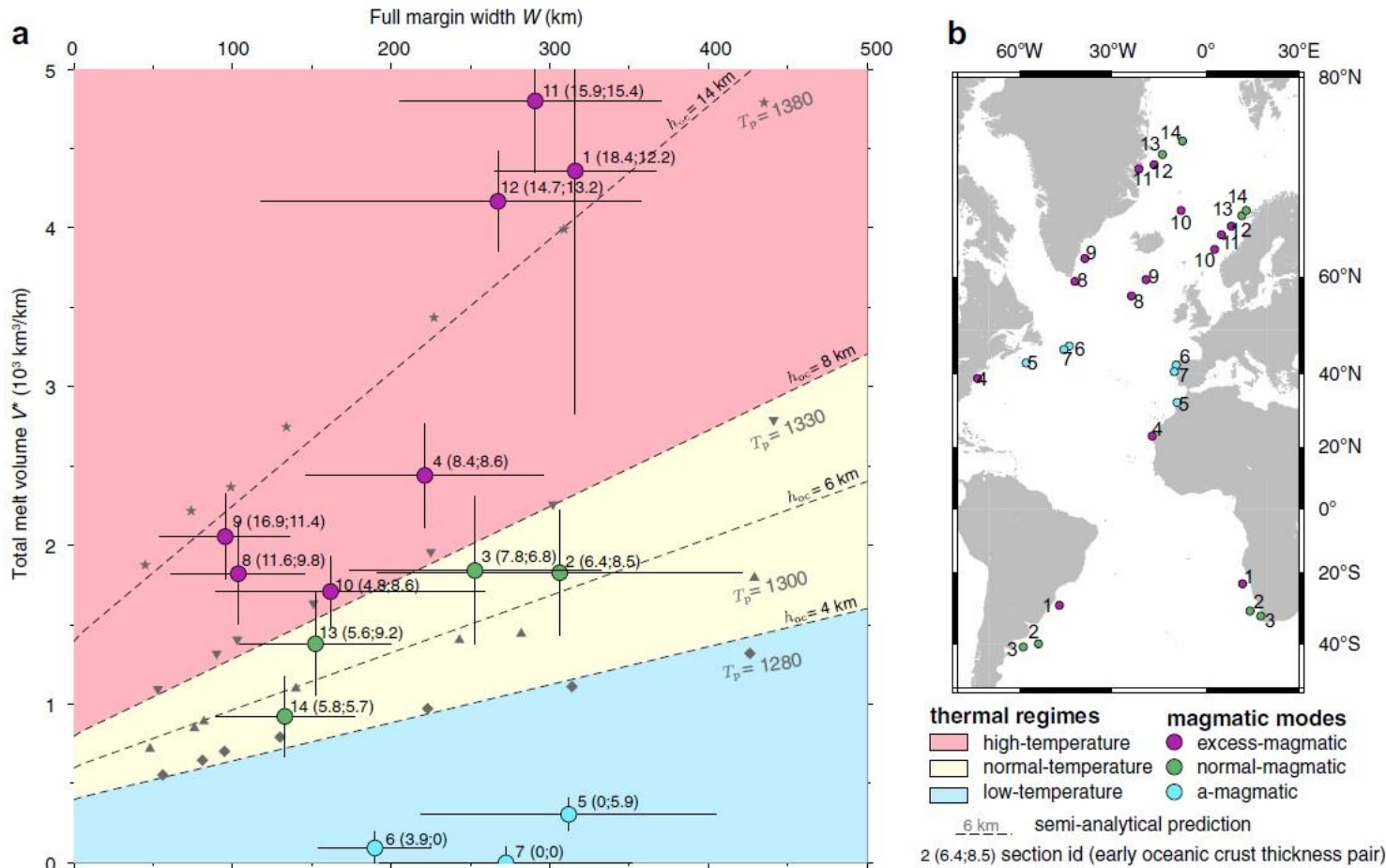

- **Excess magmatic conjugate margins** include: some characterized by only moderately excess activity (e.g., East US–West African margin) and others with clear excess-magmatic volume versus width (e.g., Vøring–East Greenland margin), interpreted as related to the Iceland plume, but having potential temperature anomaly in the order of 50–80 °C.
- **Poor magmatic margins** are possibly caused by: Low mantle potential temperature, slow spreading rate, compositional inheritance

Lu and Huisman, 2021, Nature Communications, 12

**1** Pelotas–Walvis **2** Colorado N–Orange **3** Colorado S–Orange **4** Baltimore–Dakhla **5** Morocco–Nova Scotia **6** Newfoundland N–Iberia **7** Newfoundland S–Iberia **8** SE Greenland–Edoras **9** SE Greenland–Hatton Bank **10** Jan Mayen–Møre **11** NE Greenland–Vøring **12** NE Greenland–Vøring **13** NE Greenland–Lofoten **14** NE Greenland–Lofoten N.

Given the dependency of oceanic crustal thickness on potential temperature, the melt volume margin width space can be divided into three temperature regimes: **(1)** a normal temperature regime (1280–1330 °C) with  $h_{oc}$  in the range of 4–8 km, **(2)** a high-temperature regime (>1330 °C) with  $h_{oc}$  > 8 km and **(3)** a low-temperature regime (<1280 °C) with  $h_{oc}$  < 4 km.

## Magmatic and Amagmatic Passive Margins

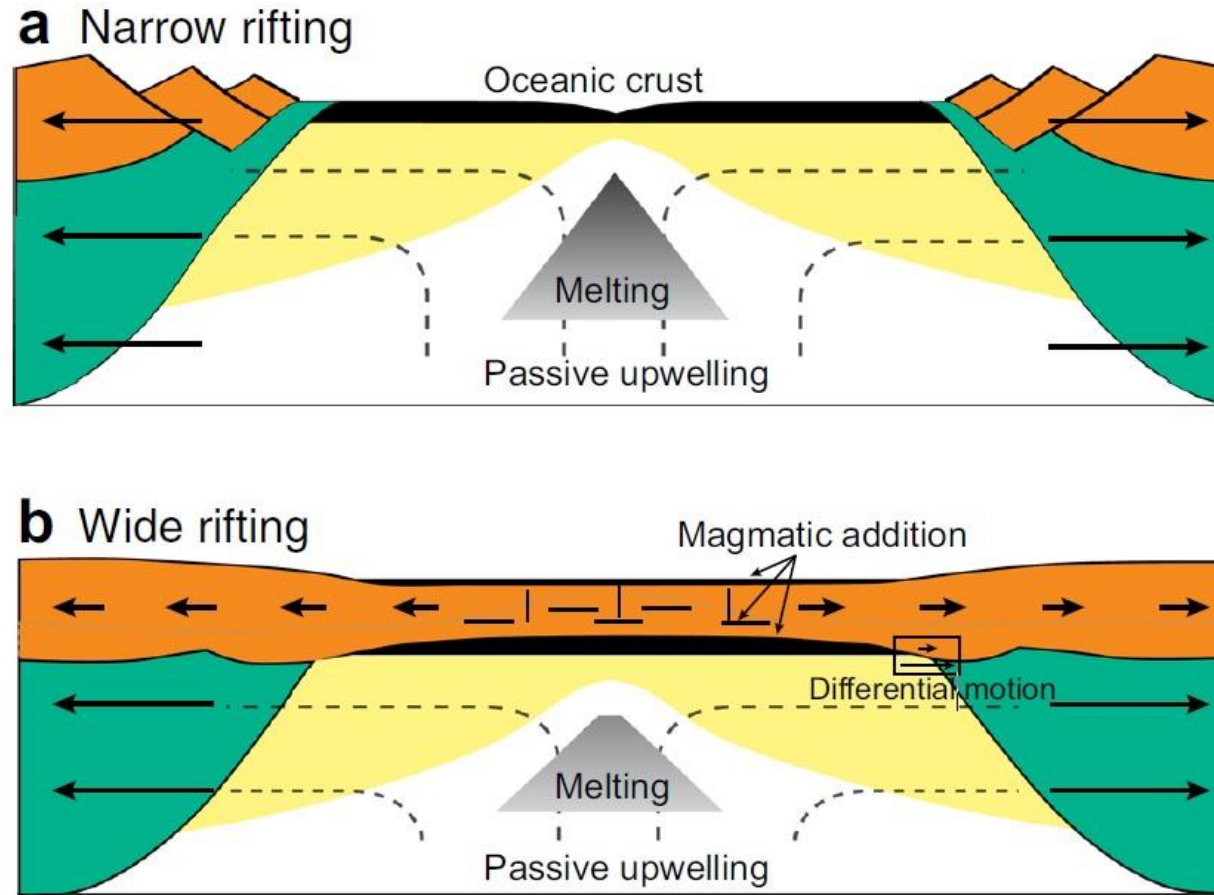

- Narrow margins with simultaneous rupture of crust (orange) and mantle lithosphere (green), having normal potential temperature mantle are expected to lead to a sharp transition from thinned continental crust to normal thickness oceanic crust.
- Depth-dependent extension with distributed deformation in the crust (orange) and narrow rupture of the mantle lithosphere (green), with preferential removal of the mantle lithosphere results in early melt addition in wide margins without requiring anomalously high mantle temperature.

# Volcanic margins (Lofoten-Vesteralen margin)

Rifted volcanic margins are defined by :

1. thick flood basalts and silicic volcanic sequences,
2. high velocity ( $V_p > 7 \text{ km s}^{-1}$ ) lower crust in the continent–ocean transition zone
3. thick sequences of volcanic and sedimentary strata (*seaward-dipping reflectors* on seismic reflection profiles)

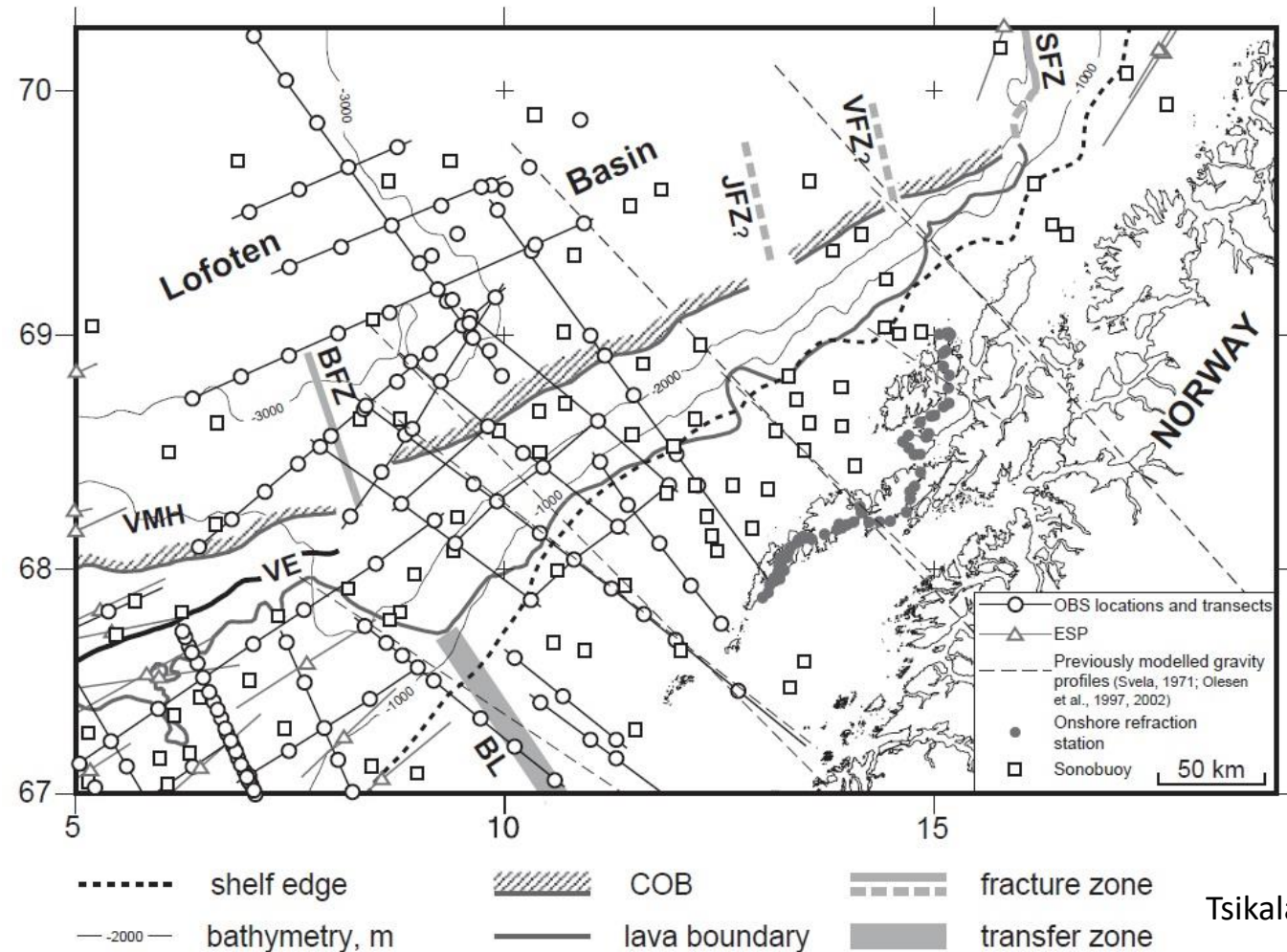

# Volcanic margins (Lofoten-Vesteralen margin)

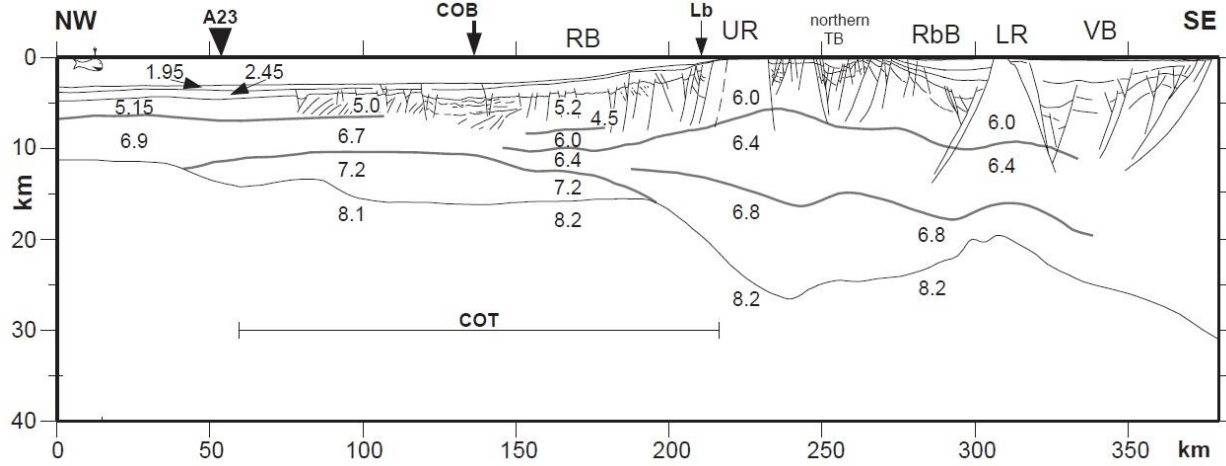

Tsikalas et al., 2005, Tectonophysics, 404

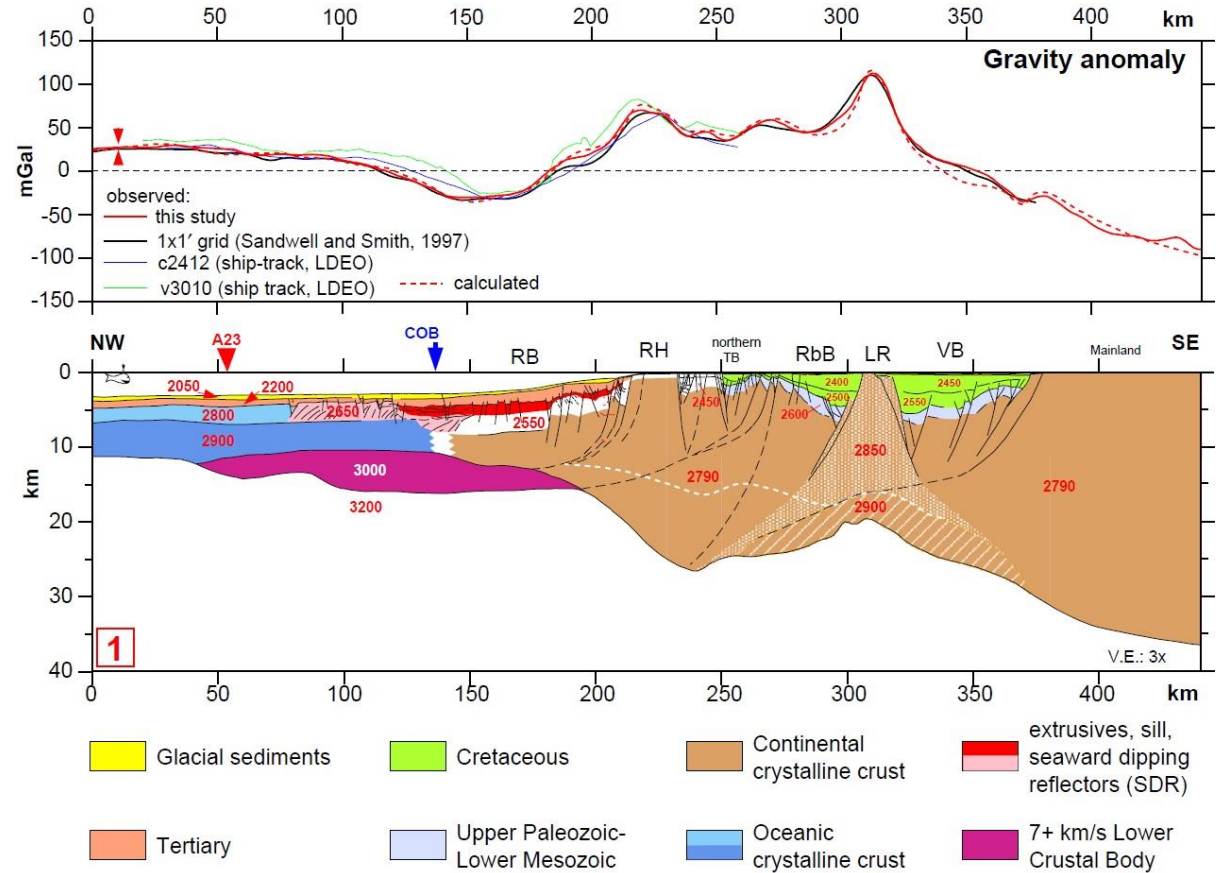

OCTZ=Ocean-Continent Transition Zone

- **OCTZ is usually 50-150 km wide and characterized by an abrupt lateral gradient in crustal thinning, covered by layers of volcanic material and by seaward dipping faults**



# Non-volcanic margins

## (Southern Iberia Abyssal Plain, Galicia Bank, and west Greenland margins)

**Possible causes of absence of large volumes of magma in passive margins:**

- (1) the effects of prior melting episodes, (2) convective cooling of hot asthenosphere, (3) the rate of mantle upwelling: If the rate is slow and the upwelling mantle is cooled, melt-depleted asthenosphere is pulled up under the active part of the rift during the transition to sea floor spreading, its presence would suppress further melting, even more if the rate of rifting is slow.
- The transition from rift to oceanic crust at nonvolcanic margins is fundamentally asymmetric and involves a period of magmatic starvation that leads to the exhumation of the mantle

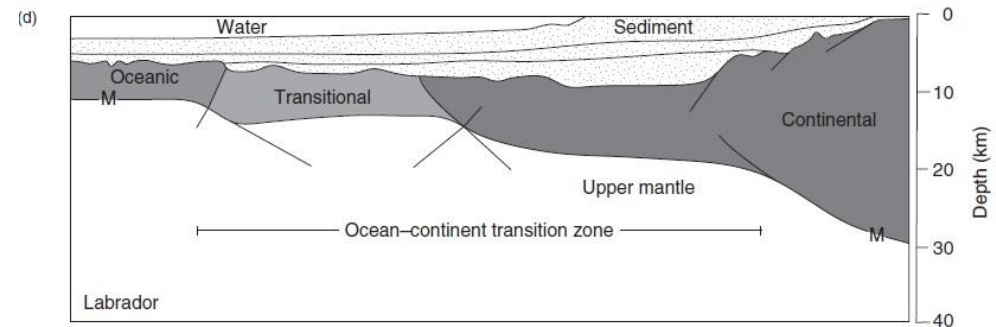
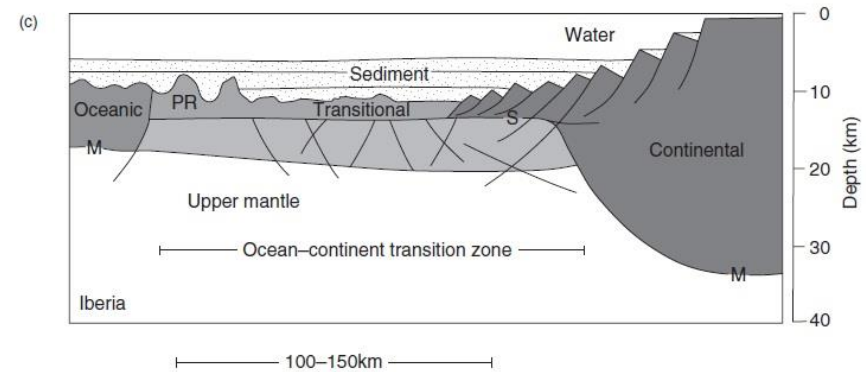
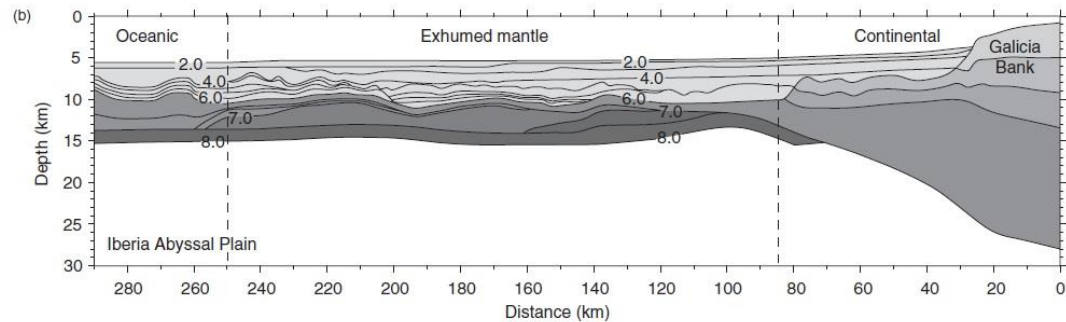
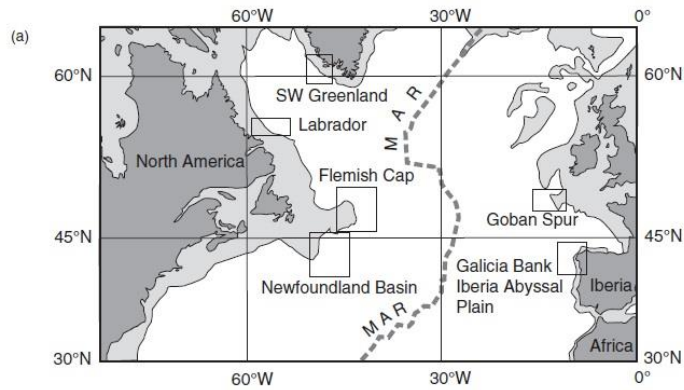

- In these margins rifting of the continent produced a smooth transition toward thin crust having tilted fault blocks, underlain by a sub-horizontal reflector, representing serpentinized zone at crust-mantle boundary.

# Evolution of magma-poor continental margins

## Iberian Margin

The total extension accommodated by the detachment faults LD, HD and HHD is around 34 km and this occurred about 130 Myr ago in 9 Myr .

- a)** Initial situation with four-layer rheology and crust locally thickened by pre-rift underplated gabbro.
- b)** Initially the upper mantle updomes beneath the gabbros where it was weakest, allowing the asthenosphere to rise (little crustal thinning and subsidence occurred above this region, while the adjacent areas were strongly thinned).
- c)** The thermal structure and gravitational response associated with the rising asthenosphere started to influence the rifting, which was localized at the margin of the relatively weak, extended crust. This allows the important initial thinning of the lower crust and its observed abrupt transition to weakly thinned crust.
- d)** The asthenosphere ascended close to the surface and mid-ocean-ridge basalt melts were intruded into sub-continental mantle. Deeper mantle layers were exhumed oceanward. Eventually, increasing melt production led to the creation of 'continuous' oceanic crust.

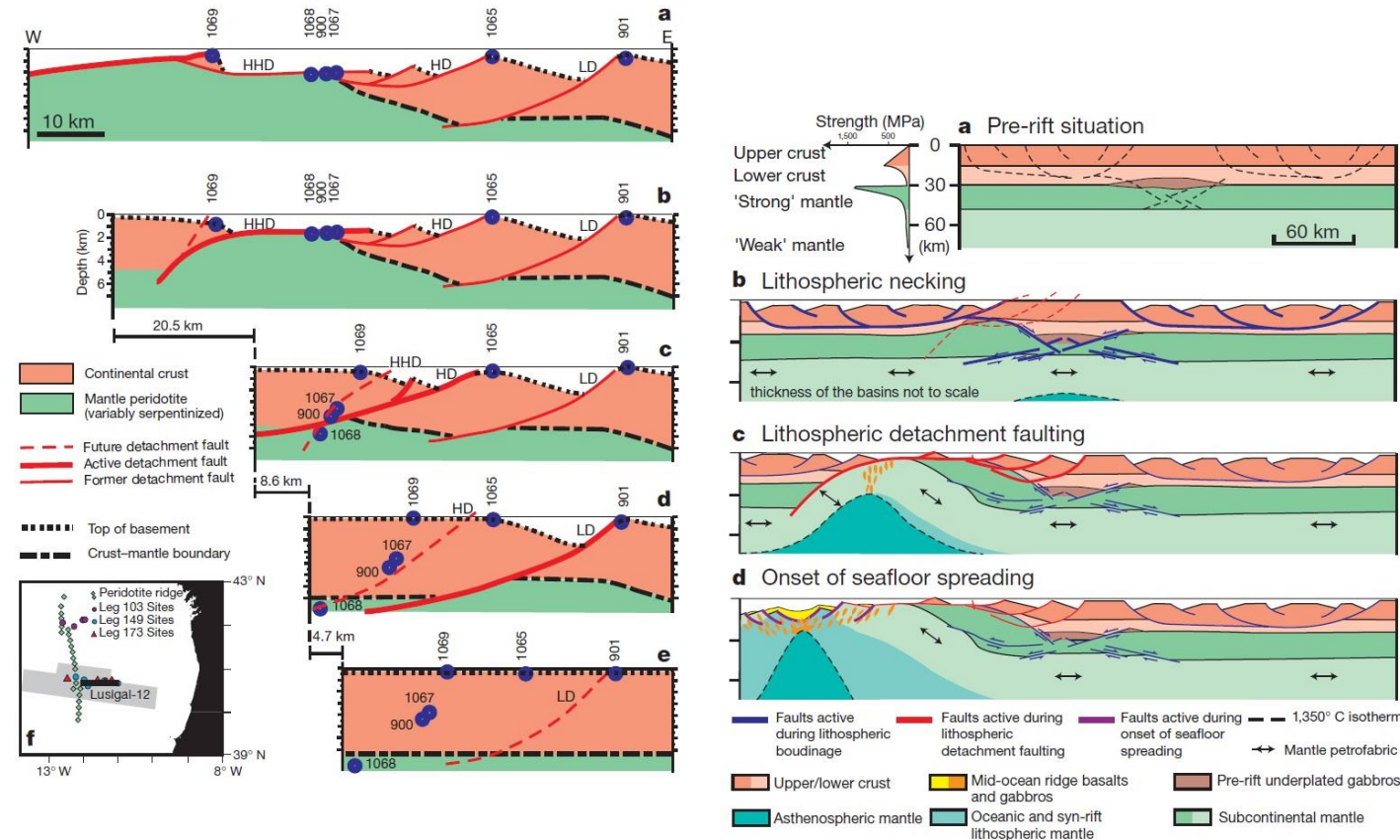

Whitmarsh et al., 2001, Nature

- The change in extensional geometry from listric to one or more concave-downward faults reflected a change in the distribution of weak layers:** Whereas listric faults are missed in horizontal weak layers, concave-downward faults might be favoured by sub-vertical weak zones, possibly resulting from rising magma and higher thermal gradients.

# Influence of rift velocity on the shape of continental margins

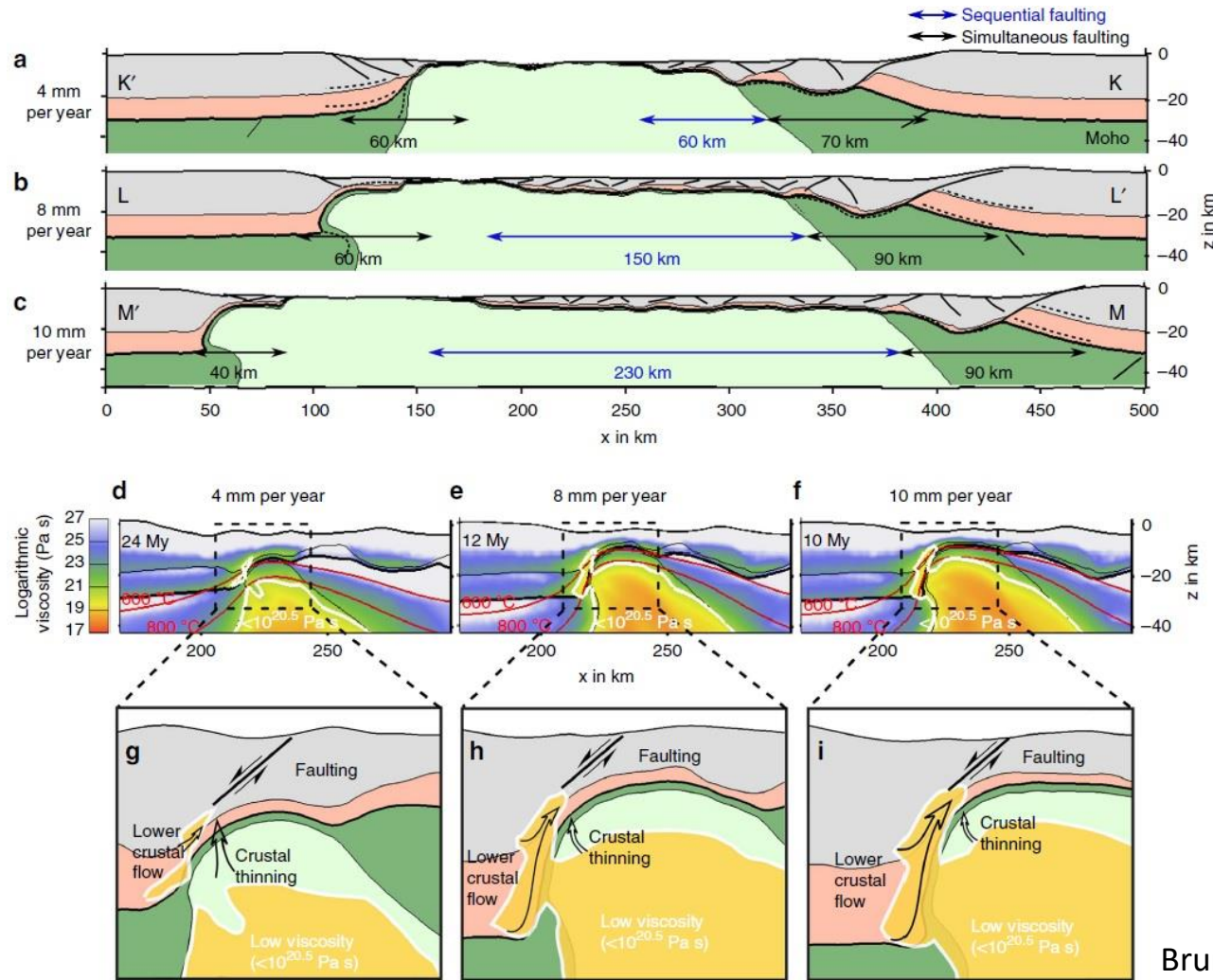

Brune et al., 2014, Nature Communications, 5

- The model with slow extension generates moderately asymmetric margins.
- Higher velocities lead to advection of the isotherms to shallower depths. This heats the lower crust more efficiently, forming a weaker and larger exhumation channel.
- Favored lower crustal flow counteracts fault-controlled crustal thinning and prolongs the phase of rift migration leading to a wider margin.
- Wide margins are generated by short-lived, sequentially active normal faults that accomplish lateral rift migration.



# Influence of thermal conditions on the shape of continental margins

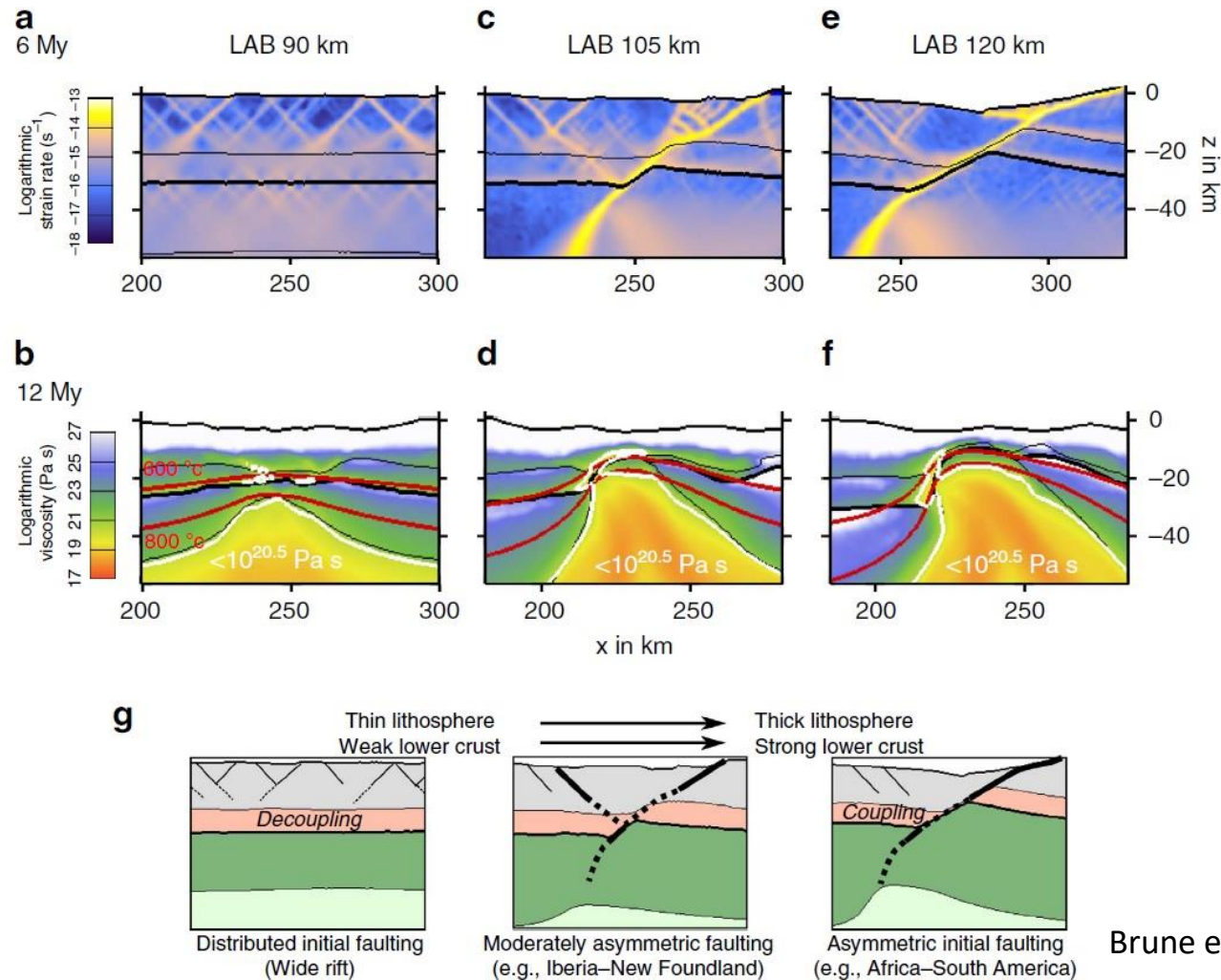

Brune et al., 2014, Nature Communications, 5

- Thin (90 km) and hence hot lithosphere favours crust–mantle decoupling, pure shear deformation, and distributed faulting without rift migration.
- Intermediate thick lithosphere results in initially pure shear straining with moderately asymmetric faulting and generates a small low-viscosity pocket and a short rift migration phase.
- A thick lithosphere (120 km) involves strong crust–mantle coupling and generates a large low-viscosity pocket.



# Genetic link between tectonic style and COT nature at magma-poor conjugate margins

Margins that undergo a prolonged phase of wide rifting tend to show a magmatic dominated COTZ, while those that undergo a dominant narrow extension phase and those which extended very slowly (< 5 mm/yr) usually show a COTZ consisting of exhumed serpentinized mantle.

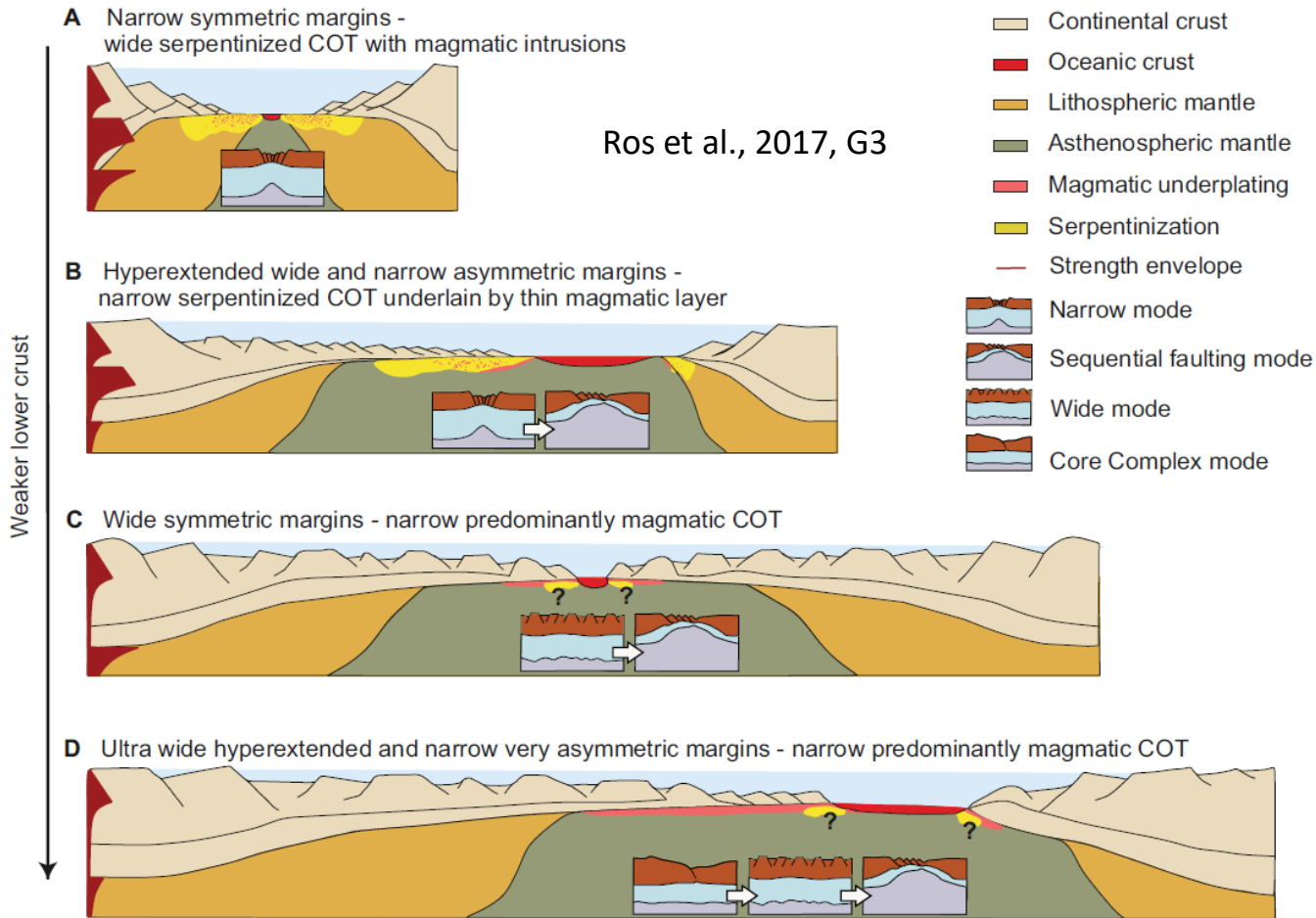

- Very slow extension velocities (< 5 mm/yr) and a strong lower crust lead to margins characterized by large fault offsets (> 5 km), abrupt crustal thinning, mainly oceanward dipping faults and large syn-rift subsidence.
- These margins present a COTZ with exhumed serpentinized mantle underlain by some magmatic products.

- A weak lower crust promotes margins with a gradual crustal thinning, small faults dipping both ocean- and landward and small syn-rift subsidence.
- These margins are predominantly magmatic at any ultra-slow extension velocity and perhaps underlain by some serpentinized mantle.

(a) Mafic granulite and thin lower crust. (b) Mafic granulite and thick lower crust. (c) Wet quartzite and thin lower crust. (d) Wet quartzite and thick lower crust. Boxes show the mode evolution for each of the tectonic styles.

# Plume-lithosphere interactions in rifted margin tectonic settings

Iceland plume shows lobes extending into southern Norway, the British Isles, and central Europe. All of these areas are undergoing recent uplift in an intraplate tectonic setting, far from plate boundaries

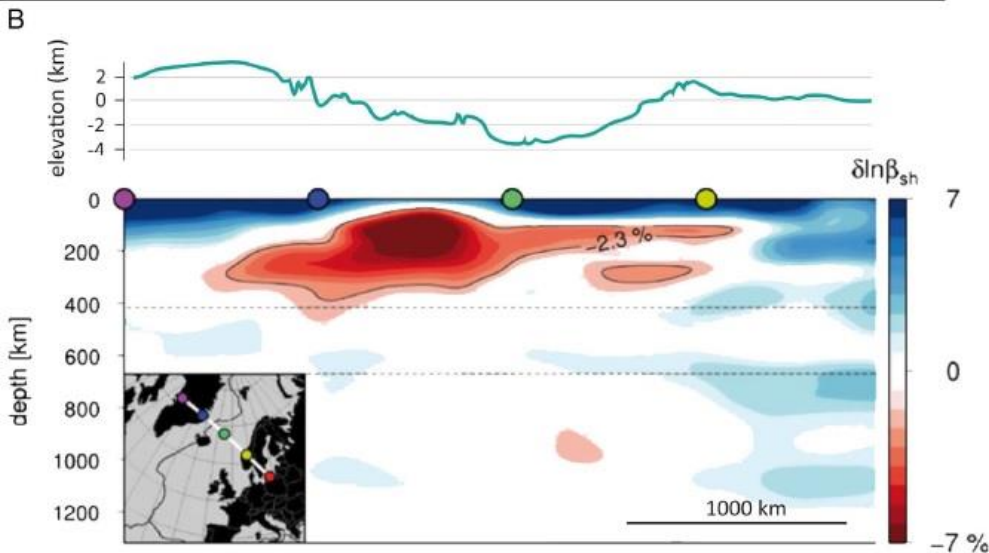
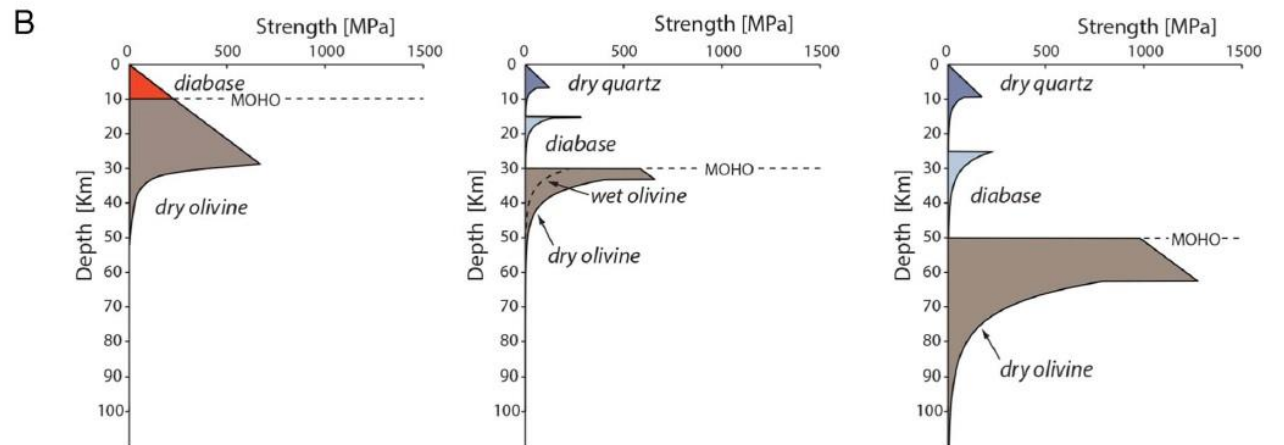
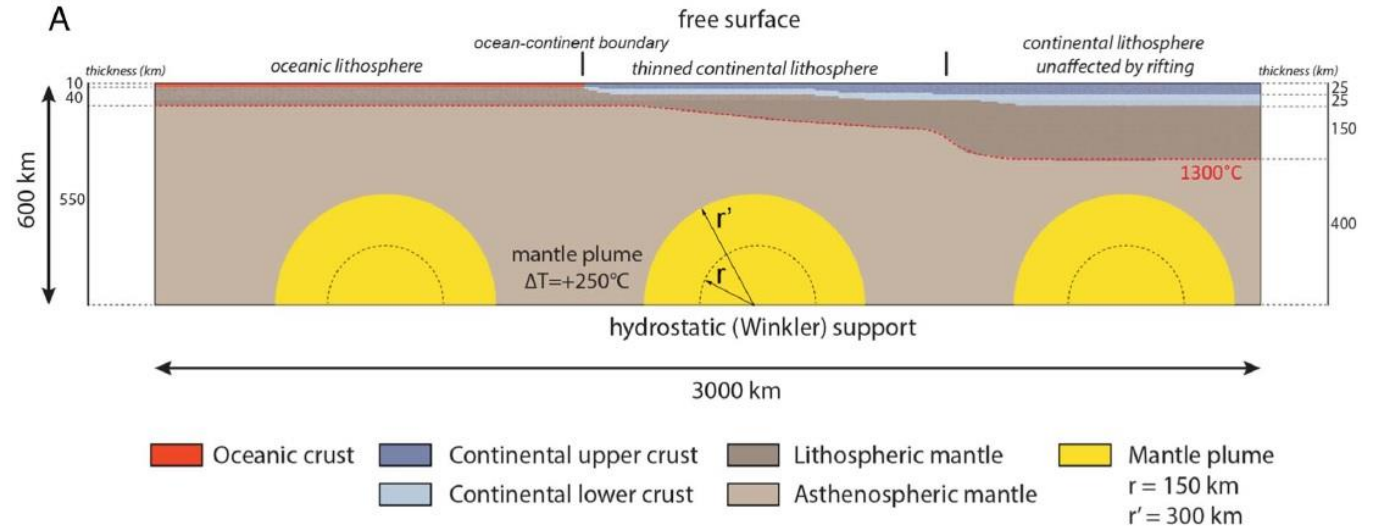
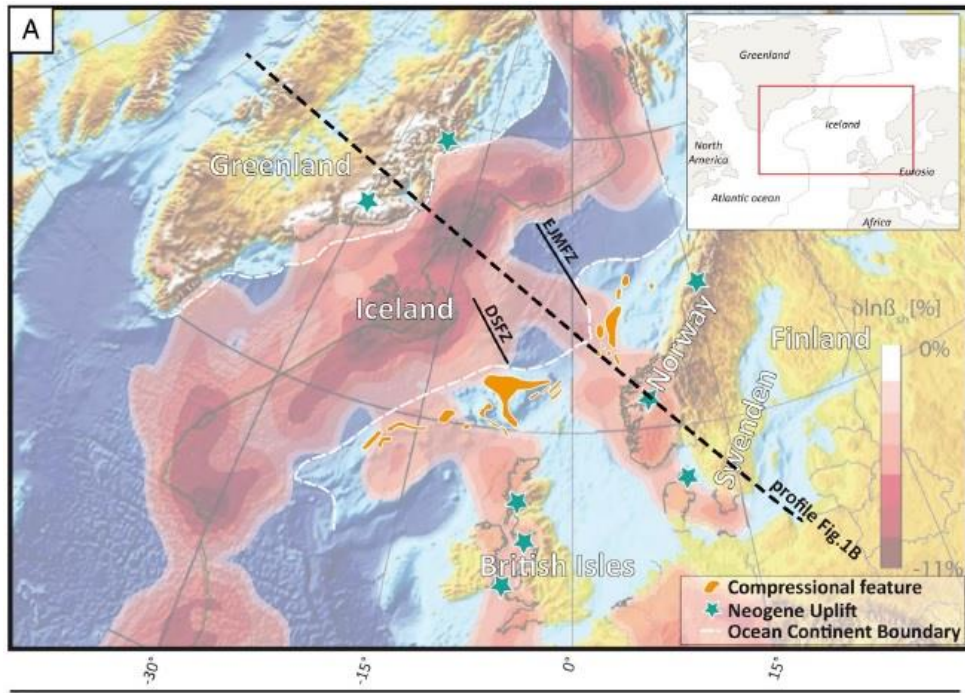

# Interaction between mantle plume and inherited lithospheric structures

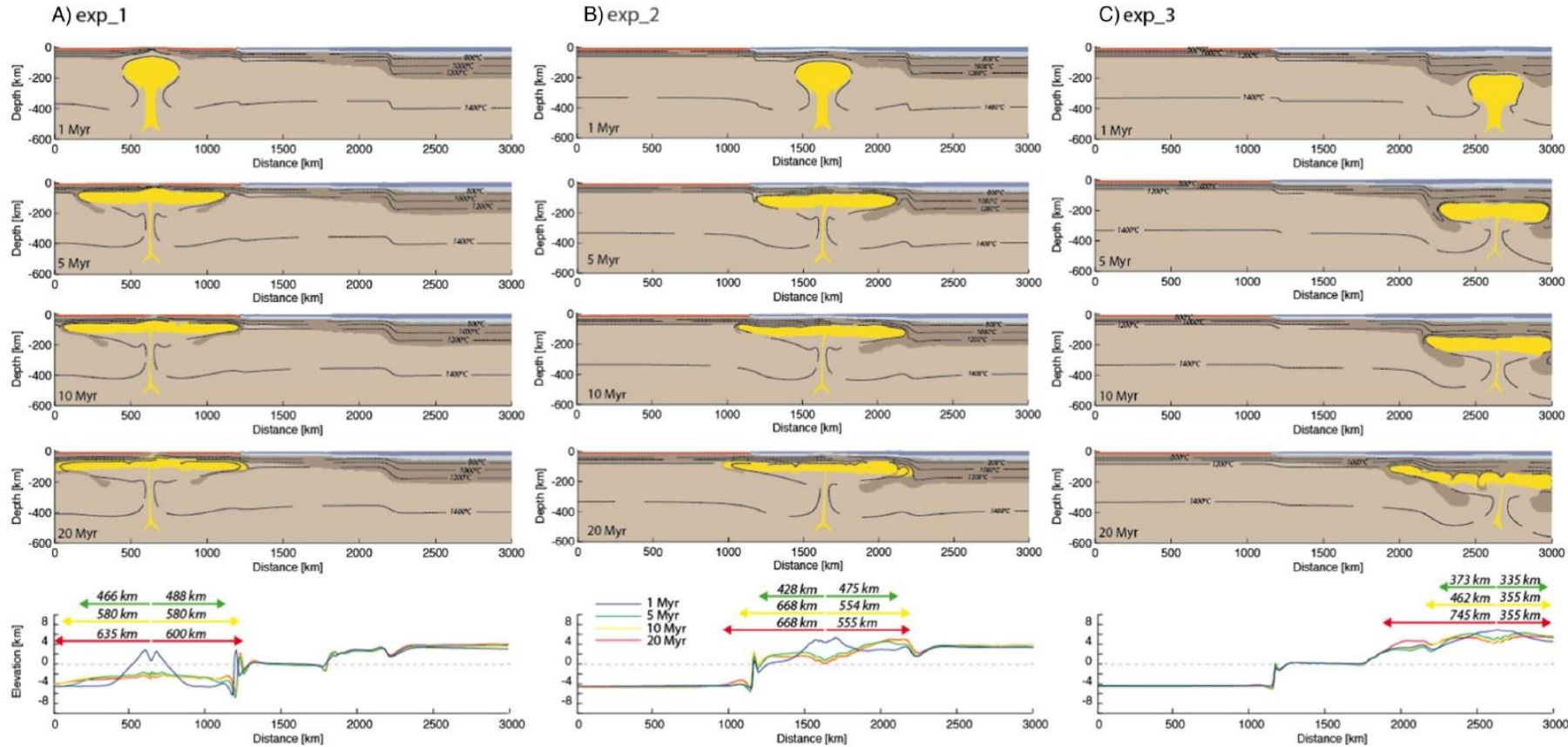

Plume Rheology: wet olivine  
Plume Radius: 150 km.

François et al., 2018, Tectonophysics, 746

The initial location of the plume strongly impacts its ability to reach the surface: in case the plume is initially seeded beneath oceanic lithosphere, it reaches the sea floor already after 5 Myr, with lateral spreading afterwards. In contrast, when seeded beneath the continent, the plume is confined to deeper levels of the lithosphere with significant down-thrusting of the overlying mantle on the extremities of the plume.

- (A) Plume under the oceanic lithosphere:** After the ascent of plume material associated with the break-up of the oceanic crust, the lateral propagation of plume material remains symmetric until 20 Myr.
- (B) Plume under transitional Phanerozoic lithosphere:** 1 Myr - ascent of the plume mantle up to the bottom of the continental lithosphere, 5 Myr - mantle plume lateral propagation in the two directions, 10 Myr - beginning of asymmetric expansion of plume material, induced by thinning of the transitional lithosphere towards the oceanic segment, 20 Myr - large asymmetric lateral spreading of plume mantle material.
- (C) Plume under continental Proterozoic lithosphere:** After the ascent and the symmetric lateral plume propagation (until 5 Myr), plume material flows preferentially towards thinner segments of transitional lithosphere, while on the opposite side the propagation is very limited.



# Interaction between mantle plume and inherited lithospheric structures

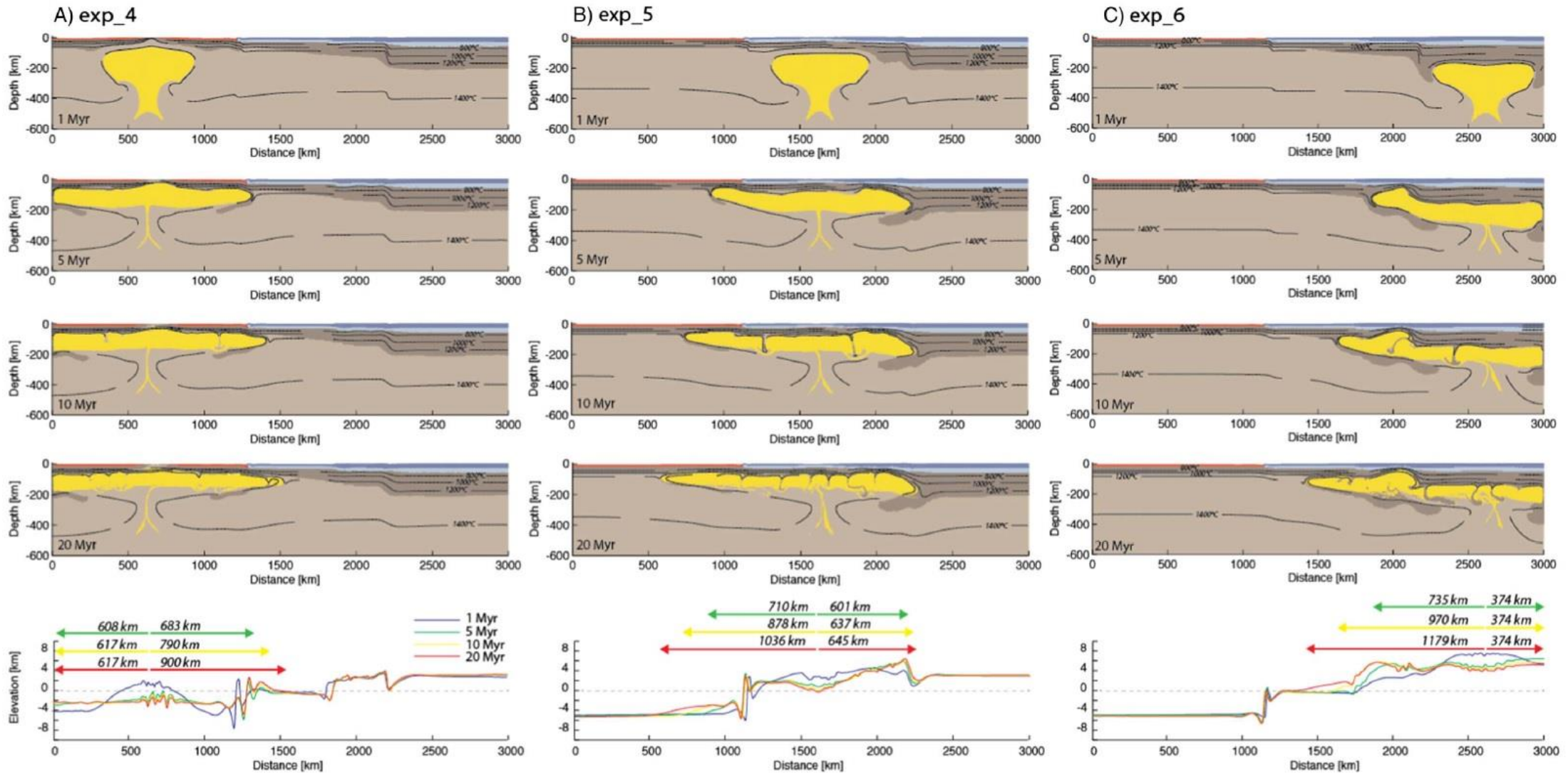

François et al., 2018, Tectonophysics, 746

- **Impact of a larger size of the mantle plume (300 km):** Amplified plume-lithosphere interactions lead to the asymmetric propagation of the plume material that starts quicker and with higher amplitude.



# Interaction between mantle plume and inherited lithospheric structures

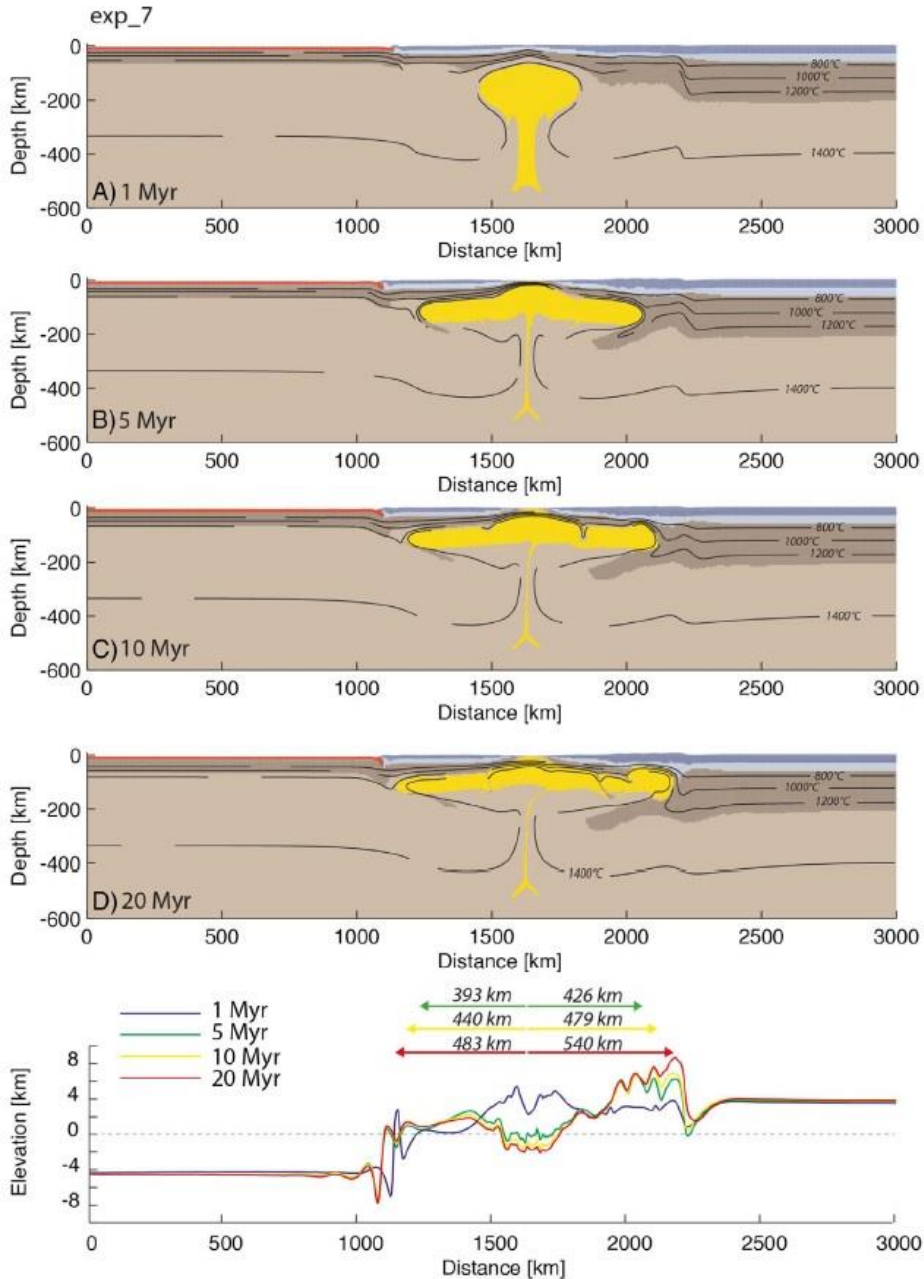

## Effect of a weak rheology of the mantle of transitional lithosphere:

- Plume emplacement has a much more dramatic surface expression and is accompanied by a quick thinning of the continental lithosphere, ultimately leading to the crustal break-up at 10 Myr.
- Lateral propagation of the plume material is limited, due to deeper penetration of plume material into weak transitional mantle, which favors longer propagation towards the thicker segment and significant down-thrusting and plume-induced subduction of the continental lithosphere.

## Main Readings:

## References

### Books:

- Cloetingh and Ziegler, 2009, Tectonic Models for the Evolution of Sedimentary Basins, Treatise of Geophysics, vol. 6.
- Kearey, Klepeis, and Vine, 2015, Continental rifts and rifted margins (Chapter 7), Global Tectonics.
- Frisch, Meschede, Blakey, 2011, Continental graben structures (Chapter 3), Plate Tectonics.
- Allen and Allen, 2014, Basins due to lithospheric stretching (Chapter 3), Basin Analysis.
- Allen P.A., Armitage J.J., Cratonic Basins in Tectonics of Sedimentary Basins, edited by C. Busby and A. Azor, pp. 602–620, John Wiley & Sons, Ltd., 2011.
- Stuwe, 2007, Dynamic Processes (Chapter 6), Geodynamics of the Lithosphere, Springer.

### Articles:

- François et al., 2018, Plume-lithosphere interactions in rifted margin tectonic settings: Inferences from thermo-mechanical modelling, Tectonophysics, 746, 138-154.
- Whitmarsh, et al., 2001, Evolution of magma-poor continental margins from rifting to seafloor spreading, Nature, 413.
- Lu and Huisman, 2021, Melt volume at Atlantic volcanic rifted margins controlled by depth-dependent extension and mantle temperature, Nature Communications, 12, 3894.

### Further Readings:

- Brune et al., 2014, Rift migration explains continental margin asymmetry and crustal hyper-extension, 5:4014 | DOI: 10.1038/ncomms5014
- Kaban et al., 2010, An integrated gravity model for Europe's crust and upper mantle, EPSL, 296, 195–209.
- Xie and Heller, 2009, Plate tectonics and basin subsidence history, GSA Bull., 121, 55-64.
- Kaus et al., 2005, Effect of mineral phase transitions on sedimentary basin subsidence and uplift, EPSL, 233, 213-228.
- Cacace and Scheck-Wenderoth, Why intracontinental basins subside longer: 3-D feedback effects of lithospheric cooling and sedimentation on the flexural strength of the lithosphere, JGR, 121, 3742–3761.
- Bastow et al., 2005, Upper-mantle seismic structure in a region of incipient continental breakup: northern Ethiopian rift, Geophys. J. Int., 162, 479-493.
- Thybo and Nielsen, 2009, Magma-compensated crustal thinning in continental rift zones, Nature, 457, 873-876.
- Gao et al., 2004, Upper mantle convection beneath the central Rio Grande rift imaged by *P* and *S* wave tomography, JGR, 109, B03305.
- Horváth et al., 2015, Evolution of the Pannonian basin and its geothermal resources, Geothermics, 53, 328-352.
- Tsikalas et al., 2005, Crustal structure of the Lofoten–Vesteralen continental margin, off Norway, Tectonophysics, 404, 151-174.
- Ros et al., 2017, Lower Crustal Strength Controls on Melting and Serpentinization at Magma-Poor Margins: Potential Implications for the South Atlantic, G3, 18.