



UNIVERSITÀ
DEGLI STUDI DI TRIESTE



DICOM-DIGITAL IMAGING AND COMMUNICATION IN MEDICINE

Prof. Sara Renata Francesca Marceglia

SCOPO



[ABOUT DICOM®](#) [STANDARD](#) [ACTIVITY](#) [USING DICOM®](#) [RESOURCES](#) [CONFERENCES](#) [CALENDAR](#) [NEWS](#) [CONTACT](#) [Q](#)

Digital Imaging and Communications in Medicine (DICOM) è uno standard per la gestione e comunicazione delle immagini mediche e dei dati ad esse correlati

- DICOM fornisce delle specifiche per:
 - La comunicazione in rete delle immagini, come insieme di protocolli che i dispositivi conformi devono rispettare
 - La sintassi e la semantica dei comandi e informazioni che possono essere scambiati tramite questi protocolli
 - Un insieme di servizi di memorizzazione per i sistemi conformi allo standard, così come i formati dei file e le strutture per facilitare l'accesso ai dati
- DICOM NON specifica:
 - L'implementazione delle caratteristiche descritte nello standard
 - Procedure di validazione e test

STORIA DI DICOM

- 1983 → ACR (American College of Radiology) e NEMA (National Electrical Manufacturers Association) iniziarono a collaborare per creare una standardizzazione che potesse superare le diversità tra i vari costruttori.
- 1985 → presentato alla RSNA (Radiological Society of North America) la prima versione dello standard ACR-NEMA 300-1985 1.0
- 1988 → nuova versione 2.0 (ACR-NEMA 300-1988).
- DICOM nasce come evoluzione di questo standard, che supera le difficoltà di interconnessione in rete, offrendo la possibilità di verificare se due apparecchi - dichiarati conformi - sono in grado di scambiare informazioni.
- 1993 → completamento delle specifiche DICOM e presentazione ufficiale alla RSNA [RSNA, 2008].
- DICOM versione 3.0 → riconosciuto come standard ISO 12052:2006

ELEMENTI BASE DICOM 3.0

- Struttura dati orientata agli oggetti (OGGETTI DICOM)
- Un insieme di servizi/primitive (DIMSE = Dicom Message Service) per la manipolazione dei dati;

Service Object Pair (SOP)=



SOP class = tutti i SOP associati ad un oggetto

SOP CLASS E SOP INSTANCE

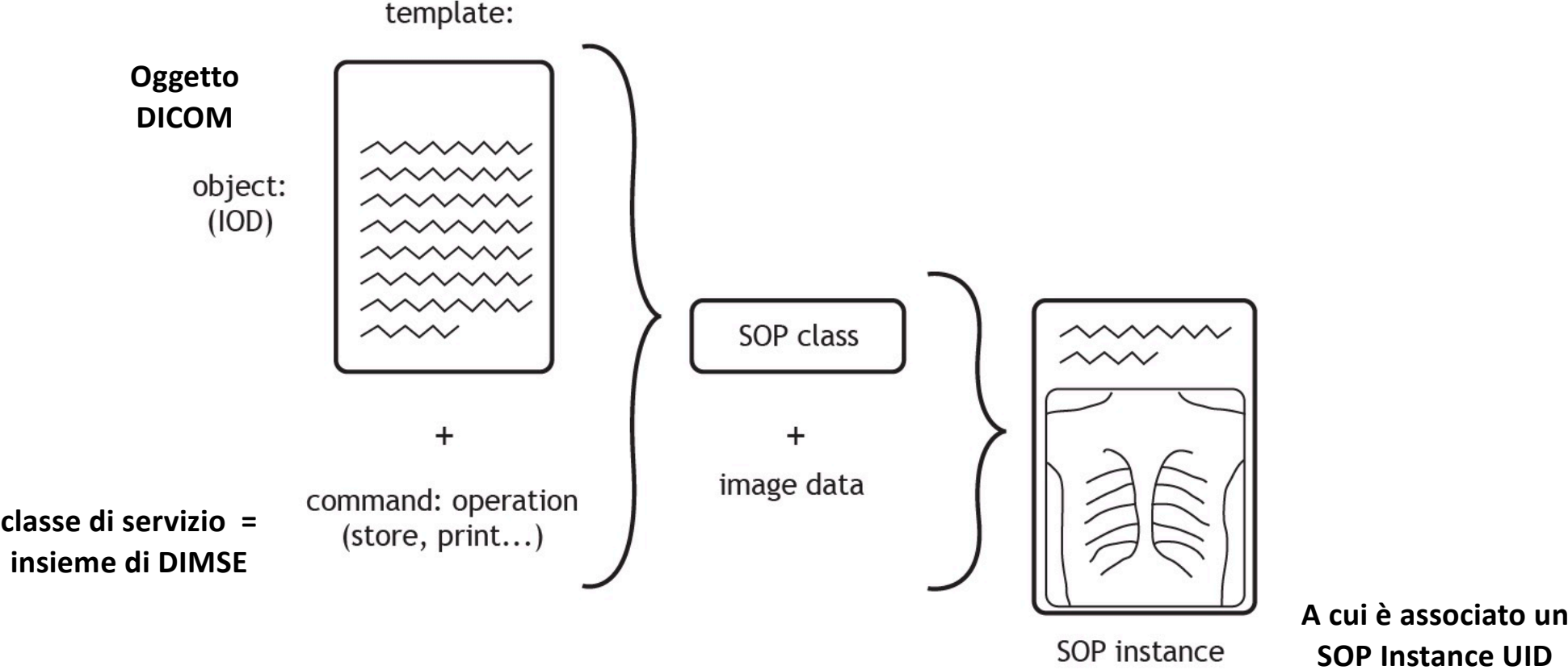

ESEMPIO

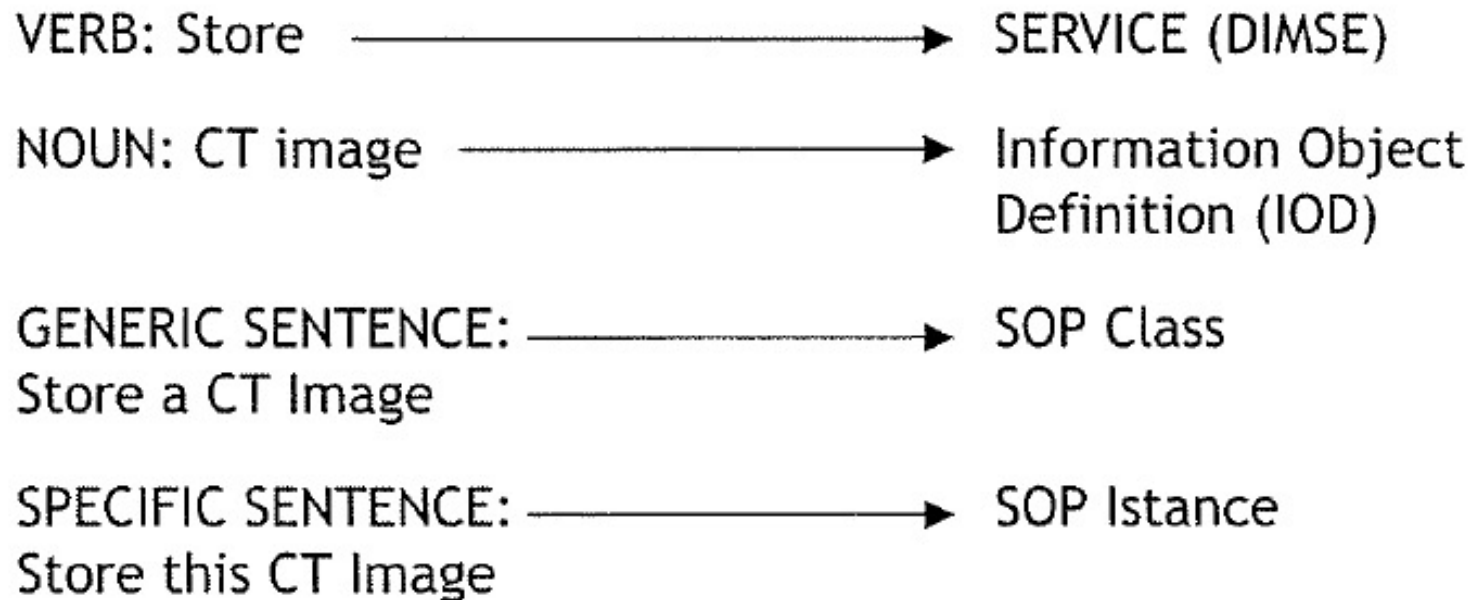

OGGETTI DICOM: MODELLO E-R

- DICOM realizza un esplicito e dettagliato modello di descrizione di una serie di “oggetti” (paziente, immagine, ecc.) che formano il dato radiologico, e di come essi sono tra loro collegati
- Non solo le immagini sono oggetti DICOM
- Altri esempi di oggetti sono: lista di prenotazioni di un paziente, la coda di stampa associata ad una stampante di pellicole, etc.

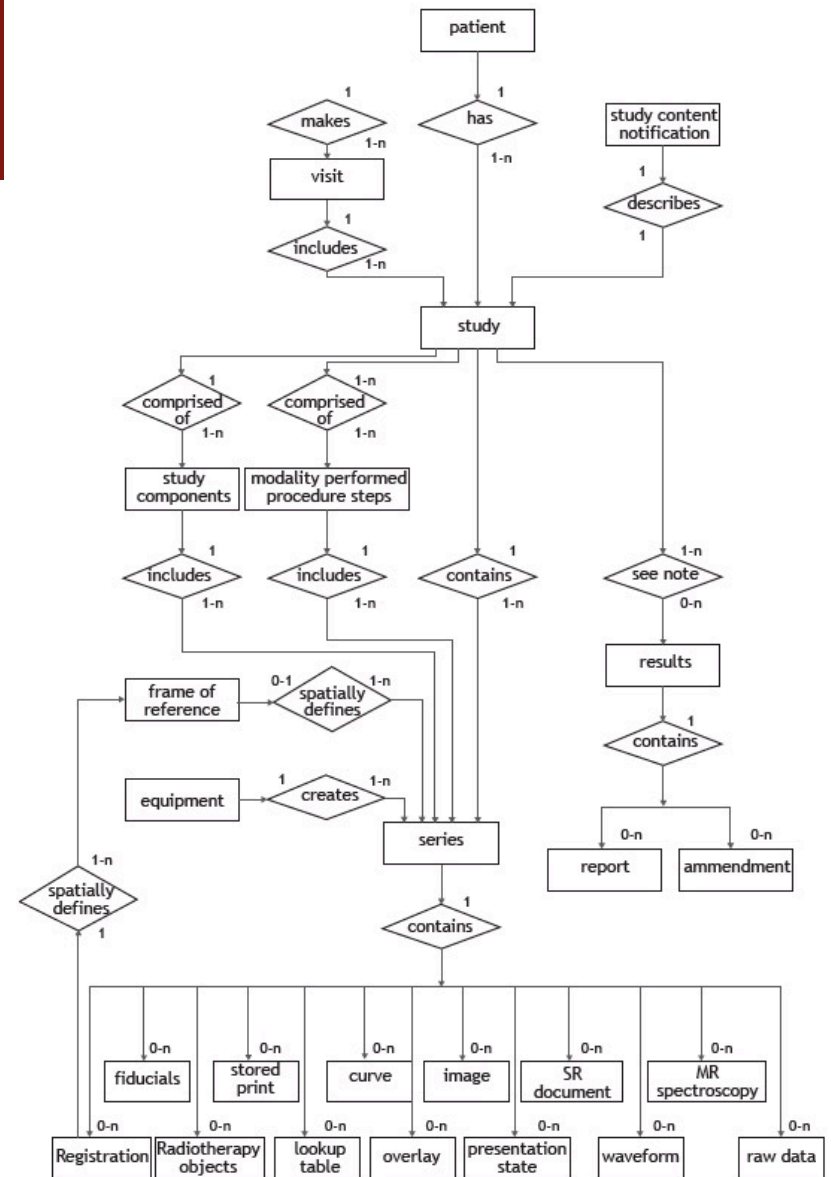

UID – UNIQUE IDENTIFIER

- Ad ogni oggetto DICOM deve essere associato uno *Unique Identifier (UID)*, per rendere tale identificativo possibilmente unico a livello mondiale.
- Lo struttura di un UID è basata sulla forma numerica dello standard *OSI Object Identification (ISO 8824)*
- Ogni UID si compone di due parti, una radice (riferita alla specifica organizzazione/azienda produttrice) e un suffisso:

UID = <radice><suffisso>

ESEMPIO UID

<radice>=1.2.840.xxxxx	<uffisso>=3.152.235.2.12.187636473
1: ISO	3: tipo di apparecchiatura
2: ANSI	152: numero di serie dell'apparecchiatura
840: codice ANSI per gli U.S.A.	235: studio
xxxxx: codice ANSI fornito all'organizzazione/azienda	2: serie
	12: immagine
	187636473: codifica per data e ora di acquisizione

IMMAGINE DICOM: ESEMPIO

1x1 struct with 97 fields

Field ▲	Value
Filename	'/Users/samarceglia/Documents/Brevetti/aDBS/Es...
FileModDate	'14-Nov-2018 13:48:23'
FileSize	132982
Format	'DICOM'
FormatVersion	3
Width	256
Height	256
BitDepth	12
ColorType	'grayscale'
FileMetaInformationGrou...	182
FileMetaInformationVersi...	[0;1]
MediaStorageSOPClassUID	'1.2.840.10008.5.1.4.1.1.4'
MediaStorageSOPInstanc...	'1.3.76.2.1.1.4.1.3.4081.492252849.0'
TransferSyntaxUID	'1.2.840.10008.1.2'
ImplementationClassUID	'1.2.276.0.7238010.5.0.3.5.4'
ImplementationVersionN...	'OSIRIX'
Unknown_0002_0017	'MYPACS'
SpecificCharacterSet	'ISO_IR 100'
ImageType	'ORIGINAL\PRIMARY\T1 MAP'
SOPClassUID	'1.2.840.10008.5.1.4.1.1.4'
SOPInstanceUID	'1.3.76.2.1.1.4.1.3.4081.492252849.0'
StudyDate	'20150907'
SeriesDate	'20150907'
AcquisitionDate	'20150907'
ContentDate	'20150907'

IMMAGINE DICOM ESEMPIO

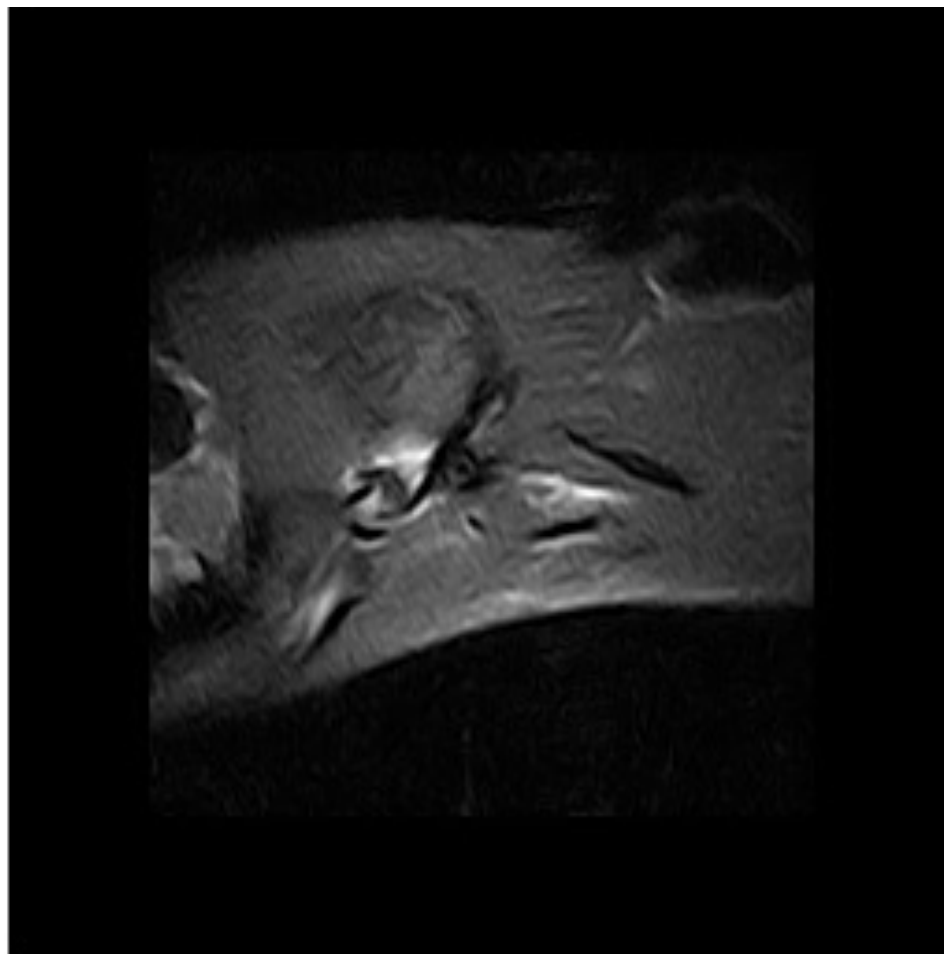

SOP CLASSES

Verification

- Servizio che consente ad un dispositivo DICOM di verificare lo stato di connessione (e di funzionamento) di un altro dispositivo connesso alla rete;
- Noto come "DICOM-ping".
- Deve essere implementato da un dispositivo conforme come SCP

Storage

- Servizio che permette il trasferimento di immagini e altri oggetti DICOM tra dispositivi
- Le Storage SOP Class sono sempre aggiornate e garantiscono la compatibilità col pregresso (non viceversa)

Query/retrieve

- Servizio di interrogazione: consente ad un qualunque dispositivo che lo implementa come SCU di interrogare un archivio centrale o un altro dispositivo (che agisce da SCP) alla ricerca delle immagini ivi eventualmente contenute

Print

- Servizio che rende le stampanti fruibili in un contesto di rete ed ogni dispositivo che implementi il servizio come SCU può dunque inviare i propri job di stampa ad una delle stampanti collegate

Modality Worklist (MWL)

- Consente all'operatore del sistema di acquisizione di reperire dal RIS (Radiological Information System) la lista dei pazienti in attesa di effettuare un esame diagnostico (CT, PET, MRI, ecc.), nonché tutte le informazioni socio-demografiche a questi collegate

Modality Performed Procedure Step (MPPS)

- Consente al sistema di acquisizione di comunicare la presa in consegna di un esame diagnostico per un paziente presente nella lista d'attesa, nonché lo stato attuale dell'esame (con il relativo numero di immagini prodotte e la loro locazione) ed, eventualmente, la sua conclusione.

Storage commitment

- Consente di garantire la corretta e persistente memorizzazione delle immagini (e in generale di qualunque altro oggetto DICOM), a seguito del loro invio attraverso la rete, sul dispositivo ricevente.
- Il dispositivo SCU di riversa la responsabilità della corretta archiviazione dei dati sul dispositivo SCP (tipicamente l'archivio centrale del PACS): in tal modo, ad esempio, è possibile e lecito per il sistema d'acquisizione, liberare la memoria occupata dagli oggetti per cui il servizio è andato a buon fine, avendo la certezza che i dati cancellati non vadano persi.

COMUNICAZIONE TRA COMPONENTI: PARADIGMA DICOM

- Paradigma di comunicazione client-server



- A seconda del contesto in cui ci si trova, un dispositivo può agire come SCU o come SCP oppure assumere entrambi i ruoli.
- Il conformance statement definisce quali SOP class sono implementate da un certo dispositivo e con quale/i ruolo/i
- Esempio: il dispositivo XXX supporta il CT image storage SCU e SCP, MR image storage SCU e SCP, DR image storage SCP → il dispositivo XXX può inviare e ricevere CT e MR, ma può solo ricevere radiografie digitali (DR)

ESEMPIO: SERVIZIO DICOM STORAGE

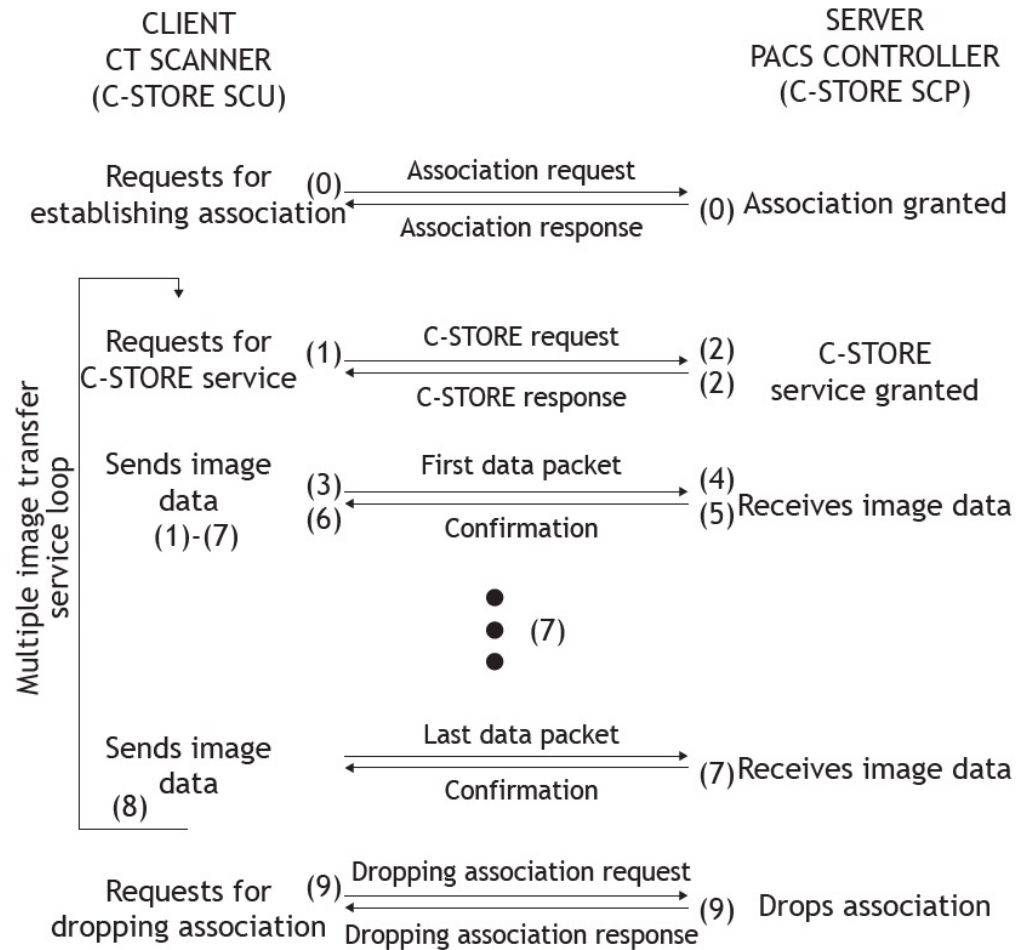

























































































































ESEMPIO: REFERTO CDA-2

```
1. <section classCode="DOCSECT" moodCode="EVN">
2.   <id root="1.2.840.10213.2.62.70447834679.11429737"/>
3.   <code code="121181"
4.     codeSystem="1.2.840.10008.2.16.4"
5.     codeSystemName="DCM"
6.     displayName="DICOM Object Catalog"/>
7.   <entry>
8.     <!-- **** Study Act **** -->
9.     <act classCode="ACT" moodCode="EVN">
10.      <!-- **** Identificativo dello Studio DICOM **** -->
11.      <id root="1.2.840.113619.2.62.994044785528.114289542805"/>
12.      <code code="113014" codeSystem="1.2.840.10008.2.16.4"
13.        codeSystemName="DCM" displayName="Study"/>
14.      <!-- **** Series Act ****-->
15.      <entryRelationship typeCode="COMP">
16.        <act classCode="ACT" moodCode="EVN">
17.          <id root="1.2.840.113619.2.62.994044785528.20060823223142485051"/>
18.          <code code="113015" codeSystem="1.2.840.10008.2.16.4"
19.            codeSystemName="DCM" displayName="Series">
20.            ...
21.          </code>
22.          <!-- **** SOP Instance UID *** -->
23.          <entryRelationship typeCode="COMP">
24.            <observation classCode="DGIMG" moodCode="EVN">
25.              <!-- **** Identificativo dell'immagine nel sistema PACS *** -->
26.              <id root="1.2.840.113619.2.62.994044785528.20060823.3"/>
27.              ...
28.            </observation>
29.          </entryRelationship>
30.        </act>
31.      </entryRelationship>
32.    </act>
33.  </entry>
```

DICOM object
di riferimento

SOP instance

STRUTTURA DELLO STANDARD: 21 PARTI

	PDF	HTML	CHTML	DOCX	ODT	XML
DICOM Part 1: Introduction and Overview						
DICOM Part 2: Conformance						
DICOM Part 3: Information Object Definitions						
DICOM Part 4: Service Class Specifications						
DICOM Part 5: Data Structures and Encoding						
DICOM Part 6: Data Dictionary						
DICOM Part 7: Message Exchange						
DICOM Part 8: Network Communication Support for Message Exchange						
DICOM Part 10: Media Storage and File Format for Media Interchange						
DICOM Part 11: Media Storage Application Profiles						
DICOM Part 12: Media Formats and Physical Media for Media Interchange						
DICOM Part 14: Grayscale Standard Display Function						
DICOM Part 15: Security and System Management Profiles						
DICOM Part 16: Content Mapping Resource						
DICOM Part 17: Explanatory Information						
DICOM Part 18: Web Services						
DICOM Part 19: Application Hosting						
DICOM Part 20: Imaging Reports using HL7 Clinical Document Architecture						
DICOM Part 21: Transformations between DICOM and other Representations						
DICOM Part 22: Real-Time Communication						
DICOM Parts 1-21: Bulk Download	Zip file for each format					

STRUTTURA DELLO STANDARD

PARTE 1 - INTRODUCTION AND OVERVIEW

La prima parte contiene una panoramica dello standard stesso, con descrizione dei principi basilari e delle norme di riferimento.

PARTE 2 - CONFORMANCE

Ogni produttore e venditore di un dispositivo dichiarato compatibile con DICOM 3.0 è tenuto a redigere e a rendere pubblicamente fruibile un documento di conformità allo standard. In esso sono contenute le necessarie informazioni per capire se effettivamente il dispositivo d'interesse è in grado di integrarsi con il parco macchine DICOM-compatibili già a disposizione. Non si specifica però una procedura di testing/validation per stimare la conformità di un'applicazione allo Standard.

STRUTTURA DELLO STANDARD

PARTE 3 - INFORMATION AND OBJECT DEFINITION

La terza parte definisce e descrive gli Information Objects che offrono una definizione astratta delle entità reali (paziente, studio, immagine), applicabile alla comunicazione di immagini mediche digitali ed alle informazioni relative (forme d'onda, report strutturati, dose di radiazione, ecc.). Ogni "Information Object Class definition" (IODs) è costituita da una descrizione del suo scopo e dagli attributi che la definiscono. Ogni IOD è una classe, non è una istanza e non specifica i valori per i suoi attributi. Si parla di istanza quando ad un attributo si sostituisce un valore specifico: naturalmente i valori degli attributi possono cambiare nel tempo, anche in base alle operazioni che si effettuano sulle entità.

PARTE 4 - SERVICES CLASS SPECIFICATION

Il contenuto della quarta parte mostra le specifiche delle classi di servizi Service Object Pair (SOP Class) che sono basate su di una serie di operazioni primitive che operano su IOD.

STRUTTURA DELLO STANDARD

PARTE 5 - DATA STRUCTURE AND ENCODING

Appena un'applicazione DICOM assembla un data set (una raccolta d'informazioni costituite dagli Information Objects e dalle Service Classes DICOM), deve essere codificata cosicché può essere inserita in forma di messaggio per la comunicazione. La funzione principale di questo documento è la definizione del “linguaggio” che due apparecchiature useranno per “parlare” l'una con l'altra.

PARTE 6 - DATA DICTIONARY

Questa parte di DICOM include la lista completa di tutti i Data Elements insieme ai loro tag (o nomi numerici) ed al loro nome testuale, come questi sono rappresentati (testo, numero a virgola mobile, ecc.), se contengono uno o più percorsi e quali valori sono permessi.

STRUTTURA DELLO STANDARD

PARTE 7 - MESSAGE EXCHANGE

La settima parte dello Standard DICOM specifica sia il servizio che il protocollo utilizzato per lo scambio d'immagini mediche da un'applicazione dedita allo scambio dei messaggi su supporti definiti nella Parte 8.

PARTE 8 - NETWORK COMMUNICATION SUPPORT FOR MESSAGE EXCHANGE

In ambiente DICOM il protocollo di comunicazione utilizzato è il TCP/IP che rappresenta uno standard ormai molto diffuso che consente il trasferimento di immagini e dati a prescindere dal mezzo fisico di trasmissione, in modo efficiente e coordinato. Data l'esistenza di molte reti di comunicazione, realizzate secondo strategie differenti, la scelta di questo standard rappresenta una soluzione ideale al trasferimento delle immagini diagnostiche, sia a livello locale, che su rete metropolitana (MAN) o geografica (WAN).

STRUTTURA DELLO STANDARD

PARTE 9 - RETIRED

Nella nona parte sono raggruppate tutte le modalità relative ai vecchi protocolli punto-punto ancora in uso presso vecchi sistemi.

PARTE 10 - MEDIA STORAGE AND FILE FORMAT FOR DATA INTERCHANGE

Specifica un modello generale per lo storage delle informazioni relative alle immagini medicali su supporti removibili. Lo scopo è fornire un framework che consenta l'interscambio di vari tipi di immagini medicali e delle relative informazioni, su una vasta gamma di supporti fisici di memorizzazione.

PARTE 11 - MEDIA STORAGE APPLICATION PROFILES

La parte 11 dello standard specifica sottoinsiemi specifici di applicazioni dello standard DICOM ai quali un'implementazione può esigere la conformità. Questi sottoinsiemi specifici di applicazioni vengono raggruppati in Application Profiles.

STRUTTURA DELLO STANDARD

PARTE 12 - STORAGE FUNCTIONS AND MEDIA FORMATS FOR DATA INTERCHANGE

Questa parte dello standard facilita l'interscambio di informazioni tra applicazioni in ambiente medico, specificando:

- una struttura per descrivere la relazione tra il modello di memorizzazione e uno specifico supporto fisico e formato;
- specifica le caratteristiche del supporto fisico ed i relativi formati.

PARTE 13 - RETIRED (FORMERLY PRINT MANAGEMENT POINT-TO-POINT COMMUNICATION SUPPORT)

La parte 13 specificava i servizi ed i protocolli utilizzati per le comunicazioni punto-punto ed i servizi per la gestione delle stampe. È stato ritirato.

PARTE 14 - GRAYSCALE STANDARD DISPLAY FUNCTION

La parte 14 specifica le funzioni standard per la visualizzazione di immagini in scala di grigi. Questa funzione fornisce un metodo per calibrare un particolare sistema di visualizzazione al fine di presentare le immagini in modo consistente su differenti strumenti di visualizzazione (e.g. monitor e stampanti).

STRUTTURA DELLO STANDARD

PARTE 15 - SECURITY AND SYSTEM MANAGEMENT PROFILES

La parte 15 specifica i profili per la gestione della sicurezza del sistema ai quali l'implementazione dichiara di essere conforme. Questa parte non vuole indicare delle politiche di sicurezza ma vuole solo fornire dei meccanismi che possono essere utilizzati per implementare le politiche di sicurezza nell'ottica dell'interscambio sicuro degli oggetti DICOM.

PARTE 16 - CONTENT MAPPING RESOURCE

La parte 16 specifica:

- template per strutturare i documenti come oggetti DICOM
- insiemi di termini utilizzati negli oggetti DICOM
- un lessico dei termini definiti e mantenuti da DICOM
- specifiche traduzioni di termini del Paese specifico.

STRUTTURA DELLO STANDARD

PARTE 17 - EXPLANATORY INFORMATION

La parte 17 specifica le informative e le normative annesse che contengono informazioni esplicative.

PARTE 18 - WEB ACCESS TO DICOM PERSISTENT OBJECTS

La parte 18 specifica come accedere agli oggetti persistenti DICOM attraverso richieste HTTP URL/URI che includono un puntatore ad uno specifico oggetto DICOM nella forma di una istanza UID.

APPROCCIO REST: DICOM WEB



[ABOUT DICOM®](#) [STANDARD](#) [ACTIVITY](#) [USING DICOM®](#) [RESOURCES](#) [CONFERENCES](#) [CALENDAR](#) [NEWS](#) [CONTACT](#)

DICOMweb™

DICOMweb™ is the DICOM standard for web-based medical imaging. It is a set of RESTful services, enabling web developers to unlock the power of healthcare images using industry-standard toolsets.

DICOMweb can be implemented directly or as a proxy to the DIMSE services to offer modern web-based access to DICOM-enabled systems. Image-producing modalities don't all need to be retrofitted to support DICOMweb.

DICOMWEB SERVICES

SERVICE	DESCRIPTION	STANDARD
QUERY	Search for DICOM objects (QIDO-RS)	DICOM PS3.18 10.6
RETRIEVE	Retrieve DICOM objects (WADO-RS)	DICOM PS3.18 10.4
	Retrieve single DICOM instances (WADO-URI)	DICOM PS3.18 9
STORE	Store DICOM objects (STOW-RS)	DICOM PS3.18 10.5
WORKLIST	Manage worklist items (UPS-RS)	DICOM PS3.18 11
CAPABILITIES	Discover services	DICOM PS3.18 8.9

UTILIZZO DI STANDARD: IHE



Integrating the Healthcare Enterprises



IHE International
Enable seamless and secure access to
health information whenever and
wherever needed.

[Integrating the Healthcare Enterprise \(IHE\)](#)

[BECOME A MEMBER](#)

IHE is an initiative by healthcare professionals and industry to improve the way computer systems in healthcare share information. IHE promotes the coordinated use of established standards such as DICOM and HL7 to address specific clinical needs in support of optimal patient care. Systems developed in accordance with IHE communicate with one another better, are easier to implement, and enable care providers to use information more effectively.

OBIETTIVI

- Nata nel 1998 in USA da *Radiological Society of North America (RSNA)* e *Healthcare Information and Management Systems Society (HIMSS)*
- IHE non è uno standard di comunicazione → definisce le specifiche mediante cui gli standard disponibili possono essere utilizzati in pratica per:
 - Facilitare l'integrazione
 - Supportare le funzionalità della cartella clinica informatizzata
 - Favorire l'adozione degli standard
 - Promuovere la comunicazione tra aziende produttrici
 - Migliorare efficacia ed efficienza in clinica
 - Migliorare la sicurezza ICT
- Interoperabilità → definizione di processi di scambio di informazione definiti **profili**.

IHE domains

IHE Domains
Anatomic Pathology
Cardiology
Dental
Eye Care
IT Infrastructure
Laboratory
Patient Care Coordination
Patient Care Devices
Pharmacy
Quality, Research and Public Health
Radiation Oncology
Radiology

- IHE lavora su domini clinici e amministrativi.
- In ogni dominio vengono identificate le maggiori criticità legate all'integrazione
- Ogni dominio è dotato di una commissione tecnica che interagisce sviluppa il corrispondente profilo/i di integrazione
- Vengono creati i documenti di riferimento (Technical Framework documents)
- Una commissione di pianificazione organizza i lavori di verifica e gestione del profilo

PROFILI IHE

- **Profilo** = rappresentazione astratta di un processo reale in cui si specificano i diversi «use case»
- Si definiscono i:
 - I processi di comunicazione
 - Le informazioni scambiate
 - Le azioni che si effettuano una volta ricevuta l'informazione
- Ogni profilo è caratterizzato da:
 - **ATTORI**: sistema informativo coinvolto nello scambio di informazione (es. ADT, Order Placer, Order Filler, etc.);
 - **TRANSIZIONI**: scambio di informazione basato su uno standard (es. HL7 v2).
- Una **tabella** sintetizza attori e transizioni per un determinato profilo.

Example: the Laboratory Testing Workflow (LTW) overview

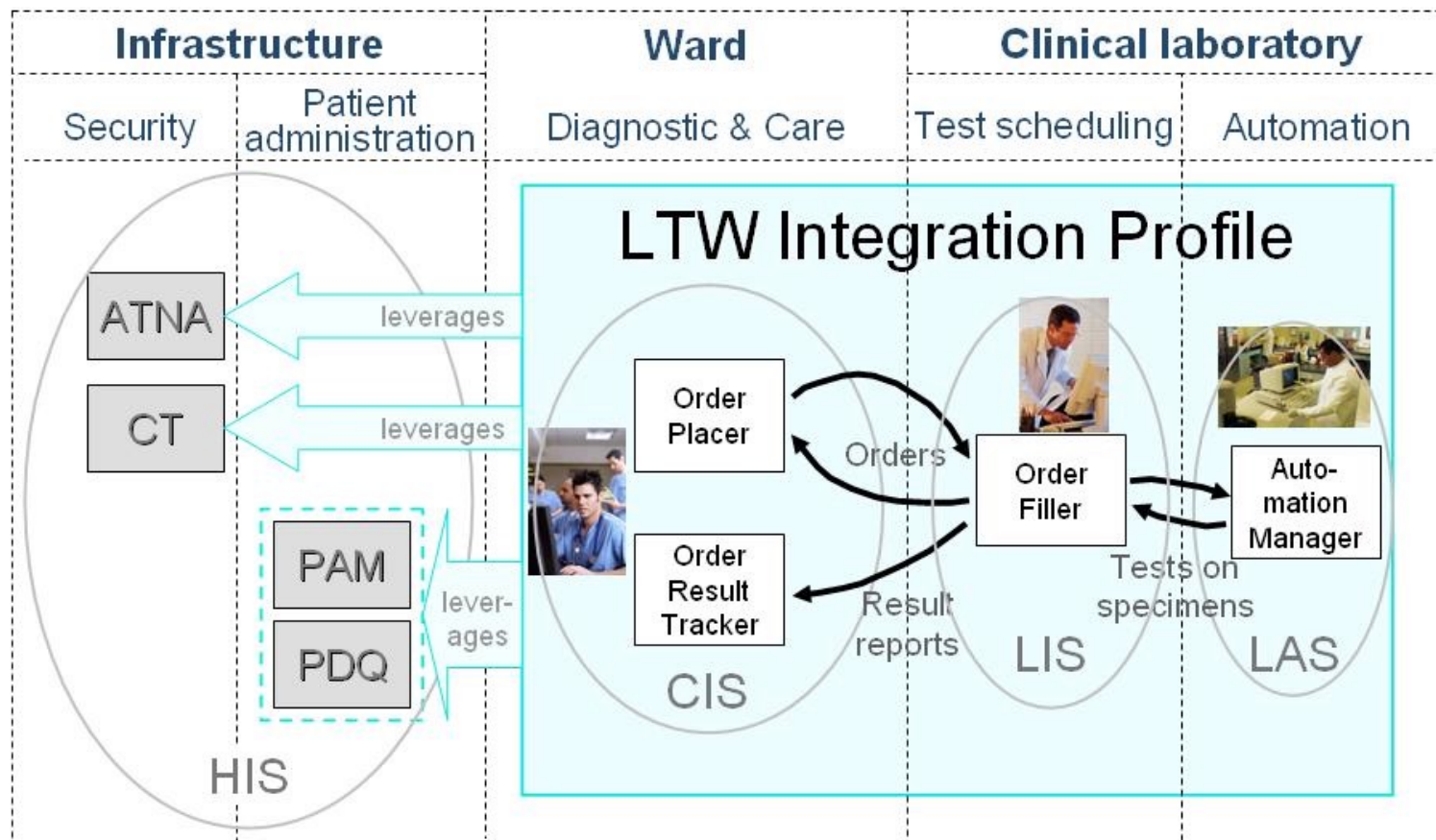

Example: LTW actors and transactions

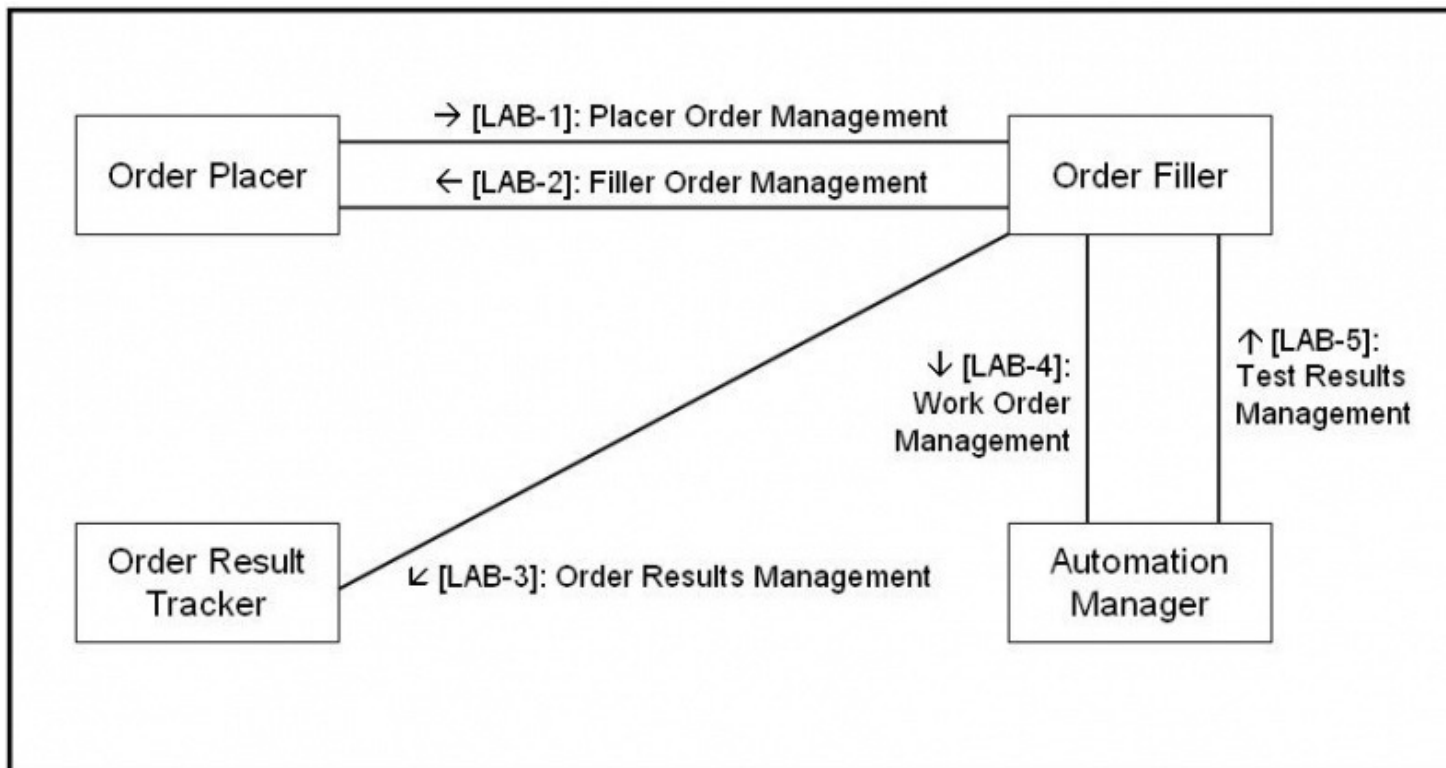

Example: LTW actors and transactions reference messages

Actors	Transactions	Optionality	Section in Vol. 2
Order Placer	Placer Order management [LAB-1]	R	LAB TF-2a: 3.1
	Filler Order Management [LAB-2]	R	LAB TF-2a: 3.2
Order Filler	Placer Order management [LAB-1]	R	LAB TF-2a: 3.1
	Filler Order Management [LAB-2]	R	LAB TF-2a: 3.2
	Order Results management [LAB-3]	R	LAB TF-2a: 3.3
	Work Order Management [LAB-4]	R	LAB TF-2a: 3.4
	Test Results Management [LAB-5]	R	LAB TF-2a: 3.5
Automation Manager	Work Order Management [LAB-4]	R	LAB TF-2a: 3.4
	Test Results Management [LAB-5]	R	LAB TF-2a: 3.5

Example: LTW process flow for placer ordering

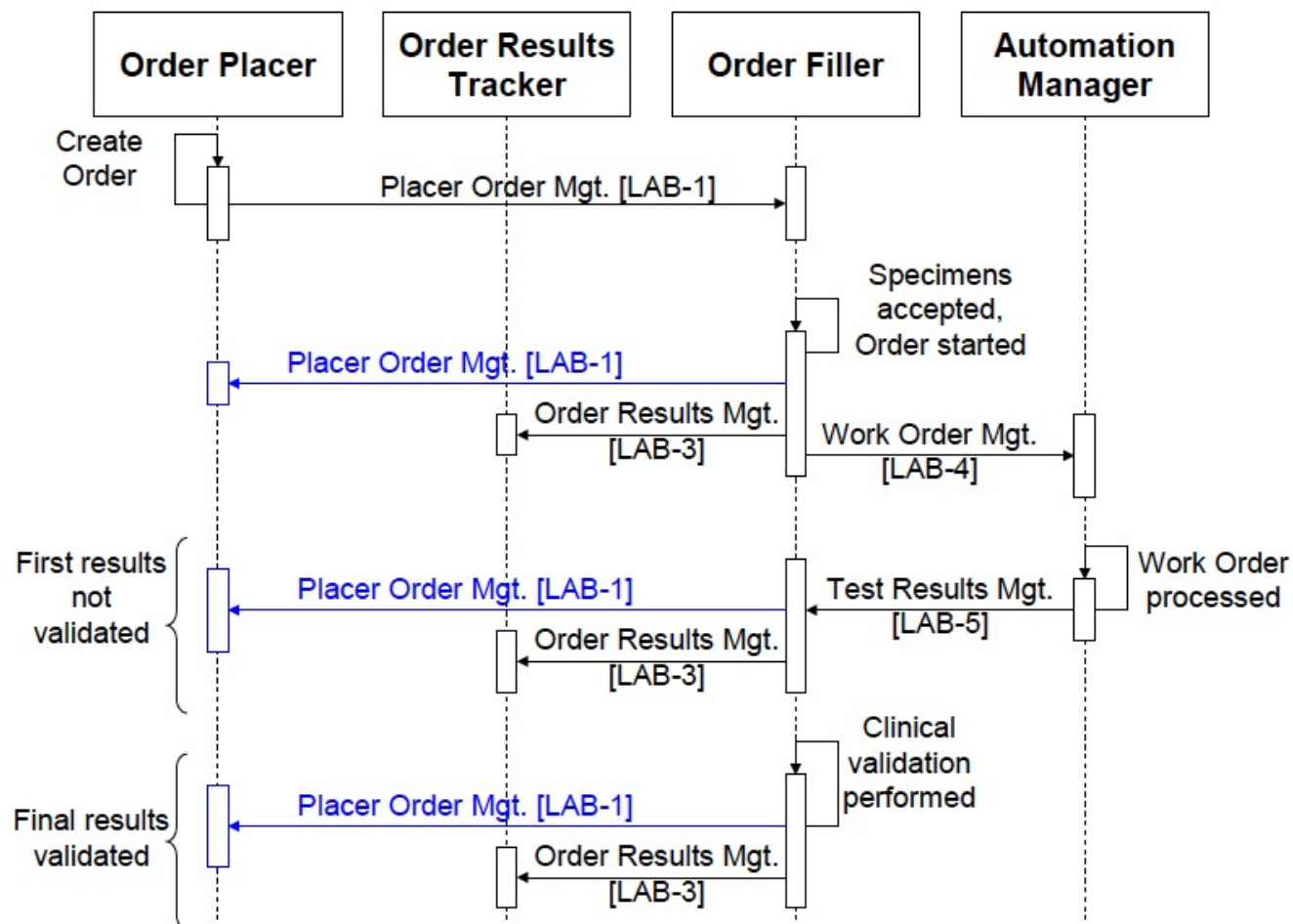

Example: OML^O21 message for the LAB-1 transaction in LTW

Table 3.1.5.3-1: OML^O21 static definition for transaction LAB-1

Segment	Meaning	Usage	Card.	HL7 chapter
MSH	Message Header	R	[1..1]	2
[--- PATIENT begin	RE	[0..1]	
PID	Patient Identification	R	[1..1]	3
[PV1]	Patient Visit	RE	[0..1]	3
]	--- PATIENT end			
{	--- ORDER begin	R	[1..*]	
ORC	Common Order (for one battery)	R	[1..1]	4
[TQ1]	Timing Quantity	RE	[0..1]	4
	--- OBSERVATION REQUEST begin	R	[1..1]	
OBR	Observation Request	R	[1..1]	4
{ [NTE] }	Notes and Comments	O	[0..*]	2
[{	--- OBSERVATION begin	O	[0..*]	
OBX	Observation Result	R	[1..1]	7
[{ [NTE] }	Comment of the result	C	[0..*]	2
}]	--- OBSERVATION end			
[{	--- SPECIMEN begin	O	[0..*]	
SPM	Specimen	R	[1..1]	7
[{ [SAC] }	Container	C	[0..*]	13
}]	--- SPECIMEN end			
[{	--- PRIOR_RESULT begin	O	[0..*]	
PV1	Patient Visit – previous result	R	[1..1]	3
{	--- ORDER_PRIOR begin	R	[1..*]	



Sessione plenaria annuale in cui sono coinvolti utenti e produttori di software per testare i profili

ESEMPIO DI INTEGRAZIONE: IL SISTEMA RIS/PACS



STANDARD E INTEGRAZIONE

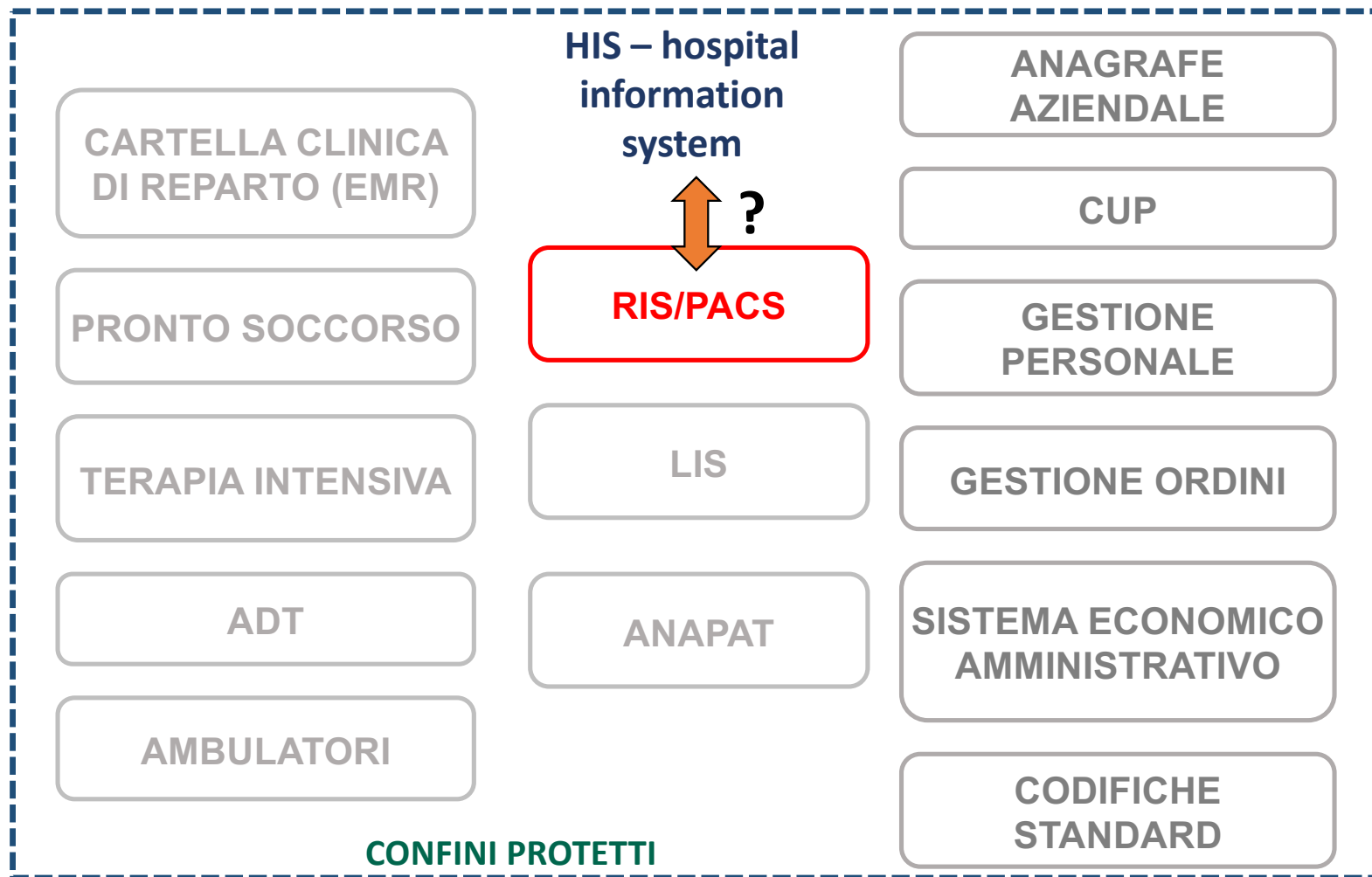

RIS – RADIOLOGY INFORMATION SYSTEM

- Sistema per la gestione delle informazioni generate/gestite dalla radiologia
- Il RIS solitamente si interfaccia con il Sistema informativo Ospedaliero (HIS – Hospital Information System) e con il PACS (Picture Archiving and Communication System)
- Il RIS può includere funzionalità di gestione pazienti/percorsi o di reporting/statistica

FUNZIONALITÀ DEL RIS NEL FLUSSO DI LAVORO

Gestione richieste d'esame

- Necessita della raccolta di informazioni amministrative (paziente, tipo di esame, vincoli temporali di urgenza, etc)
- Necessita della raccolta di informazioni cliniche (quesito diagnostic, eventuale anamnesi)

Gestione dell'agenda

- Gestione risorse disponibili
- Generazione degli appuntamenti

Accettazione

- Validazione dati raccolti in fase di richiesta d'esame
- Permette l'inserimento dei dati dei pazienti direttamente nelle modalità diagnostiche (apparecchiature a disposizione)

Esecuzione dell'esame

- Raccolta delle informazioni relative alla procedura

FUNZIONALITÀ DEL RIS NEL FLUSSO DI LAVORO

Refertazione

- Creazione della lista di refertazione
- Visualizzazione degli esami (reperti e referti) precedenti

Archiviazione

- Conservazione delle informazioni (non delle immagini)
- Integrazione col PACS

Gestione della manutenzione

- Possibilità di creare schede di monitoraggio delle apparecchiature a disposizione

PACS: PICTURE ARCHIVING AND COMMUNICATION SYSTEMS

- Implementazione di una banca di bioimmagini ospedaliera:
 - ✓ Costosa
 - ✓ Aumento dell'utenza (non solo la radiologia)
 - ✓ Interfaccia con il sistema informativo ospedaliero
 - ✓ Deve facilitare l'attività degli utenti
- I PACS offrono soluzioni ad hoc
- Non sono in grado di rispondere alle specifiche richieste di visualizzazione dell'utenza, ma rispondono bene alle necessità organizzative, di memorizzazione e di interrogazione di liste alfanumeriche

PACS: ARCHITETTURA

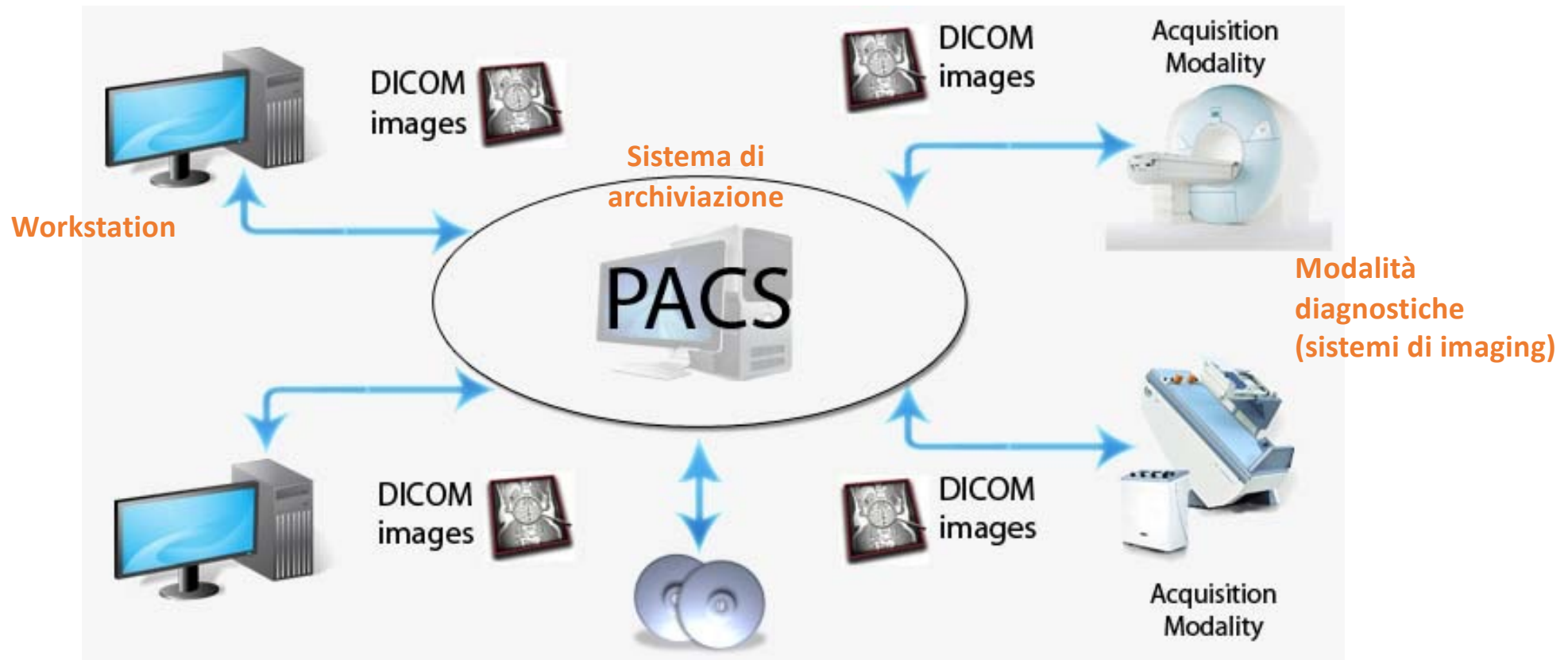

PACS: TIPOLOGIE DI ARCHIVIAZIONE

- Obiettivo del PACS è rendere disponibili le immagini dove e quando necessarie
- Necessari diversi tipi di archivi:
 - A brevissimo termine: limitato al tempo che intercorre tra l'acquisizione e la refertazione
 - A breve termine: limitato al tempo di permanenza del paziente in ospedale (frequenza di consultazione elevata)
 - A medio termine: fino a un anno
 - Archivio storico: esami precedenti a un anno

PROFILI DI INTEGRAZIONE IN AMBITO RADIOLOGICO

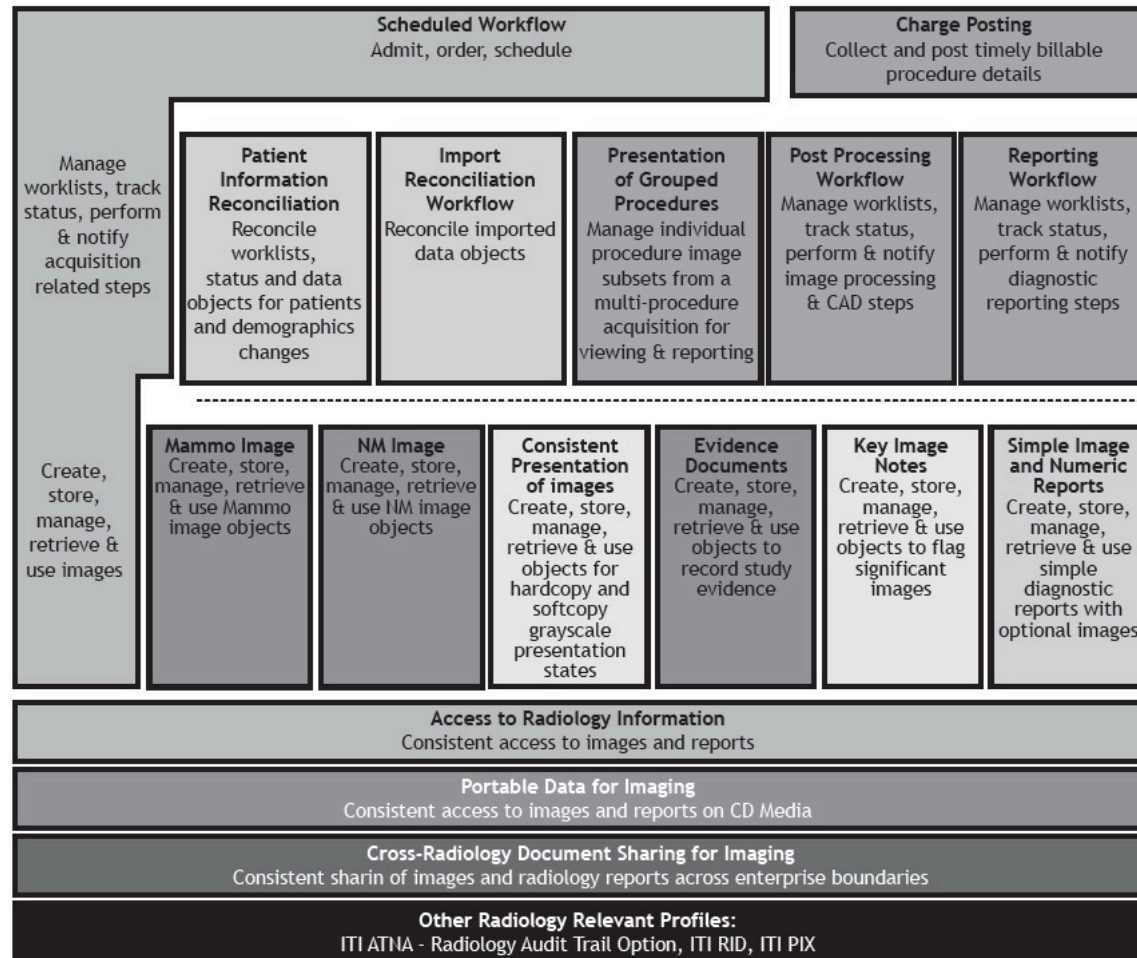

ESEMPIO: IHE radiology profiles

IHE Radiology Profiles

Radiology Profiles

Profiles for Workflow

- [SWF] [Scheduled Workflow](#) integrates ordering, scheduling, imaging acquisition, storage and viewing for Radiology exams.
- [SWF.b] [Scheduled Workflow.b](#) integrates ordering, scheduling, imaging acquisition, storage and viewing for Radiology exams.
- [PIR] [Patient Information Reconciliation](#) coordinates reconciliation of the patient record when images are acquired for unidentified (e.g., trauma), or misidentified patients.
- [PWF] [Post-Processing Workflow](#) provides worklists, status and result tracking for post-acquisition tasks, such as Computer-Aided Detection or Image Processing.
- [RWF] [Reporting Workflow](#) provides worklists, status and result tracking for reporting tasks, such as dictation, transcription and verification.
- [IRWF] [Import Reconciliation Workflow](#) manages importing images from CDs, hardcopy, XDS-I, etc. and reconciling identifiers to match local values.
- [EBIW] [Encounter-Based Imaging Workflow](#) links images acquired in the context of a healthcare encounter with critical metadata and notifies the EMR.
- [MAWF] [Mammography Acquisition Workflow](#) handles mammography-specific exceptions to routine image acquisition based on Scheduled Workflow.
- [PAWF] [Post-Acquisition Workflow](#) provides worklists, status and result tracking for post-acquisition tasks and application hosting.
- [RRR-WF] [Radiology Remote Reading Workflow](#) provides worklists, status and result tracking for imaging studies distributed to other locations for review and return of a diagnostic report.
- [XRR-WD] [Cross Enterprise Remote Read Workflow Definition](#) provides a workflow definition to enable remote interpretation of imaging studies.
- [IDEP] [Import and Display of External Priors](#) automates the discovery and import of relevant prior imaging studies and reports from affiliated facilities, i.e., "external priors".

Profiles for Content

- [NMI] [Nuclear Medicine Image](#) specifies how Nuclear Medicine images and result screens are created, exchanged, used and displayed.
- [MAMMO] [Mammography Image](#) specifies how Mammography images and evidence objects are created, exchanged, used and displayed.
- [ED] [Evidence Documents](#) specifies how data objects such as digital measurements are created, exchanged, and used.
- [SINR] [Simple Image and Numeric Report](#) specifies how Diagnostic Radiology Reports (including images and numeric data) are created, exchanged, and used.
- [REM] [Radiation Exposure Monitoring](#) specifies how radiation details from imaging procedures are created, exchanged and used.
- [REM-NM] [Radiation Exposure Monitoring for Nuclear Medicine](#) specifies how radiation details from procedures using radiopharmaceuticals are created, exchanged and used.
- [CAM] [Contrast Administration Management](#) specifies how contrast administration details from imaging procedures are created, exchanged and used.
- [MAP] [Management of Acquisition Protocols](#) specifies how acquisition protocols are exchanged between scanners and a protocol management workstation.
- [PERF] [CT/MR Perfusion Imaging](#) specifies encoding of Contrast Perfusion imaging data using Enhanced CT/MR DICOM objects.
- [DIFF] [MR Diffusion Imaging](#) specifies encoding of MR Diffusion imaging data using Enhanced MR DICOM objects.
- [CXCAD] [Chest X-ray CAD display](#) specifies how Chest X-Ray images and evidence objects are created, exchanged, used and displayed.
- [DBT] [Digital Breast Tomosynthesis](#) specifies how Mammography and Digital Breast Tomography images and evidence objects are created, exchanged, used and displayed.
- [RD] [Results Distribution](#) specifies how radiology results (i.e., radiology reports) are exchanged.
- [SMI] [Stereotactic Mammography Image](#) specifies how Stereotactic Mammography images are created, exchanged, used and displayed.

Scree

ESEMPIO: IHE radiology profiles

- [SMI] [Stereotactic Mammography Image](#) specifies how Stereotactic Mammography images are created, exchanged, used and displayed.
- [MRRT] [Management of Radiology Report Templates](#) specifies how templates for Radiology Reports are created, exchanged, and used.
- [AIR] [AI Results](#) specifies how medical imaging analysis results are exchanged, stored, and displayed.

Profiles for Presentation

- [KIN] [Key Image Note](#) lets users flag images as significant (e.g., for referring, for surgery, etc.) and add notes.
- [CPI] [Consistent Presentation of Images](#) maintains consistent intensity and image transformations between different hardcopy and softcopy devices.
- [PGP] [Presentation of Grouped Procedures](#) helps view and report individual requested procedures (e.g., head, chest, abdomen) that an operator has grouped into a single scan.
- [FUS] [Image Fusion](#) integrates systems creating, registering and displaying fused image sets and storing their results.
- [BIR] [Basic Image Review](#) defines baseline features and user interface for simple review of DICOM images.

Profiles for Infrastructure

- [PDI] [Portable Data for Imaging](#) stores image data and diagnostic reports on CDs, DVDs or USB for importing, printing or displaying in a browser.
- [XDS-I.b] [Cross-enterprise Document Sharing for Imaging.b](#) extends XDS to share images, diagnostic reports and related information across a group of care sites.
- [TCE] [Teaching File and Clinical Trial Export](#) lets users flag images and related information for automatic routing to teaching file authoring or clinical trials management systems.
- [ARI] [Access to Radiology Information](#) shares images, diagnostic reports, and related information inside a single network.
- [ATNA] [Audit Trail and Node Authentication - Radiology Option](#) defines Radiology-specific audit trail messages and security measures to protect patient information confidentiality.
- [WIA] [Web-based Image Access](#) shares and views (interactively) imaging studies using RESTful services.
- [XCA-I] [Cross-Community Access for Imaging](#) extends XCA to share images, diagnostic reports and related information across communities.
- [XDR-I] [Cross-Enterprise Reliable Document Interchange for Imaging](#) extends XDR to push images, diagnostic reports and related information between healthcare providers.
- [IOCM] [Imaging Object Change Management](#) communicates image replacement or deletion instructions between multiple imaging systems.
- [IID] [Invoke Image Display](#) allows an EHR/PHR/RIS to request a PACS (IM/IA/ID) to display images of a patient or study.
- [CDS-OAT] [Clinical Decision Support Order Appropriateness Tracking](#) communicates Appropriate Use Criteria (AUC) results downstream for inclusion in reporting and billing.
- [WIC] [Web-based Image Capture](#) stores imaging objects using a DICOM RESTful API.
- [WIA] [Web-based Image Access](#) shares and views (interactively) imaging studies using RESTful services.
- [SOLE] [Standardized Operational Log of Events](#) stores and retrieves logs of operational events (patient arrives, scan complete, etc.). 

Scree

ESEMPIO: SCHEDULED WORKFLOW (SWF)

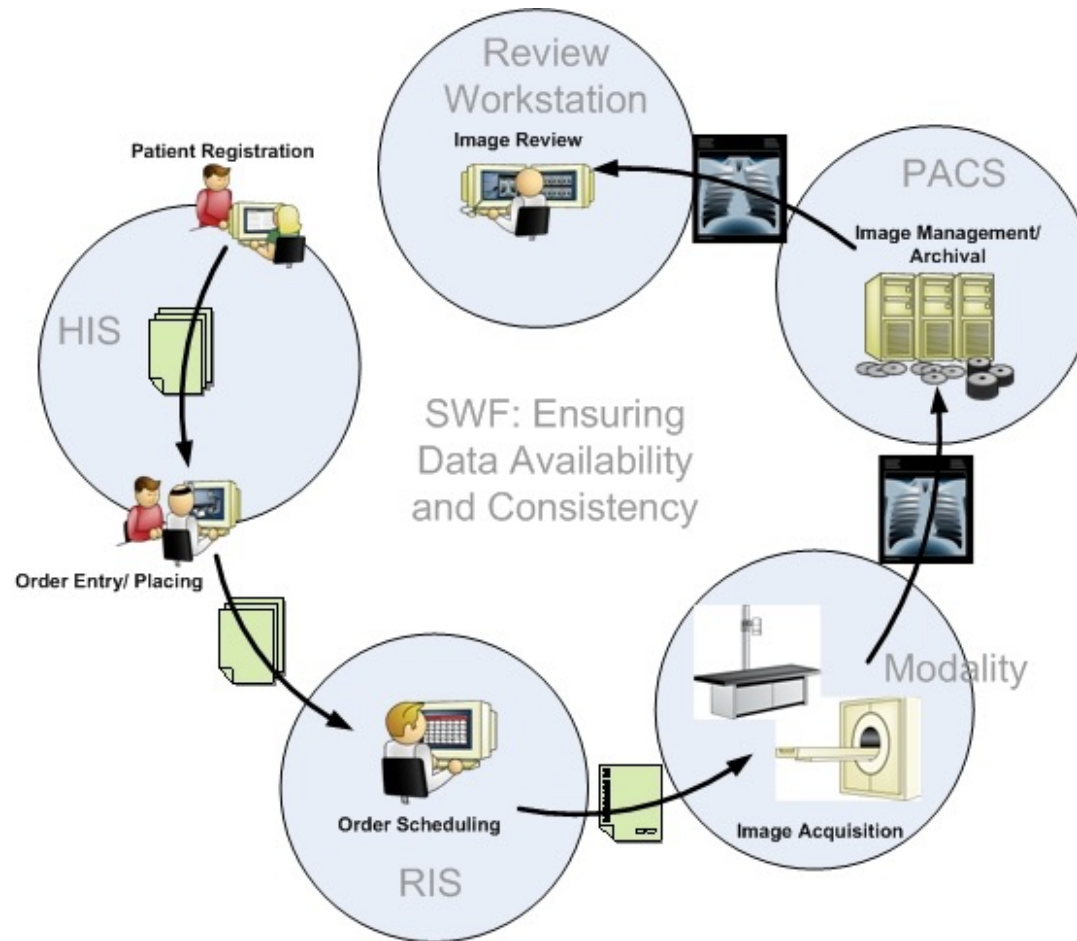

SCHEDULED WORKFLOW EVENTS

IHE Workflow Events

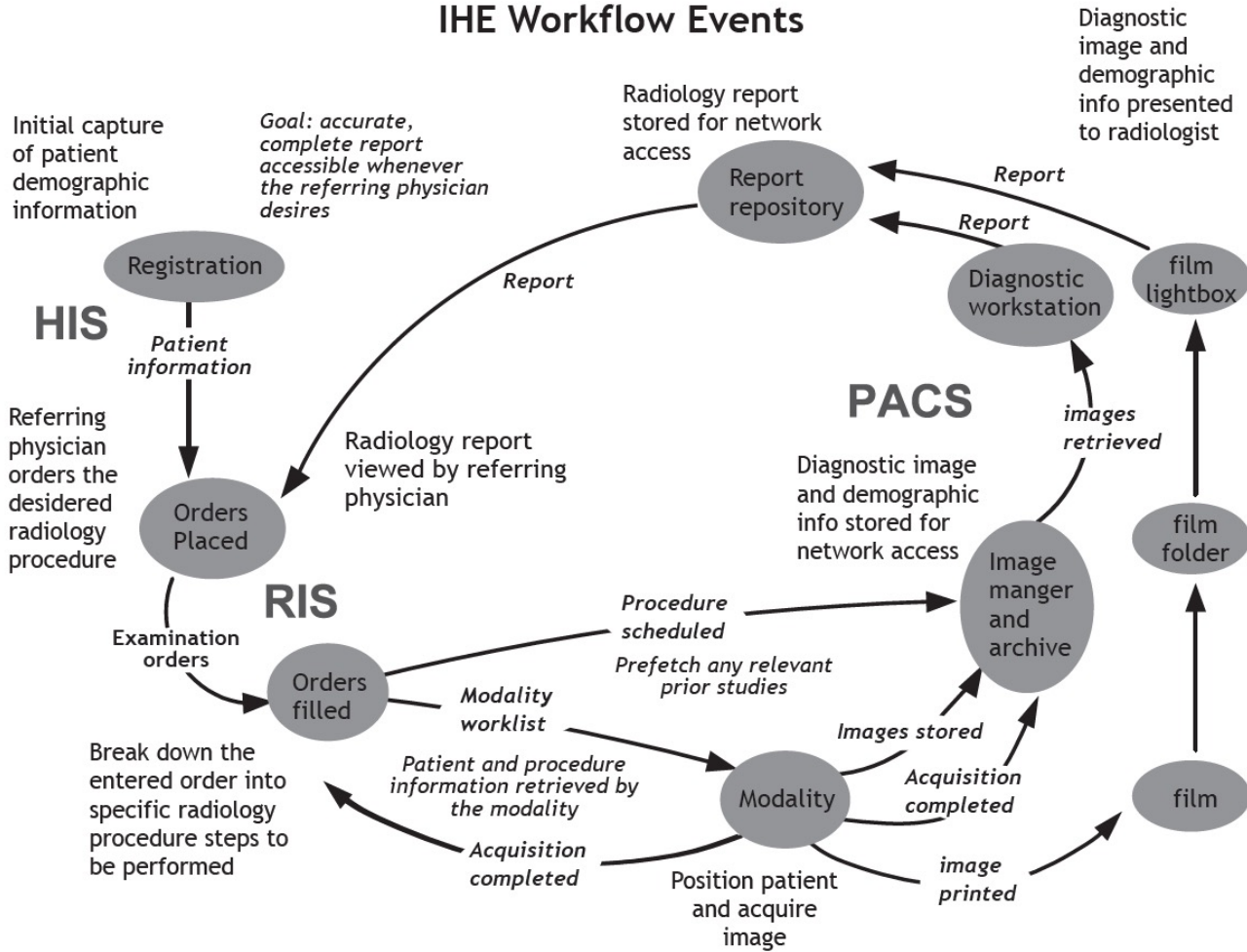

SWF: ATTORI E TRANSIZIONI

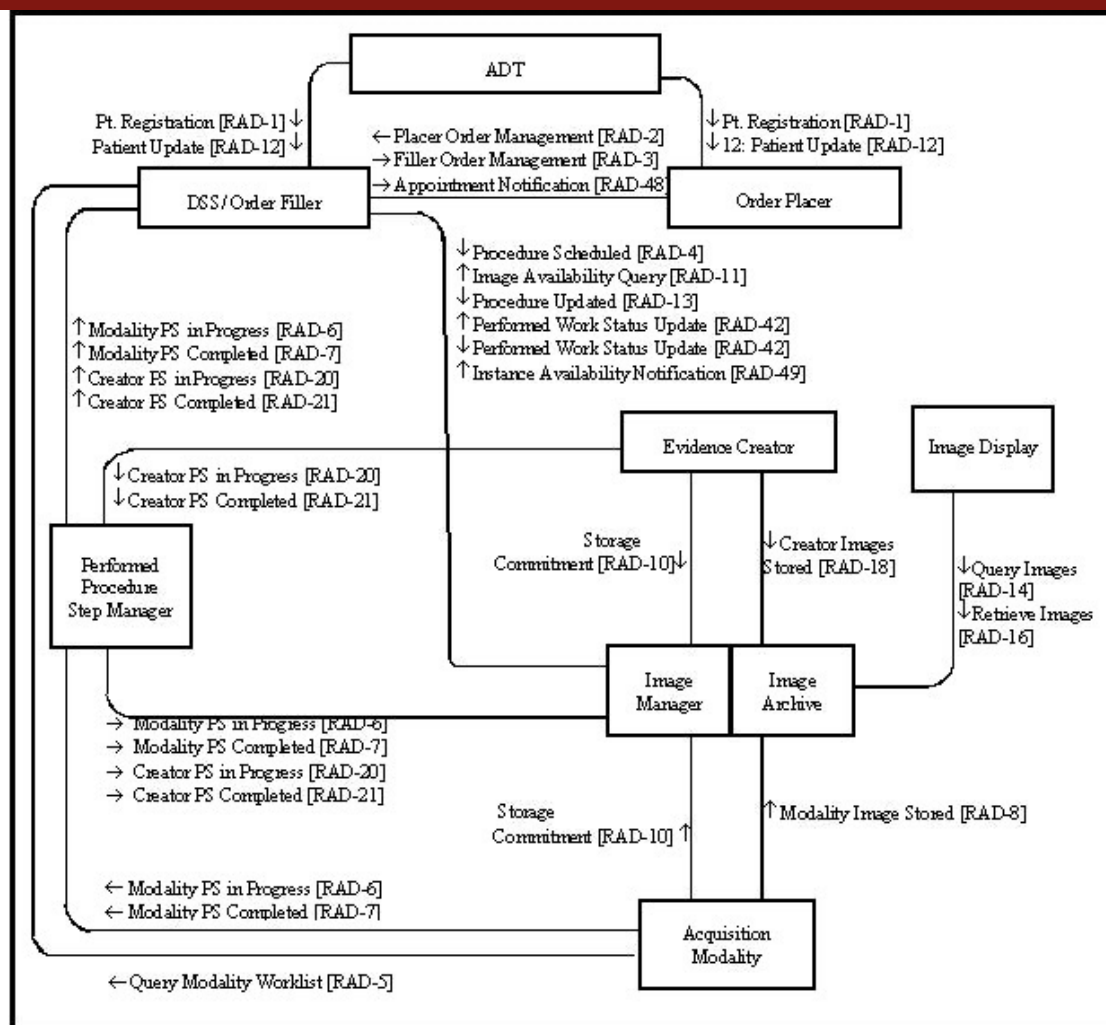

ESEMPIO: RAD-1

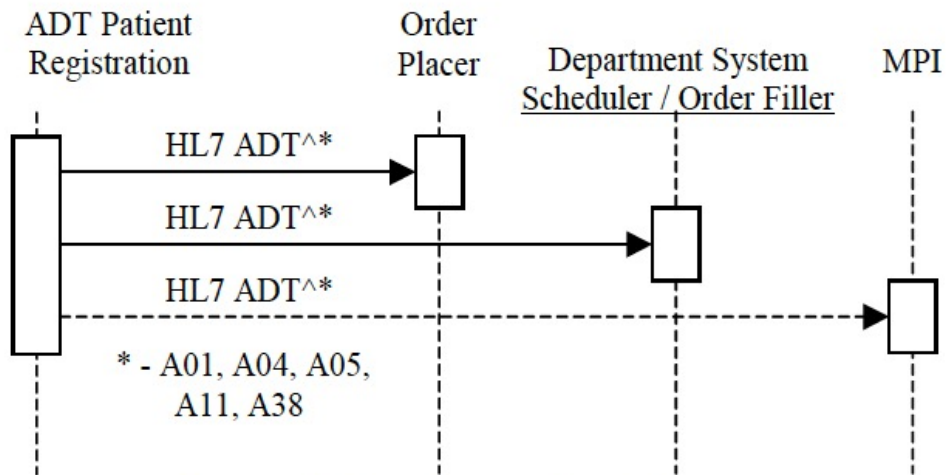

Figure 4.1.4-1: Interaction Diagram

4.1 Patient Registration [RAD-1]

4.1.1 Scope

This transaction involves the patient information, including demographics, captured at the point of encounter. This may occur when the visit is scheduled, if that precedes patient arrival at the institution. This transaction is used for both in-patients (i.e., those who are assigned a bed at the facility) and outpatients (i.e., those who are not assigned a bed at the facility).

ADT	Patient Administration Message	Chapter in HL7 2.3.1
MSH	Message Header	2
EVN	Event Type	3
PID	Patient Identification	3
PV1	Patient Visit	3
[[{OBX}]]	Observation/Result	7
[[{AL1}]]	Allergy Information	3

ESEMPIO: RAD-14

4.14 Query Images [RAD-14]

4.14.1 Scope

The Image Display queries the Image Archive for study, series and image instances for retrieval.

4.14.2 Actor Roles

Actor: Image Archive

Role: Responds to queries for Studies, Series, and Images.

Actor: Image Display

Role: Issues Queries for Studies, Series, Images

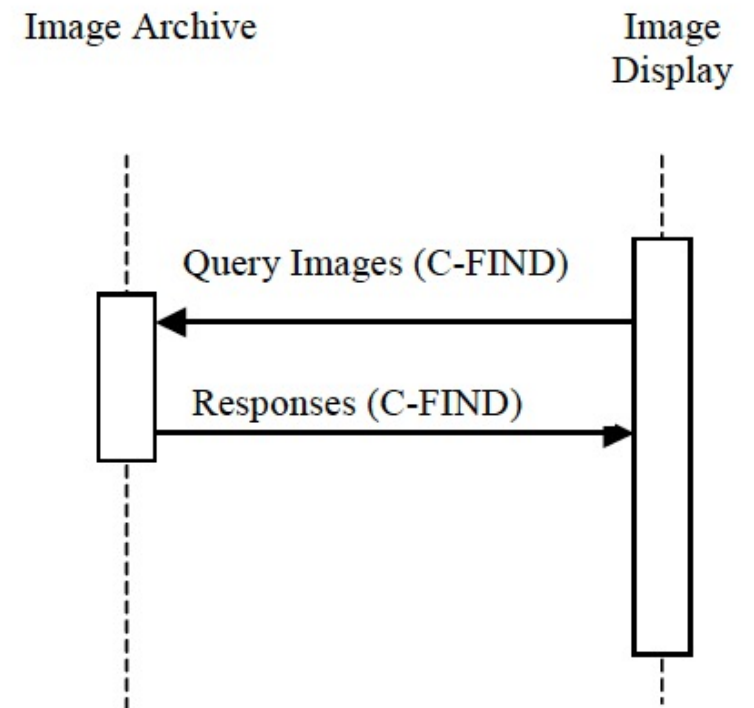

Figure 4.14.4-1: Interaction Diagram

INTEGRAZIONE DIPARTIMENTALE: ESEMPIO

