

# Astrofisica Nucleare e Subnucleare

## Gamma ray Bursts – II

# The Compton Gamma Ray Observatory

<http://coss.c.gsfc.nasa.gov>

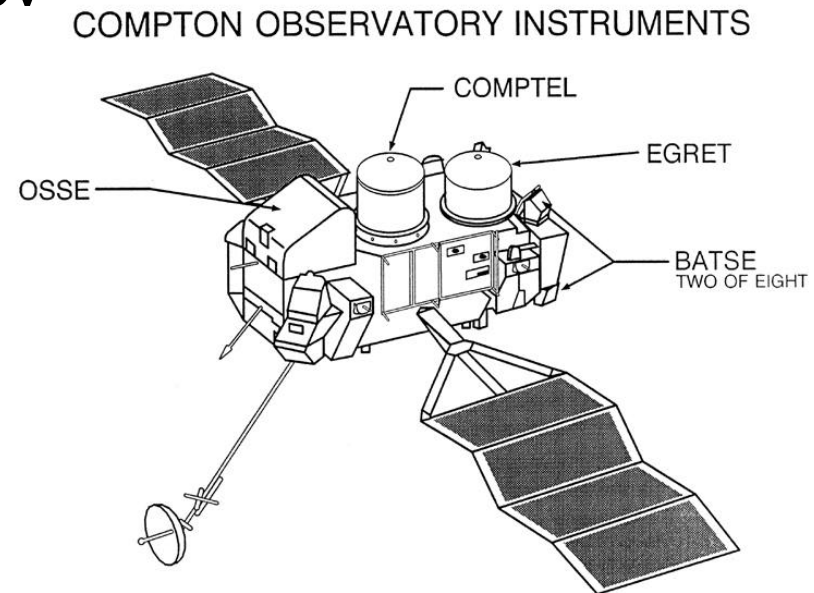
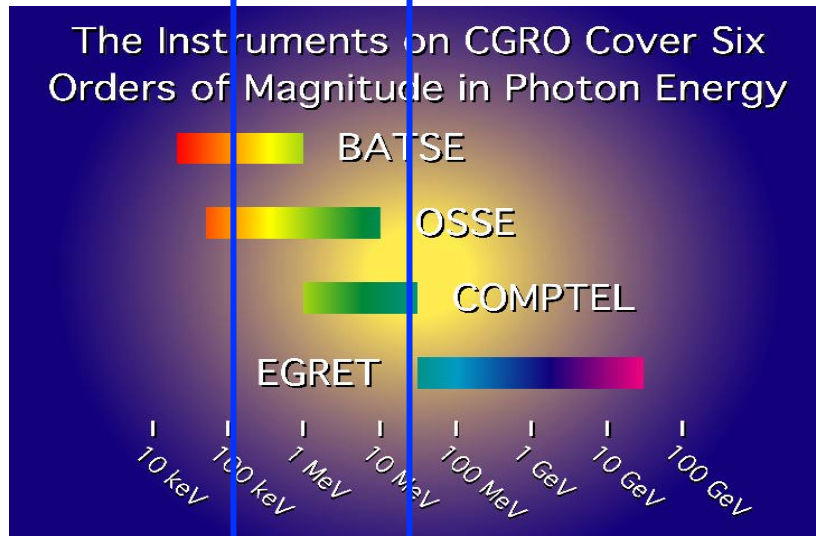

The Compton Gamma Ray Observatory (CGRO) is a sophisticated satellite observatory dedicated to observing the high-energy Universe. It is the second in NASA's program of orbiting "Great Observatories", following the Hubble Space Telescope. While Hubble's instruments operate at visible and ultraviolet wavelengths, Compton carries a collection of four instruments which together can detect an unprecedented broad range of high-energy radiation called gamma rays. These instruments are the Burst And Transient Source Experiment (BATSE), the Oriented Scintillation Spectrometer Experiment (OSSE), the Imaging Compton Telescope (COMPTEL), and the Energetic Gamma Ray Experiment Telescope (EGRET).

# Gamma-Ray Bursts

Temporal behaviour

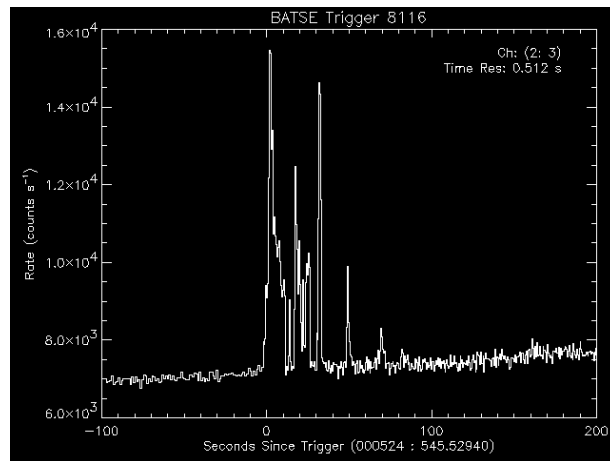

Spectral shape

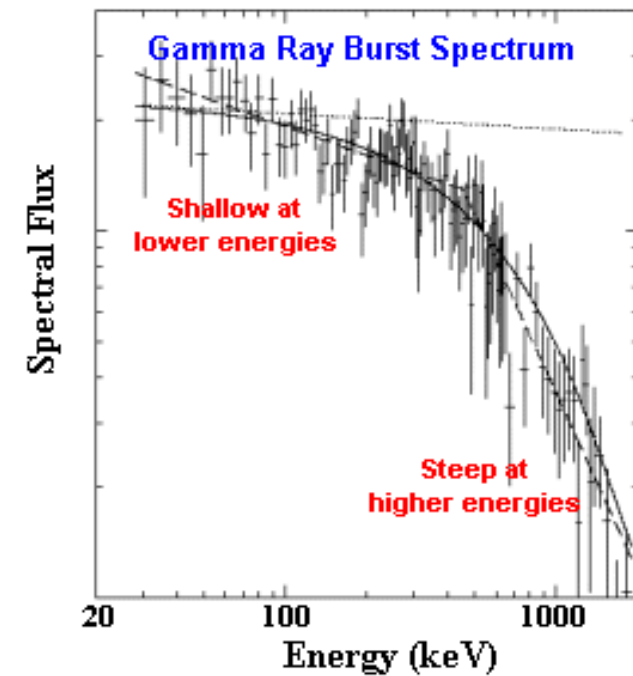

2704 BATSE Gamma-Ray Bursts

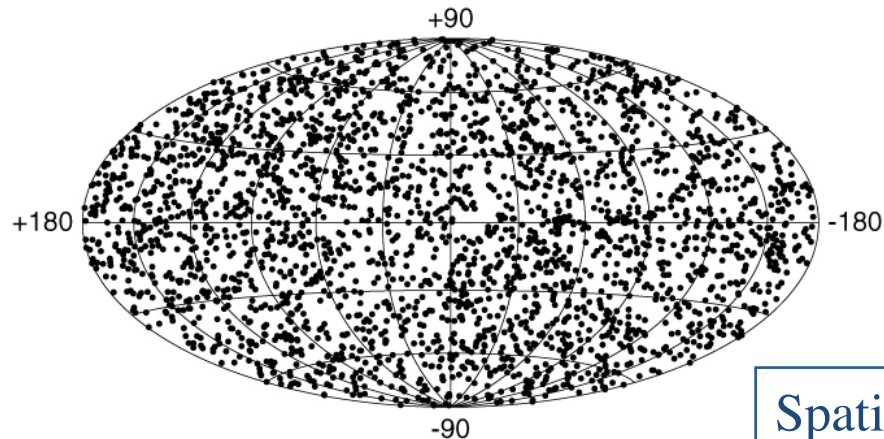

Spatial distribution

# GRB: where are they?

The great debate (1995)



Flux:  $10^{-7}$  erg cm $^{-2}$  s $^{-1}$

Distance: 1 Gpc

Energy:  $10^{51}$  erg

Distance: 100 kpc

Energy:  $10^{43}$  erg

Cosmological - Galactic?

Need a new type of observation!



# Exercise #2

- Find the GRB function by David Band (1993)
- Find the review paper by Piran 1999 on GRB afterglow
- Find the paper by L.Amati on Ep-Eiso correlation (2002)
- Find the papers of the “Great Debate (1995)”

# Exercise #2

- Find the GRB function by David Band (1993)

THE ASTROPHYSICAL JOURNAL, 413:281–292, 1993 August 10  
© 1993. The American Astronomical Society. All rights reserved. Printed in U.S.A.

## BATSE OBSERVATIONS OF GAMMA-RAY BURST SPECTRA. I. SPECTRAL DIVERSITY

D. BAND, J. MATTESON, AND L. FORD

Center for Astrophysics and Space Sciences 0111, University of California at San Diego, La Jolla, CA 92093

B. SCHAEFER, D. PALMER, B. TEEGARDEN, AND T. CLINE

NASA/Goddard Space Flight Center, Code 661, Greenbelt, MD 20771

M. BRIGGS, W. PACIASAS, AND G. PENDLETON

University of Alabama at Huntsville, Huntsville, AL 35899

G. FISHMAN, C. KOUVELIOTOU, C. MEEGAN, AND R. WILSON

NASA/Marshall Space Flight Center, ES-62, Huntsville, AL 35812

AND

P. LESTRADE

Mississippi State University, P.O. Box 5167, Mississippi State, MS 39762

*Received 1992 November 17; accepted 1993 February 19*

# Exercise #2

- Find the GRB function by David Band (1993)

## ABSTRACT

We studied the time-averaged gamma-ray burst spectra accumulated by the spectroscopy detectors of the Burst and Transient Source Experiment (BATSE). The spectra are described well at low energy by a power-law continuum with an exponential cutoff,  $N_E(E) \propto E^\alpha \exp(-E/E_0)$ , and by a steeper power law,  $N_E(E) \propto E^\beta$  with  $\alpha > \beta$ , at high energy. However, the spectral parameters  $\alpha$ ,  $\beta$ , and  $E_0$  vary from burst to burst with no universal values. The break in the spectrum,  $E_0$ , ranges from below 100 keV to more than 1 MeV, but peaks below 200 keV with only a small fraction of the spectra breaking above 400 keV. Consequently, it is unlikely that a majority of the burst spectra are shaped directly by pair processes, unless bursts originate from a broad redshift range. We find that the correlations among burst parameters do not fulfill the predictions of the cosmological models of burst origin, but our burst sample may not be appropriate for such a test. No correlations with burst morphology or the spatial distribution were found. We also studied the process of fitting the BATSE spectral data. For example, we demonstrate the importance of using a complete spectral description even if a partial description (e.g., a model without a high-energy tail) is statistically satisfactory.

*Subject headings:* gamma rays: bursts — radiation mechanisms: miscellaneous

# Exercise #2

- Find the review paper by Piran 1999 on GRB afterglow



ELSEVIER

Physics Reports 314 (1999) 575–667

---

---

PHYSICS REPORTS

---

---

[www.elsevier.com/locate/physrep](http://www.elsevier.com/locate/physrep)

## Gamma-ray bursts and the fireball model

Tsvi Piran<sup>a,b,1</sup>

<sup>a</sup>*Racah Institute for Physics, The Hebrew University, Jerusalem, 91904, Israel*<sup>2</sup>

<sup>b</sup>*Physics Department, Columbia University, New York, NY 10027, USA*

Received October 1998 editor: M.P. Kamionkowski

# Exercise #2

- Find the review paper by Piran 1999 on GRB afterglow

## **Abstract**

Gamma-ray bursts (GRBs) have puzzled astronomers since their accidental discovery in the late 1960s. The BATSE detector on the COMPTON-GRO satellite has been detecting one burst per day for the last six years. Its findings have revolutionized our ideas about the nature of these objects. They have shown that GRBs are at cosmological distances. This idea was accepted with difficulties at first. The recent discovery of an X-ray afterglow by the Italian/Dutch satellite BeppoSAX has led to a detection of high red-shift absorption lines in the optical afterglow of GRB970508 and in several other bursts and to the identification of host galaxies to others. This has confirmed the cosmological origin. Cosmological GRBs release  $\sim 10^{51}$ – $10^{53}$  erg in a few seconds making them the most (electromagnetically) luminous objects in the Universe. The simplest, most conventional, and practically inevitable, interpretation of these observations is that GRBs result from the conversion of the kinetic energy of ultra-relativistic particles or possibly the electromagnetic energy of a Poynting flux to radiation in an optically thin region. This generic “fireball” model has also been confirmed by the afterglow observations. The “inner engine” that accelerates the relativistic flow is hidden from direct observations. Consequently, it is difficult to infer its structure directly from current observations. Recent studies show, however, that this “inner engine” is responsible for the complicated temporal structure observed in GRBs. This temporal structure and energy considerations indicates that the “inner engine” is associated with the formation of a compact object – most likely a black hole. © 1999 Elsevier Science B.V. All rights reserved.

*PACS:* 98.70.Rz; 95.30.Lz; 95.30.Sf

*Keywords:* Gamma-ray bursts



# Exercise #2

- Find the paper by L. Amati on Ep-Eiso correlation (2002)

A&A 390, 81–89 (2002)  
DOI: 10.1051/0004-6361:20020722  
© ESO 2002

**Astronomy  
&  
Astrophysics**

## **Intrinsic spectra and energetics of BeppoSAX Gamma-Ray Bursts with known redshifts**

L. Amati<sup>1</sup>, F. Frontera<sup>1,2</sup>, M. Tavani<sup>3</sup>, J. J. M. in 't Zand<sup>4</sup>, A. Antonelli<sup>5</sup>, E. Costa<sup>6</sup>, M. Feroci<sup>6</sup>, C. Guidorzi<sup>2</sup>, J. Heise<sup>4</sup>, N. Masetti<sup>1</sup>, E. Montanari<sup>2</sup>, L. Nicastro<sup>7</sup>, E. Palazzi<sup>1</sup>, E. Pian<sup>8</sup>, L. Piro<sup>6</sup>, and P. Soffitta<sup>6</sup>

<sup>1</sup> Istituto di Astrofisica Spaziale e Fisica cosmica – Sezione di Bologna, CNR, Via Gobetti 101, 40129 Bologna, Italy

<sup>2</sup> Dipartimento di Fisica, Università di Ferrara, Via Paradiso 12, 44100 Ferrara, Italy

<sup>3</sup> Istituto di Astrofisica Spaziale e Fisica cosmica – Sezione di Milano, CNR, Via Bassini 15, 20133 Milano, Italy

<sup>4</sup> Space Research Organization Netherlands, Sorbonnelaan 2, 3584 CA Utrecht, The Netherlands

<sup>5</sup> Osservatorio Astronomico di Roma, Via Frascati 33, 00040 Monteporzio Catone (RM), Italy

<sup>6</sup> Istituto di Astrofisica Spaziale e Fisica cosmica, CNR, Via Fosso del Cavaliere, 00133 Roma, Italy

<sup>7</sup> Istituto di Astrofisica Spaziale e Fisica cosmica – Sezione di Palermo, CNR, Via La Malfa 153, 90146 Palermo, Italy

<sup>8</sup> Osservatorio Astronomico di Trieste, Via G.B. Tiepolo 11, 34131, Trieste, Italy

# Exercise #2

- Find the paper by L.Amati on Ep-Eiso correlation (2002)

**Abstract.** We present the main results of a study of spectral and energetics properties of twelve gamma-ray bursts (GRBs) with redshift estimates. All GRBs in our sample were detected by BeppoSAX in a broad energy range (2–700 keV). From the redshift estimates and the good-quality BeppoSAX time-integrated spectra we deduce the main properties of GRBs in their cosmological rest frames. All spectra in our sample are satisfactorily represented by the Band model, with no significant soft X-ray excesses or spectral absorptions. We find a positive correlation between the estimated total (isotropic) energies in the 1–10 000 keV energy range ( $E_{\text{rad}}$ ) and redshifts  $z$ . Interestingly, more luminous GRBs are characterized also by larger peak energies  $E_p$ s of their  $EF(E)$  spectra. Furthermore, more distant GRBs appear to be systematically harder in the X-ray band compared to GRBs with lower redshifts. We discuss how selection and data truncation effects could bias our results and give possible explanations for the correlations that we found.

**Key words.** gamma-rays: bursts – gamma rays: observations – X-rays: general

# Exercise #2

<https://apod.nasa.gov/debate/debate95.html>

- Find the papers of the “Great Debate (1995)”



## The Distance Scale to Gamma-Ray Bursts Great Debate in 1995

In April 1920, Harlow Shapley and Heber D. Curtis first debated [The Scale of the Universe](#) in the main auditorium of Smithsonian's Natural History Museum in Washington, DC. In April 1995, this debate was commemorated by holding another debate on a topic with marked similarities. In 1995, the distance scale to gamma-ray bursts were as uncertain as the distance scale to spiral nebulae was in 1920. Evidence appeared to be mounting that GRBs occur in our Galaxy, but conflicting evidence also appeared to be mounting that GRBs occur at cosmological distances. Therefore, at this debate, Lamb and Paczynski publicly disagreed, and each displayed evidence and reasoning on why one distance scale should be preferred over the other.

**Debate Proceedings:** Six published papers from the diamond jubilee debate appeared in the 1995 December Publications of the Astronomical Society of the Pacific. Included are the two introductory talks, an opening by one of the organizers, and a closing by the moderator.

[An Introduction](#) by Robert Nemiroff

[The 1920 Shapley-Curtis Discussion: Background, Issues, And Outcome](#) by Virginia Trimble

[Gamma-Ray Bursts: An Overview](#) by Gerald Fishman

[How Far Away Are Gamma-Ray Bursters?](#) by Bohdan Paczynski

[The Distance Scale To Gamma-Ray Bursts](#) by Donald Q. Lamb

[Concluding Remarks](#) by Martin Rees

**About the 1995 Debate:** Background information about the 1995 debate is given below.

[The Program](#) distributed at the 1995 Diamond Jubilee Debate. The program includes an introduction, the schedule of events, and a brief profile of all the program participants.

[Images from the debate.](#)

[Comments about the debate.](#) Comments from people who attended the debate are being compiled. Some comments are available - updated June 16, 1995.

**Scientific Background:** Below find links and lists intended for students, educators, and the generally inquisitive.

[A Brief History of the Discovery of Cosmic Gamma-Ray Bursts](#) by J. T. Bonnell

[A short bibliography for the 1995 debate.](#) Some of these articles are highly technical in nature.

[A Glossary of terms used in the 1995 debate.](#)

[Gamma Ray Bursts from the Unknown](#) an Astronomy Picture of the Day describing the great "GRB" mystery. Follow the links to find more information.

[Optical Transient Near GRB970508 Shows Distant Redshift](#) an [APOD](#) describing how a solution to this mystery may have now been found.

[Brighter Than a Million Galaxies](#) press releases from NASA's Marshall Space Flight Center describing recent events.

[Return to Great Debates in Astronomy Page](#)

# Exercise #2

- Find the papers of the “Great Debate (1995)”

Publications of the Astronomical Society of the Pacific  
107: 1152–1166, 1995 December

## The Distance Scale to Gamma-Ray Bursts

D. Q. LAMB

Department of Astronomy and Astrophysics, and Enrico Fermi Institute, University of Chicago, Chicago, Illinois 60637

*Received 1995 August 31; accepted 1995 September 22*

**ABSTRACT.** We do not yet know the distance scale to gamma-ray bursts. Here I discuss several observational results and theoretical calculations which provide evidence about the distance scale. First, I describe the recent discovery that many neutron stars have high enough velocities to escape from the Milky Way. These high-velocity neutron stars form a distant, previously unknown Galactic “corona.” This distant corona is isotropic when viewed from Earth, and consequently, the population of neutron stars in it can easily explain the angular and brightness distributions of the BATSE bursts. If this were all of the evidence that we considered, we could not distinguish the cosmological and Galactic hypotheses. I contend that we can go further, by considering other important evidence. I draw attention to the many similarities between soft gamma-ray repeaters, which are known to be high-velocity neutron stars, and gamma-ray bursts. I point out that the source of the famous 1979 March 5 event, which is a high-velocity neutron star 50 kpc away from us, demonstrates that high-velocity neutron stars are capable of producing bursts which have the energy, the duration, and the spectrum of gamma-ray bursts. Finally, I comment that high-velocity neutron stars in a distant Galactic corona can account for cyclotron lines and repeating, and naturally explain the absence of bright optical counterparts in gamma-ray-burst error boxes, whereas all of these present major difficulties for cosmological models. I conclude that when we consider all of the evidence, it adds up to a strong case for the Galactic hypothesis.

# Exercise #2

- Find the papers of the “Great Debate (1995)”

Publications of the Astronomical Society of the Pacific  
107: 1167–1175, 1995 December

## How Far Away Are Gamma-Ray Bursters?

BOHDAN PACZYŃSKI

Princeton University Observatory, Princeton, New Jersey 08544-1001, Visiting Scientist, National Astronomical Observatory,  
Mitaka, Tokyo, 181, Japan  
Electronic mail: [bp@astro.princeton.edu](mailto:bp@astro.princeton.edu)

*Received 1995 August 31; accepted 1995 September 22*

**ABSTRACT.** The positions of over 1000 gamma-ray bursts detected with the BATSE experiment on board the *Compton Gamma Ray Observatory* are uniformly and randomly distributed in the sky, with no significant concentration to the galactic plane or to the galactic center. The strong gamma-ray bursts have an intensity distribution consistent with a number density independent of distance in Euclidean space. Weak gamma-ray bursts are relatively rare, indicating that either their number density is reduced at large distances or that the space in which they are distributed is non-Euclidean. In other words, we appear to be at the center of a spherical and bounded distribution of bursters. This is consistent with the distribution of all objects that are known to be at cosmological distances (like galaxies and quasars), but inconsistent with the distribution of any objects which are known to be in our galaxy (like stars and globular clusters). If the bursters are at cosmological distances then the weakest bursts should be redshifted, i.e., on average their durations should be longer and their spectra should be softer than the corresponding quantities for the strong bursts. There is some evidence for both effects in the BATSE data. At this time the cosmological distance scale is strongly favored over the galactic one, but is not proven. A definite proof (or disproof) could be provided with the results of a search for very weak bursts in the Andromeda galaxy (M31) with an instrument  $\sim 10$  times more sensitive than BATSE. If the bursters are indeed at cosmological distances then they are the most luminous sources of electromagnetic radiation known in the Universe. At this time we have no clue as to their nature, even though well over a hundred suggestions have been published in the scientific journals. An experiment providing  $\sim 1$  arcsecond positions would greatly improve the likelihood that counterparts of gamma-ray bursters are finally found. A new interplanetary network would offer the best opportunity.



# The compactness problem

Light curve variability  $\sim 1$  ms

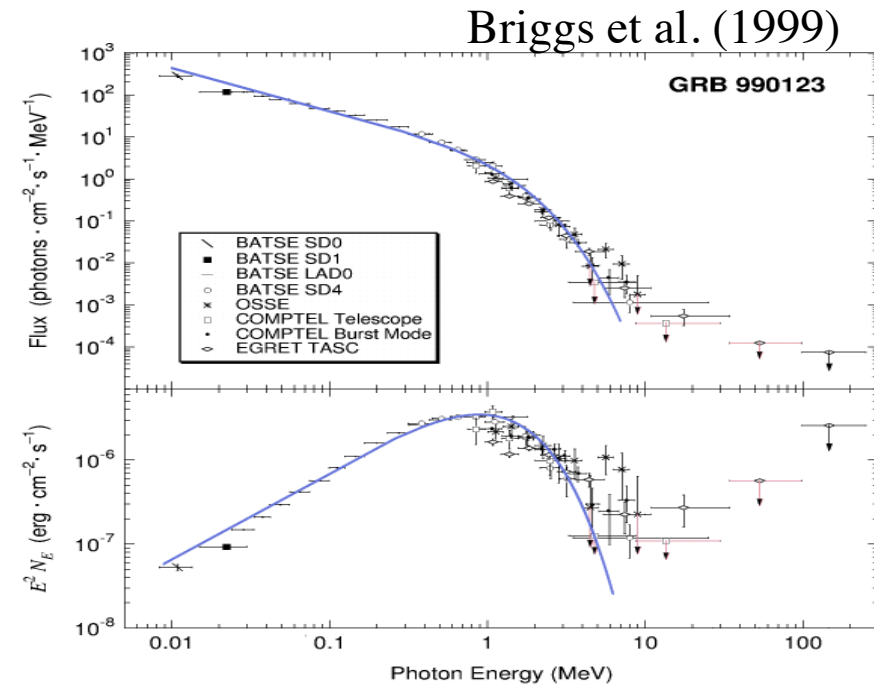
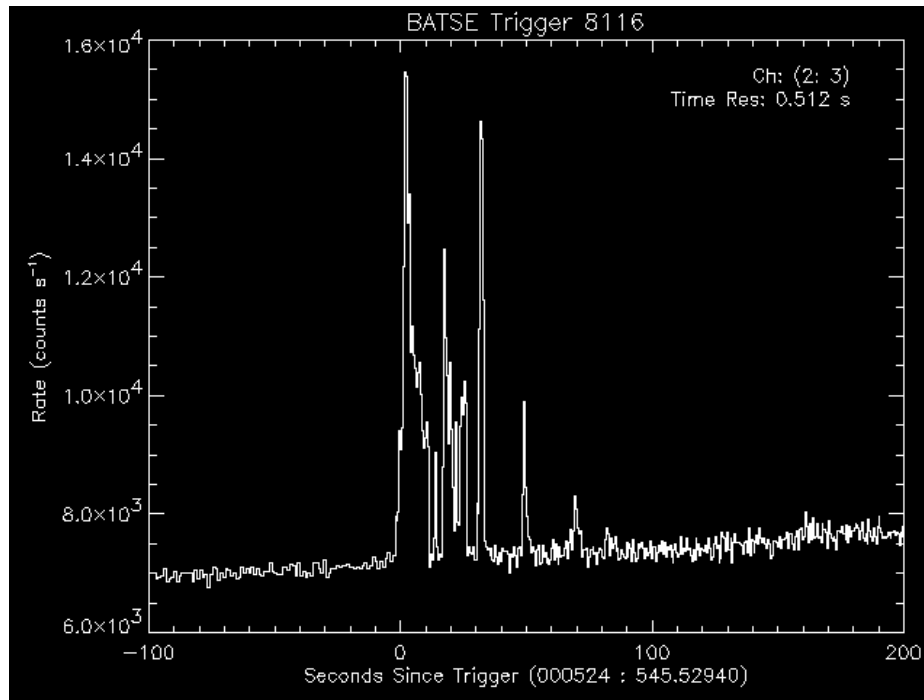

Non thermal spectra

- Fluence ( $\gamma$ ):  $(0.1-10) \times 10^{-6}$  erg/ $cm^2$  ( $\Omega/4\pi$ )
- Total Energy:  $E \sim 10^{51} \div 10^{52}$  erg

# Superluminal motion

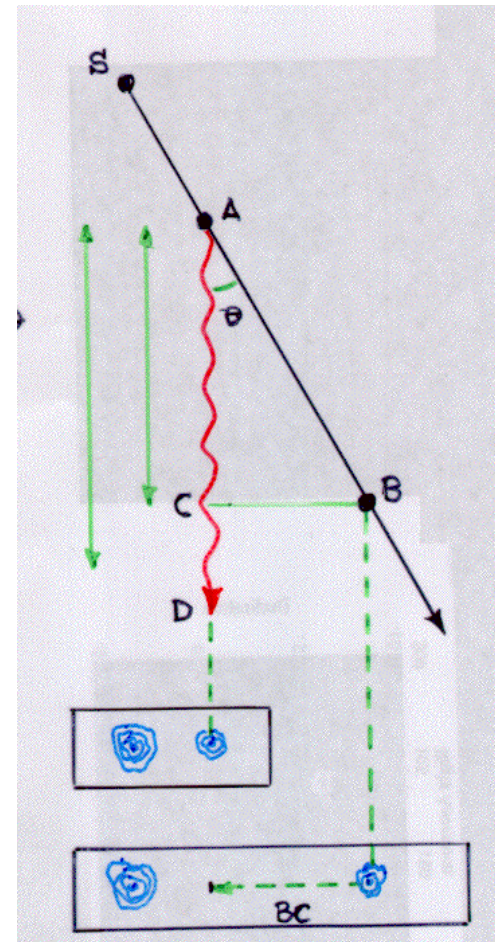
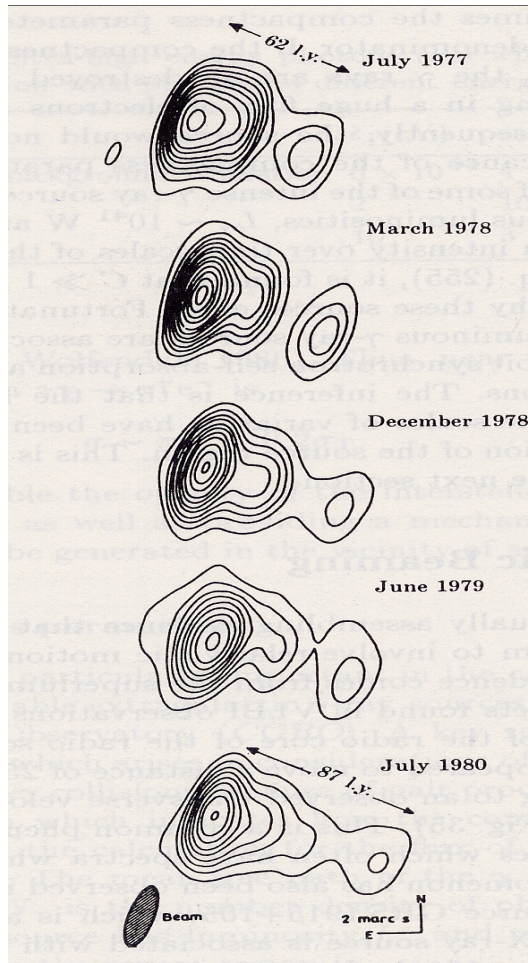

# Superluminal motion

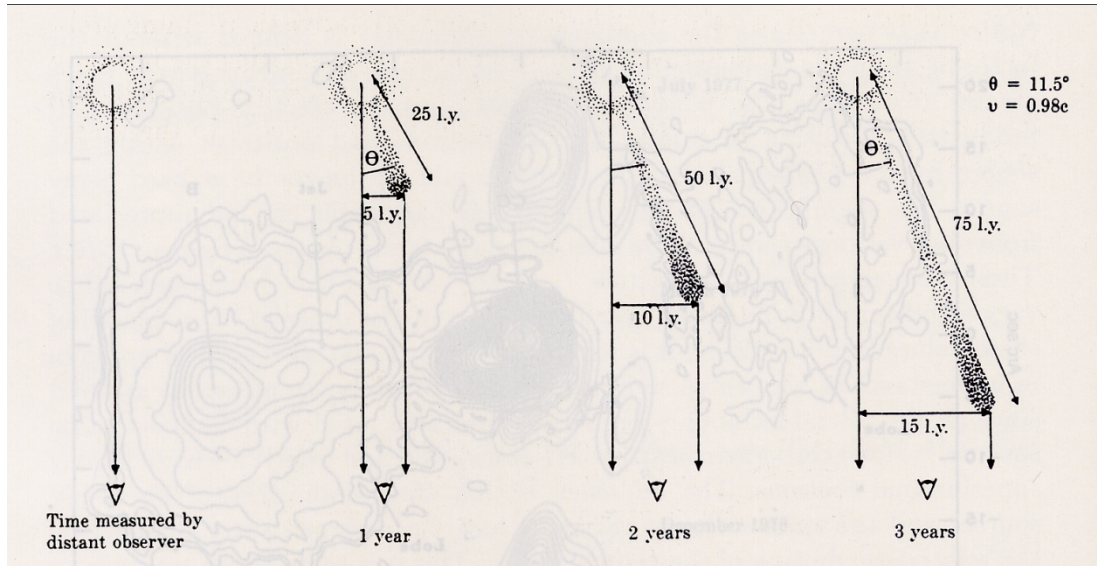

Arrival time of "bullets" emission

$$t'_A = t_A + \frac{D + v\delta t \cos\theta}{c}$$

$$t'_B = t_B + \frac{D}{c}$$

$$\delta t' = \delta t(1 - \beta \cos\theta)$$

$$v_{\perp} = \frac{v \sin\theta}{1 - \beta \cos\theta}$$

$$\cos\theta = \frac{v}{c}$$

$$\sin\theta = \sqrt{1 - \beta^2}$$

$$v_{\perp} = \gamma v$$

# The compactness problem

$$R_i < c\delta t \quad \gamma\gamma \rightarrow e^+e^-$$

$$\tau_{\gamma\gamma} = \frac{f_p \sigma_T F D_L^2}{R_i^2 m_e c^2} \approx 10^{17} f_p \left( \frac{F}{10^{-6} \text{ erg/cm}^2} \right) \left( \frac{D_L}{3 \text{ Gpc}} \right)^2 \left( \frac{\delta t}{1 \text{ ms}} \right)$$

$$\tau_{\gamma\gamma} \gg 1$$

Very High Optical Depth to pair production

$$\Gamma = \frac{1}{\sqrt{1 - \beta^2}}$$

$$R_i < \Gamma^2 c\delta t \quad f_p \rightarrow f_p \Gamma^{-2\alpha}$$

Size

Pair fraction

$$\tau_{\gamma\gamma} = \frac{f_p \sigma_T F D_L^2}{R_i^2 m_e c^2} \approx \frac{10^{17}}{\Gamma^{4+2\alpha}} f_p \left( \frac{F}{10^{-6} \text{ erg/cm}^2} \right) \left( \frac{D_L}{3 \text{ Gpc}} \right)^2 \left( \frac{\delta t}{1 \text{ ms}} \right)$$

$$\Gamma \approx 10^2 \div 10^3$$

Piran (1999)



# Radial transformations

Consider an observer located at a distance  $R$  from the point A. The radiation from A reaches the observer at time  $R/c$ . The radiation emitted from B takes place at time  $L/v$  later and it then travels a distance  $(R - L)$  at the speed of light to reach the observer. The trailing edge of the pulse therefore arrives at the observer at a time  $L/v + (R - L)/c$ . The duration of the pulse as measured by the observer is therefore

$$\Delta t = \left[ \frac{L}{v} + \frac{(R - L)}{c} \right] - \frac{R}{c} = \frac{L}{v} \left[ 1 - \frac{v}{c} \right]. \quad (8.16)$$

The observed duration of the pulse is much less than the time interval  $L/v$ , which might have been expected. Only if light propagated at an infinite velocity would the duration of the pulse be  $L/v$ . The intriguing point about this analysis is that the factor  $1 - (v/c)$  is exactly the same factor which appears in the Liénard–Wiechert potentials (6.19) and which takes account of the fact that the source of radiation is moving towards the observer. The



# Radial transformations

relativistic electron almost catches up with the radiation emitted at A since  $v \approx c$ , but not quite. We can rewrite (8.16) using the fact that

$$\frac{L}{v} = \frac{r_g \theta}{v} \approx \frac{1}{\gamma \omega_r} = \frac{1}{\omega_g}, \quad (8.17)$$

where  $\omega_g$  is the non-relativistic angular gyrofrequency and  $\omega_r = \omega_g/\gamma$  the relativistic angular gyrofrequency. We can also rewrite  $(1 - v/c)$  as

$$\left(1 - \frac{v}{c}\right) = \frac{[1 - (v/c)][1 + (v/c)]}{[1 + (v/c)]} = \frac{(1 - v^2/c^2)}{1 + (v/c)} \approx \frac{1}{2\gamma^2}, \quad (8.18)$$

since  $v \approx c$ . Therefore, the observed duration of the pulse is

$$\Delta t \approx \frac{1}{2\gamma^2 \omega_g}. \quad (8.19)$$

# Relativistic effects

- **Light aberration:** photons emitted at right angles with respect to the velocity vector (in  $K'$ ) are observed in  $K$  to make an angle given by  $\sin \theta = 1/\Gamma$ . This means that in  $K$  half of the photons are concentrated in a cone of semi-aperture angle corresponding to  $\sin \theta = 1/\Gamma$ .
- **Arrival time of the photons:** as discussed above, the emission and arrival time intervals are different. As measured in the same frame  $K$  we have, as before,  $\Delta t_a = \Delta t_e(1 - \beta \cos \theta)$ . If  $\Delta t'_e$  is measured in  $K'$ ,  $\Delta t_e = \Gamma \Delta t'_e$  leading to

$$\Delta t_a = \Gamma(1 - \beta \cos \theta) \Delta t'_e \equiv \frac{\Delta t'_e}{\delta} \quad (2)$$

Here we have introduced the factor  $\delta$ , referred to as the beaming or Doppler factor. It exceeds unity for small viewing angles, and if so, observed time intervals are *contracted*.

- **Blueshift/Redshift of frequencies:** since frequencies are the inverse of times, we just have  $\nu = \delta \nu'$ .

Ghisellini astro-ph/9905181

# Relativistic effects

---

---

$\nu = \delta\nu'$	frequency
$t = t'/\delta$	time
$V = \delta V'$	volume
$\sin \theta = \sin \theta' / \delta$	sine
$\cos \theta = (\cos \theta' + \beta) / (1 + \beta \cos \theta')$	cosine
$I(\nu) = \delta^3 I'(\nu')$	specific intensity
$I = \delta^4 I'$	total intensity
$j(\nu) = \delta^2 j'(\nu')$	specific emissivity
$\kappa(\nu) = \kappa'(\nu') / \delta$	absorption coefficient
$T_B = \delta T'_B$	brightness temperature (size directly measured)
$T_B = \delta^3 T'_B$	brightness temperature (size from variability)

---

---

$$\delta = \gamma(1 - (V/c)\cos\theta)$$

Ghisellini astro-ph/9905181

# BeppoSAX (1995 - 2002 )

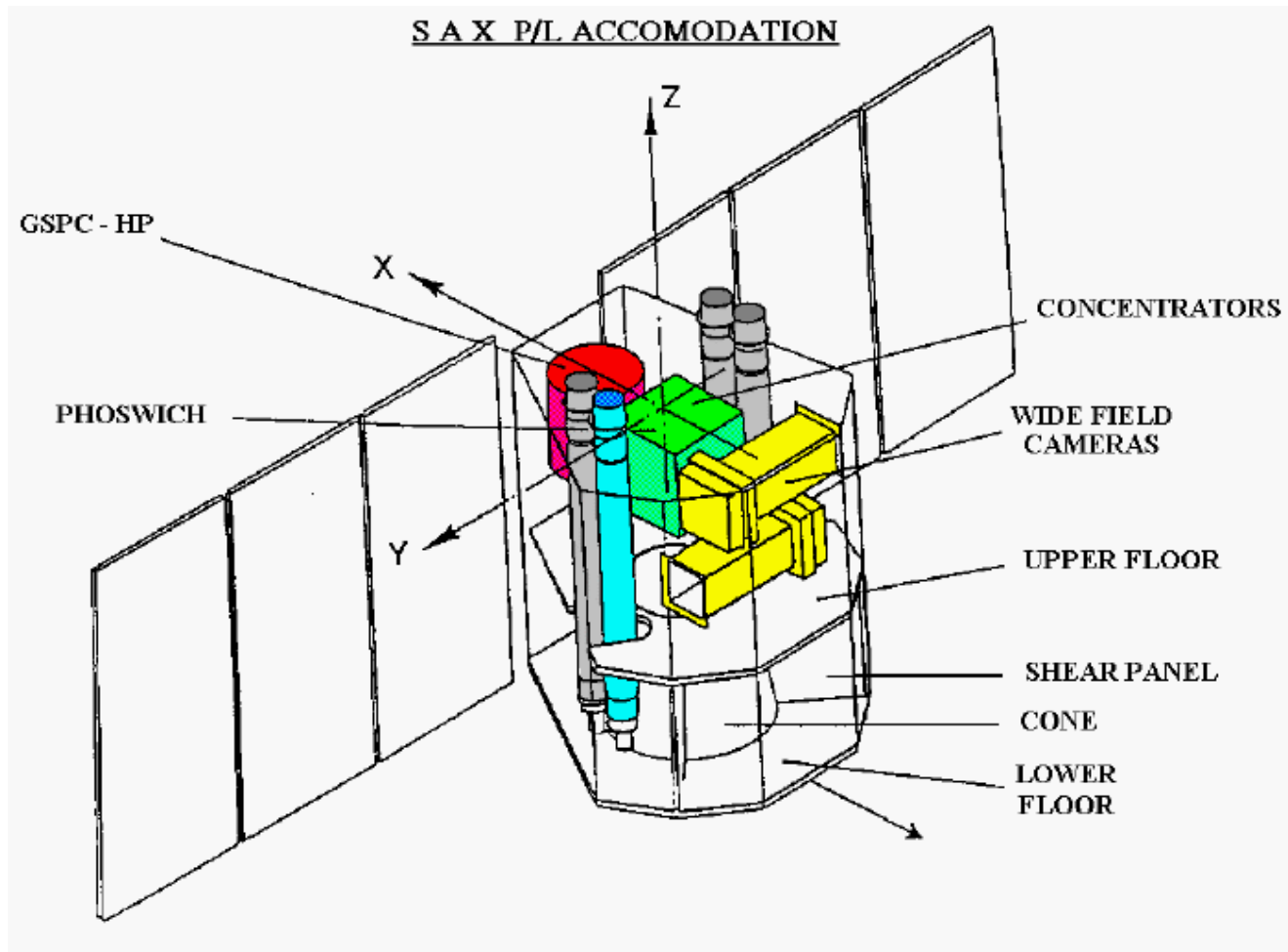

# Spatial Aperture Modulation

- **Alternative to temporal modulation**
- **Requires two-dimensional position-sensitive detectors**
- **The spatial modulation is achieved by a pattern of holes in an otherwise absorbing plate, providing a unique spatial code**

## Coded-aperture (or coded-mask) Telescopes

Principle: the mask pattern (in the form of the shadow produced by the parallel beam of an X-ray source) is recognized by the two-dimensional position-sensitive detector. Any shift in the pattern is related to a shift of the source position.



# Coded Mask Imaging

The Coded Mask Technique  
is the worst possible way of making a telescope

Except when you can't do anything better !

- Wide fields of view
- Energies too high for focussing, or too low for Compton/Tracking detector techniques
- Very good angular resolution
- The best energy resolution

# Coded Mask Imaging

The principle of the camera is straightforward: photons from a certain direction in the sky project the mask on the detector; this projection has the same coding as the mask pattern, but is shifted relative to the central position over a distance uniquely correspondent to the direction of the photons. The detector accumulates the sum of a number of shifted mask patterns. Each shift encodes the position and its strength encodes the intensity of the sky at that position.

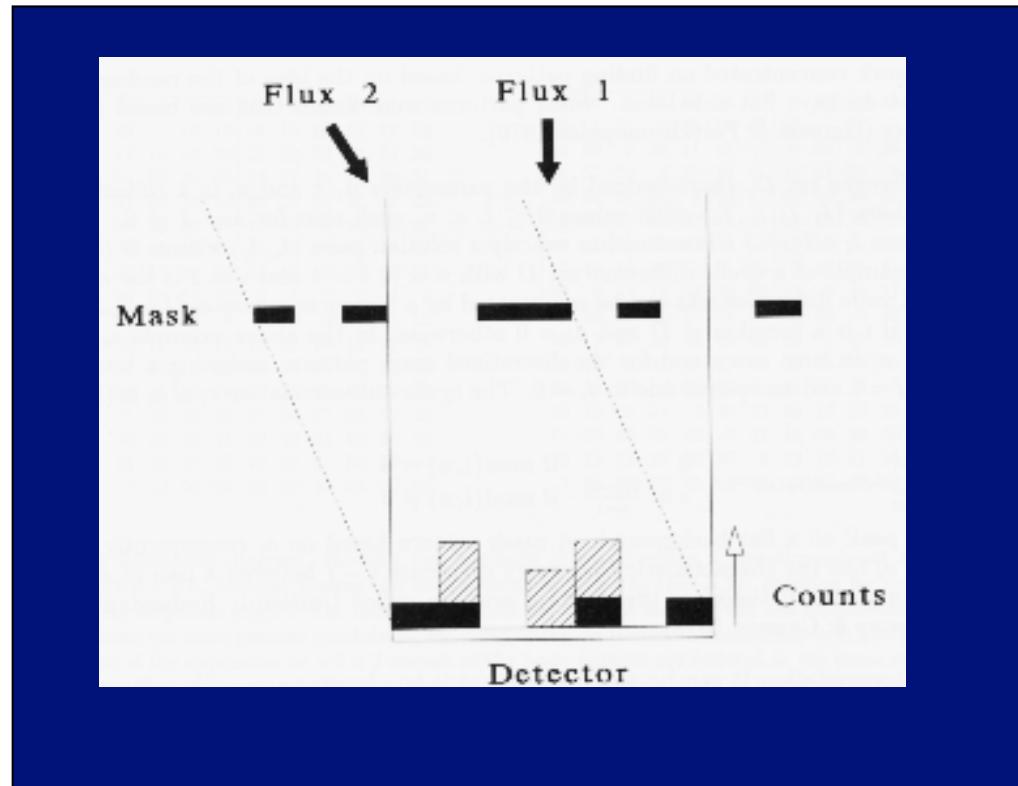

[http://asd.gsfc.nasa.gov/archive/cai/coded\\_intr.html](http://asd.gsfc.nasa.gov/archive/cai/coded_intr.html)

# Coded Mask Imaging

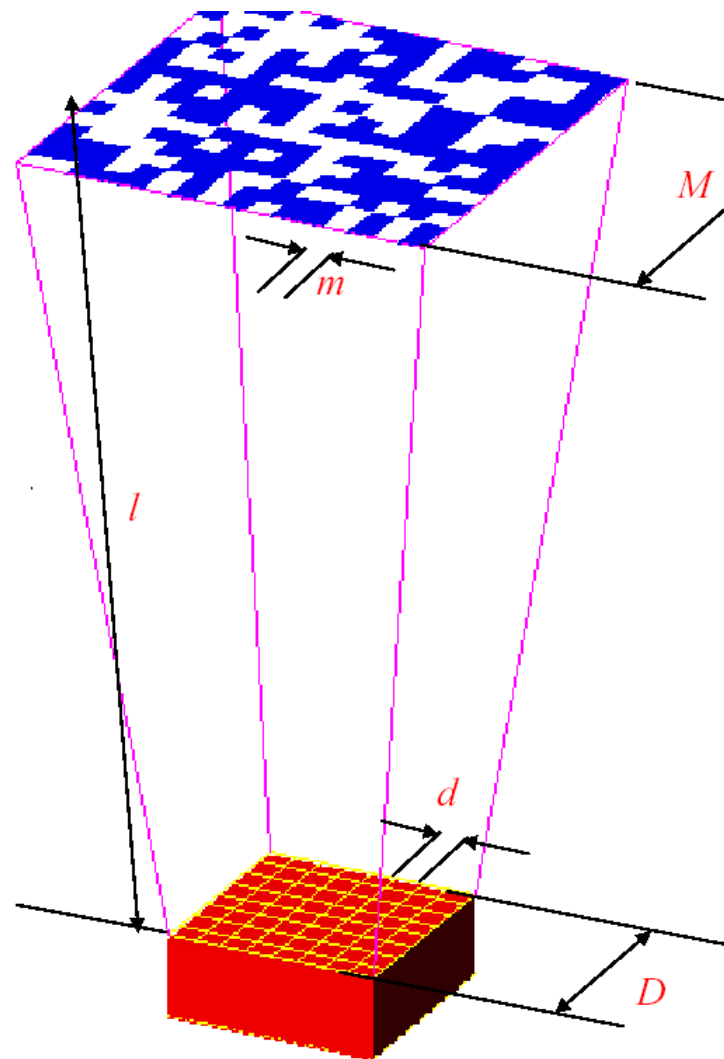

## Coded mask telescopes -key parameters

- $m$  Mask Pixel size
- $d$  Detector Pixel size
- $M$  Mask Size
- $D$  Detector Size (assume  $D < M$ )
- $l$  Mask-Detector Separation
- $t$  Mask open fraction

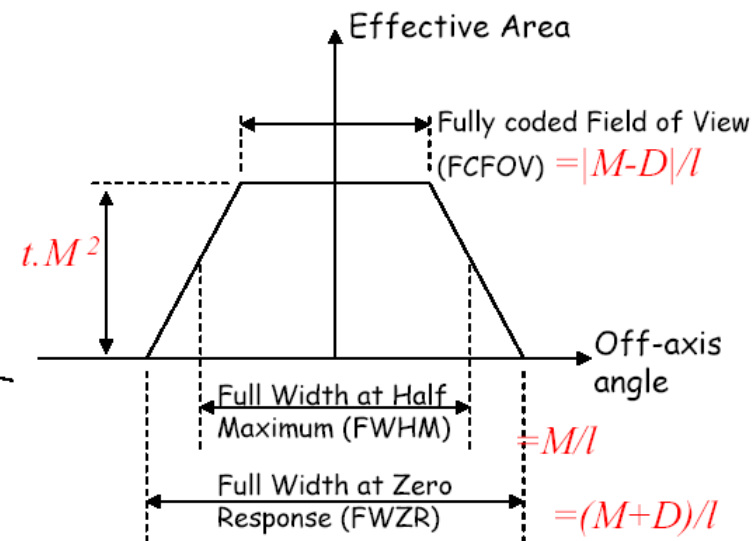

# Coded Mask Imaging

## Some aspects of *real* systems

- Non cyclic
  - Mask Closed element absorption
  - Mask Open element transparency
  - Mask Element Thickness
  - Obstructions in Mask Plane
  - Detector finite position resolution
  - Detector efficiency non-uniformities
  - Detector response dependent on off-axis angle
  - Detector background non-uniform
  - Gaps in the detector plane
  - Dead/inactive pixels in the detector plane
  - Shielding (collimation) imperfect
  - Obstructions between detector and mask
  - Leaks onto detector from far outside the fov
- 
- The diagram consists of three red curly braces on the right side of the slide, each grouping a set of bullet points. The top brace is labeled 'Mask' and groups the first five bullet points. The middle brace is labeled 'Detector' and groups the next six bullet points. The bottom brace is labeled 'Other' and groups the final three bullet points.

# Coded Mask Imaging

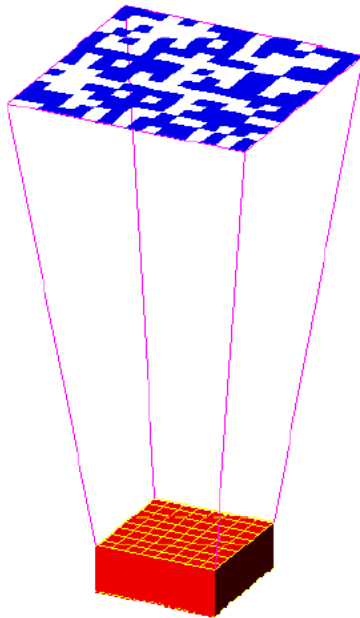

## How to recover an image

Basic method :

' Correlation with the Mask Pattern '

Recorded pattern is Convolution of source distribution and the mask pattern, plus some background B

$$D = S \otimes M + B$$

Suppose we form an image as<sup>†</sup>

$$\begin{aligned} I &= M \otimes D = M \otimes S \otimes M + M \otimes B \\ &= M \otimes M \otimes S + M \otimes B \\ &= ACF(M) \otimes S + M \otimes B \end{aligned}$$

where ACF indicated the Autocorrelation function.

If ACF(M) were a Delta function and if  $M \otimes B$  were zero we would have recovered S.

<sup>†</sup> coordinate reversals are ignored here

# Coded Mask Imaging

---

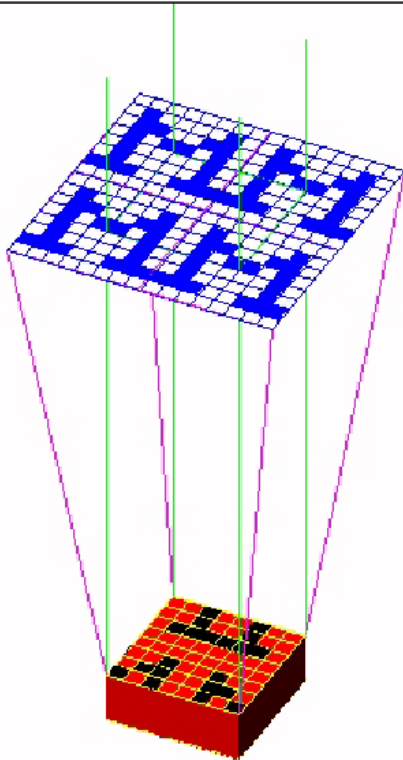

'Optimum coded' designs  
or 'URAs'  
(Uniformly Redundant Arrays)

Certain patterns have the properties:

i) Their DISCRETE, CYCLIC autocorrelation function is indeed a Delta function, PLUS A FLAT LEVEL.

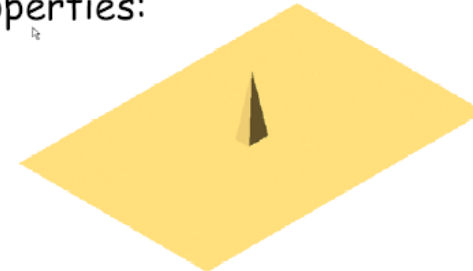

ii) For uniform background,  $M \otimes B$  is not zero, but it is at least FLAT.

If you can:

- Arrange that coding is cyclic
- Use Binned (discrete) arrays
- Be prepared to subtract a DC level

Then this is just what is needed

# Coded Mask Imaging

## 'Optimum coded' designs or 'URAs'

URAs are closely related to 'Cyclic Difference Sets'. Different families of cyclic difference sets yield Mask patterns which look quite different but which all have the desired properties - all have an ACF of the same form.

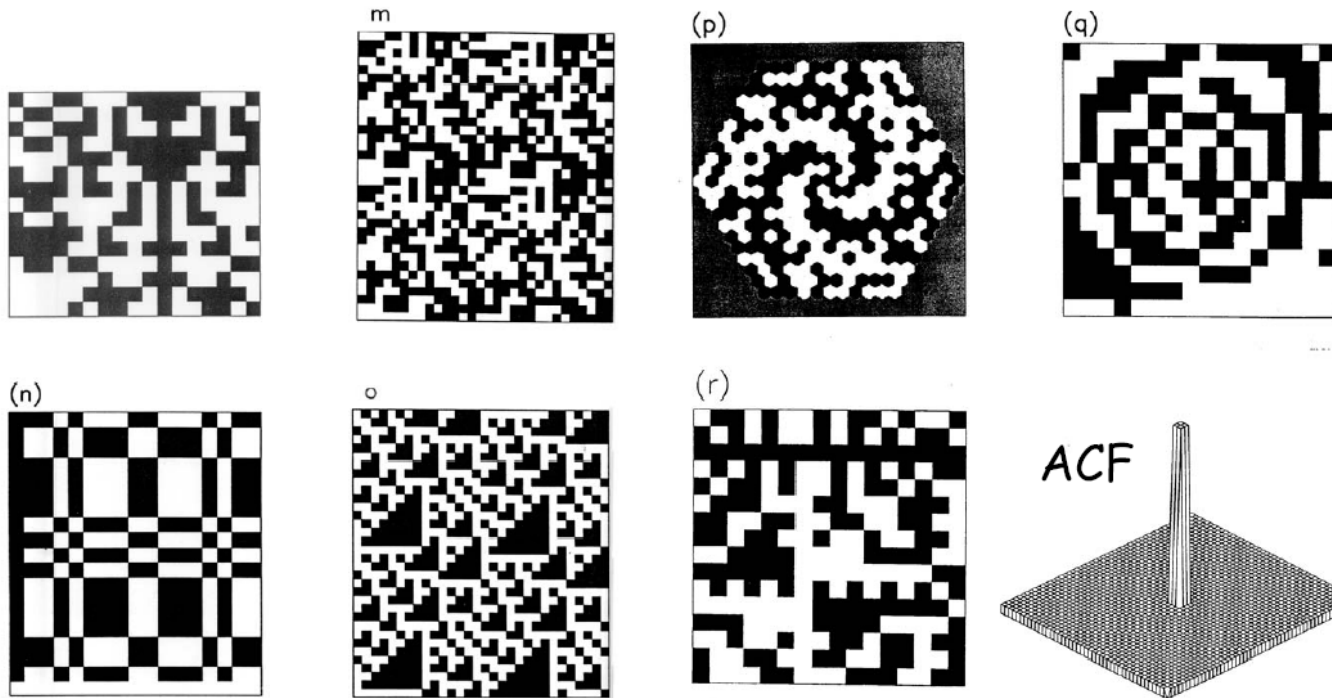

# The GRB phenomenon

- simultaneous detection of GRBs by GRBM and WFC  
→ very accurate localization (few arcmin)

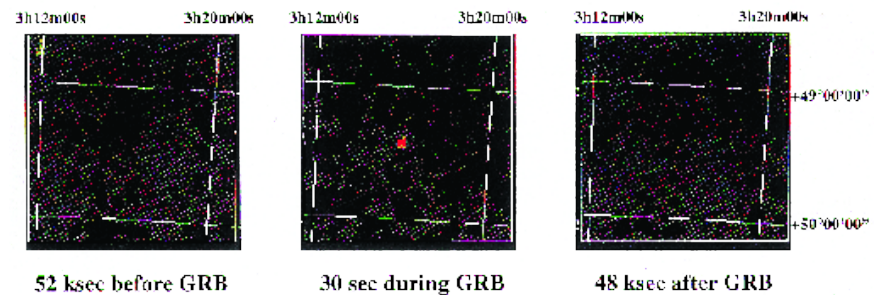
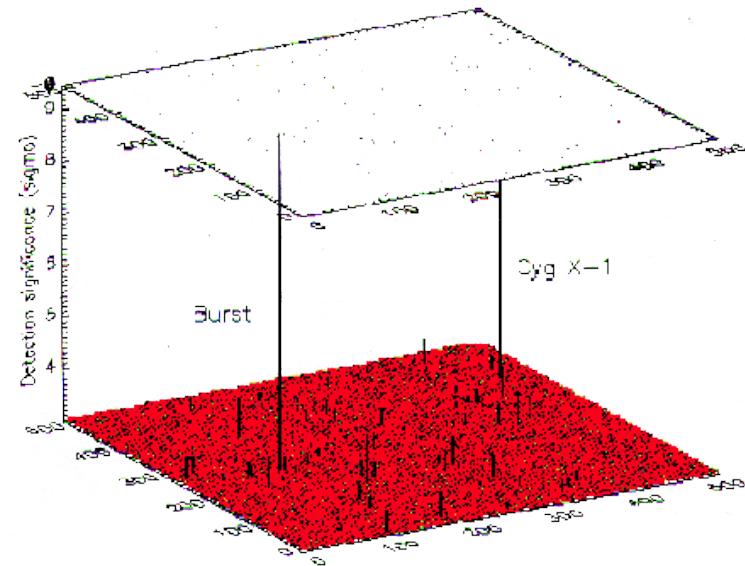
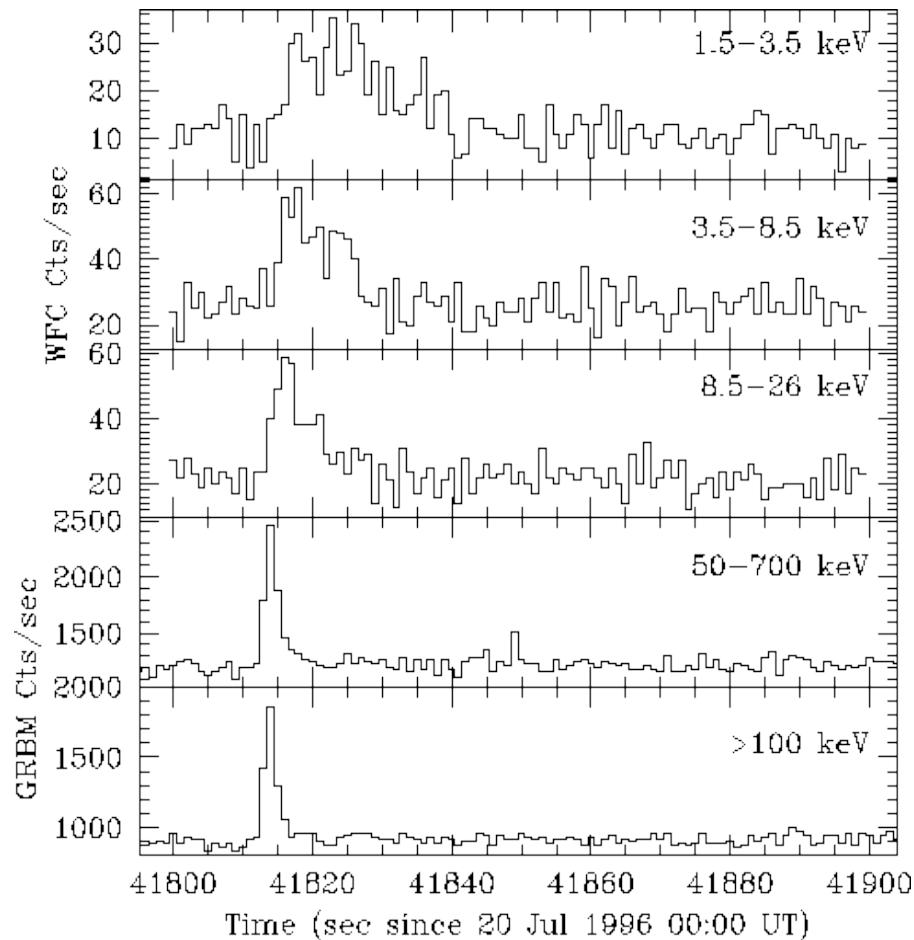

**GRB960720, Piro et al., A&A, 1998**



# The GRB phenomenon

- in 1997, thanks to BeppoSAX observations, discovery of fading X-ray, optical, radio emission following the GRB
- photons received during the classical GRB phenomenon are then called “**prompt emission**” and the subsequent fading emission is called “**afterglow emission**”

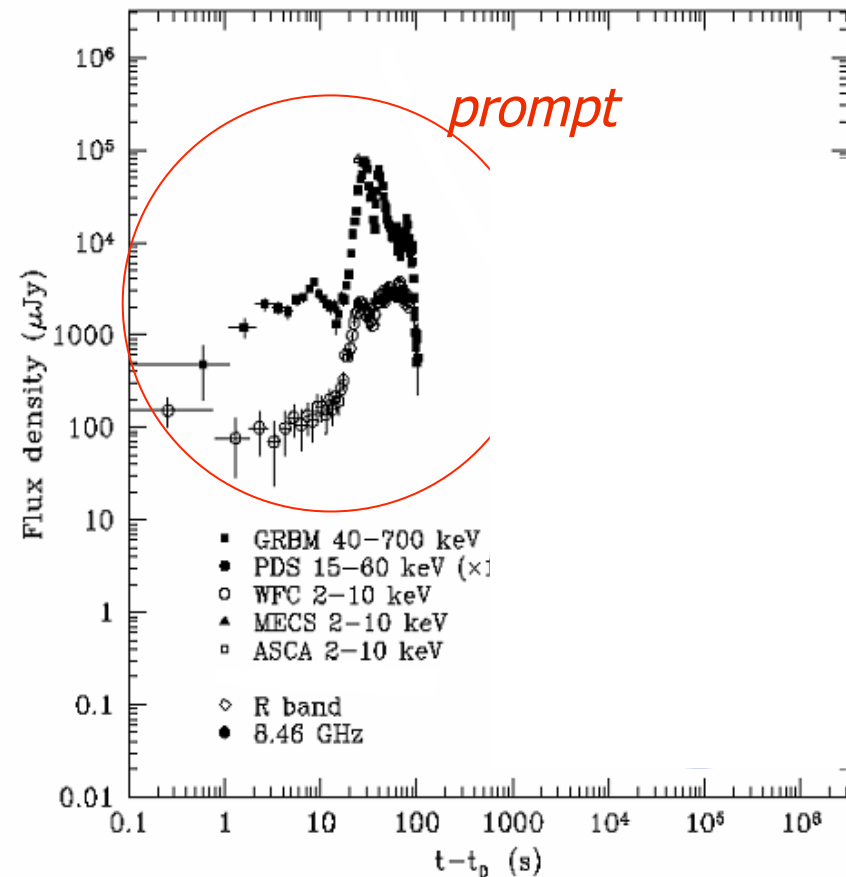

Adapted from Maiorano et al.,  
A&A, 2005

- in 1997, thanks to BeppoSAX observations, discovery of fading X-ray, optical, radio emission following the GRB
- photons received during the classical GRB phenomenon are then called “**prompt emission**” and the subsequent fading emission is called “**afterglow emission**”

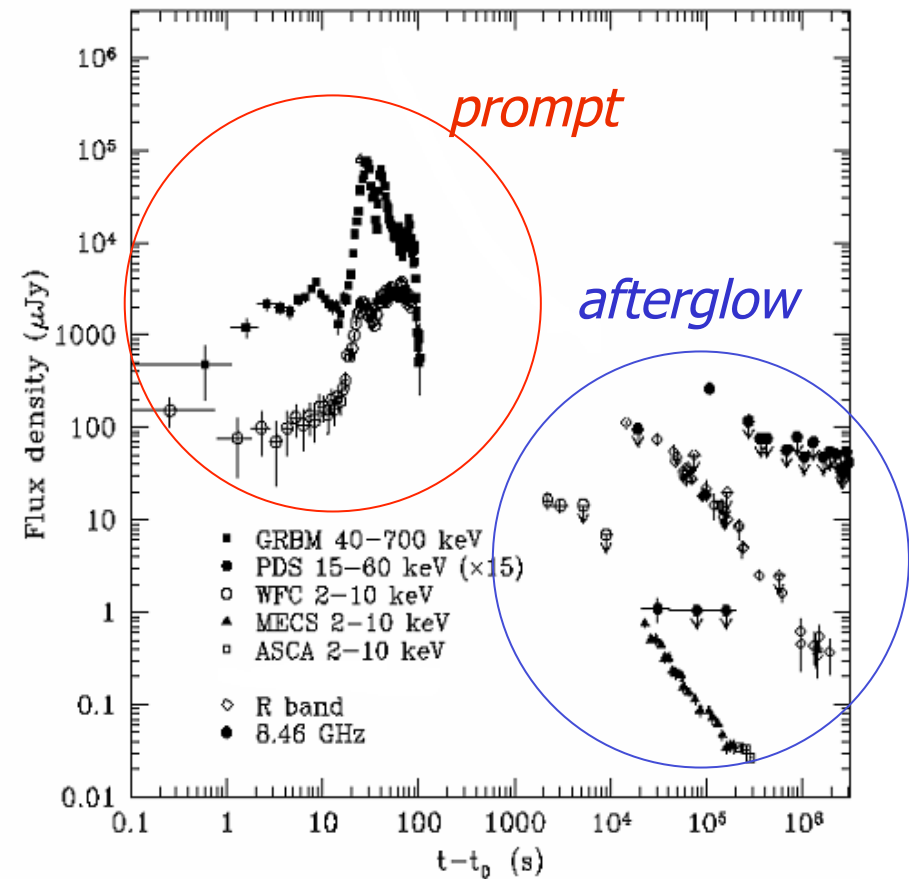

Adapted from Maiorano et al.,  
A&A, 2005

# GRB970228 – first good localization

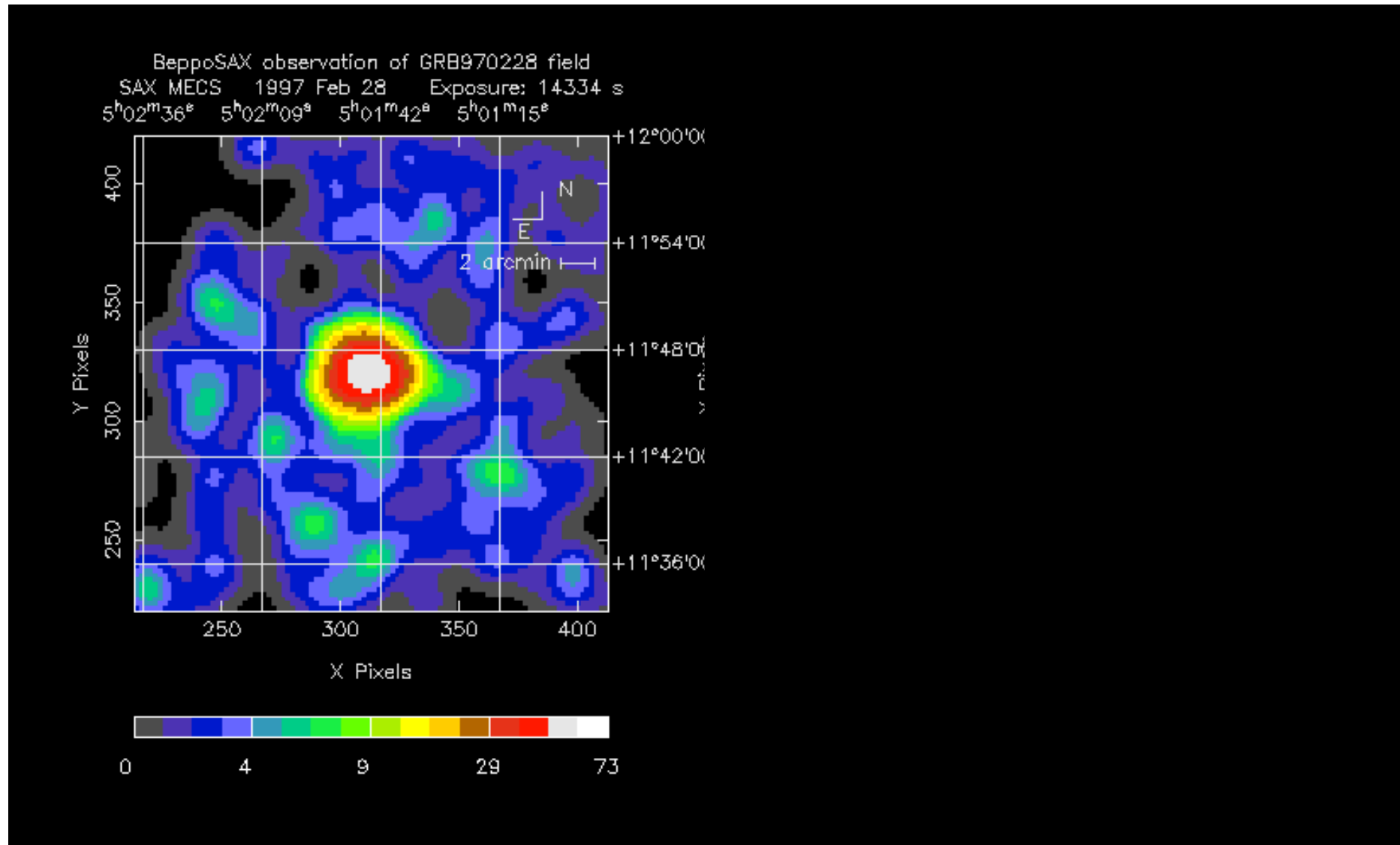

# GRB970228 – first good localization

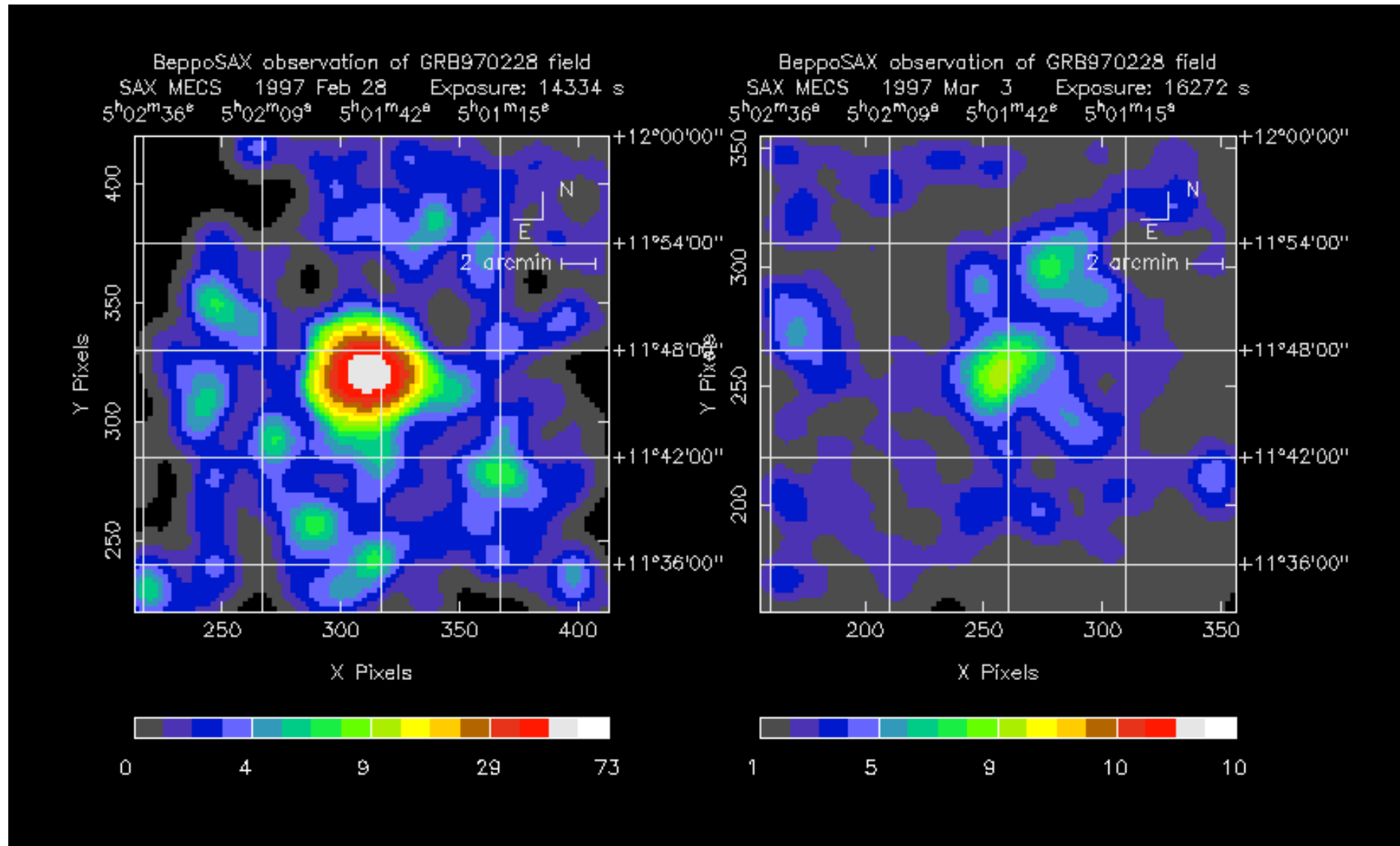

# BeppoSAX

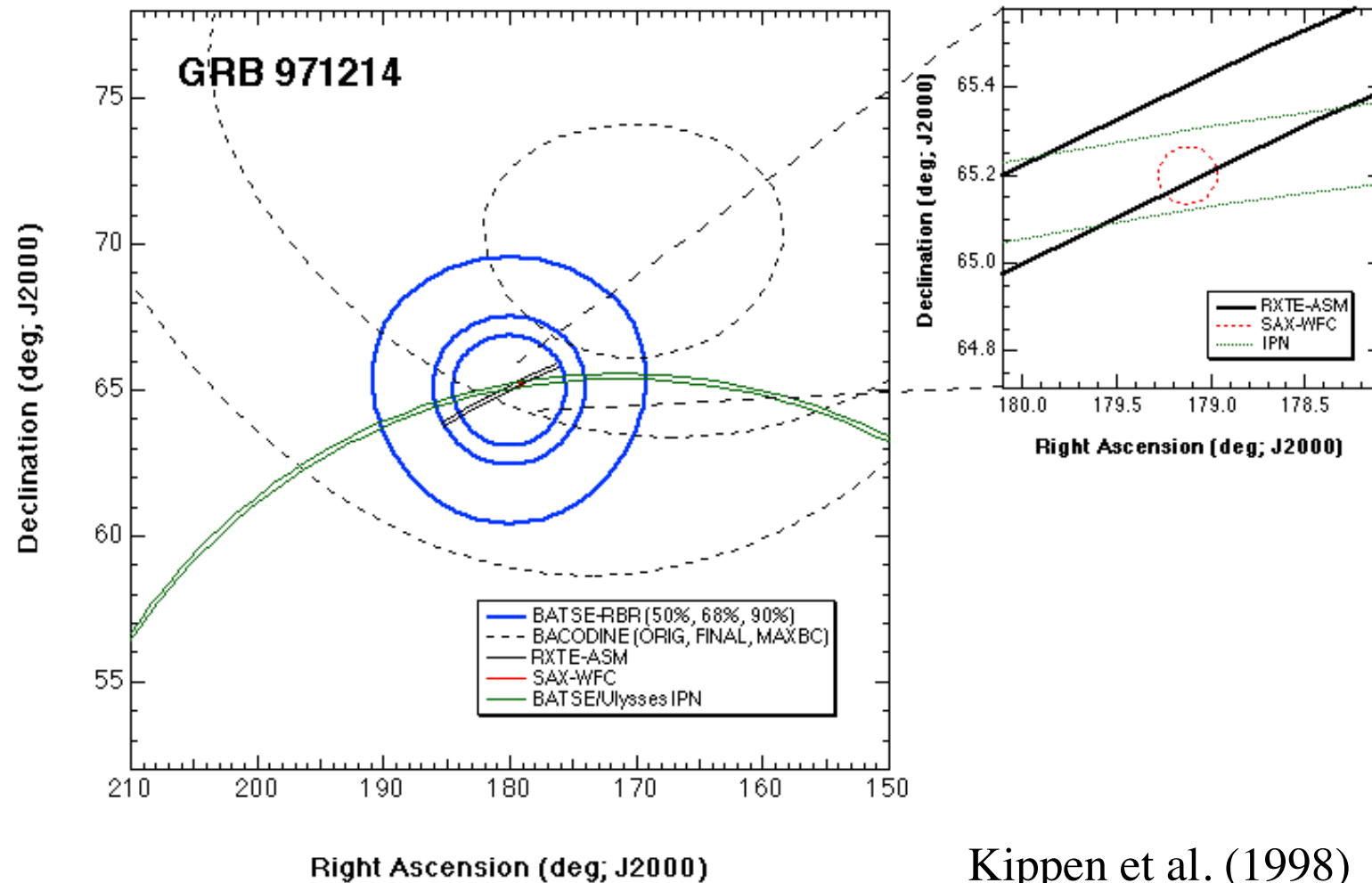

Kippen et al. (1998)

# Afterglow Observations

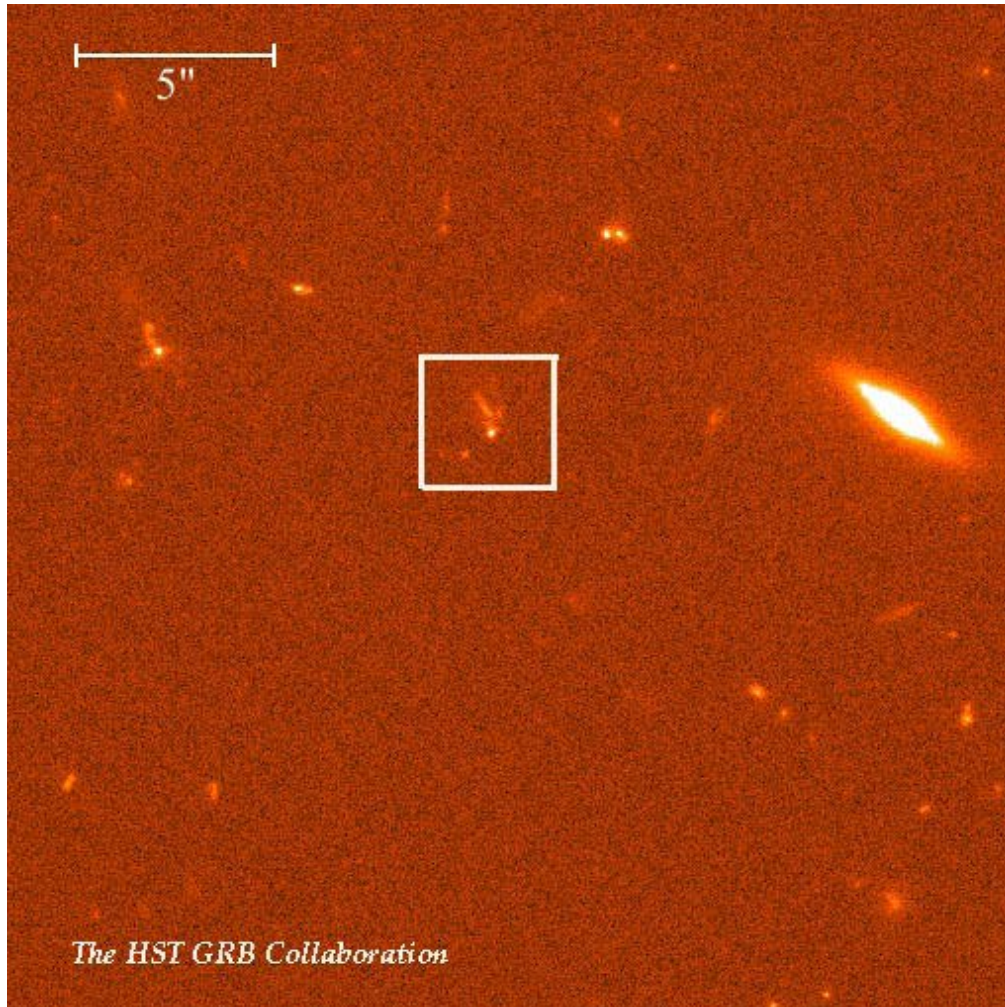

Identificazione delle  
Host Galaxies

Fruchter et al (1999)



# The Fireball model

- Relativistic motion of the emitting region
- Shock mechanism converts the kinetic energy of the shells into radiation.
- Baryon Loading problem

## External Shock

- Synchrotron & SSC
- High conversion efficiency
- Not easy to justify the rapid variability

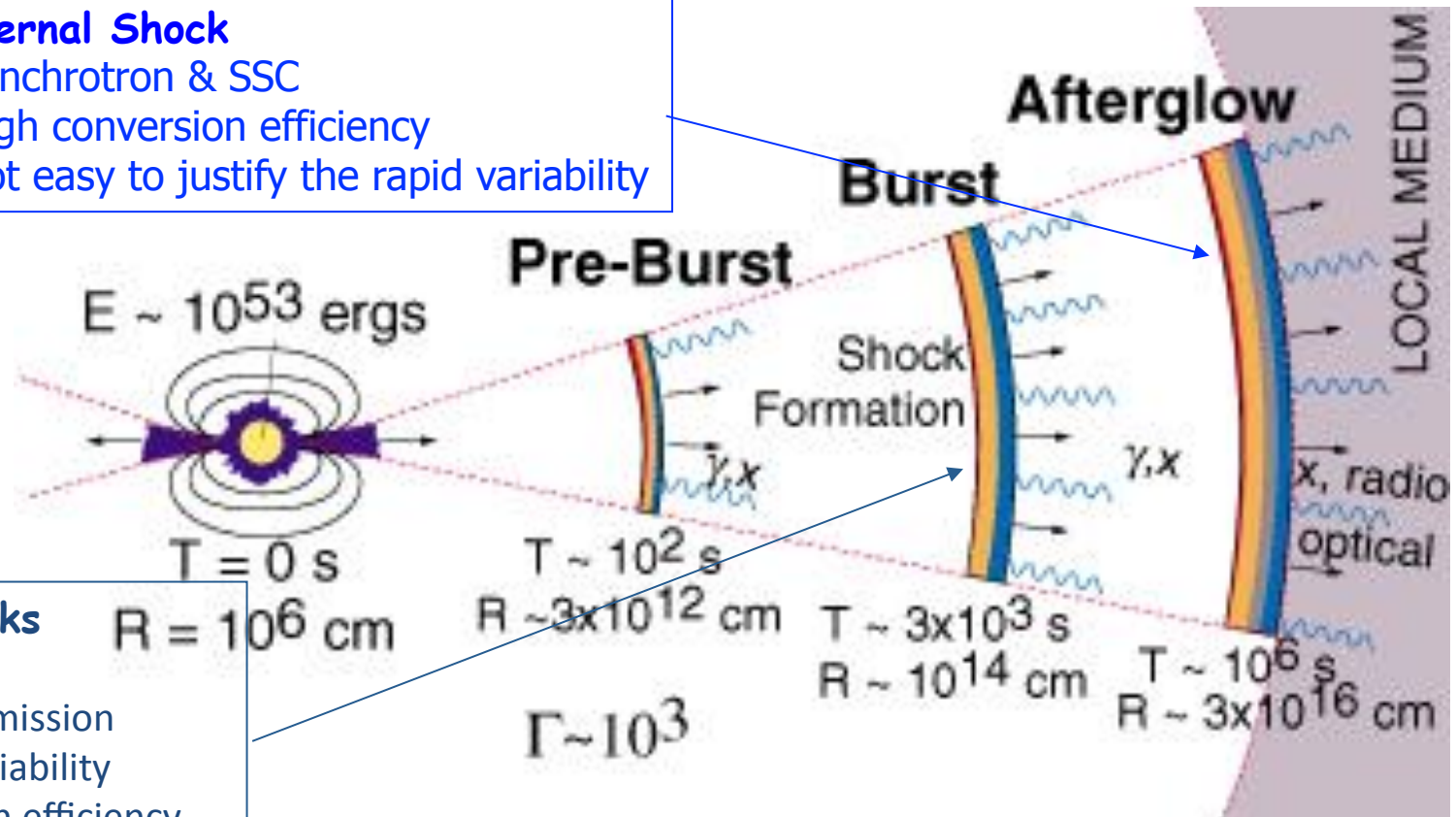

## Internal Shocks

- Source activity
- Synchrotron Emission
- Rapid time Variability
- Low conversion efficiency



# Afterglow Observations

Harrison et al (1999)

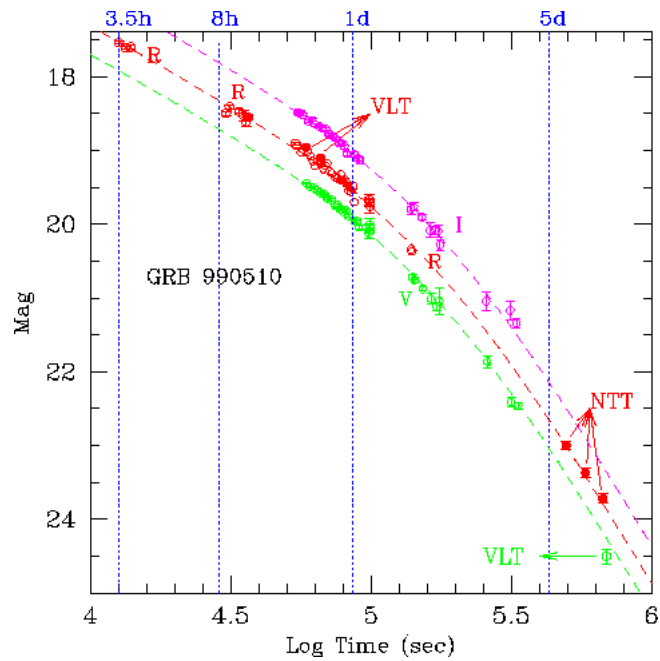

Achromatic Break

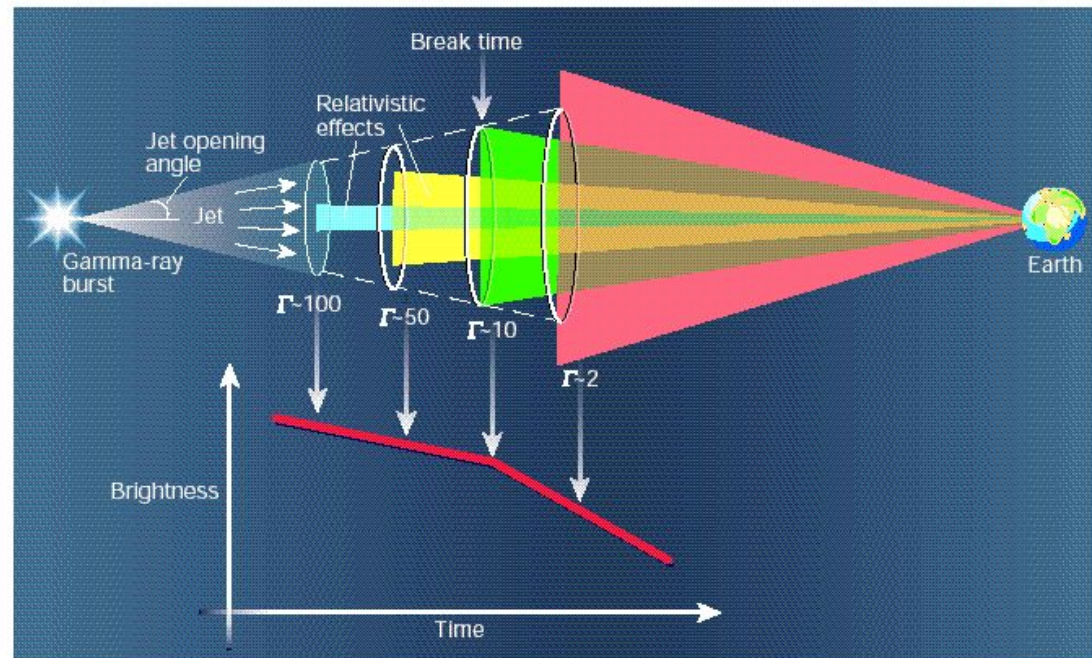

Woosley (2001)

# Jet and Energy Requirements

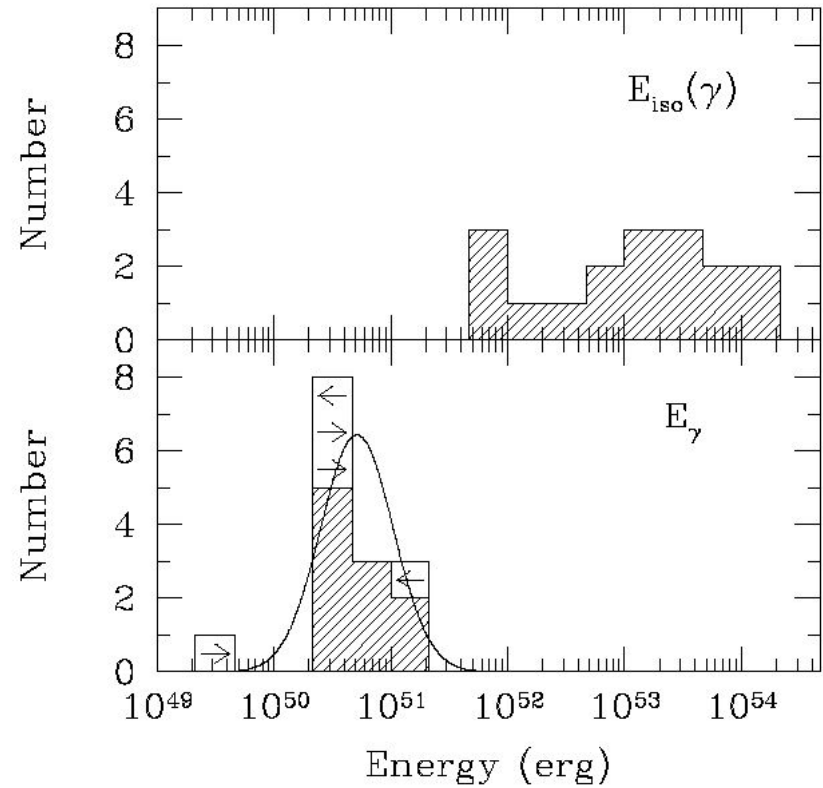
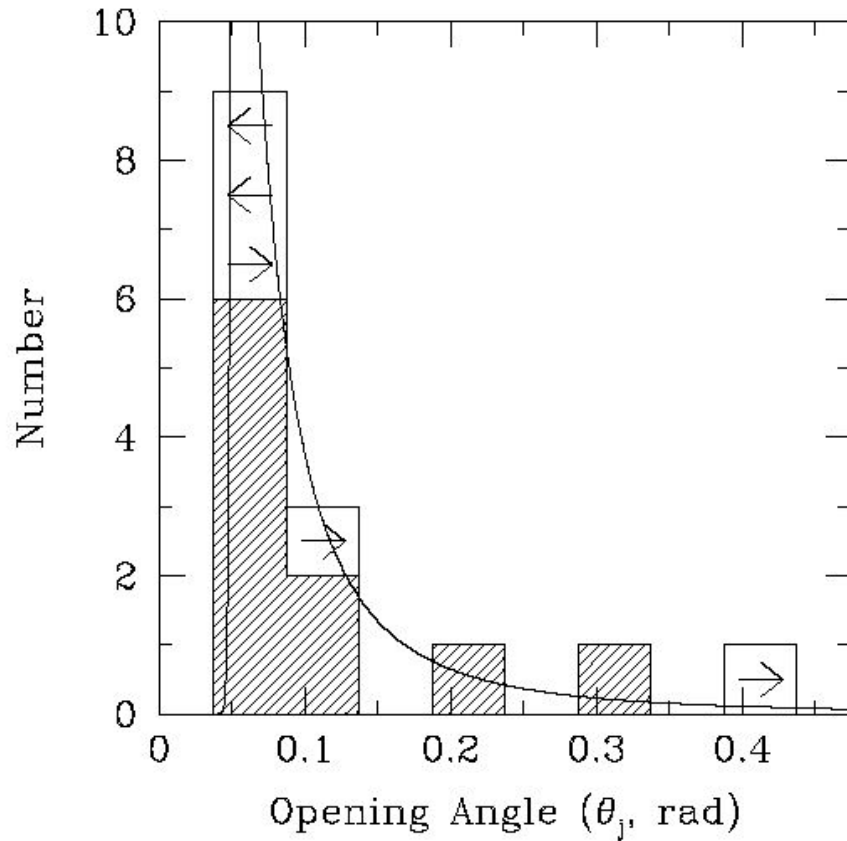

Frail et al. (2001)

# Relativistic beaming

## 3. Transformation of Velocities

If a point has velocity  $\mathbf{u}'$  in frame  $K'$ , what is its velocity  $\mathbf{u}$  in frame  $K$  (Fig. 4.2)? Writing Lorentz transformations for differentials [cf. Eqs. (4.2)]

$$\begin{aligned} dx &= \gamma(dx' + v dt'), & dy &= dy' \\ dz &= dz', & dt &= \gamma\left(dt' + \frac{v}{c^2} dx'\right). \end{aligned}$$

We then have the relations

$$u_x = \frac{dx}{dt} = \frac{\gamma(dx' + v dt')}{\gamma(dt' + v dx'/c^2)} = \frac{u'_x + v}{1 + vu'_x/c^2}, \quad (4.5a)$$

$$u_y = \frac{u'_y}{\gamma(1 + vu'_x/c^2)}, \quad (4.5b)$$

$$u_z = \frac{u'_z}{\gamma(1 + vu'_x/c^2)}. \quad (4.5c)$$

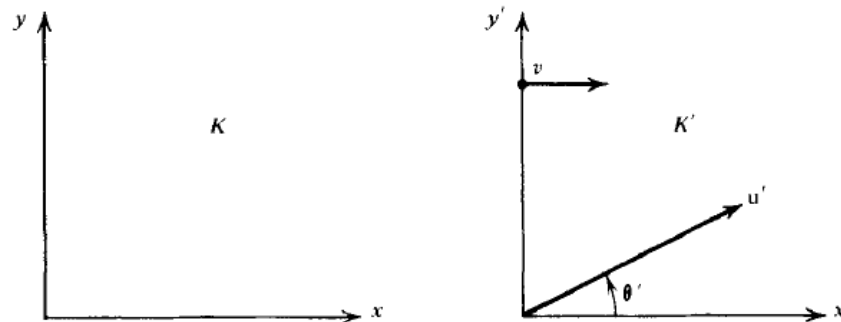

Figure 4.2 Lorentz transformation of velocities.

# Relativistic beaming

The generalization of these equations to an arbitrary velocity  $\mathbf{v}$ , not necessarily along the  $x$  axis, can be stated in terms of the components of  $\mathbf{u}$  perpendicular to and parallel to  $\mathbf{v}$ :

$$u_{\parallel} = \frac{u'_{\parallel} + v}{(1 + vu'_{\parallel}/c^2)}, \quad u_{\perp} = \frac{u'_{\perp}}{\gamma(1 + vu'_{\parallel}/c^2)}. \quad (4.6)$$

The directions of the velocities in the two frames are related by the *aberration formula*,

$$\tan \theta = \frac{u_{\perp}}{u_{\parallel}} = \frac{u' \sin \theta'}{\gamma(u' \cos \theta' + v)}, \quad (4.7)$$

where  $u' \equiv |\mathbf{u}'|$ . The azimuthal angle  $\phi$  remains unchanged. An interesting application is for the case  $u' = c$ , where

$$\tan \theta = \frac{\sin \theta'}{\gamma(\cos \theta' + v/c)}, \quad (4.8a)$$

$$\cos \theta = \frac{\cos \theta' + v/c}{1 + (v/c) \cos \theta'}. \quad (4.8b)$$

# Relativistic beaming

Equations (4.8) represent the *aberration of light*.

It is instructive to set  $\theta' = \pi/2$ , that is, a photon is emitted at right angles to  $v$  in  $K'$ . Then we have

$$\tan \theta = \frac{c}{\gamma v}, \quad (4.9a)$$

$$\sin \theta = \frac{1}{\gamma}. \quad (4.9b)$$

Now for highly relativistic speeds,  $\gamma \gg 1$ ,  $\theta$  becomes small:

$$\theta \sim \frac{1}{\gamma}. \quad (4.10)$$

If photons are emitted isotropically in  $K'$ , then half will have  $\theta' < \pi/2$  and half  $\theta' > \pi/2$  (see Fig. 4.3). Equation (4.10) shows that in frame  $K$  photons are concentrated in the forward direction, with half of them lying within a cone of half-angle  $1/\gamma$ . Very few photons will be emitted having  $\theta \gg 1/\gamma$ . This is called the *beaming effect*.

# Jet breaks

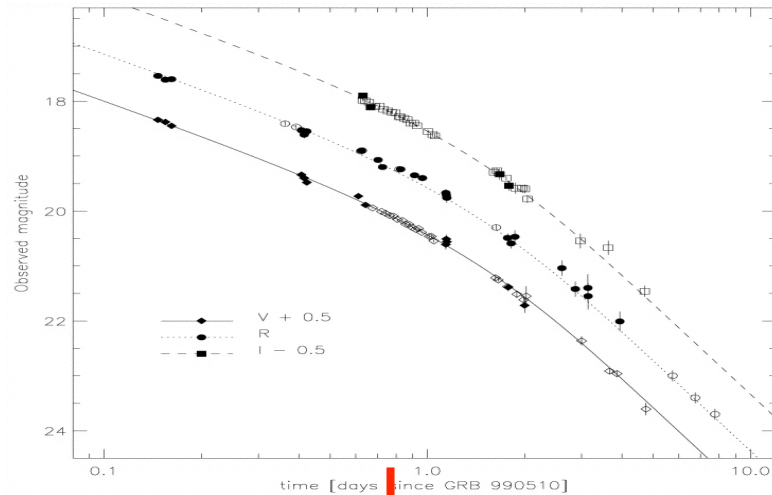

➤ breaks in the afterglow decay light curves -> collimation ?

$$\theta = 0.09 \left( \frac{t_{jet,d}}{1+z} \right)^{3/8} \left( \frac{n\eta_\gamma}{E_{\gamma,iso,52}} \right)^{1/8}$$

$$E_\gamma = (1 - \cos \theta) E_{\gamma,iso}$$

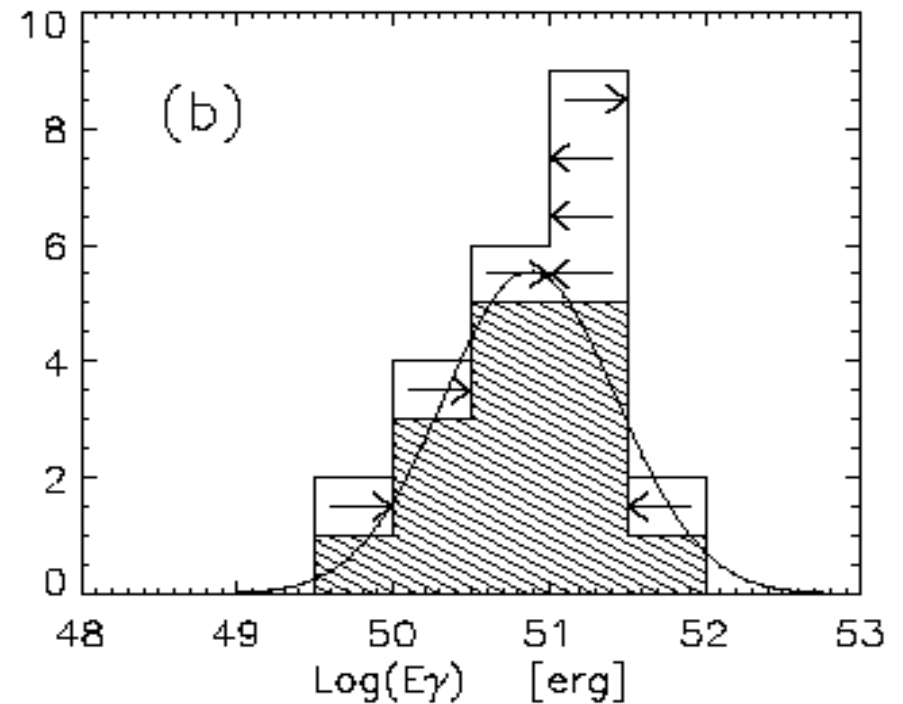

# Progenitors

- Two populations of GRB?
- Main models
- Possible solution?

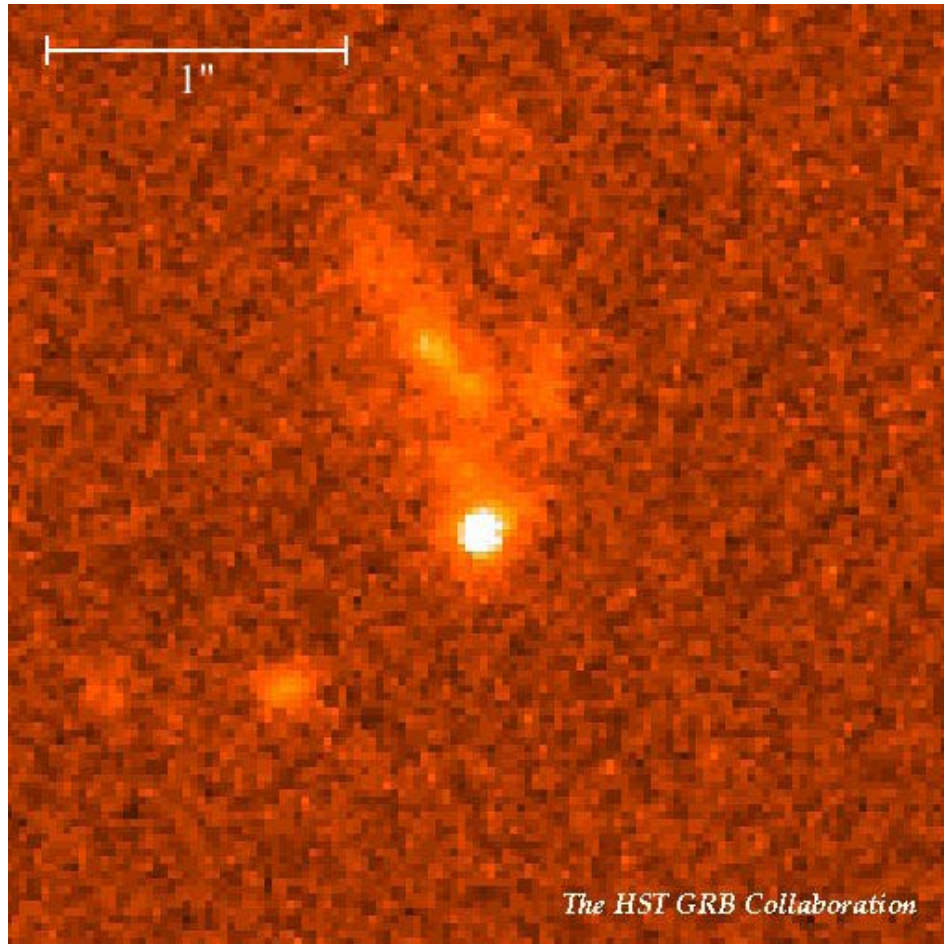



# Progenitors

Long GRB

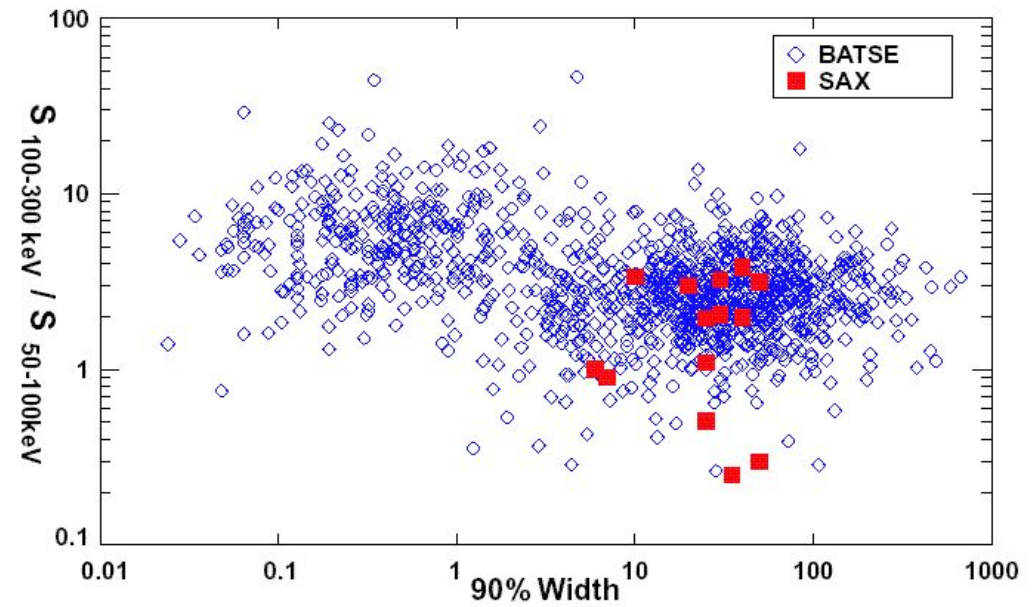
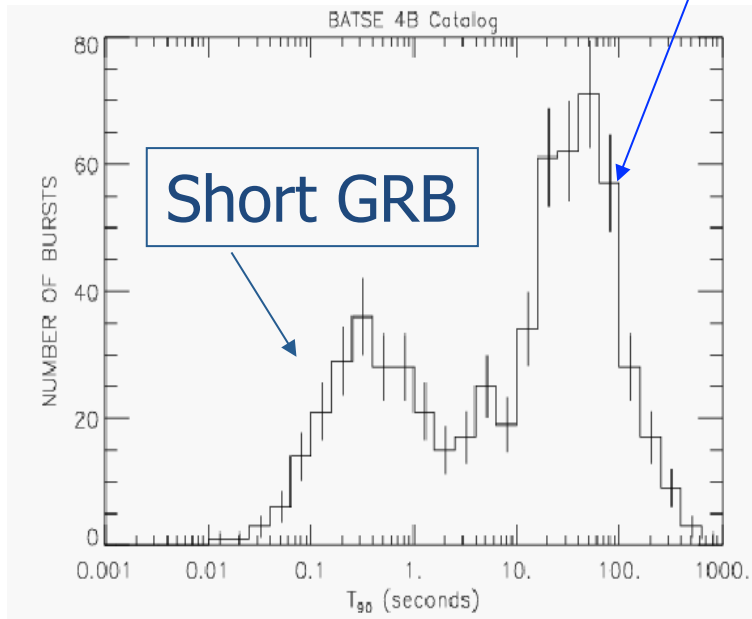

# Towards a solution?

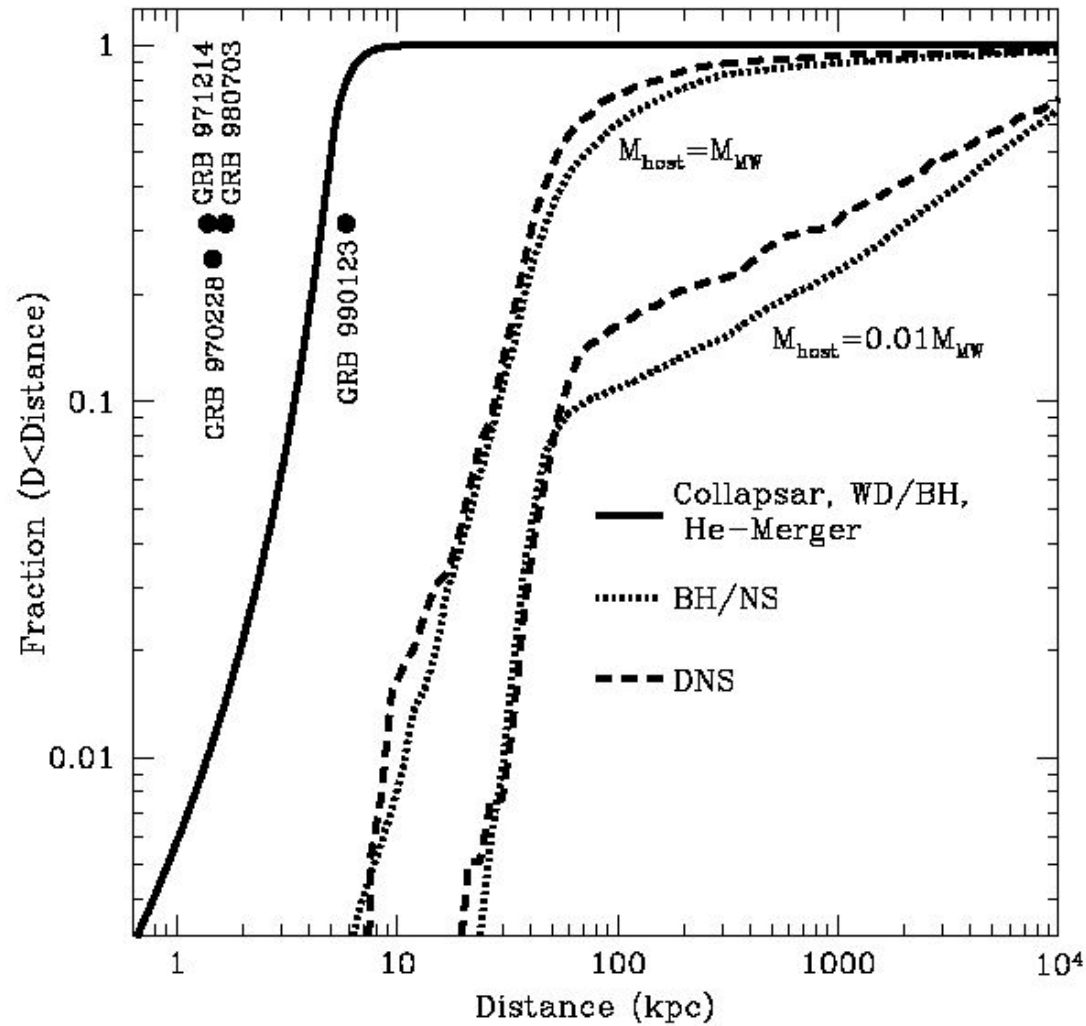

Fryer et al. (1999)

# SN- GRB connection

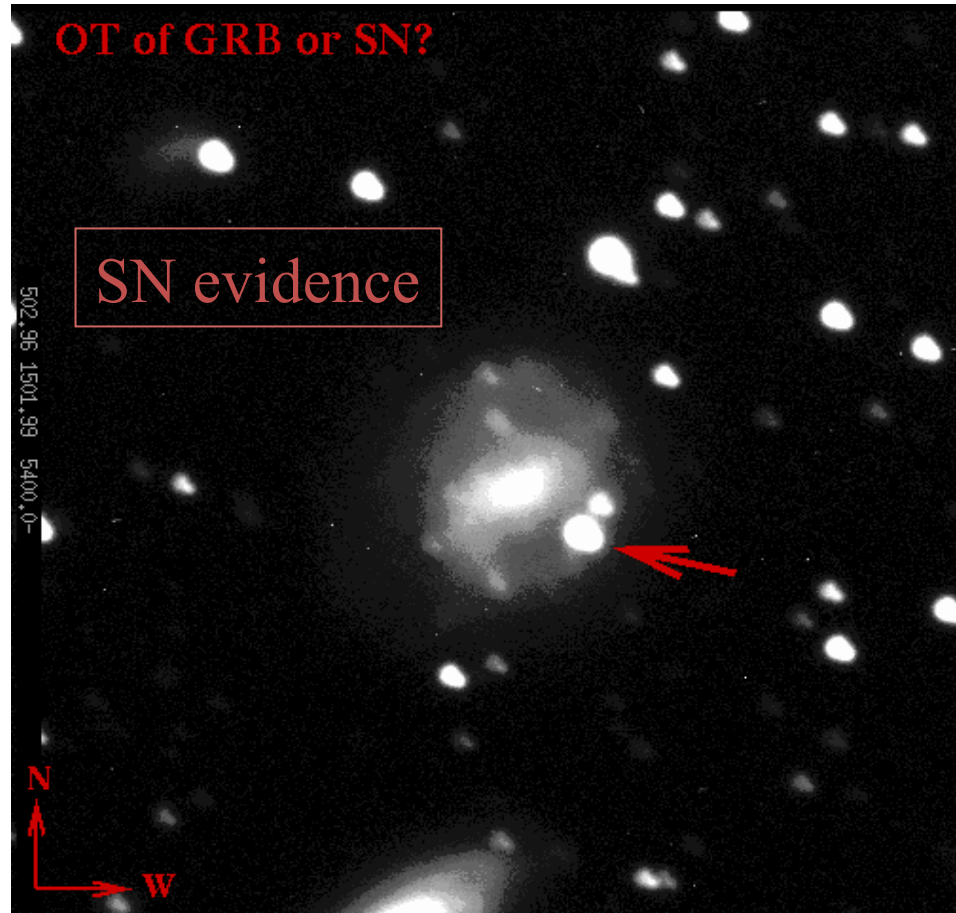

SN 1998bw - GRB 980425  
chance coincidence  $O(10^{-4})$   
(Galama et al. 98) <sup>58</sup>

# GRB & SN first predictions

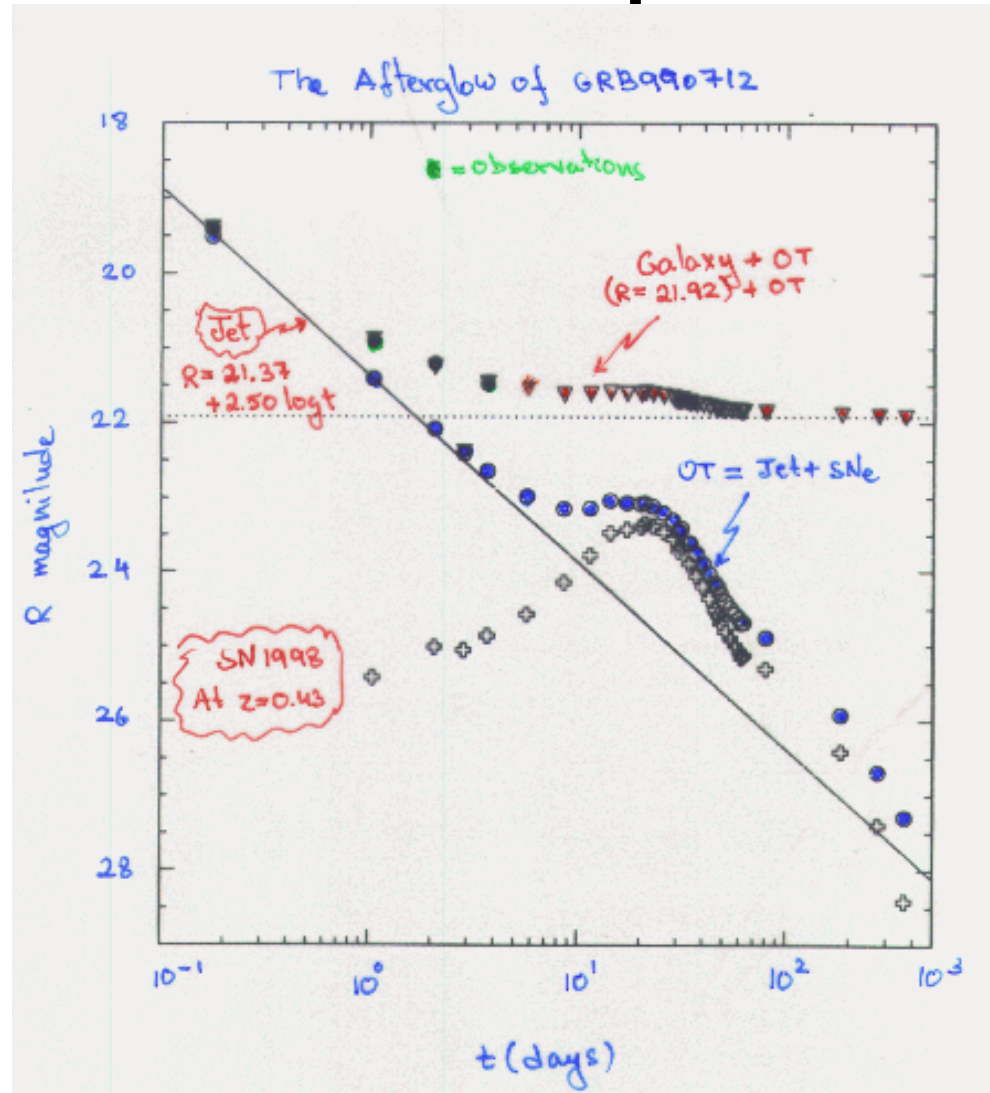

# GRB & SN

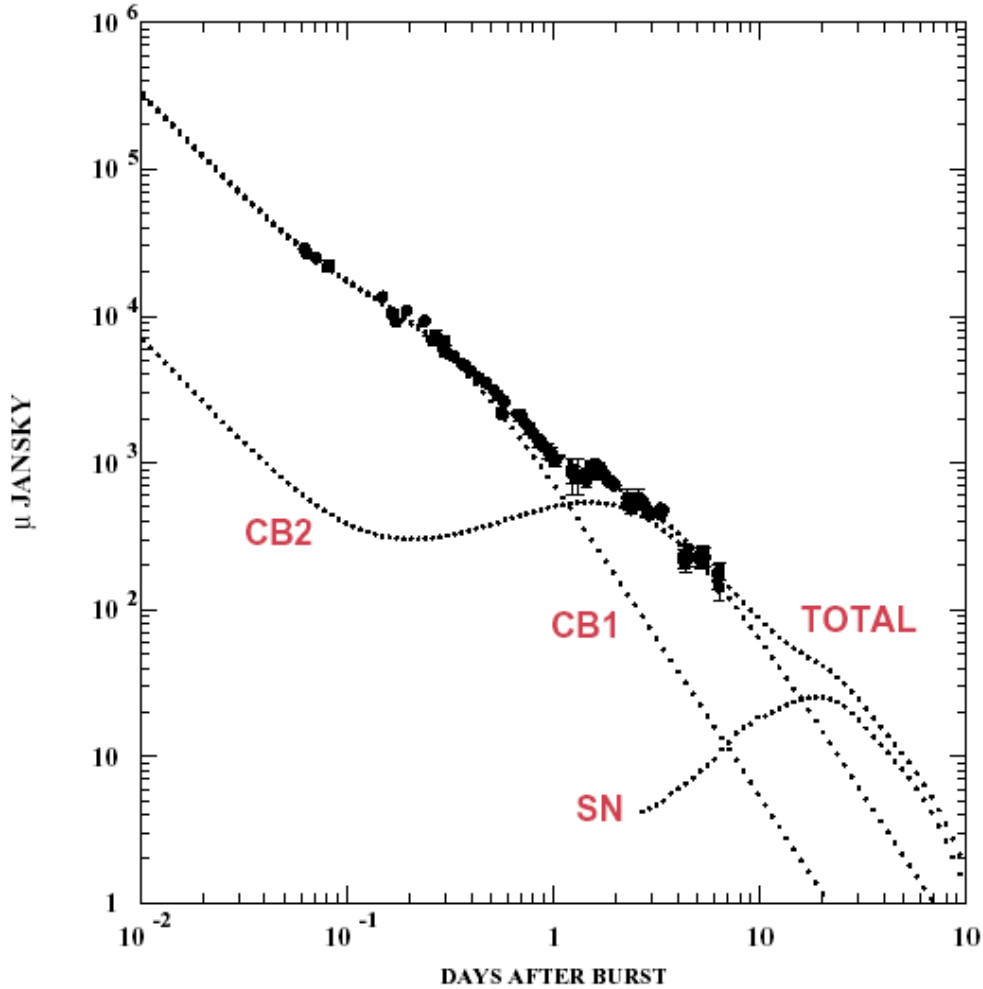

Dado, Dar & De Rujula (2003)

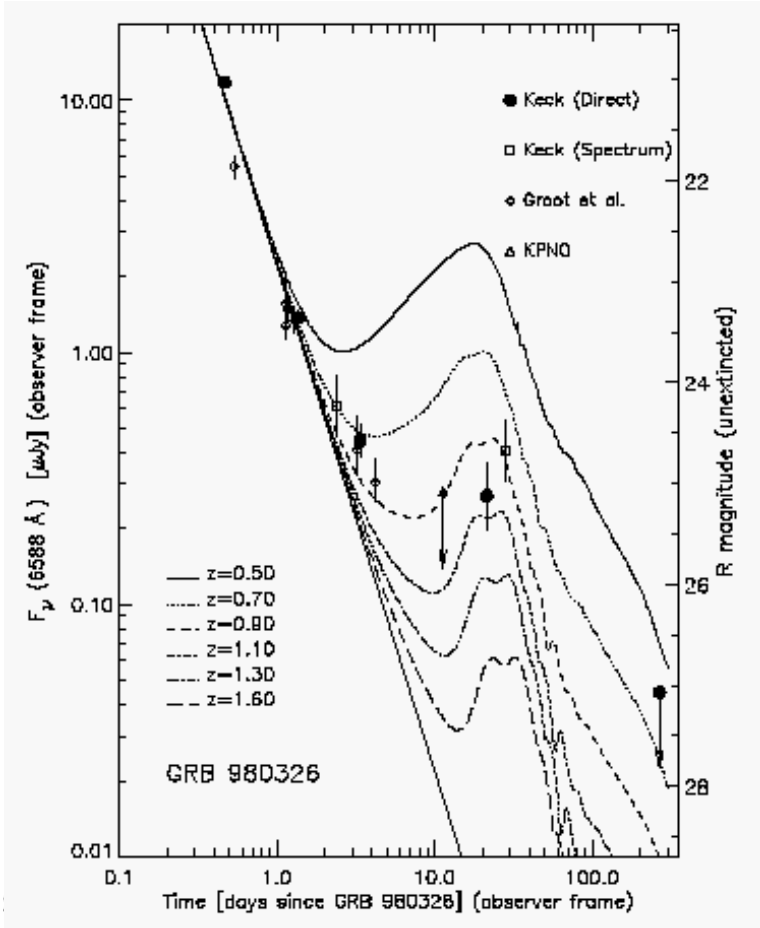

GRB 980326

(Bloom et al. 99)

# Hete2

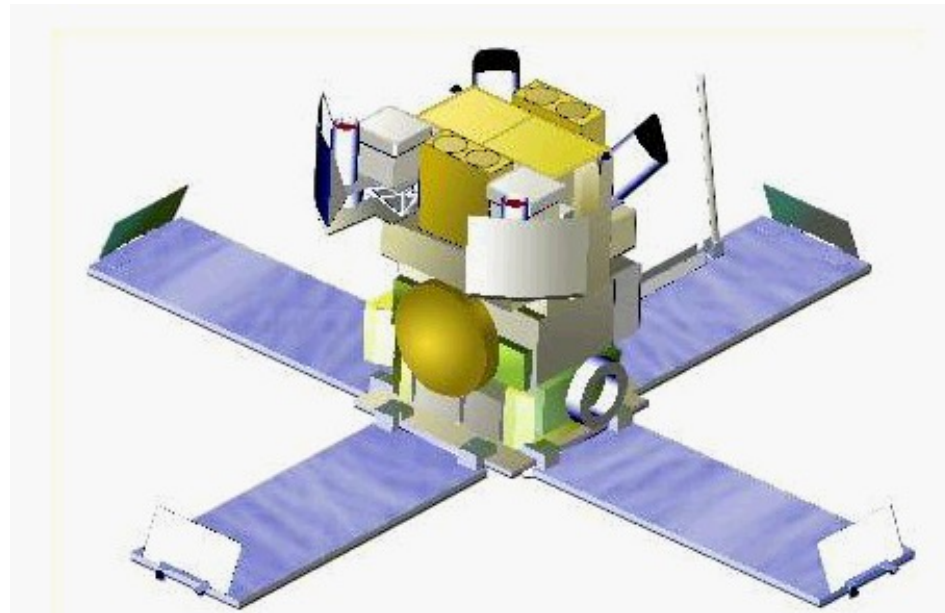

2000 - 2008

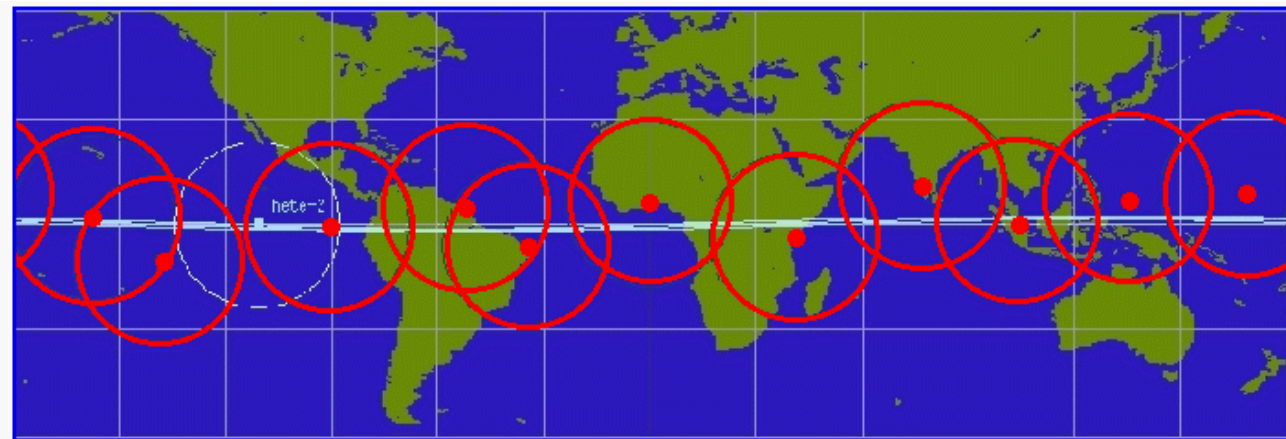



# HETE-2 Science Instrument Package

French Gamma-ray Telescope  
**(FREGATE)**: 5-500 keV;  $\sim\pi$  FOV

Wide-Field X-ray Monitor (**WXM**):  
2-25 keV;  $\sim 5'$ - $10'$  localizations

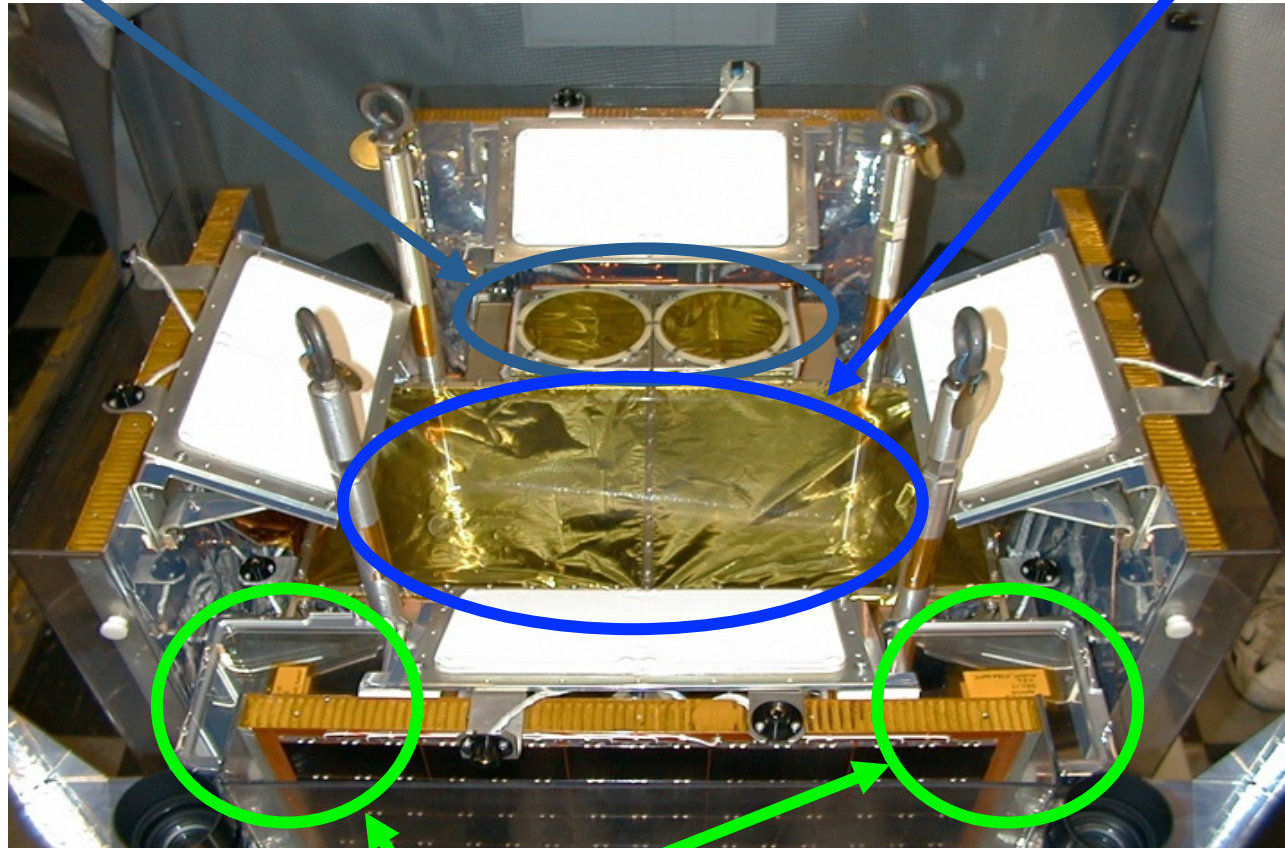

Soft X-ray Cameras (**SXC**):  
1-10 keV;  $\sim 30''$  localizations



# GRB050709

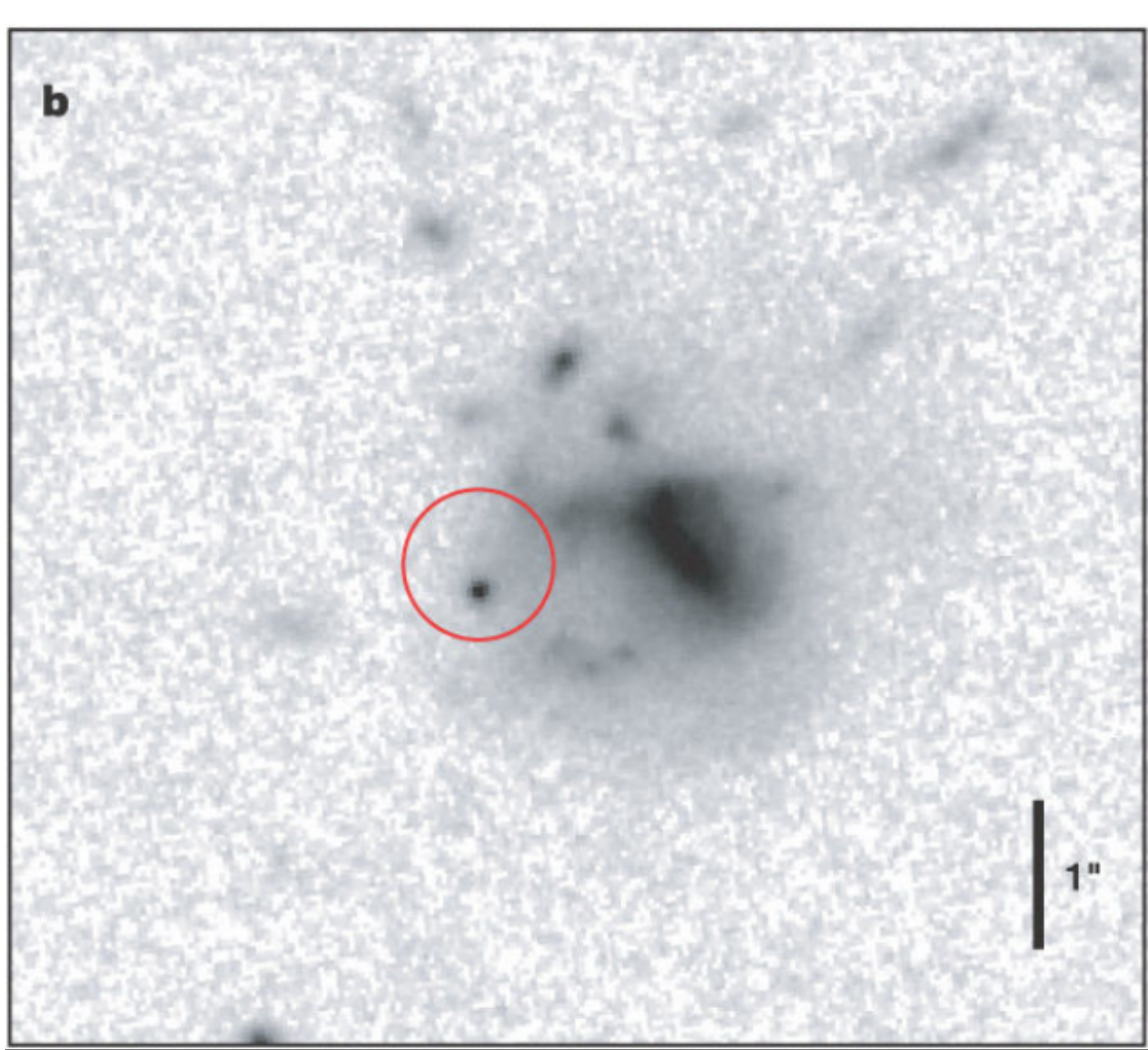

(Fox et al. 2005)

# GRB 030329: the “smoking gun”?

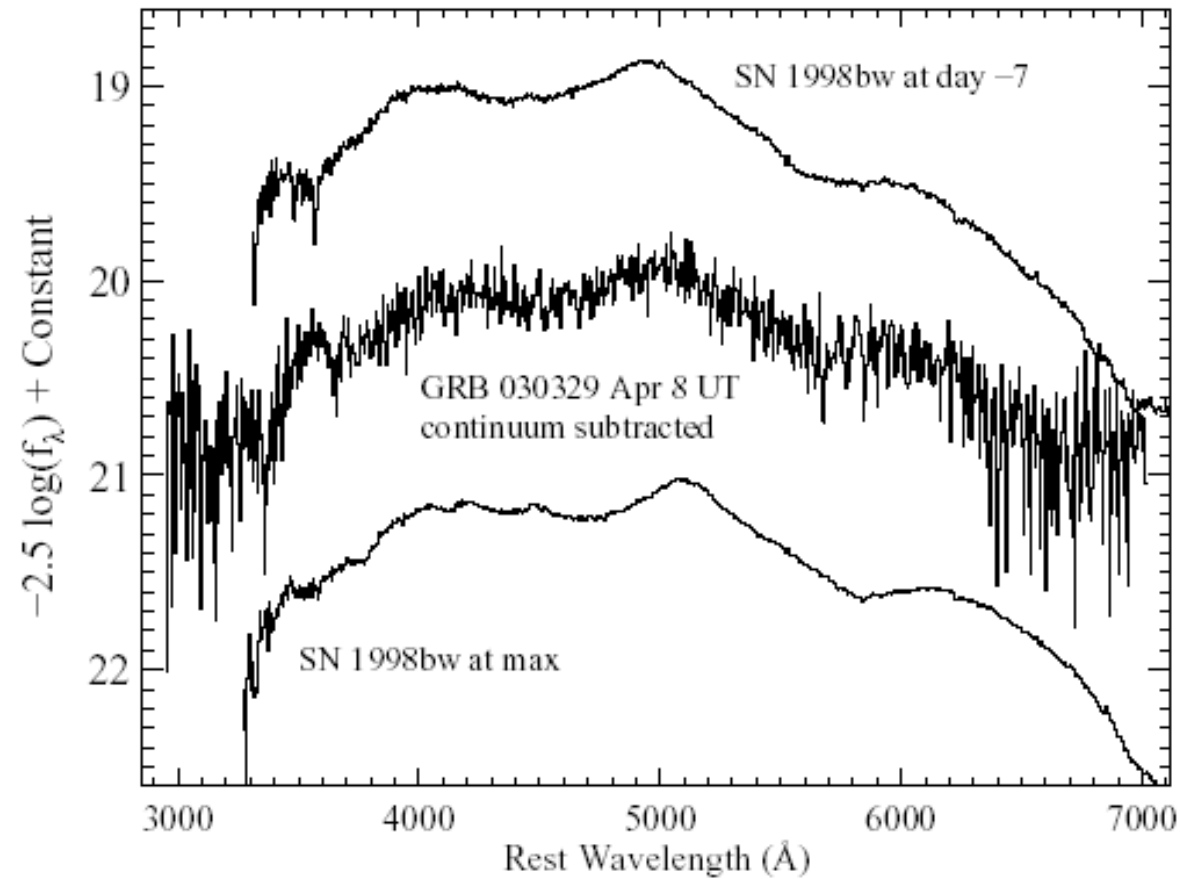

(Matheson et al. 2003)

# Collapsar model

Woosley (1993)

## Scenario X: Collapsar

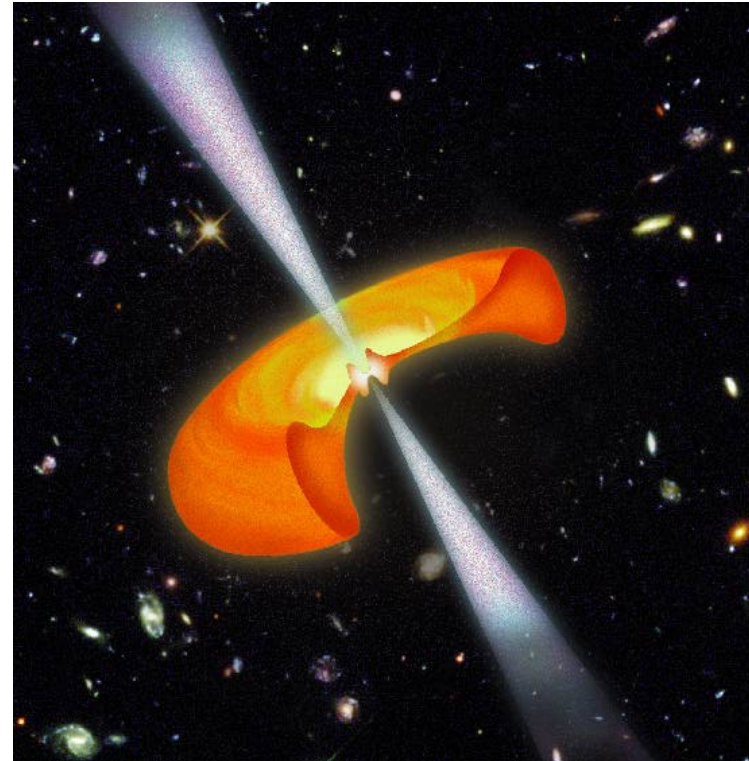
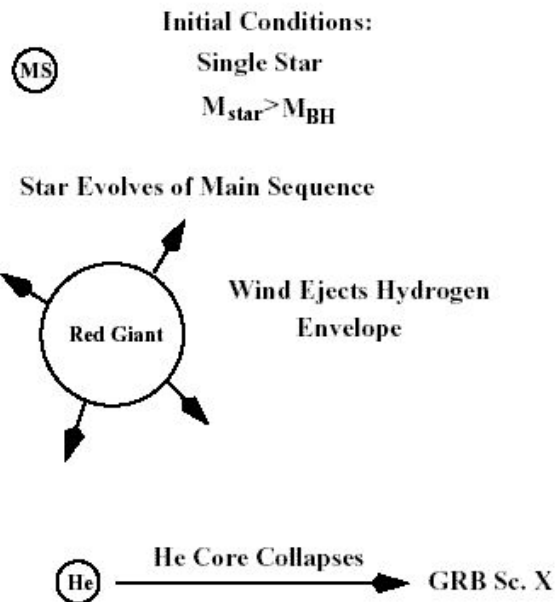

- Very massive star that collapses in a rapidly spinning BH.
- Identification with SN explosion.

# Classificazione delle SNe

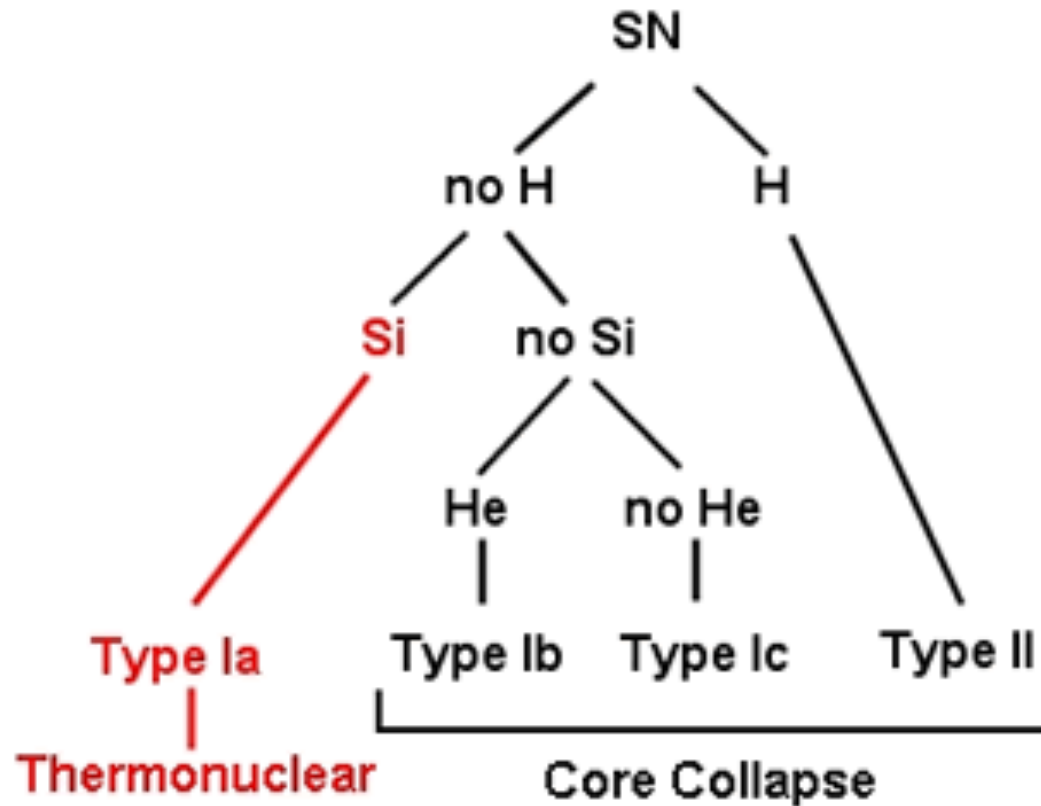

# Classificazione delle SNe

thermonuclear

core collapse

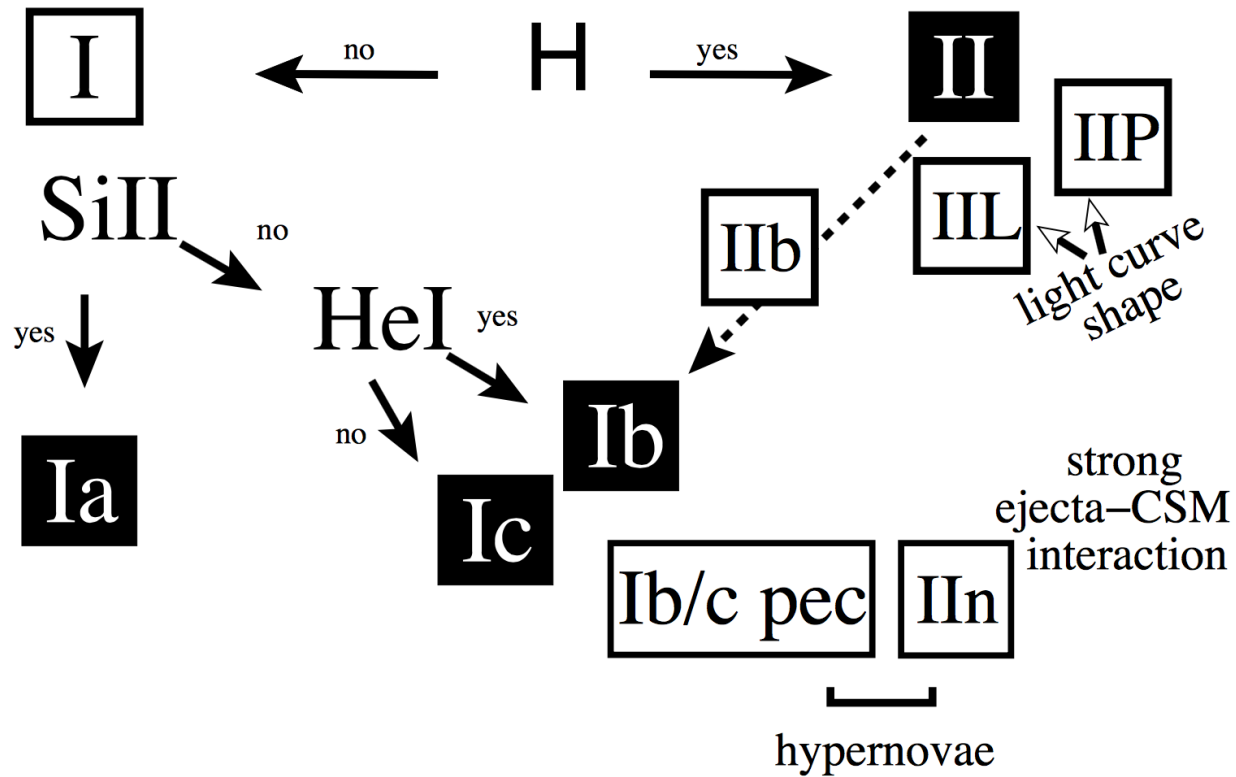

# SWIFT

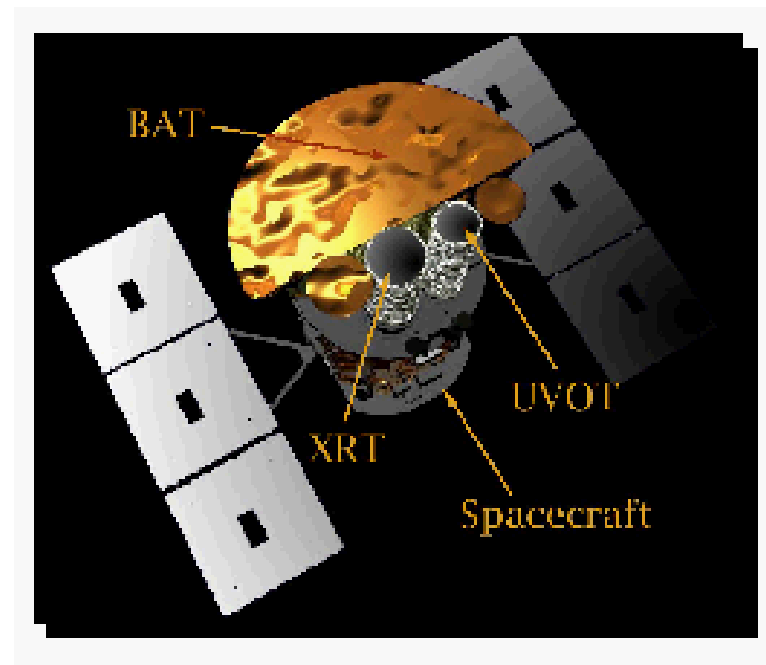

In orbita dal 2004

# Swift Instruments

## Instruments

- **Burst Alert Telescope (BAT)**
  - New CdZnTe detectors
  - Most sensitive gamma-ray imager ever
- **X-Ray Telescope (XRT)**
  - Arcsecond GRB positions
  - CCD spectroscopy
- **UV/Optical Telescope (UVOT)**
  - Sub-arcsec positions
  - Grism spectroscopy
  - 24<sup>th</sup> mag sensitivity (1000 sec)
  - Finding chart for other observers

## Spacecraft

- Autonomous re-pointing, 20 - 75 s
- Onboard and ground triggers

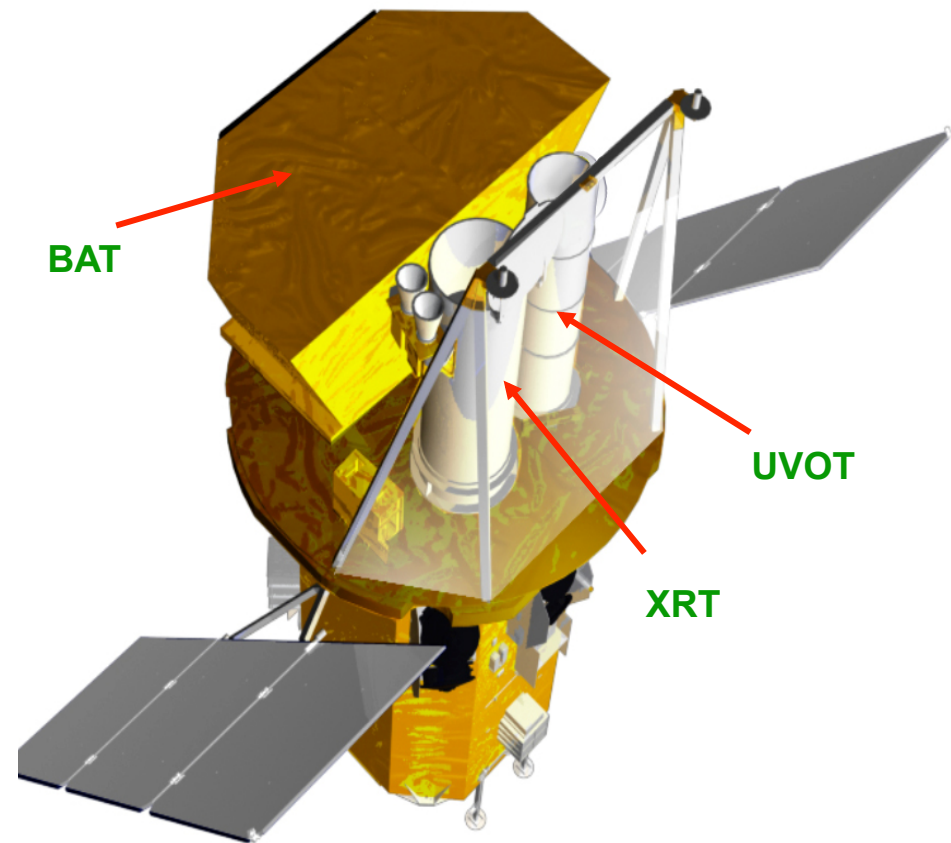



# SWIFT

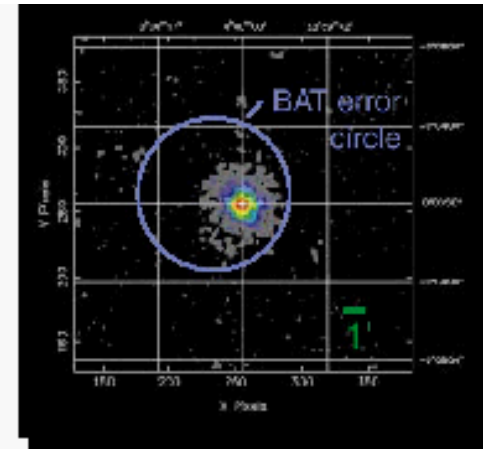
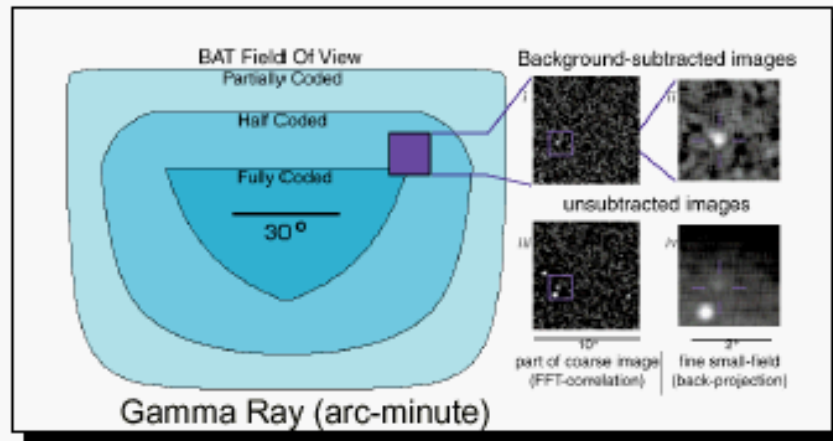

X-ray (2.5 arc-second)

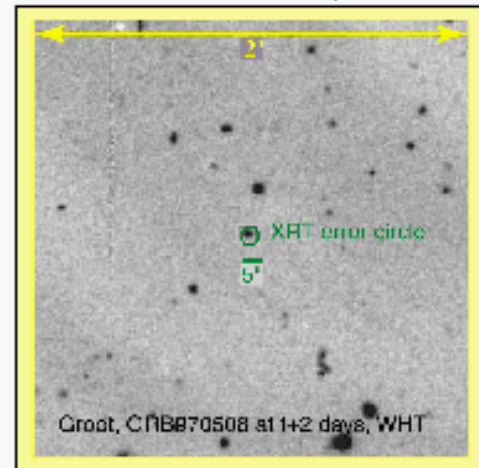

UVOT  
(0.3 arc-second)



HST, Keck,  
etc.

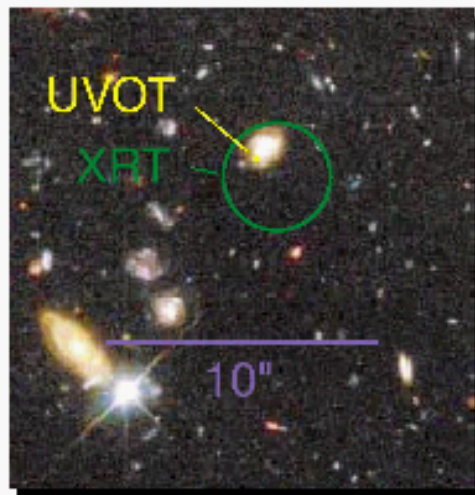

# Mission Capabilities

**Multiwavelength observations on all time scales**

**>100 GRBs per year of all types**

**BAT sensitivity 2 - 5 time better than BATSE**

**Arcsec positions & counterparts for 100's GRBs**

**Rapid GRB notifications via GCN**

**Identification of host galaxies offsets**

**X-ray and UV/optical spectroscopy**

**Upload capability to slew to GRB and transients detected by other observatories**

**BAT**

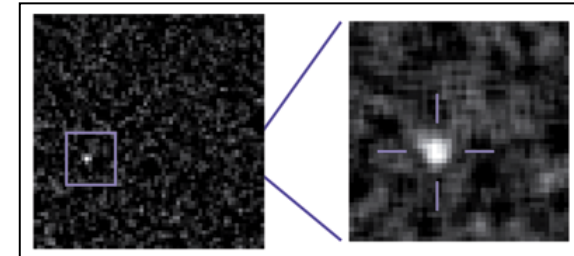

**XRT**

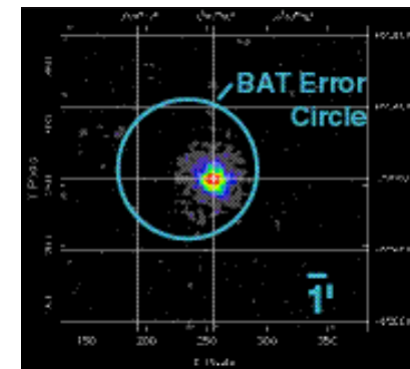

**UVOT**

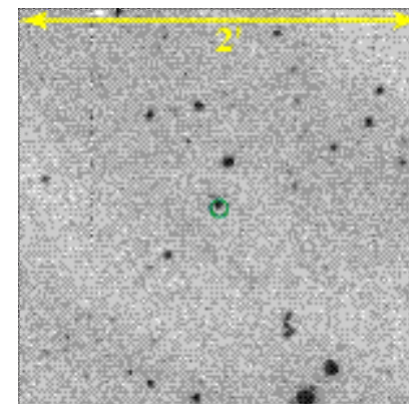

# Swift Observatory in Goddard Clean Room



# Swift

## Details

- **BAT** (15-350 keV). Large (2 sr) field of view – detects bursts with arc min accuracy. And tells observers immediately.
- *Swift* automatically determines if it can view the GRB, and if so, slews to it.
- **XRT** (0.3-10 keV) and **UVOT** ( $\sim 1000\text{-}6000 \text{ \AA}$ ) begin observing typically within 100 s of the trigger.
- XRT can automatically detect afterglows, and downlinks limited data immediately.  $\sim 90\%$  of BAT GRBs have promptly detected XRT afterglows.

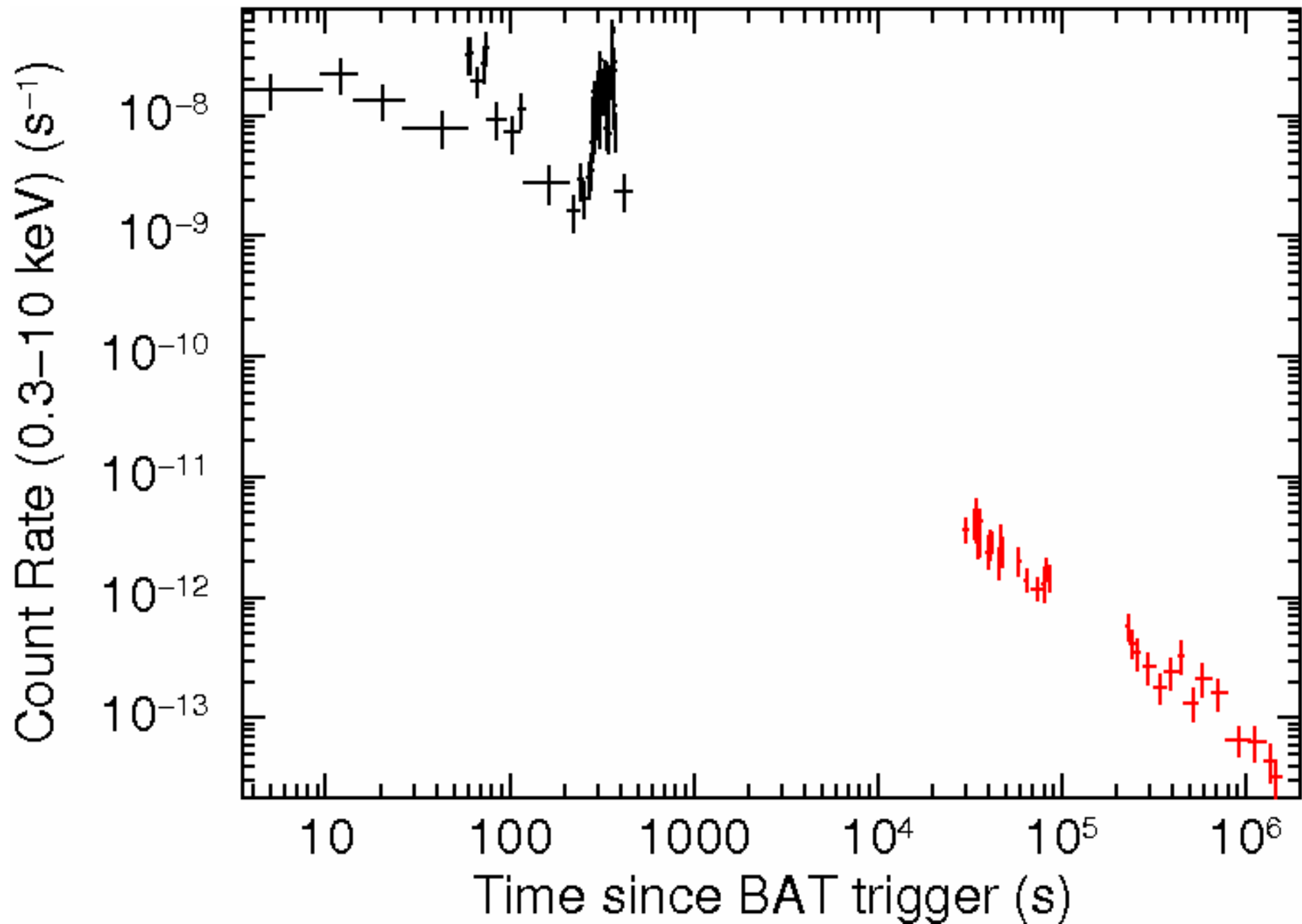



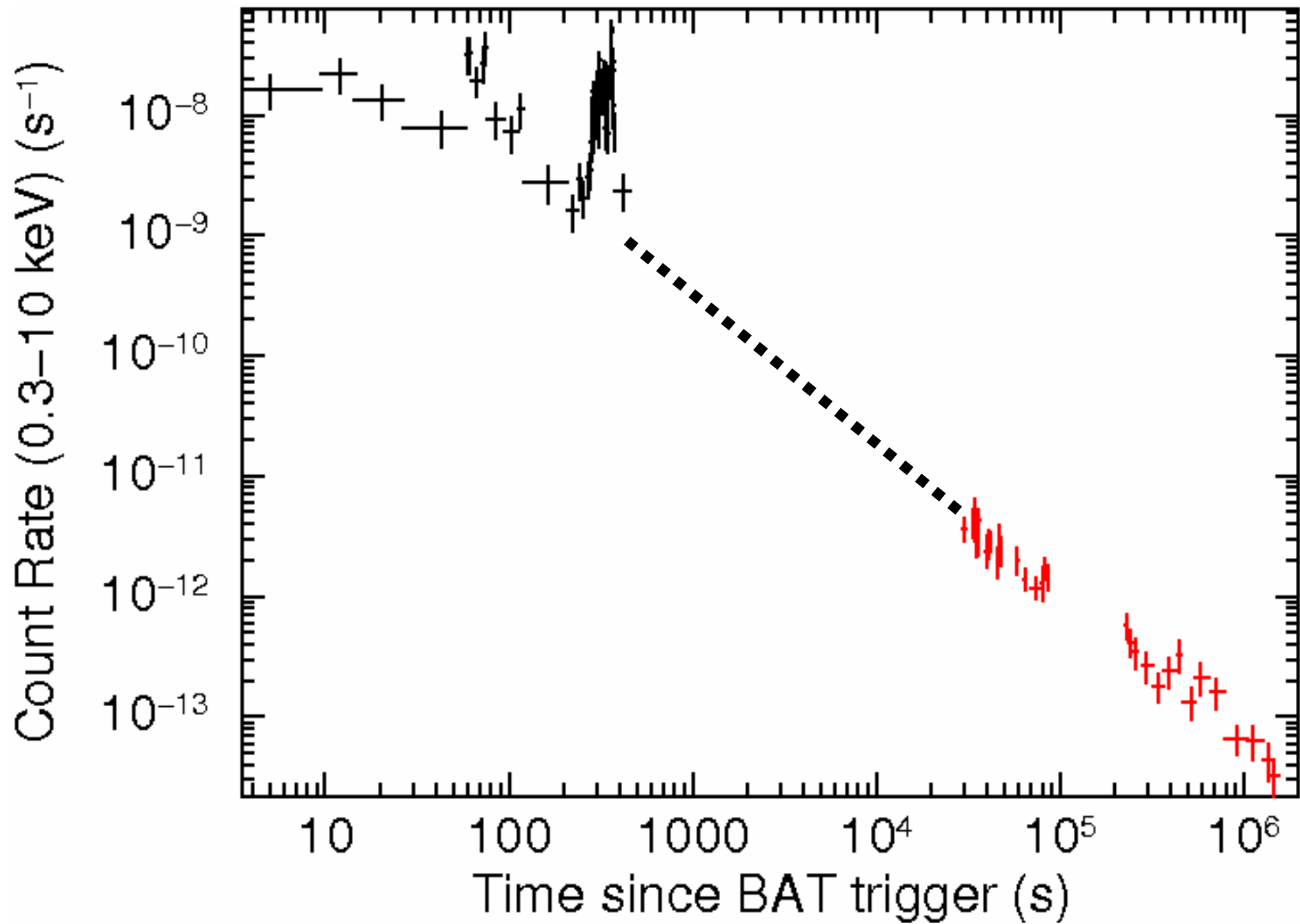

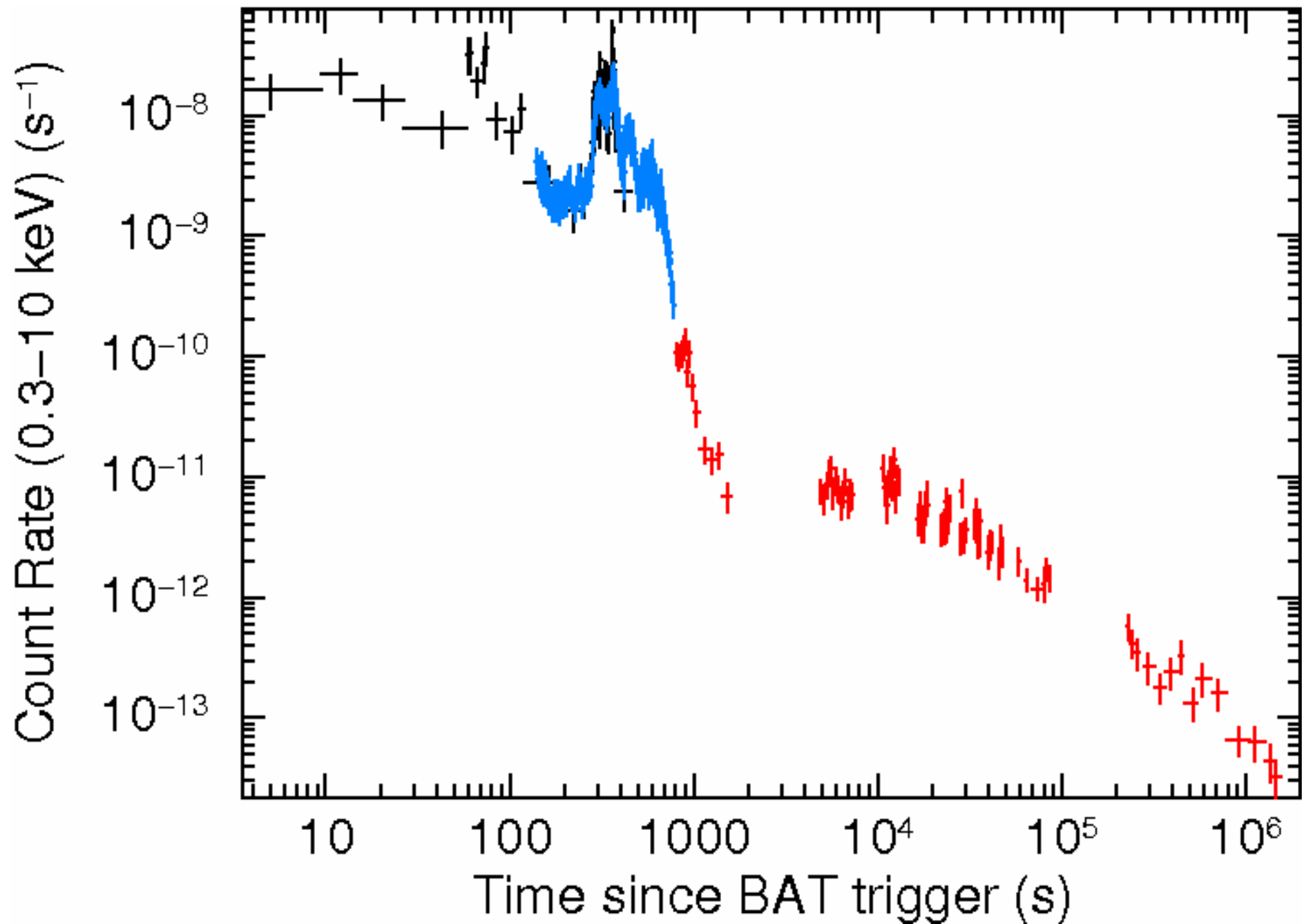



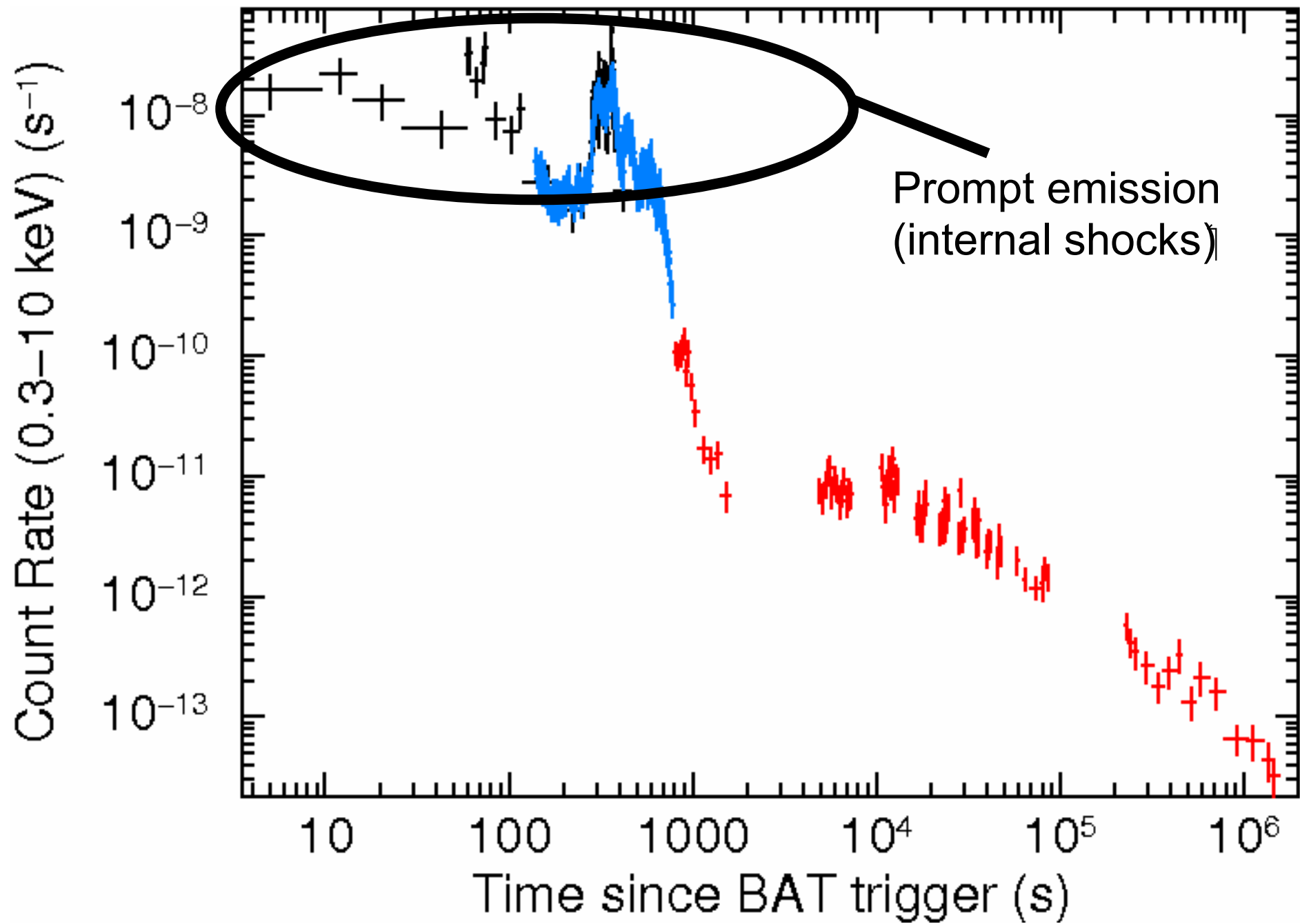

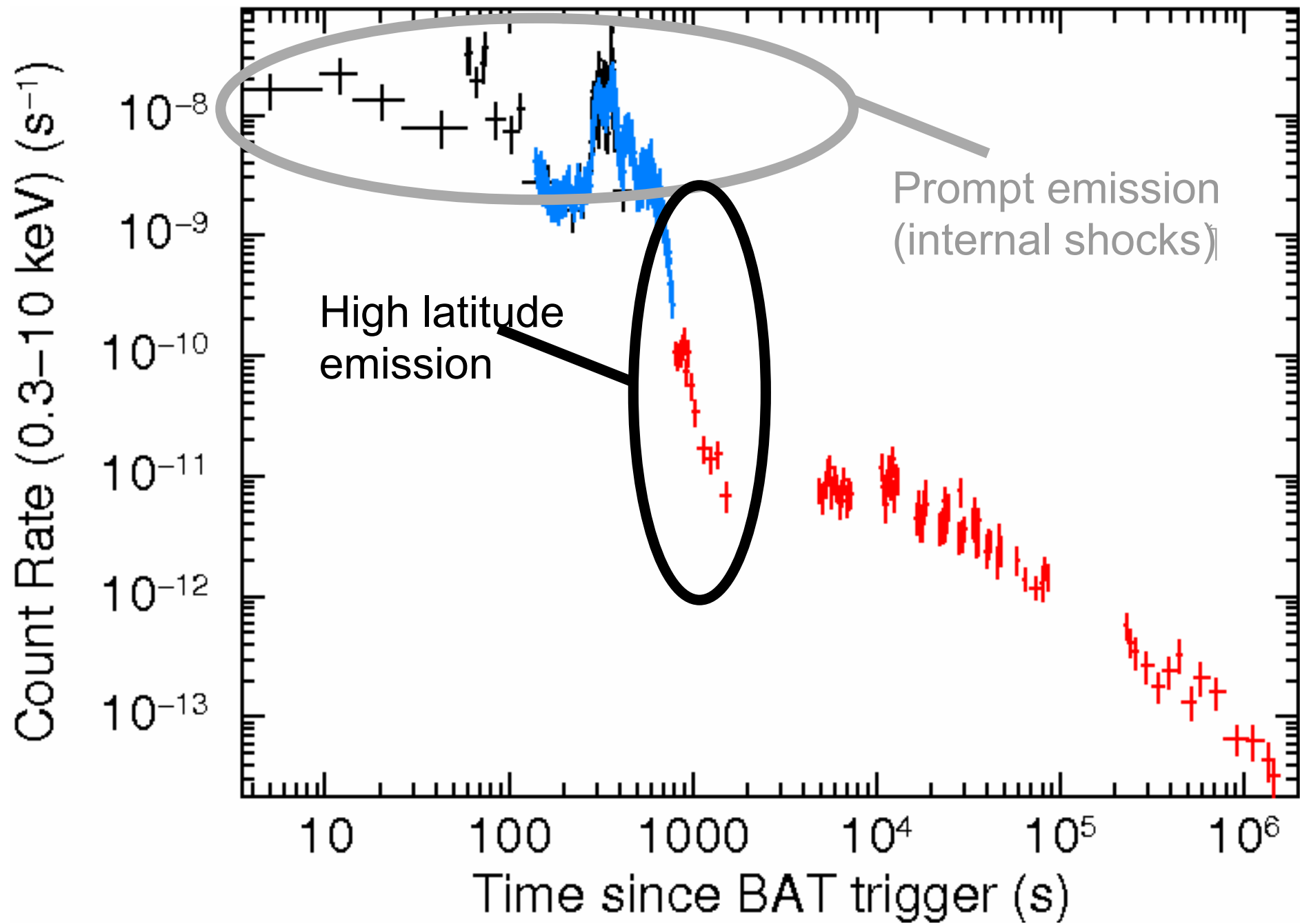

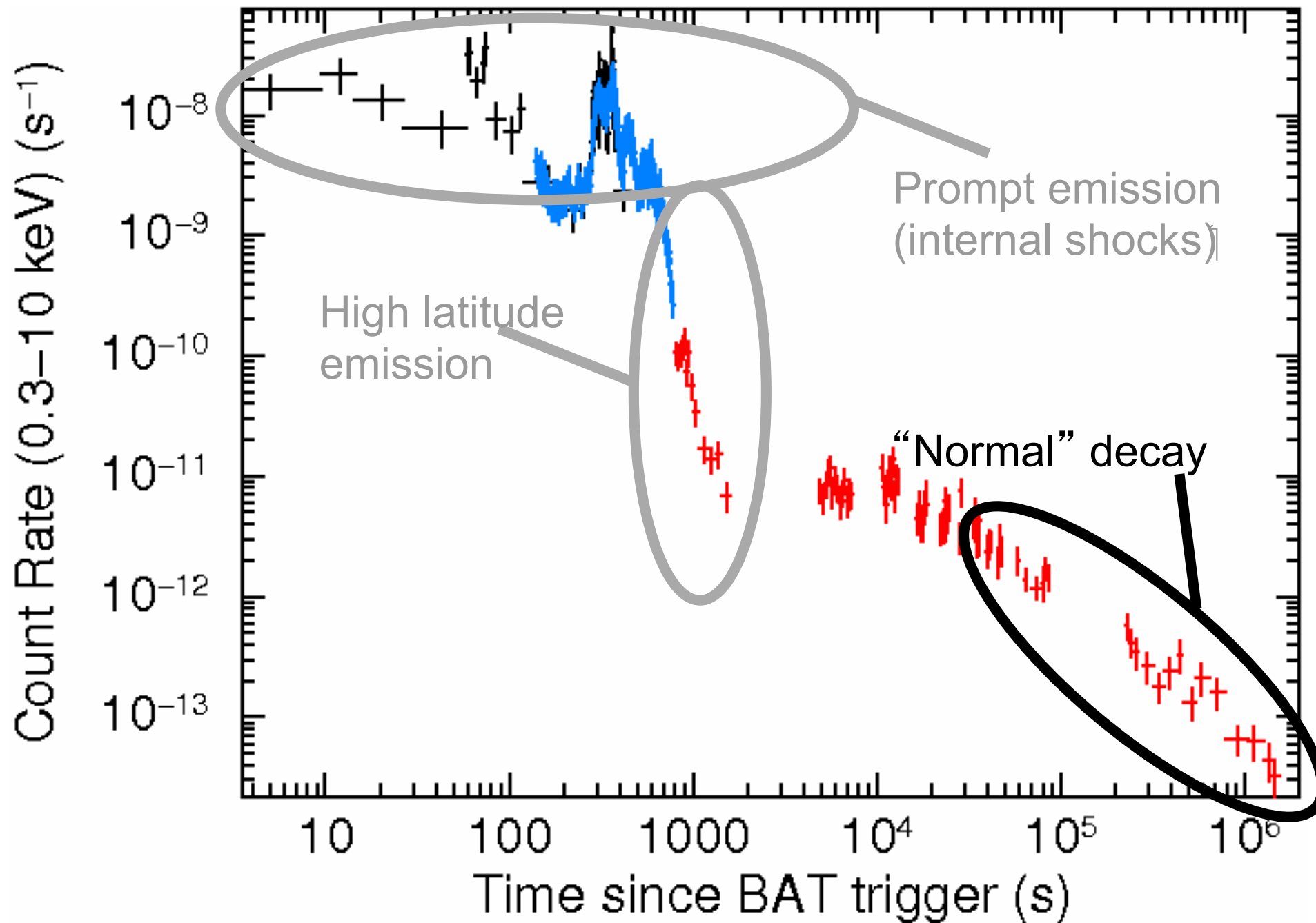

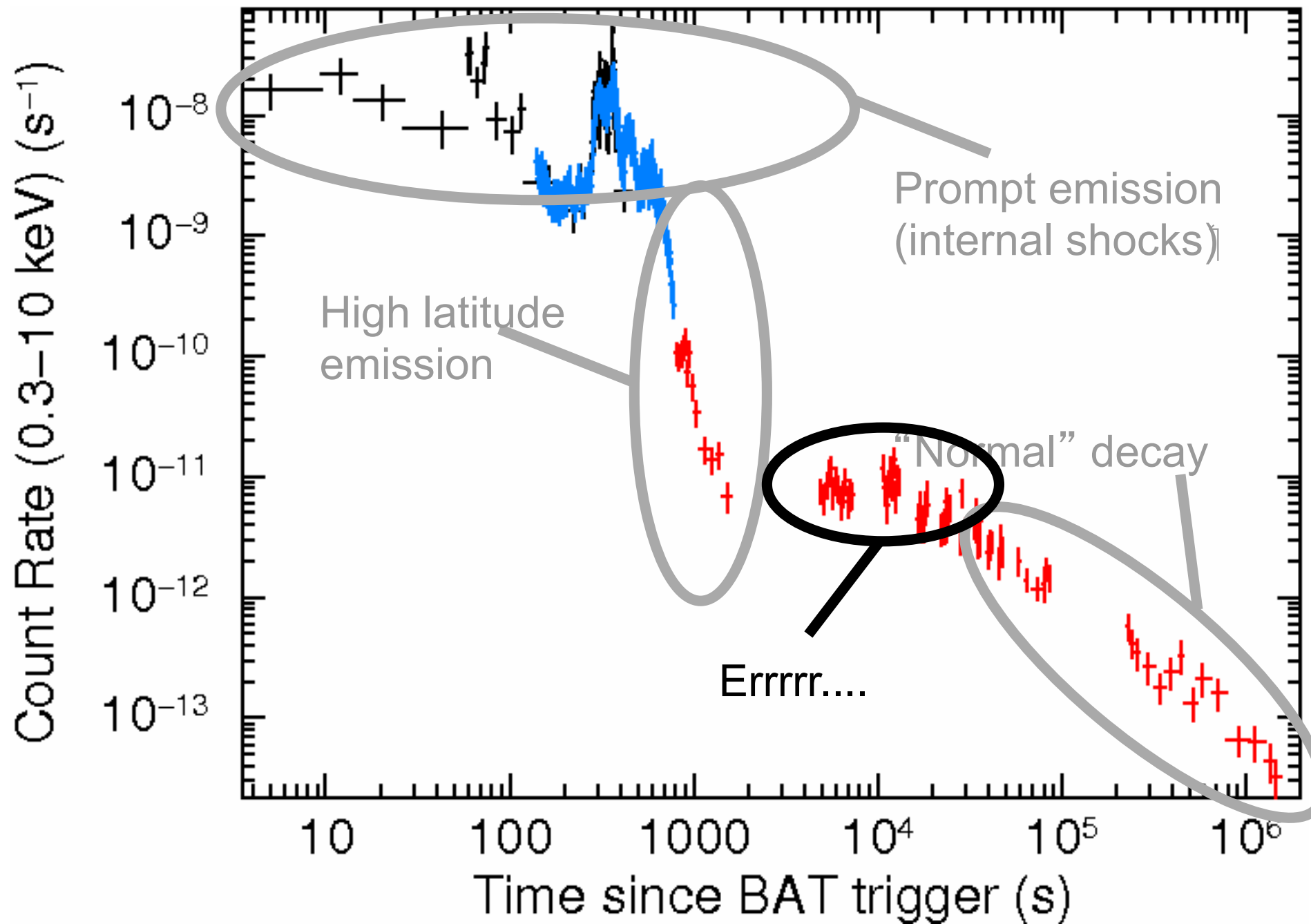

# Swift discoveries

## Complex X-ray afterglows

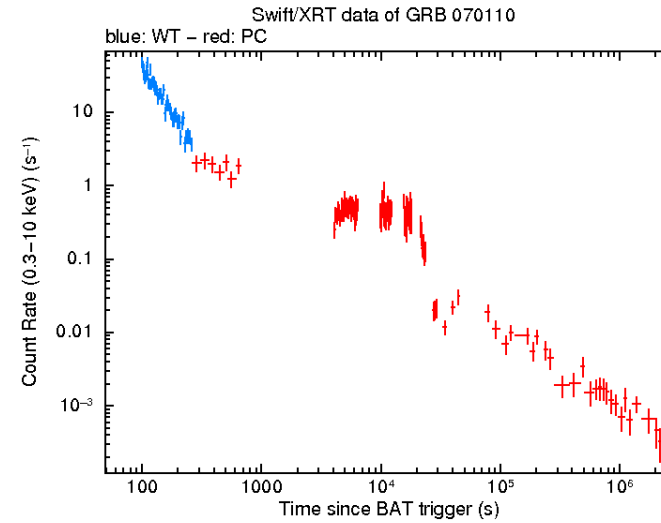
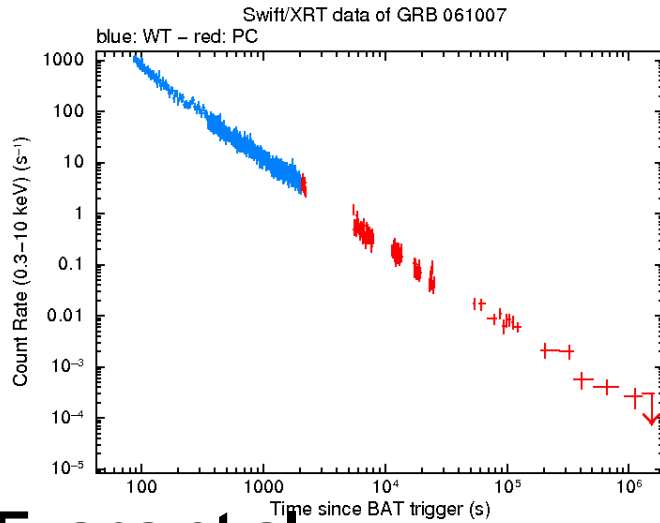
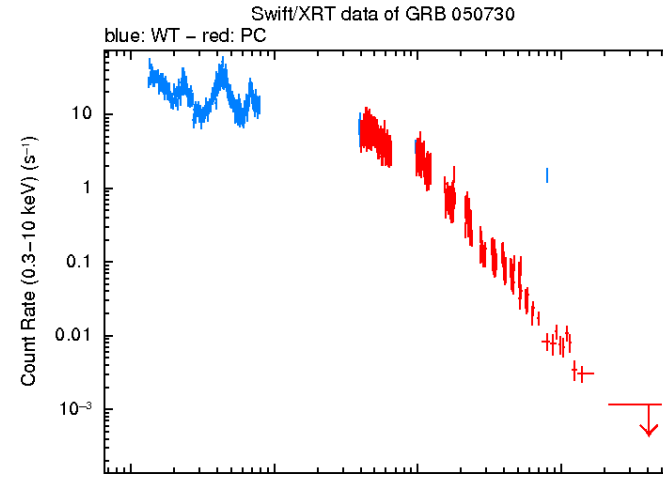
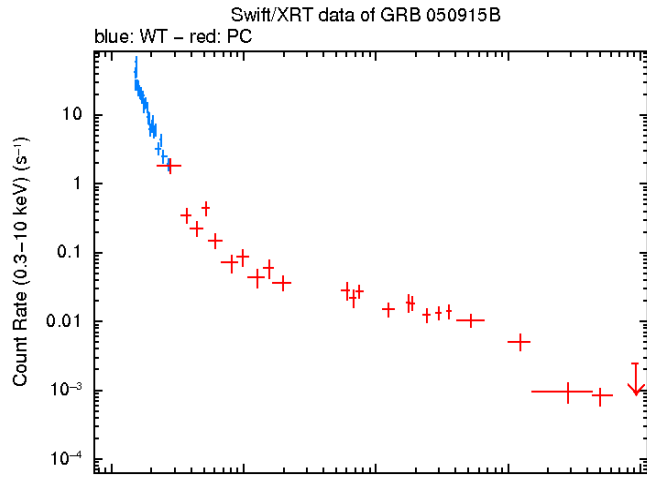

Evans et al.  
2009

# Swift discoveries

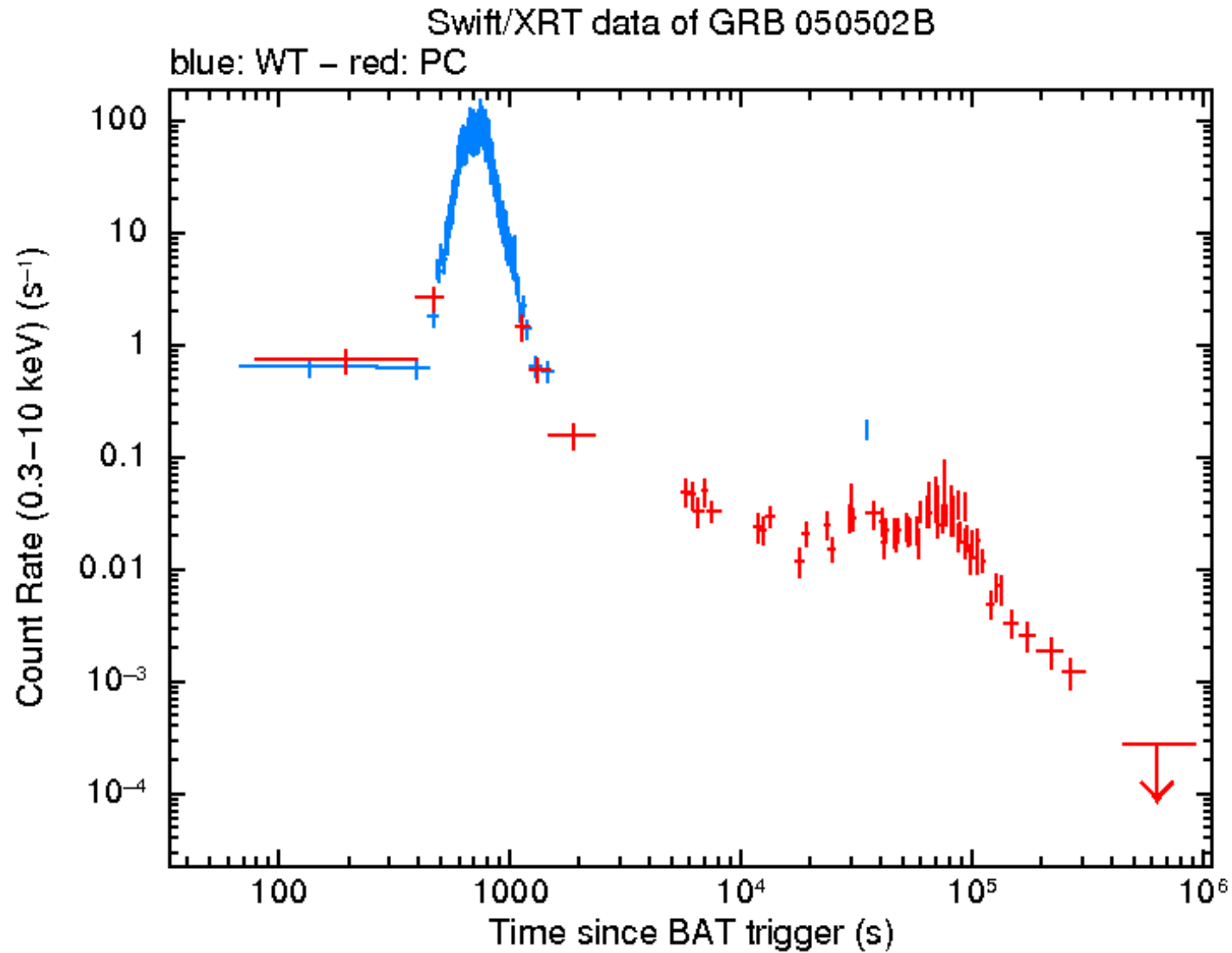

# Swift discoveries

