

Cyber-Physical Systems.

Laura Nenzi

Università degli Studi di Trieste

II Semestre 2021

Lecture 4: Timed Automata and Hybrid Automata

Parking Finite State Machine

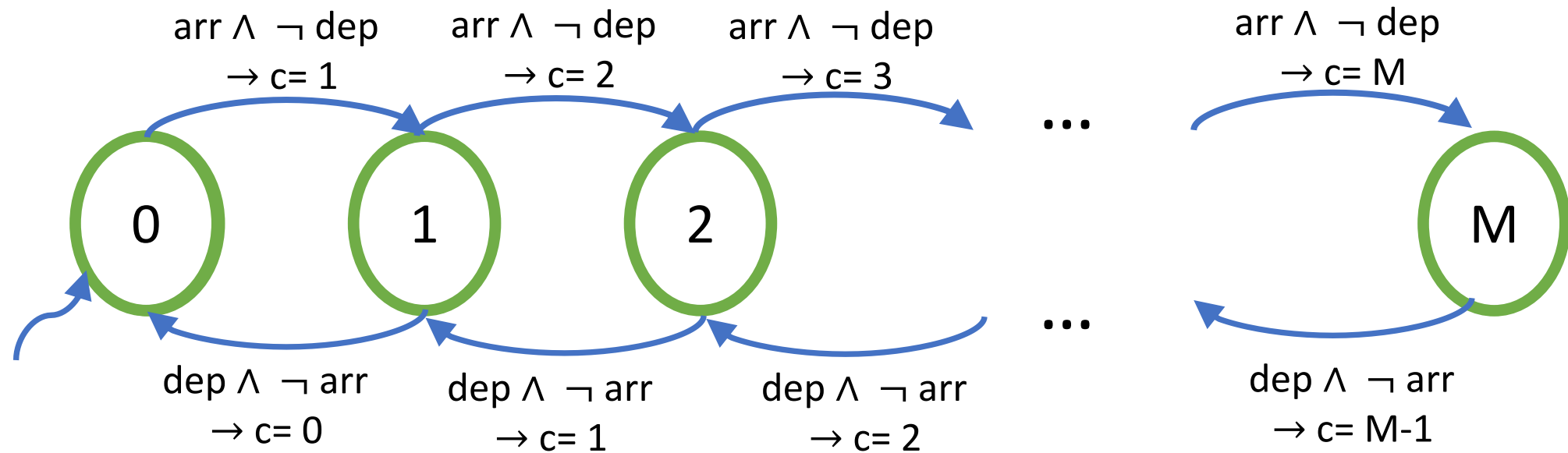

Parking Finite State Machine

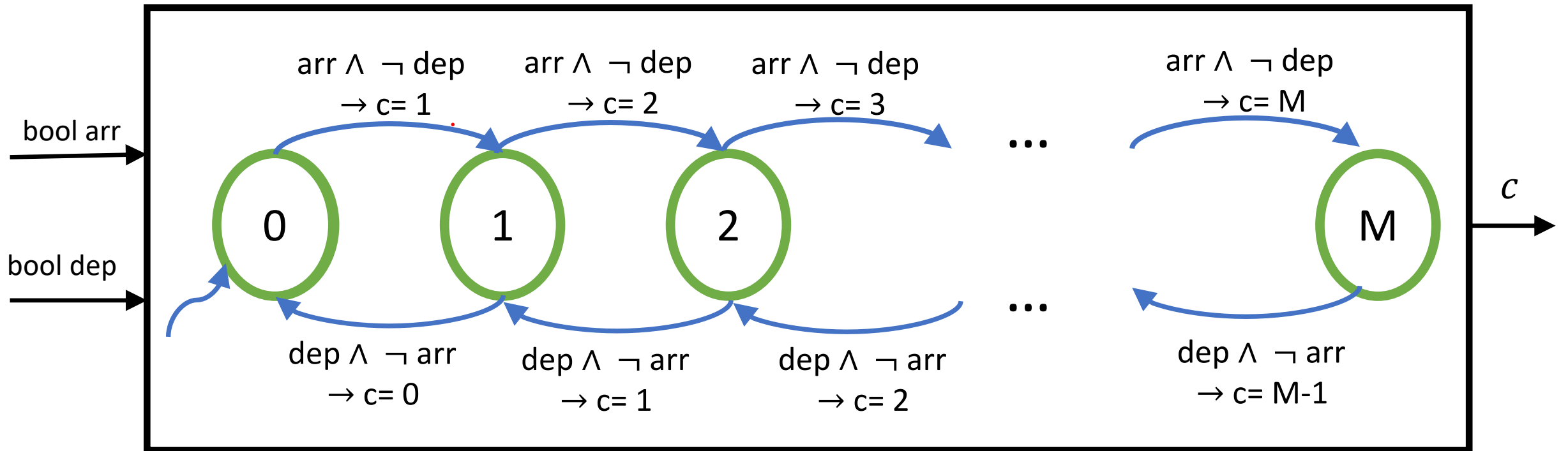

Finite State Machine

A FSM is a tuple $\{S, Q_I, Q_O, update, s_0\}$ where:

- S is a finite set of states;
- Q_I is a set of input valuations;
- Q_O is a set of output valuations;
- $update: S \times Q_I \rightarrow S \times Q_O$ is an update function, mapping a state and an input valuation to a next state and an output valuation;
- s_0 is the initial state.

Mealy machines and Moore machine

The state machines we describe here are known as **Mealy machines**, named after George H. Mealy, a Bell Labs engineer who published a description of these machines in 1955 (Mealy, 1955). Mealy machines are characterized by producing outputs when a transition is taken.

An alternative, known as a **Moore machine**, produces outputs when the machine is in a state, rather than when a transition is taken. That is, the output is defined by the current state rather than by the current transition. Moore machines are named after Edward F. Moore, another Bell Labs engineer who described them in a 1956 paper (Moore, 1956).

Parking Extended State Machine

Consider a system that counts the number of cars that enter and leave a parking garage in order to keep track of how many cars are in the garage at any time.

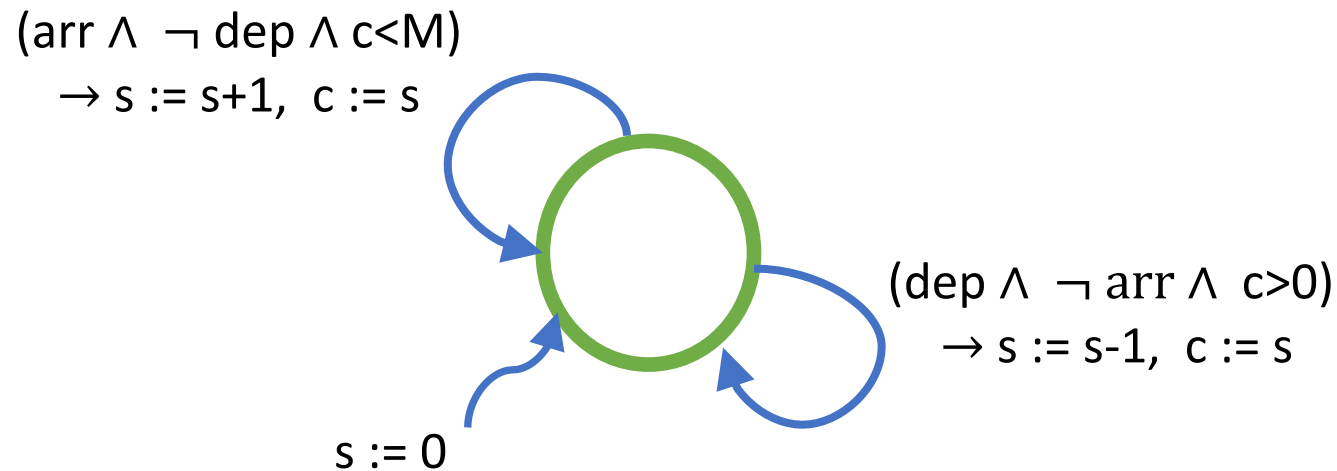

Time Trigger Machine

variable: $count: \{0, \dots, 60\}$

inputs: $pedestrian: \text{pure}$

outputs: $sigR, sigG, sigY: \text{pure}$

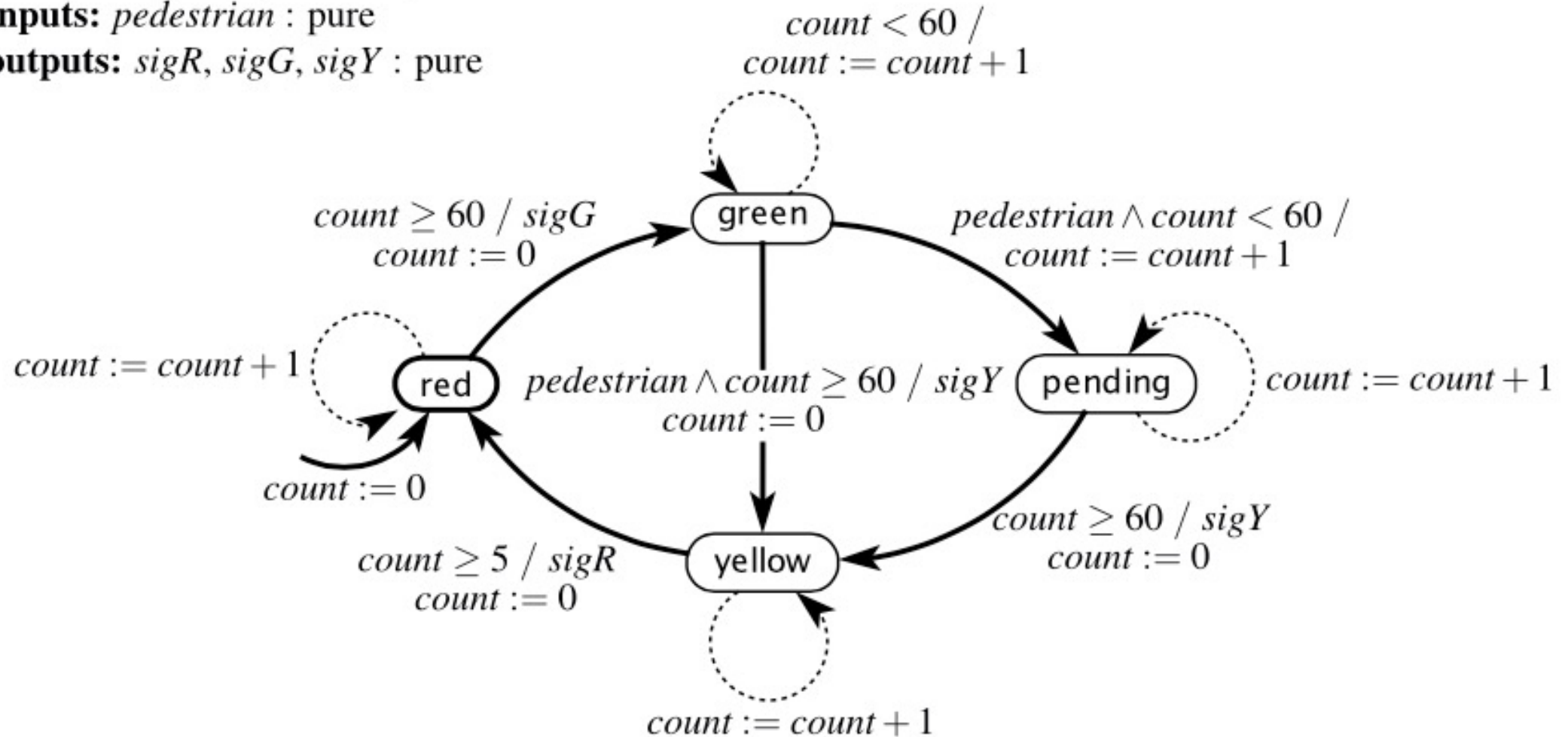

Non-deterministic Finite State Machine

A FSM is a tuple $\{S, Q_I, Q_O, possibleUpdate, s_0\}$ where:

- S is a finite set of states;
- Q_I is a set of input valuations;
- Q_O is a set of output valuations;
- $possibleUpdate: S \times Q_I \rightarrow 2^{\{S \times Q_O\}}$ is an update relation, mapping a state and an input valuation to a set of possible (next state, output valuation) pairs;
- s_0 is the initial state.

inputs: *pedestrian*: pure
outputs: *sigR*, *sigG*, *sigY*: pure

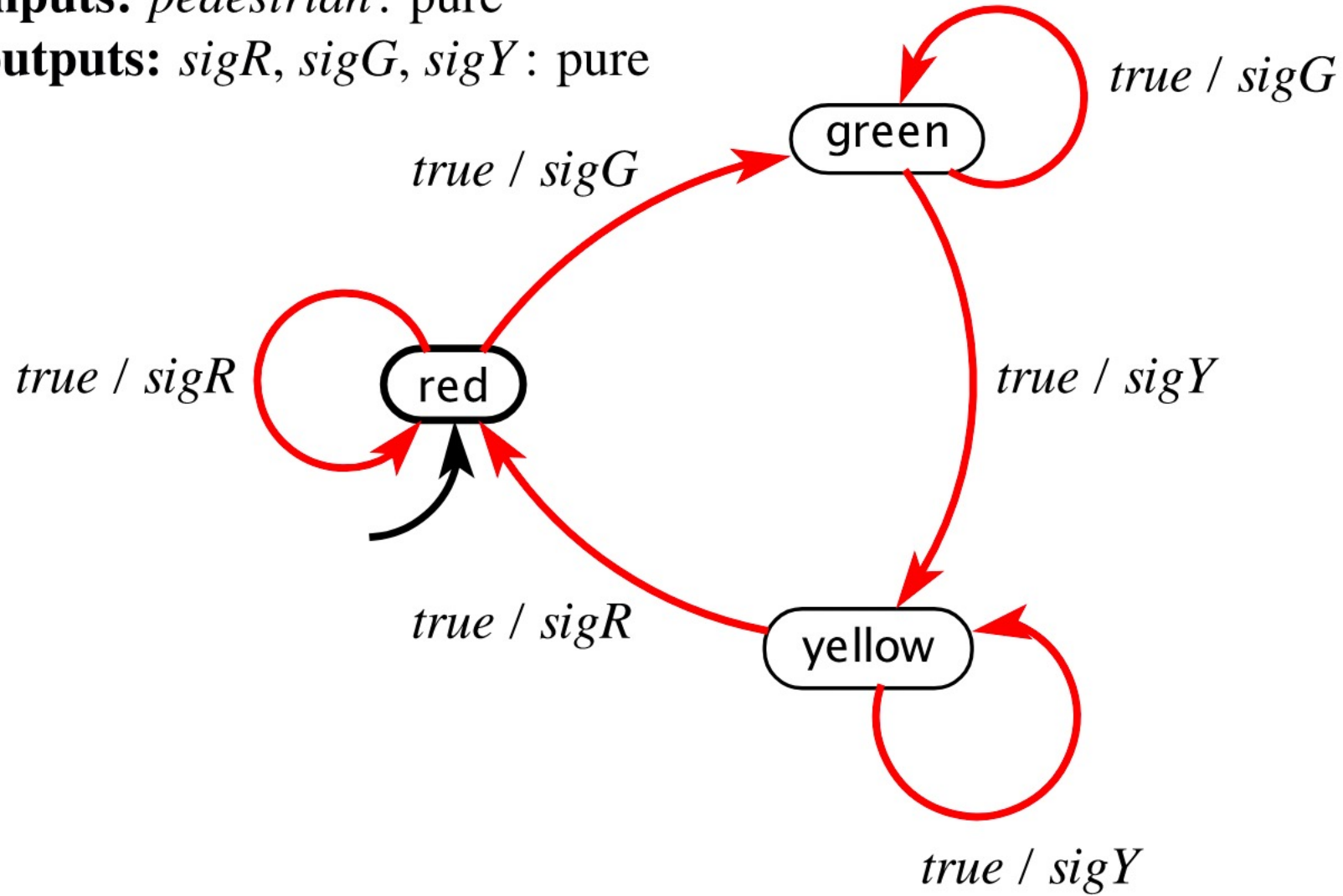

Thermostat FSM

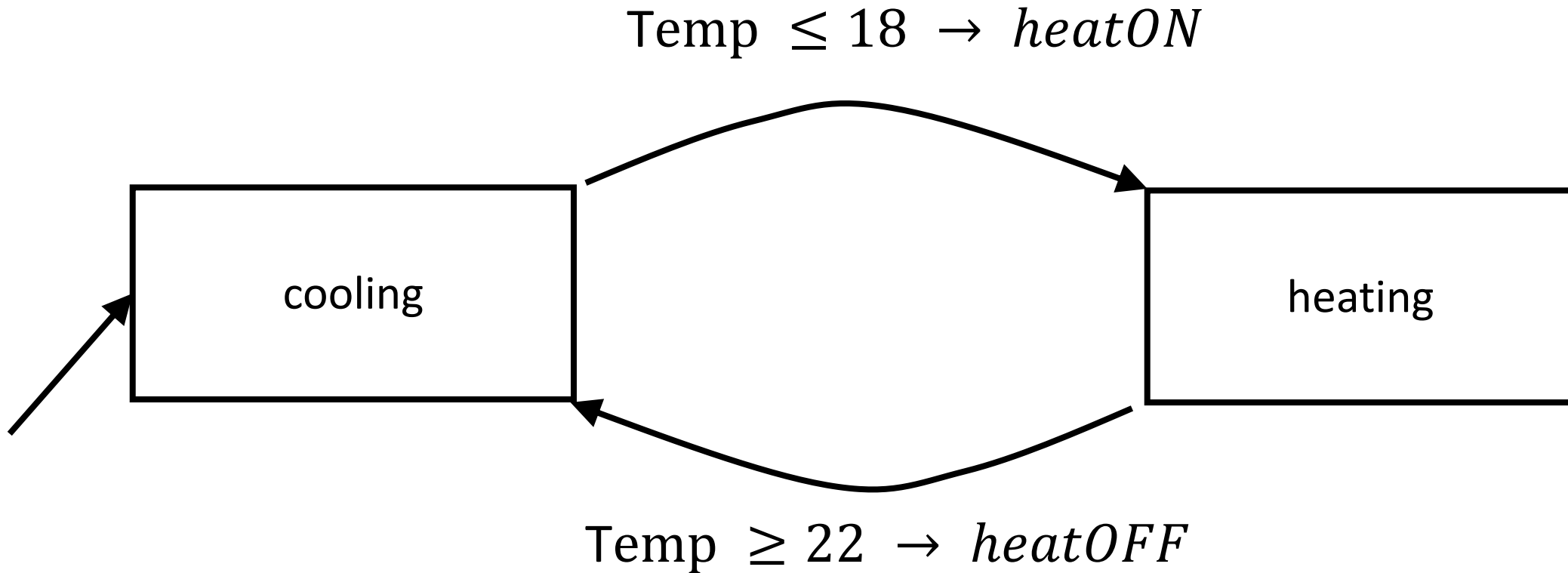

It could be **event triggered**, like the garage counter, in which case it will react whenever a *temperature* input is provided. Alternatively, it could be **time triggered**, meaning that it reacts at regular time intervals

Discrete System (FSM)

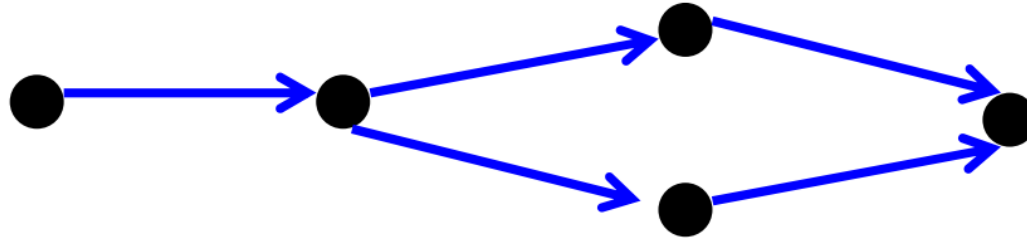

Continuous System

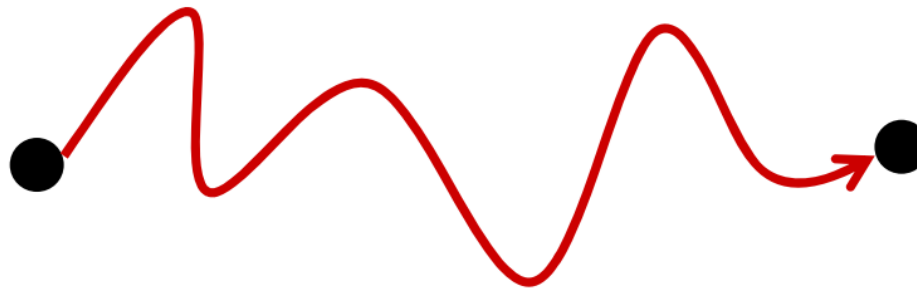

Hybrid System

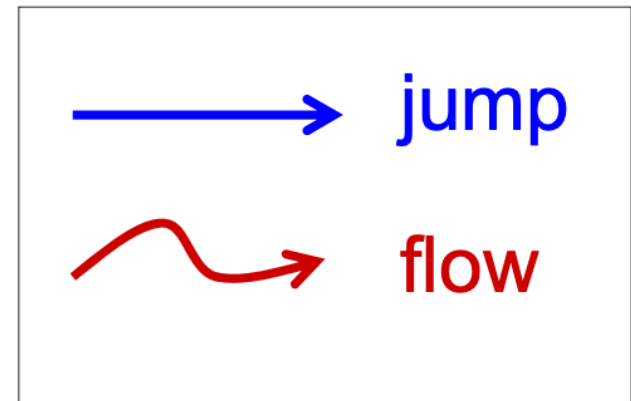
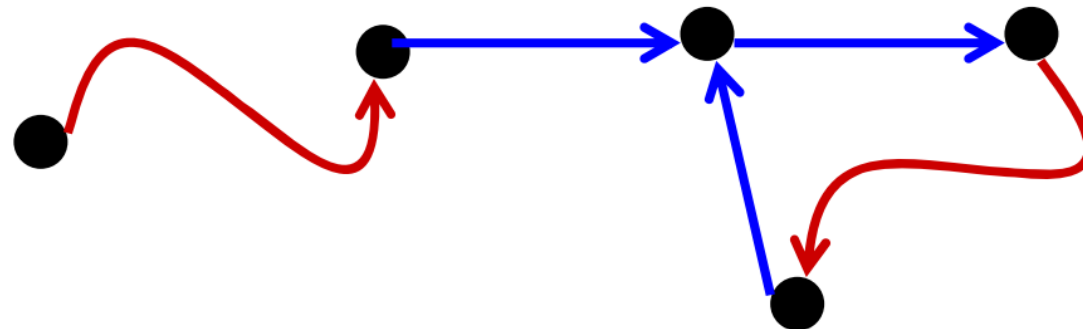

Actor Models

A box, where the inputs and the outputs are functions $S: u \rightarrow y$

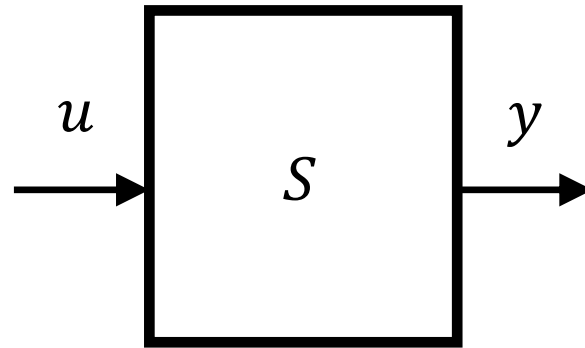

Actor models are composable. We can form a **cascade composition**

We have so far assumed that state machines operate in a sequence of discrete reactions. We have assumed that inputs and outputs are absent between reactions.

Having continuous inputs

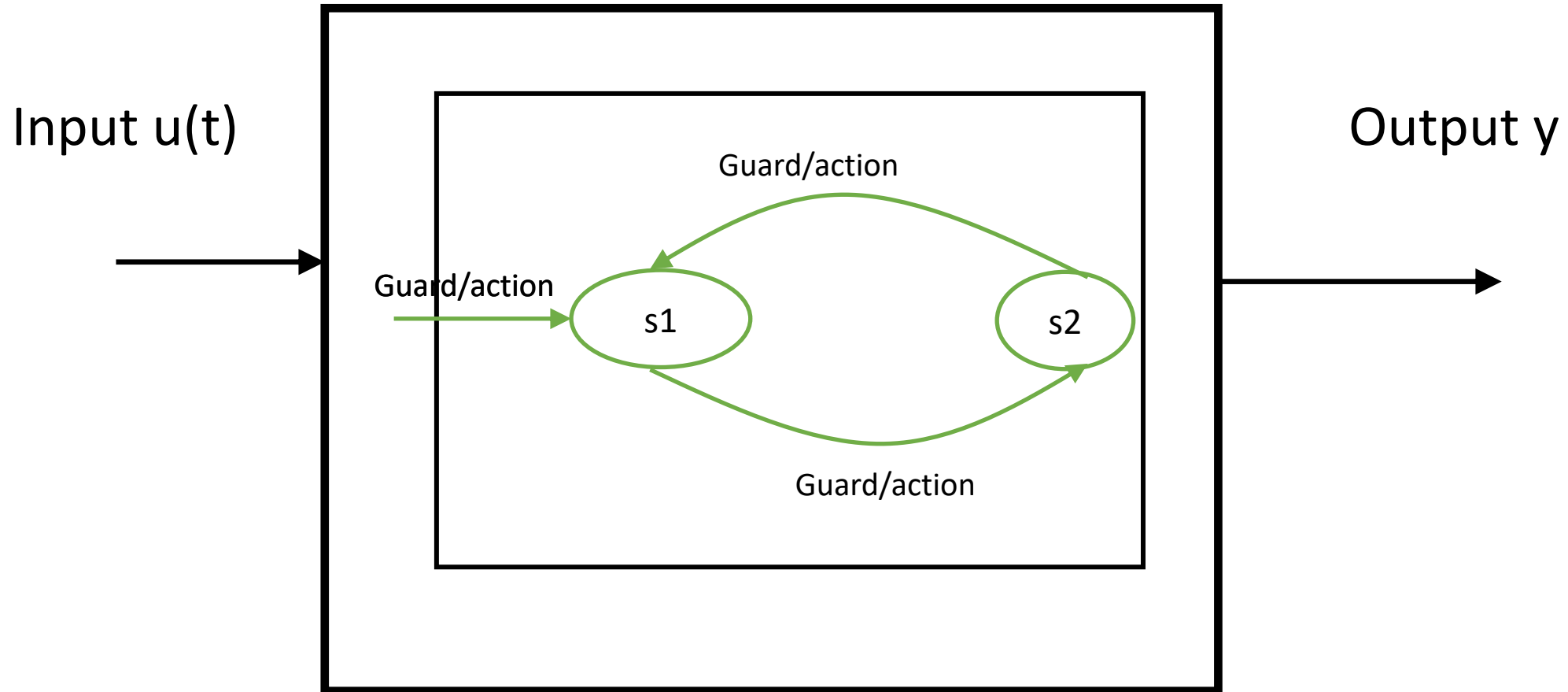

We will define a transition to occur when a guard on an outgoing transition from the current state becomes enabled

Thermostat FSM with a continuous-time input signal

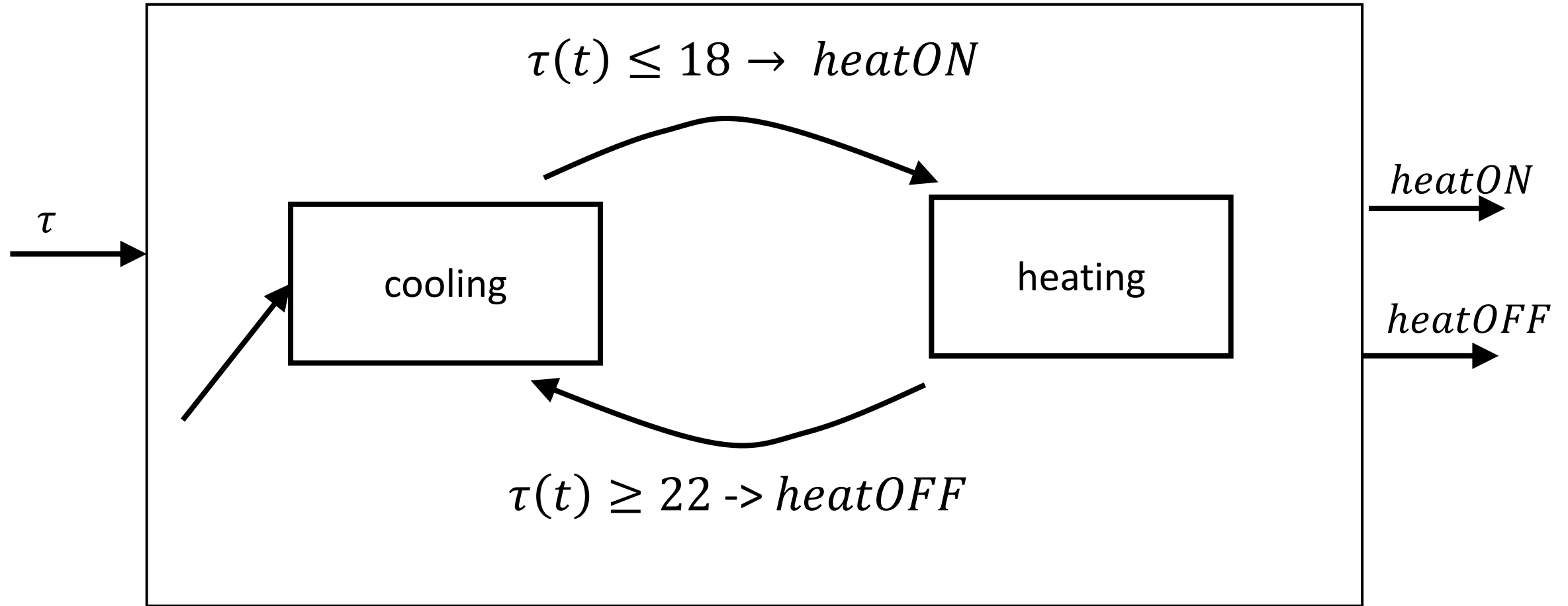

The outputs are present only at the times the transitions are taken

State Refinements

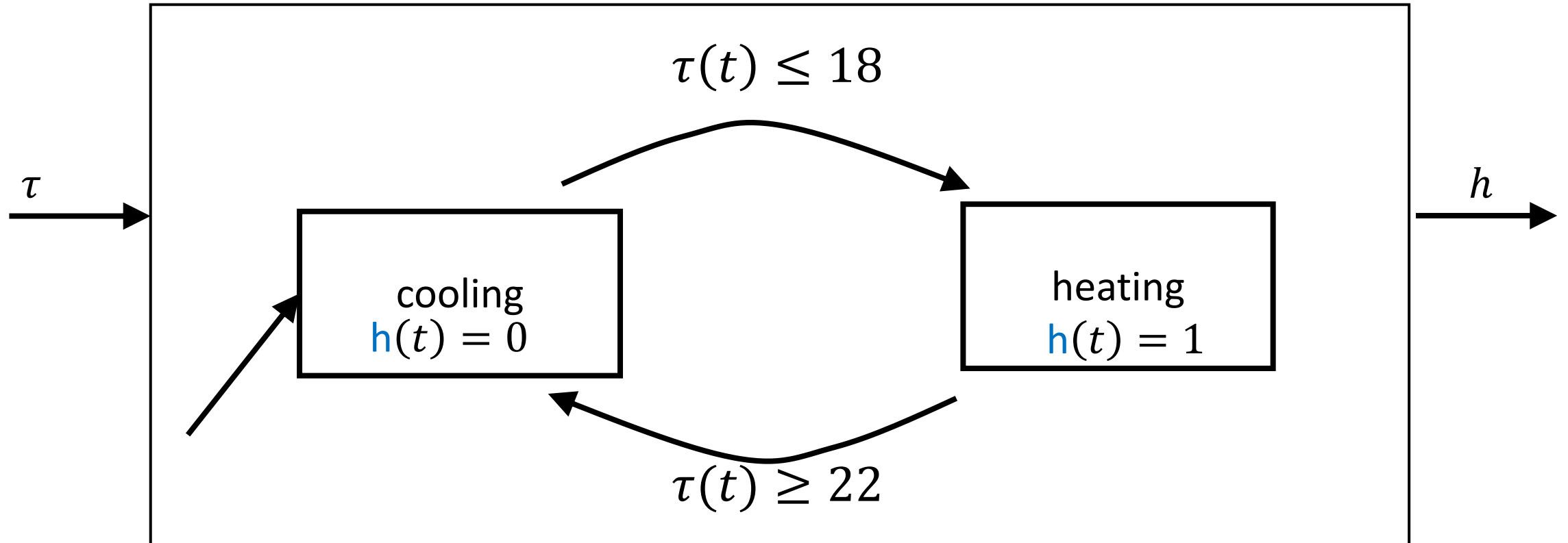

The current state of the state machine has a **state refinement** that gives the dynamic behavior of the output as a function of the input.

Modal Models

A hybrid system is sometimes called a modal model because it has a finite number of modes, one for each state of the FSM, and when it is in a mode, it has dynamics specified by the state refinement.

Timed Automata

- Introduced by Alur and Dill (A theory of timed Automata, TCS,1994)
- They are the simplest non-trivial hybrid systems
- All they do is measuring the passage of time
- A **clock** $s(t)$ is modeled by a first-ODE: $\dot{s} = a \quad \forall t \in T_m$
where $s : \mathbb{R} \rightarrow \mathbb{R}$ is a continuous-time signal,
 $s(t)$ is the value of the clock at time t , and
 $T_m \subset \mathbb{R}$ is the subset of time during which the hybrid system is in mode m .
The rate of the clock, a , is a constant while the system is in this mode.

Timed Automata

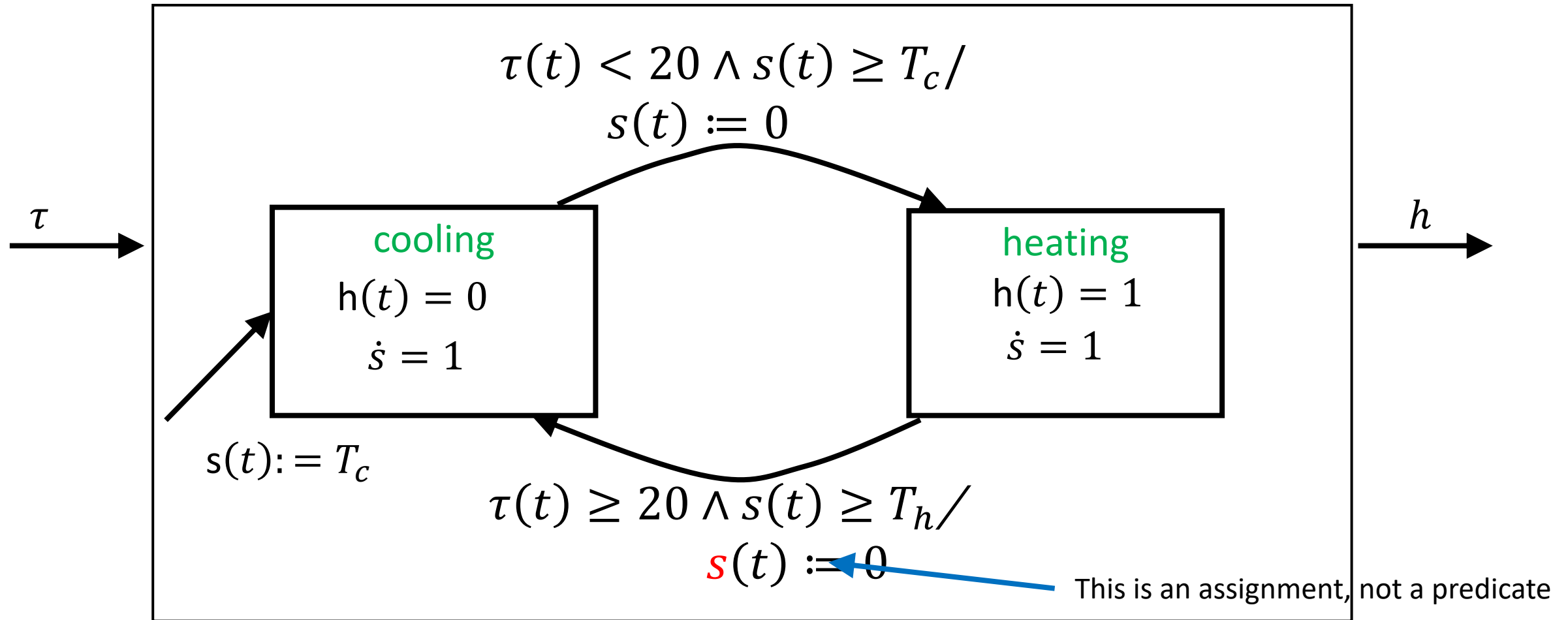

cooling and **heating** are discrete states, **s** is a continuous state

Timed Automata

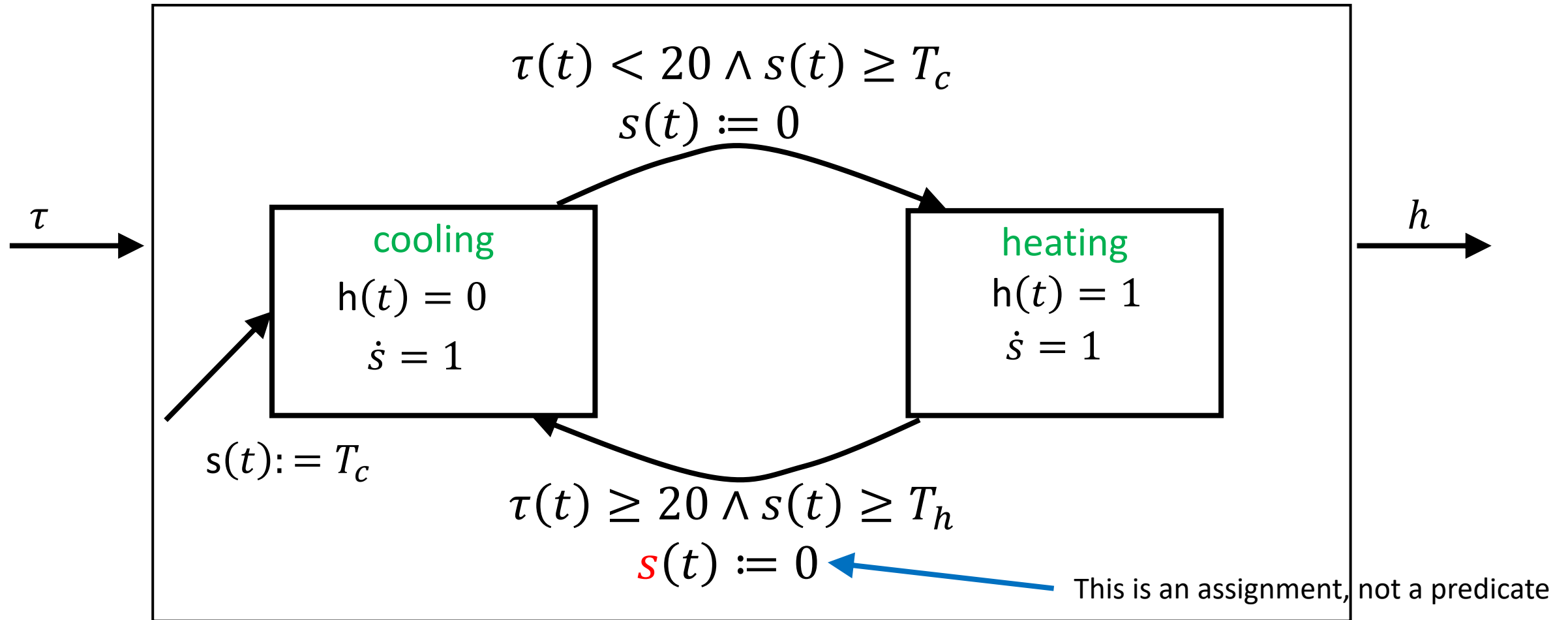

cooling and **heating** are discrete states, **s** is a continuous state

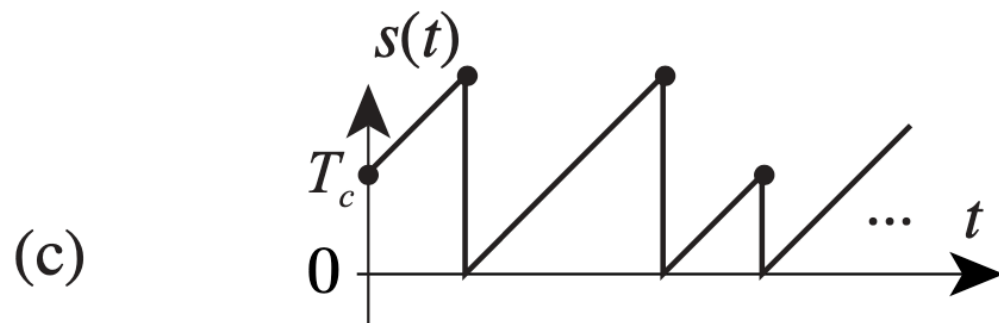
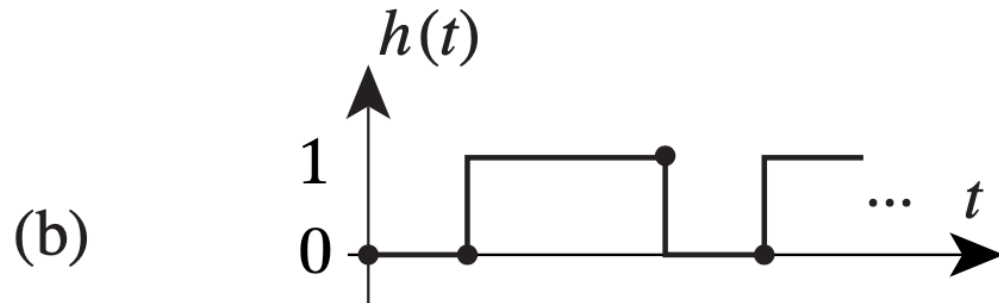
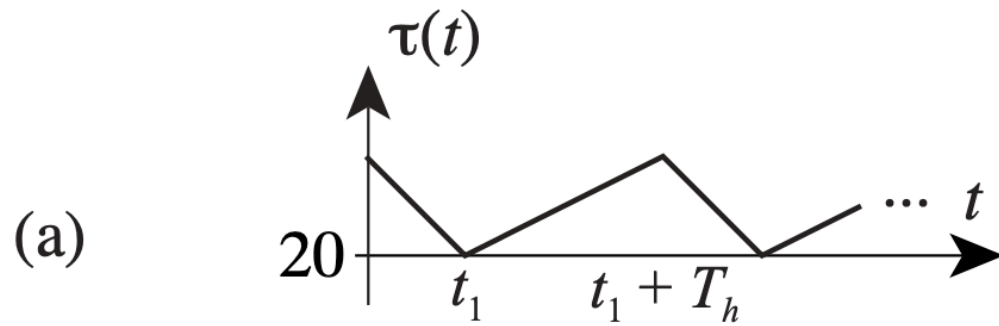

continuous variable: $x(t) : \mathbb{R}$

inputs: *pedestrian*: pure

outputs: *sigR*, *sigG*, *sigY*: pure

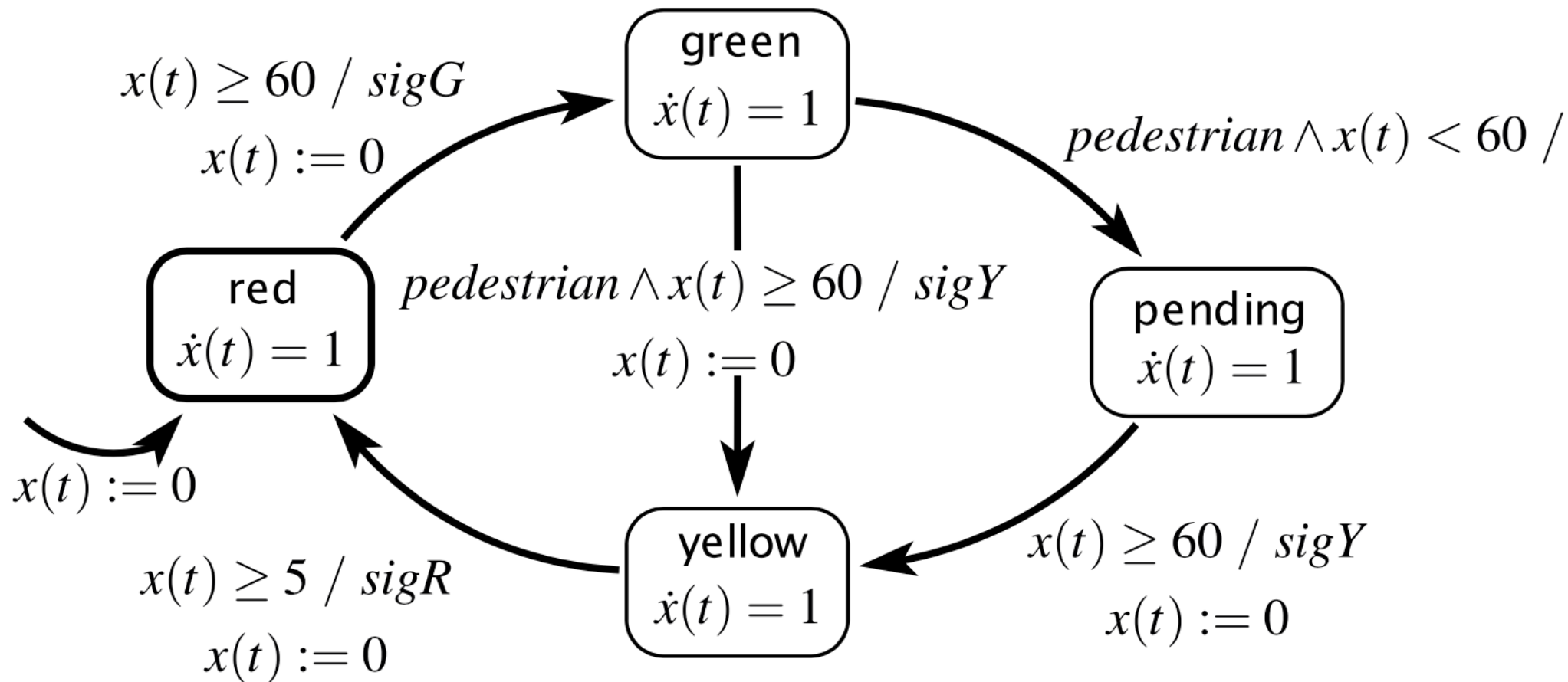

Hybrid Automata

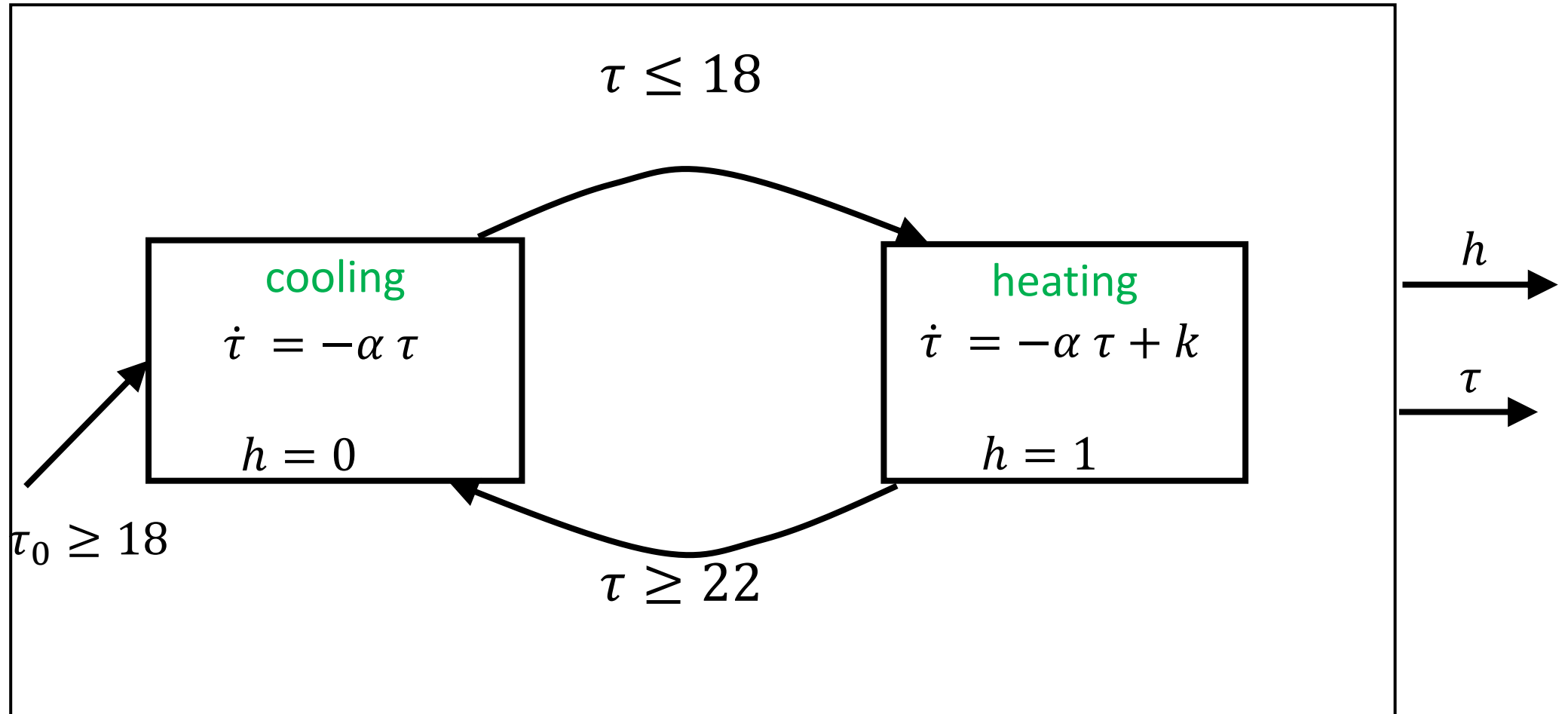

Modeling a bouncing ball

- Ball dropped from an initial height of h_0 with an initial velocity of v_0
- Velocity changes according to $\dot{v} = -g$
- When ball hits the ground, i.e. when $h(t) = 0$, velocity changes discretely from negative (downward) to positive (upward)
 - I.e. $v(t) := -av(t)$, where a is a damping constant
- we can model it as a hybrid system!

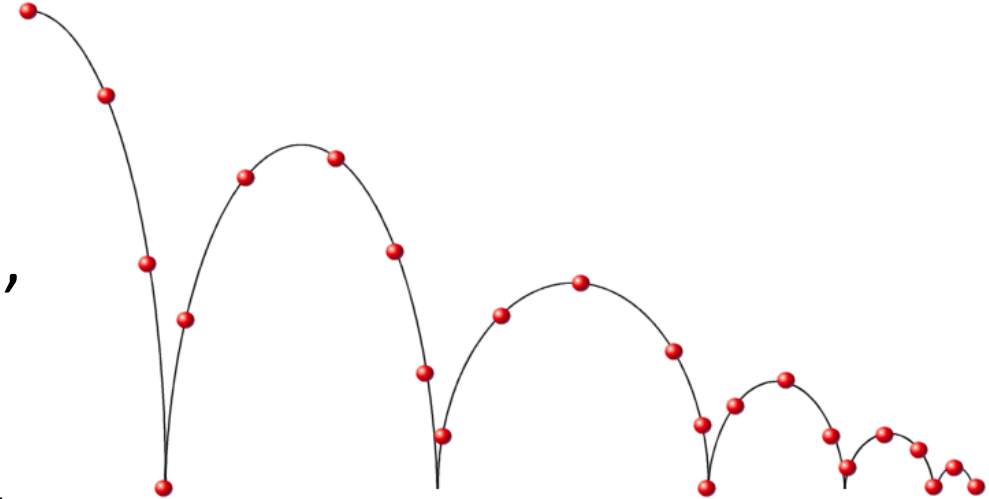

Hybrid Process for Bouncing ball

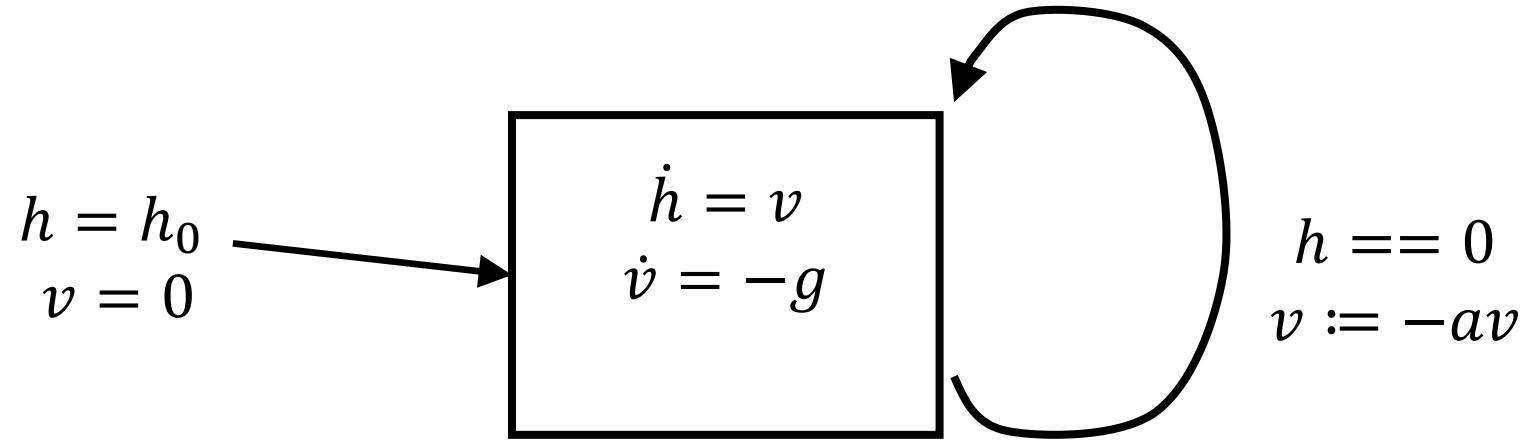

Non-Zeno hybrid process for bouncing ball

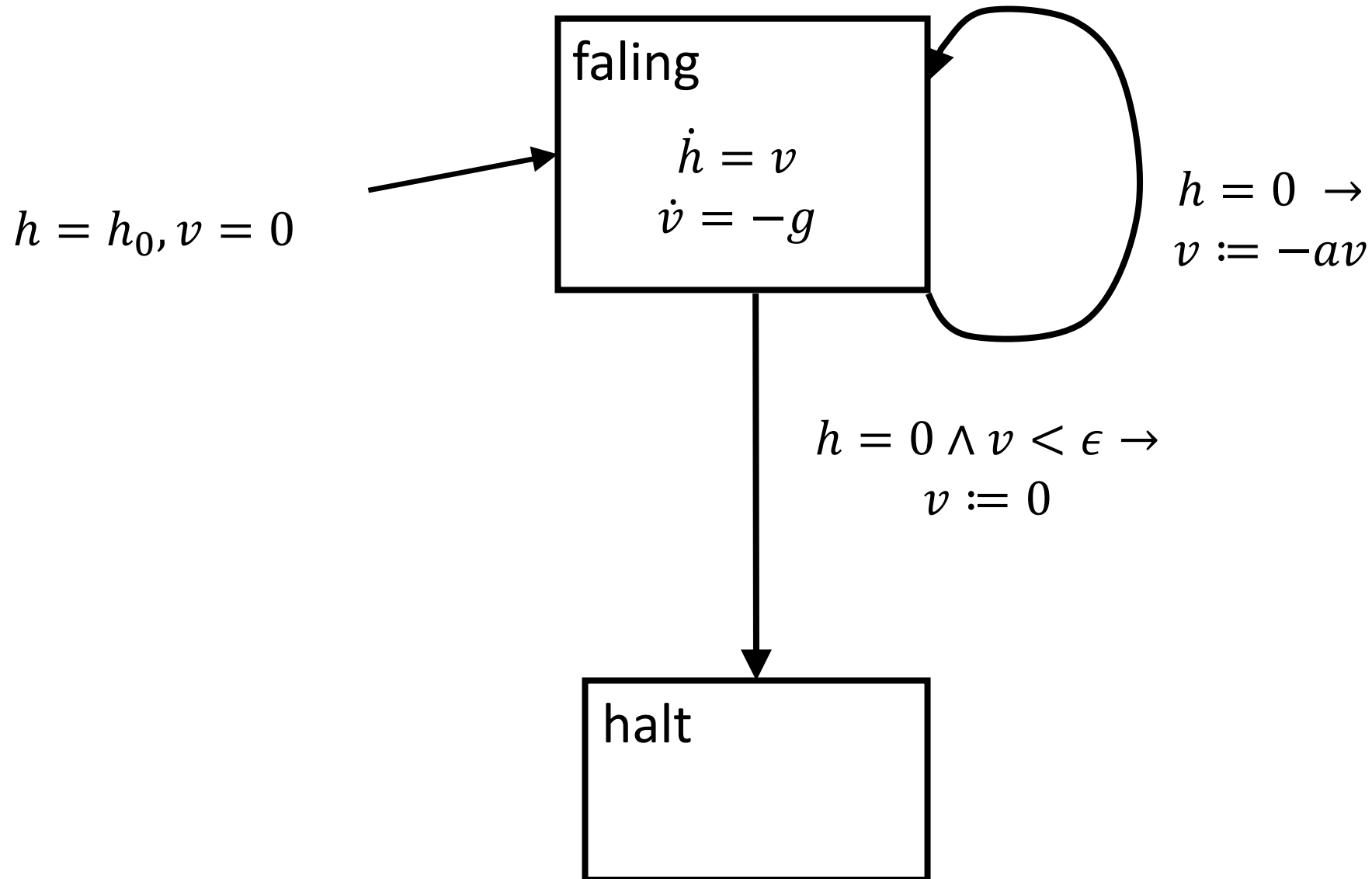

Hybrid Process for Bouncing ball

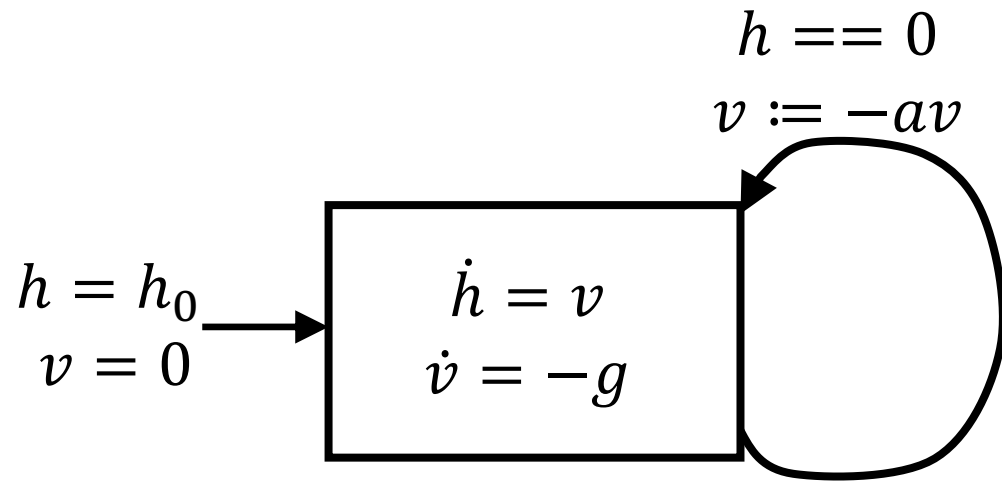

What happens as $h \rightarrow 0$?

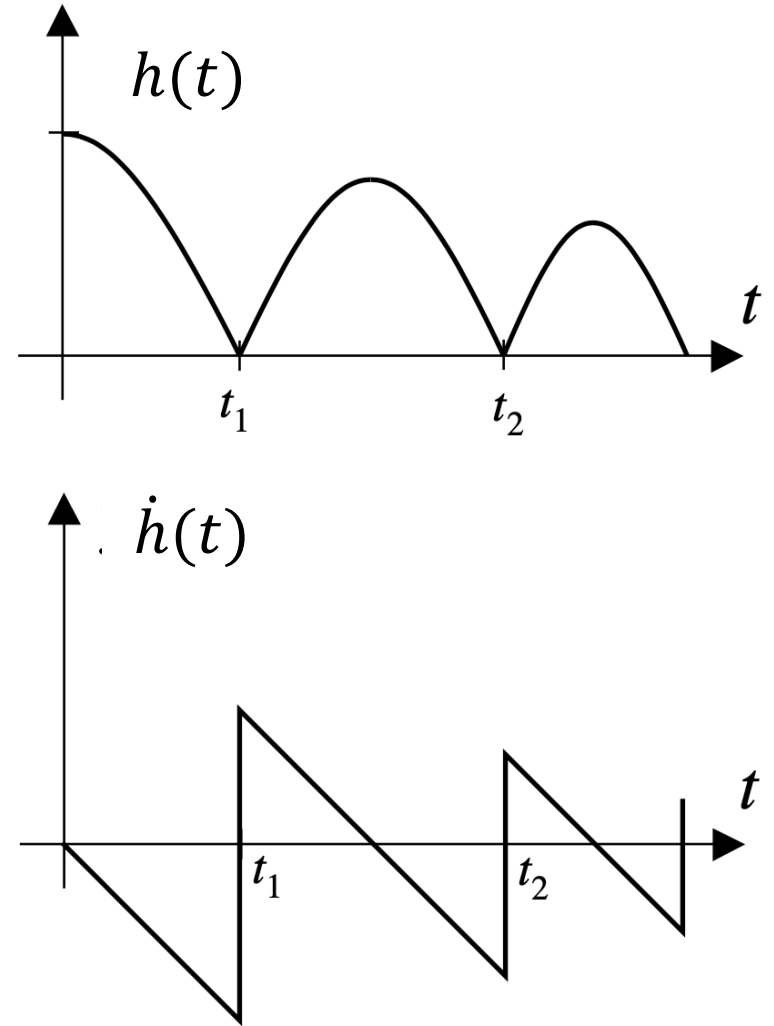

Hybrid Time Set

A hybrid time set is a finite or infinite sequence of intervals

$$\tau = \{I_i, i = 0, \dots, M\}:$$

- $I_i = [\tau_i, \tau'_i]$ for $i < M$
- $I_M = [\tau_M, \tau'_M]$ or $I_M = [\tau_M, \tau'_M)$ if $M < \infty$
- $\tau'_i = \tau_{i+1}$
- $\tau_i \leq \tau'_i$

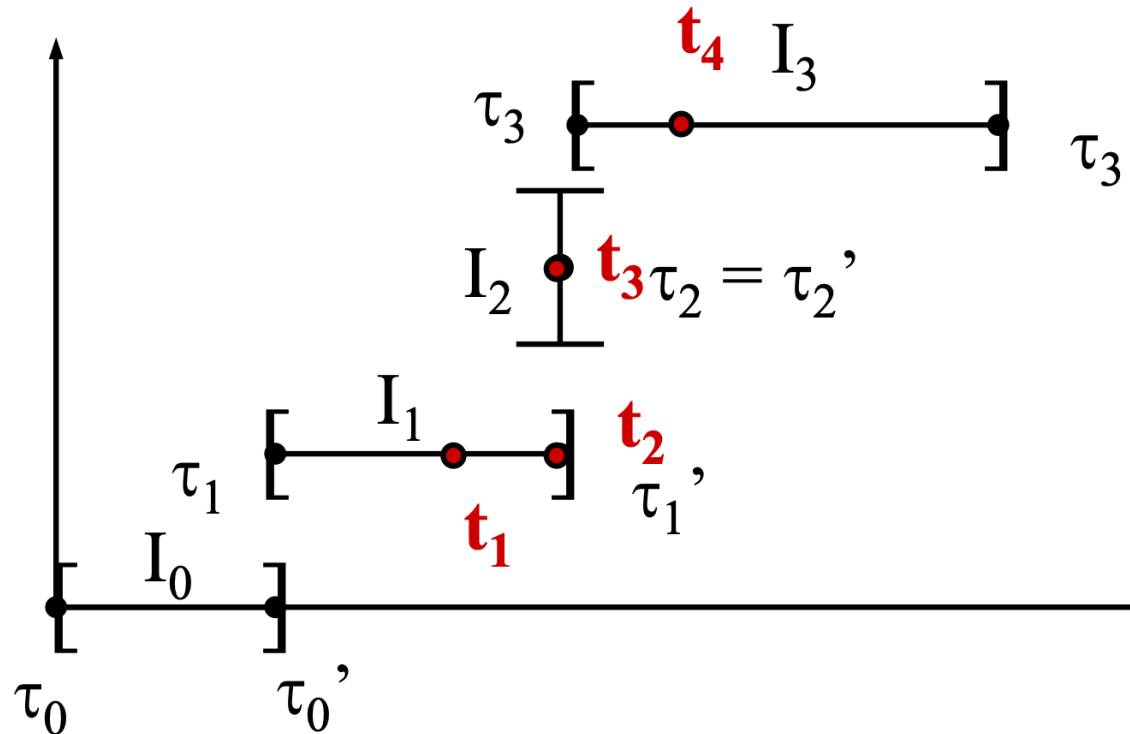

$$t_1 < t_2 < t_3 < t_4$$

time instants in τ are linearly ordered

Hybrid Time Set: Length

Two notions of length for a hybrid time set $\tau = \{I_i, i = 0, \dots, M\}$:

- Discrete extent: $\langle \tau \rangle = M + 1$ number of discrete transition
- Continuous extent: $\|\tau\| = \sum_{i=0}^M |\tau'_i - \tau_i|$ total duration of interval in τ

$$\langle \tau \rangle = 4$$
$$\|\tau\| = \tau_3' - \tau_0$$

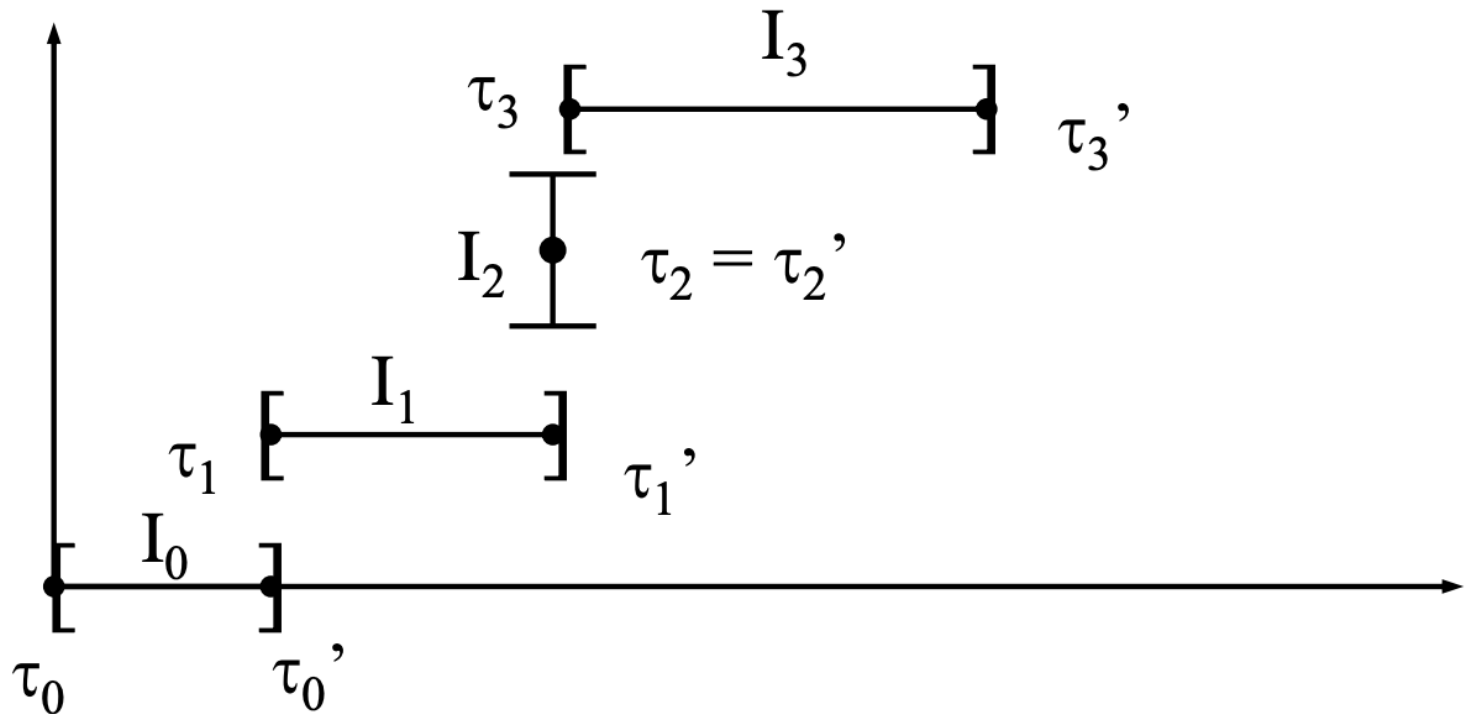

Hybrid Time Set: Classification

A hybrid set $\tau = \{I_i, i = 0, \dots, M\}$ is :

- Finite: if $\langle \tau \rangle$ is finite and $I_M = [\tau_M, \tau'_M]$
- Infinite: if $||\tau||$ is infinite
- Zeno: if $\langle \tau \rangle$ is infinite but $||\tau||$ is finite

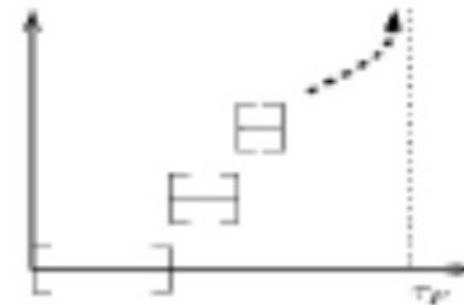
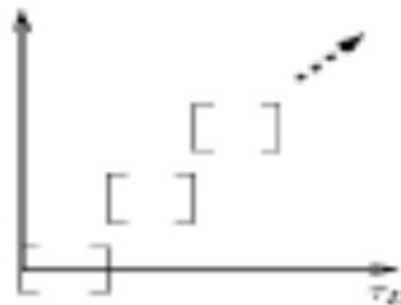
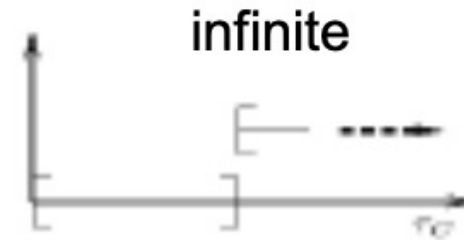
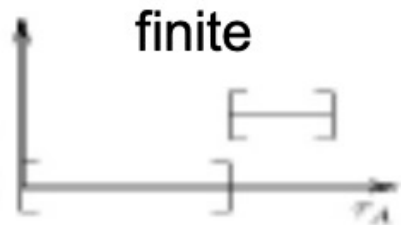

infinite

Zeno

Zeno

Zeno's Paradox

- ▶ Described by Greek philosopher Zeno in context of a race between Achilles and a tortoise
- ▶ Tortoise has a head start over Achilles, but is much slower
- ▶ In each discrete round, suppose Achilles is d meters behind at the beginning of the round
- ▶ During the round, Achilles runs d meters, but by then, tortoise has moved a little bit further
- ▶ At the beginning of the next round, Achilles is still behind, by a distance of $a \times d$ meters, where a is a fraction $0 < a < 1$
- ▶ By induction, if we repeat this for infinitely many rounds, Achilles will never catch up!

(Linear) Hybrid Automata

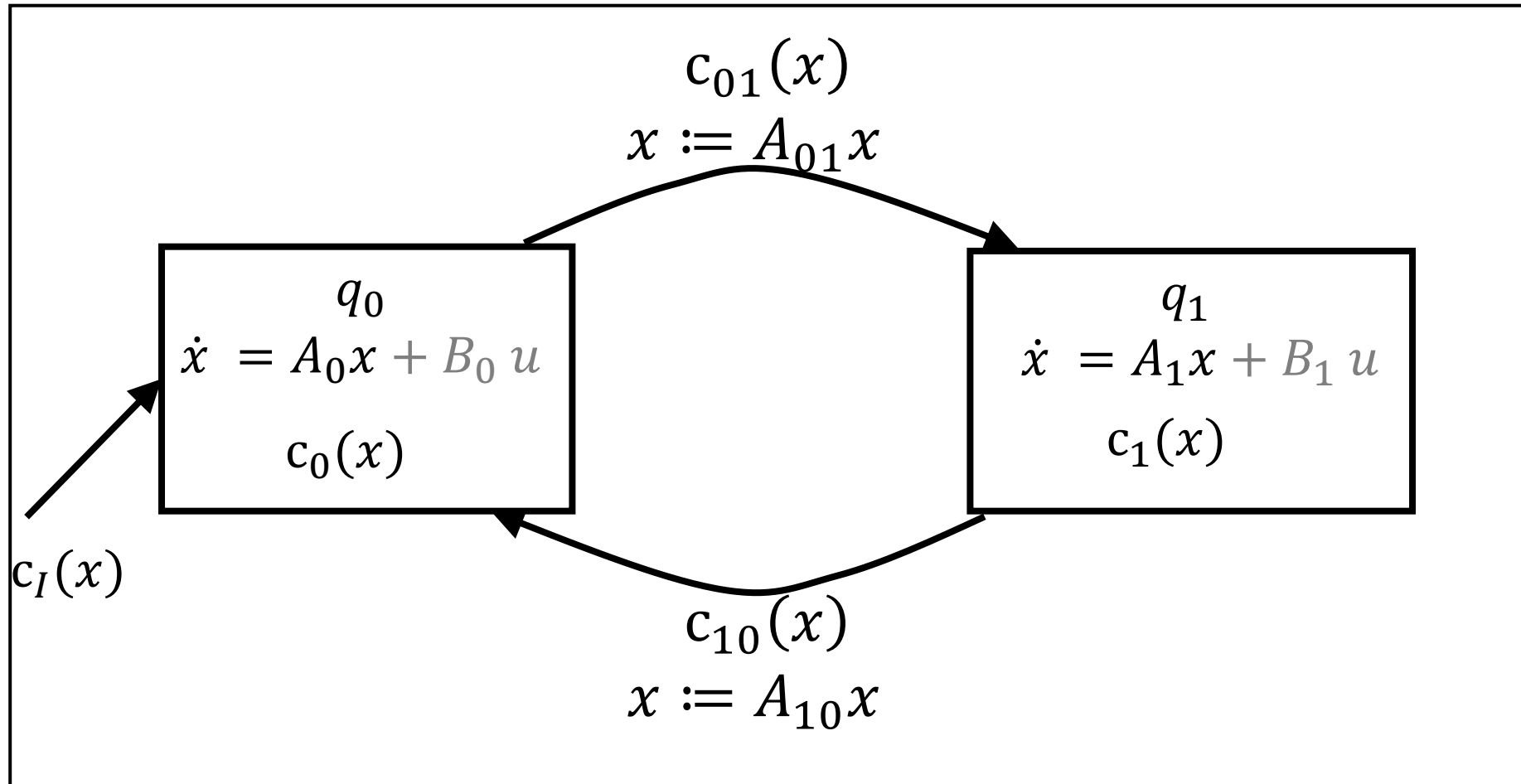

(Linear) Hybrid Automata

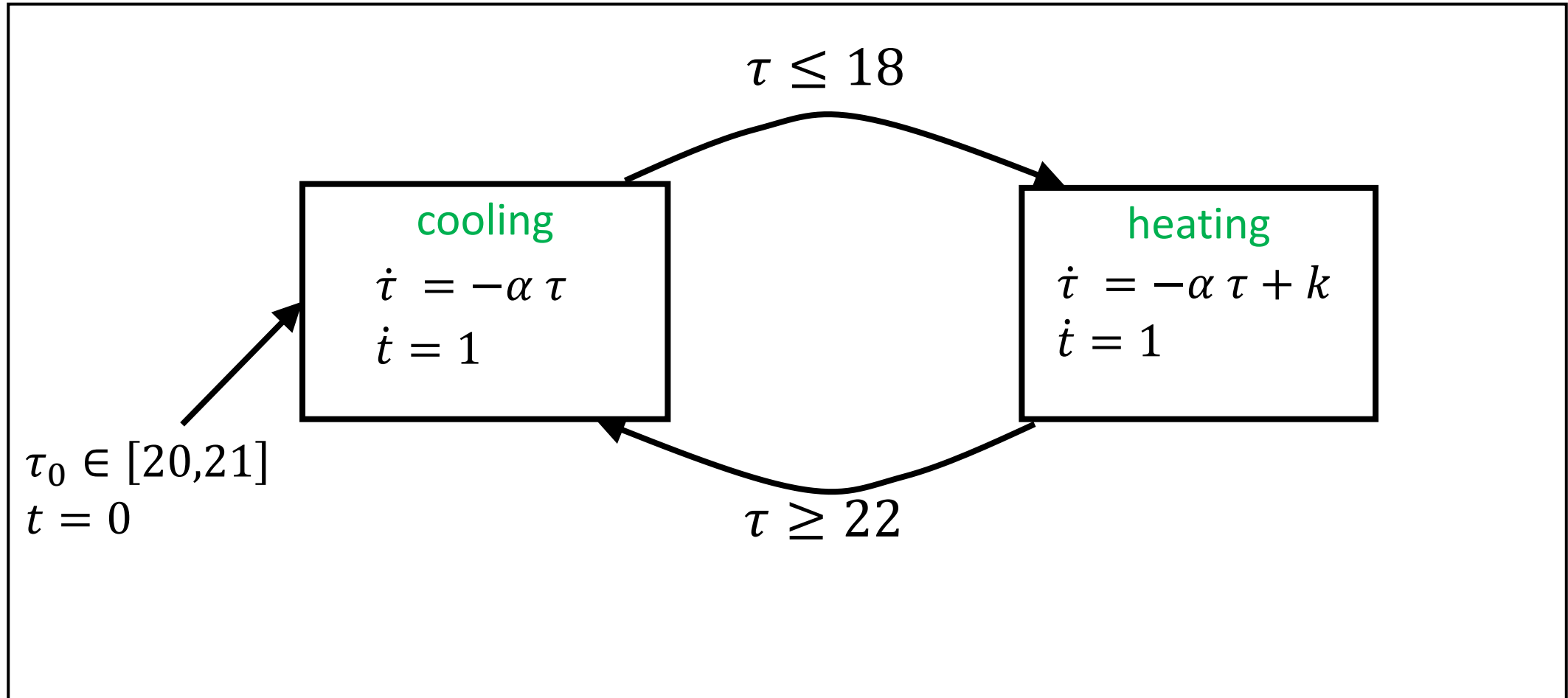

Hybrid actions/transitions

$$(q, \mathbf{x}_\tau) \xrightarrow{\mathbf{u}(t)/\mathbf{y}(t)}_{\delta} (q, \mathbf{x}(t + \delta))$$

► Continuous action/transition:

- Discrete mode m does not change
- $\mathbf{x}_\tau = \mathbf{x}(0)$
- $\frac{d\mathbf{x}(t)}{dt}$ satisfies the given dynamical equation for mode m
- Output \mathbf{y} satisfies the output equation for mode m : $\mathbf{y}(t) = h_q(\mathbf{x}(t), \mathbf{u}(t))$
- At all times $t \in [0, \delta]$, the state $\mathbf{x}(t)$ satisfies the invariant for mode m

Hybrid actions/transitions

$$(q, \mathbf{x}_\tau) \xrightarrow{g(\mathbf{x})/\mathbf{x} := r(\mathbf{x})} (q', r(\mathbf{x}_\tau))$$

► Discrete action/transition:

- Happens instantaneously
- Changes discrete mode q to q'
- Can execute only if $g(\mathbf{x}_\tau)$ evaluates to true
- Changes state variable value from \mathbf{x}_τ to $r(\mathbf{x}_\tau)$
- $r(\mathbf{x}_\tau)$ should satisfy mode invariant of q' Output will change from $h_q(\mathbf{x}_\tau)$ to $h_{q'}(r(\mathbf{x}_\tau))$

Pacemaker Modeling as a Timed Process

- ▶ Most material that follows is from this paper:

Z. Jiang, M. Pajic, S. Moarref, R. Alur, R. Mangharam, *Modeling and Verification of a Dual Chamber Implantable Pacemaker*, In Proceedings of Tools and Algorithms for the Construction and Analysis of Systems (TACAS), 2012.

- ▶ The textbook has detailed descriptions of some other pacemaker components

How does a healthy heart work?

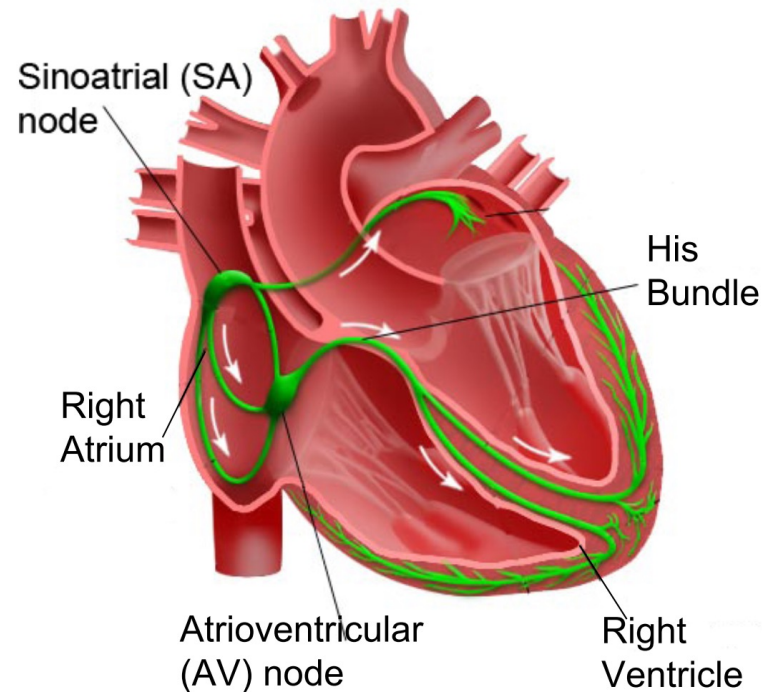

Electrical Conduction System of the Heart

- ▶ SA node (controlled by nervous system) periodically generates an electric pulse
- ▶ This pulse causes both atria to contract pushing blood into the ventricles
- ▶ Conduction is delayed at the AV node allowing ventricles to fill
- ▶ Finally the His-Pukinje system spreads electric activation through ventricles causing them both to contract, pumping blood out of the heart

What do pacemakers do?

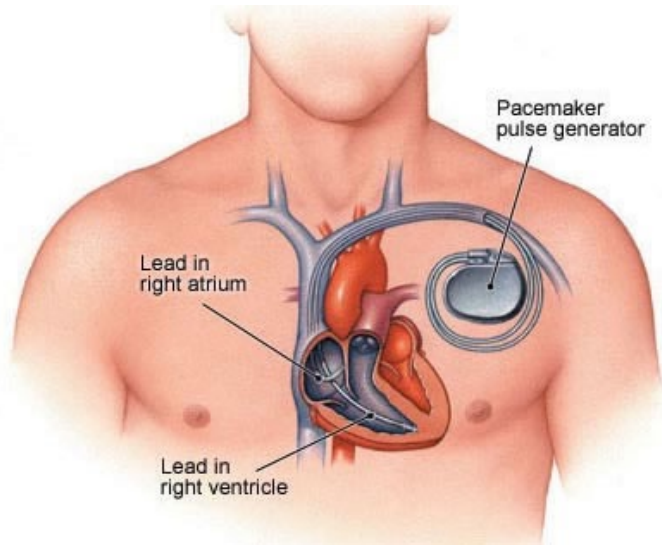

- ▶ Aging and/or diseases cause conduction properties of heart tissue to change leading to changes in heart rhythm
- ▶ Tachycardia: faster than desirable heart rate impairing hemo-dynamics (blood flow dynamics)
- ▶ Bradycardia: slower heart rate leading to insufficient blood supply
- ▶ Pacemakers can be used to treat bradycardia by providing pulses when heart rate is low

Implantable Pacemaker modeling

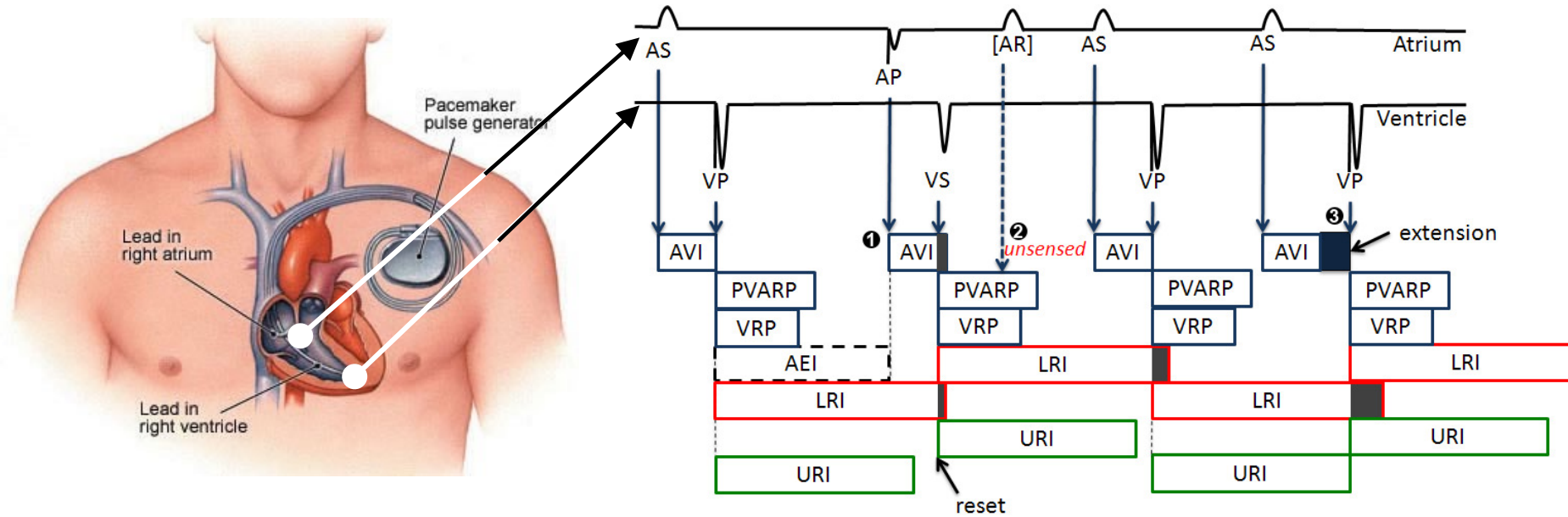

How dual-chamber pacemakers work

- ▶ Two fixed leads on wall of right atrium and ventricle respectively
- ▶ Activation of local tissue sensed by the leads (giving rise to events Atrial Sense (AS) and Ventricular Sense (VS))
- ▶ Atrial Pacing (AP) or Ventricular Pacing (VP) are delivered if no sensed events occur within deadlines

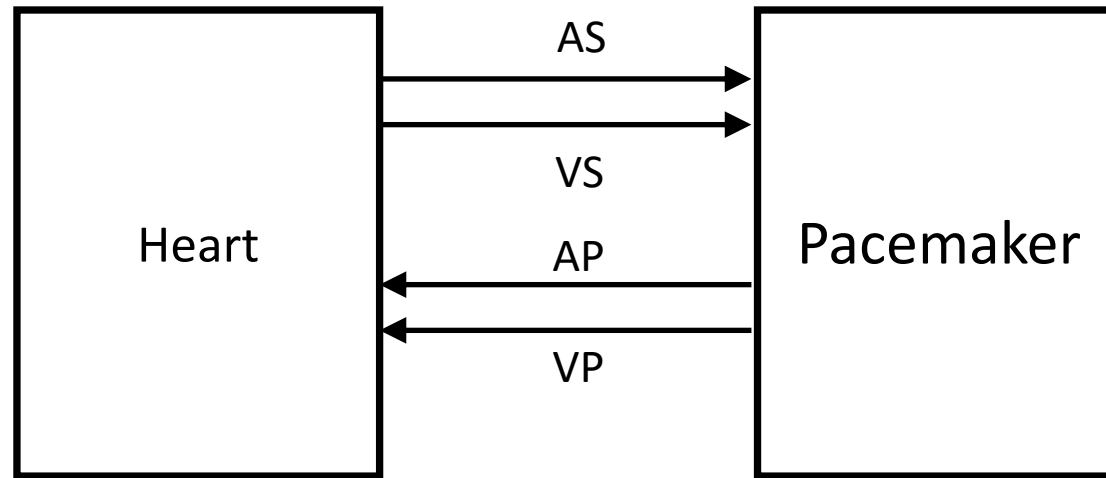

The Lower Rate Interval (LRI) mode

LRI component keeps heart rate above minimum level

- ▶ Measures the longest interval between ventricular events
- ▶ Clock reset when VS or VP received
- ▶ No AS received \Rightarrow LRI outputs AP after K time units

The Lower Rate Interval (LRI) mode

LRI component keeps heart rate above minimum level

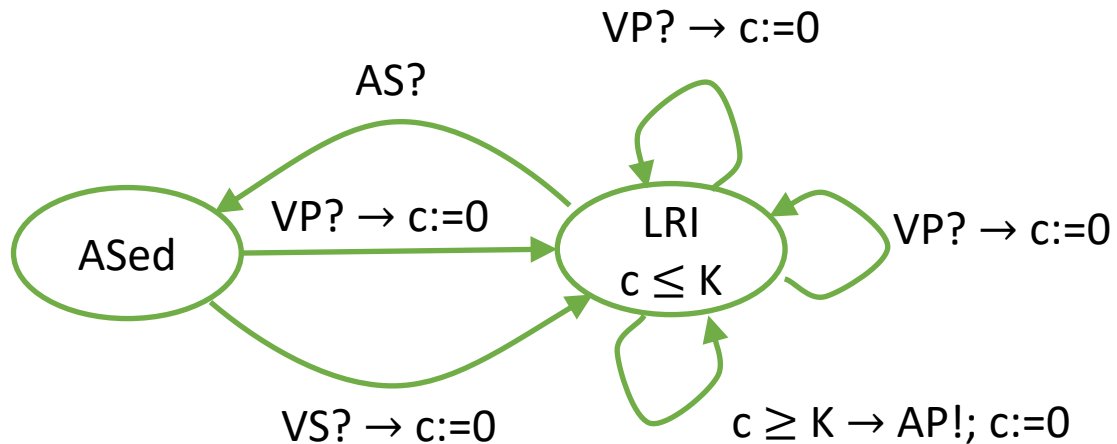

K= 850ms

- ▶ Measures the longest interval between ventricular events
- ▶ Clock reset when VS or VP received
- ▶ No AS received \Rightarrow LRI outputs AP after K time units

Translated into Stateflow charts in Simulink for test generation and code generation :

Pajic, M., Jiang, Z., Sokolsky, O., Lee, I., Mangharam, R.: From Verification to Implementation: A Model Translation Tool and a Pacemaker Case Study. In: 18th IEEE Real-Time and Embedded Technology and Applications Symposium, IEEE RTAS (2012).

Design Application: Autonomous Guided Vehicle

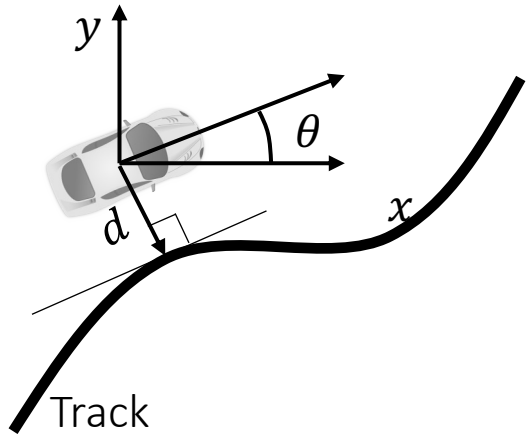

When $d \in [-\epsilon, +\epsilon]$, controller decides that vehicle goes straight, otherwise executes a turn command to bring error back in the interval

- ▶ Objective: Steer vehicle to follow a given track
- ▶ Control inputs: linear speed (v), angular speed (ω), start/stop
- ▶ Constraints on control inputs:
 - ▶ $v \in \{v_{\max}, v_{\max}/2, 0\}$
 - ▶ $\omega \in \{-\pi, 0, \pi\}$
- ▶ Designer choice: $v = v_{\max}$ only if $\omega = 0$, otherwise $v = \frac{v_{\max}}{2}$

On/Off control for Path following

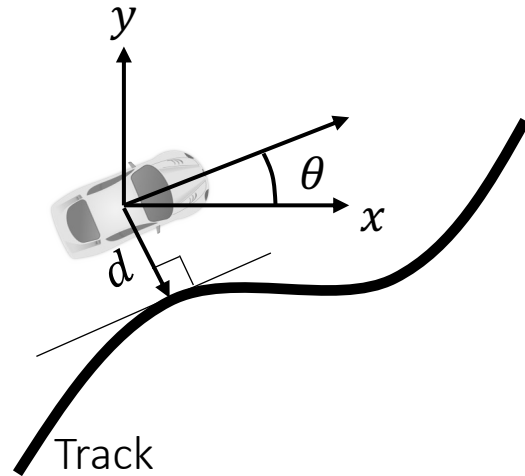
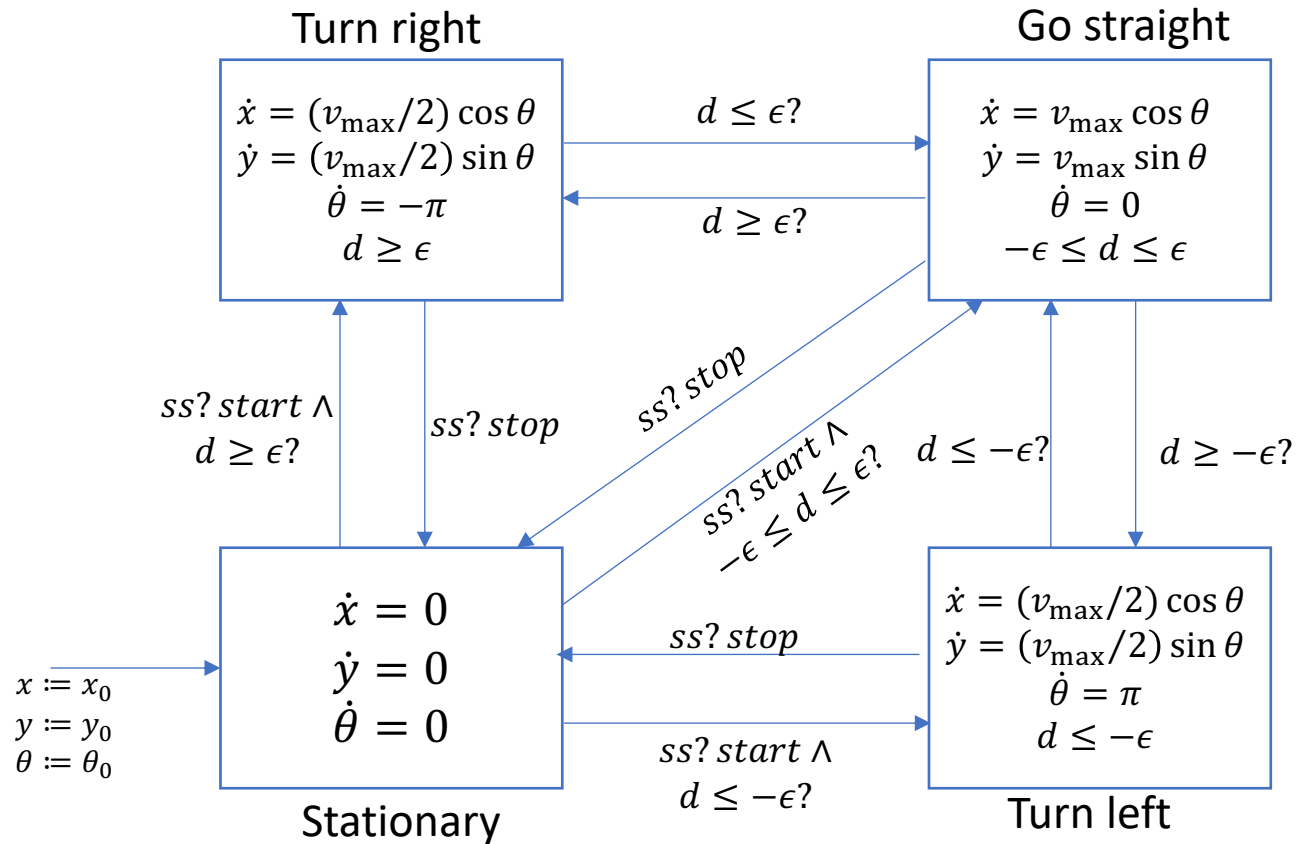

Inputs: $ss \in \{stop, start\}, d \in \mathbb{R}$

On/Off control for Path following

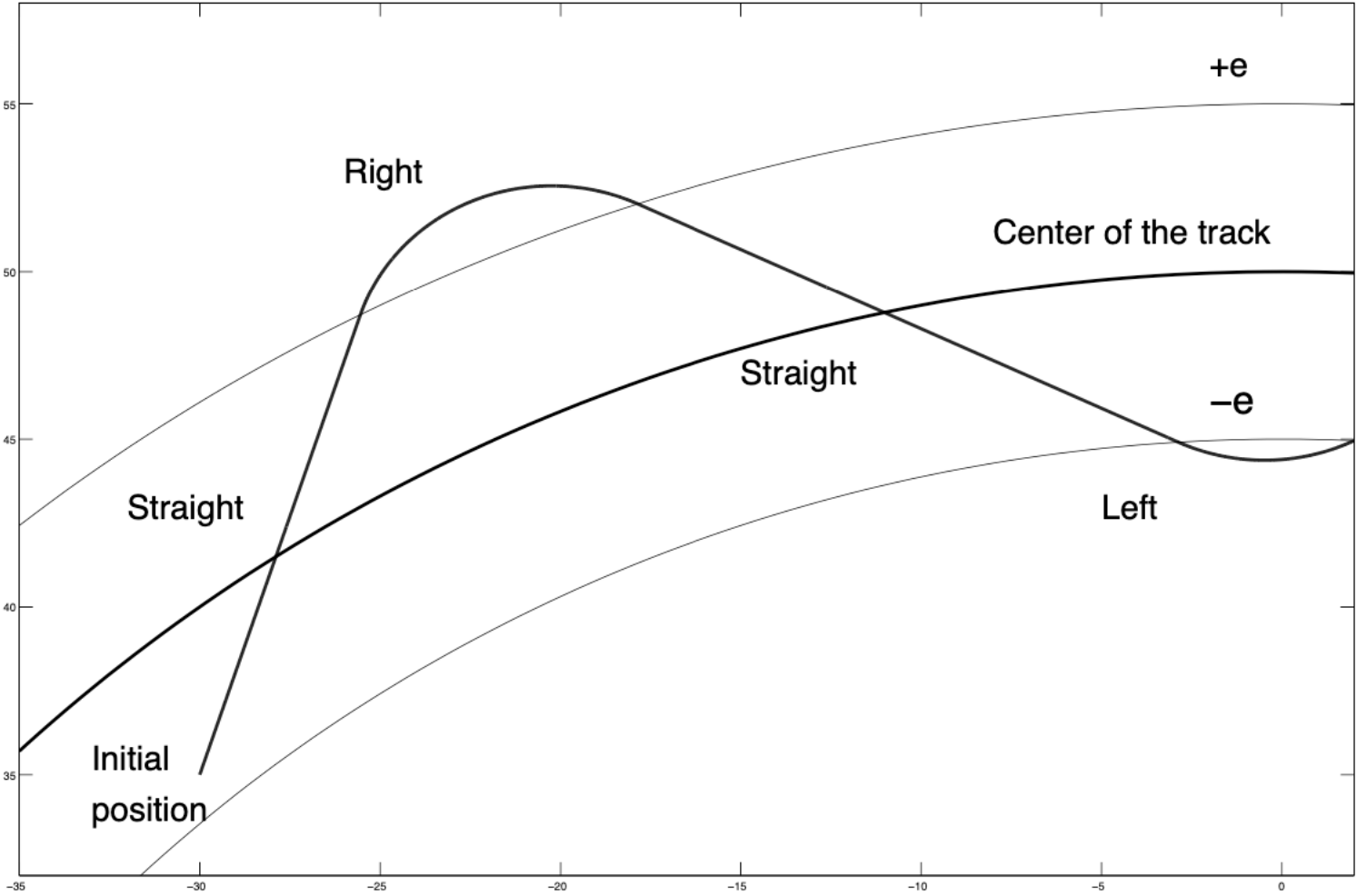

Design Application: Robot Coordination

- ▶ Autonomous mobile robots in a room, goal for each robot:
 - ▶ Reach a target at a known location
 - ▶ Avoid obstacles (positions not known in advance)
 - ▶ Minimize distance travelled
- ▶ Design Problems:
 - ▶ Cameras/vision systems can provide estimates of obstacle positions
 - ▶ When should a robot update its estimate of the obstacle position?
 - ▶ Robots can communicate with each other
 - ▶ How often and what information can they communicate?
 - ▶ High-level motion planning
 - ▶ What path in the speed/direction-space should the robots traverse?

Path planning with obstacle avoidance

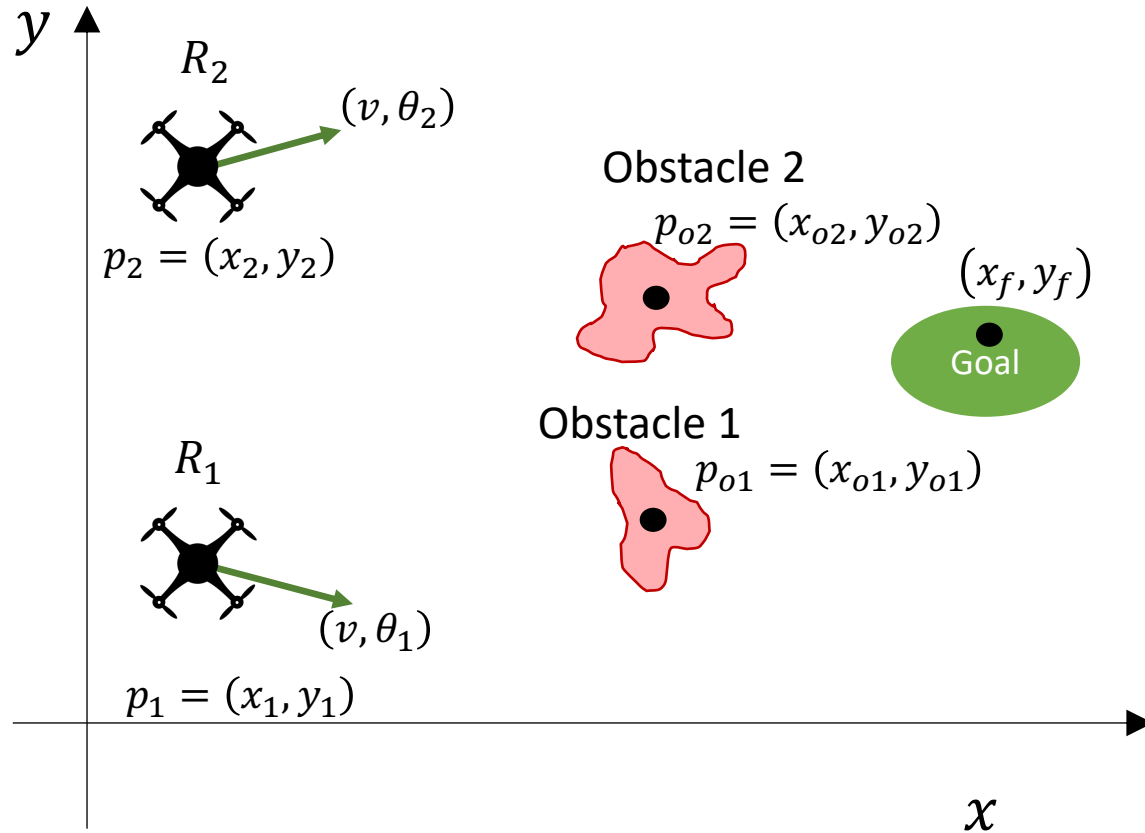

- ▶ Assumptions:
 - ▶ Two-dimensional world
 - ▶ Robots are just points
 - ▶ Each robot travels with a fixed speed
- ▶ Dynamics for Robot R_i :
 - ▶ $\dot{x}_i = v \cos \theta_i$; $\dot{y}_i = v \sin \theta_i$
- ▶ Design objectives:
 - ▶ Eventually reach (x_f, y_f)
 - ▶ Always avoid Obstacle 1 and Obstacle 2
 - ▶ Minimize distance travelled

Divide path/motion planning into two parts

1. Computer vision tasks
 2. Actual path planning task
- ▶ Assume computer vision algorithm identifies obstacles, and labels them with some easy-to-represent geometric shape (such as a bounding boxes)
 - ▶ In this example, we will assume a sonar-based sensor, so we will use circles
 - ▶ Assuming the vision algorithm is correct, do path planning based on the estimated shapes of obstacles
 - ▶ Design challenge:
 - ▶ Estimate of obstacle shape is not the smallest shape containing the obstacle
 - ▶ Shape estimate varies based on distance from obstacle

Estimation error

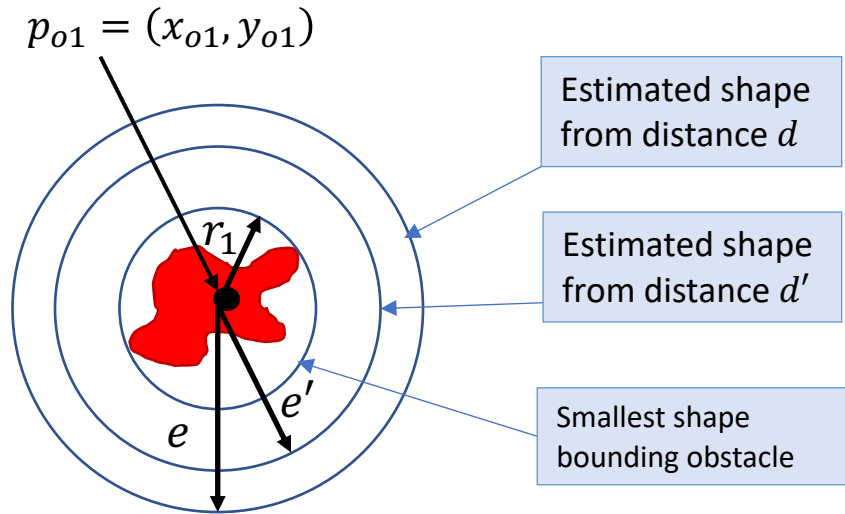

Estimated radius (from current distance d)

$$e = r + a(d - r),$$

where $a \in [0,1]$ is a constant

- ▶ Robot R_1 maintains radii e and e' that are estimates of obstacle sizes
- ▶ Every τ seconds, R_1 executes following update to get estimates of shapes of each obstacle:
$$e := \min(e, r_1 + a(\|p_1 - p_{o1}\| - r_1))$$
$$e' := \min(e', r_2 + a(\|p_1 - p_{o2}\| - r_2))$$
- ▶ Computation of R_2 is symmetric

Path planning

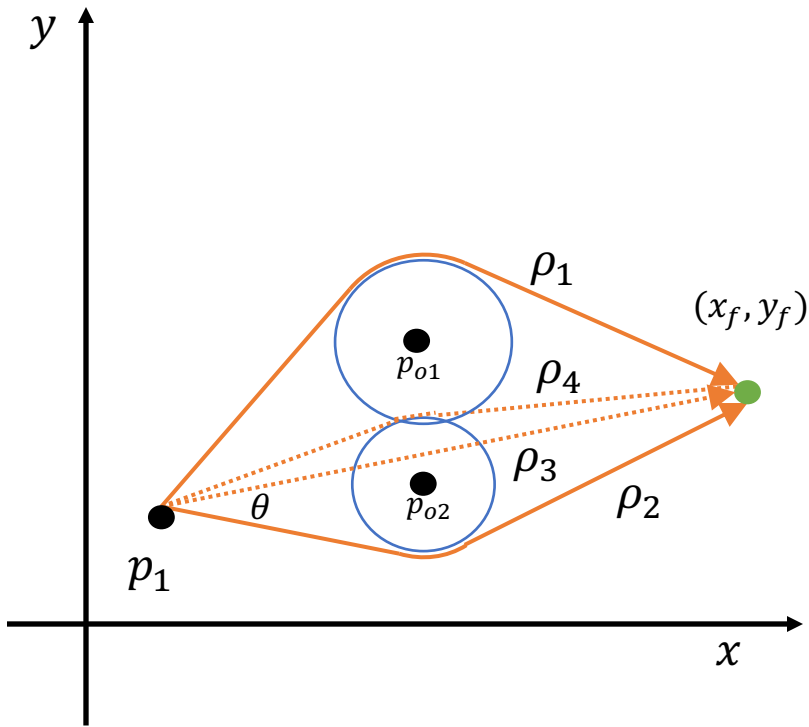

- ▶ Choose shortest path ρ_3 to target (to minimize time)
- ▶ If estimate of obstacle 1 intersects ρ_3 , calculate two paths that are tangent to obstacle 1 estimate
- ▶ If estimate of obstacle 2 intersects ρ_3 , or obstacle 1, calculate tangent paths
- ▶ Plausible paths: ρ_1 and ρ_2
- ▶ Calculate shorter one as the planned path

Dynamic path planning

- ▶ Path planning inputs:
 - ▶ Current position of robot
 - ▶ Target position
 - ▶ Position of obstacles and estimates
- ▶ Output:
 - ▶ Direction for motion assuming obstacle estimates are correct
- ▶ May be useful to execute planning algorithm again as robot moves!
 - ▶ Because estimates will improve closer to the obstacles
 - ▶ Invoke planning algorithm every τ seconds

Communication improves planning

- ▶ Every robot has its own estimate of the obstacle
- ▶ R_2 's estimate of obstacle might be better than R_1 's
- ▶ Strategy: every τ seconds, send estimates to other robot, and receive estimates
- ▶ For estimate e_i , use final estimate = $\min(e_i, e_i^{recv})$
- ▶ Re-run path planner

Improved path planning through communication

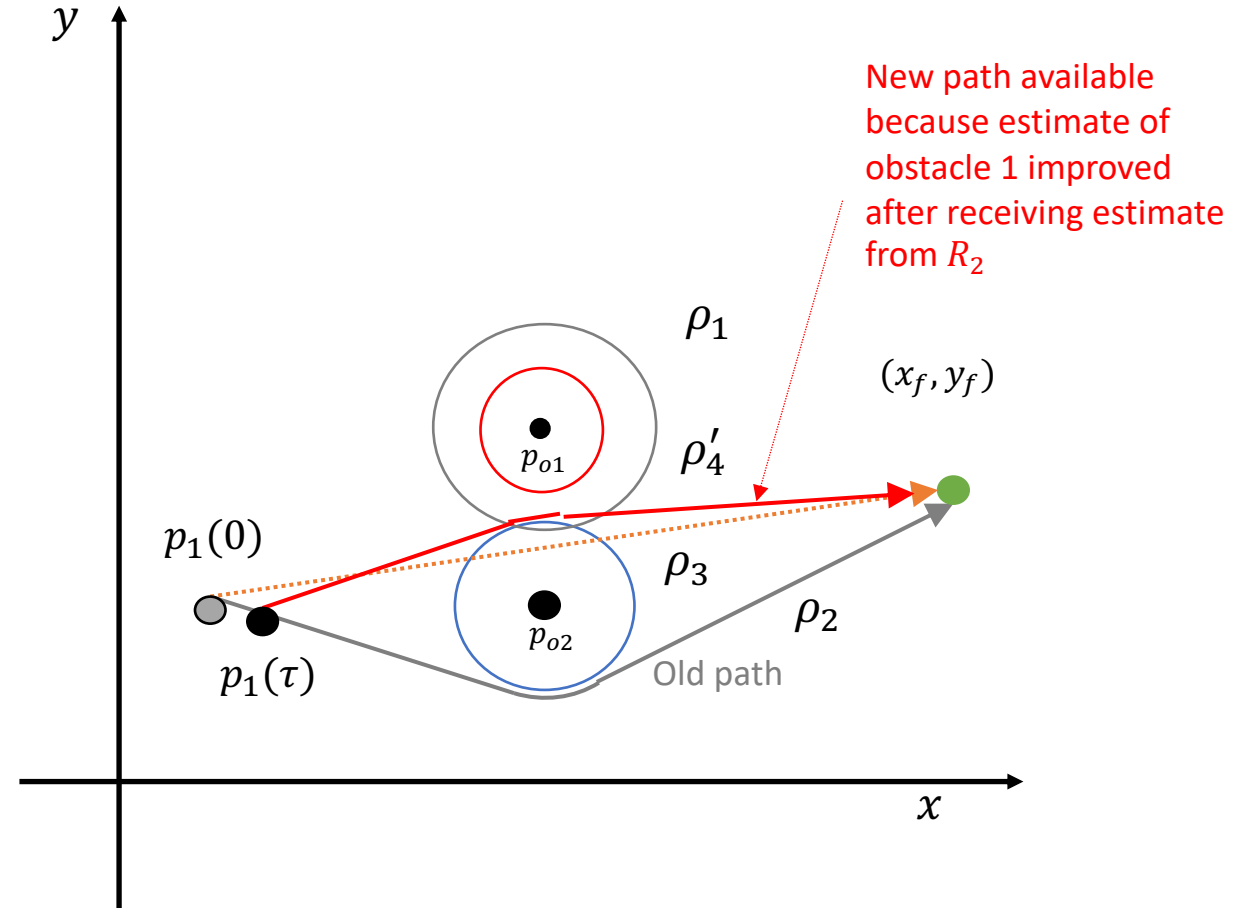
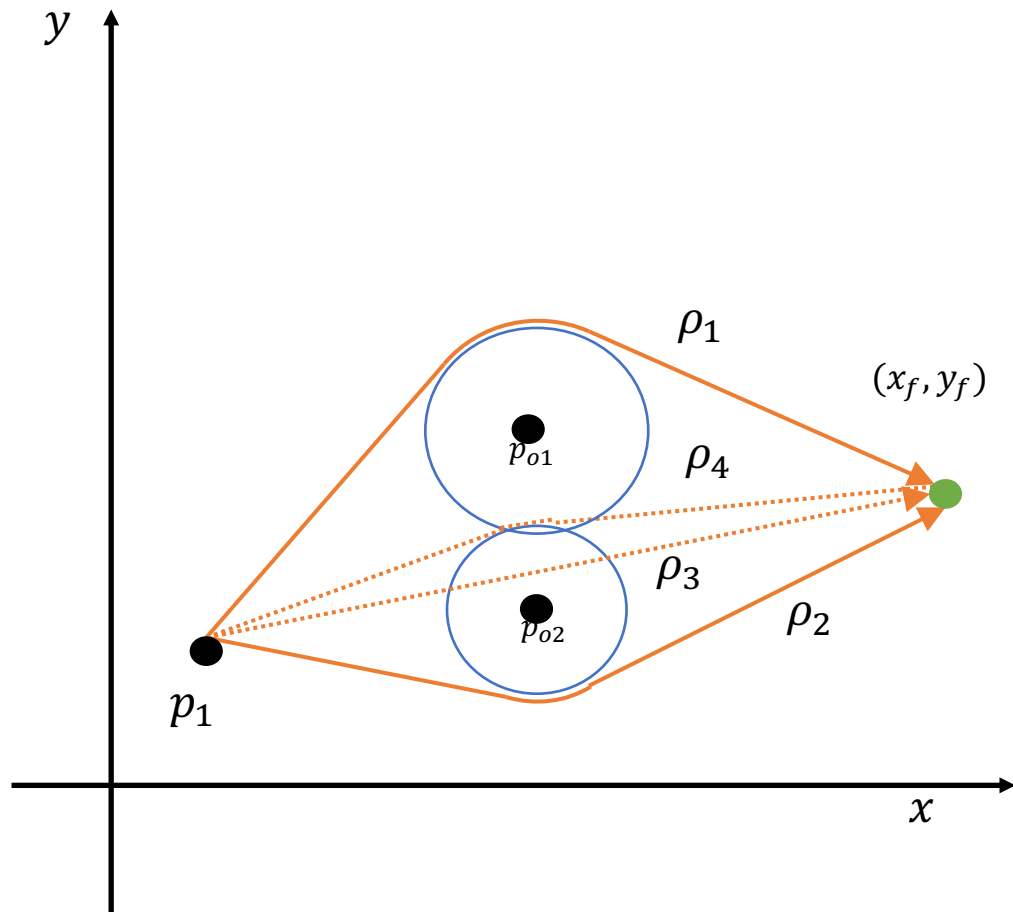

Hybrid State Machine for Communicating Robot

