

ESPERIENZA 5

Isomeria geometrica e isomeria ottica

I complessi di cobalto studiati

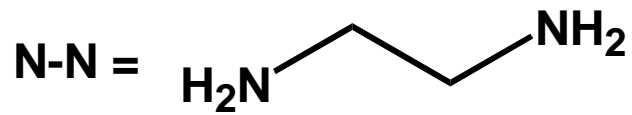
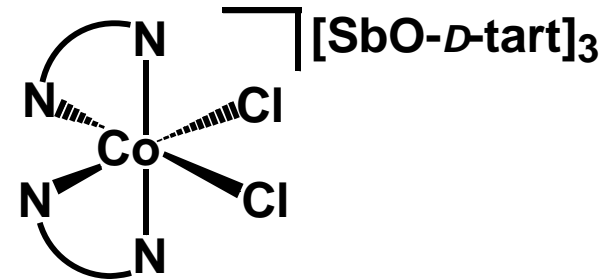
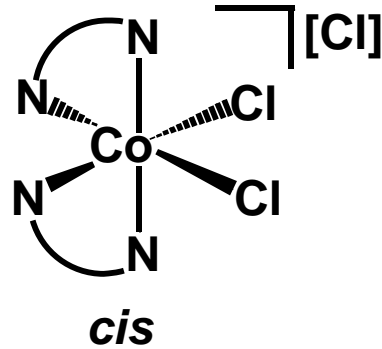
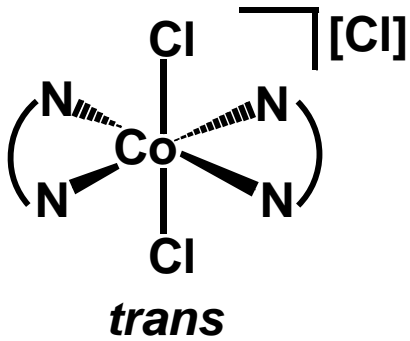

Sintesi di *trans*-[Co(Cl)₂(en)₂][Cl]

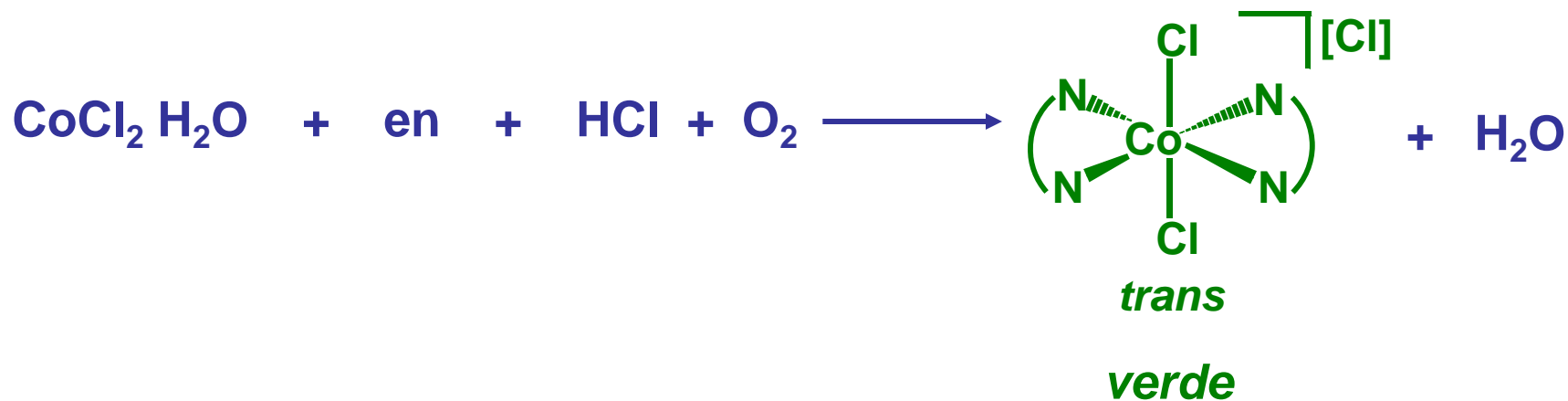

Da bilanciare

Sintesi di $cis\text{-}[\text{Co}(\text{Cl})_2(\text{en})_2][\text{Cl}]$

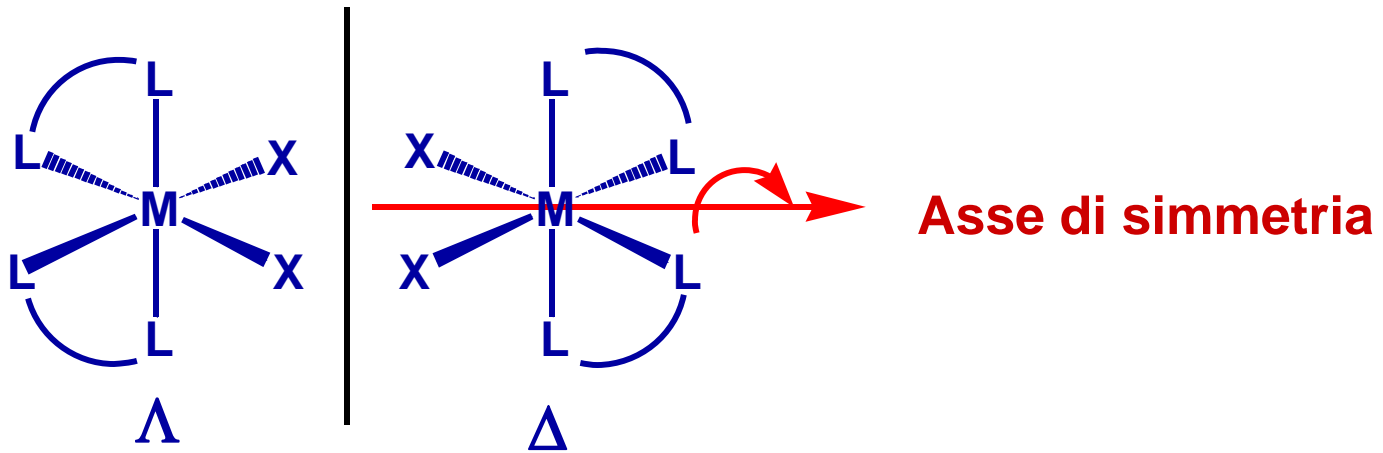
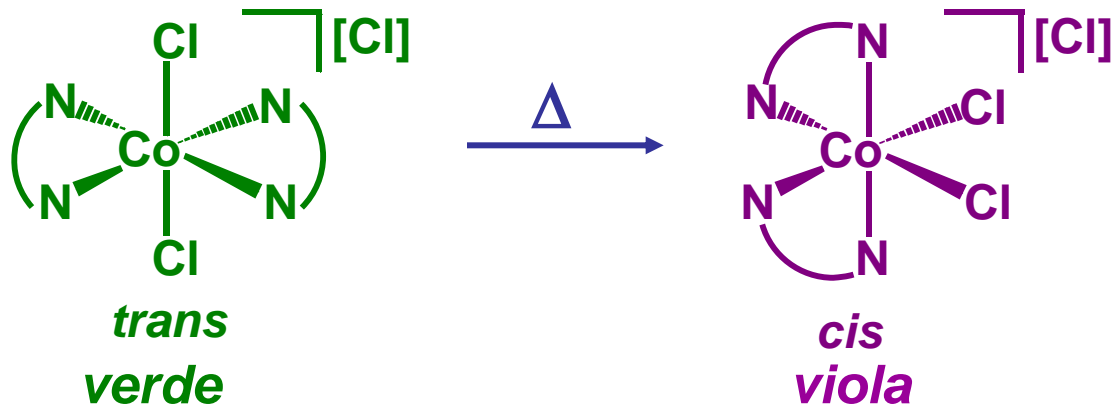

Separazione del *rac, cis*-[Co(Cl)₂(en)₂][Cl]
 nei suoi due enantiomeri

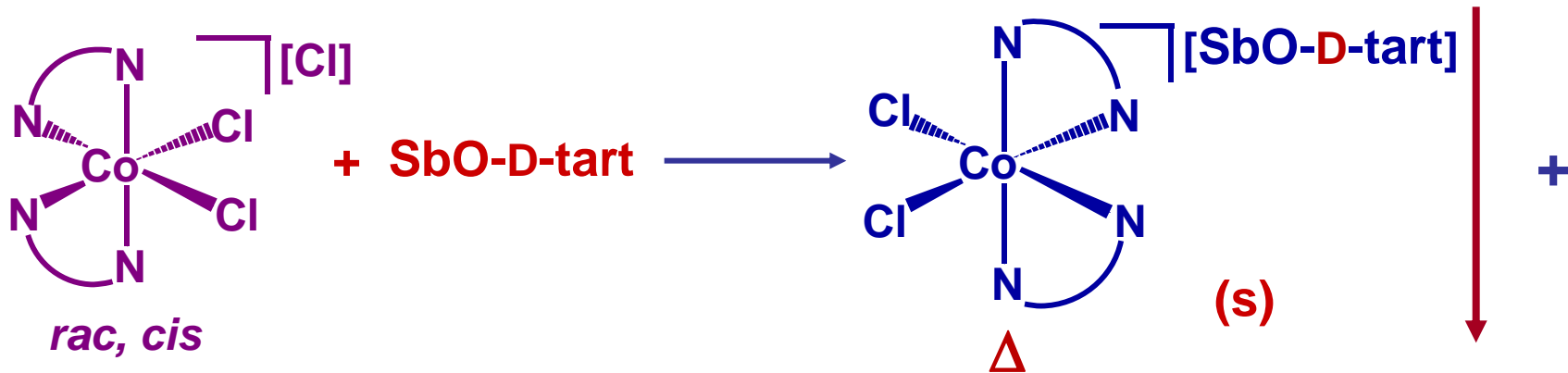

SbO-D-tart =

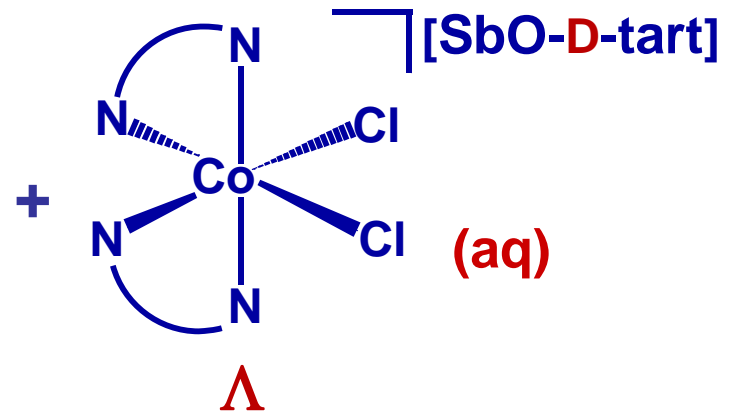
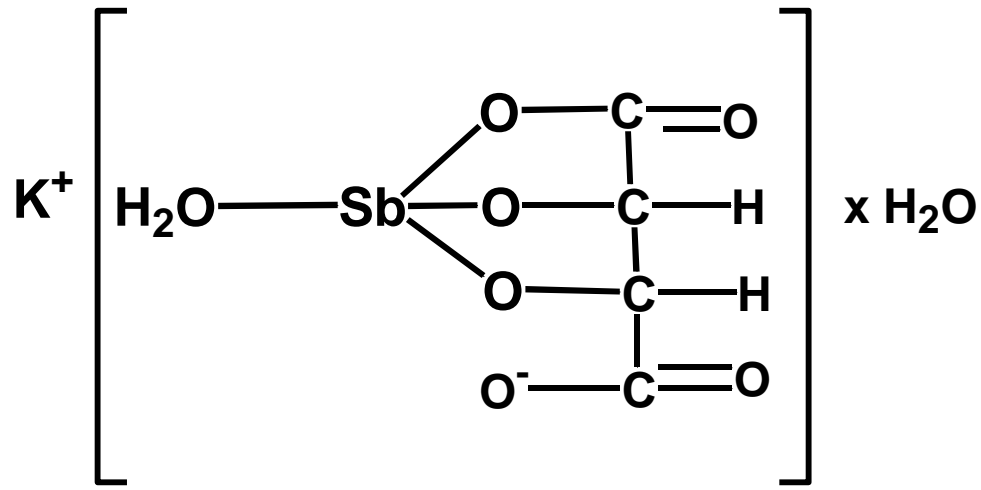

Accorgimenti sperimentali

LAVORARE RIGOROSAMENTE SOTTO CAPPAA!

Non chiudete mai la pompa ad acqua prima di aver staccato la provetta in cui avete fatto il vuoto: altrimenti rischiate che dell'acqua passi dalla pompa alla provetta anche se è presente il polmone!