

Number of papers about **NON** metallocenes catalysts¹

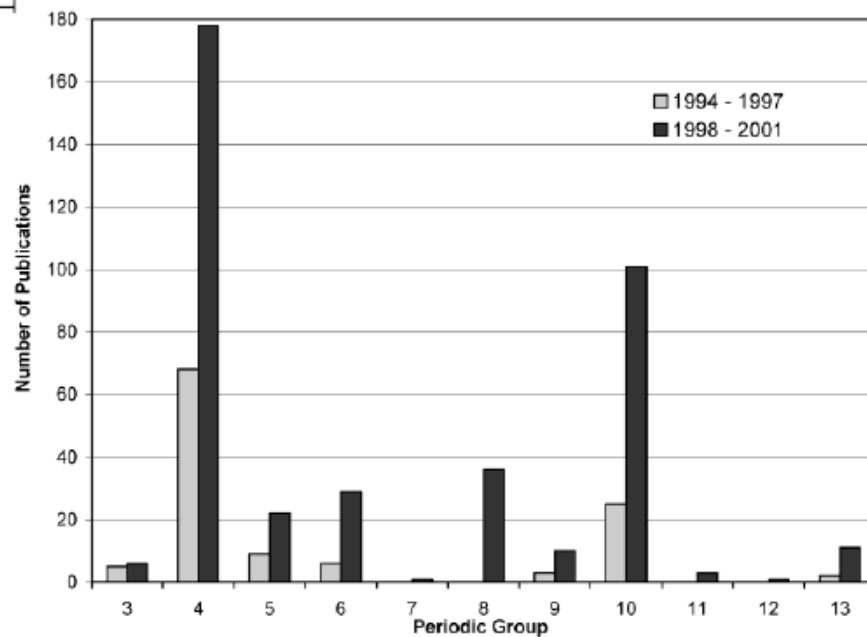
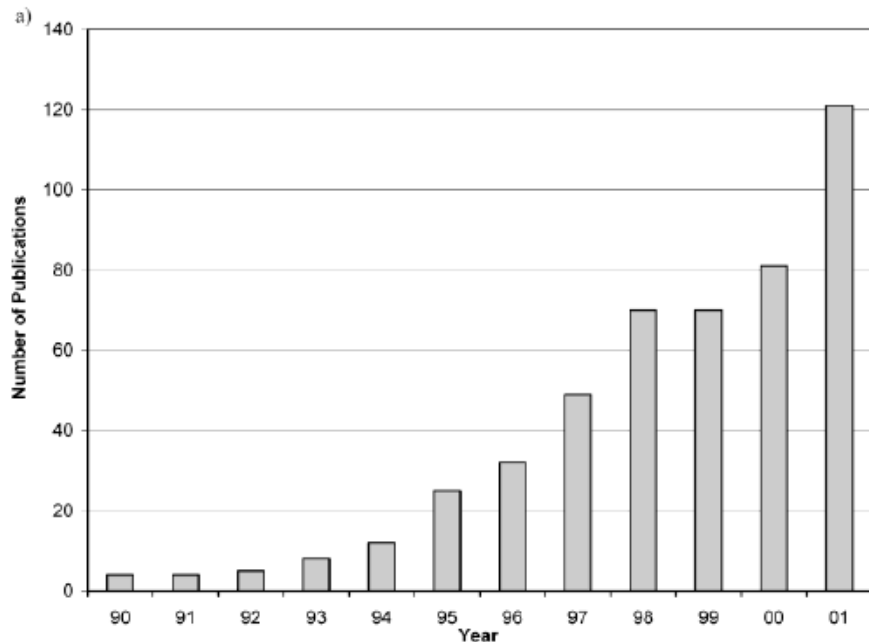

¹V. Gibson et al., *Chem. Rev.* **2003**, *103*, 285.

Pyridil-bis(immines) tridentate ligands for ethylene polymerization

Catalysts based on **Fe(II)** or **Co(II)**

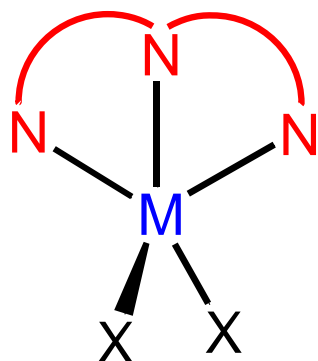

+ MAO

High density linear polyethylene

VERSIPOL (Du Pont)

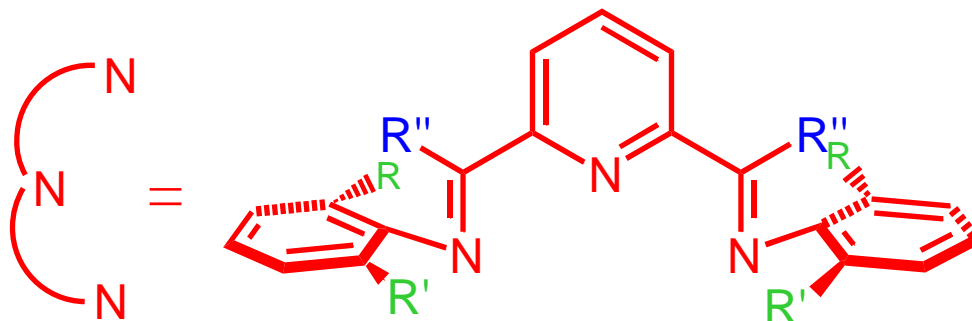

PBI

R = H **R' = Ph**

R = H **R' = C(CH₃)₃**

R = R' = HC(CH₃)₂

M. Brookhart et al. *J. Am. Chem. Soc.* **1998**, *120*, 4049.

V. C. Gibson et al. *Chem. Commun.* **1998**, 849.

S. D. Ittel, L.K. Johnson, M. Brookhart *Chem. Rev.* **2000**, *100*, 1169.

V. C. Gibson, S. K. Spitzmesser *Chem. Rev.* **2003**, *103*, 283.

Crystal structure of [Fe((2,6-*i*-Pr-Ph)₂PBIME₂)Cl₂]

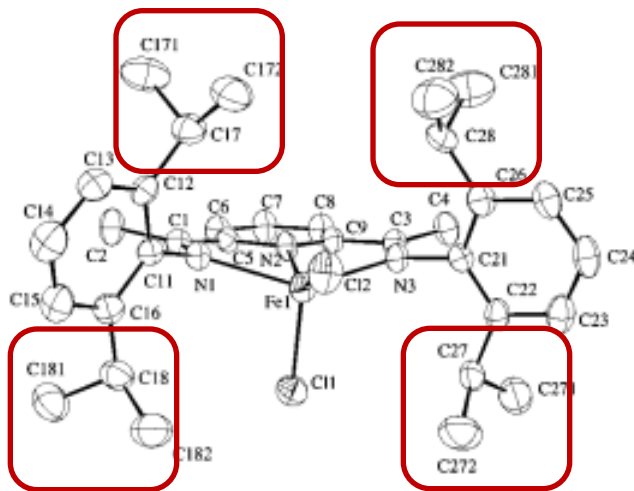

B. L. Small, M. Brookhart, A. M. A. Bennett J. Am. Chem. Soc. **1998**, 120, 4049.

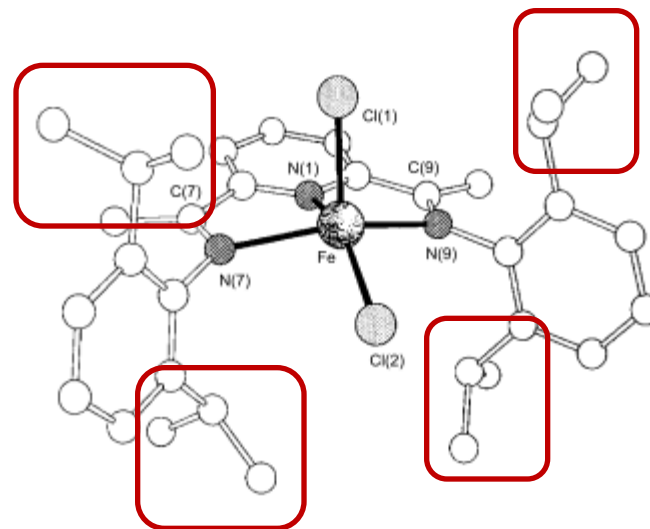

G. J. P. Britovsek, V. C. Gibson, B. S. Kimberley, P. J. Maddox, S. J. McTavish, G. A. Solan, A. J. P. White, D. J. Williams Chem. Commun. **1998**, 849.

Both complexes have a **pseudo-square-pyramidal** geometry with the **aryl rings** nearly **perpendicular** to the square plane.

They are paramagnetic, high-spin complexes.

Ethylene polymerization with catalysts based on Fe(II) or Co(II)¹

Effect of ethylene pressure

Cat. Prec.: $[\text{MCl}_2((2,6\text{-}i\text{-PrPh})_2\text{PBIH}_2)]$

M	P _{ethylene} (atm)	kg PE/g M h
Co	7	140
	41	140
Fe	7	1860
	41	4220
	340	11900

¹S. D. Ittel et al., *Chem. Rev.* **2000**, *100*, 1169.

Ethylene polymerization with catalysts based on Fe(II) or Co(II)¹

Effect of **nitrogen-donor ligand**

Cat. Prec.: [CoCl₂(PBI)]

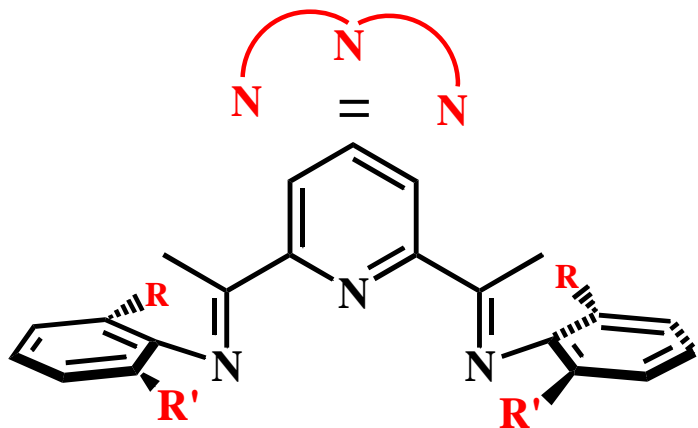

PBI	M _w
(2-PhPh) ₂ PBIME ₂	α-olefine
(2- <i>t</i> -BuPh) ₂ PBIME ₂	31 000
(2,6- <i>i</i> -PrPh) ₂ PBIME ₂	46 000
(2,6- <i>i</i> -PrPh) ₂ PBIH ₂	18 000

¹S. D. Ittel et al., *Chem. Rev.* **2000**, *100*, 1169.

α -diimines bidentate ligands for ethylene polymerization

Catalysts based on Ni(II) or Pd(II)

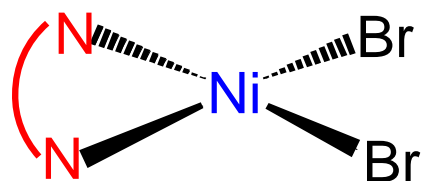

+ MAO

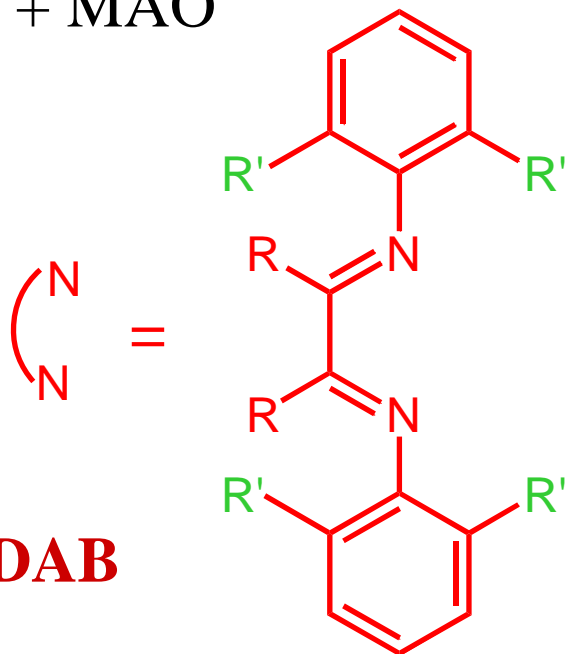
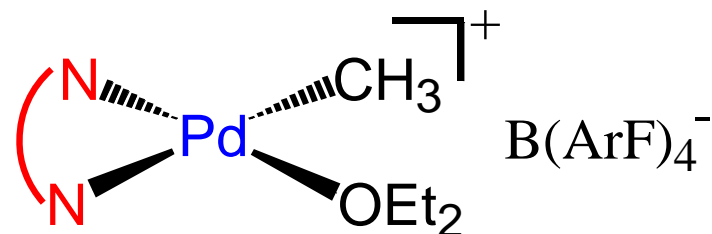

$R = H, CH_3$

$R' = H, CH_3, HC(CH_3)_2$

VERSIPOL (Du Pont)

¹M. Brookhart et al., *J. Am. Chem. Soc.* **1995**, *117*, 6414.

²S. D. Ittel et al., *Chem. Rev.* **2000**, *100*, 1169.

Ethylene polymerization with **Pd(II)** catalysts

Effect of **precatalyst**

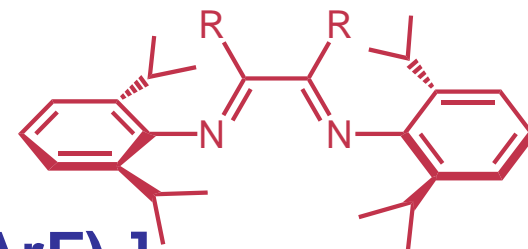

Cat. Prec.: [**PdMe(OEt₂)(i-Pr-DABR)**][**B(ArF)₄**]

R	Yield (g)	kg PE/mol Pd h	Mw (Mw/Mn)	Branches per 1000 carbons
H^a	9.07	4.0	600 (3.0)	116
Me^b	45.3	26.6	29000 (3.9)	103

Reaction conditions: $n_{\text{cat}} = 100 \mu\text{mol}$, $P = 1.0 \text{ atm}$, $T = 25 \text{ }^\circ\text{C}$.

^a CH_2Cl_2 $V = 50 \text{ mL}$, $t = 24 \text{ h}$.

^b CH_2Cl_2 $V = 100 \text{ mL}$, $t = 17 \text{ h}$.

α -diimines bidentate ligands for ethylene polymerization

Catalysts based on Pd(II)

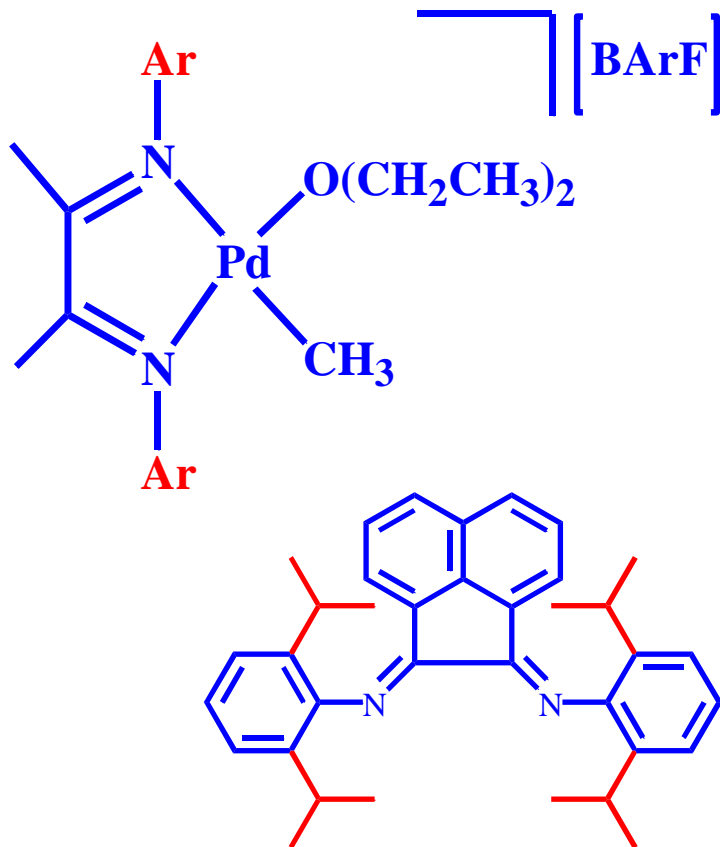

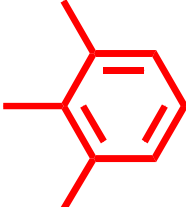
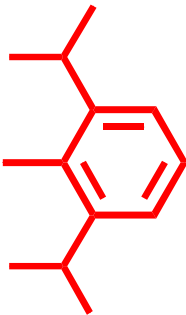
Ar	g PE	Mw (Mw/Mn)
	3.7	445000
	13.7	490000

L. K. Johnson, C. M. Killian, M. Brookhart *J. Am. Chem. Soc.* **1995**, *117*, 6414.

L. K. Johnson, S. Mecking, M. Brookhart *J. Am. Chem. Soc.* **1996**, *118*, 267.

Ethylene polymerization with **Ni(II)** catalysts

Effect of **precatalyst**

Cat. Prec.: **[NiBr₂(N-N)]**

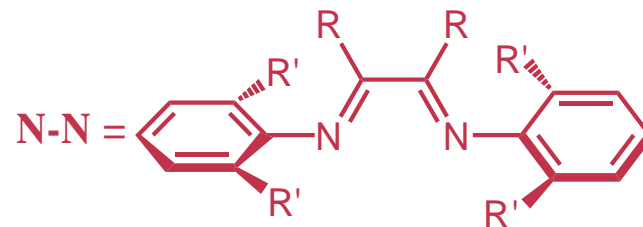

R, R'	mol cat.	t (min)	kg PE/mol Ni h	Mw (Mw/Mn)	Branches
H, i-Pr^a	1.7 x 10⁻⁶	15	1.1 x 10⁴	31000 (2.5)	38
Me, i-Pr	1.6 x 10⁻⁶	15	0.3 x 10⁴	520000 (1.6)	48
H, Me	17 x 10⁻⁶	30	0.04 x 10⁴	43000 (2.5)	1.2
Me, Me	17 x 10⁻⁶	10	0.17 x 10⁴	170000 (2.6)	20
BIAN, i-Pr^b	0.83 x 10⁻⁶	30	0.51 x 10⁴	610000 (2.3)	5.0

Reaction conditions: toluene V = 100 mL, P = 1.0 atm, T = 0 °C. ^aT = 25 °C. ^bV = 200 mL.

The activity of **i-Pr-DABH** is comparable to those of the most active Ziegler-Natta systems!

Ethylene polymerization with catalysts based on Ni(II) or Pd(II)^{1,2}

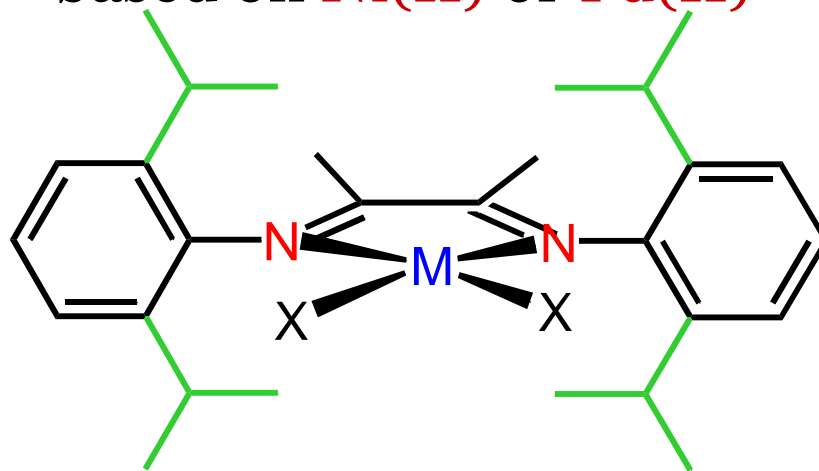

M = Ni

Solvent: toluene

11 000 kg PE/mol Ni h

M_w = oligomers – 85 000

linear and branched PE

M = Pd

Solvent: CH₂Cl₂

27 kg PE/mol Pd h

M_w = 112 000 – 1 000 000

Highly branched PE

¹M. Brookhart et al., *J. Am. Chem. Soc.* **1995**, *117*, 6414.

²S. D. Ittel et al., *Chem. Rev.* **2000**, *100*, 1169.

Ethylene polymerization with catalysts based on
Ni(II) or **Pd(II)**:
microstructure of the synthesized polyethylene

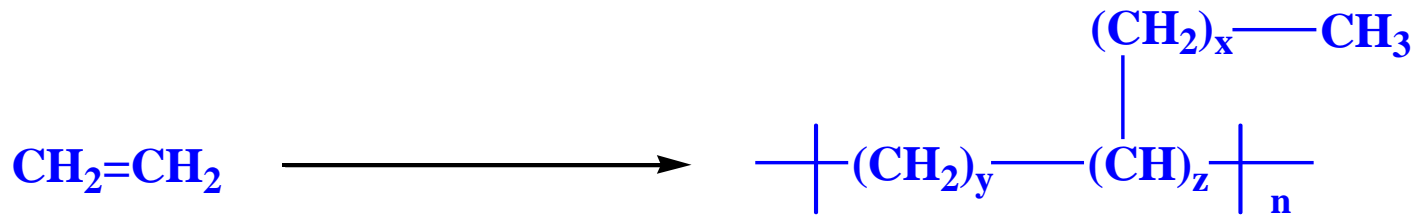

with cat. based on **Pd(II)** the
 synthesized PE has 115 branches
 each 1000 inserted CH_2

{	C1	37
	C2	25
	C3	3
	C4	12
	C5	1
	C6+	37

Polymerization Mechanism

NMR spectroscopy was fundamental to unravel the mechanism of the polymerization. Key intermediates were detected and kinetic investigations were performed, thus:

- the reaction was found to be **zero order** in ethylene pressure;
- the **Pd-alkyl-ethylene** intermediate was recognized to be the catalyst resting state;
- **ethylene insertion** was the rate determining step.

L. K. Johnson, C. M. Killian, M. Brookhart J. Am. Chem. Soc. **1995**, 117, 6414.
S. D. Ittel, L.K. Johnson, M. Brookhart Chem. Rev. **2000**, 100, 1169.

Polymerization Mechanism

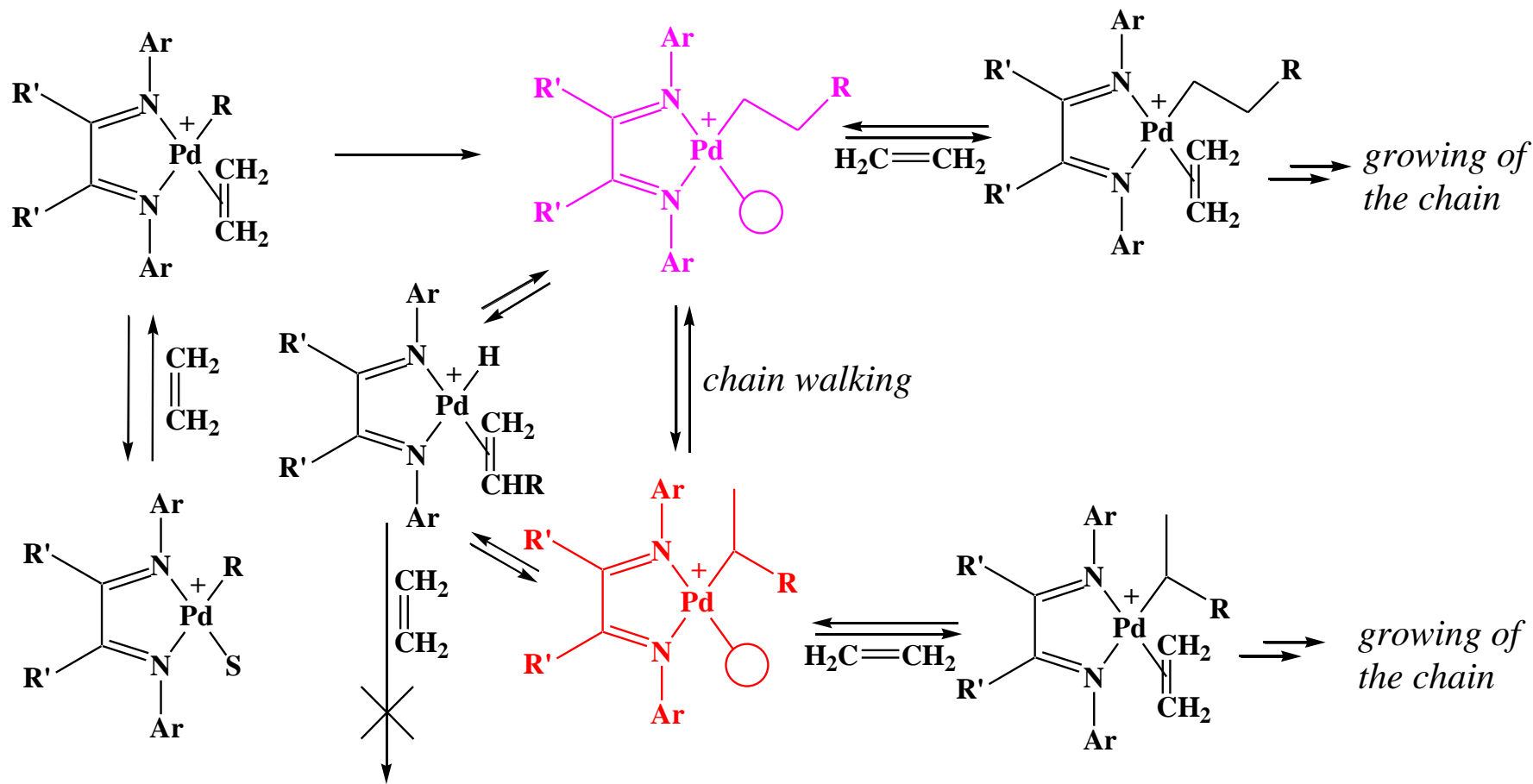

¹M. Brookhart et al., *J. Am. Chem. Soc.* **1995**, *117*, 6414.

²S. D. Ittel et al., *Chem. Rev.* **2000**, *100*, 1169.

Polymerization Mechanism

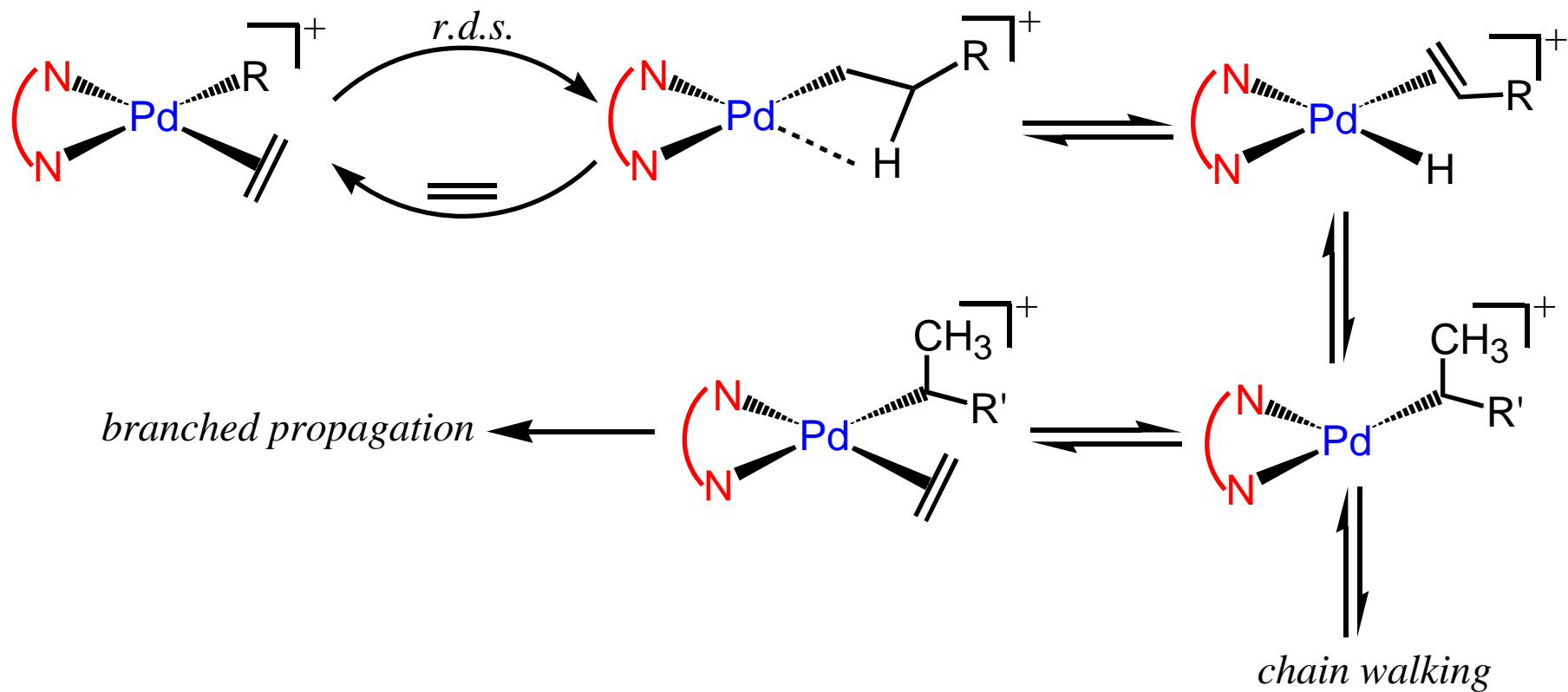

¹M. Brookhart et al., *J. Am. Chem. Soc.* **1995**, *117*, 6414.

²S. D. Ittel et al., *Chem. Rev.* **2000**, *100*, 1169.

Chain transfer mechanism

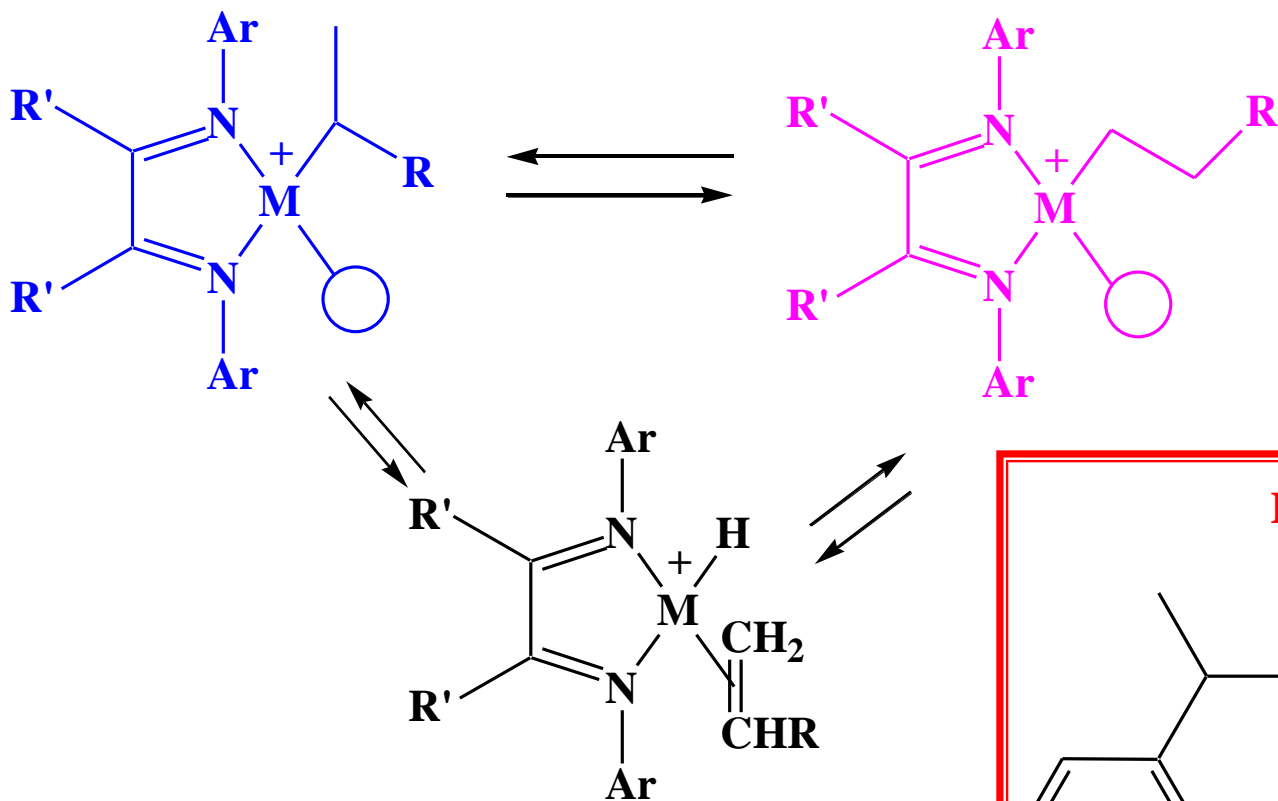

... it is *associative*,
and it is unfavoured by
steric hindrance!

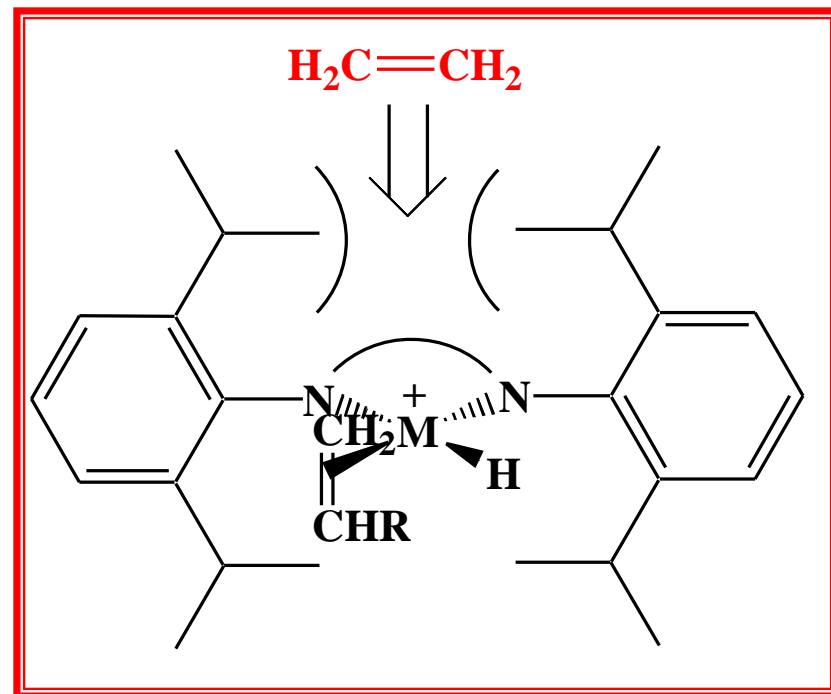

Chain transfer mechanism

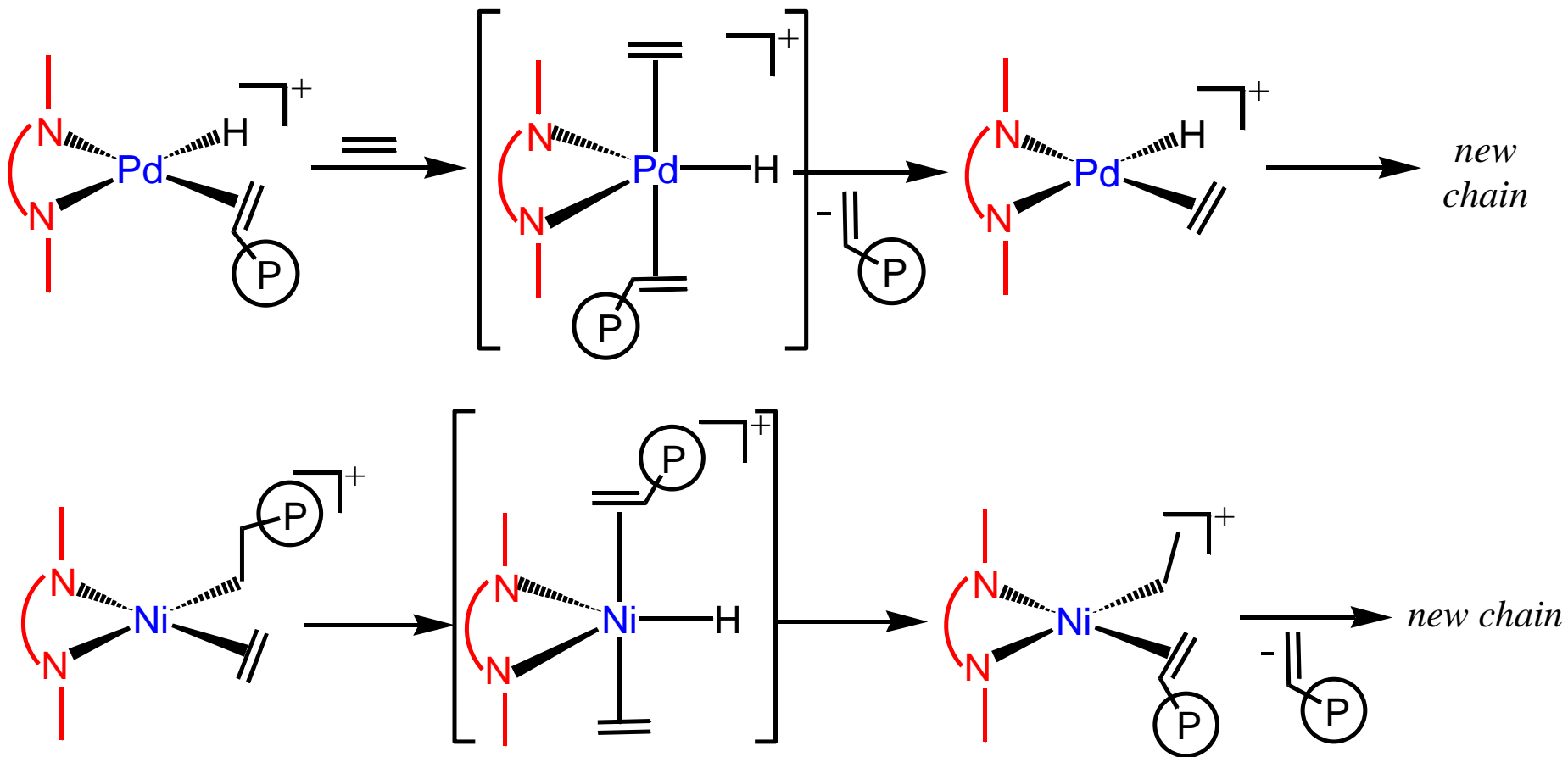

¹M. Brookhart et al., *J. Am. Chem. Soc.* **1995**, *117*, 6414.

²S. D. Ittel et al., *Chem. Rev.* **2000**, *100*, 1169.

