

Course of Geothermics

Dr. Magdala Tesauro

Course Outline:

1. Thermal conditions of the early Earth and present-day Earth's structure
2. Thermal parameters of the rocks
3. Thermal structure of the lithospheric continental areas (steady state)
4. Thermal structure of the lithospheric oceanic areas
5. Thermal structure of the lithosphere for transient conditions in various tectonic settings
6. Heat balance of the Earth
- 7. Thermal structure of the sedimentary basins**
8. Thermal maturity of sediments
9. Mantle convection and hot spots
10. Magmatic processes and volcanoes
11. Heat transfer in hydrogeological settings
12. Geothermal Systems

Sedimentary Basins

- Most of the thickest sedimentary basins were formed in intracontinental seas because they: (1) are surrounded by source regions, favoring collection of huge amounts of sediments; (2) contain water in sedimentary pores which facilitates the bending of rocks in folds (e.g., South Caspian Depression, surrounded by orogenic belts, such as the Greater Caucasus (N–W)).
- Thickness of sedimentary rocks is usually greater in the middle of a basin (e.g., the South Caspian Depression), but in some cases the thickness can vary from one side to the opposite one (e.g., in the Dniepr–Donets Basin the max thickness of the sediments ranges from 2–6 km in the northwest to 15–19 km in the southeast).

Sedimentary thickness distribution

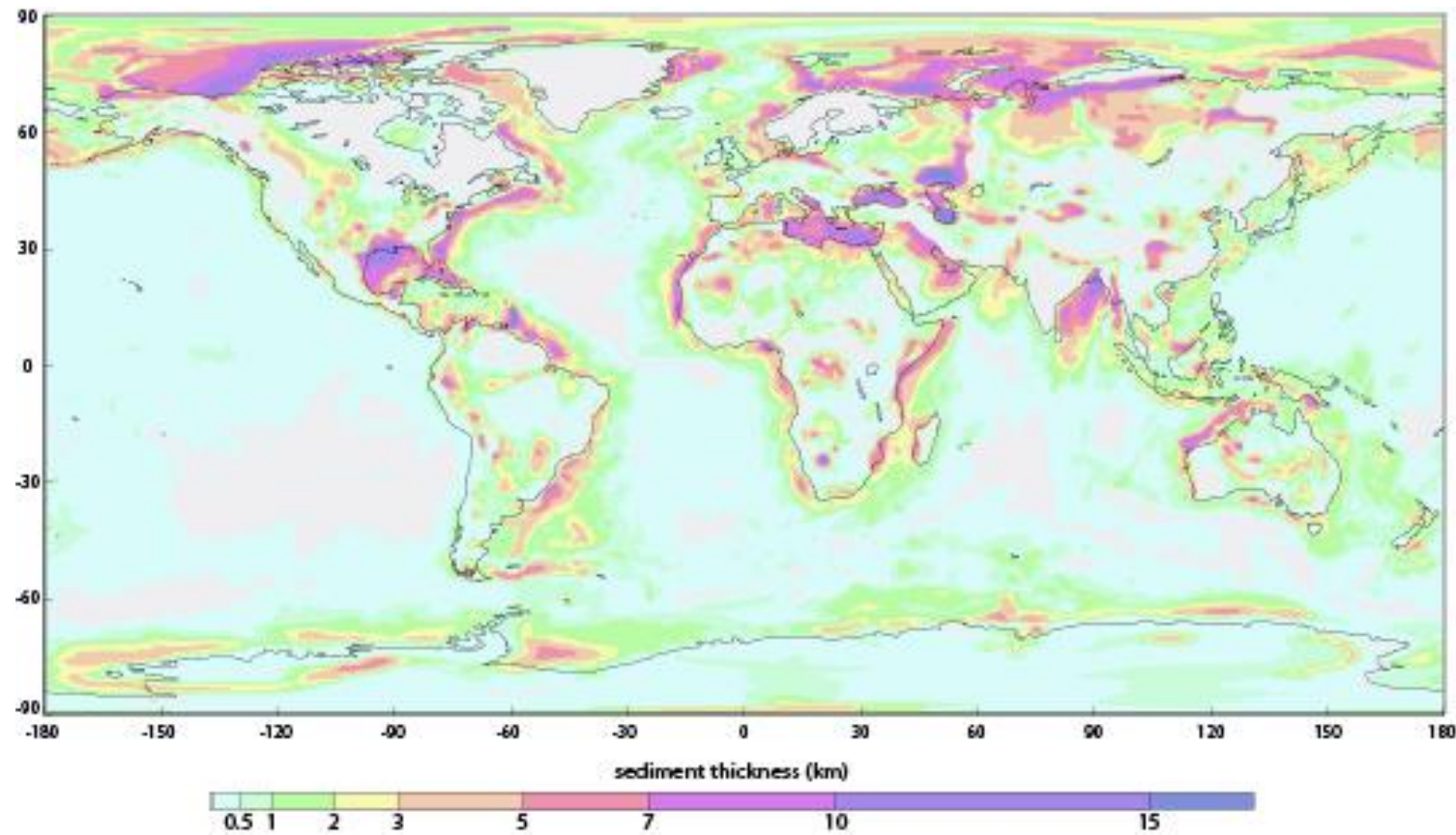

Laske et al., 1997

Sediments

Sedimentation during basin evolution causes several physical/chemical changes to the basin-fill

Compressibility: elastic response of a solid material allowing reduction of a volume caused by an increase in pressure or stress

Consolidation: decrease in volume by a loss of water under static loading (usually applied to soils and young sediments)

Compaction: change in dimensions of a volume of sediment by a reduction of the pore space between a solid framework as a result of loading due to *mechanical compaction* (dominating in the cool upper portions of sedimentary basins) and *physical-chemical compaction* (e.g., pressure solution in the carbonates).

Porosity loss: loss of pore volume that accompanies burial due to compaction and cementation (filling of the pore space by chemical precipitation)

Cementation: (or lithification) takes place when dissolved ions, carried by water within pores, react to form specific cementing minerals (calcite, quartz, iron oxides), which are precipitated within pores.

Porosity of sediments

Porosity-depth relationships are affected by different factors:

- Gross lithology (shales compact quickly compared to sandstones)
- Depositional facies, controlling grain size, sorting, and clay content.
- Composition of framework grains, e.g., pure quartz arenite is different from lithic arenites.
- Temperature affects chemical diagenesis (quartz cementation, clay mineral growth, and pressure solution)
- Time: porosity loss may require sufficiently long periods of time.

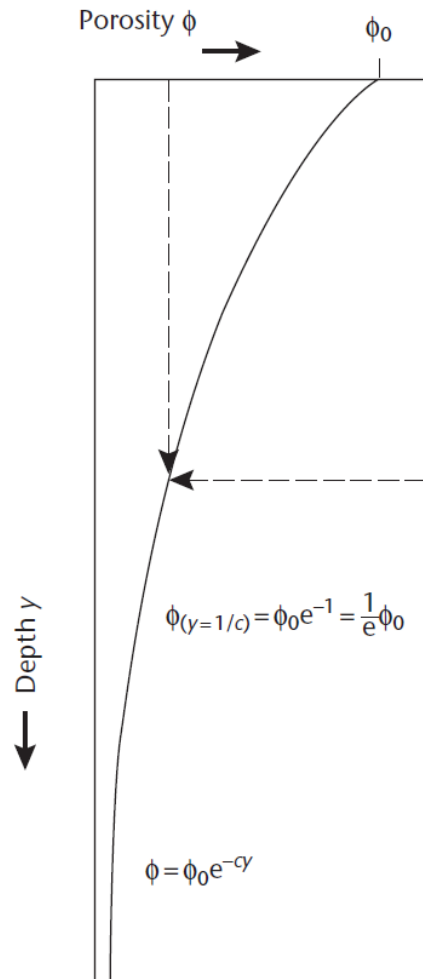

There are many porosity-depth relations, based on a principle of porosity destruction as a consequence to burial effect:

$$\phi = \phi_0 - ay$$

$$\phi(y) = \phi_0 \exp(-cy)$$

$$\phi(y) = \phi_0 \exp(-y/y_0)$$

y_0 = the depth at which the porosity has decreased to 1/e of its surface value

Lithology	ϕ_0	y_0 (m)	c (km^{-1})
Shale	0.63 (0.71)	1960 (1961)	0.51 (0.51)
Sandstone	0.49	3703	0.27
Chalk	0.70	1408	0.71
Shaly sandstone	0.56	2464	0.40

Porosity and permeability of sediments

$$\phi(y) = \phi_0 \exp(-cy) \quad \phi(y) = \phi_0 \exp(-y/y_0)$$

Darcy law

The flux of fluid v_D flowing through a porous medium of length l in response to a pressure difference ΔP .

$$v_D = -\frac{k \Delta p}{\mu l} \quad v_D = \phi v_f$$

k is the permeability and μ is the fluid viscosity, v_f =fluid velocity

Permeability of rocks

Rock	k (m ²)
Fractured rocks	$10^{-7} - 10^{-10}$
Fresh granite	$10^{-17} - 10^{-18}$
Sandstone	10^{-14}
Limestone	10^{-16}

$$1 \text{ Darcy} = 10^{-12} \text{ m}^2$$

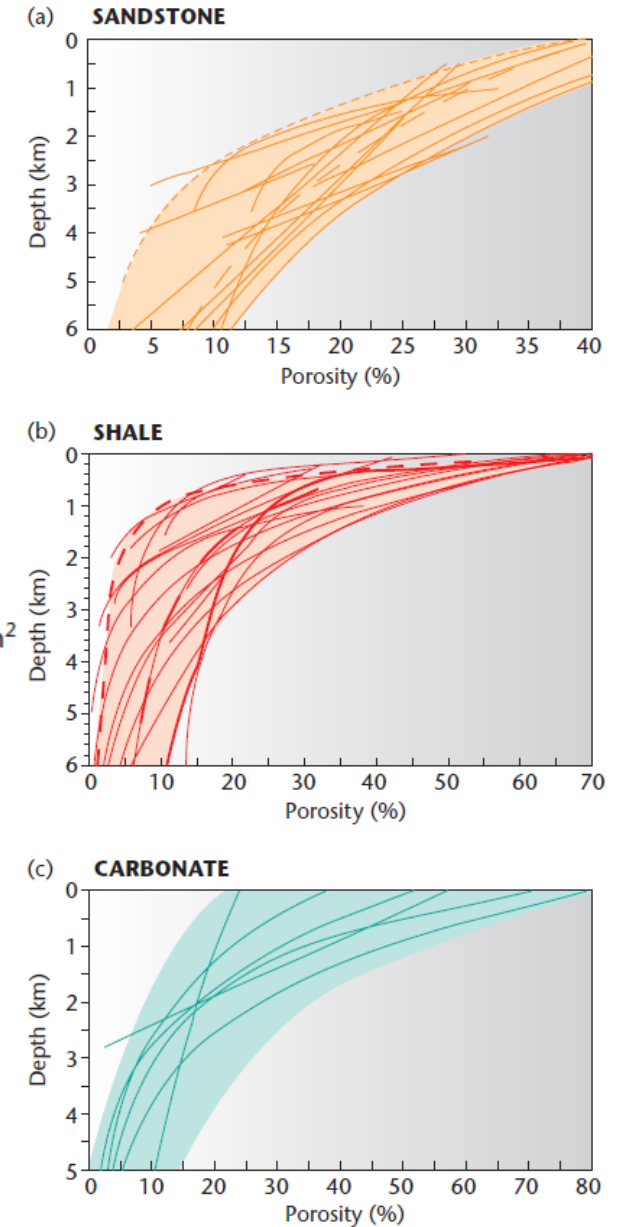
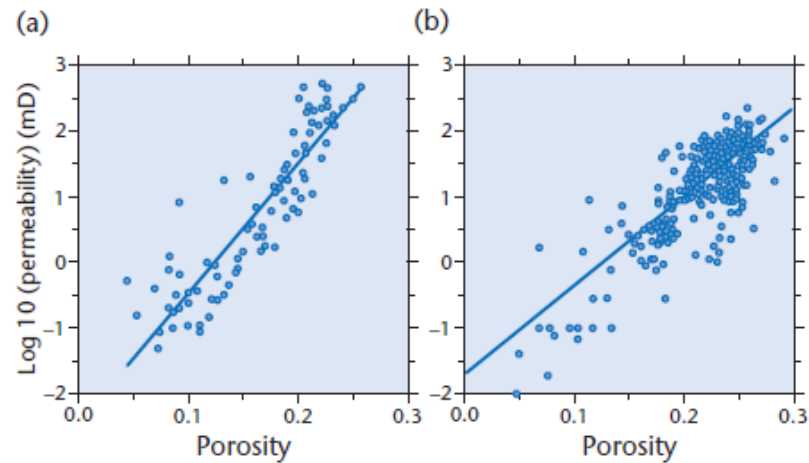
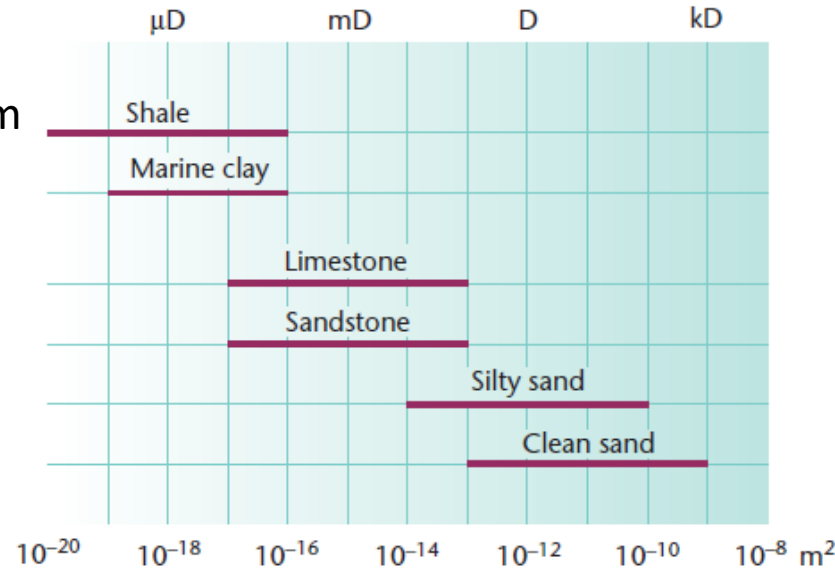

Density and porosity in sedimentary basins

(a)

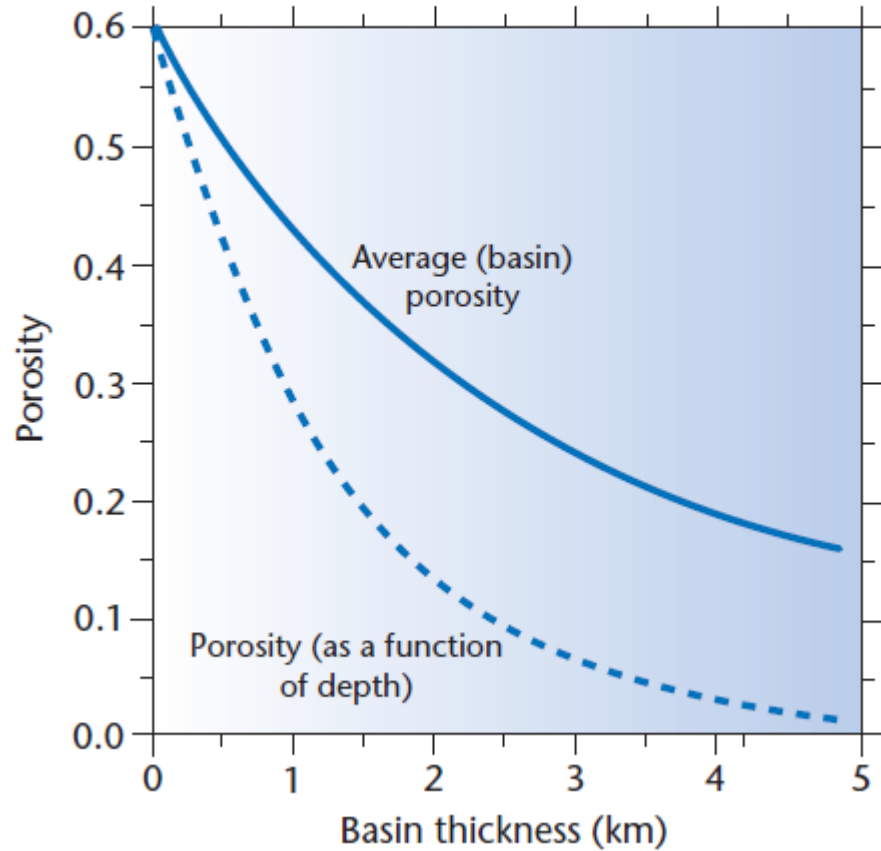

(b)

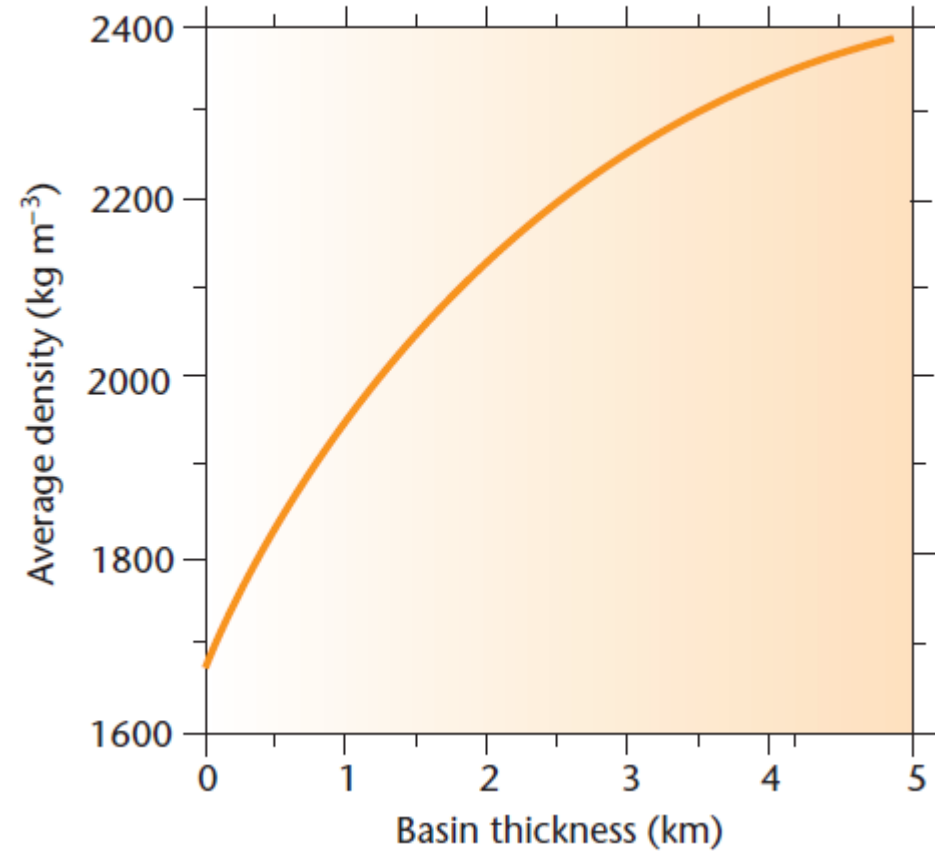

$$\rho_w = 1000 \text{ kg m}^{-3} \quad \rho_s = 2650 \text{ kg m}^{-3} \quad \phi_0 = 0.6 \quad y_0 = 1350 \text{ m}$$

y_0 = depth scale for the exponential reduction of porosity

Density of sediments (Europe)

Depth of the basement

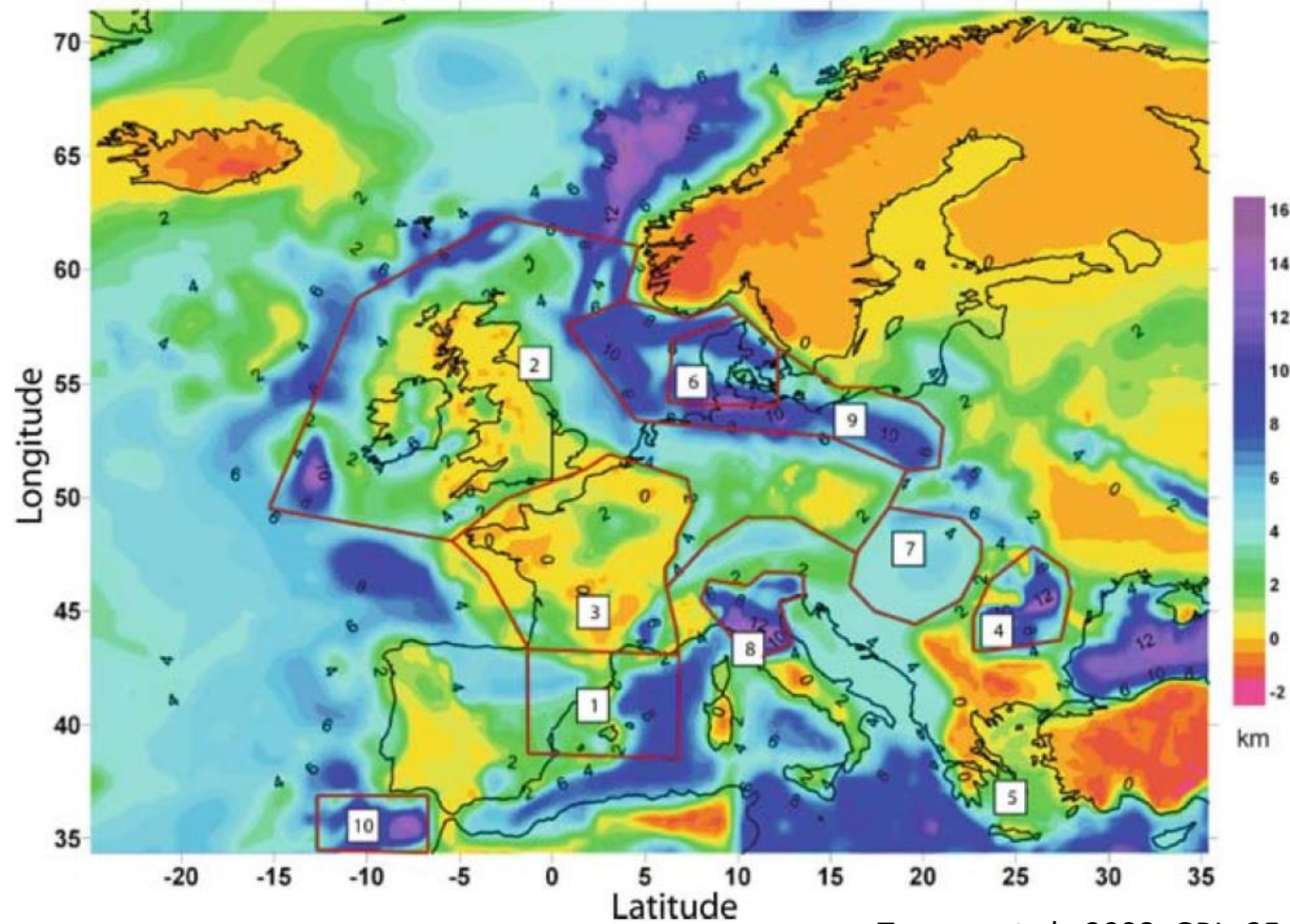

Tesauro et al., 2008, GRL, 35

Depth to basement (km) determined using the following compilations: 1, Ayala et al. (2003); 2, Bourgeois et al. (2007); 3, BRGM (2006); 4, Diehl et al. (2005); 5, EXXON (1985); 6, Lassen (2005); 7, Lenkey (1999); 8, Pieri and Groppi (1981); 9, Scheck-Wenderoth and Lamarche (2005); 10, Thiebot and Gutscher (2006).

Density of sediments (Europe)

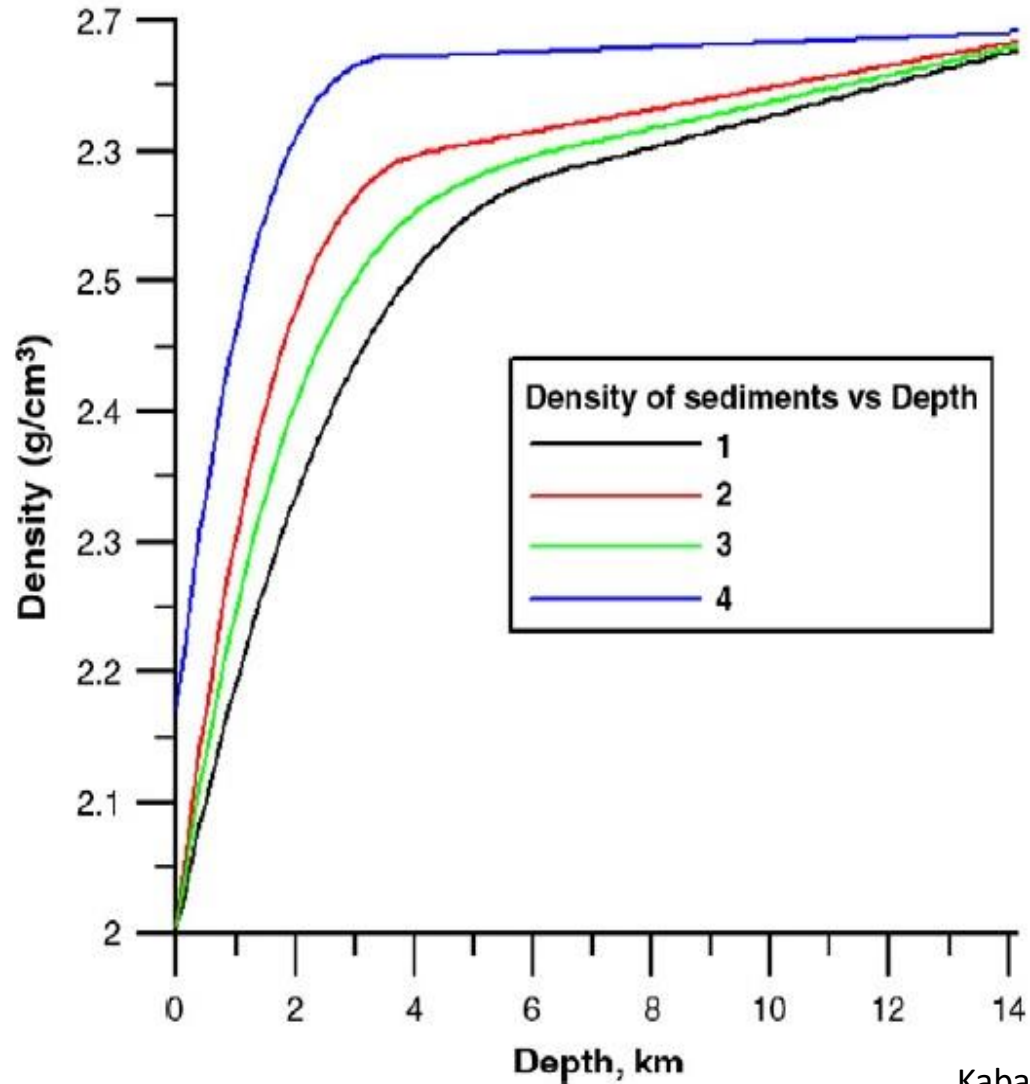

Kaban et al., 2010, EPSL, 296

Geological feature	Age	Mean density (g/cm ³)	^a Max thickness (km)
Central European Basin System	Paleozoic-Tertiary	2.40-2.45	10
Møre and Vøring Margin	Pre-Cretaceous-Quaternary	2.45-2.50	15
Lofoten Margin	Pre-Cretaceous-Quaternary	2.40-2.45	8
Upper Rhine Graben	Late Paleozoic-Quaternary	2.45	4
Cantabrian-Pyrenees	Mesozoic-Tertiary	2.50-2.55	5
Aquitaine Basin	Mesozoic-Tertiary	2.45-2.50	10
Duero Basin	Mesozoic-Tertiary	2.50-2.55	6
Ebro and Tajo Basin	Mesozoic-Tertiary	2.50-2.55	6
Balearic Sea	Tertiary-Quaternary	2.35	5
Gulf of Cadiz	Tertiary-Quaternary	2.30-2.35	4
Bay of Biscay	Mesozoic-Quaternary	2.25-2.35	2
Iberian Abyssal Plain	Tertiary-Quaternary	2.10-2.20	2
Provençal-Corsica margin	Tertiary-Quaternary	2.30	5
Gulf of Lyon	Tertiary-Quaternary	2.20-2.25	2
Tyrrhenian Sea	Tertiary-Quaternary	2.25-2.30	5
Ionian Sea	Mesozoic-Quaternary	2.30-2.35	6
Eastern Mediterranean Sea	Tertiary-Quaternary	2.35	8
Aegean Sea	Tertiary-Quaternary	2.05-2.15	2
Po Plain	Tertiary-Quaternary	2.45-2.50	15
Molasse Basin	Tertiary-Quaternary	2.45	6
Adriatic Sea	Mesozoic-Quaternary	2.25-2.30	4
Ligurian Sea	Tertiary-Quaternary	2.30-2.35	5
South Rockall Basin	Late Paleozoic-Quaternary	2.30-2.35	5
Lousy and Rosemary Bank	Mesozoic-Quaternary	2.25-2.30	2
North Rockall Basin	Mesozoic-Quaternary	2.30-2.35	6
Iceland-Faeroe Ridge	Mesozoic-Quaternary	2.20-2.25	2
Porcupine Basin	Mesozoic-Quaternary	2.45-2.50	12
Edoras Bank	Mesozoic-Quaternary	2.20-2.25	2
Hatton Basin	Mesozoic-Quaternary	2.30	4
Foçani Basin	Late Mesozoic-Quaternary	2.45-2.50	16
Transylvania Basin	Paleozoic-Quaternary	2.25	5
Foredeep Carpathians	Tertiary-Quaternary	2.45-2.50	7
Pannonian Basin	Mesozoic-Quaternary	2.35-2.40	5
Black Sea	Mesozoic-Quaternary	2.45-2.50	12
Dnieper-Donets Rift	Paleozoic-Quaternary	2.40-2.50	10
Russian Rift	Paleozoic-Quaternary	2.40-2.45	3

1. marine deposits 2. Central European basins, 3. Pannonian basin, 4. basins of Iberia

Thermal conductivity of sediments

Bulk thermal conductivity of sediments depends on the mineralogy of the framework grains, type and amount of material in the matrix, and porosity (increases with decreasing porosity) and fluid content. It ranges between $1.5 \text{ Wm}^{-1} \text{ K}^{-1}$ (shales) and $4.5 \text{ Wm}^{-1} \text{ K}^{-1}$ (sandstones).

(a) SANDSTONES WITH VARIABLE CLAY CONTENTS

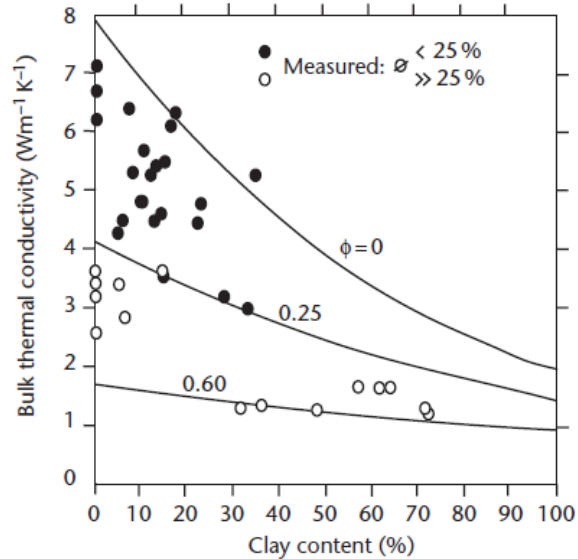

(b)

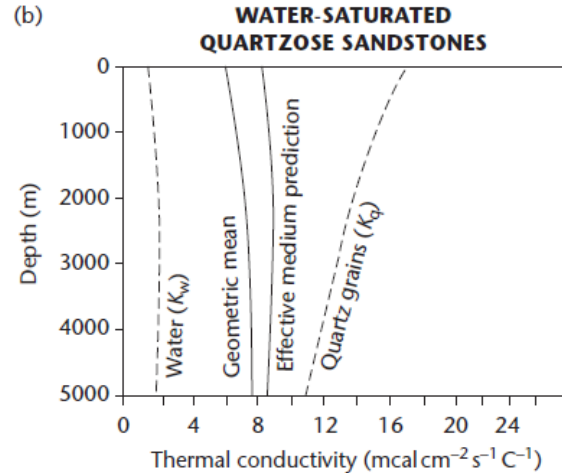

(c)

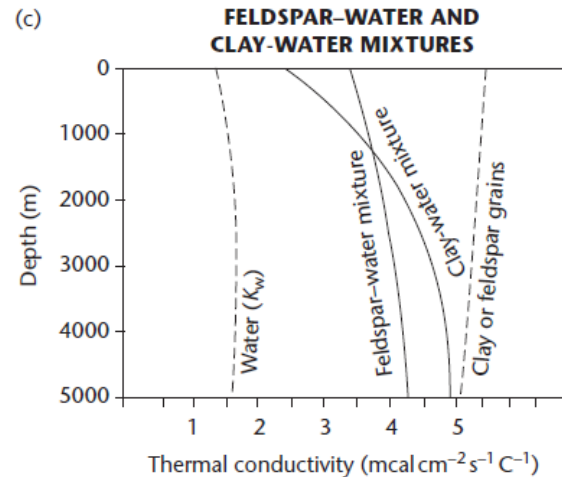

$$K_{\text{bulk}} = K_s^{(1-\phi)} K_w \phi$$

K_s and K_w = thermal conductivities of sediments grains and water

ϕ = porosity (filled with water)

$$K_{\text{Quartz}} = 7.7 \text{ Wm}^{-1} \text{ K}^{-1},$$

$$K_{\text{clay}} = 2.0 \text{ Wm}^{-1} \text{ K}^{-1}$$

$$K_{\text{Water}} = 0.6 \text{ Wm}^{-1} \text{ K}^{-1}$$

Conductivity and temperatures in a sedimentary basin

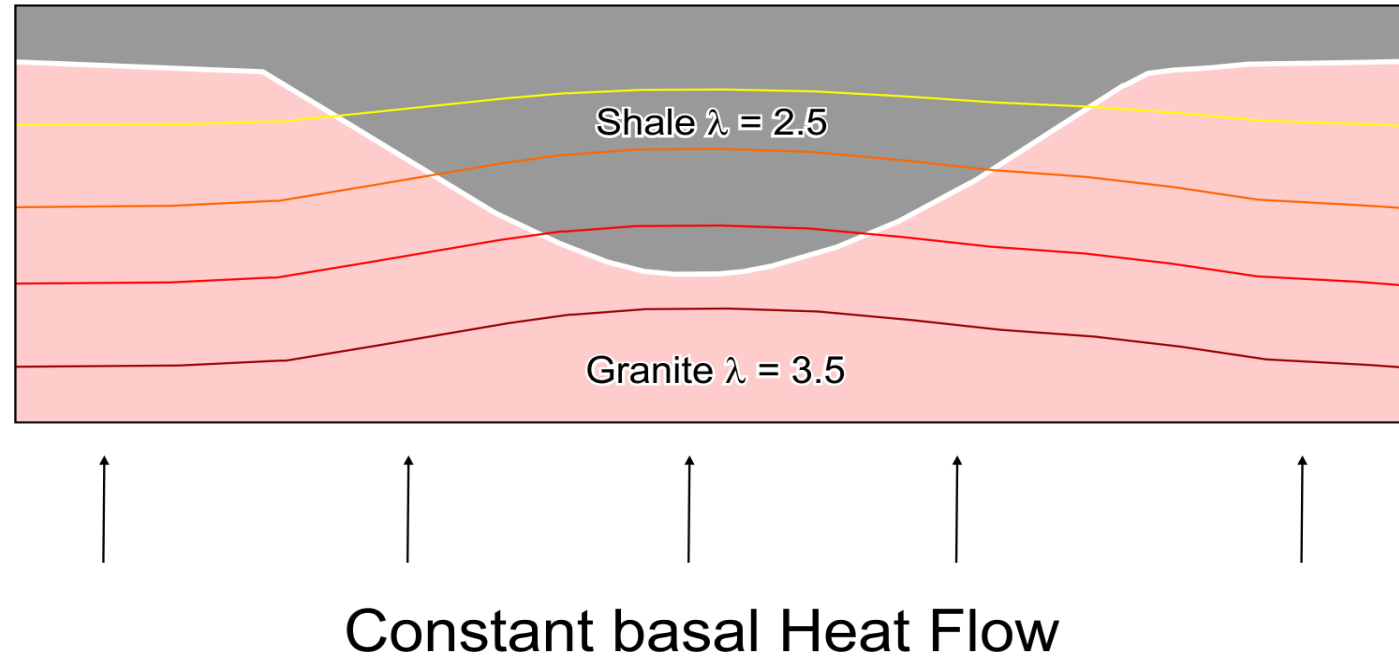

Conductivity and temperatures in a sedimentary basin

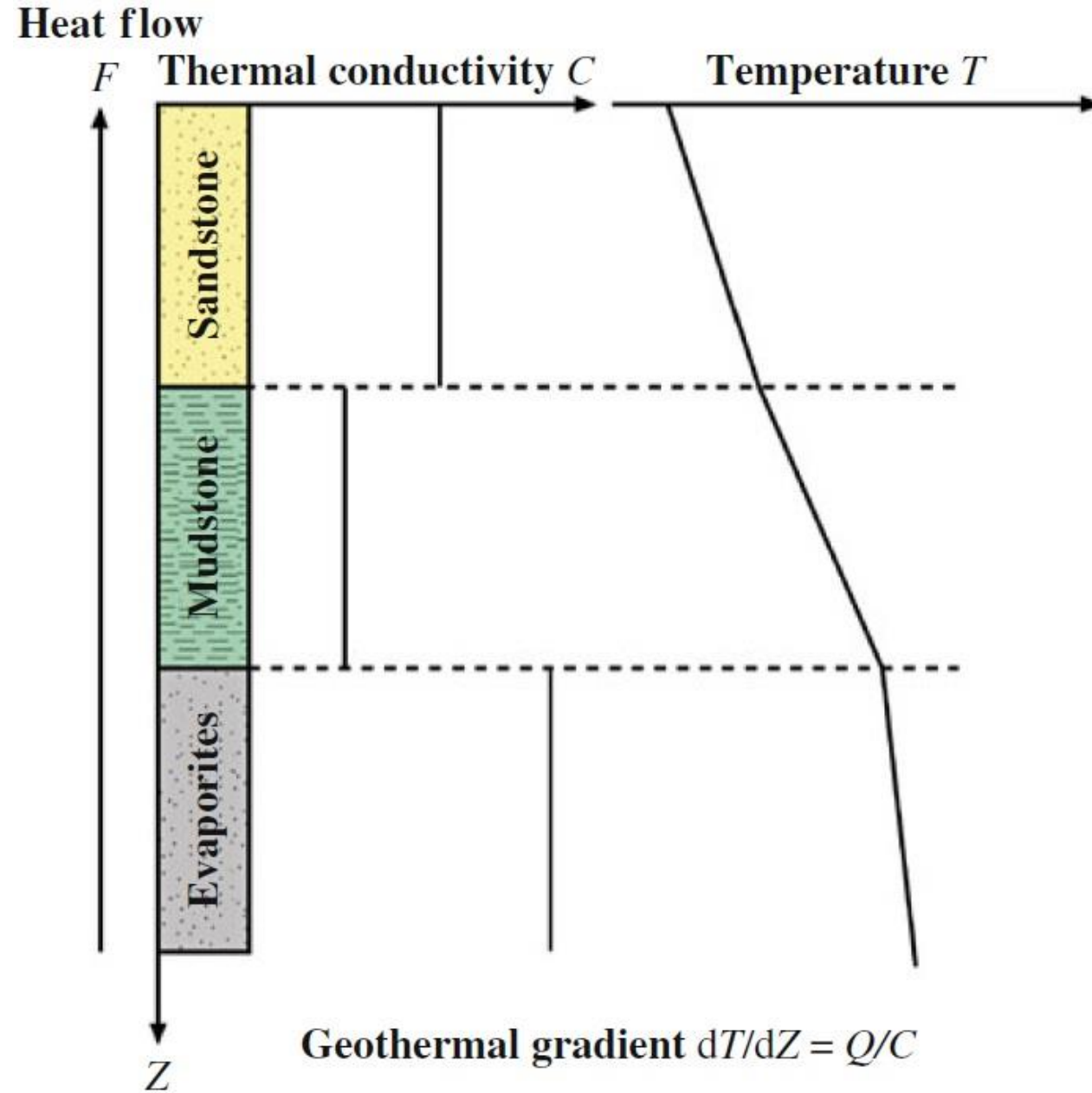

Heat refraction and salt bodies

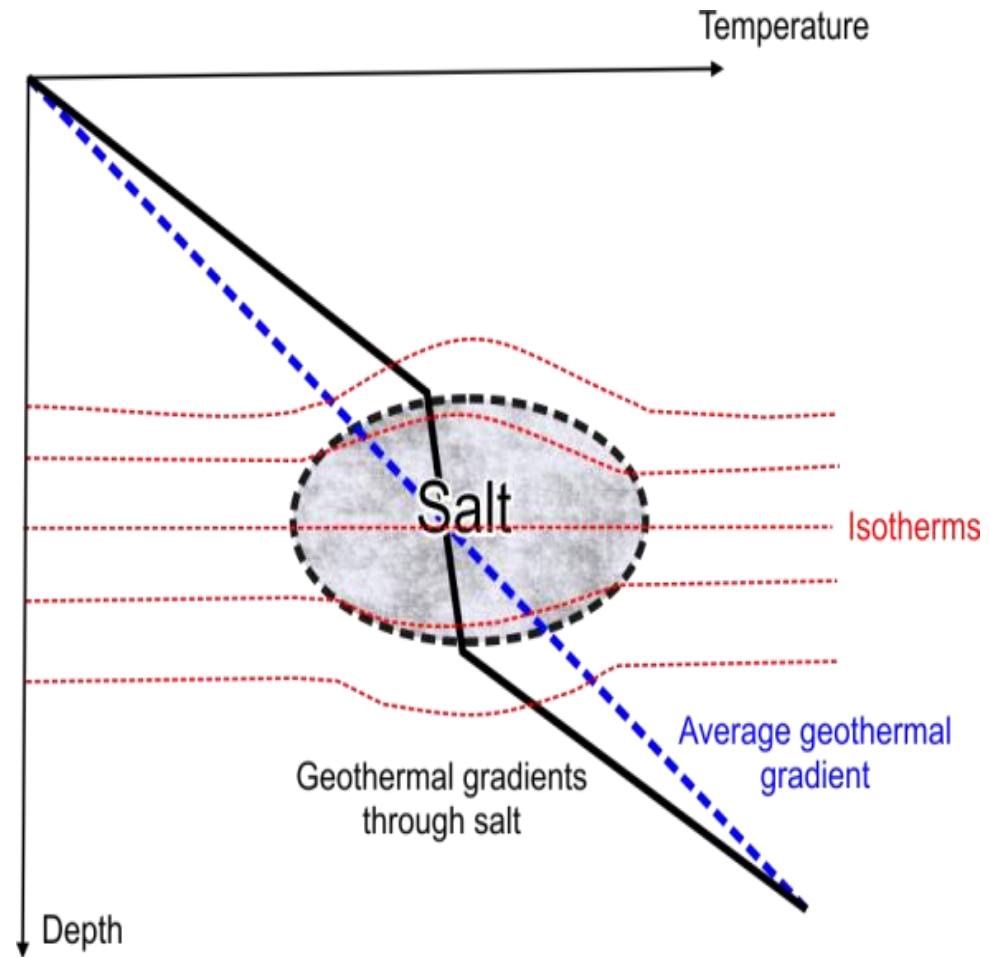

Salt Dome

- Salt dome increases surface heat flow due to its higher thermal conductivity ($5.5 \text{ Wm}^{-1} \text{ K}^{-1}$) and transports heat via advection.
- The increase in thermal conductivity is amplified if the salt rises to form vertical columns.

If the salt is a horizontal layer (Harmonic mean):

$$\lambda_{\text{av}} = 1/[0.9/2.3 + 0.1/5.5] = 2.44 \text{ W m}^{-1} \text{ K}^{-1}$$

If the salt is a vertical column (Arithmetic mean):

$$\lambda_{\text{av}} = 0.9 \times 2.3 + 0.1 \times 5.5 = 2.62 \text{ W m}^{-1} \text{ K}^{-1}$$

A column of salt rises heat through advection if the rate of ascent is significant

$$(\partial Q_s / \partial z) = \phi \rho_s c_s w_z (\partial T / \partial z)$$

ρ_s =density w_z =vertical velocity of the diapir c_s = specific heat

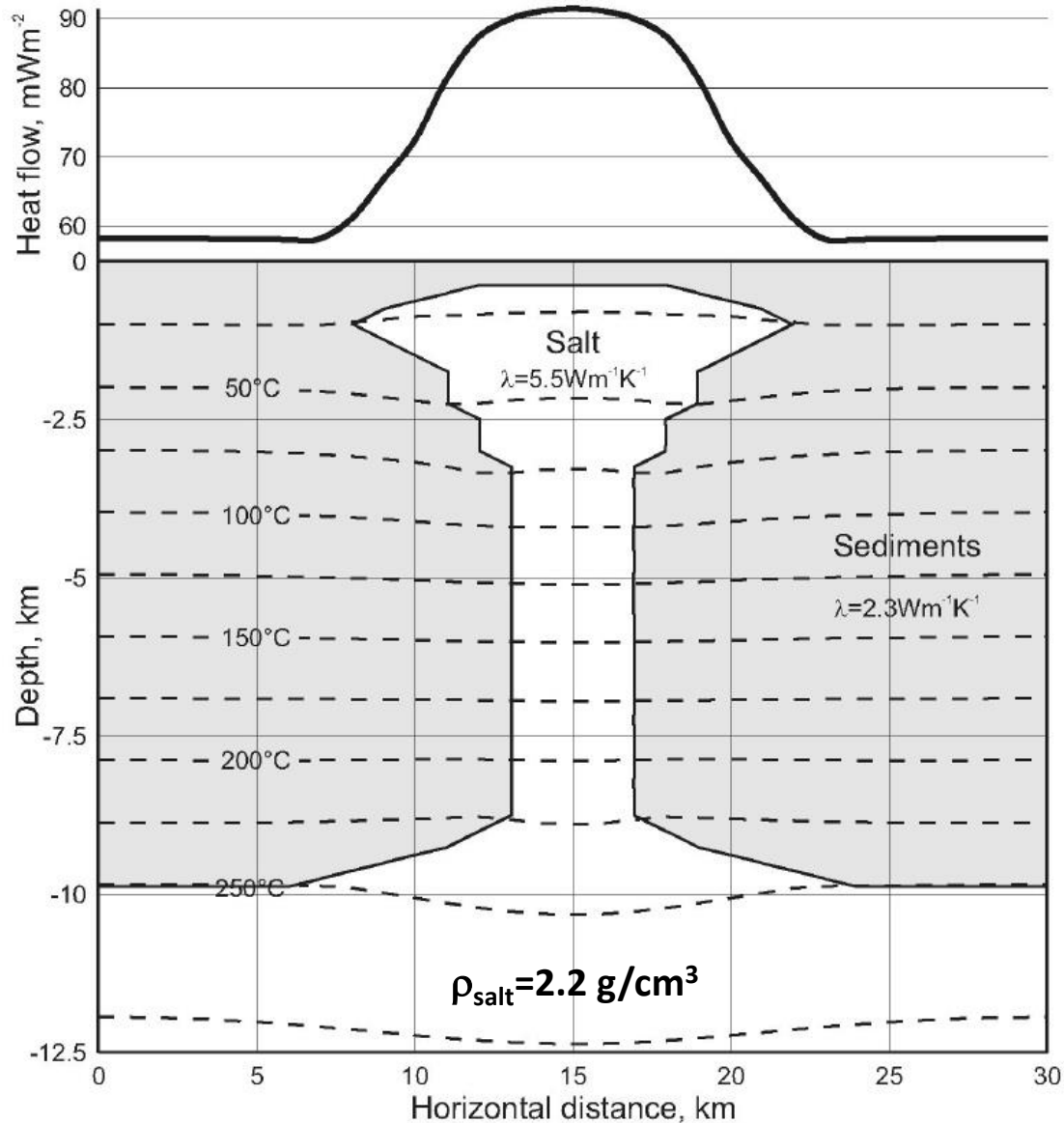

Salt Dome

- Salt diapirs cause hotter conditions above the salt bodies (anomalous high heat flow) and cooler below, in comparison with the other surrounding regions.
- The temperature anomaly extends for a lateral distance almost equal to the thickness of the salt body.
- High horizontal geothermal gradient values are usually found near salt domes: e.g., 12 K km^{-1} near the salt dome, 7 K km^{-1} at 500 m from the salt dome, and 2.3 K km^{-1} at 1000–1500 m from the dome have been reported for the North Louisiana Salt Basin.

(a)

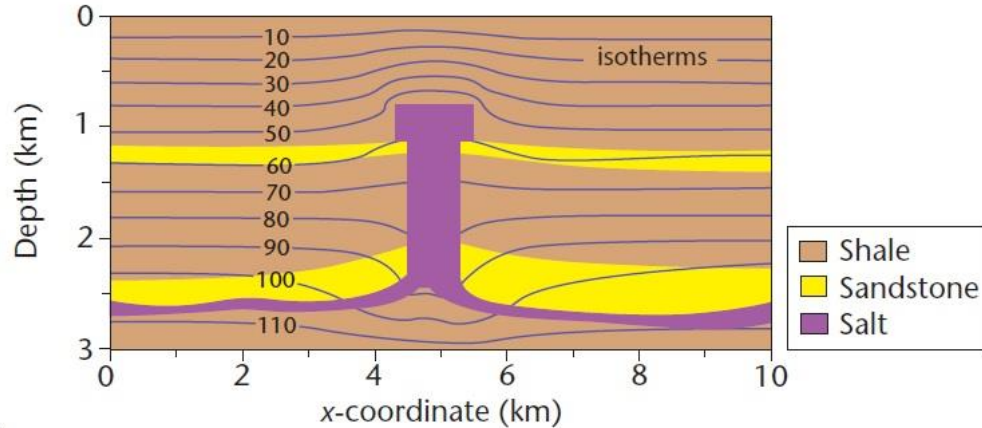

(b)

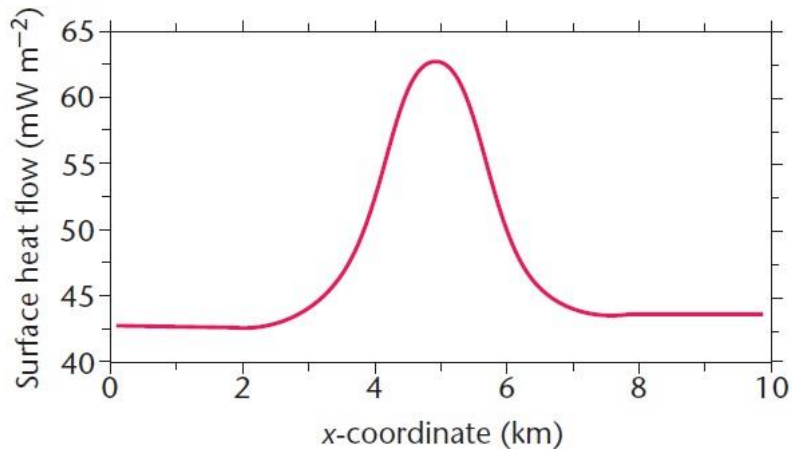

(c)

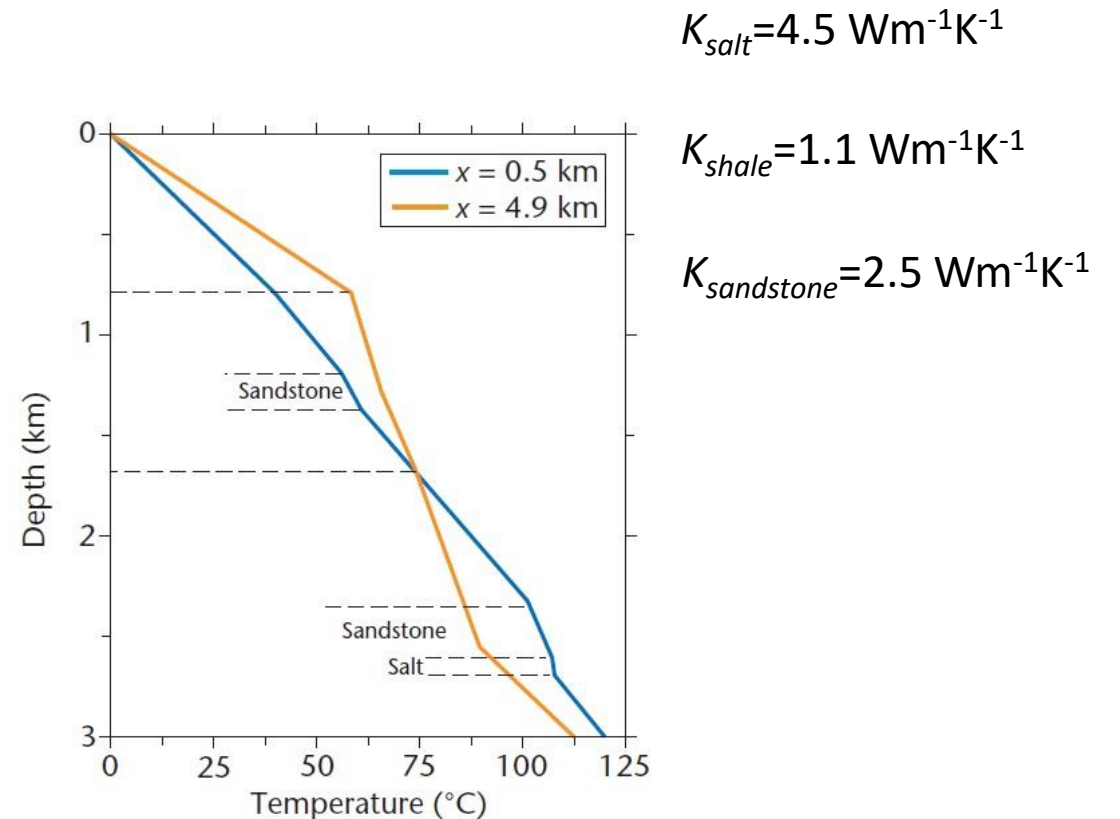

Central European Basin System

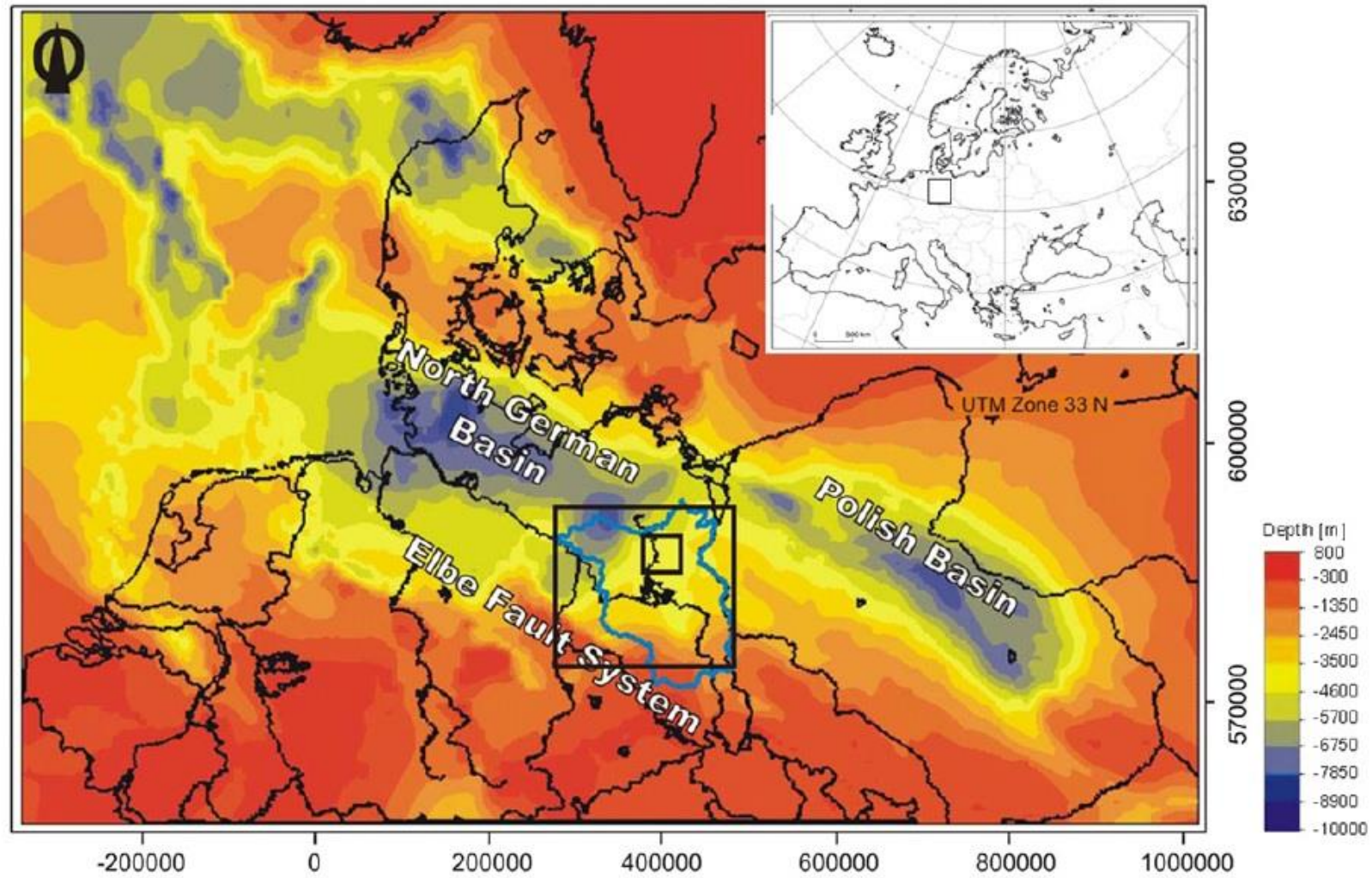

Central European Basin System

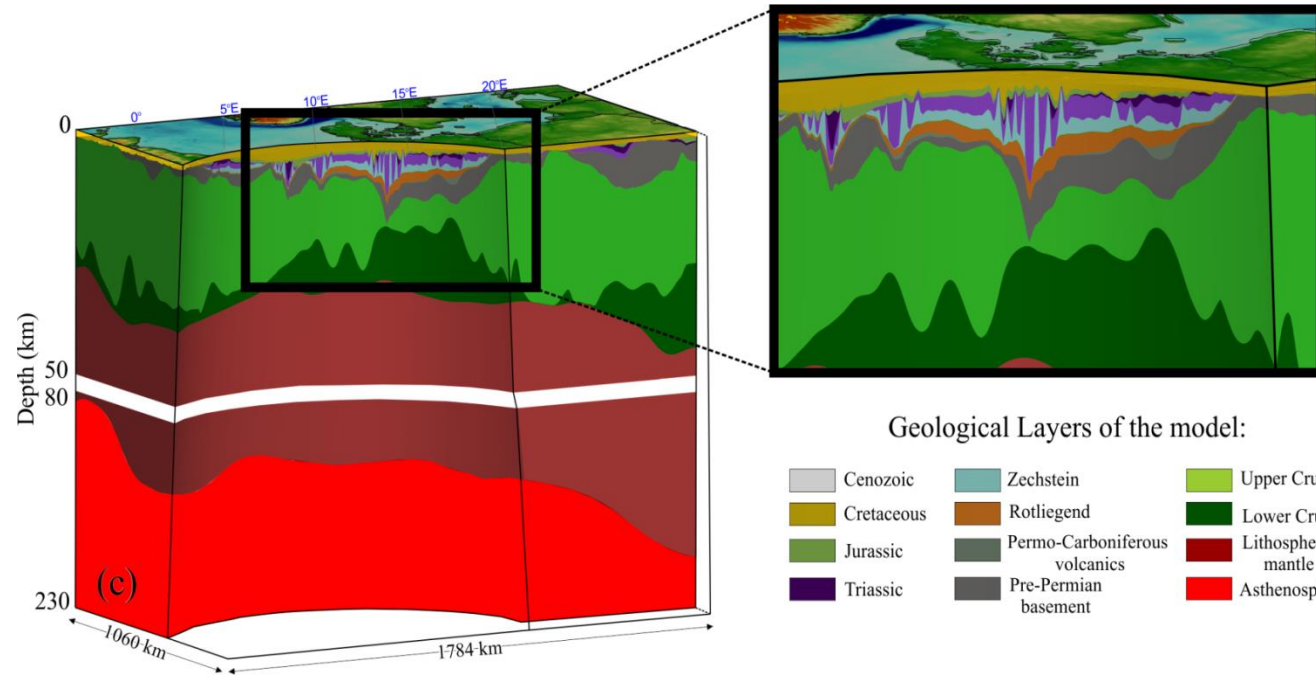

Noack et al., 2010, Chemie der Erde, 70

Stratigraphic unit	Thermal conductivity ($\text{W m}^{-1} \text{K}^{-1}$)	Radiogenic heat production 10^{-7}W m^{-3}
Quaternary	1.5	9
Tertiary	1.5	9
Upper Cretaceous	1.9	6
Jurassic-Lower Cretaceous	2	15
Upper Triassic (Upper Keuper)	2.3	16
Upper Triassic (Lower Middle Keuper)	2.3	16
Middle Triassic (Middle-Upper Muschelkalk)	1.85	10
Middle Triassic (Lower Muschelkalk)	1.85	10
Lower Triassic (Buntsandstein)	2.0	18
Upper Permian (Zechstein)	4.5	4
Lower Up. Permian (Zechstein)	4.5	4
Upper Rotliegend (Hannover Formation)	1.9	18
Upper Rotliegend (Elbe alternating sequence)	1.9	14
Upper Rotliegend (Elbe base sandstone 2)	2.9	14
Upper Rotliegend (Elbe base sandstone 1)	2.8	10
Upper Rotliegend (Havel Subgroup)	3.0	12
Permo-Carboniferous Volcanics	2.3	10
Carboniferous	2.7	20

Heat refraction and salt bodies (Zachstein Salt)

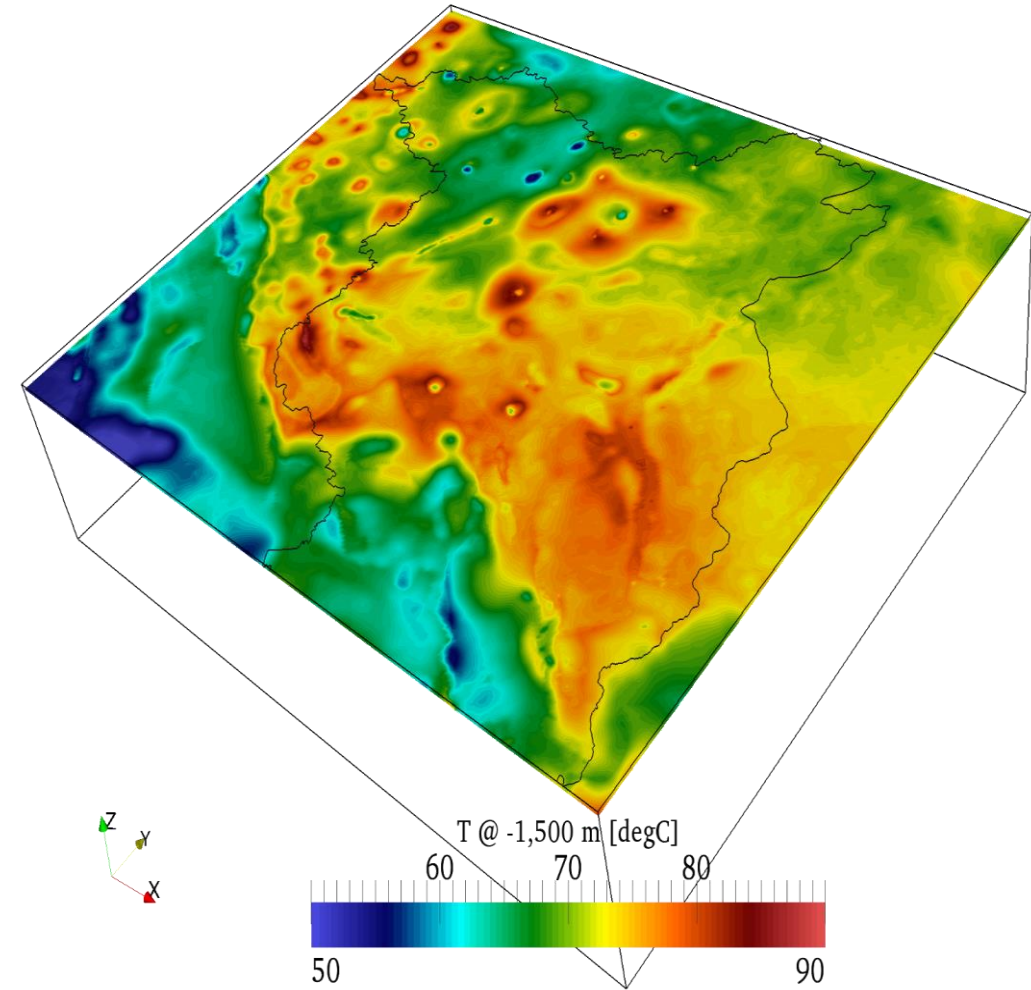
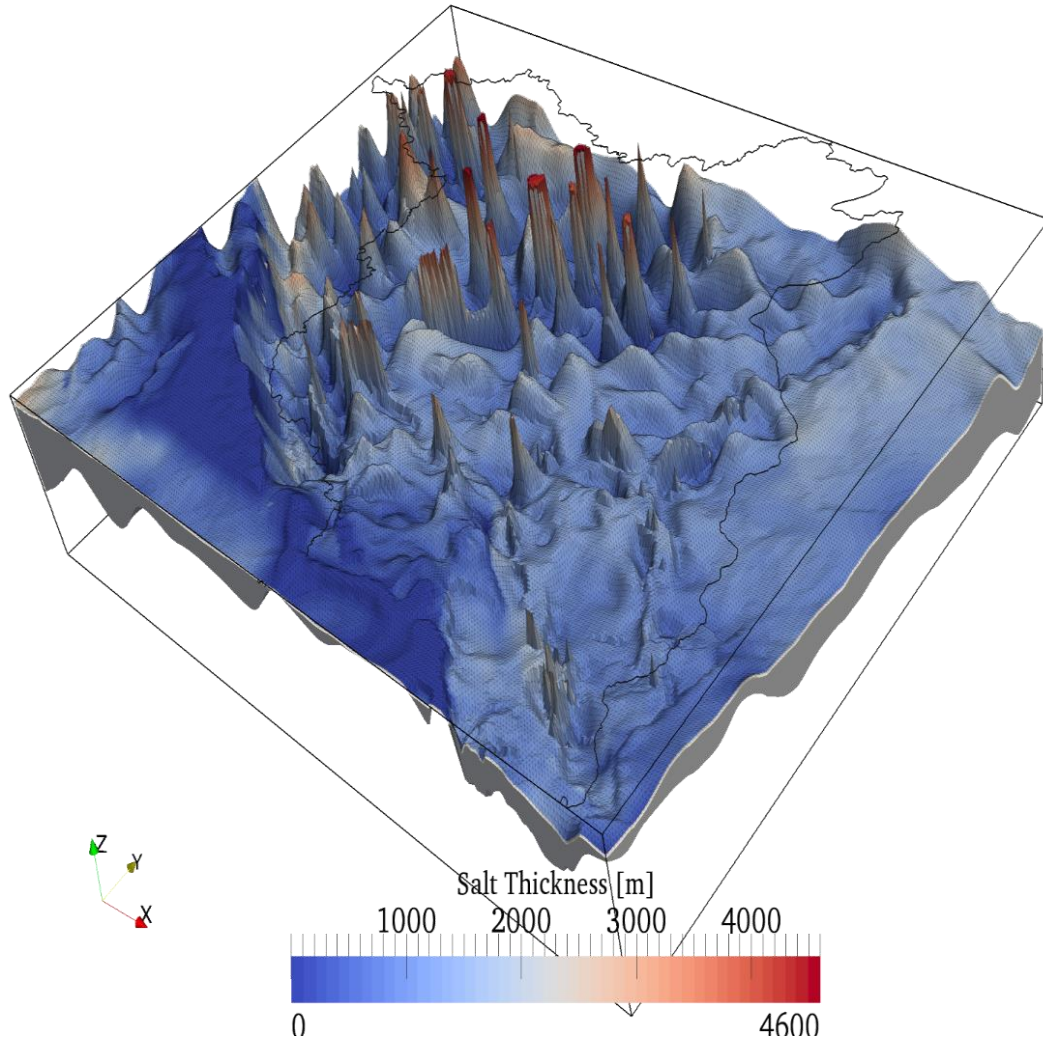

Transient Effects: Basement Undulations

Heat follows a path of least thermal resistance, then it flows towards regions of higher thermal conductivity

If $\lambda_r > \lambda$ heat is channeled from thick to thin sedimentary cover

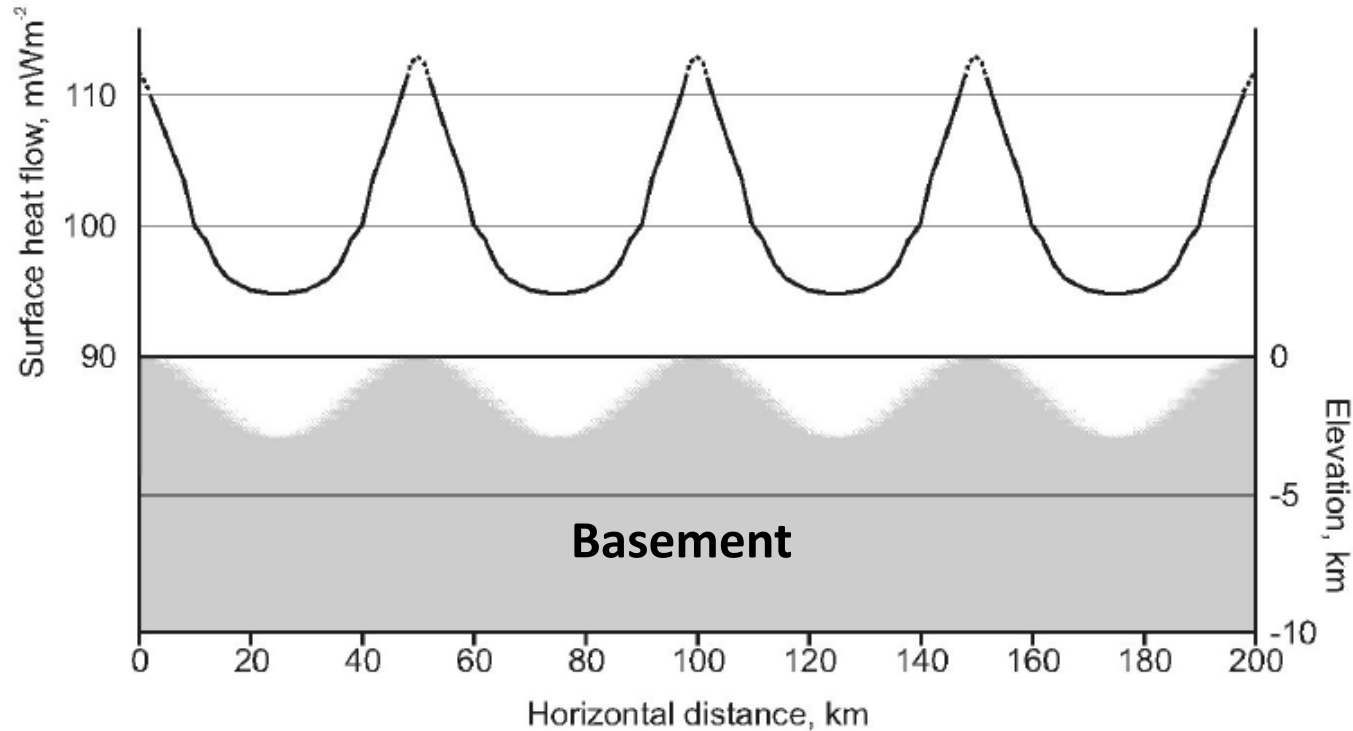

$2l$ =Amplitude from the crest to trough (3km)

w =wavelength (50 km)

λ_r =thermal conductivity of the rock ($4 \text{ Wm}^{-1} \text{ K}^{-1}$)

λ =thermal conductivity of sediments ($2 \text{ Wm}^{-1} \text{ K}^{-1}$)

Maxwell and Revelle, 1956

If $l/w \ll 1$ heat flow through the crests exceeds that through the troughs:

$$\frac{\partial Q}{Q} = \frac{2\pi l(\lambda_r - \lambda)}{w\lambda}$$

Q =mean heat flow

Heat Generation of sediments

Heat generation of sediments changes with lithology: lowest in evaporites and carbonates, low to medium in sandstones, higher in shales and silstones, and very high in black shales.

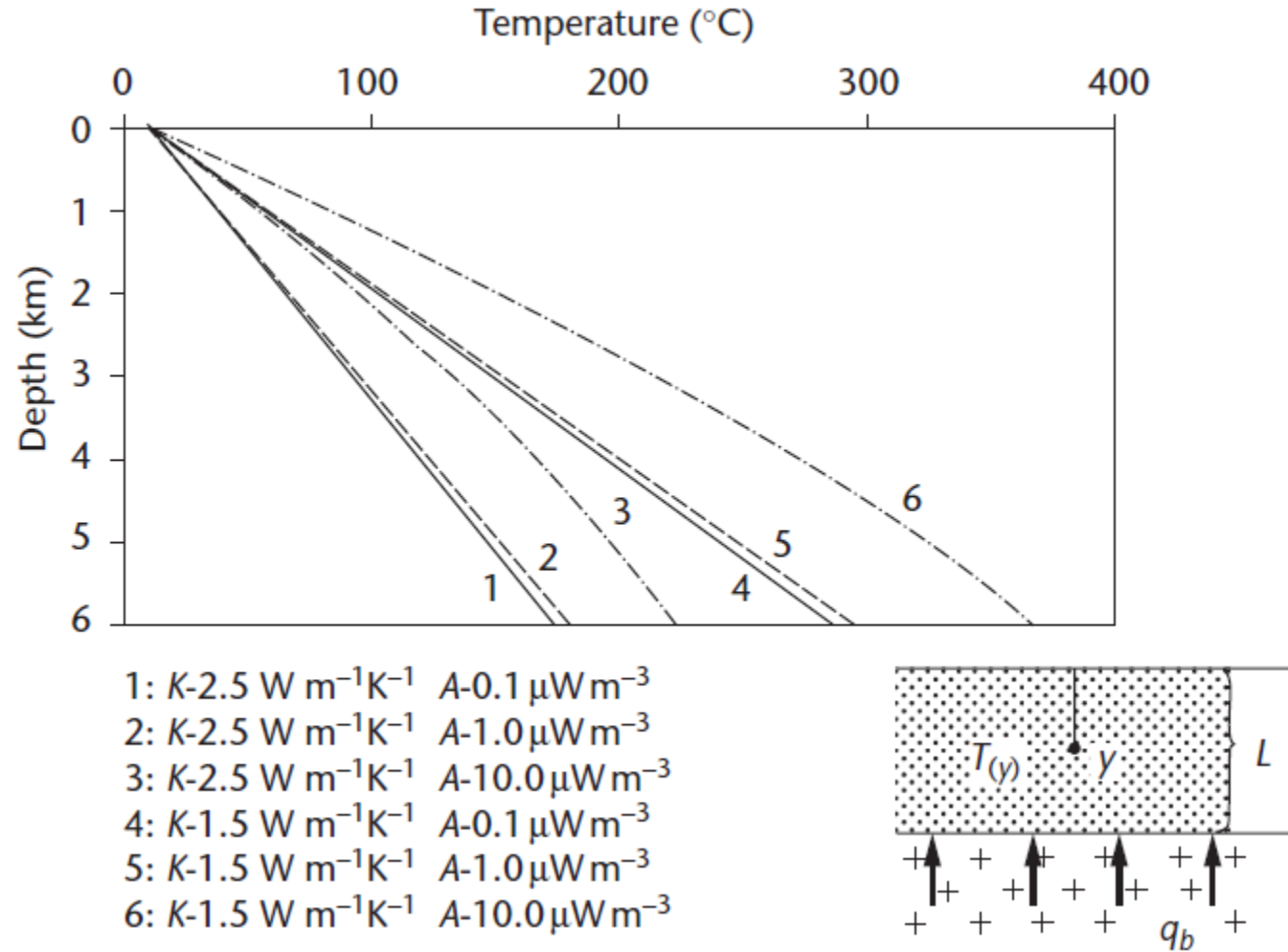

$$q_b = 70 \text{ mW m}^{-2}$$

Heat Generation and thermal conductivity of sediments

(a)

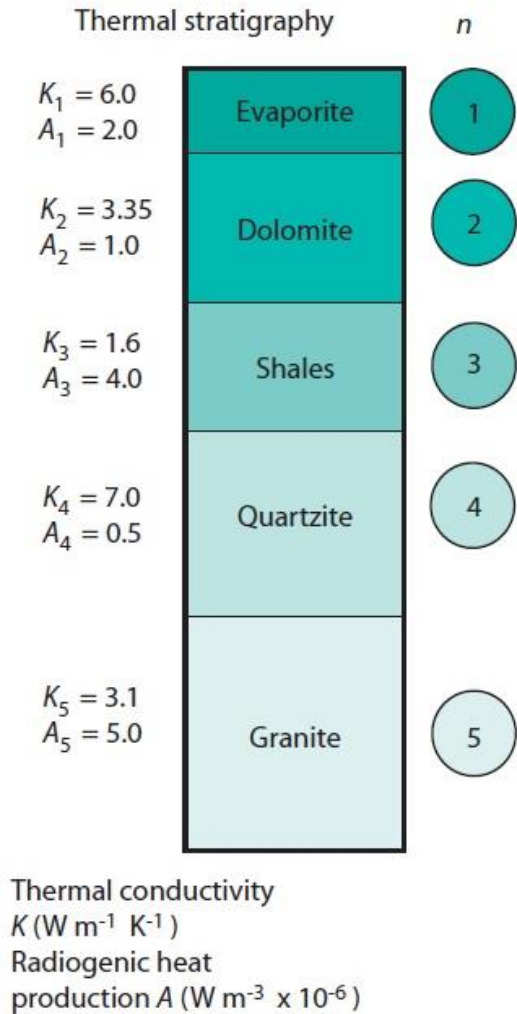

(b)

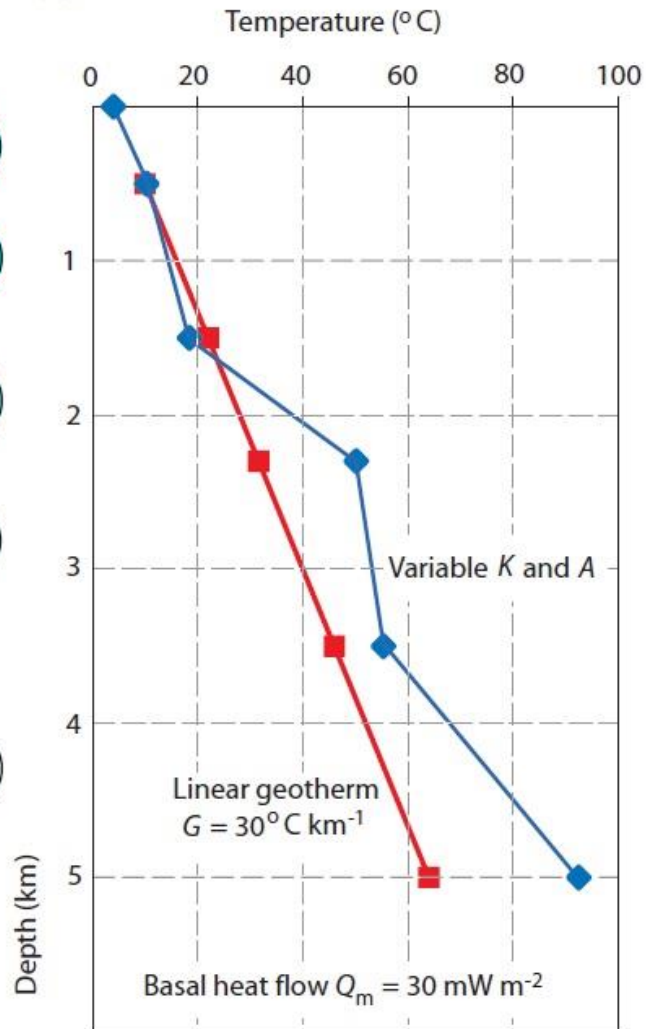

Neglecting radiogenic heat production within the basin-fill, the geotherm in a basin with different thermal conductivities of sedimentary layers is given by:

$$T_y = T_0 + (-q) \left\{ \frac{l_1}{K_1} + \frac{l_2}{K_2} + \frac{l_3}{K_3} + \dots \right\}$$

Considering radiogenic heat production variable in each layer:

$$T = T_0 + \left(\frac{q_m + A y_c}{K} \right) y - \frac{A}{2K} y^2$$

$$T_y = T_0 + \left\{ \left(\frac{q_m + A_1 y_c}{K_1} \right) l_1 + \left(\frac{q_m + A_2 y_c}{K_2} \right) l_2 + \dots \right\} - \left\{ \frac{A_1}{2K_1} l_1^2 + \frac{A_2}{2K_2} l_2^2 + \dots \right\}$$

y_c becomes the sum of the sedimentary layers of thickness $l_1 + l_2 + \dots + l_n$ if the geotherm is calculated for the basin-fill only.

Sediments and heat

- The part of the basin with the greatest sediment thickness is characterized by the fastest rate of heating (temperature increase), since T increases with depth and sedimentary rocks have minimal values of heat conductivity among crustal rocks, and thus by the fastest increase in pressure (overpressure) .
- The values of thermal expansion α for the main sedimentary rocks are within the range of $(2.4-3.3) \times 10^{-5} \text{ K}^{-1}$ and their value is almost one order greater for wet clays ($\sim 1-2 \times 10^{-4} \text{ K}^{-1}$). Thus, for rocks heated by $\sim 100 \text{ K}$ (e.g., at a depth of 6 km in the South Caspian Depression) α will be about 0.24–0.33 % for brittle rocks and $\sim 1-2 \%$ for plastic rocks, which makes the total surface uplift $\sim 2.4-3.3 \text{ m}$ for brittle sedimentary rocks and 10–20 m for plastic sedimentary rocks for each 1 km of thickness of sedimentary rocks.
- The formation of pressure (overpressure) within any volume of a sedimentary layer surrounded by other volumes actually creates a situation in which the volume cannot expand, until the internal stress overcomes the external pressure on the volume in any direction.
- The absence of open porous spaces in the clay prevents the fluid expulsion during compaction, but favours overpressure conditions, which can contribute to significant tectonic effects, including the formation of faults, fractures, mud volcanoes, folding.

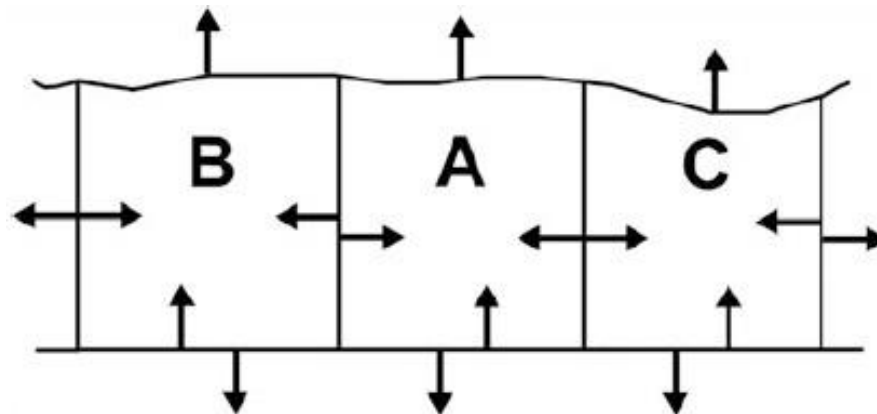

Heat absorption/release in the sedimentary layers

The second derivative of T with depth $\frac{d^2T_i(z)}{dz^2} = -\frac{A_i}{\lambda_i}$ (rate of change of the vertical gradient with depth) usually decreases with depth, but in some cases increases. This is because the crust is composed of layers which are absorbing (Q increases with depth) and releasing heat (Q decreases with depth).

In case of crustal layers absorbing heat:

$$Q_i(h_i) > Q_i(h_{i-1}) \quad \text{for} \quad A_i = 0 \quad \Delta Q = Q_i(h_i) - Q_i(h_{i-1}).$$

$$\text{for } A_i \neq 0 \quad Q_i(h_{i-1}) < Q_i(h_i) + A_i(h_i - h_{i-1})$$

$$\Delta Q = Q_i(h_{i-1}) - Q_i(h_i) < A_i(h_i - h_{i-1})$$

In case of crustal layers releasing heat: $Q_i(h_i) < Q_i(h_{i-1})$

In conditions of thermal equilibrium: $Q_i(h_i) = Q_i(h_{i-1})$

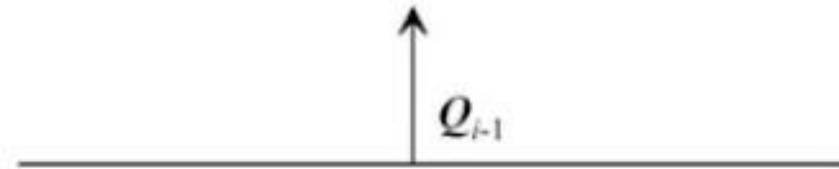

$$A_i(h_i - h_{i-1})$$

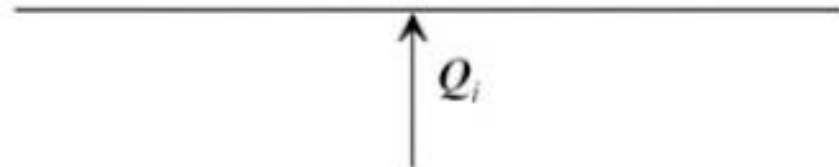

Heat absorption/release in the sedimentary layers

Values of heat flow density in the Saatly super-deep SG-1 borehole (after Pilchin 1983)

Depth interval (m)	Stratigraphy	Lithology	Heat flow density (mWm^{-2})
800–2,150	Apsheron	Siltstones, aleurites, clays	18.0
2,150–2,320	Akchagyl	Clays	17.2
2,320–2,600	Productive layers	Sands, sandstones, clays, conglomerates	19.7
2,600–2,765	Productive layers	Same	11.3/23.0
2,765–2,896	Sarmatian	Sandstones, clays, tuffs	30.6
2,896–3,500	Upper Cretaceous	Limestone, sandstones, tuffs	35.6
3,500–4,400	Volcanogenic layers	Basalts, porphyrites	51.1
4,400–5,000	Volcanogenic layers	Basalts, porphyrites	96.7
5,000–5,650	Volcanogenic layers	Basalts, porphyrites	36.4

In this example, there is a clear alternation of layers absorbing heat and layers releasing heat, with a general increase of heat flow with depth (heat absorption).

- **Heat absorption takes place also for huge regions:** e.g., in the Middle Kura Depression, it increases from 33.5 mW m^{-2} at 10–1,000 m to 75.4 mW m^{-2} at 4,001–5,000 m and in the Dnieper-Donets Depression (Ukraine) increases from $15.0\text{--}31.0 \text{ mW m}^{-2}$ at 25–50 m to $33\text{--}46 \text{ mW m}^{-2}$ at over 1,000 m.
- **Heat absorption is not found exclusively in the sedimentary layers, but also in the crystalline crust** (e.g., the whole crystalline shield of the Ukraine is characterized by Q values that are about 10–15 % lower at depths of 100–150 m and in some areas up to 20–30 % lower at depths up to 300–350 m than at deeper layers).

Heat absorption/release in the sedimentary layers

Well-logs of Petrovsko-Blagodarnenskaya area of Stavropol province

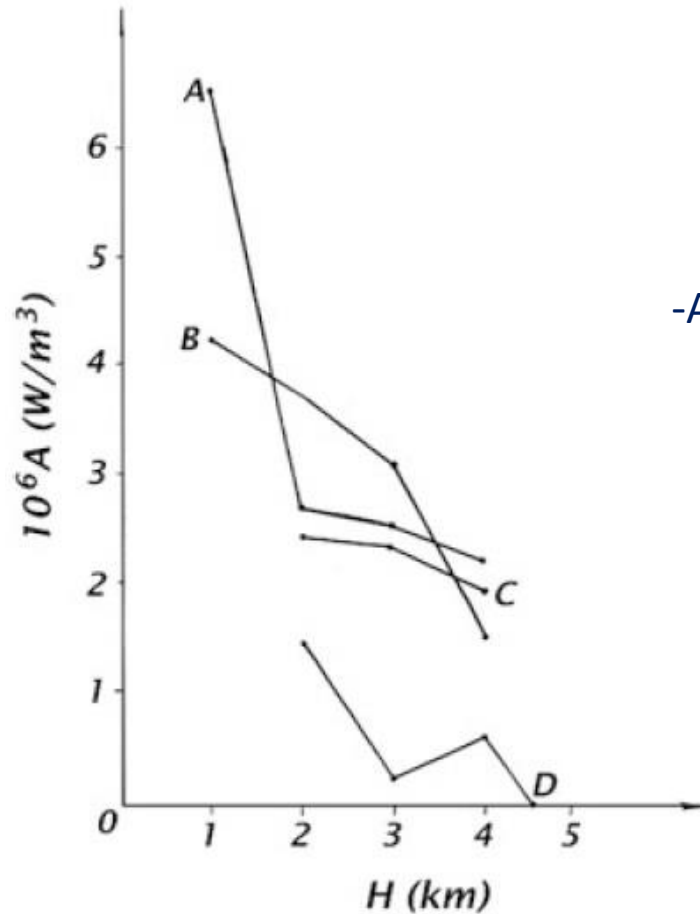

$-A/\lambda > 0$ (heat absorption)

$-A/\lambda < 0$ (heat release)

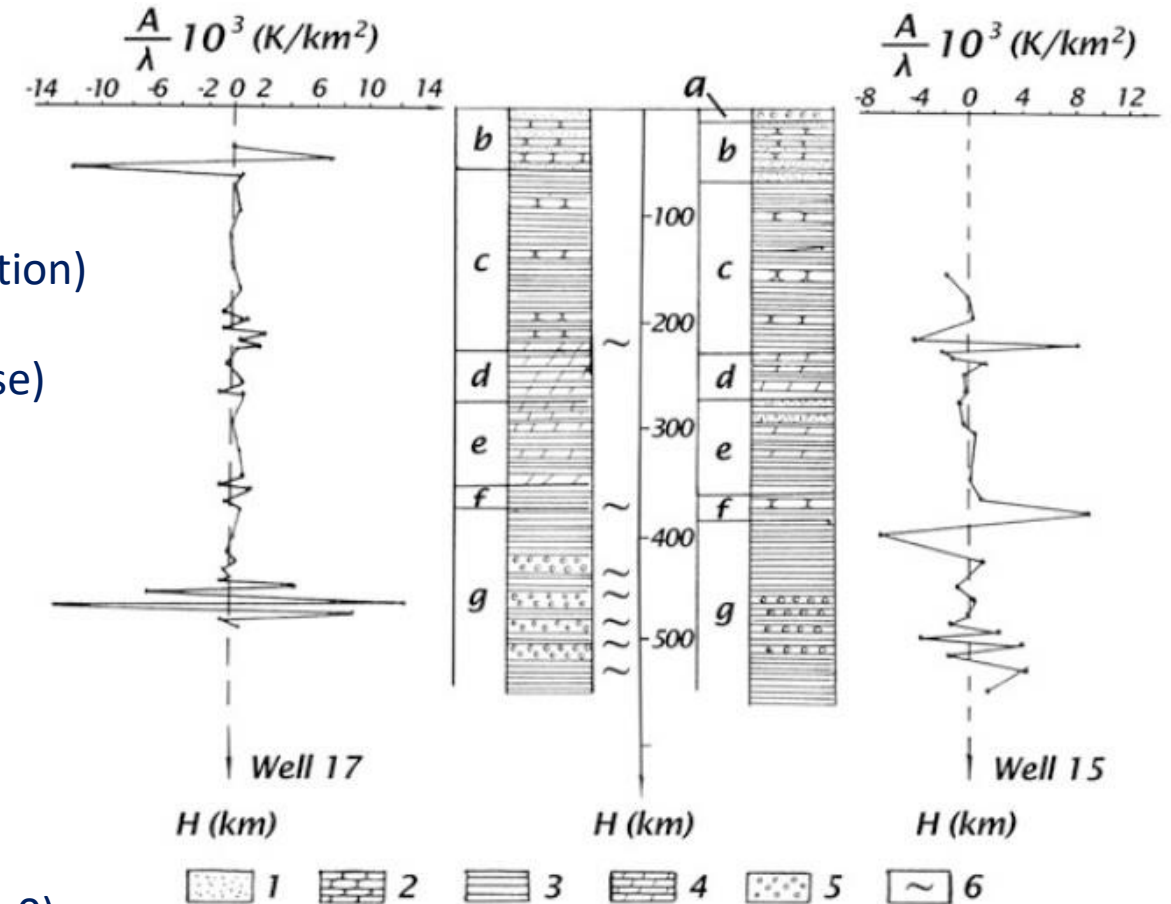

Example **D** shows sub-layers which evidence an equilibrium ($-A/k = 0$)

Area of Kura depression (Azerbaijan): (A) Agdzhabedy-Beilagan (Zardob); (B) Kirovabad (Ganja); (C) Kurdamir; (D) Sal'yani-Karabagly (after Pilchin 1979).

Lithology: (1) sand, (2) sandstone, (3) clay, (4) marl, (5) siltstone, (6) water-bearing horizons. **Stratigraphy:** (a) quaternary, (b) upper Sarmatian (Miocene), (c) middle Sarmatian (Miocene), (d) lower Sarmatian and Konkskiy horizon (Miocene), (e) Karaganskiy horizon (Miocene), (f) Chokracskiy horizon (Miocene) and (g) Maykop suite (Oligocene-Miocene).

Steady vs Transient Geotherms

- Few processes in sedimentary basins are in steady state
- Depositional, erosional and diagenetic changes are all followed by thermal adjustment

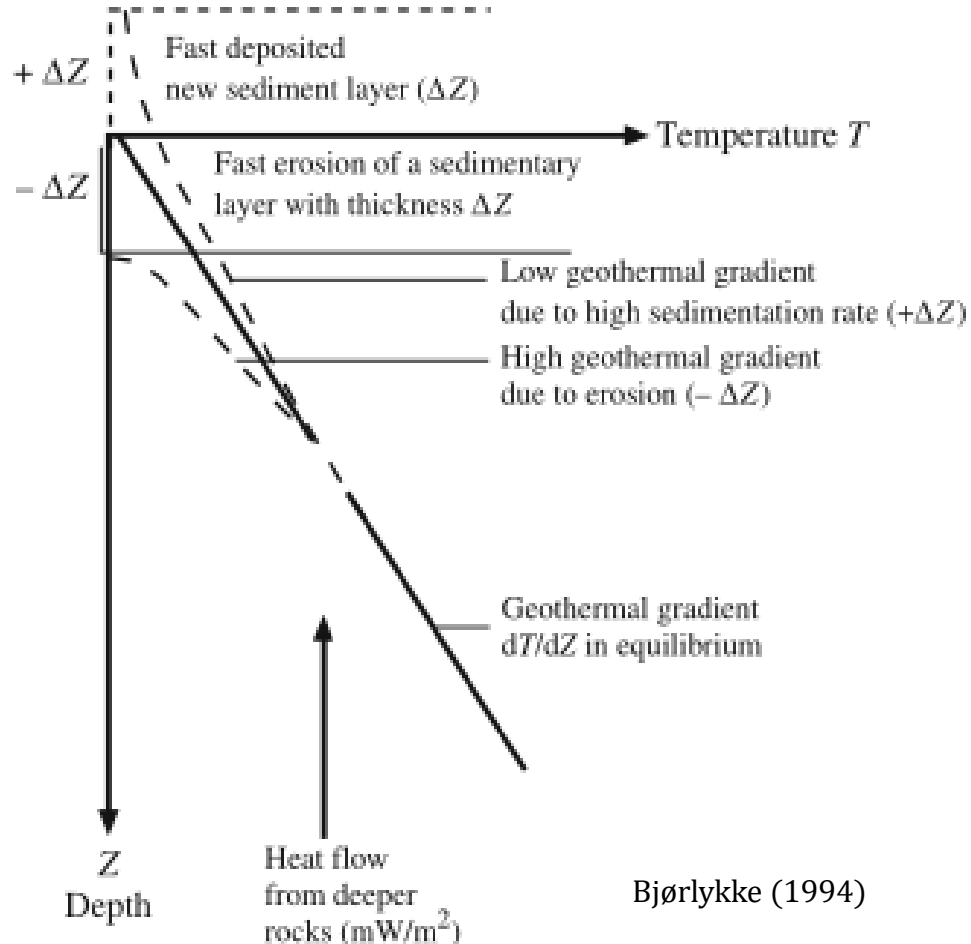

During Subsidence:

$$Q_s = Q_b - F_s \cdot C_{(hc)} \cdot dT/dZ$$

- During subsidence and sedimentation the sediments must be heated, and this heat is taken from the background heat flow and the geothermal gradient is reduced.

During Uplift:

$$Q_s = Q_b + F_{ur} \cdot C_h dT/dZ$$

- When rocks are uplifted and cooled the heat given off from the cooling rocks adds to the background heat flow.

F_s = rate of subsidence $C_{(hc)}$ = Heat capacity of the bulk rock

F_{ur} = rate of uplift

Temperature in sedimentary basins (transient effects)

Transient effects are due to: (1) advective flow of heat through regional aquifers: low surface heat flow at regions of recharge and high surface heat flow at regions of discharge (2) blanketing effects.

Blanketing effect of sediments

Deposition of sediments produce:

- 1) A transient cooling and reduction in the surface heat flow
- 2) A possible long-term warming, depending on the thermal conductivity and internal heat generation

Departure from the steady-state thermal conditions (transient effects) depends on:

- (i) Deposition rate, transient effects if > 0.1 mm/yr (thermal response of instantaneous deposition of 1km of sediments is > 1 Myr)
- (ii) Thermal conductivity of sediments (highly porous, uncompacted marine shales act as strong insulators).

Transient Effects: Sedimentation

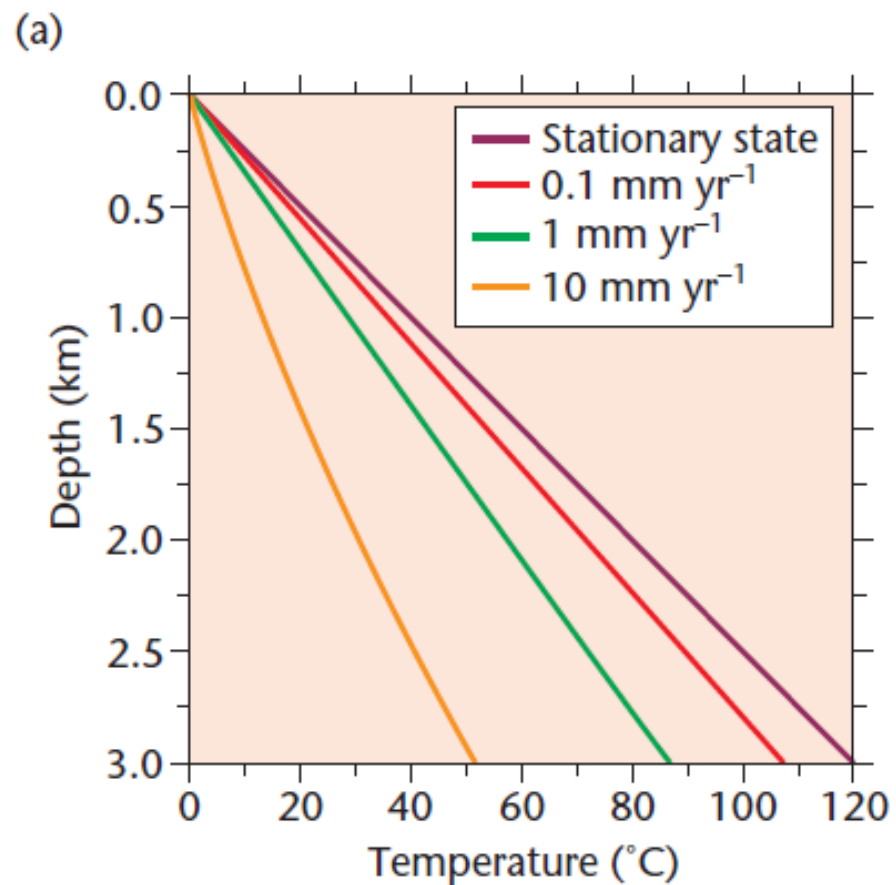

Geotherms at the time when 3 km of sediment has been deposited (30 Myr, 3 Myr and 0.3 Myr respectively).

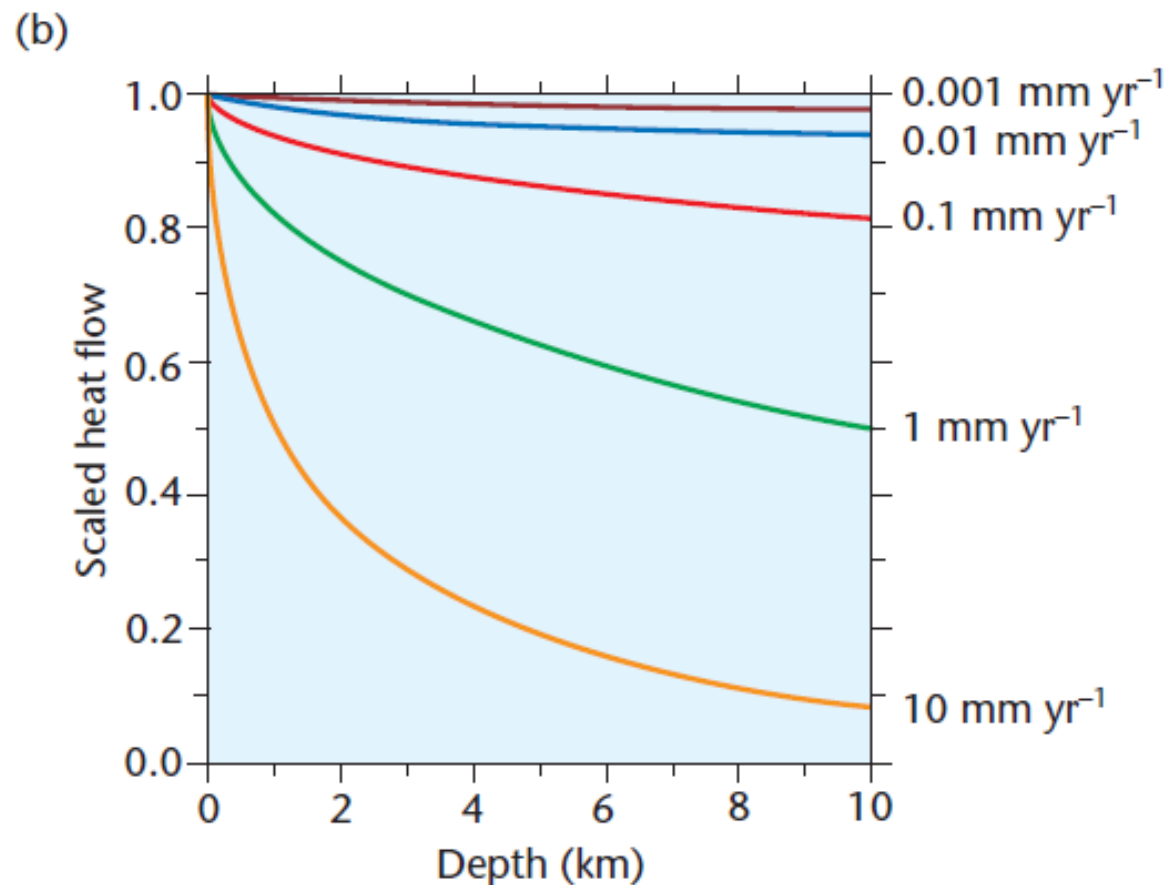

Basin thickness is the product of the sedimentation velocity and time

Effect of erosion and sediment blanketing on the geotherm

Steady-State geotherms (without sedimentation/erosion)

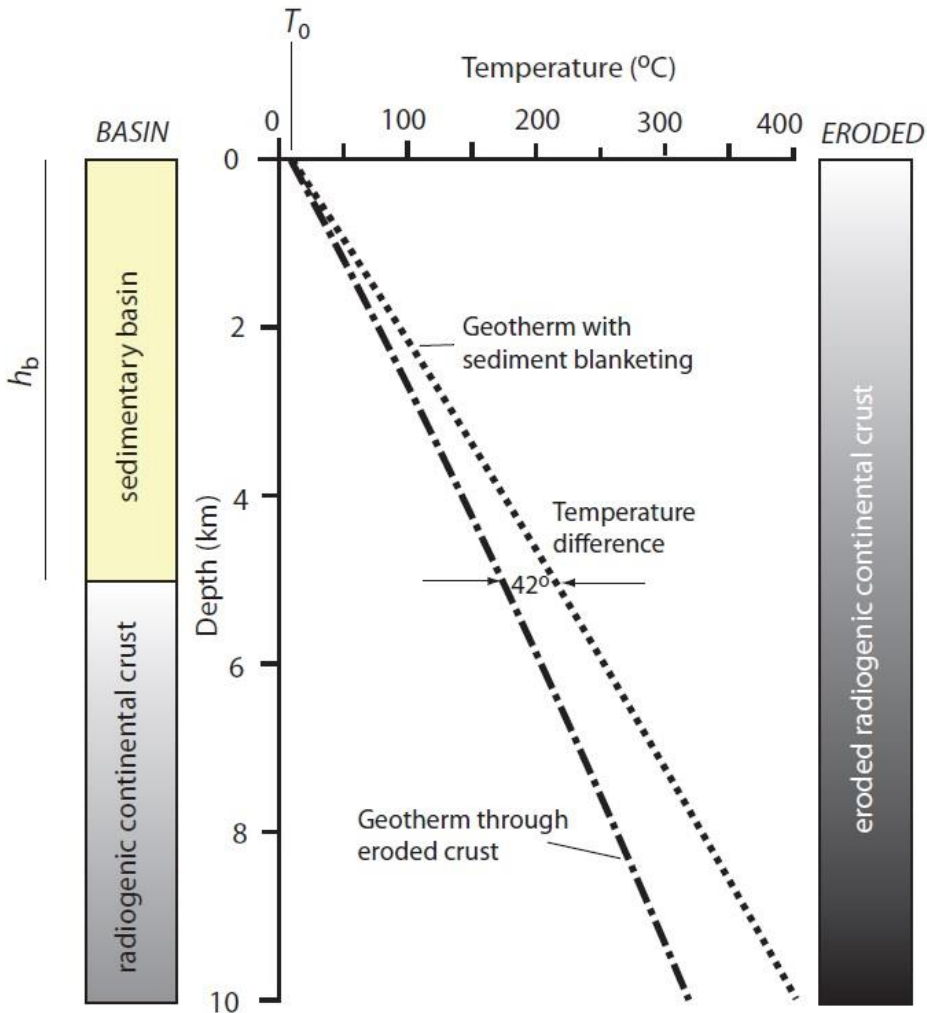

$$\frac{\partial^2 T}{\partial y^2} = -\frac{A}{K} \quad \frac{\partial T}{\partial y} = -\frac{A}{K}y + c_1$$

$$T = -\frac{A}{2K}y^2 + \frac{Q_0}{K}y + c_2 \quad T = T_0 + \frac{Q_0}{K}y - \frac{A}{2K}y^2$$

$$c_1 = \frac{Q_m}{K} + \frac{A}{K}y_c \quad T = -\frac{A}{2K}y^2 + \frac{(Q_m + Ay_c)}{K}y + c_2$$

$$T = T_0 + \frac{(Q_m + Ay_c)}{K}y - \frac{A}{2K}y^2$$

Steady-State geotherms (with sedimentation/erosion)

$$T = T_0 + \frac{\{q_m + A(y_c - h_e)\}}{K}y - \frac{A}{2K}y^2$$

h_e = thickness of the layer eroded

$$T = T_0 + \frac{\{q_m + A(y_c + h_b)\}}{K}y - \frac{A}{2K}y^2$$

h_b = thickness of the layer deposited

$$\Delta T = \frac{A}{K}y(h_b + h_e)$$

$$A_0 = 2.5 \mu\text{Wm}^{-3} \quad K = 3 \text{Wm}^{-1}\text{K}^{-1} \quad T_0 = 10^\circ\text{C}$$

Effect of erosion and sediment blanketing on the geotherm

The temperature following erosion (deposition) by an amount (thickness) l (h) is the sum of the steady state and transient solution

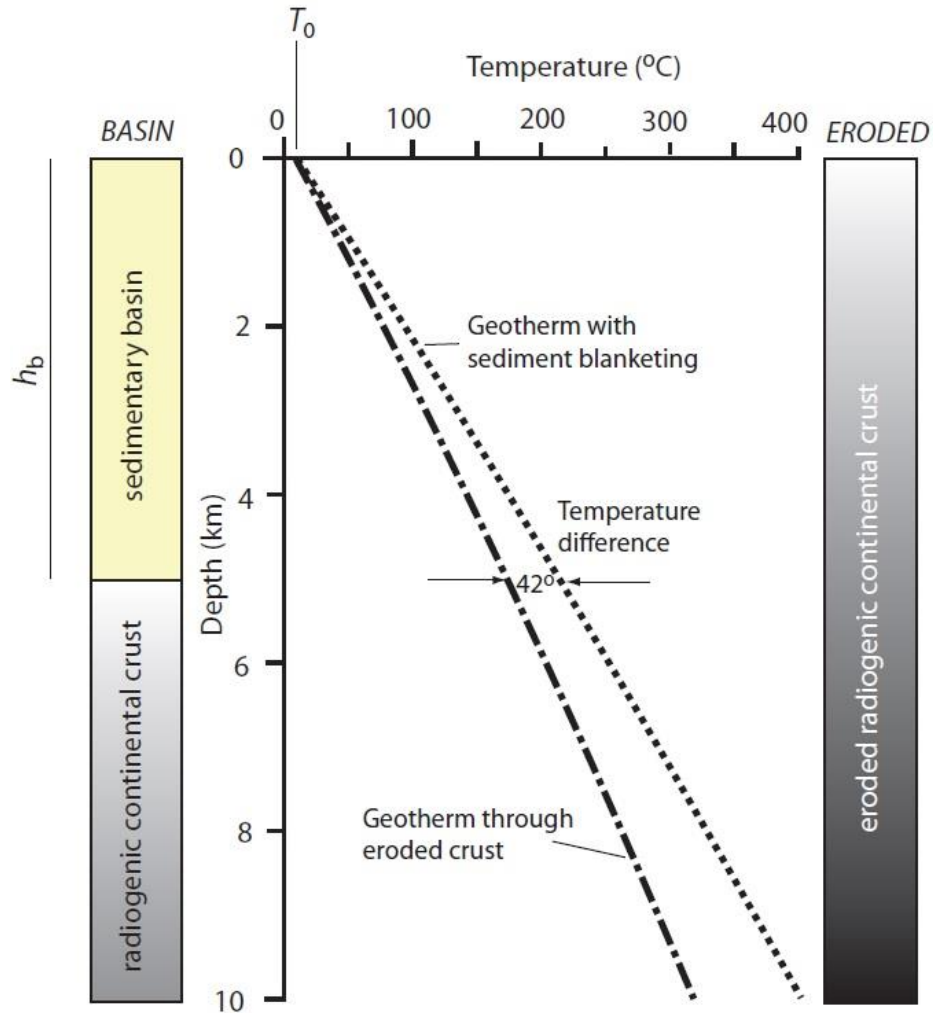

$$A_0 = 2.5 \mu\text{Wm}^{-3} \quad K = 3 \text{Wm}^{-1}\text{K}^{-1} \quad T_0 = 10^\circ\text{C}$$

Transient Geotherms

Erosion

$$T(y, t) = T_0 + G(y + l) - G \text{erfc} \left(\frac{y}{2\sqrt{Kt}} \right)$$

Deposition

$$T(y, t) = T_0 + G(y - h) + G \text{erfc} \left(\frac{y}{2\sqrt{Kt}} \right)$$

G = geothermal gradient

Effect of instantaneous erosion and deposition

1 km of sediments are eroded

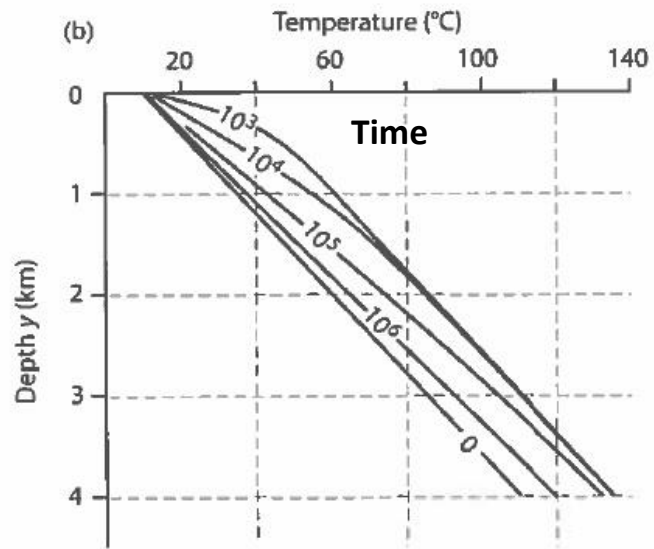
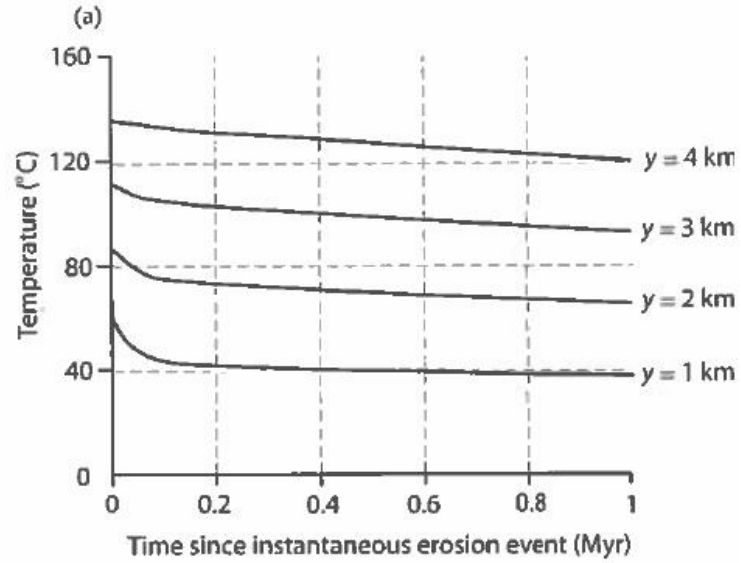

1 km of sediments are deposited

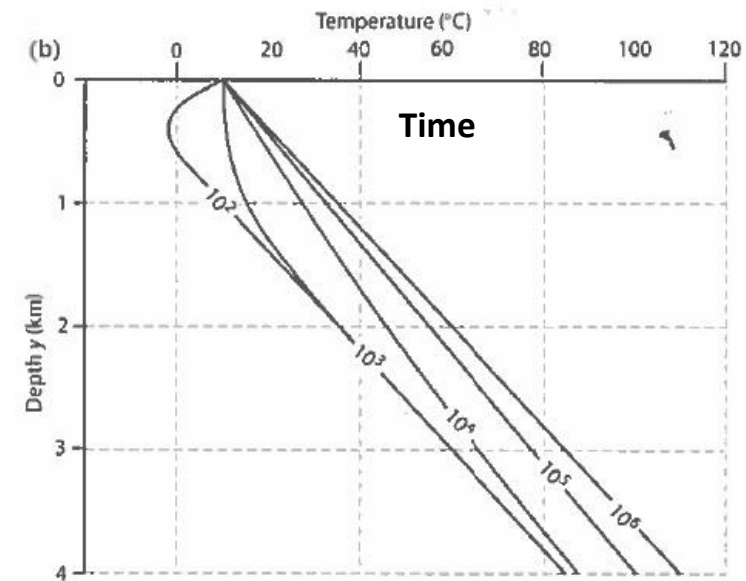
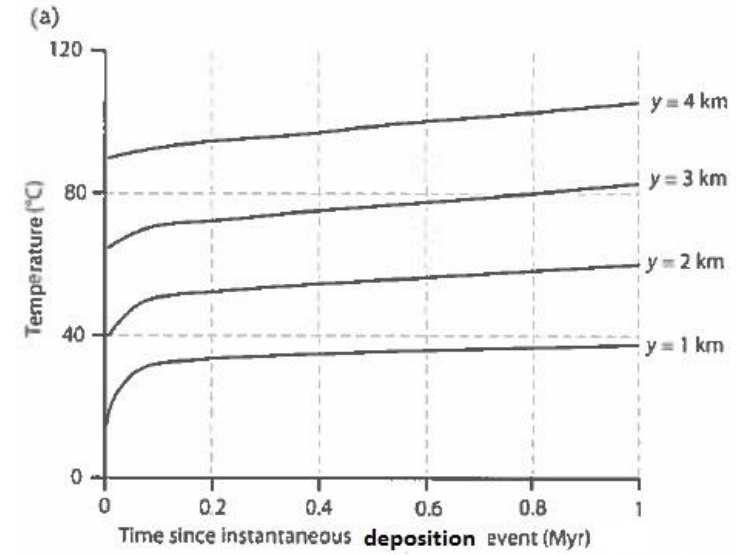

$$T_0 = 10^\circ\text{C}, \Delta t / \Delta z = 25^\circ\text{C}/\text{km}, \kappa = 10^{-6} \text{m}^2/\text{s}$$

Transient Effects: Sedimentation

Effect of a constant sedimentation rate on surface heat flow

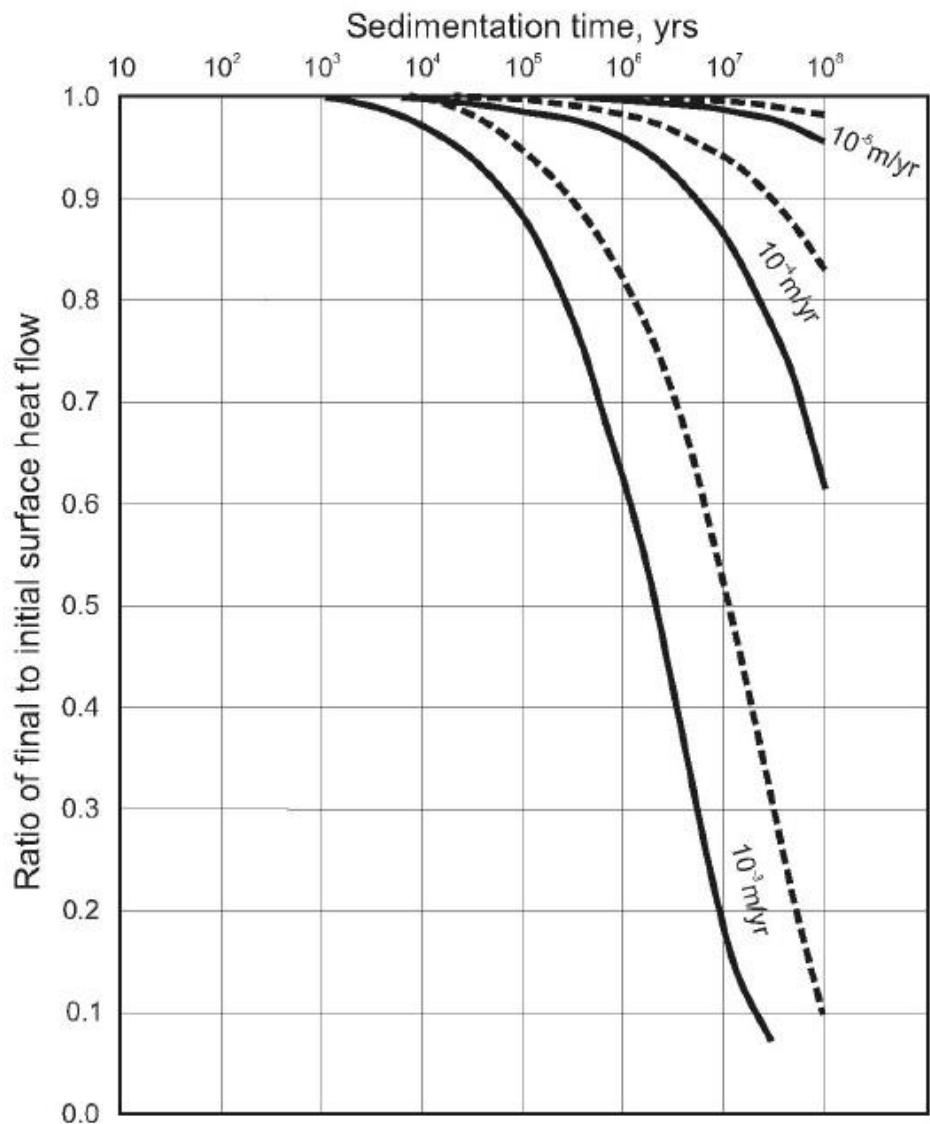

Effect on surface heat flow after sudden deposition

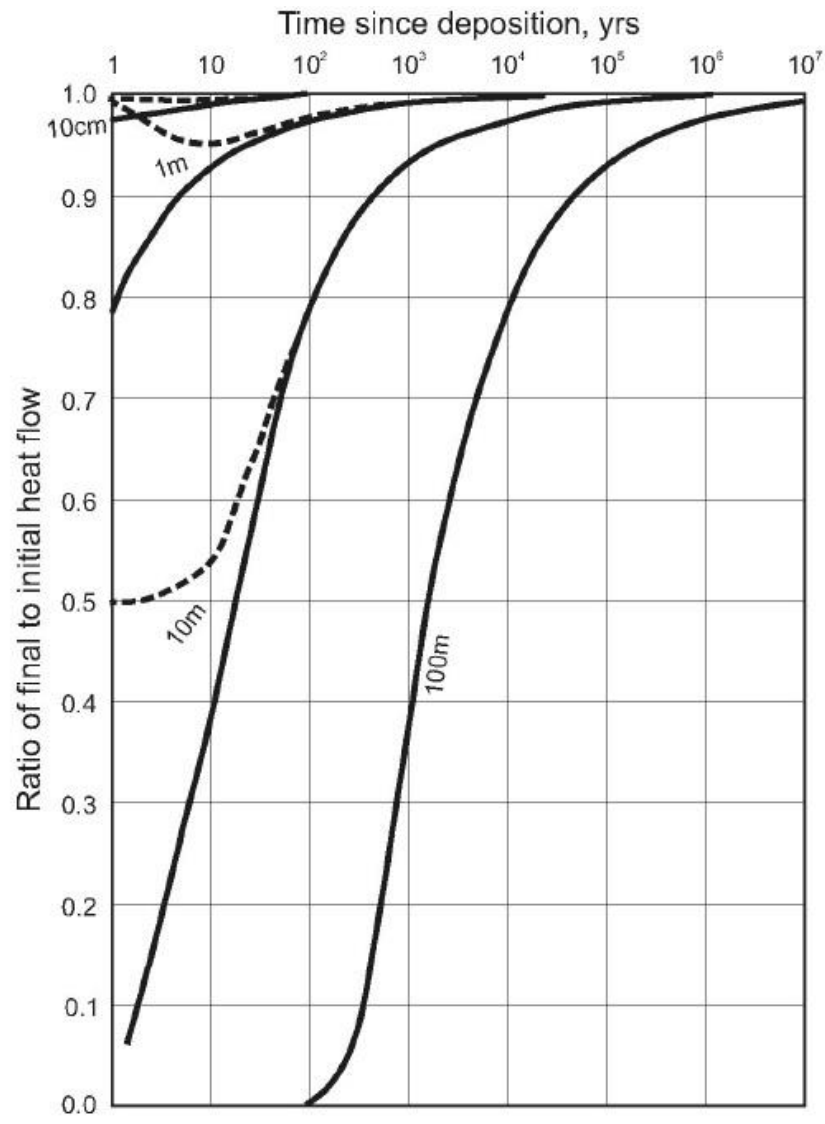

— $\kappa=2 \times 10^{-7} \text{ m}^2/\text{s}$

- - - $\kappa=1.2 \times 10^{-6} \text{ m}^2/\text{s}$

— 10 m depth

- - - 1 m depth

Transient Effects: Burial and Erosion

During burial/erosion pressure changes are instantaneous, while temperature variations are delayed

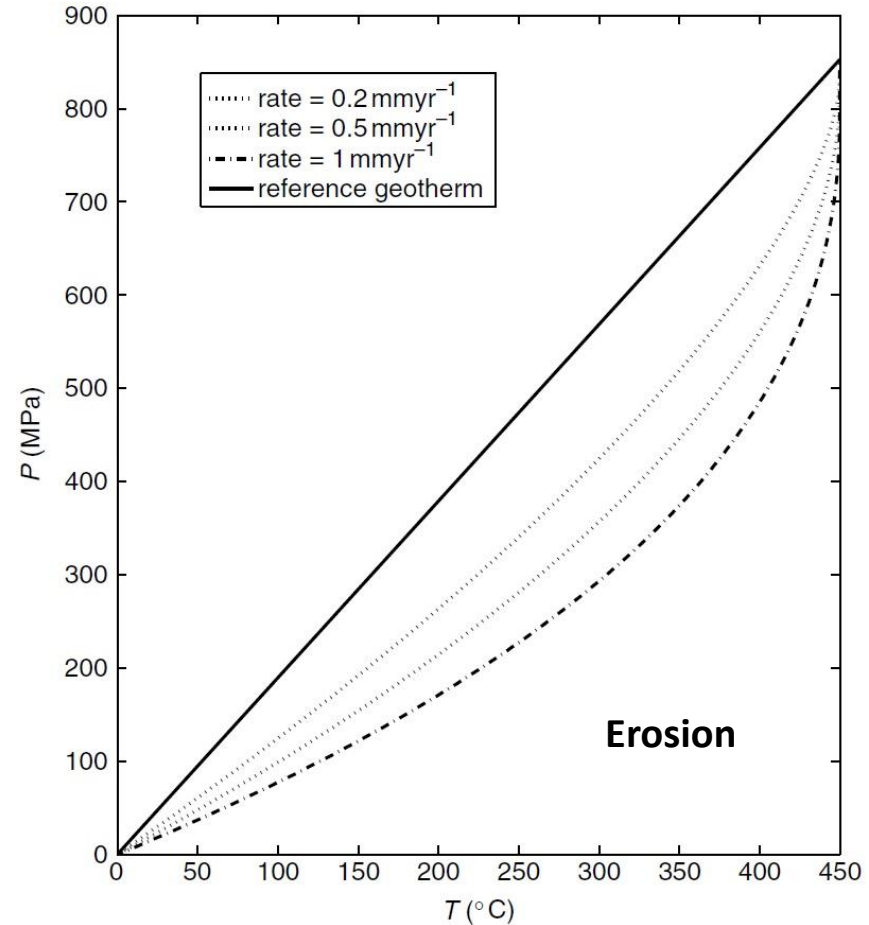
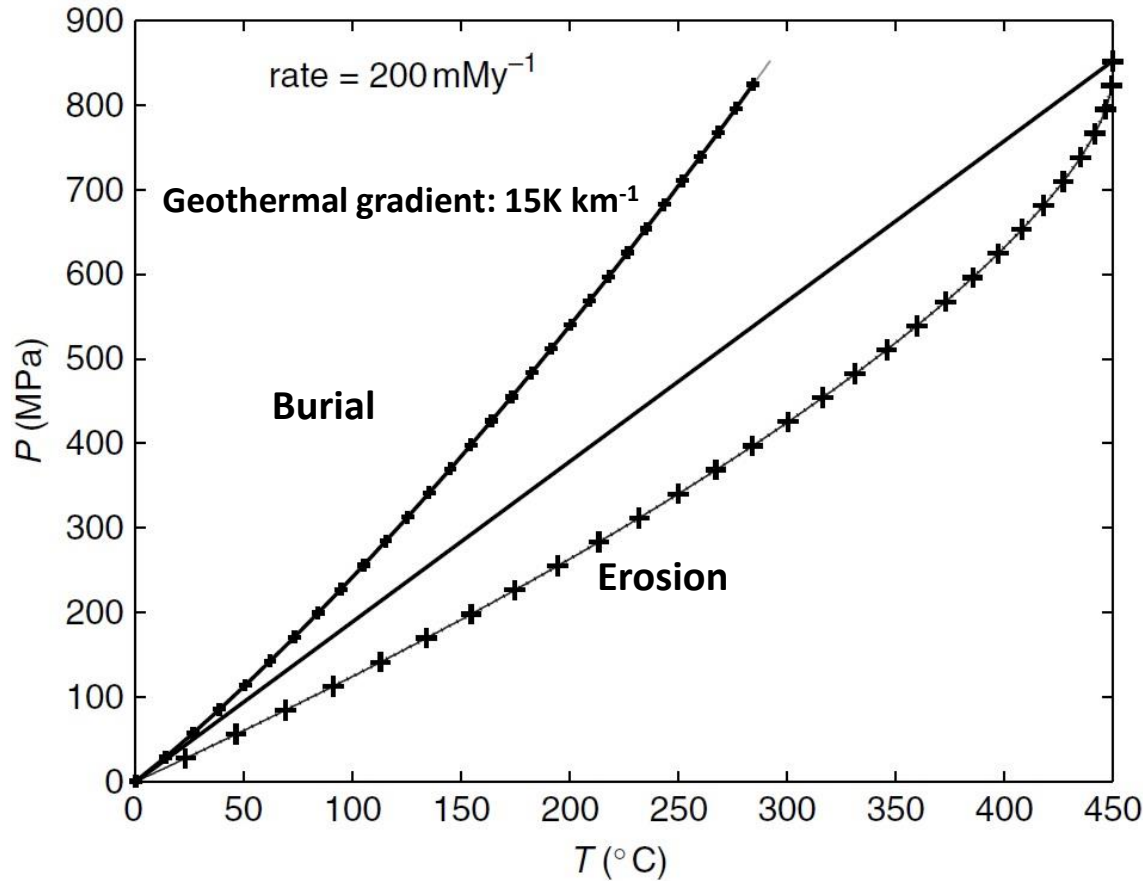

$$T(z, t) = \Gamma(z - vt) + \frac{\kappa A t}{\lambda} + \left(\frac{\Gamma}{2} - \frac{\kappa A}{2v\lambda} \right) \left((z + vt) \exp\left(\frac{vz}{\kappa}\right) \operatorname{erfc}\left(\frac{z + vt}{2\sqrt{\kappa t}}\right) + (vt - z) \operatorname{erfc}\left(\frac{z - vt}{2\sqrt{\kappa t}}\right) \right)$$

v > 0 Sedimentation

v < 0 Erosion

Heat Advection vs Heat Conduction: Péclet Number

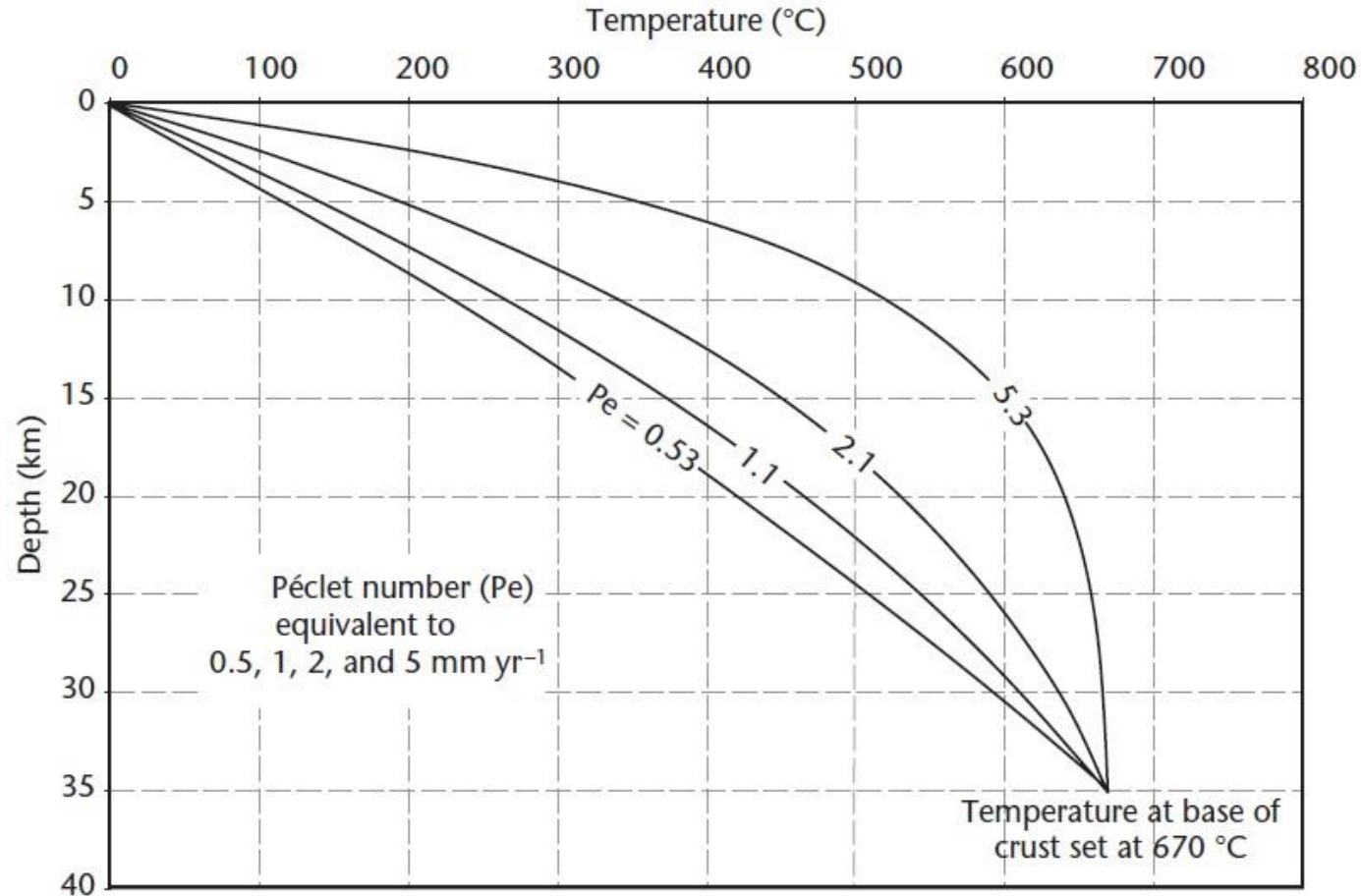

$$Pe = \frac{EL}{\kappa}$$

E =Exhumation rate

L =depth to a lower boundary (e.g., base of the crust)

- At high exhumation rates, the upward advection of hot rock towards the surface outweighs the conductive cooling, causing highly curved geotherms.
- In the case of high exhumation rate, the geothermal gradient changes from 40–60 °C km⁻¹ in the upper 5 km of the crust to <10 °C km⁻¹ in the lower crust.

Advection and diffusion of heat

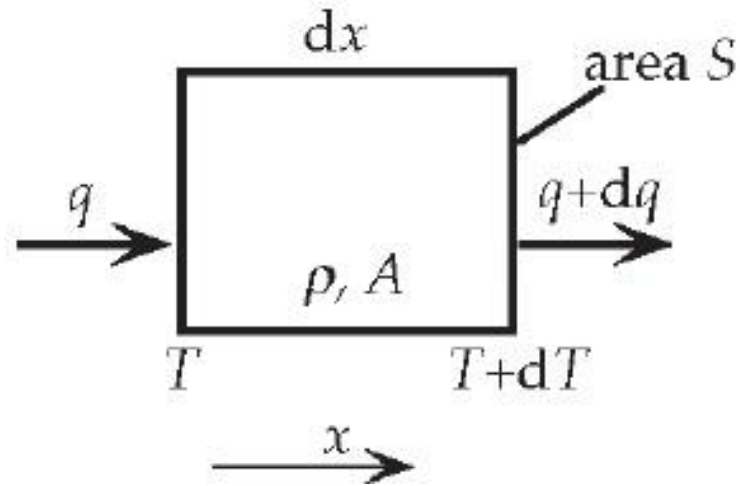

$$dH = \rho S dx \cdot C_p \cdot dT$$

If in addition to heat conduction there is a flow of a fluid at different T , with velocity v in the positive x direction, heat conduction equation becomes:

$$\rho S dx \cdot C_p \cdot dT = q S dt - (q + dq) S dt + A \cdot S dx \cdot dt + Sv dt \cdot \rho C_p T - Sv dt \cdot \rho C_p (T + \Delta T)$$

$$\rho C_p \frac{\partial T}{\partial t} = -\frac{\partial q}{\partial x} + A \left[-\rho C_p v \frac{\partial T}{\partial x} \right] \longrightarrow \frac{\partial T}{\partial t} + v \frac{\partial T}{\partial x} = \kappa \frac{\partial^2 T}{\partial x^2} + a$$

This equation governs the evolution of temperature in the presence of advection, diffusion (conduction) and internal heat generation.

Rift Basins

- Rifts are regions of extensional deformation, where the entire lithosphere has deformed under deviatoric tension.
- Extension may lead to lithospheric rupture and formation of a new oceanic basin and a rifted continental margin or aborted rifts (alaucogens).
- High surface heat flow (90-110 mWm⁻²).
- High level of earthquake activity mainly concentrate in the crust (< 30 km) and Mw < 6.
- Moho elevated (e.g., Upper Rhine Gaben).
- Crust and mantle lithosphere moderately or largely thinned
- Normal dip-slip faults and strike-slip faults.

EXTENSIONAL BASINS

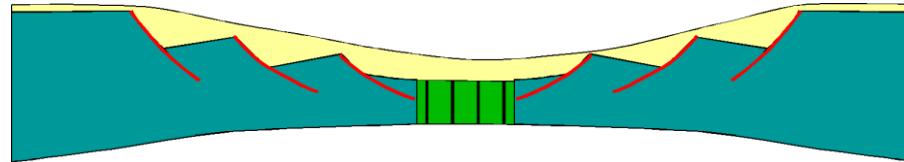

Two main time intervals

- **During rifting** normal faults develop. Accommodation space is created by two processes, A) the movement of fault blocks, B) the thinning of the crust and lithospheric mantle
- **Following rifting**, no faults are active. Accommodation space is created by the decay of the thermal anomaly present at the end of rifting

Rift Basins formation

Case A: Active Rifting

It develops in response to mantle upwelling (impingement on the base of the lithosphere of a thermal plume, as in the East African Rift).

Case B: Passive rifting

It develops in response to lithospheric extension driven by far-field stress (e.g., Basin and Range). Volcanic activity and crustal doming are secondary process, which may follow but not precede it.

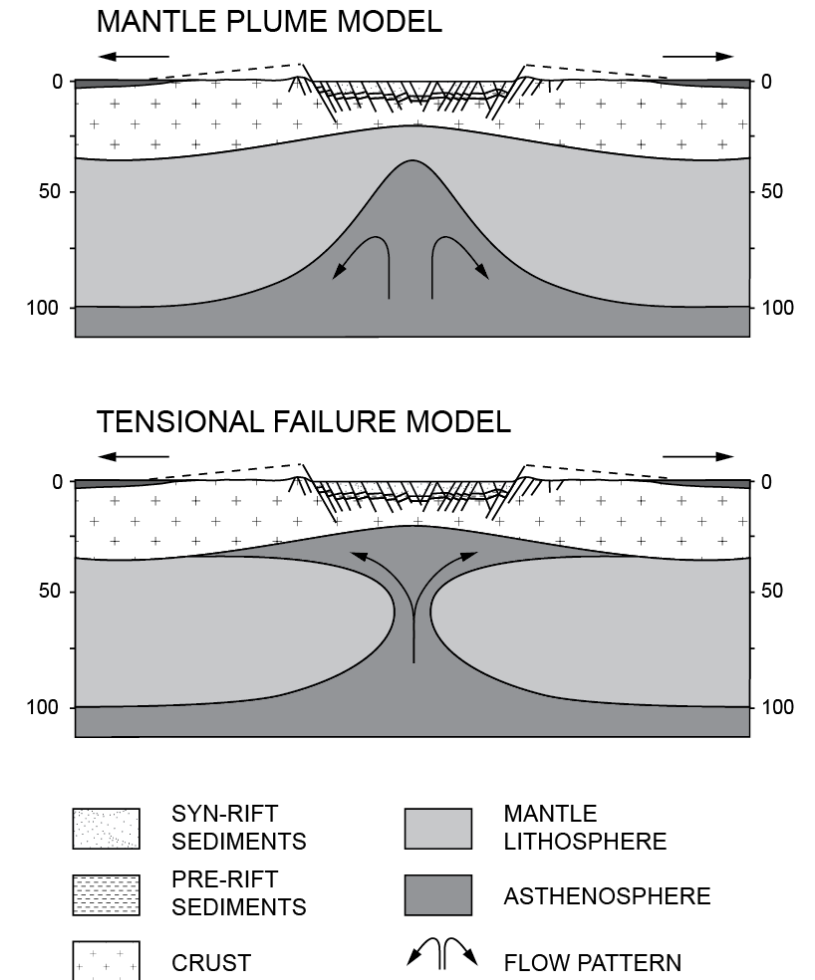

- In both cases, mantle uprising causes an initial phase of topography uplift, followed by cooling and subsidence
- Many rifts start with an initial “passive” phase and evolve in a more “active” stage when magmatic processes increase

Uniform Lithosphere Extension (McKenzie, 1978)

- Stretching is instantaneous and uniform with depth.
- Stretching occurs by pure shear, is symmetrical (no solid body rotation occurs), which result in steepening of the thermal gradient ($\beta dT/dz$).
- Initial fault-controlled subsidence depends on the initial ratio crustal/lithospheric thickness (C/L) and amount of stretching β .
- Thermal subsidence depends on the amount of stretching alone: heat flow reaches $1/e$ after 50 Myr for a standard lithosphere ($\tau=L^2/\pi^2k$).
- Necking depth (the depth in the lithosphere that remains horizontal during thinning if the effects of sediments and water loading are removed) is zero.
- Airy isostasy is assumed to operate during the syn-rift phase.
- There is no radiogenic heat production and no magmatic activity.
- Asthenosphere has a uniform temperature at the base of the lithosphere.

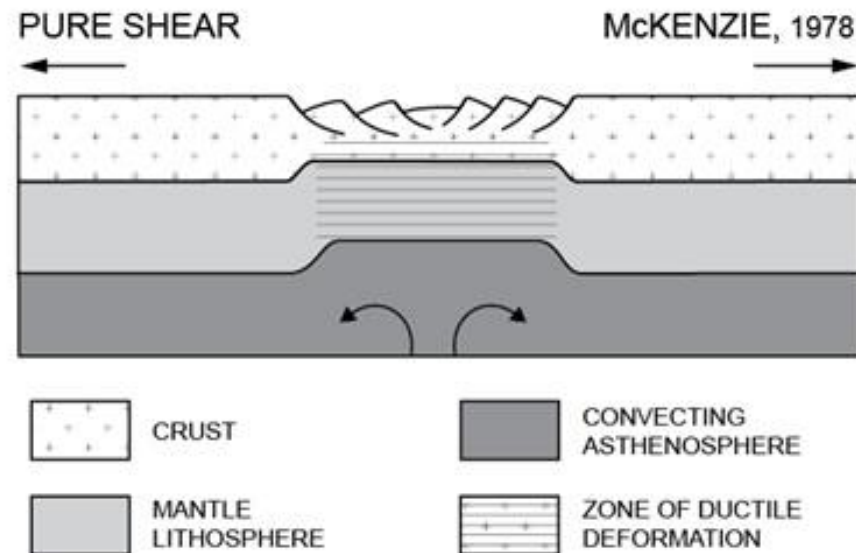

Strain

Stress and strain tensors are very different physical quantities:

- Stress characterizes the distribution of forces acting in a continuum at a given moment of time
- Strain quantifies in an integrated way the entire *deformation history* of the continuum from the initial state, up until this given moment.

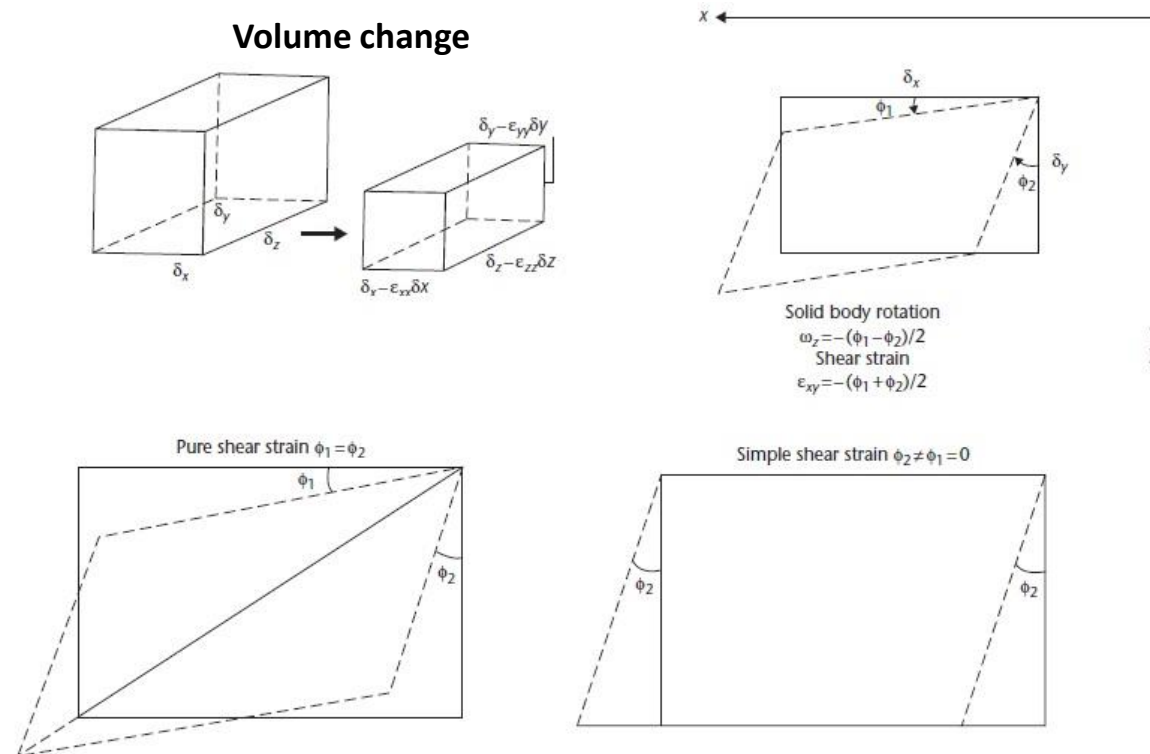

- Volume change or dilatation is the sum of the strain components ($\epsilon_{xx} + \epsilon_{yy} + \epsilon_{zz}$)
- Volume elements may change their position without changing their shape (Displacement)
- Shear strain may distort the shape of an element of a solid (e.g., rectangle) and is determined by the angles through which the sides of the rectangle are rotated (ϕ_1 and ϕ_2).
- If $\phi_1 = \phi_2$ no solid body rotation occurs, deformation is the result only of shear strains (pure shear: uniform extension with depth).
- If $\phi_2 \neq \phi_1 = 0$ the body has undergone simple shear (asymmetrical extension)

Uniform Lithosphere Extension

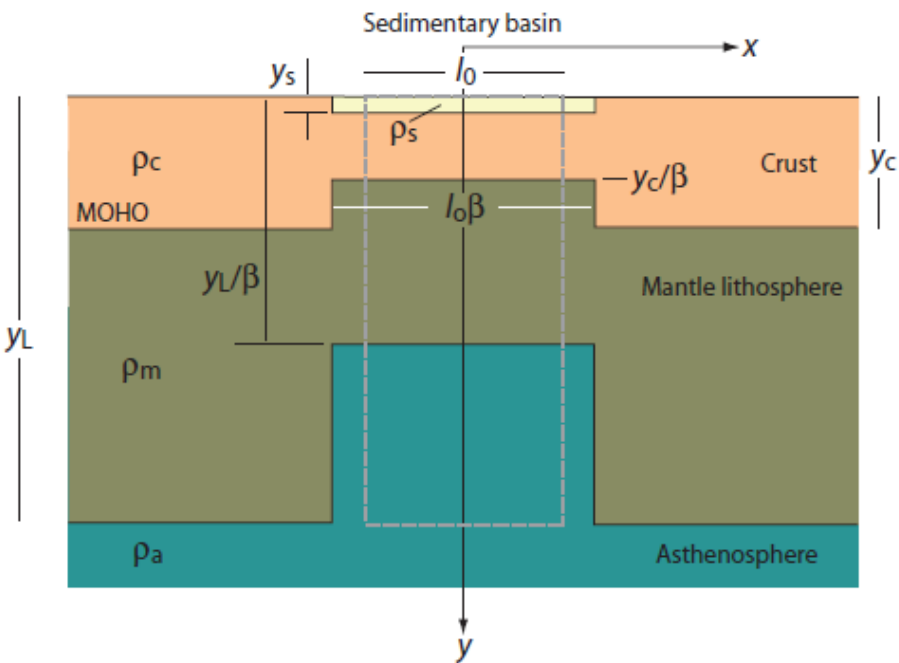

β =stretching factor

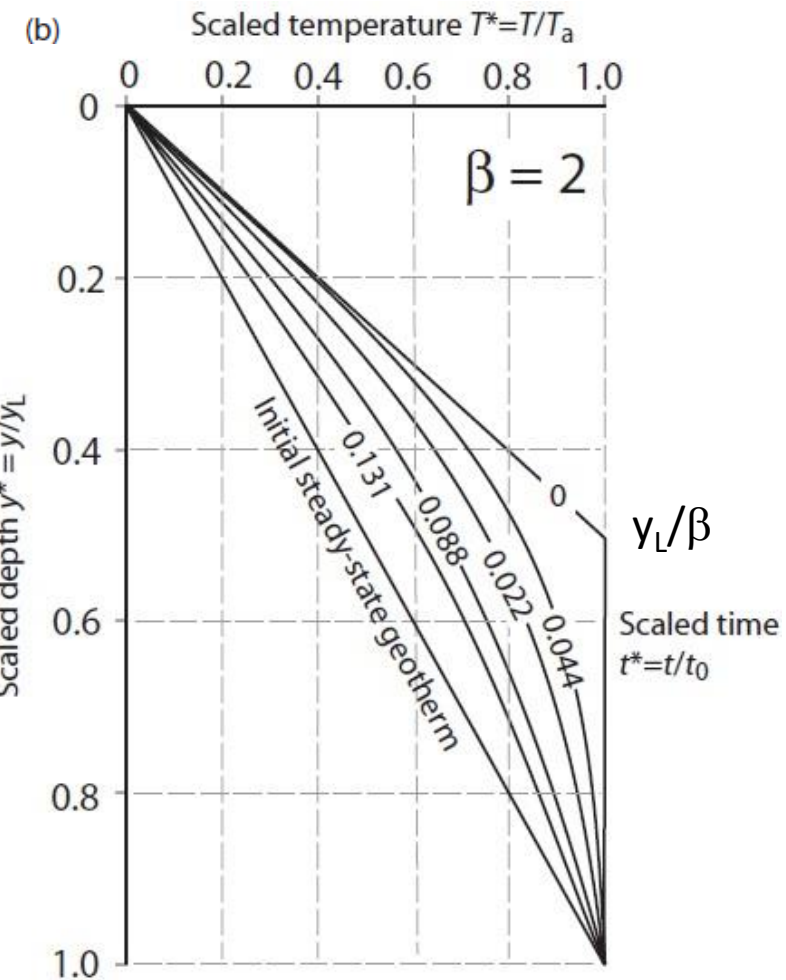
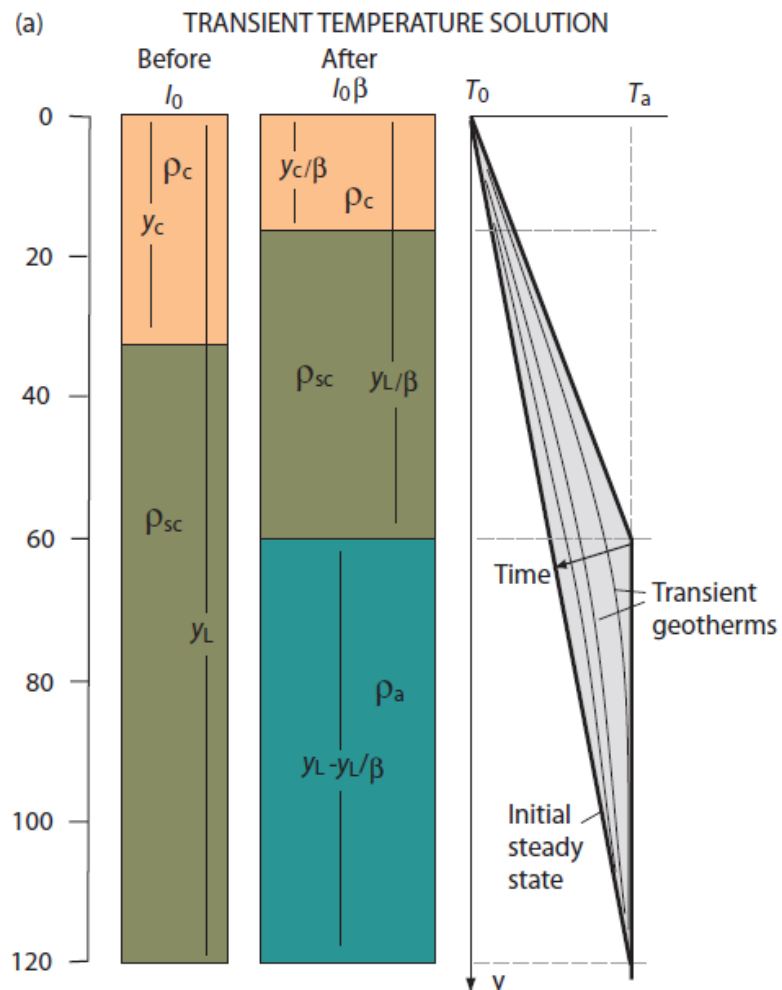

Uniform Lithosphere Extension

- The heat flow decreases exponentially with time after the cessation of rifting

Crustal thinning causes a reduction of the heat flow q_r :

$$q_r = 43.2e^{-0.39\beta}$$

β =stretching factor (ratio between the pre-rift and present-day crustal thickness)

Taking into account also the radiogenic heat contribution in the continental margins q_r is:

$$q_r = 29.6 + 26.8(1 - 1/\beta)$$

(Pasquale et al., 1996)

Surface heat flow scaled by the surface heat flow prior to stretching/
time scaled by the diffusive time constant of the lithosphere

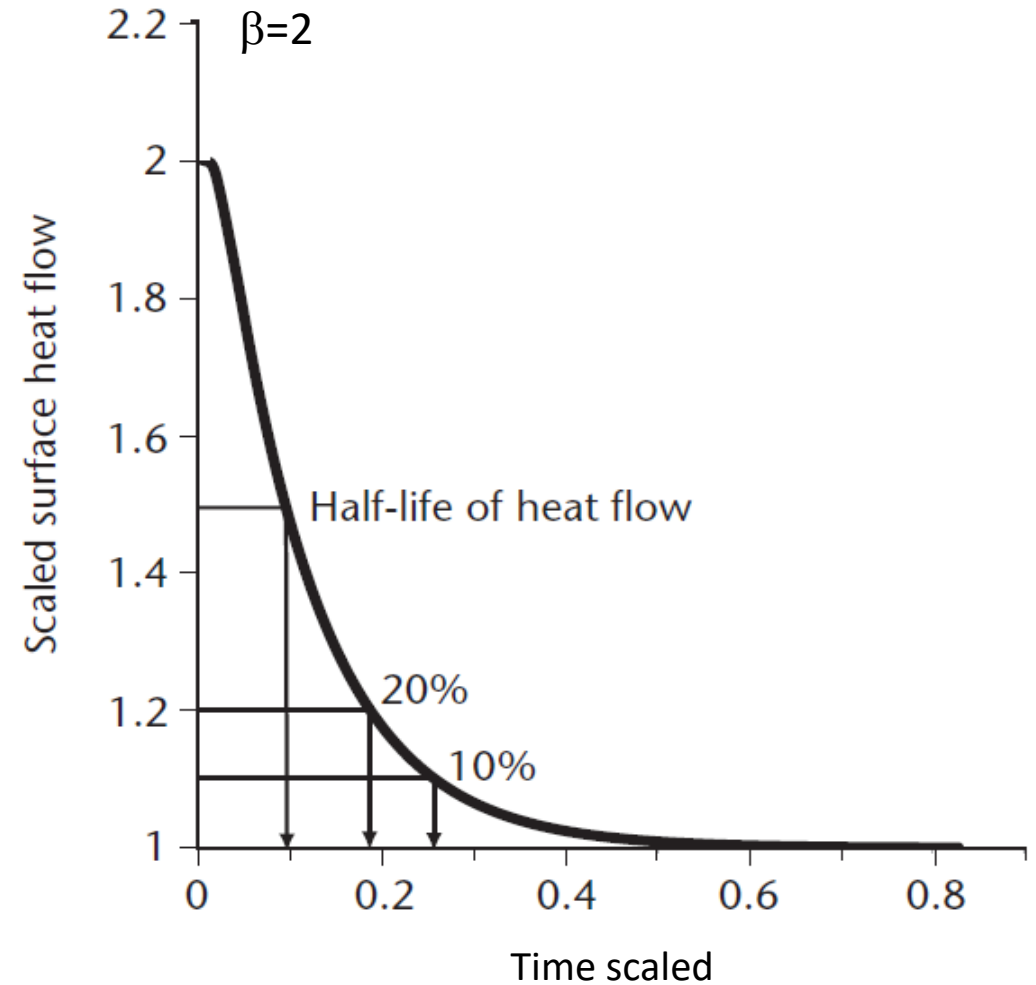

Uniform lithosphere extension

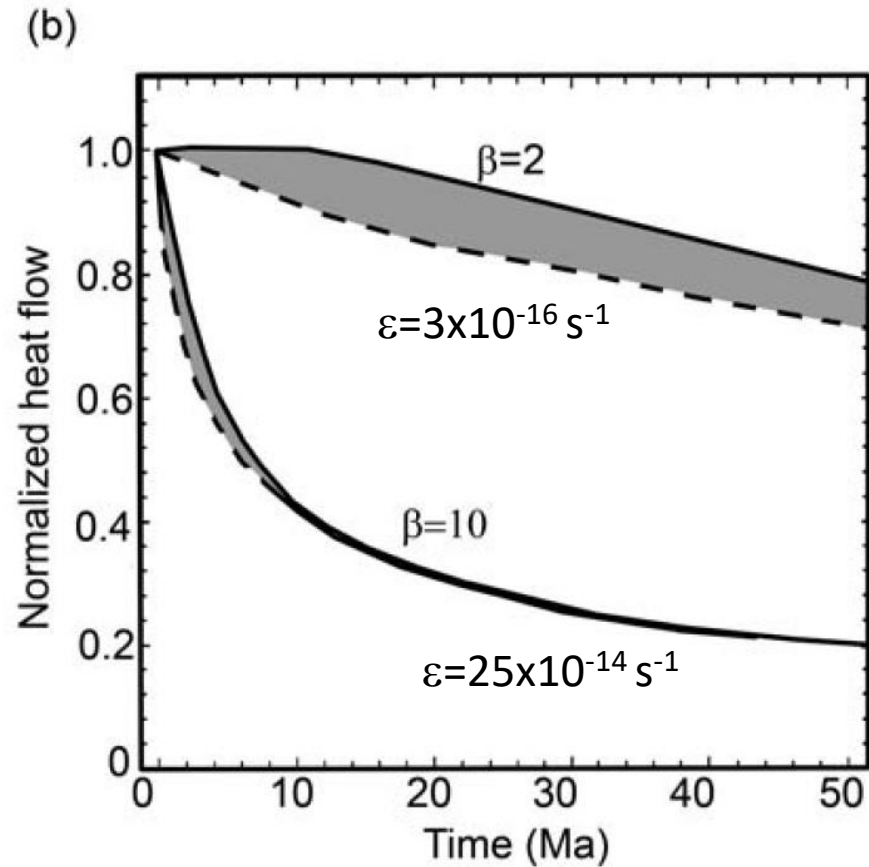
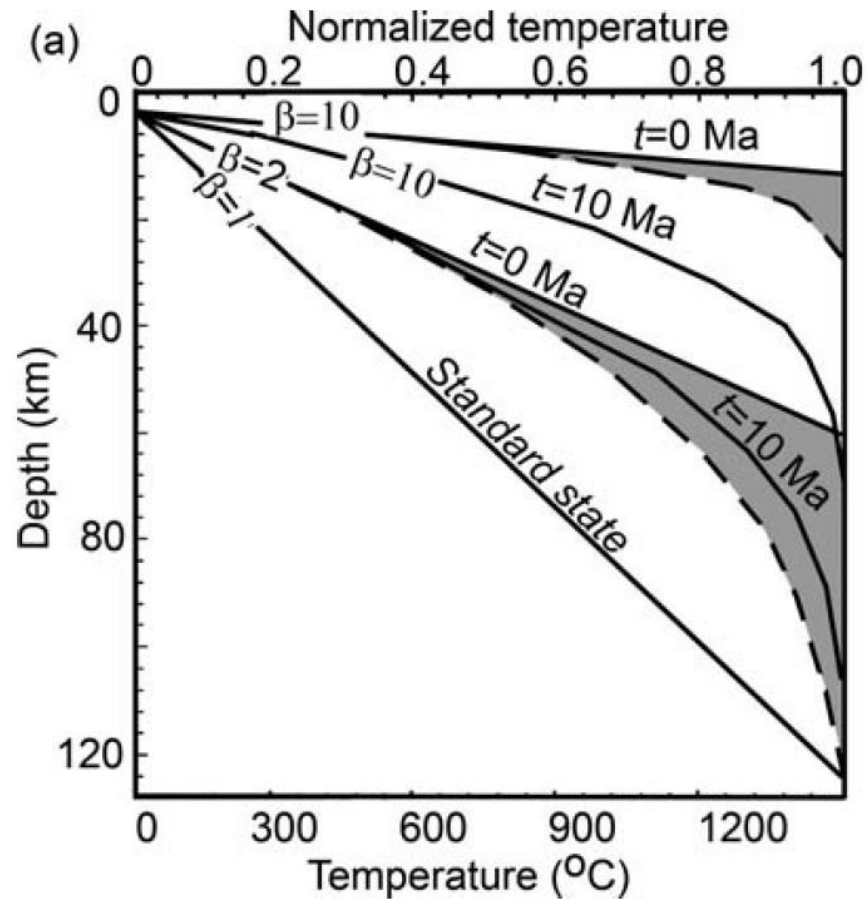

- — — Steady state geotherms for a uniform lithosphere extension (same increase of HF for instantaneous stretching).
- — — Geotherm/Heat Flow for instantaneous stretching

Uniform Stretching Model

Thermal conduction cannot account for rapid thinning of the lithosphere and advective processes (e.g., delamination, underplating, and uprise of the asthenosphere) are needed to account for the topography variations.

- According to McKenzie model, the extension is achieved by stretching the lithosphere at a constant rate, while asthenosphere material flows upward from below to replace the outflowing lithosphere.

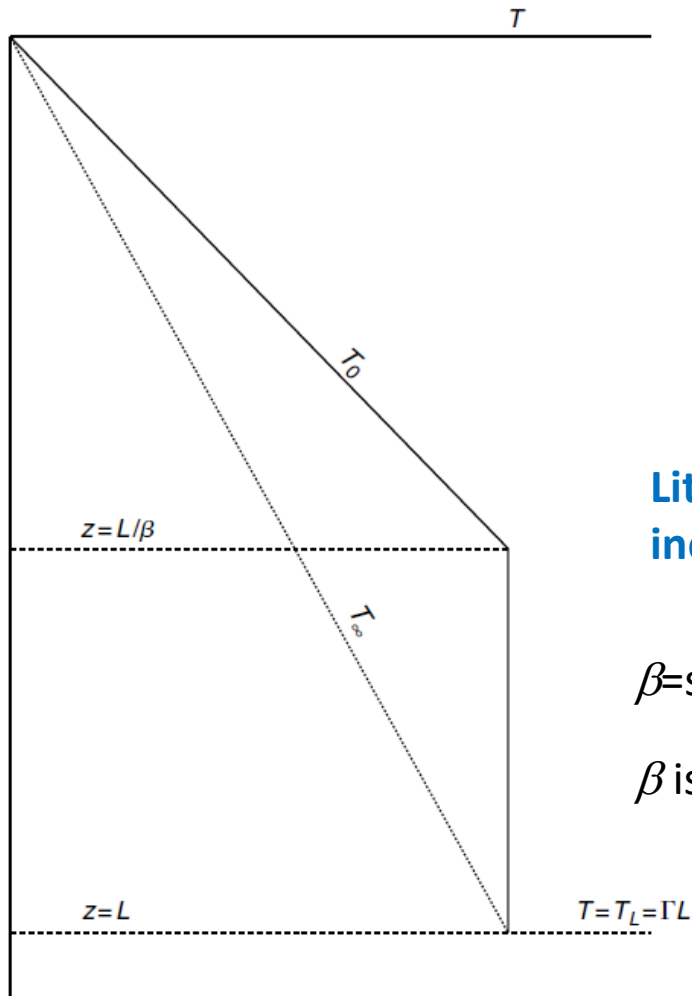

Steady State Conditions: $T = T_0 + (T_1 - T_0) \times (z/L)$ With $T_0=0$

Initial Thermal perturbation (t=0):

$$T(z, t = 0) = T_L \frac{(\beta - 1)z}{L}, \quad z < L/\beta \quad T(z, t = 0) = T_L \left(1 - \frac{z}{L}\right), \quad \frac{L}{\beta} < z < L$$

Lithospheric thickness after stretching is reduced to L/β and temperature gradient is increased by a factor β .

β =stretching factor (original lithospheric thickness/lithospheric thickness after rifting)

β is related to the strain rate (s) and the duration of stretching, Δt : $\beta = \exp(s \Delta t)$

Uniform Lithosphere Extension

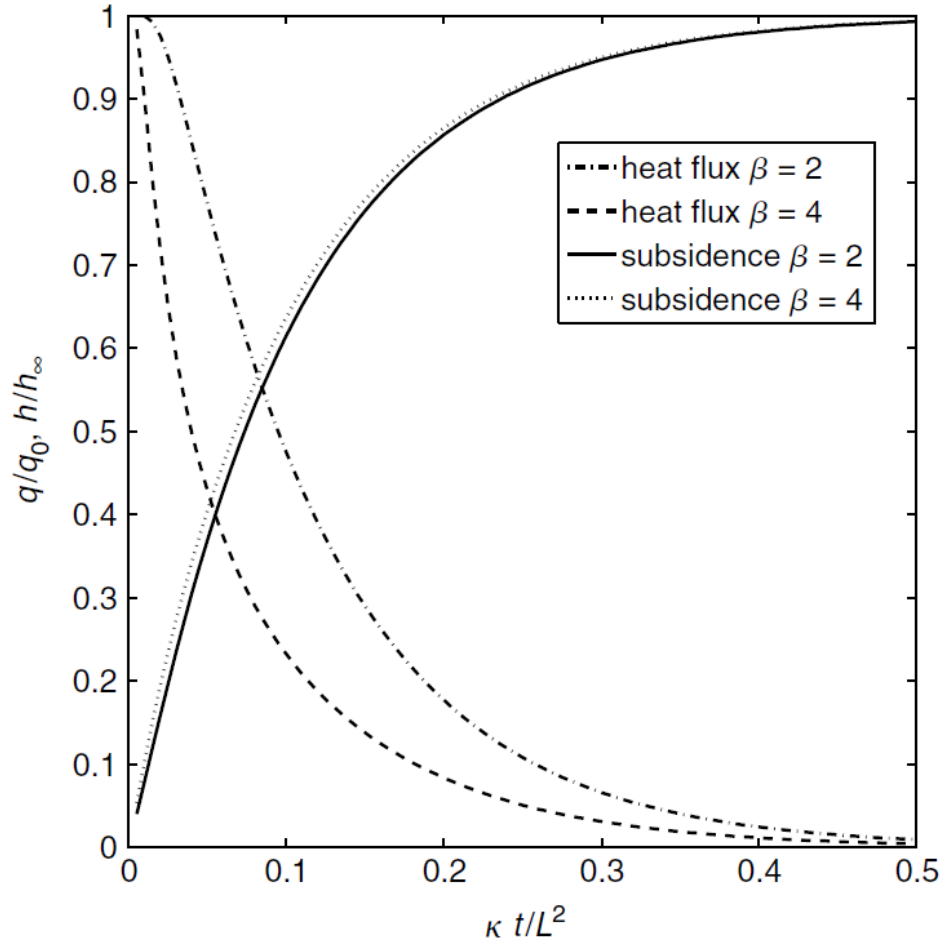

$$q_0 = \lambda(\beta - 1)T_L/L$$

$$h_\infty = \alpha(\beta - 1)T_L L / (2\beta)$$

$$T(z, t) = \frac{2\beta T_L}{\pi^2} \sum_{n=1}^{\infty} \frac{1}{n^2} \sin\left(\frac{n\pi}{\beta}\right) \sin\left(\frac{n\pi z}{L}\right) \exp\left\{\frac{-n^2 \pi^2 \kappa t}{L^2}\right\}$$

$$q(t) = \frac{2k\beta T_L}{\pi L} \sum_{n=1}^{\infty} \frac{1}{n} \sin\left(\frac{n\pi}{\beta}\right) \exp\left\{\frac{-n^2 \pi^2 \kappa t}{L^2}\right\}$$

Using the relationship:

$$\sum_{n=1}^{\infty} \frac{1}{(2n-1)^3} \sin\{(2n-1)z\} = \frac{\pi^2 z - \pi z^2}{8}$$

$$h(t) = \frac{\alpha(\beta-1)T_L L}{2\beta} - \frac{4\alpha T_L \beta L}{\pi^3} \times \sum_{n=1}^{\infty} \frac{1}{(2n-1)^3} \sin\left\{(2n-1)\frac{\pi}{\beta}\right\} \exp\left\{\frac{-(2n-1)^2 \pi^2 \kappa t}{L^2}\right\}$$

Simple Shear Extension

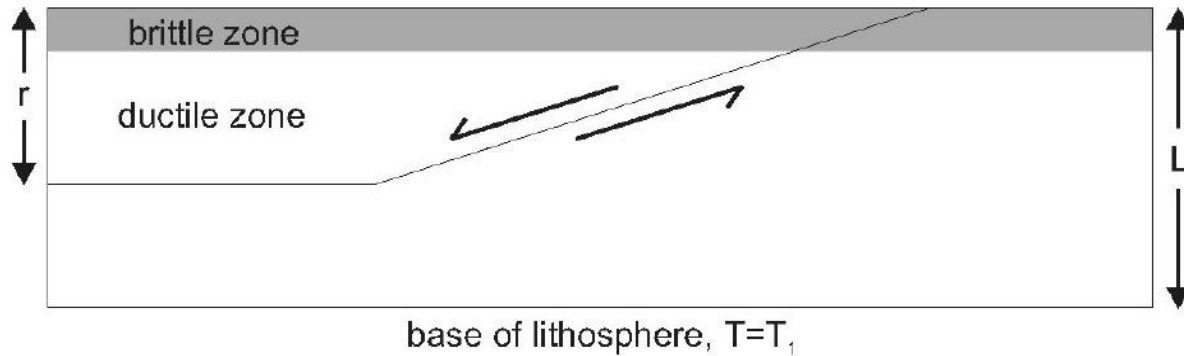

r =depth at which extends the detachment fault.
 d =depth at which the loss in crustal thickness is compensated by lateral flow within the lower crust.

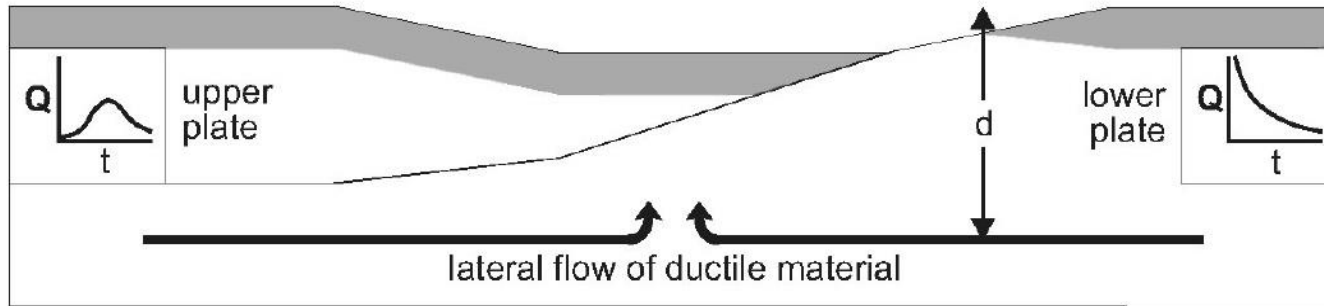

- In case of simple shear, the accommodation space created during the extension is filled by lateral flow of ductile material from either the lower crust or mantle, as opposed to an upwelling of hot asthenosphere.
- On the upper plate, surface temperature remains constant, while the temperature at the detachment surface initially increases, before relaxing back to equilibrium.
- On the lower plate, the hot detachment plane is exposed to the surface, resulting in an initial rapid increase in surface heat flow followed by subsequent decay to equilibrium:

$$Q = \lambda \frac{T_1}{L} + \lambda \frac{T_1}{L} \frac{r}{L} \sum_{n=1}^{\infty} 2 \left\{ 1 - \left(\frac{L}{n\pi r} \right) \left[\sin\left(\frac{n\pi d}{L} \right) - \sin\left(\frac{n\pi(d-r)}{L} \right) \right] \right\} \times \exp\left[\frac{-n^2 \pi^2 \kappa t}{L^2} \right]$$

Lachenbruch et al. (1994)

Geothermal flow for marginal basins

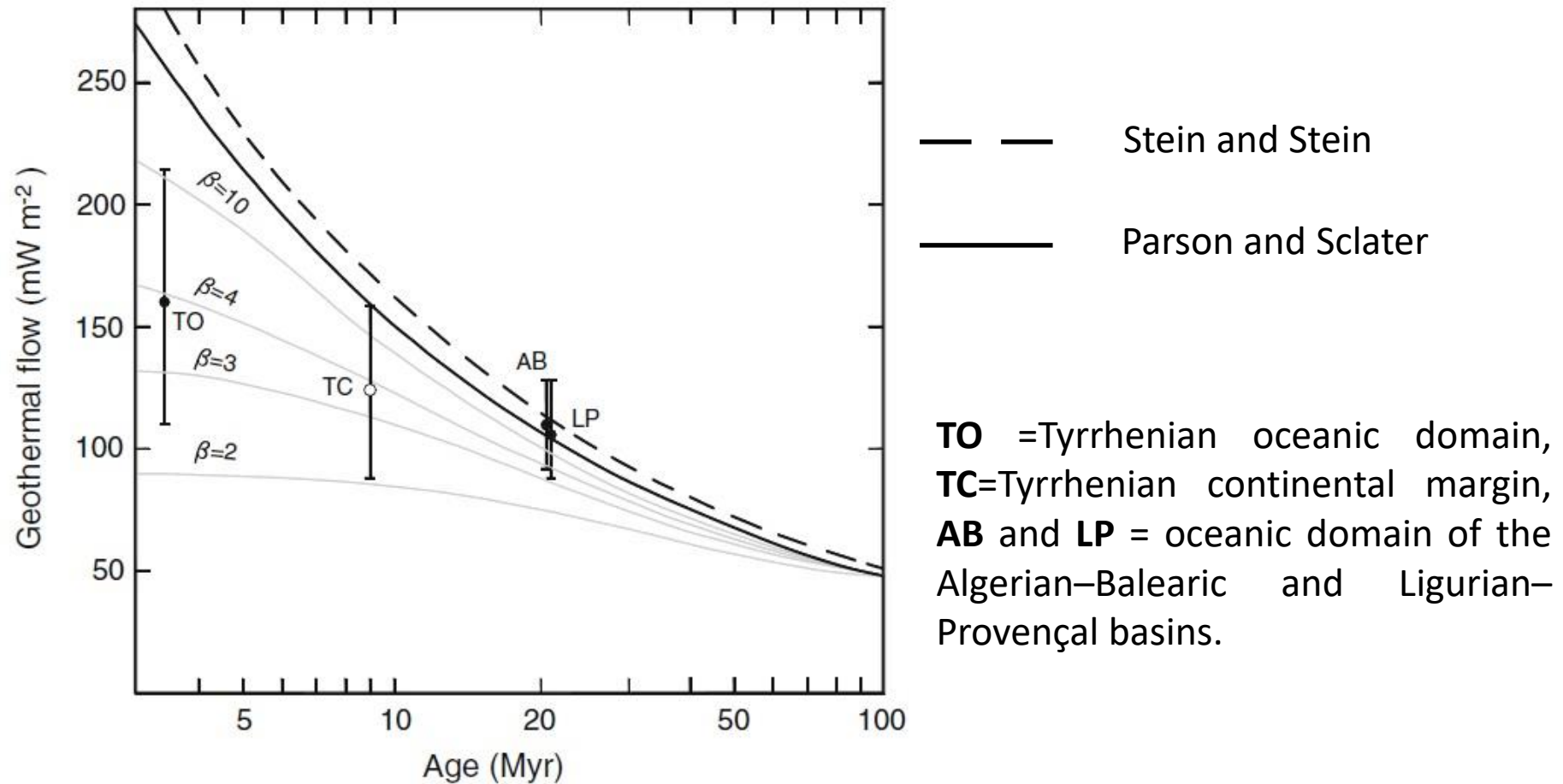

- The oceanic domains of the young marginal basins are then thermally perturbed, due to strong hydrothermal circulation.
- For oceanic crust older than 5 Myr, Q is closer to the ocean-floor cooling models, due to an increase in sediment thickness, which allows water circulation but prevents heat loss.

References

Main readings

Books:

- Allen and Allen, Basin Analysis, Chapter 2: The physical state of the lithosphere, 20-47.
- Allen and Allen, Basin Analysis, Chapter 10: Thermal History, 343-369.
- Artemieva, 2011, Chapter 4, Thermal regime of the lithosphere from heat flow data, The lithosphere an interdisciplinary approach, Cambridge and University Press.
- Beardsmore and Cull, 2001, Crustal Heat Flow A Guide to Measurement and Modelling, Chapter 3: Heat Flow, 146-200.
- Davies, 1999, Chapter 7, Heat, Dynamic Earth Plates, Plumes and Mantle Convection, Cambridge and University Press.
- Eppelbaum, Kutasov, and Pilchin, 2014: Applied Geothermics, Chapter 7: Interpretation of Thermal Measurements.
- Jaupart and Mareshal, 2011, Heat Generation and Transport in the Earth , Chapter 7, Thermal structure of the continental Lithosphere.
- Pasquale, Geothermics, Heat flow in the Lithosphere, Chapter 3: Thermal State, 53-77.

Further readings:

- Ayala, et al., 2003. The lithosphere-asthenosphere boundary in the western Mediterranean from 3D joint gravity and geoid modeling: tectonic implications. Earth Planet. Sci. Lett., 209, 275-290.
- Bourgeois, et al., 2007. Separation of rifting and lithospheric folding signatures in the NW-Alpine foreland. Int. J. Earth Sci. (Geol Rundsch).
- BRGM, 2006. Internal Report, Orleans.
- Diehl, et al, 2005. The crustal structure beneath SE Romania from teleseismic receiver functions. Geophys. J. Int., 163, 238–251.
- Exxon, 1985. Tectonic map of the World, Scale 1:10,000,000. Exxon Prod. Research Co., AAPGF, Tulsa, OK, USA.
- Kaban et al., 2010, An integrated gravity model for Europe's crust and upper mantle, Earth and Planetary Science Letters, 296, 195-209.
- Lassen, A., 2005. Structure and evolution of the pre-Permian basement in the Danish Area. Ph.D. Thesis, Copenhagen University, pp. 130.
- Lenkey, L., 1999. Geothermics of the Pannonian basin and its bearing on the tectonics of Basin evolution. Ph.D. Thesis, Vrije Universiteit, Amsterdam, pp. 215.
- Noack et al. , 2010, Chemie der Erde, 70, (S3), 47-62.
- Pieri M. and Groppi, G., 1981. Subsurface geological structure of the Po plain, Italy. Consiglio Nazionale delle Ricerche – Progetto finalizzato geodinamica, sottoprogetto "modello strutturale", pubblicazione 414, 13pp.
- Scheck-Wenderoth M. and Lamarche, J., 2005. Crustal memory and basin evolution in the Central European Basin System—new insights from a 3D structural model. Tectonophysics, 397, 143–165.
- Tesauro, et al., 2008, EuCRUST-07: a new reference model for the European crust., Geophys. Res. Lett. 35.
- Thiebot, E. and Gutscher, M.-A., 2006. The Gibraltar Arc seismogenic zone (part 1): Constraints on a shallow east dipping fault plane source for the 1755 Lisbon earthquake provided by seismic data, gravity and thermal modelling. Tectonophysics, 426, 135–152.