

Dal duttile al fragile al duttile: faglie e zone di taglio

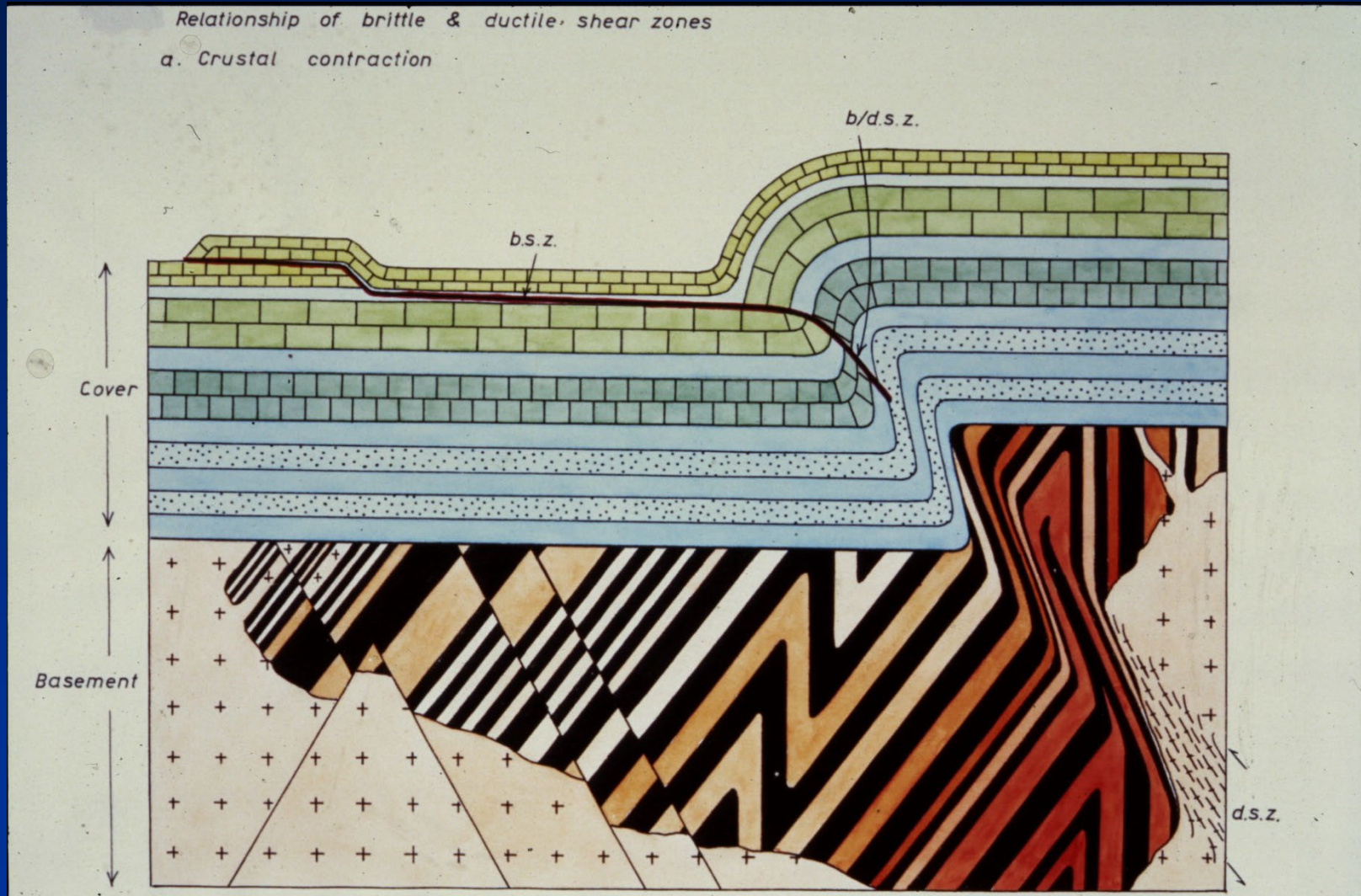

Da Ramsay & Huber, 1987

Immagini e fotografie tratte da:

- Dellisanti et al., 2008. Int J Earth Sci (Geol Rundsch), 97.
- Fossen H., 2010. Structural Geology. Cambridge University Press.
- Hatcher R.D., 1995. Structural Geology: Principles Concepts and Problems. Prentice Hall International.
- Mercier J., Vergely P., 1996. Tettonica. Pitagora Editore.
- Mercier J., Vergely P., 1995. Tectonique, 2ème edition, Dunod.
- Moore et al., 1986
- Passchier C.W., Trouw R.A.J., 2006. Microtectonics. Springer.
- Pini, materiale inedito.
- Pini, 1992. Bollettino della Società Geologica Italiana, 110.
- Price N.J., Cosgrove J.W., 1990. Analysis of Geological Structures. Cambridge University Press.
- Ramsay J. G., Huber M. I., 1983. The Techniques of Modern Structural Geology. Volume 1: Strain analysis. Academic Press Inc. .
- Ramsay J. G., Huber M. I., 1987. The Techniques of Modern Structural Geology. Volume 2: Folds and Fractures. Academic Press Inc.
- Selli L., 2006. Appunti dalle lezioni di Geologia Strutturale.
- Sholz C.H., 1990. The Mechanics of Earthquake and Faulting. Cambridge University Press
- Suppe J., 1985. Principles of Structural Geology. Prentice-Hall Inc.
- van der Pluijm B., Marshak S., 2004. Earth Structure: An Introduction to Structural Geology and Tectonics, Second Edition. WW Norton & Company.

Rocce di faglia

- 1) Duttile superficiali
- 2) Fragili
- 3) Duttile

- 1) *Bande di scorrimento granuli in arenarie-siltiti; clivaggio scaglioso*
 - *Transizione: da scorrimento indipendente granuli a grain breakage; aumento pervasività e diminuzione spaziatura clivaggio scaglioso*
- 2) *Rocce di faglia da: taglio (clivaggio scaglioso), dissoluzione da pressione (PSC+meso-faglie+eventuale clivaggio scaglioso); cataclasiti, pseudotachiliti*
 - *Transizione: da cataclasiti a miloniti; pseudotachiliti*
- 3) *Zone di taglio duttile: miloniti (S-C e S-C' miloniti, pseudotachiliti (?), indicatori cinematici)*



Kaitocho – Miura Peninsula (Japan)

G.A. Pini



Kaitocho – Miura Peninsula (Japan)

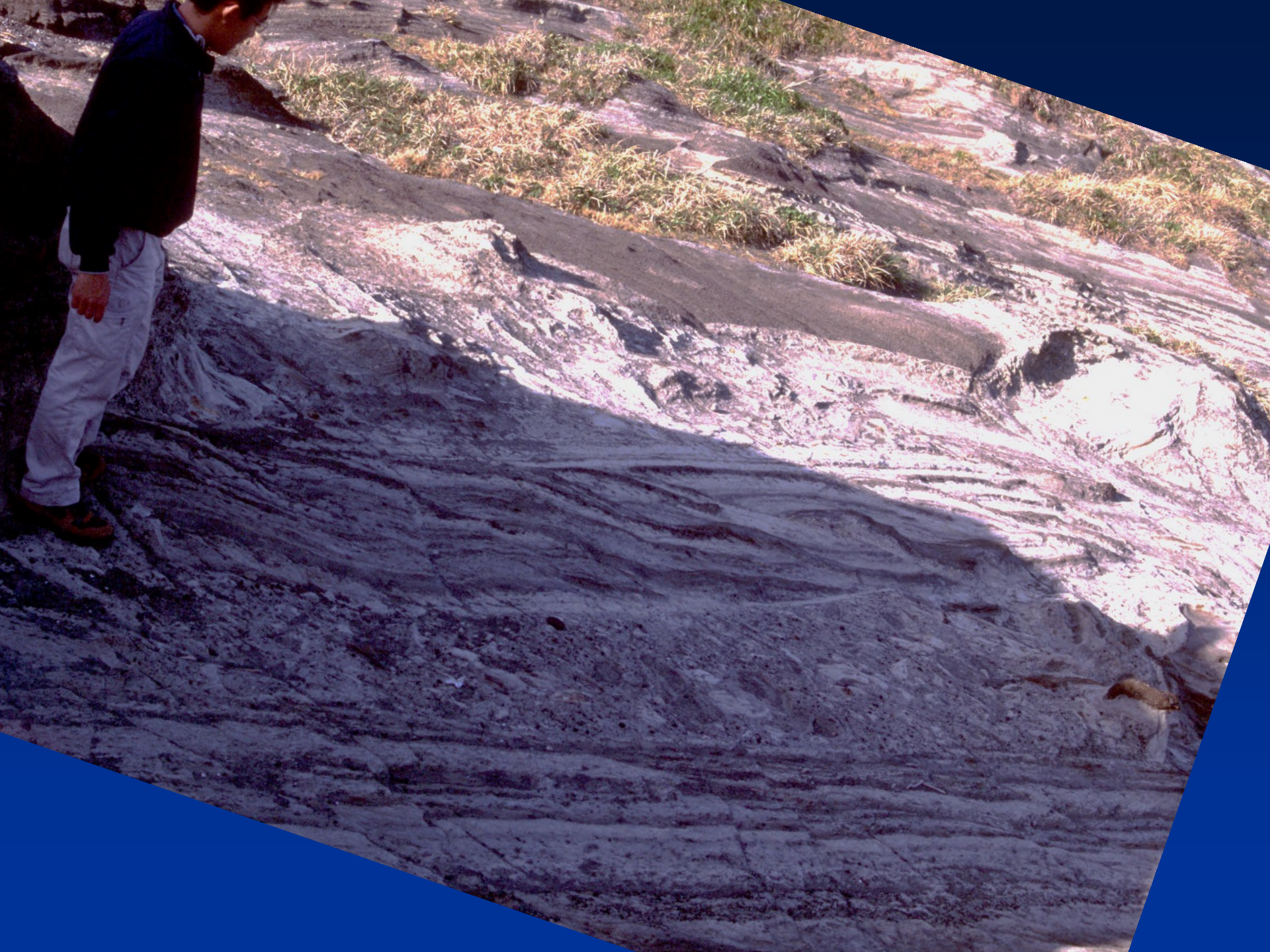

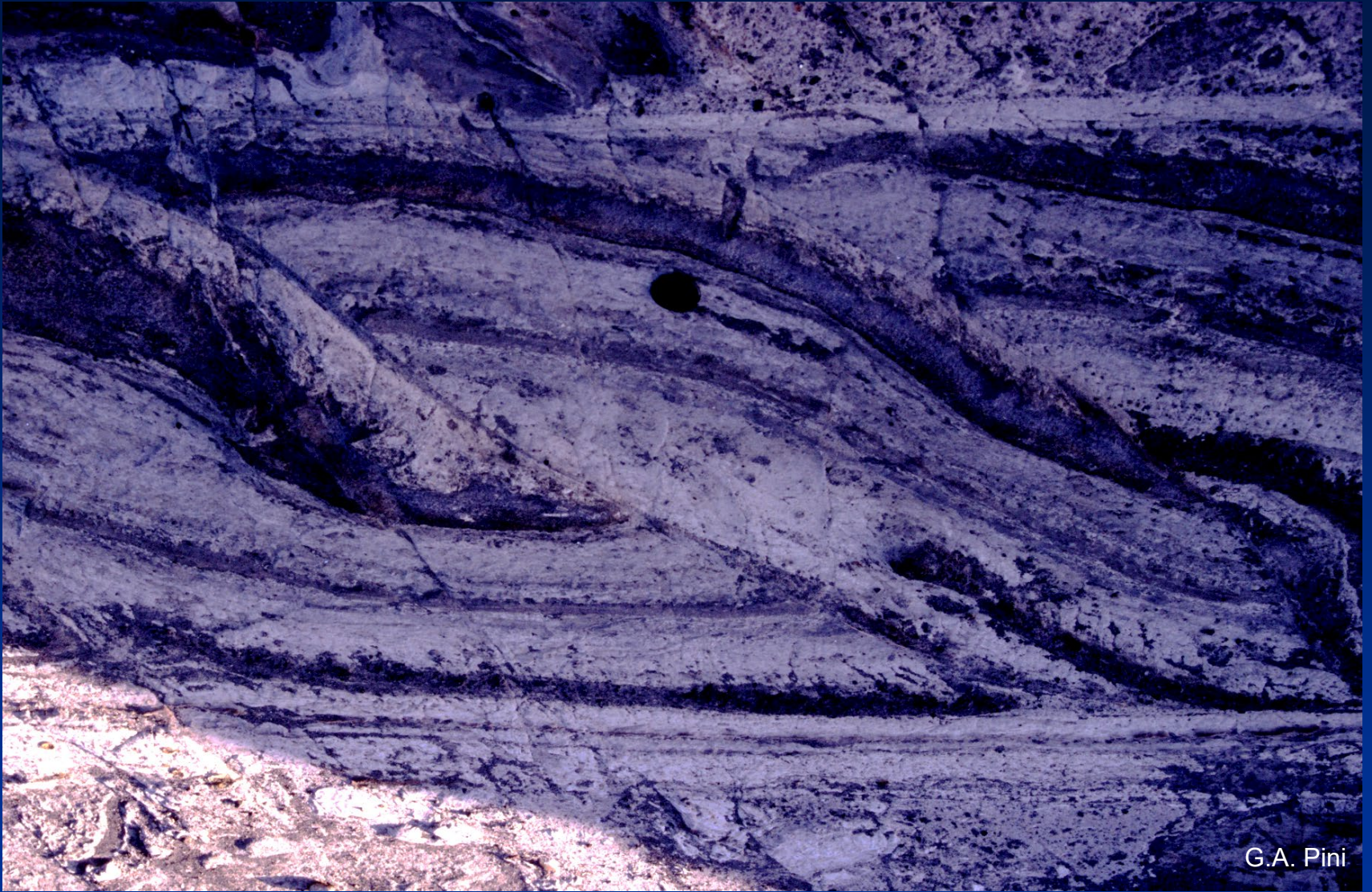

G.A. Pini

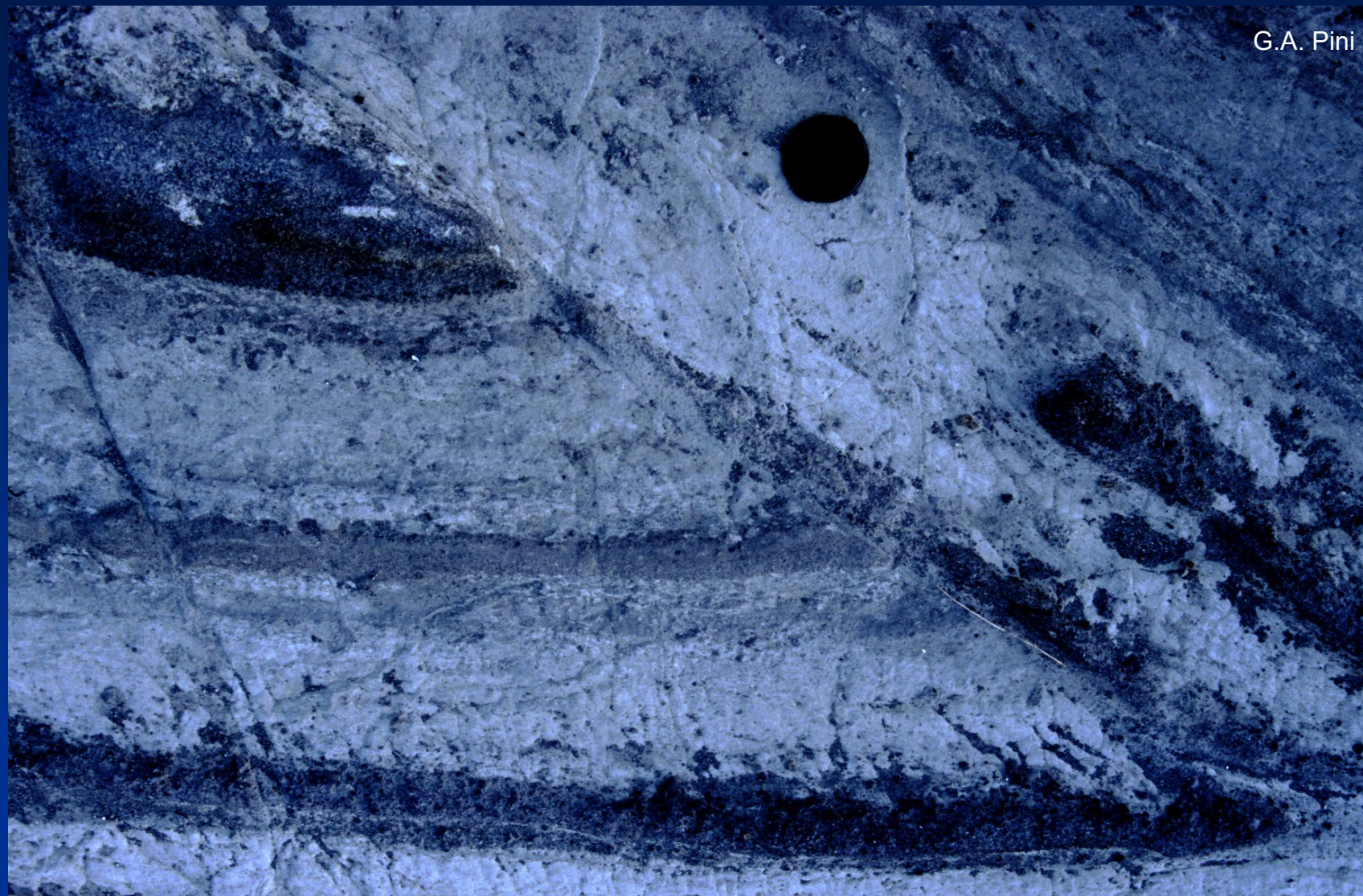

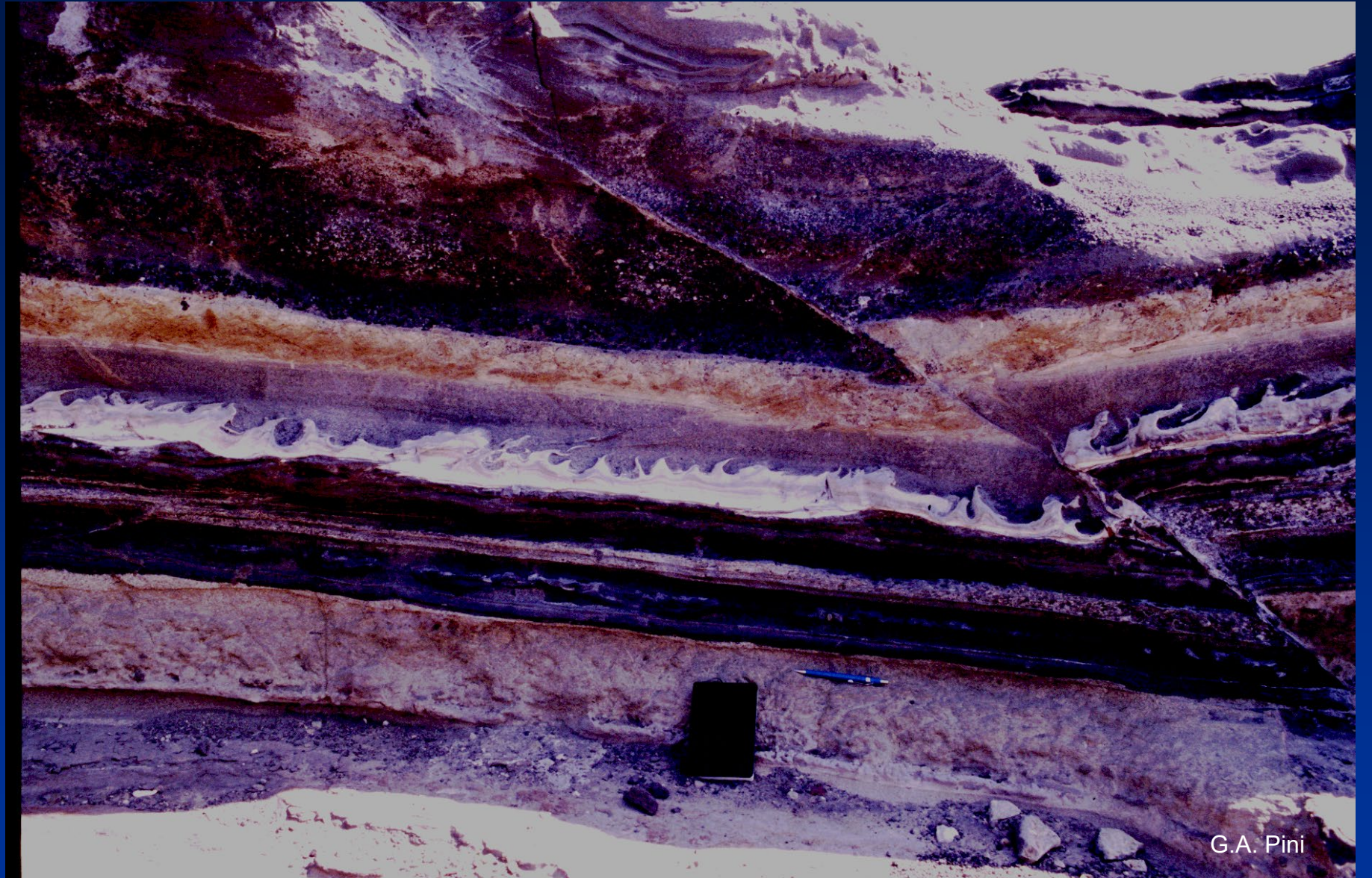

G.A. Pini

Caratteri delle shear zone in sabbie-arenarie al variare dello strain/stress di confinamento

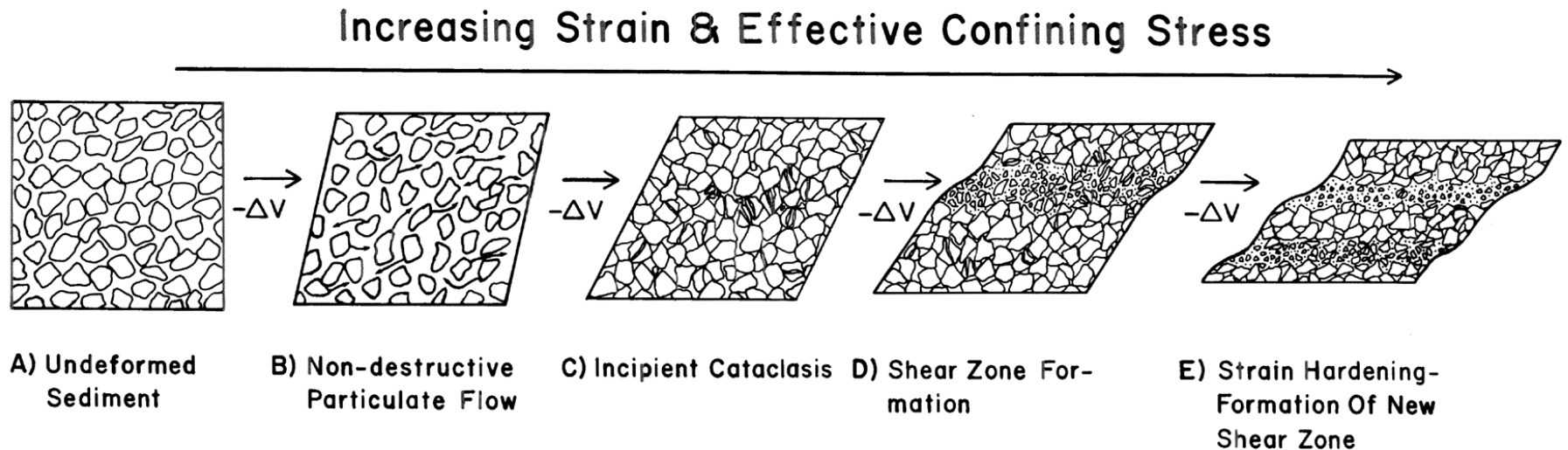

Figure 17. Model for cataclastic deformation and shear zone development in tectonically deformed sandstones. (A) Undeformed water-rich sediments. (B) Internal deformation with particulate flow. (C) Incipient cataclasis. Increasing confining stress inhibits grain boundary sliding and causes localized cataclasis where stress concentrations exceed grain strength (e.g. Sites 488 and 492). (D) Propagation of discrete shear zones. (E) Strain hardening of initial shear zone and development of a new shear zone in weaker adjacent material.

Rocce di faglia

- 1) Duttile superficiali
- 2) **Fragili**
- 3) Duttile

- 1) *Bande di scorrimento granuli in arenarie-siltiti; clivaggio scaglioso*
 - *Transizione: da scorrimento indipendente granuli a grain breakage; aumento pervasività e diminuzione spaziatura clivaggio scaglioso*
- 2) *Rocce di faglia da: taglio (clivaggio scaglioso), dissoluzione da pressione (PSC+meso-faglie+eventuale clivaggio scaglioso); cataclasiti, pseudotachiliti*
 - *Transizione: da cataclasiti a miloniti; pseudotachiliti*
- 3) *Zone di taglio duttile: miloniti (S-C e S-C' miloniti, pseudotachiliti (?), indicatori cinematici)*



G.A. Pini

G.A. Pini



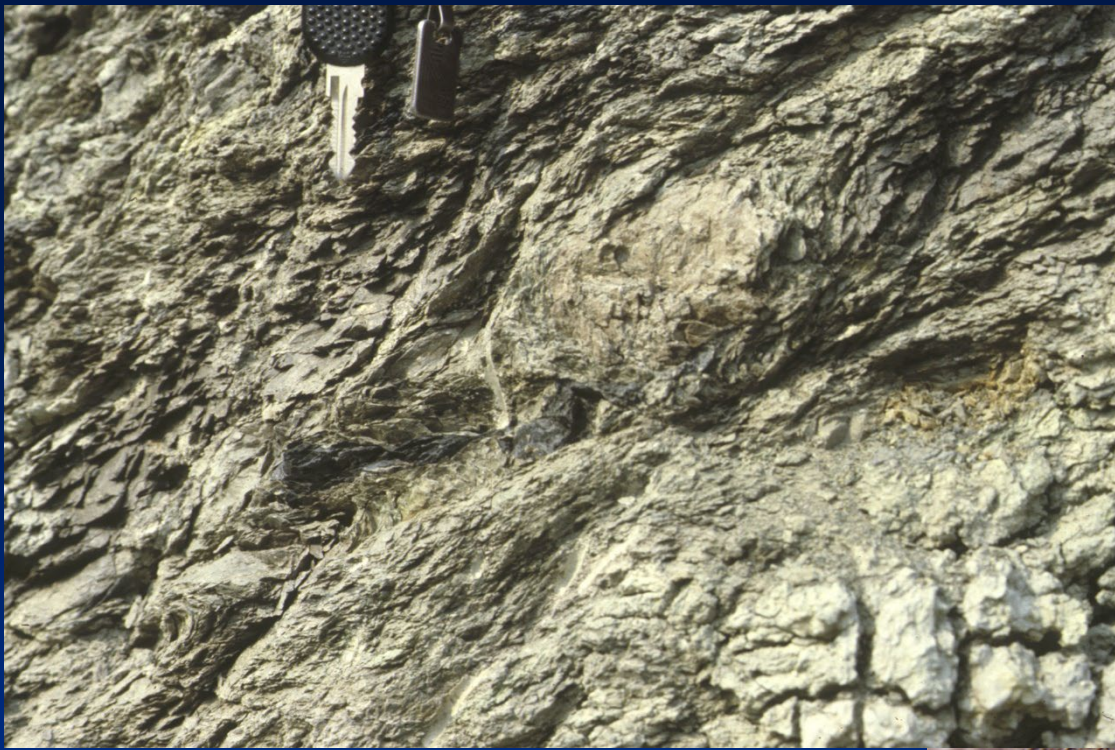

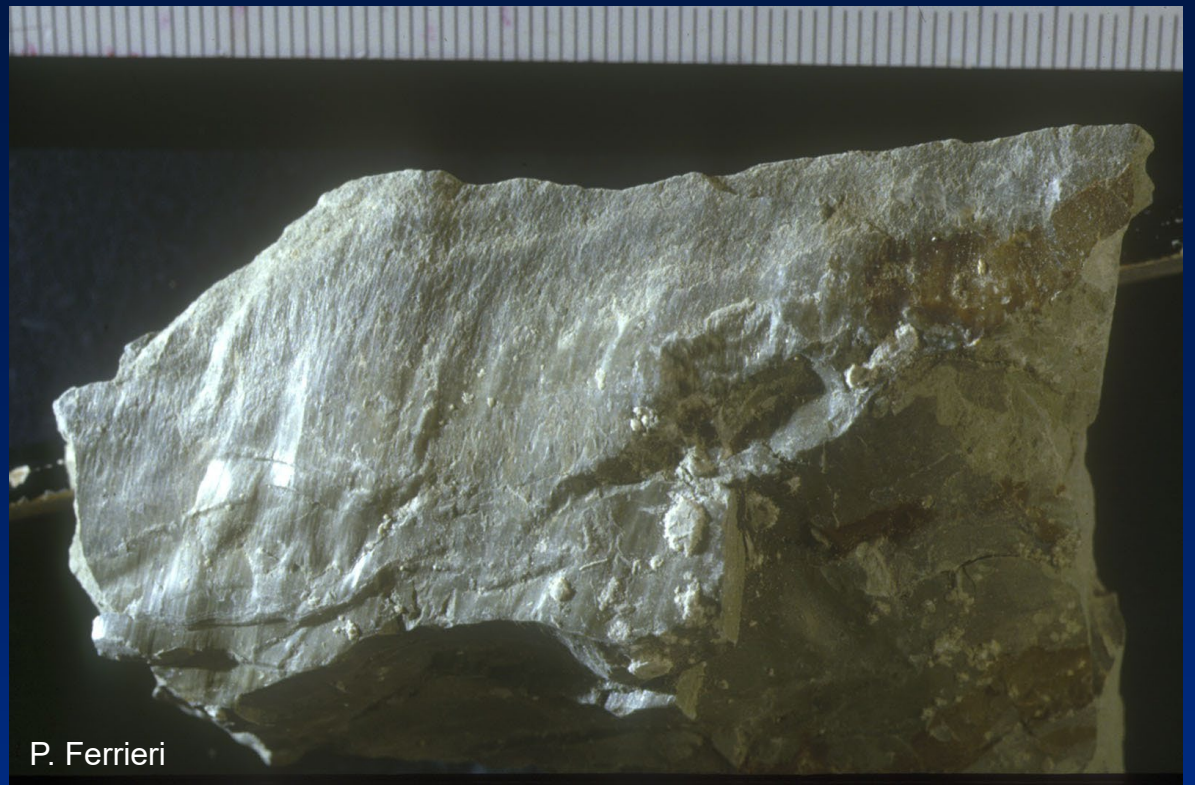

P. Ferrieri



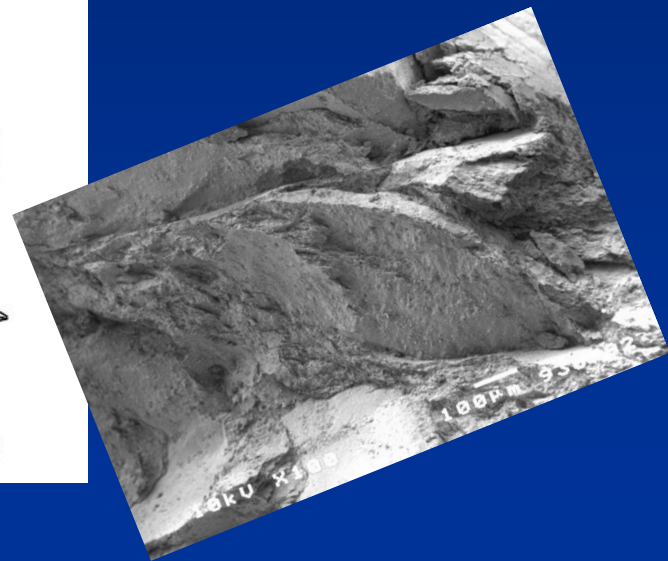
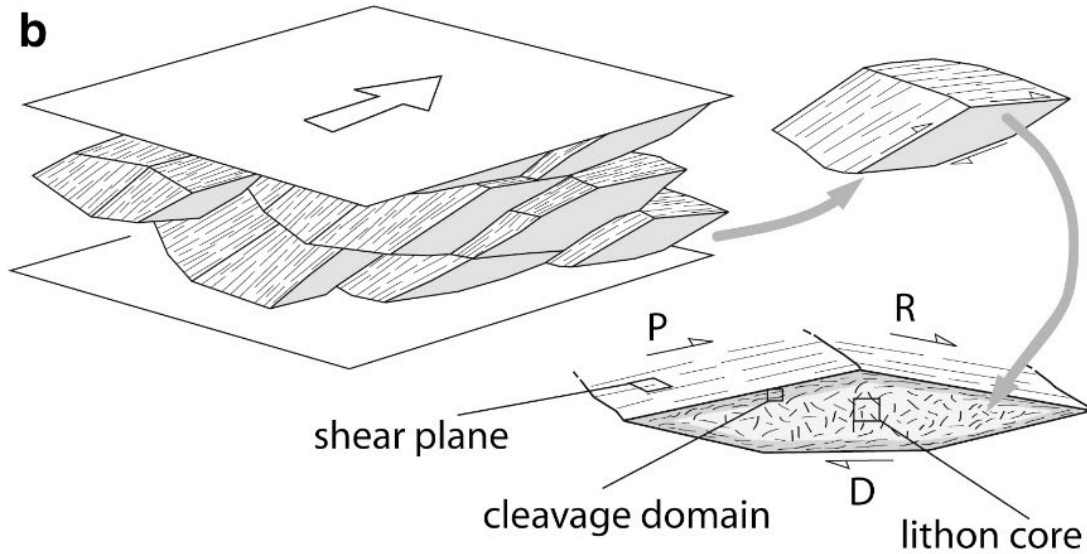
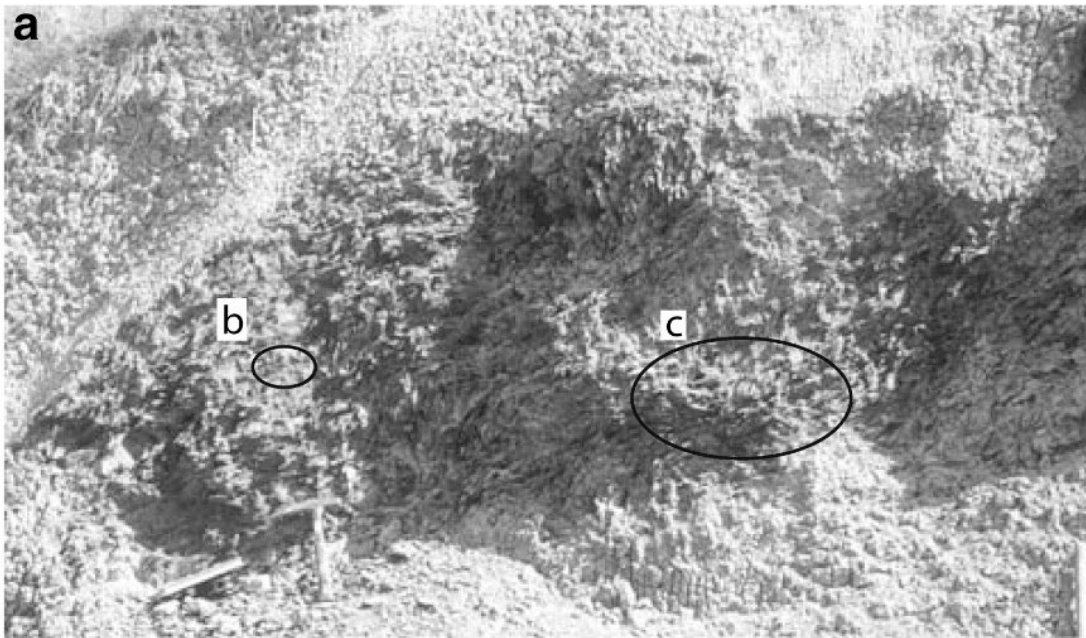

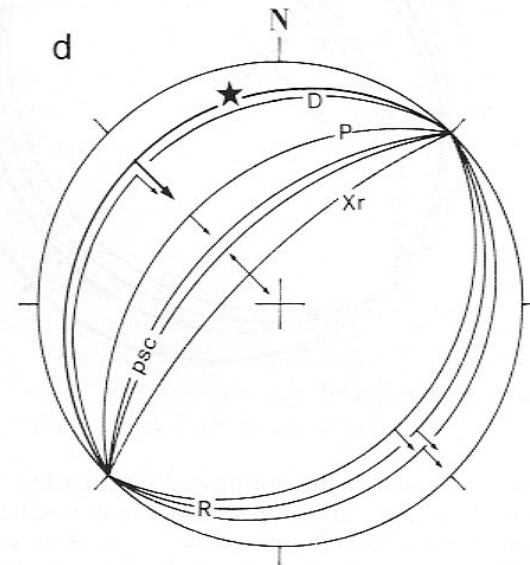
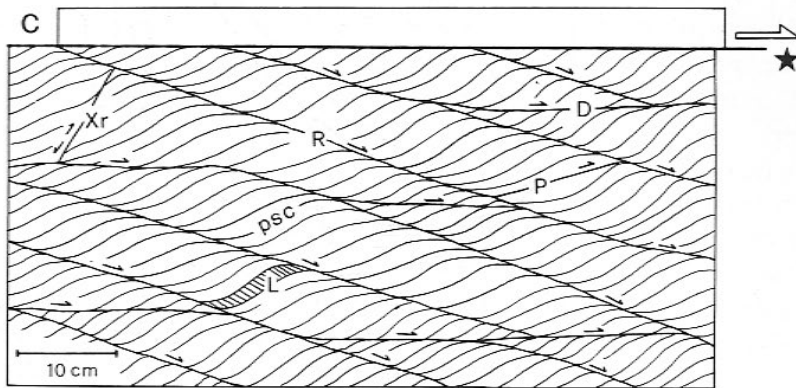
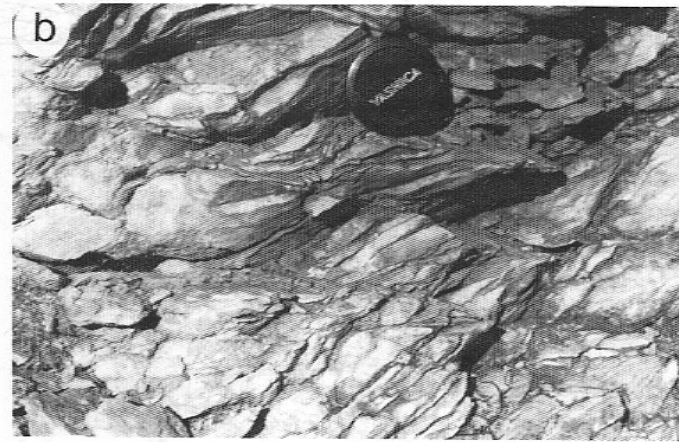
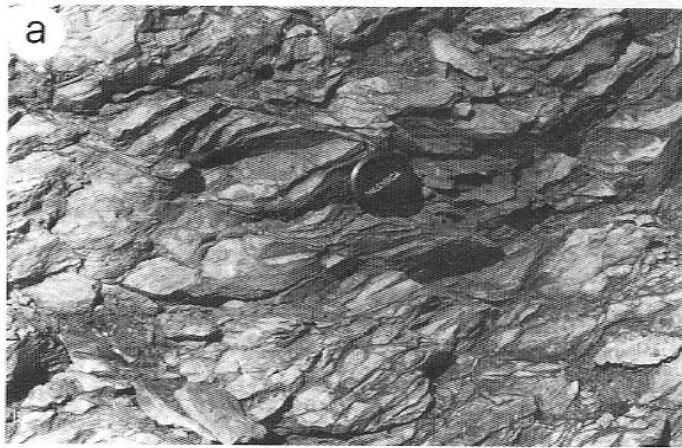
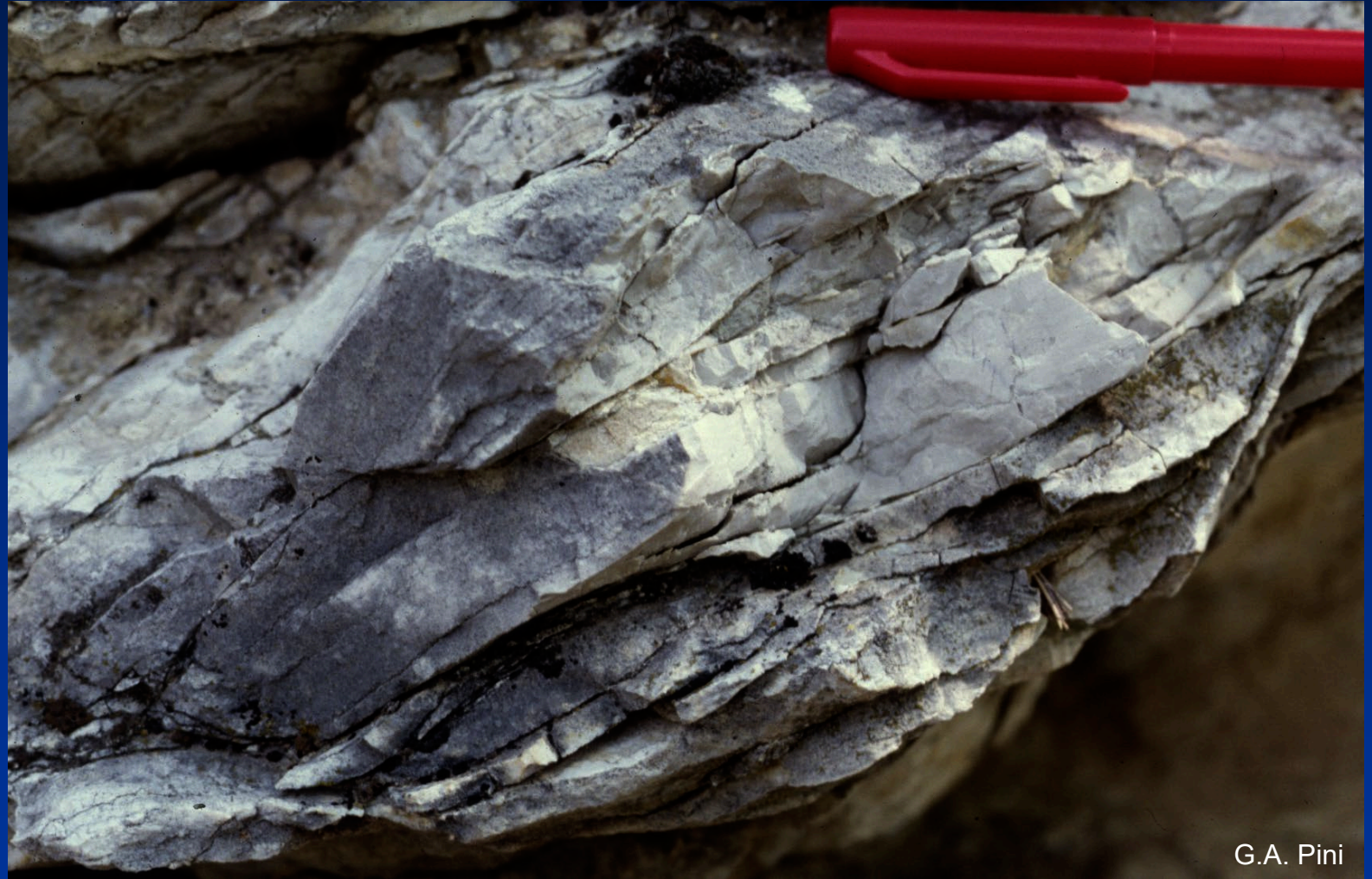
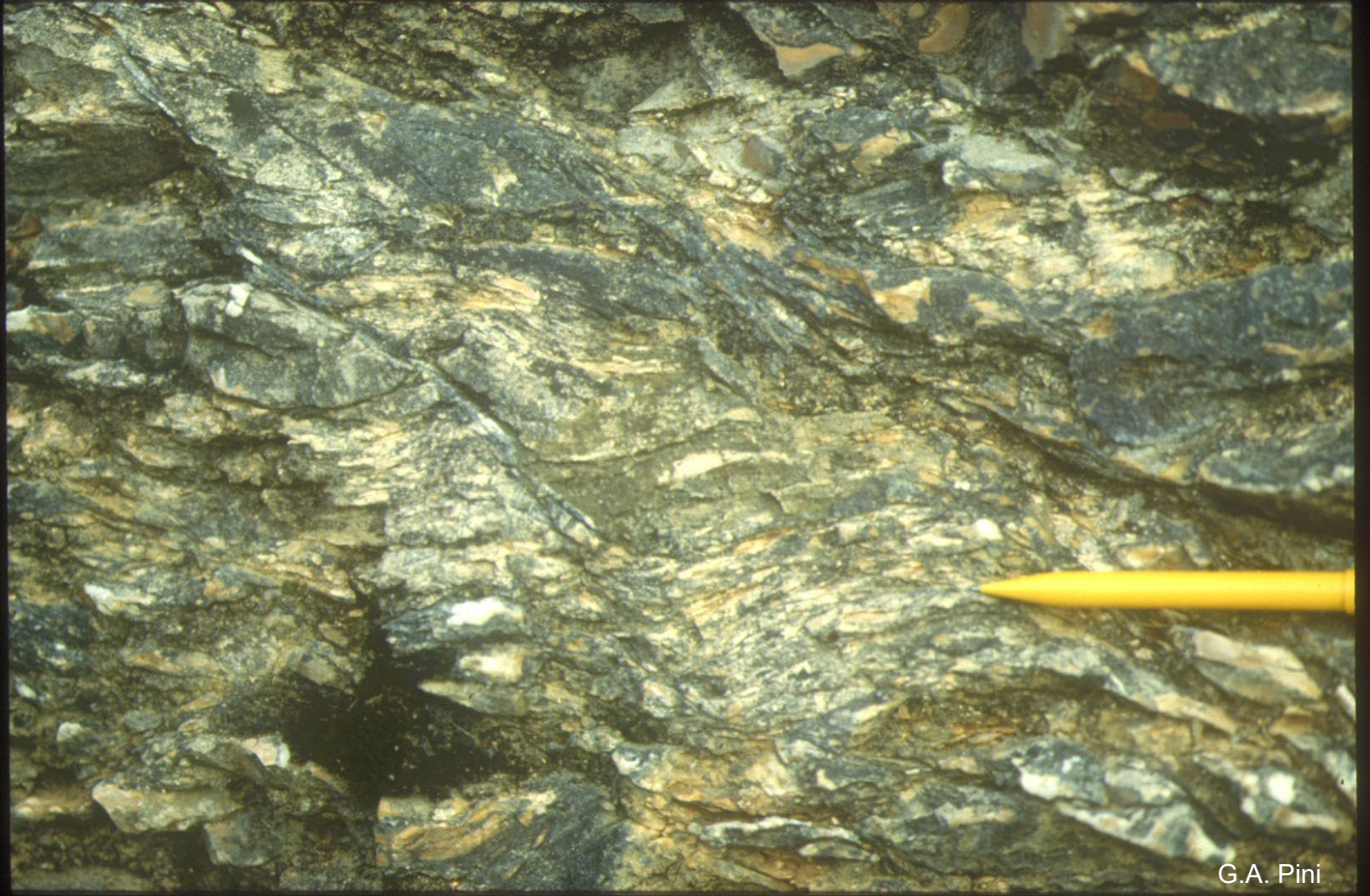

Fig. 5 - Photographs (a, b) and scheme (c) of the pressure solution cleavage and shear plane distribution in pressure solution fault rocks. Wulff net (d) show the idealized orientation of shear planes and psc. L = lithons; psc = pressure solution cleavage planes; R, D, P, Xr = shear planes (see fig. 4); ★ = principal contact surface.



G.A. Pini



G.A. Pini



G.A. Pini

G.A. Pini

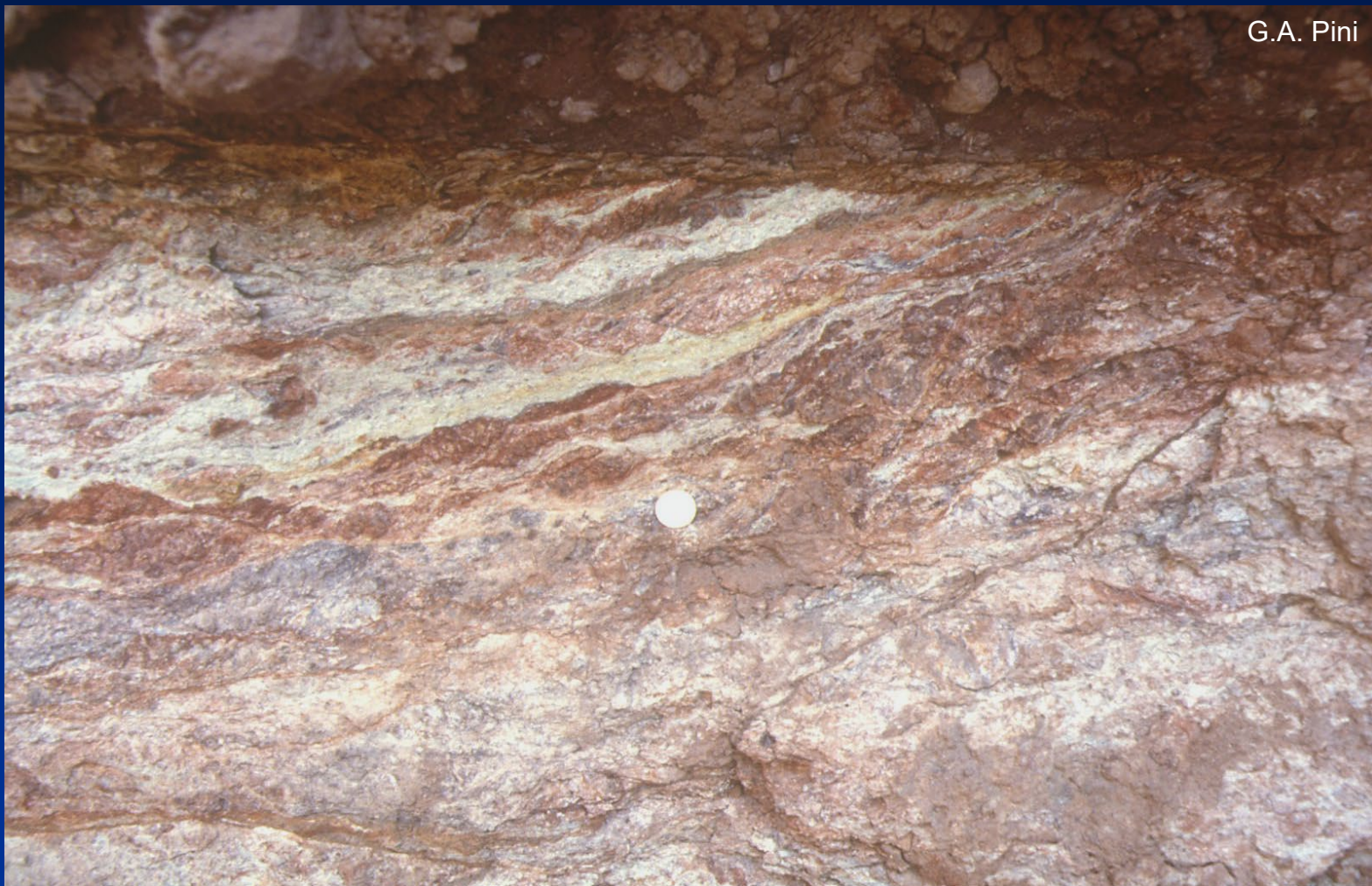



Da Ramsay & Huber, 1987

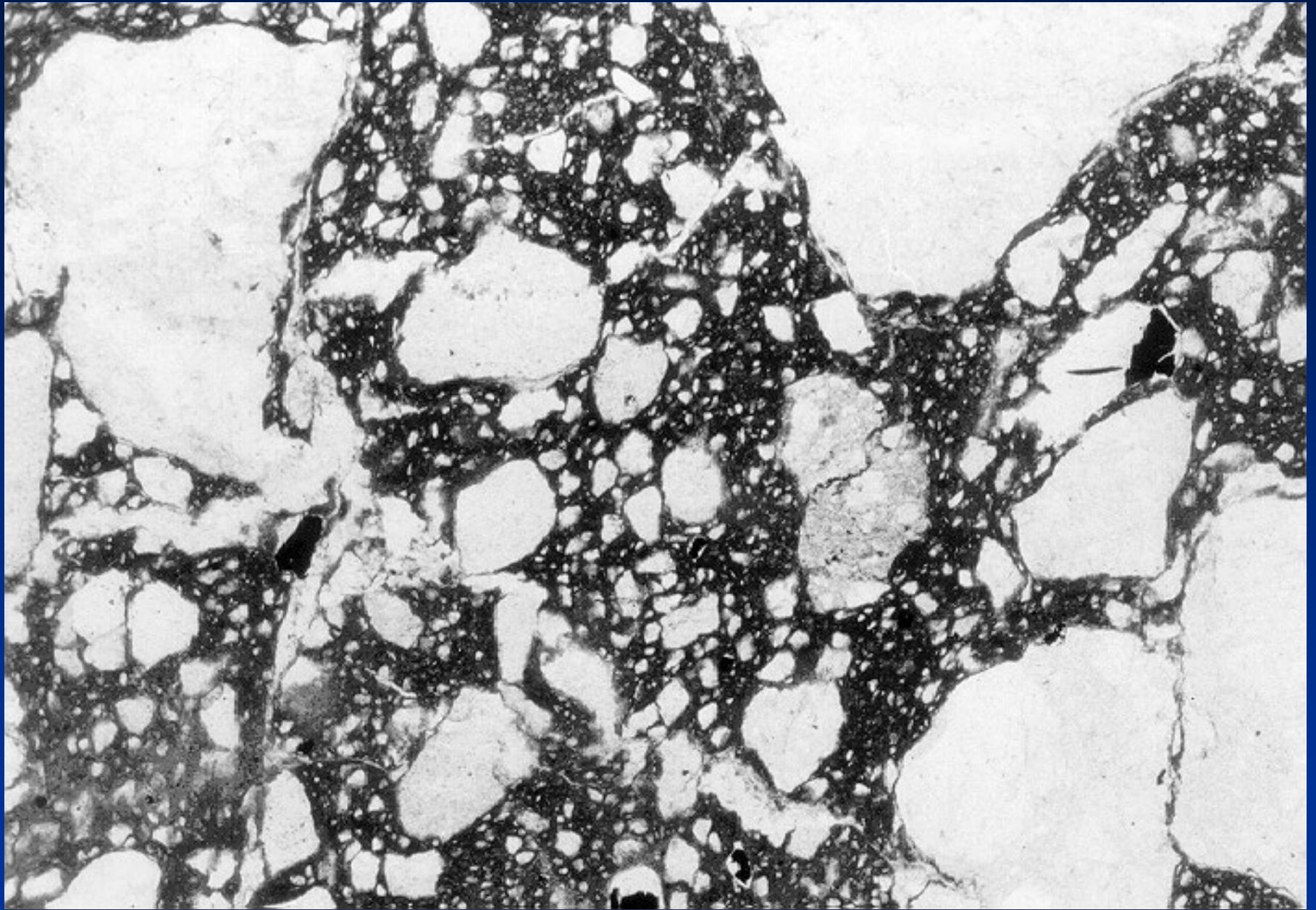

Da Passchier & Trouw, 1996

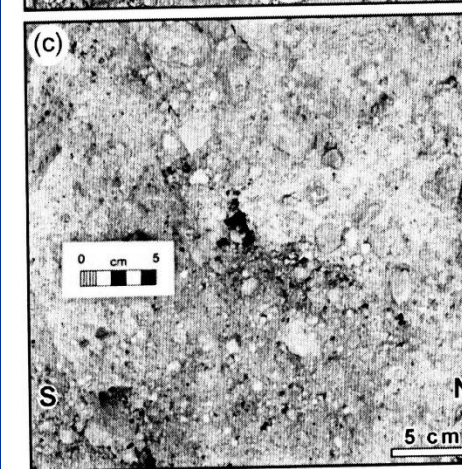
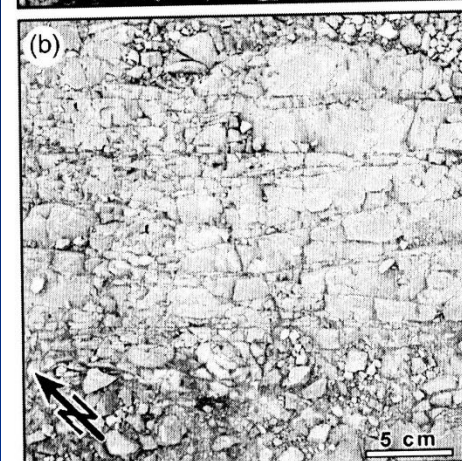
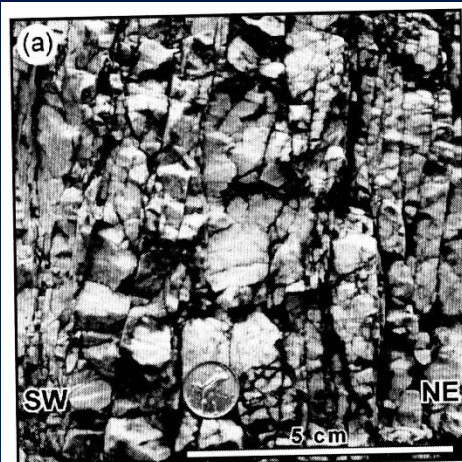
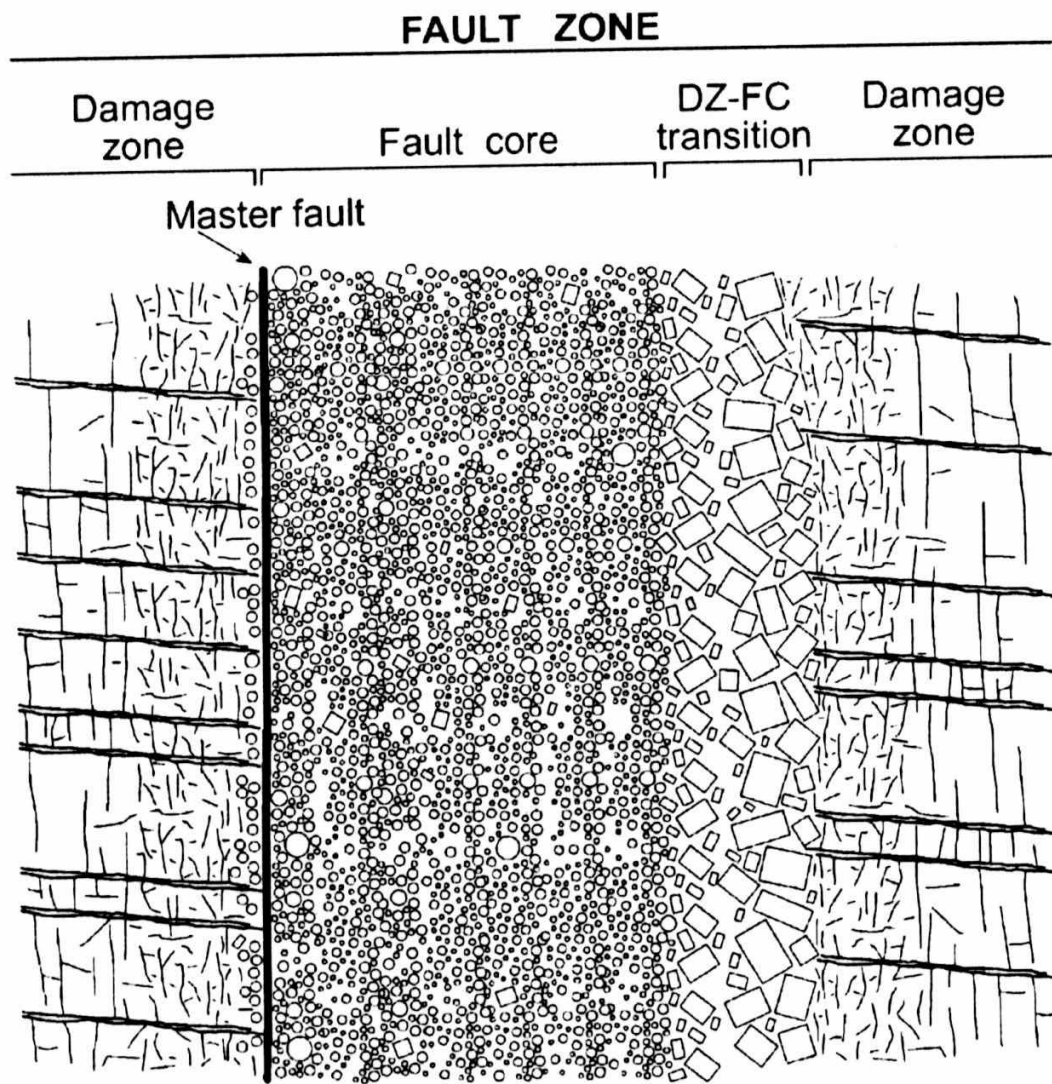

Rocce di faglia

- 1) Duttile superficiali
- 2) Fragili
- 3) Duttile

- 1) *Bande di scorrimento granuli in arenarie-siltiti; clivaggio scaglioso*
 - *Transizione: da scorrimento indipendente granuli a grain breakage; aumento pervasività e diminuzione spaziatura clivaggio scaglioso*
- 2) *Rocce di faglia da: taglio (clivaggio scaglioso), dissoluzione da pressione (PSC+meso-faglie+eventuale clivaggio scaglioso); cataclasiti, pseudotachiliti*
 - *Transizione: da cataclasiti a miloniti; pseudotachiliti*
- 3) *Zone di taglio duttile: miloniti (S-C e S-C' miloniti, pseudotachiliti (?), indicatori cinematici)*



Figura 5.5. I diversi tipi di rocce deformate associate ad una faglia principale (da Sibson, 1977, *J. Geol. Soc. London*, 133, 191, e Scholtz, 1988, *Geol. Rund. Stuttgart*, 77, 319, modificato). Lo sforzo differenziale ($\sigma_1 - \sigma_3$) decresce quando la deformazione duttile aumenta; il tratto puntinato corrisponde alle condizioni dei bacini sedimentari (vedi Fig. 4.16).

a

dominant brittle fracturing

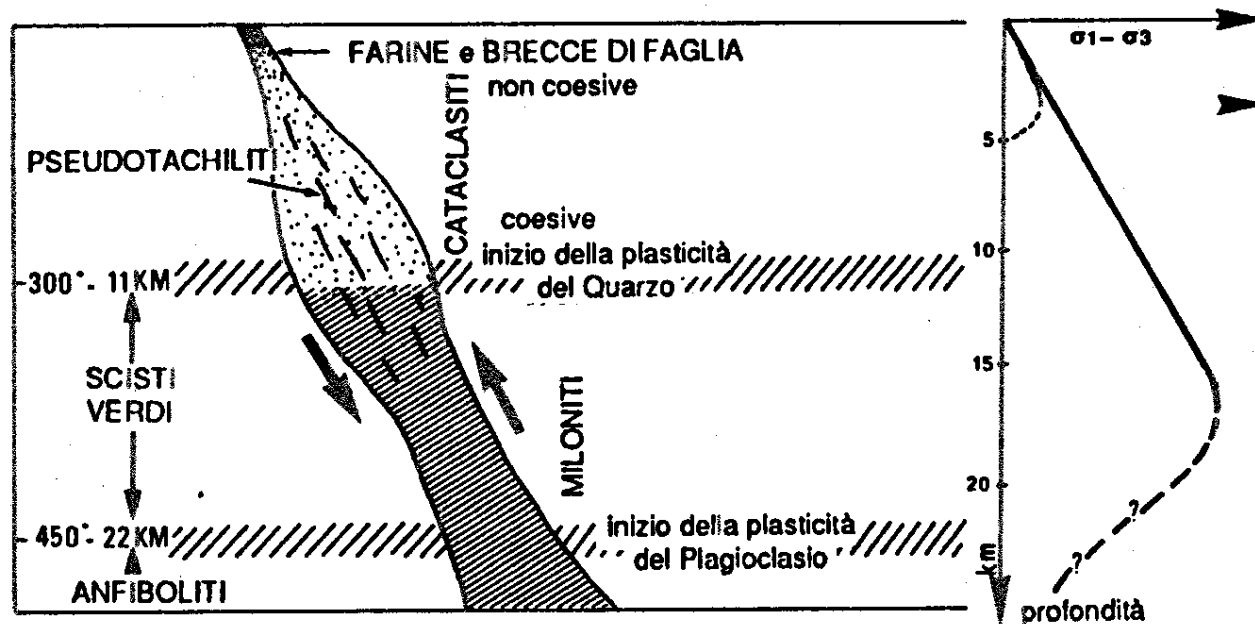

dominant ductile deformation

incohesive brittle fault rocks
cohesive brittle fault rocks

mylonite

striped gneiss

b

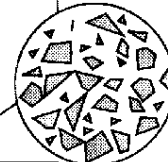
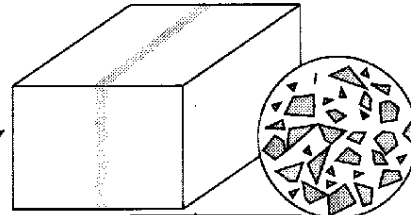
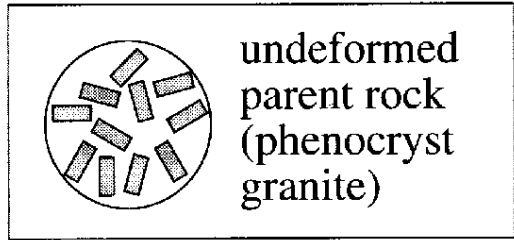

brittle fault with cohesive cataclasite

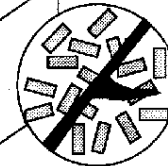
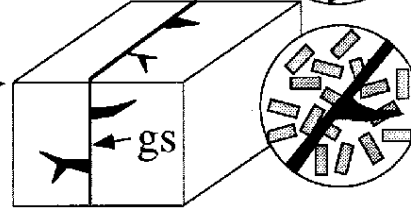

brittle fault with pseudotachylyte

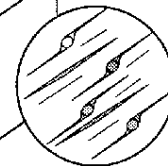
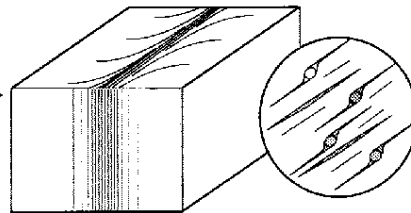

narrow ductile shear zone with mylonite

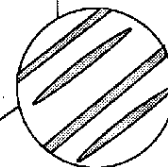
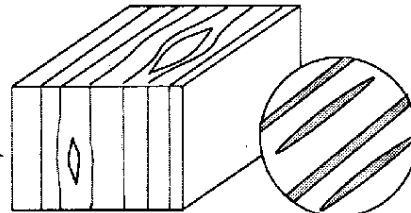

wide ductile shear zone with striped gneiss

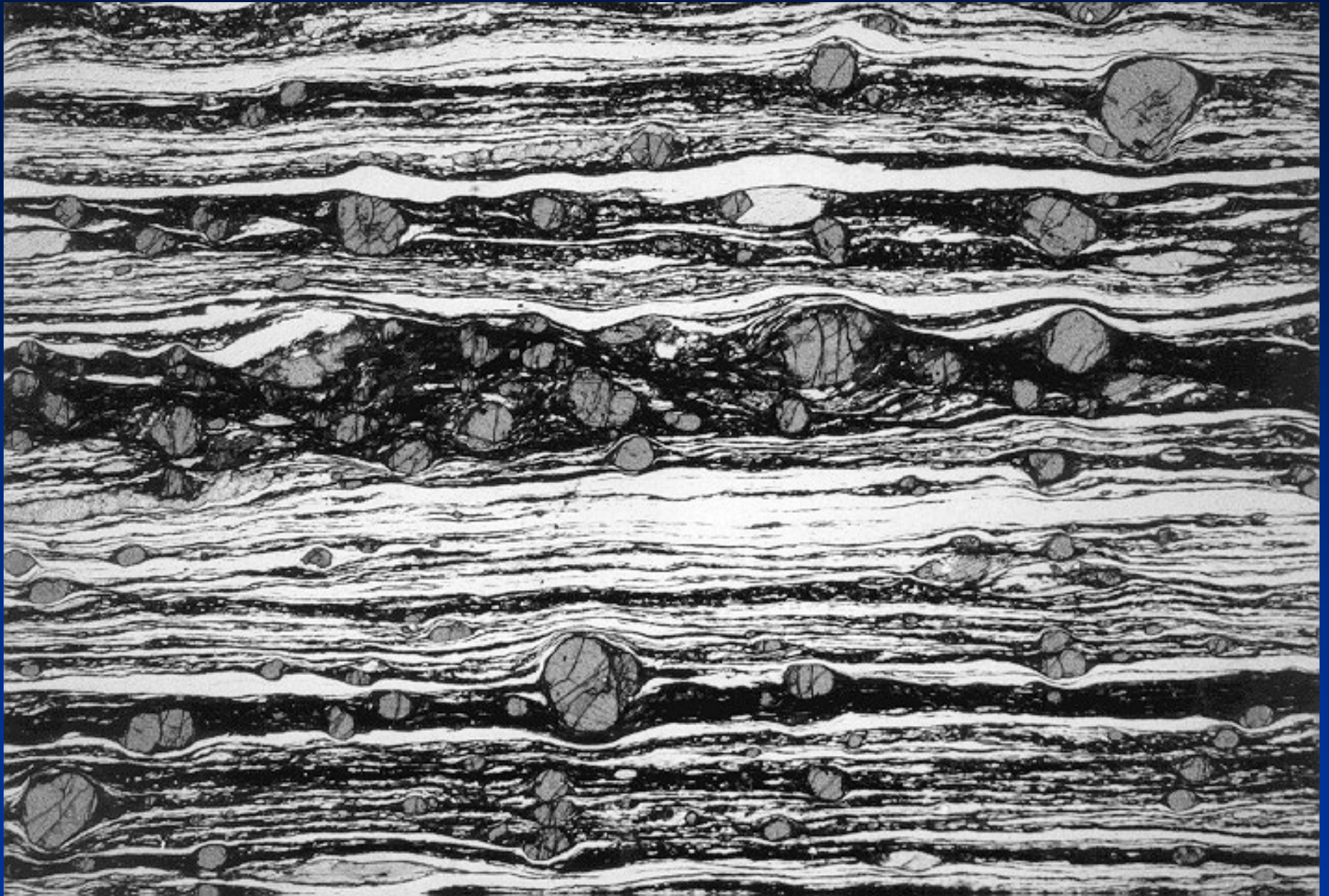

Da Passchier & Trouw, 1996



Da Passchier & Trouw, 1996

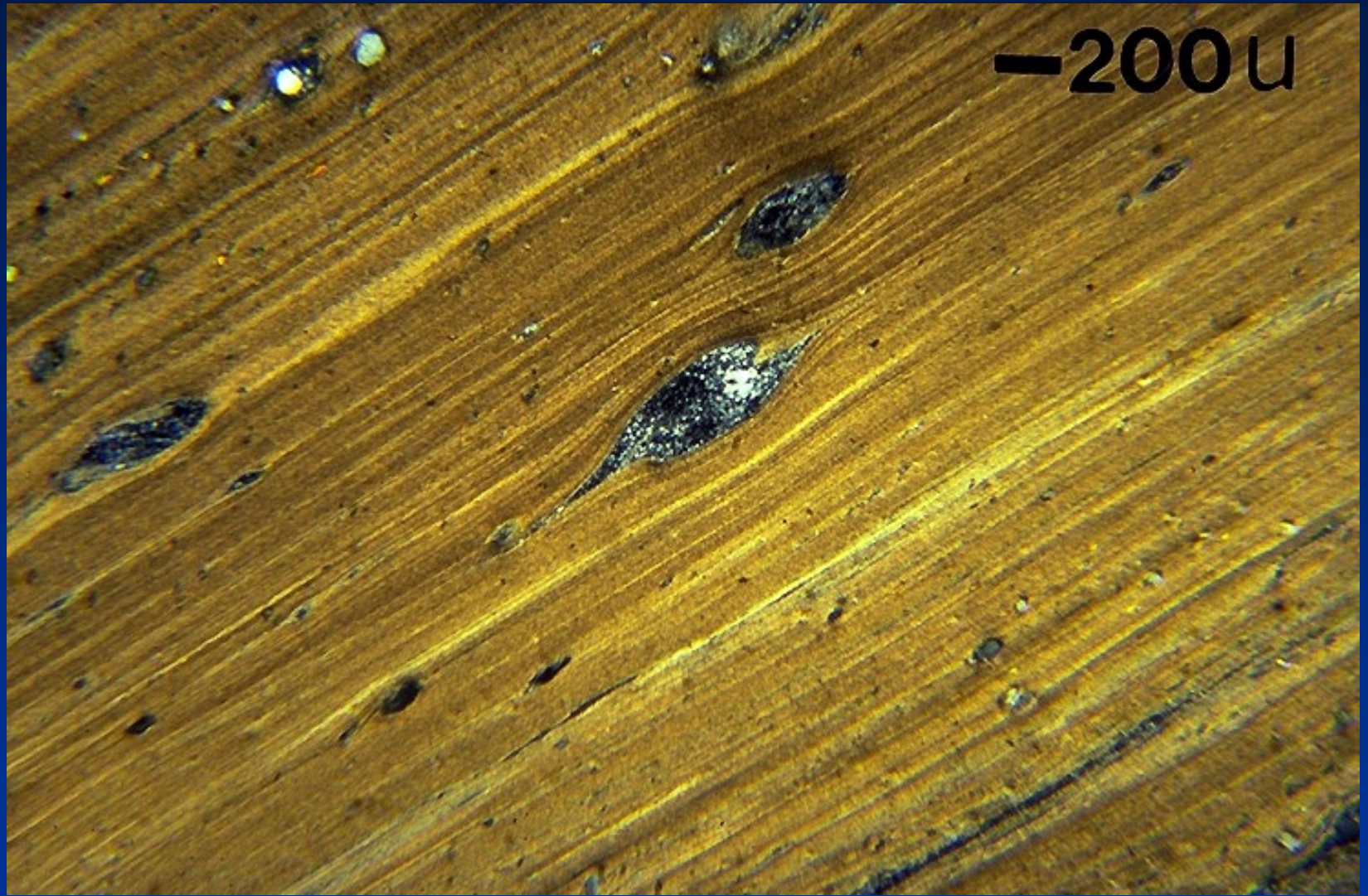

Da Passchier & Trouw, 1996

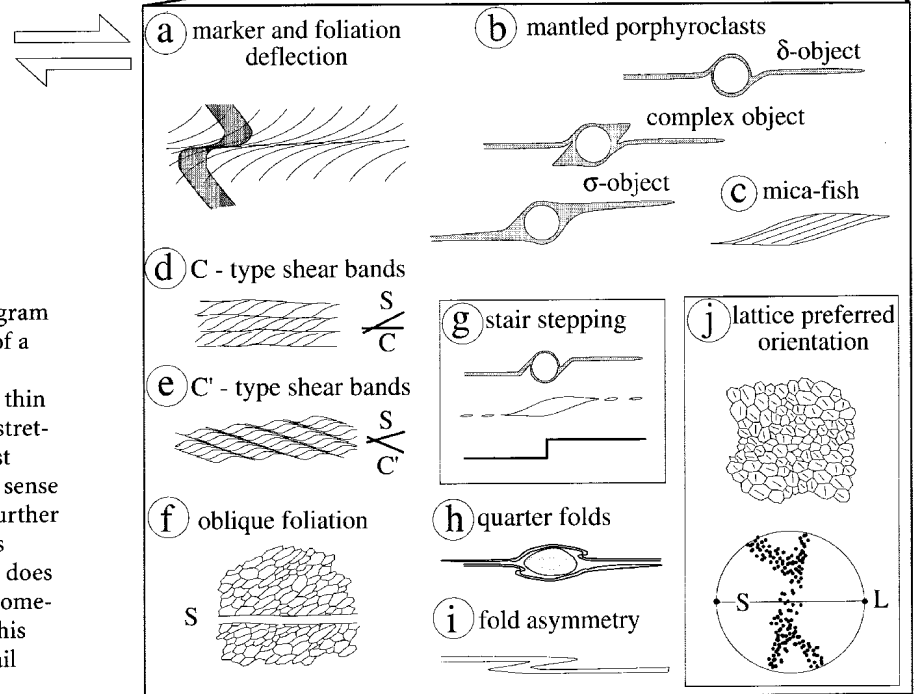
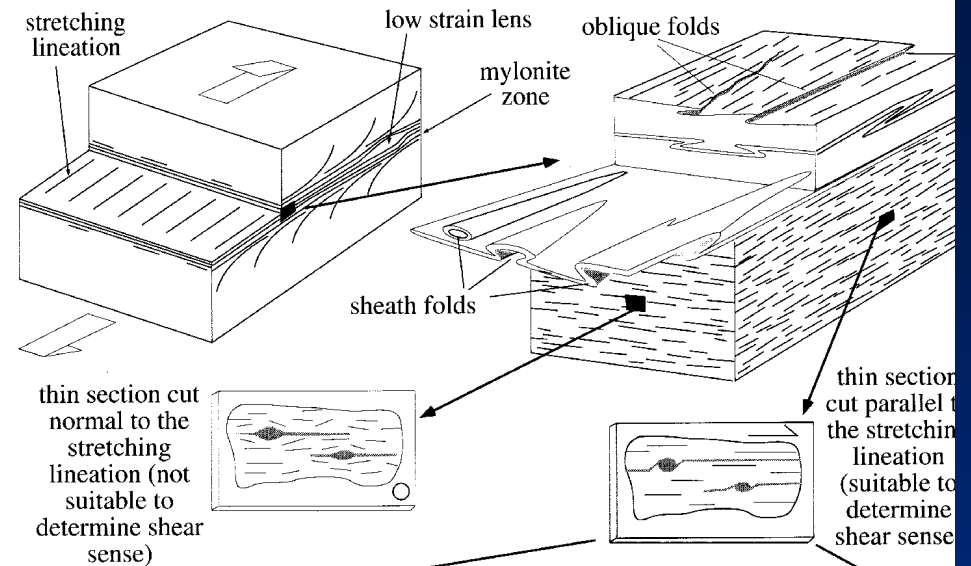

Fig. 5.9. Schematic diagram showing the geometry of a mylonite zone and the nomenclature used. For thin sections parallel to the stretching lineation, the most common types of shear sense indicators are shown. Further explanation in text. This Figure is schematic and does not show all possible geometries. Other Figures in this chapter show more detail

Indicatori cinematici: strutture σ



Figura 7.20. Relazioni tra simmetria delle strutture e modalità deformativa.

strutture σ e δ



Da van der Pluijm B., Marshak S., 2004, 2010

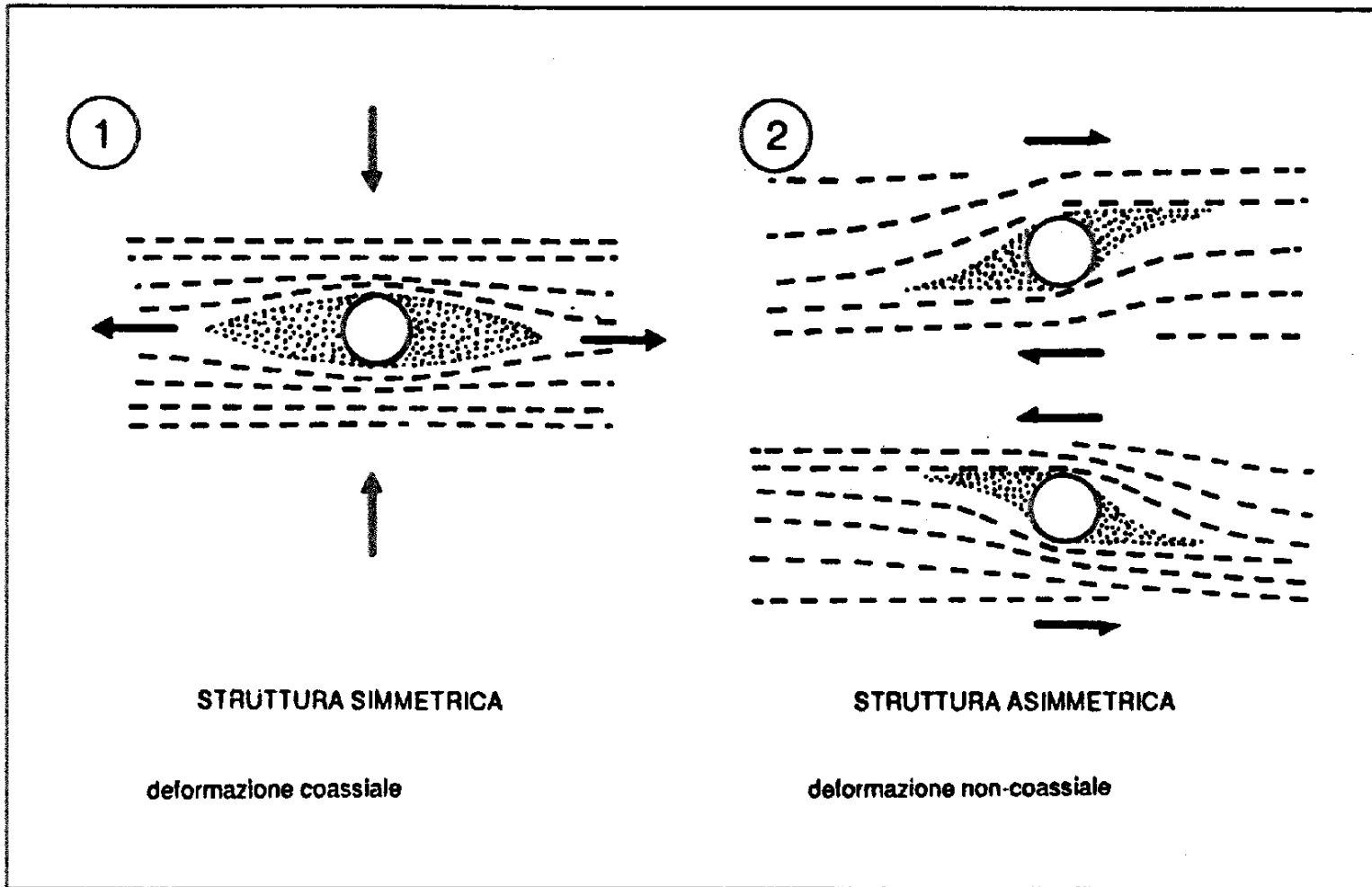
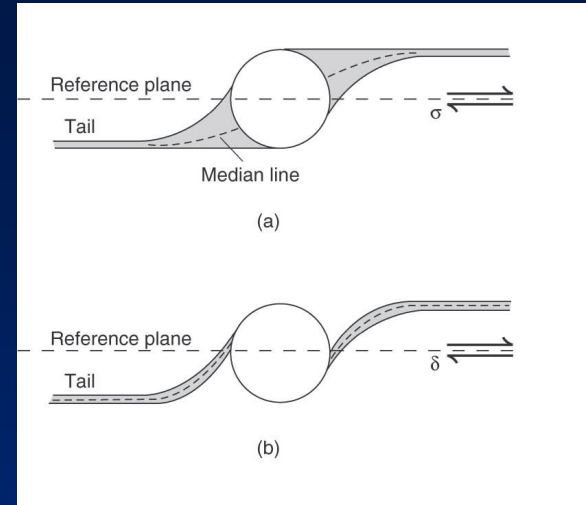

Da Fossen, 2010

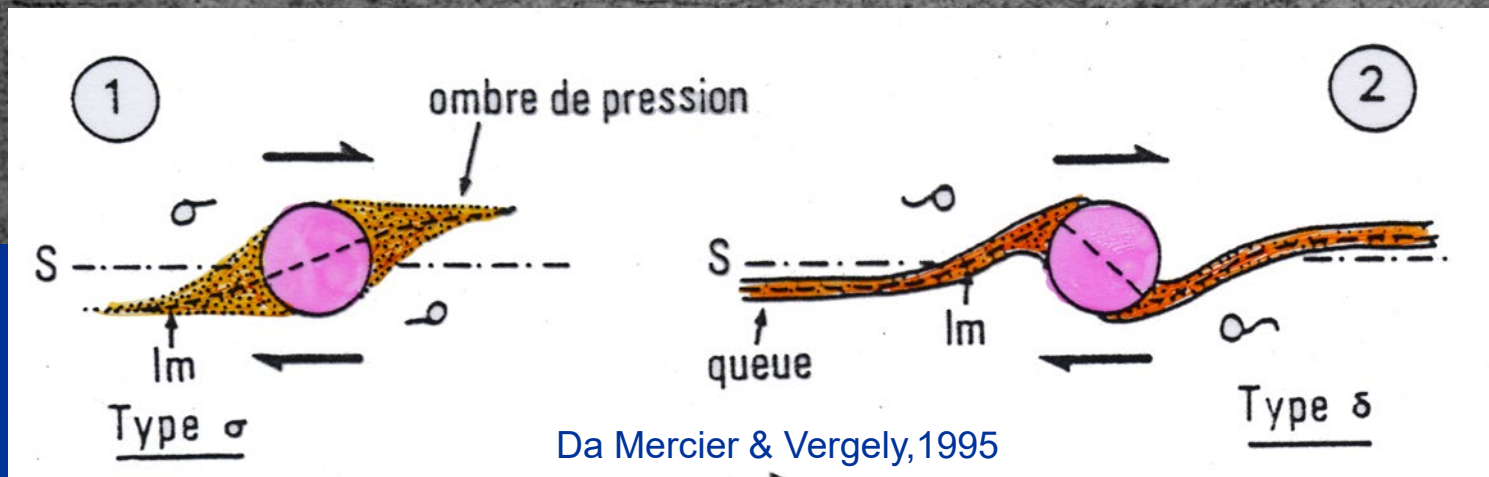
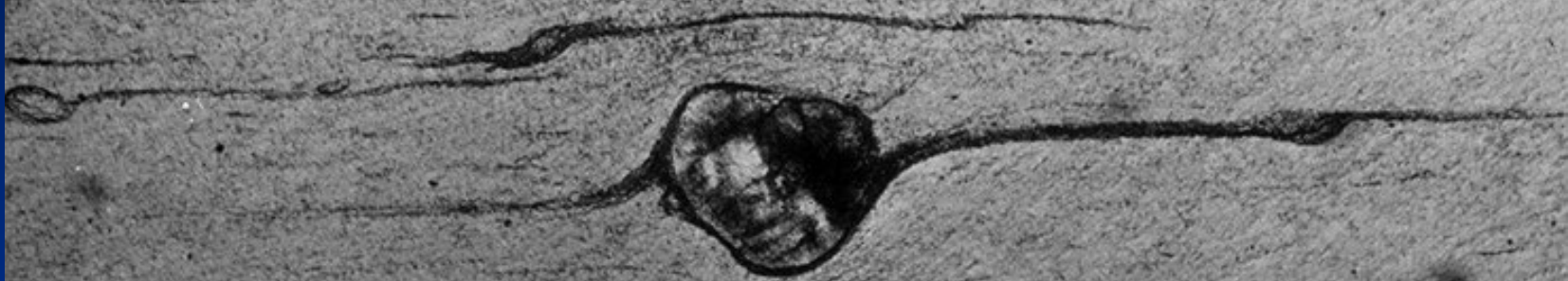

Da Mercier & Vergely, 1995

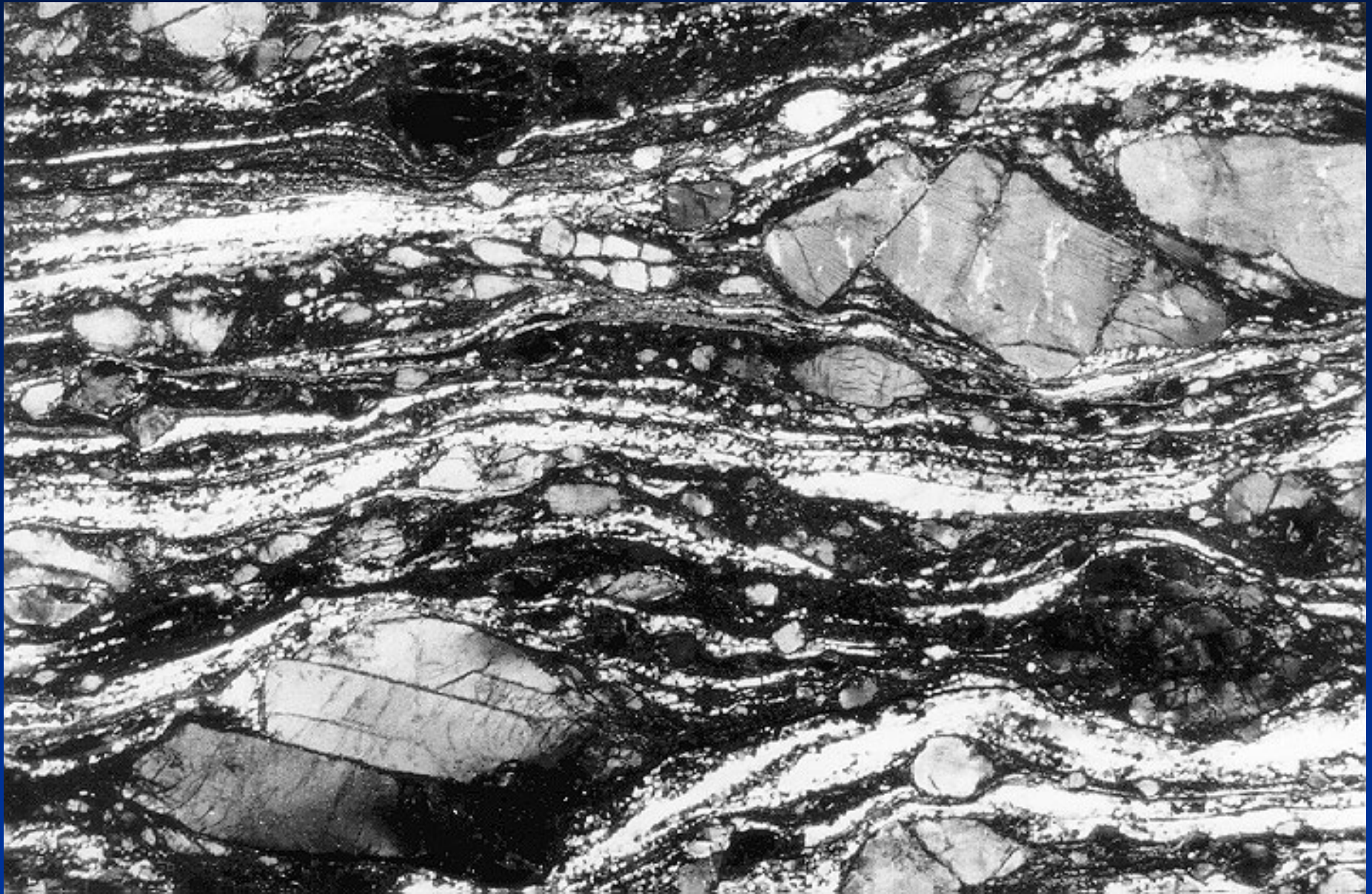

Passchier & Trouw, 2006

antithetic microfaults or shear zones in grains

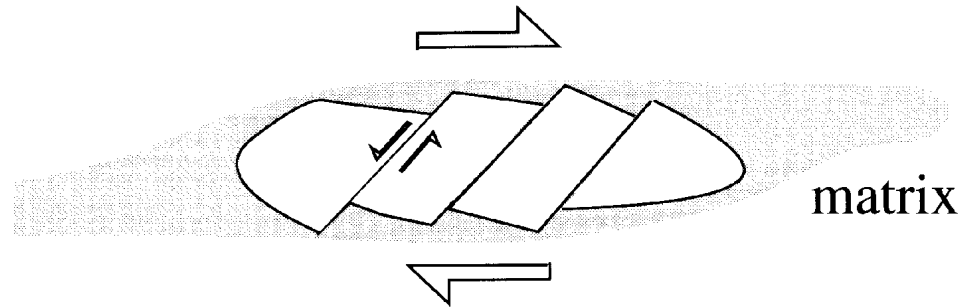

synthetic microfaults or shear zones in grains

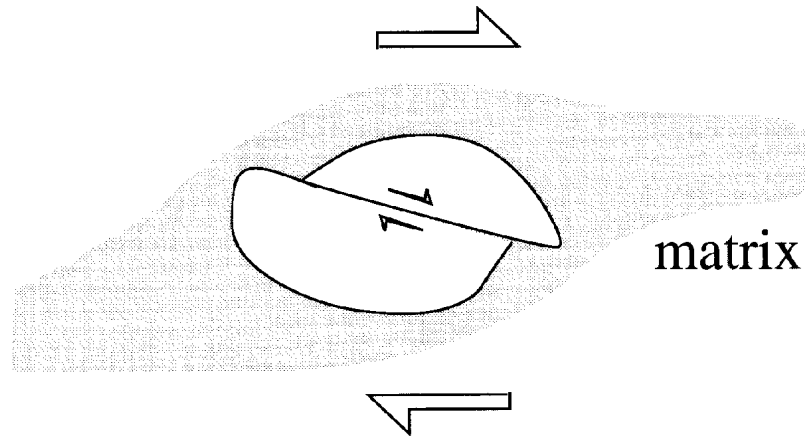
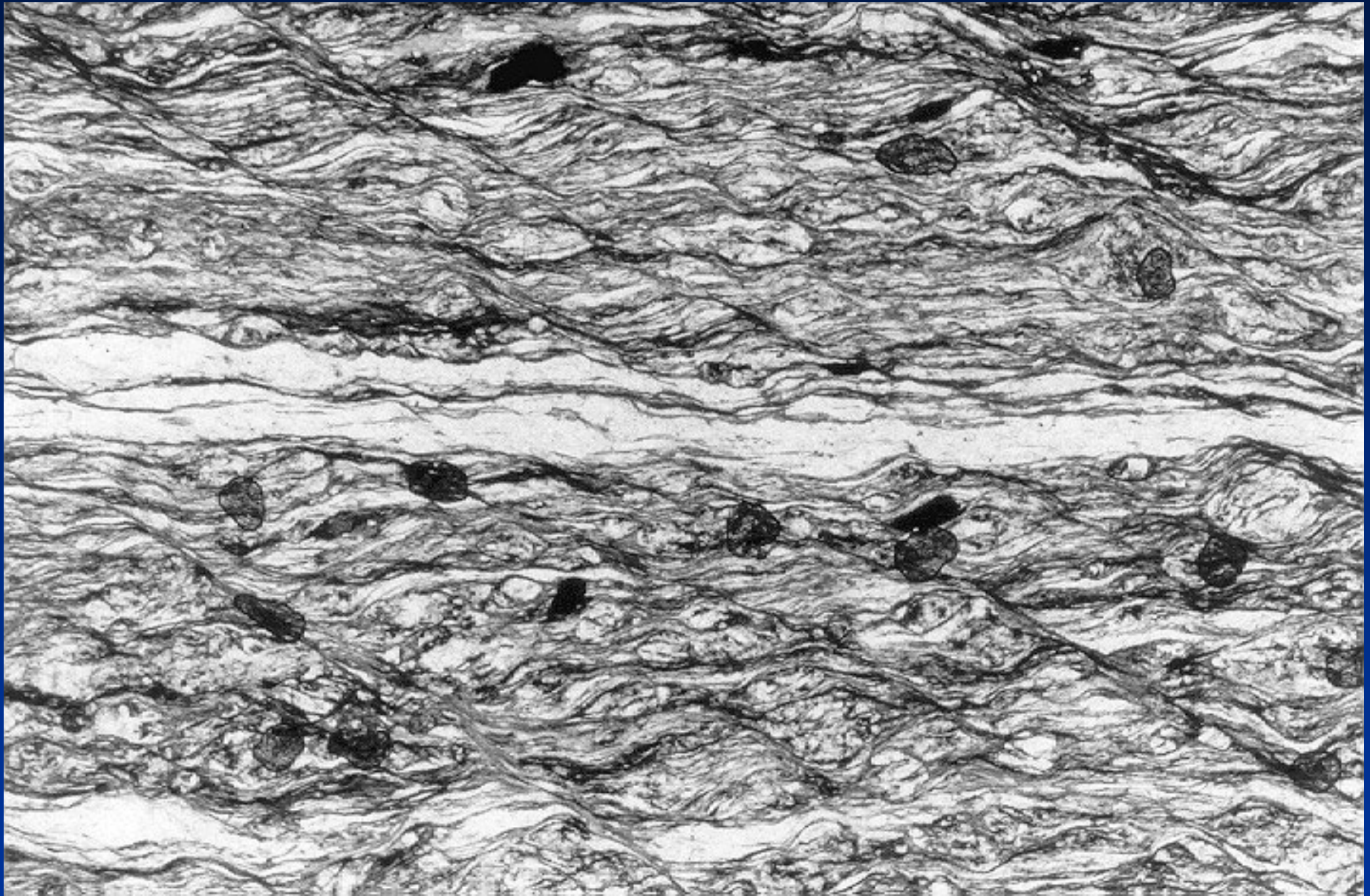

Fig. 5.31. Illustration of the two mechanisms of formation of stepped fragmented grains at similar bulk shear sense (*large arrows*)



Da Passchier & Trouw, 1996

Indicatori cinematici: strutture S-C e S-C'

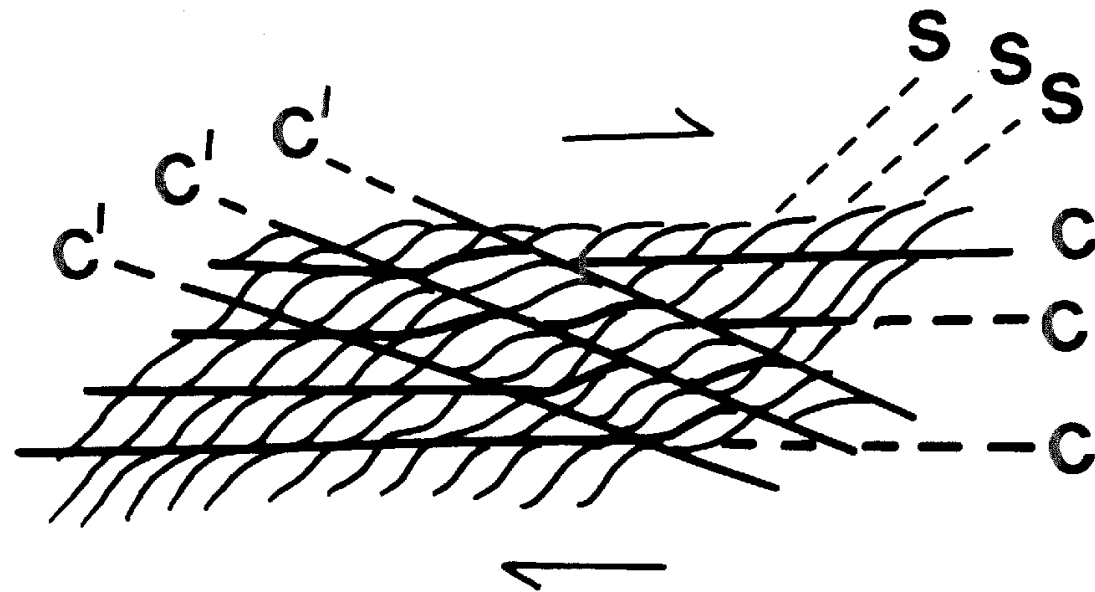
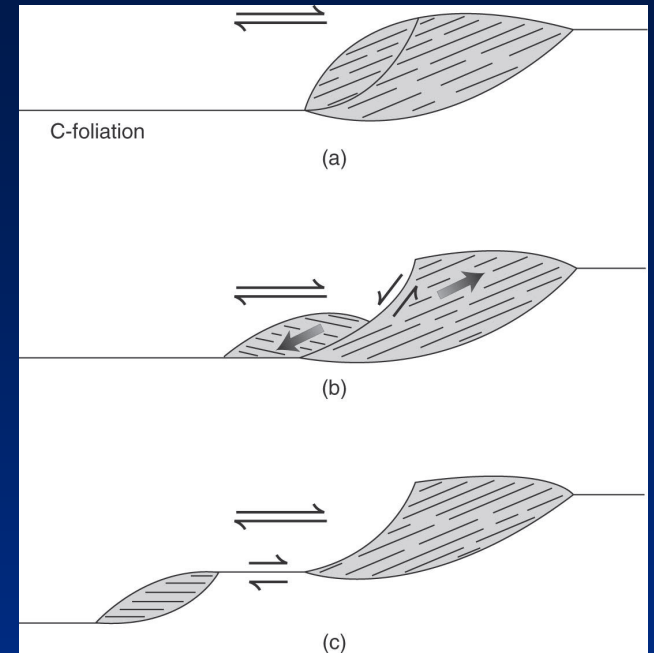
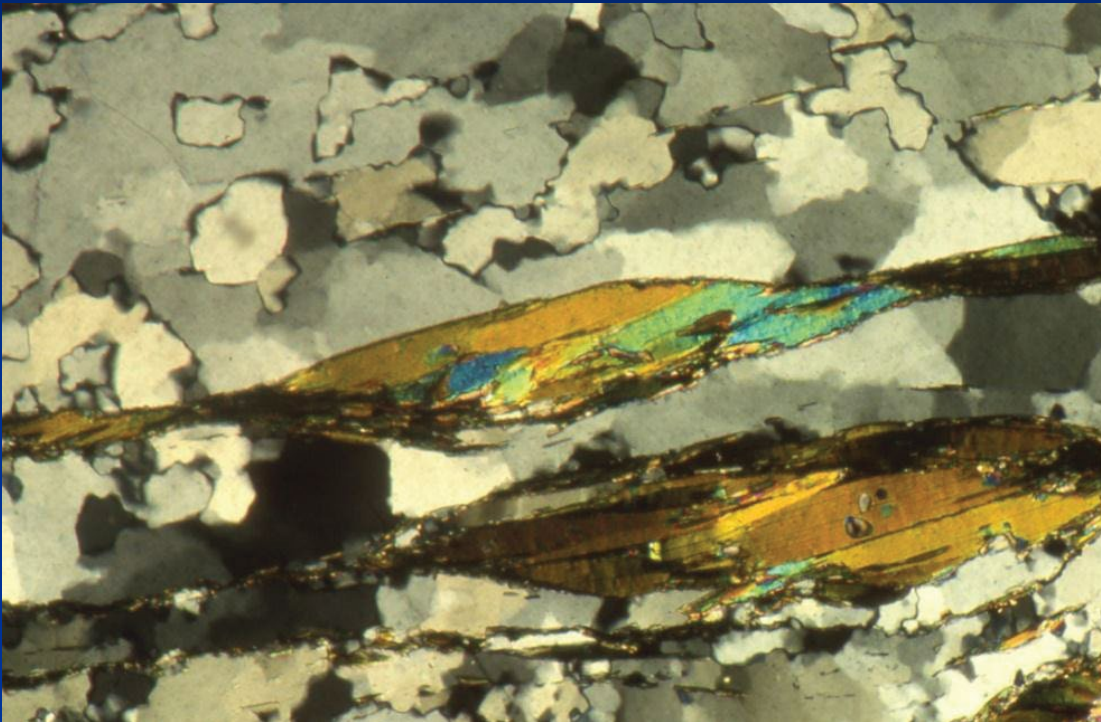

Figure 10.18 Schematic illustration of C' fabrics in relation to S and C fabrics.

Indicatori cinematici: «mica fish»



Da Passchier & Trouw, 1996



Da van der Pluijm B., Marshak S., 2004, 2010

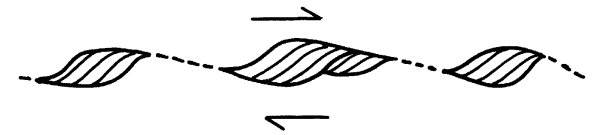
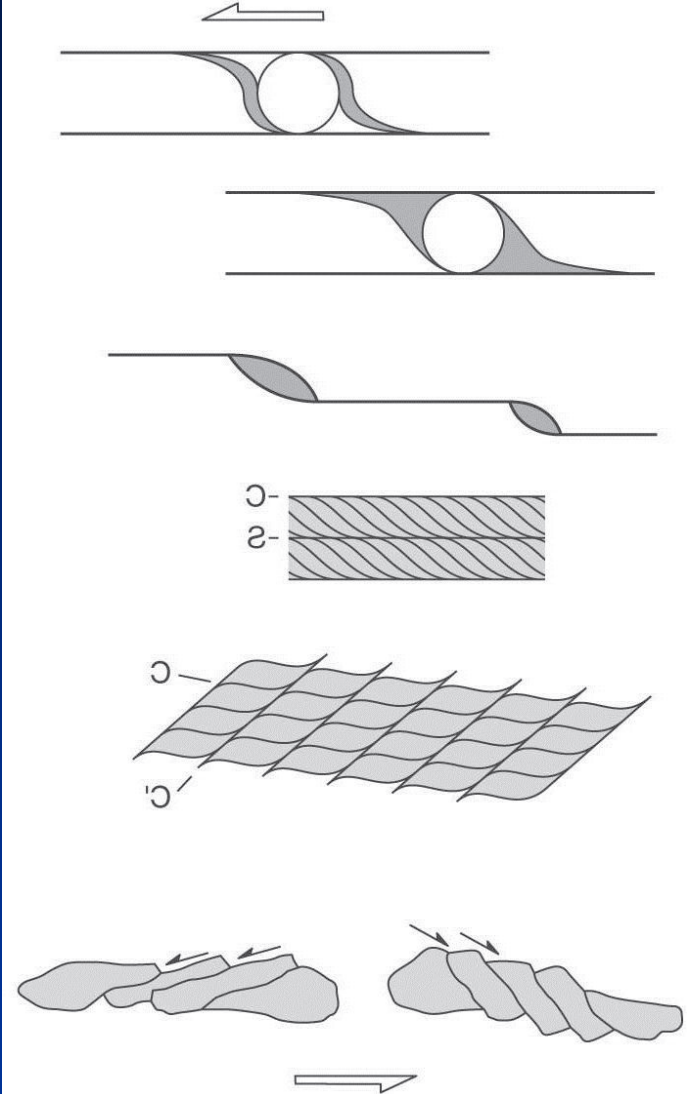
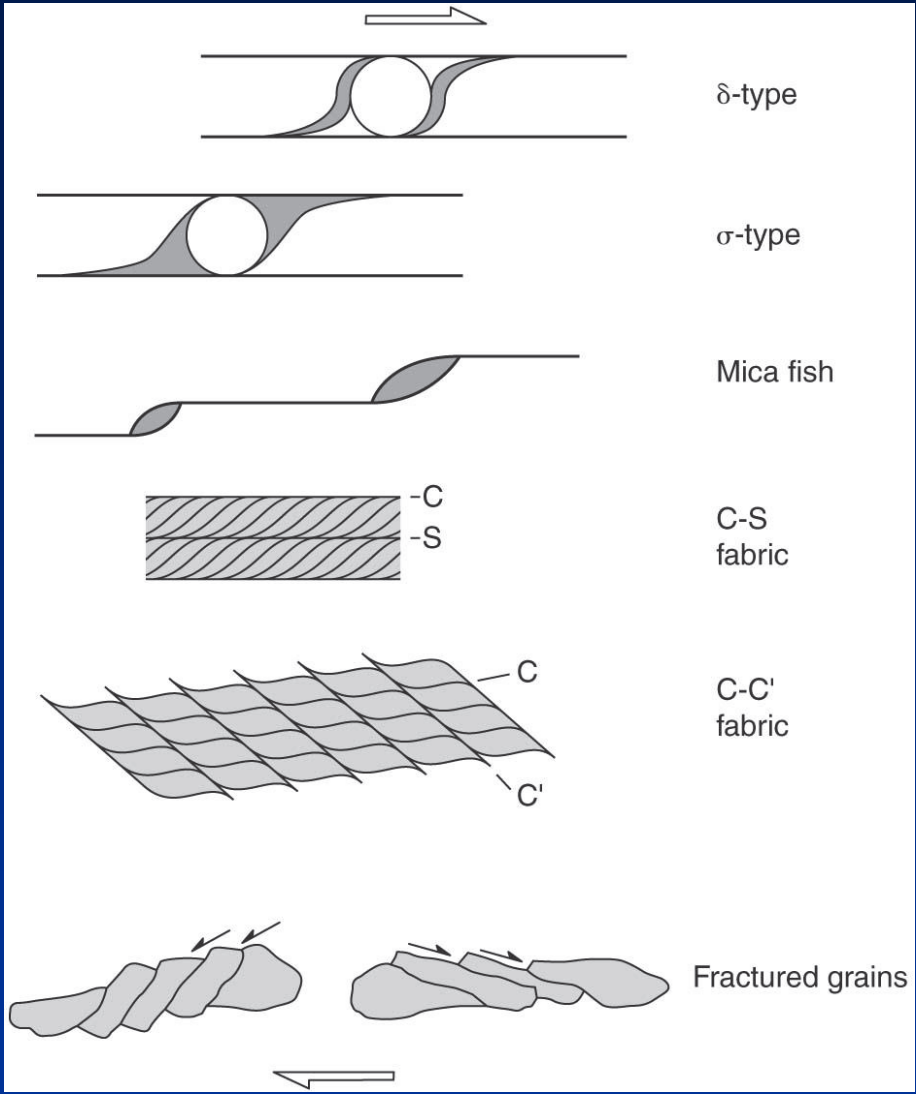

Figure 10.21 Trails and stair-stepping between mica-fish.

Da Barker, 1990



Rocce di faglia

- 1) Duttile superficiali
- 2) Fragili
- 3) Duttile

- 1) *Bande di scorrimento granuli in arenarie-siltiti; clivaggio scaglioso*
 - *Transizione: da scorrimento indipendente granuli a grain breakage; aumento pervasività e diminuzione spaziatura clivaggio scaglioso*
- 2) *Rocce di faglia da: taglio (clivaggio scaglioso), dissoluzione da pressione (PSC+meso-faglie+eventuale clivaggio scaglioso); cataclasiti, pseudotachiliti*
 - *Transizione: da cataclasiti a miloniti; pseudotachiliti*
- 3) *Zone di taglio duttile: miloniti (S-C e S-C' miloniti, pseudotachiliti (?), indicatori cinematici)*



Da Ramsay & Huber, 1987

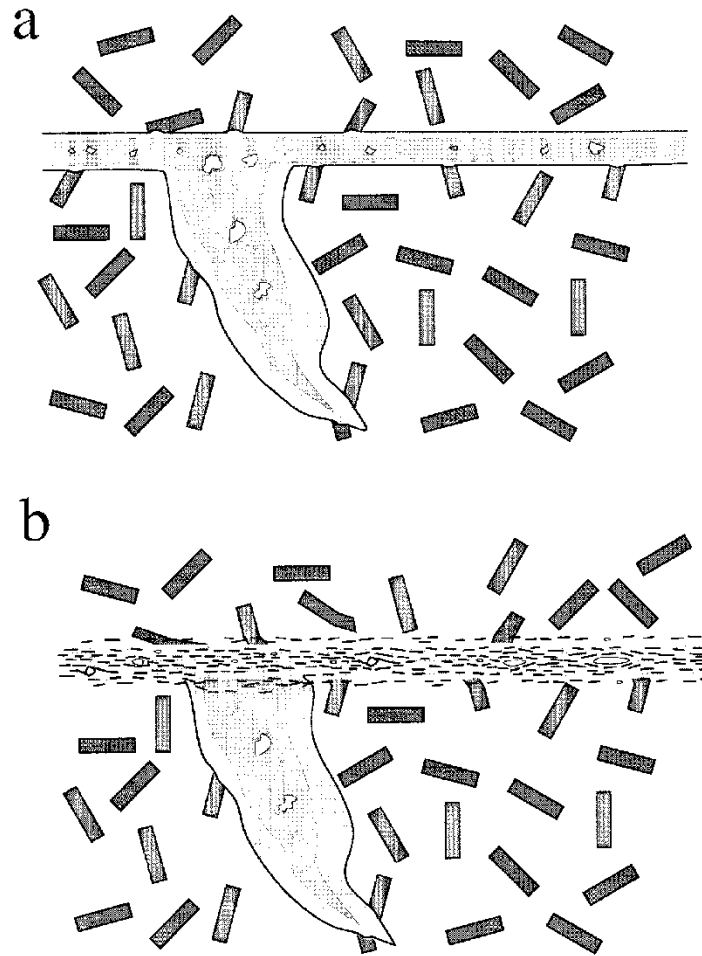
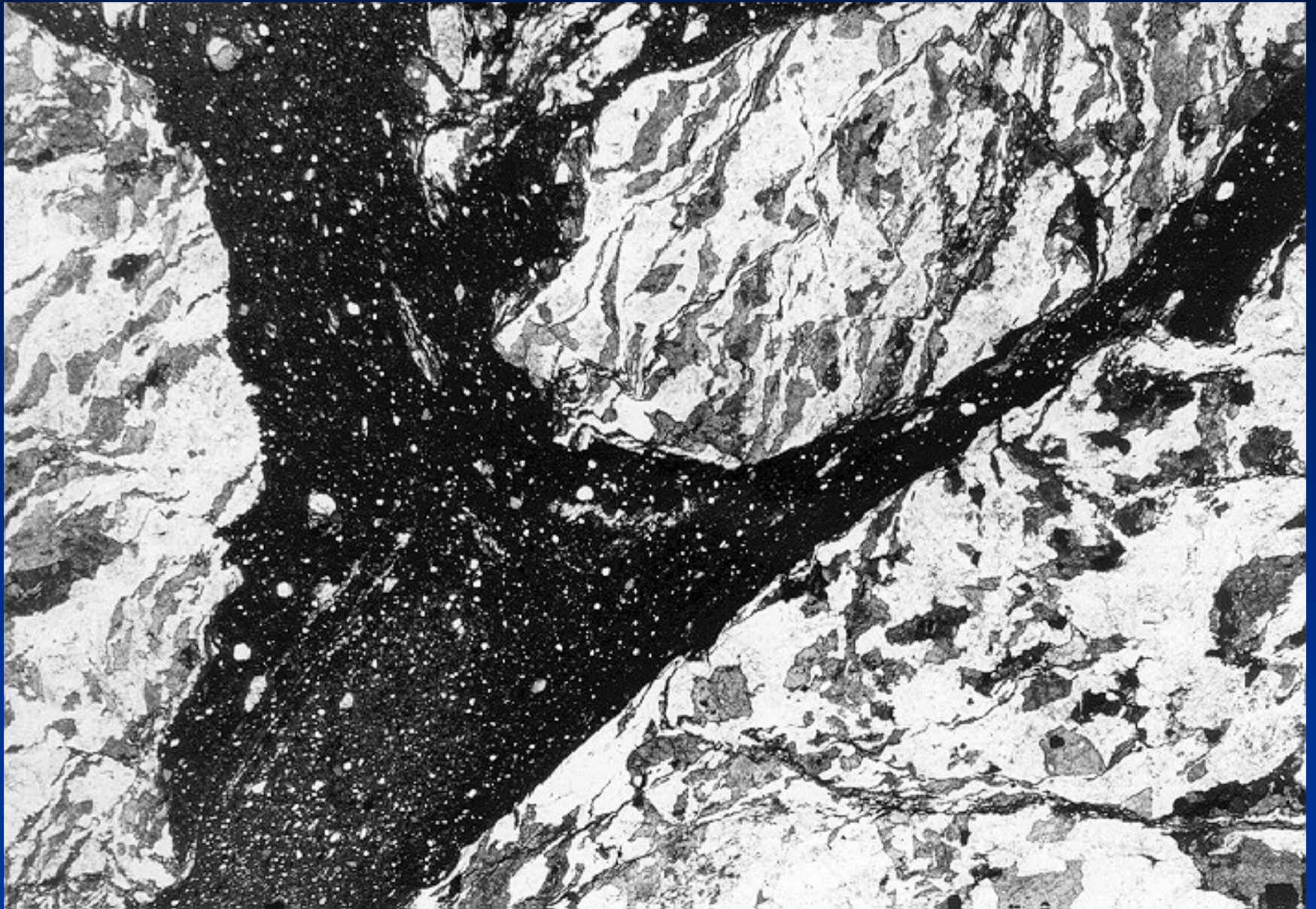
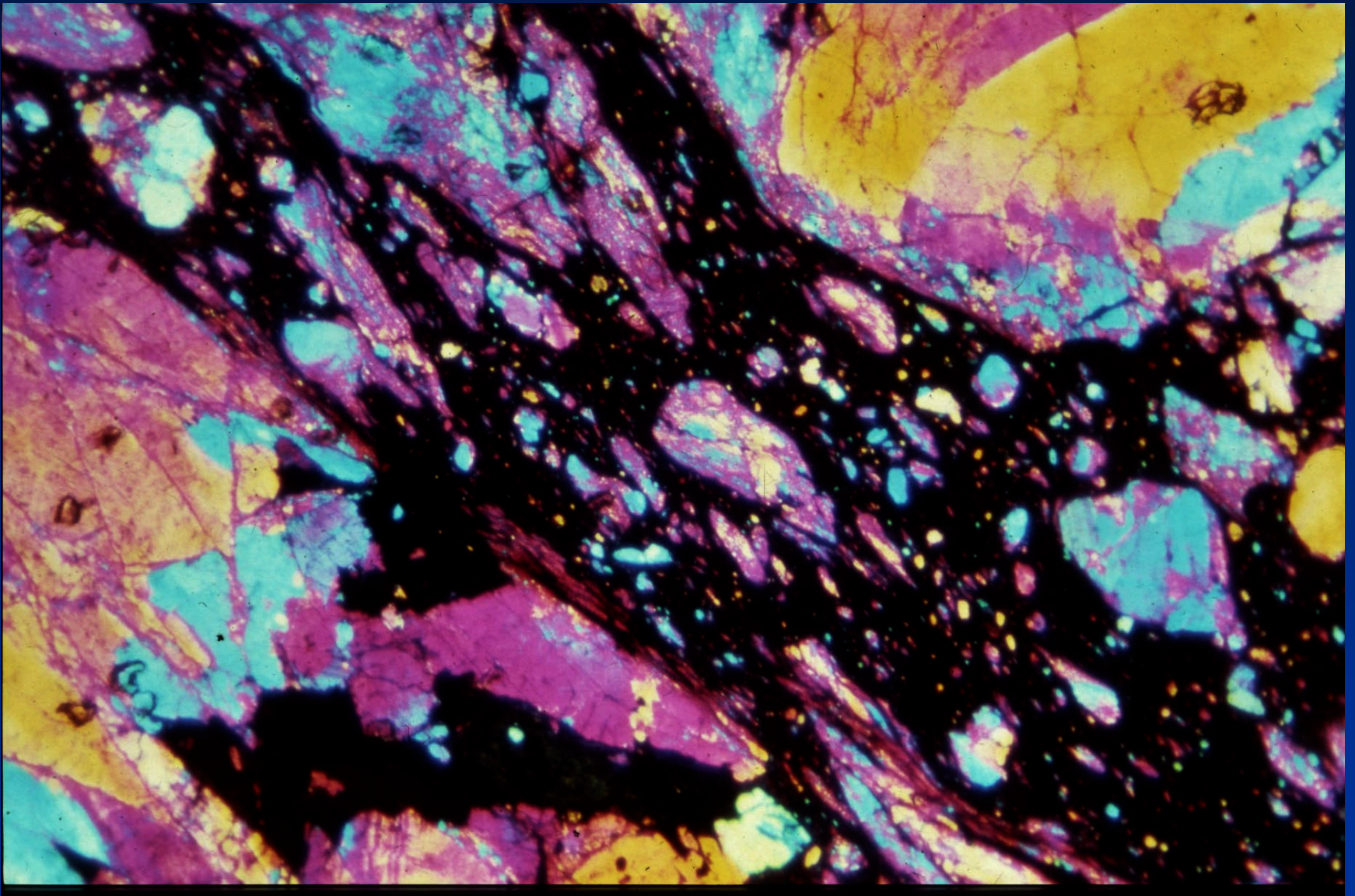

Fig. 5.3. a Schematic drawing of a typical pseudotachylyte with generation surface, injection vein, internal compositional banding and typical inclusions. The boundary with the wall rock is sharp. Mica grains in the wall rock show corrosion along the contact with pseudotachylyte. **b** Pseudotachylyte in which the generation surface has been reactivated as a mylonite zone. The mylonite can be recognised as a former pseudotachylyte by its fine-grained homogeneous nature and the presence of injection vein relics



Da Passchier & Trouw, 1996



Da Ramsay & Huber, 1987

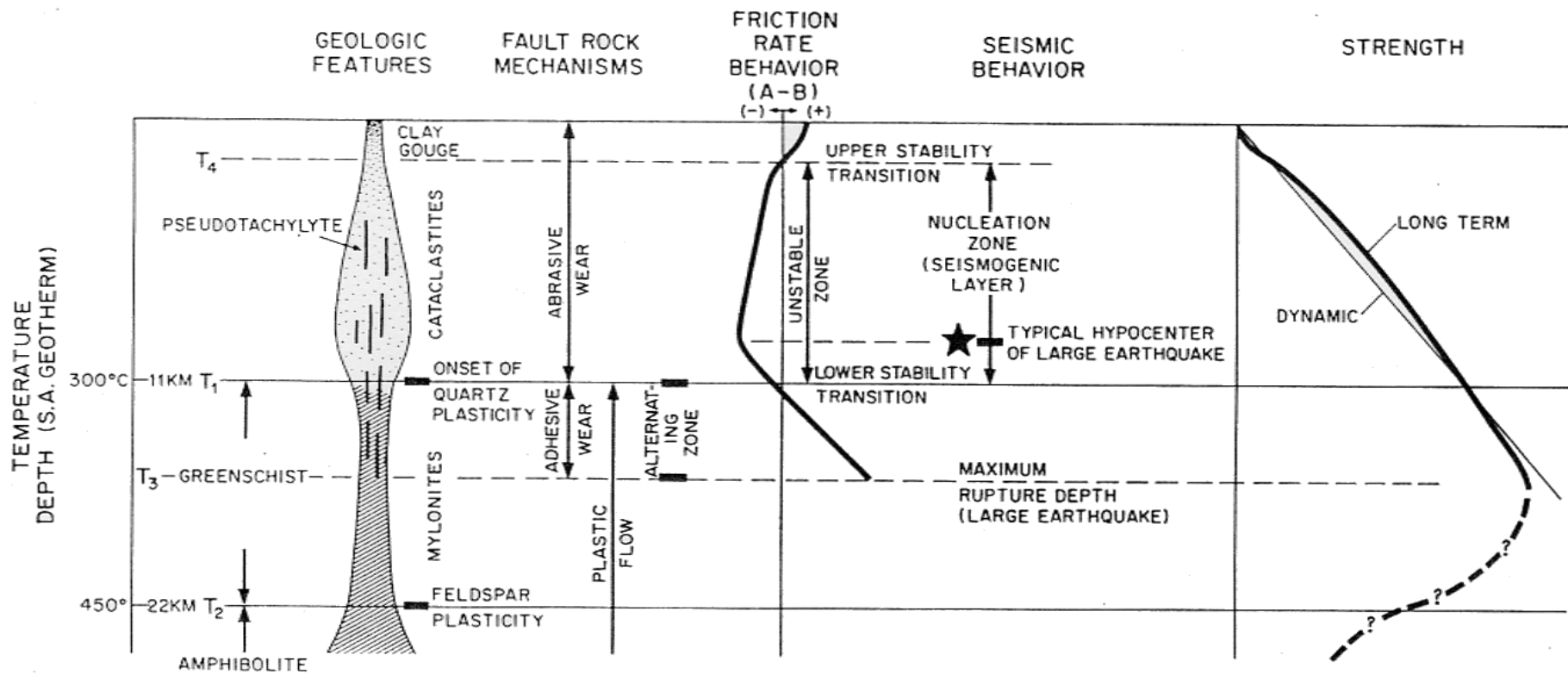

Fig. 3.19 Synoptic model of a shear zone. See the text for explanation. (From Scholz, 1988).