



Seismic source parameters

It is seen that the earthquake causes a discontinuity (jump) along a fault. We then describe the seismic source by a discontinuity of displacements. The mathematical treatment of the discontinuity, however, is rather complicated.

One may ask what system of forces in a continuous medium (= without faults, discontinuities) gives rise to the same displacements and forces generated by a discontinuity of displacement along a fault.

As the Earth before and after the earthquake is in a state of equilibrium, the system of forces can not be a single force - a singlet - which would result in a shift of the entire medium. The Earth must be in balance for rotations and then a couple of forces - single couple - is not acceptable. Therefore, the system forces it easier for an internal source to the Earth for which the sum of forces and moments is zero and that (proof omitted!) is equivalent to a discontinuity of displacement along the fault, appears to be the **TWO PAIR**.

For a description of a discontinuity of displacements oriented arbitrarily, we need a combination of nine pairs, called the seismic moment tensor.



Fisica Terrestre 2022-2023

Giovanni Costa

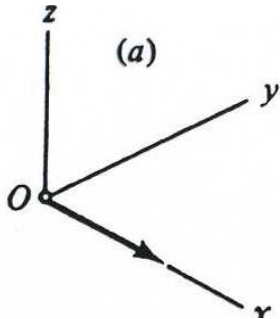

(a) A single force

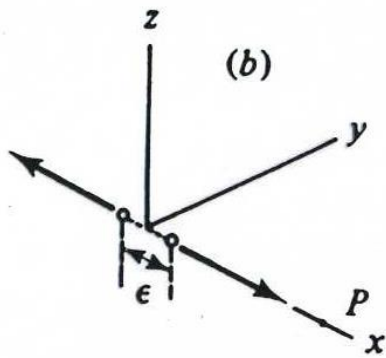

(b) A pair of equal and opposite forces as a **tension**

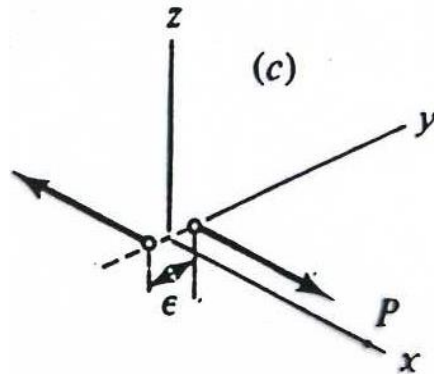

(c) A pair of equal and opposite forces with time around the z axis

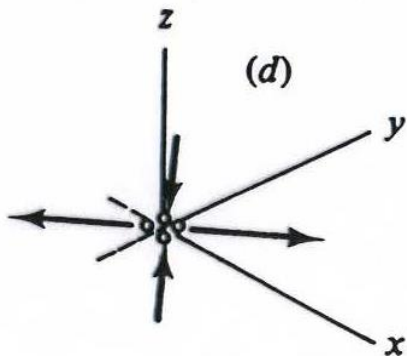

(d) Two pairs of forces, tension and compression are of equal intensity and perpendicular

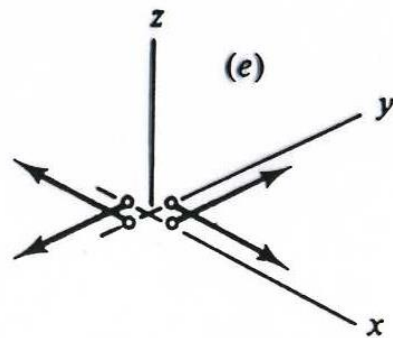

(e) Two pair of forces. Their moments around the z axis are equal and opposite



Fisica Terrestre 2022-2023

Giovanni Costa

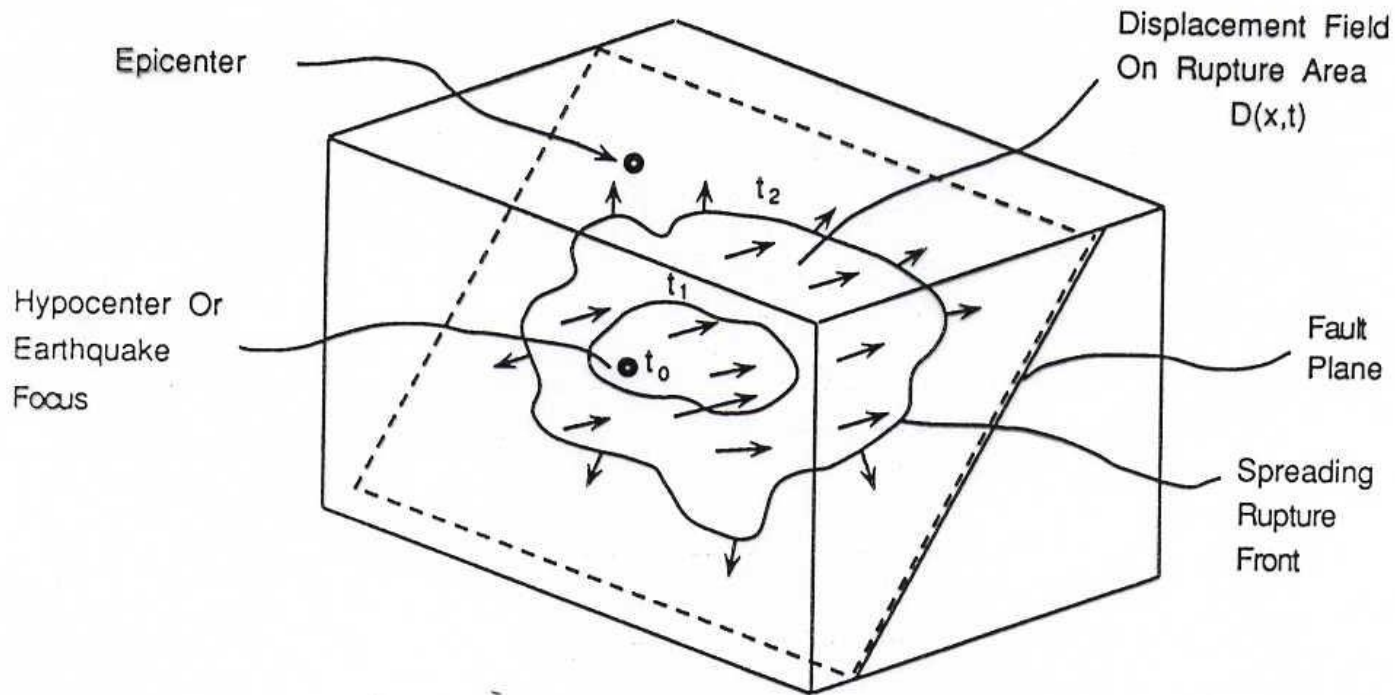

Schematic diagram of rupture on a fault that expands from the hypocenter on the fault plane. The motion starts at the focus and expands according to a front break on the fault plane function of space and time, separating regions that are in motion by those who still are not. All regions continuously radiate energy waves P and S. The displacement field varies over the surface of the fault. Note that the direction of propagation of the rupture is generally not parallel to the direction of sliding. (Modif. da Bolt, 1988)



Fisica Terrestre 2022-2023

Giovanni Costa

Simple representation yields seismic waves produced by a complex rupture involving displacements varying in space and time on irregular fault

First, approximate rupture with a constant average displacement D over a rectangular fault

Approximate further as a set of force couples.

Approximations are surprisingly successful at matching observed seismograms.

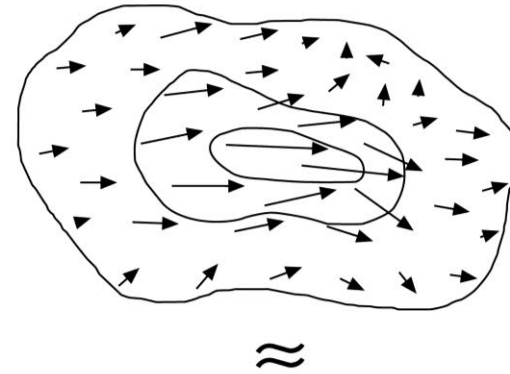

$$M = \int_A \mu D(A) dA$$

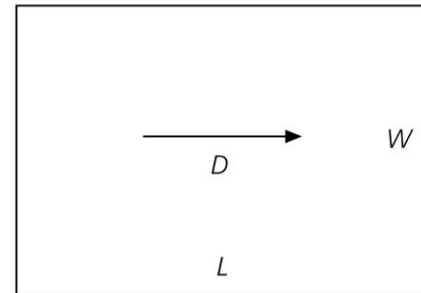

$$M = \mu DLW$$

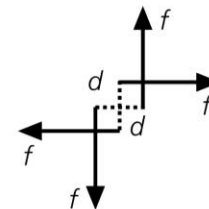

$$M = fd$$



Fisica Terrestre 2022-2023

Terremoto Amatrice 24 agosto 2016

Giovanni Costa

Rappresentazione 3D del modello di faglia.

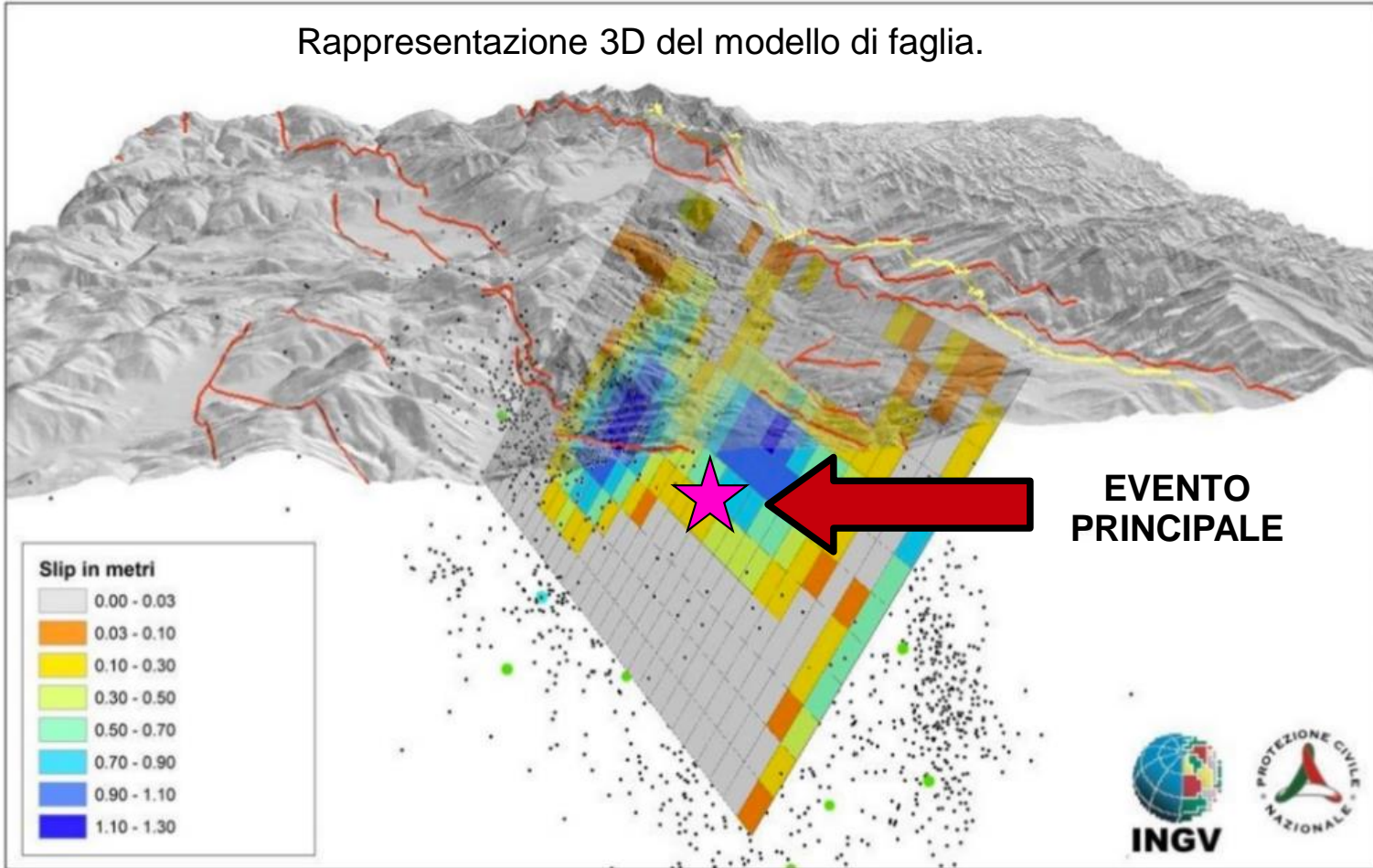



Fisica Terrestre 2022-2023

Giovanni Costa

$$\text{Sforzo} = \mu \times \text{deformazione} \quad \rightarrow \quad F/S = \mu \bar{u}/L \quad \rightarrow \quad FL = \mu \bar{u}S$$

$$M_0 = \mu \bar{u}S$$

The seismic moment is the product of the area of fault surface that ruptures, the average displacement along that surface, and a constant -- a measure of the elastic property of rock (i.e. how easily it can be stretched) called the **modulus of rigidity**.

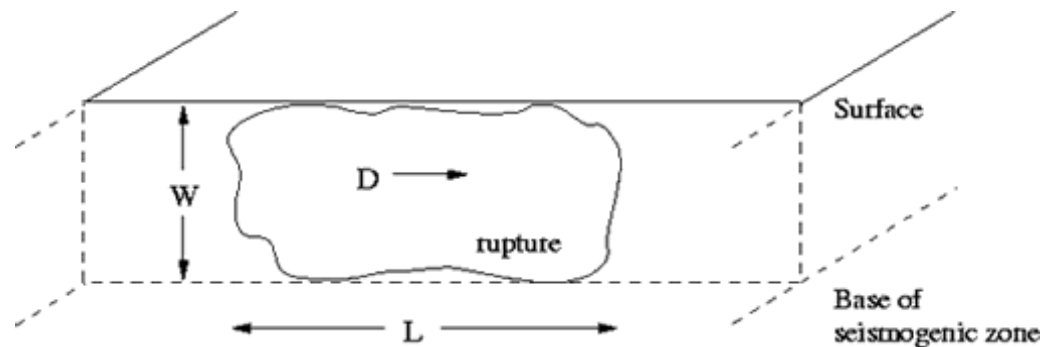



Fisica Terrestre 2022-2023

Giovanni Costa

The seismic moment is a measure of the size of an earthquake based on the area of fault rupture, the average amount of [slip](#), and the force that was required to overcome the friction sticking the rocks together that were offset by faulting.

Seismic moment can also be calculated from the amplitude [spectra](#) of seismic waves.

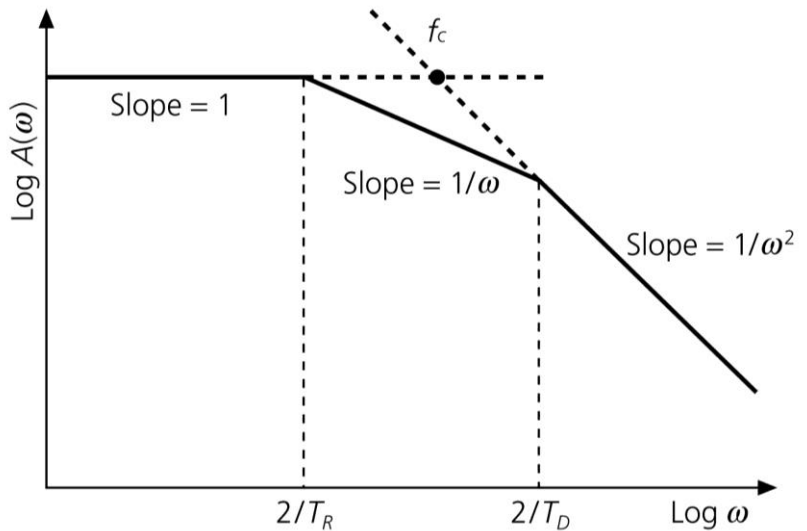

Approximation of the amplitude spectrum of a trapezoidal box car function:

$$\log |A(\omega)| =$$

$$= \left\{ \begin{array}{ll} \log M_0 & \omega < 2/T_R \\ \log M_0 - \log (T_R/2) - \log \omega & 2/T_R < \omega < 2/T_D \\ \log M_0 - \log (T_R T_D/4) - 2 \log \omega & 2/T_D < \omega \end{array} \right\}$$

The spectrum is often defined in terms of the "corner frequencies"

- SOURCE SPECTRUM is flat and equal to seismic moment at periods longer than corner frequency $2/T_R$
- Decays below corner frequency
- Corner frequency shifts to left (lower frequency) for larger earthquakes with longer faults



Fisica Terrestre 2022-2023

Giovanni Costa

$$M_0 = 4\pi\rho R\beta^3\Omega_s(\omega \rightarrow 0) / \mathcal{R}_{\Theta\Phi}$$

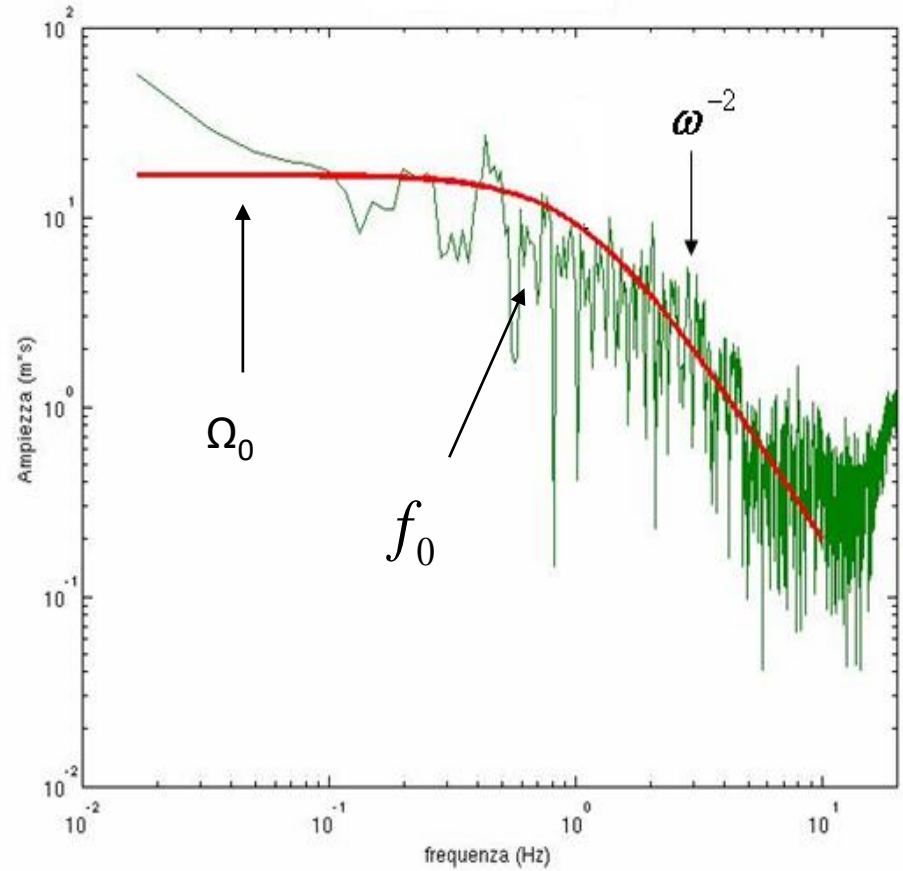



Fisica Terrestre 2022-2023

Giovanni Costa

(Moment) = (Rock Rigidity) × (Fault Area) × (Slip Distance)

$$M_0 = \mu Ad$$

$$(\text{dyne-cm}) = \left[\frac{\text{dyne}}{\text{cm}^2} \right] \times (\text{cm}^2) \times (\text{cm})$$

The **moment** of an earthquake, is fundamental to our understanding of how dangerous faults of a certain size can be.



A seismic source oriented arbitrarily in space, can be described with the help of the seismic moment tensor, whose elements are the individual pairs oriented along the spatial axes. With the moment tensor, you can describe also sources not two pair type, i.e., sources that have an isotropic component (explosion or implosion).

Figure 4.4-4: Nine force couples which compose the seismic moment tensor.

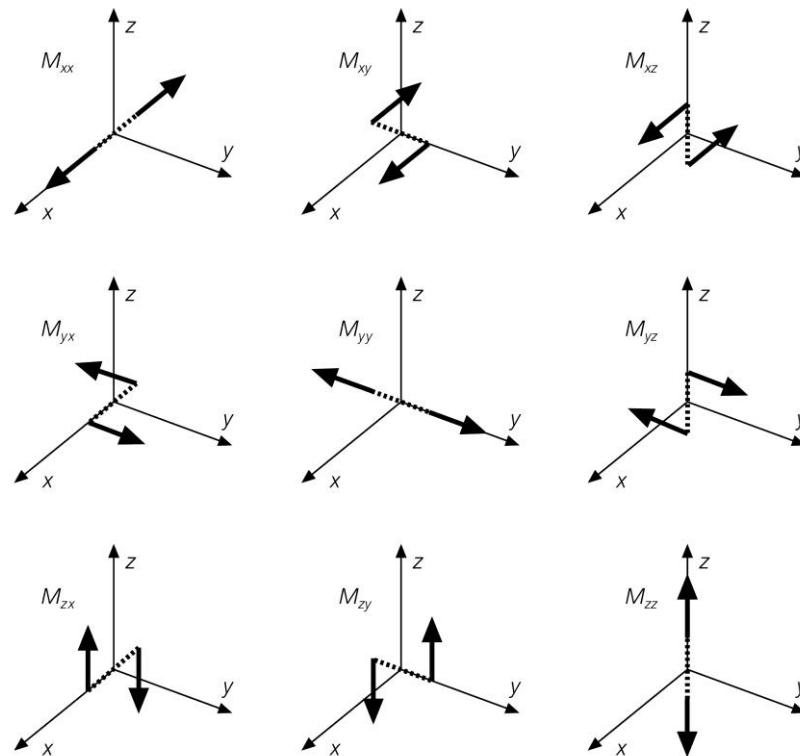



Fisica Terrestre 2022-2023

Giovanni Costa

A double couple acting in the plane of the x and y axes (or axis 1 and axis 2) respectively along the axes x and y, which will be represented by tensor elements with the two pairs (1,2) and (2,1):

$$M = M_0 \begin{bmatrix} 0 & M_{12} & 0 \\ M_{12} & 0 & 0 \\ 0 & 0 & 0 \end{bmatrix} \quad \text{Mo is scalar moment}$$

FOR FAULT ORIENTED NORMAL TO COORDINATE AXIS, MOMENT TENSOR IS

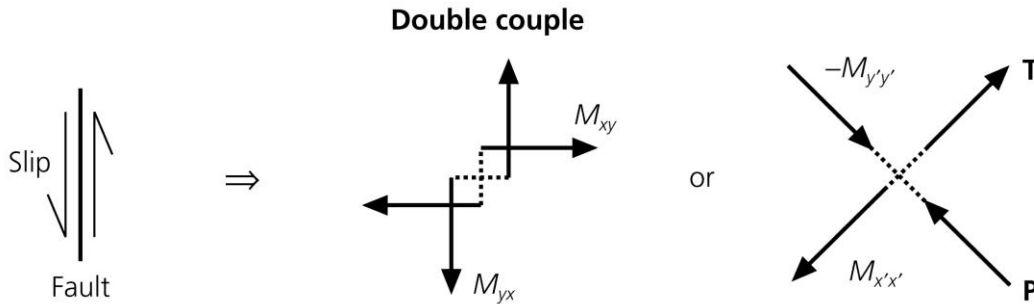

$$\mathbf{M} = \begin{pmatrix} 0 & M_0 & 0 \\ M_0 & 0 & 0 \\ 0 & 0 & 0 \end{pmatrix} = M_0 \begin{pmatrix} 0 & 1 & 0 \\ 1 & 0 & 0 \\ 0 & 0 & 0 \end{pmatrix}$$



Fisica Terrestre 2022-2023

Giovanni Costa

The general form of seismic moment tensor is:

$$M = \begin{bmatrix} M_{11} & M_{12} & M_{13} \\ M_{21} & M_{22} & M_{23} \\ M_{31} & M_{32} & M_{33} \end{bmatrix}$$

The forces equivalent to a generic point source can be determined from the analysis of the eigenvalues and eigenvectors of the moment tensor.

A common way to decompose the moment tensor is in terms of isotropic components, TWO PAIR (DC) AND LINEAR VECTOR COMPENSATED DIPOLE (CLVD).

Isotropic



Double Couple



CLVD



particle motion

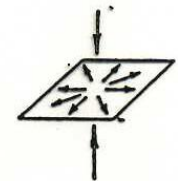

example

explosion

slip on a fault

uniform outward motion in plane due to normal shortening



Fisica Terrestre 2022-2023

Giovanni Costa

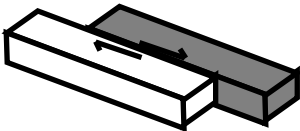

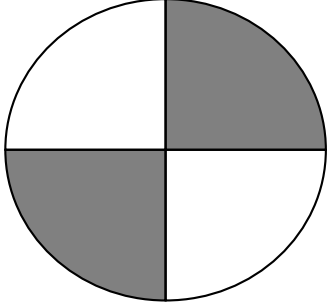

Figure 4.4-6: Selected moment tensors and their associated focal mechanisms.

	Moment tensor	Beachball	Moment tensor	Beachball
EXPLOSION IMPLOSION	$\frac{1}{\sqrt{3}} \begin{pmatrix} 1 & 0 & 0 \\ 0 & 1 & 0 \\ 0 & 0 & 1 \end{pmatrix}$		$-\frac{1}{\sqrt{3}} \begin{pmatrix} 1 & 0 & 0 \\ 0 & 1 & 0 \\ 0 & 0 & 1 \end{pmatrix}$	
EARTHQUAKES	$-\frac{1}{\sqrt{2}} \begin{pmatrix} 0 & 1 & 0 \\ 1 & 0 & 0 \\ 0 & 0 & 0 \end{pmatrix}$		$\frac{1}{\sqrt{2}} \begin{pmatrix} 1 & 0 & 0 \\ 0 & -1 & 0 \\ 0 & 0 & 0 \end{pmatrix}$	
(DOUBLE COUPLE)	$\frac{1}{\sqrt{2}} \begin{pmatrix} 0 & 0 & -1 \\ 0 & 0 & 0 \\ -1 & 0 & 0 \end{pmatrix}$		$\frac{1}{\sqrt{2}} \begin{pmatrix} 0 & 0 & 0 \\ 0 & 0 & -1 \\ 0 & -1 & 0 \end{pmatrix}$	
	$\frac{1}{\sqrt{2}} \begin{pmatrix} -1 & 0 & 0 \\ 0 & 0 & 0 \\ 0 & 0 & 1 \end{pmatrix}$		$\frac{1}{\sqrt{2}} \begin{pmatrix} 0 & 0 & 0 \\ 0 & -1 & 0 \\ 0 & 0 & 1 \end{pmatrix}$	
	$\frac{1}{\sqrt{6}} \begin{pmatrix} 1 & 0 & 0 \\ 0 & -2 & 0 \\ 0 & 0 & 1 \end{pmatrix}$		$\frac{1}{\sqrt{6}} \begin{pmatrix} -2 & 0 & 0 \\ 0 & 1 & 0 \\ 0 & 0 & 1 \end{pmatrix}$	
OTHER SOURCES (CLVD)	$\frac{1}{\sqrt{6}} \begin{pmatrix} 1 & 0 & 0 \\ 0 & 1 & 0 \\ 0 & 0 & -2 \end{pmatrix}$		$-\frac{1}{\sqrt{6}} \begin{pmatrix} 1 & 0 & 0 \\ 0 & 1 & 0 \\ 0 & 0 & -2 \end{pmatrix}$	



Fisica Terrestre 2022-2023

Giovanni Costa

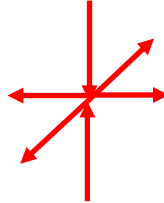
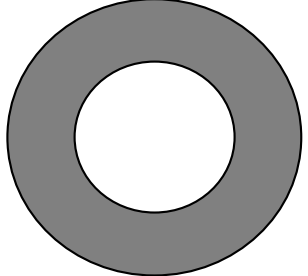
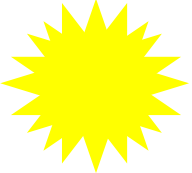
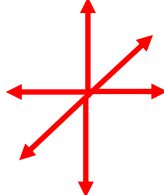
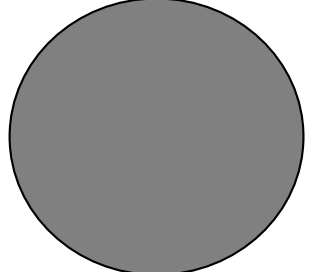
Model	Source	M	Couples	Focal Mechanism
	Double-couple (DC)	$\begin{pmatrix} 0 & 1 & 0 \\ 1 & 0 & 0 \\ 0 & 0 & 0 \end{pmatrix}$		
	Compensated linear vector dipole (CLVD)	$\begin{pmatrix} \frac{1}{2} & 0 & 0 \\ 0 & \frac{1}{2} & 0 \\ 0 & 0 & -1 \end{pmatrix}$		
	Isotropic	$\begin{pmatrix} 1 & 0 & 0 \\ 0 & 1 & 0 \\ 0 & 0 & 1 \end{pmatrix}$		



Complex source model

kinematic source model

In it is **assigned or determined the displacement** on the fault. Among the kinematic models briefly mention only the model of Haskell for a fault rectangular type (big earthquakes) and that of Madariaga for a fault of the circular type (earthquakes small-medium).

Dynamic source model

In them are **assigned or determined stress** and the fall of stress on the fault. According to them it determines the seismic radiation.

It is a complex problem even in 2D. Analytical solutions exist for semi-infinite fractures. To solve these problems makes extensive use of computer modeling programs with finite elements, finite differences, etc.

Are not covered in this course.



Fisica Terrestre 2022-2023

Giovanni Costa

MODELLO DI HASKELL

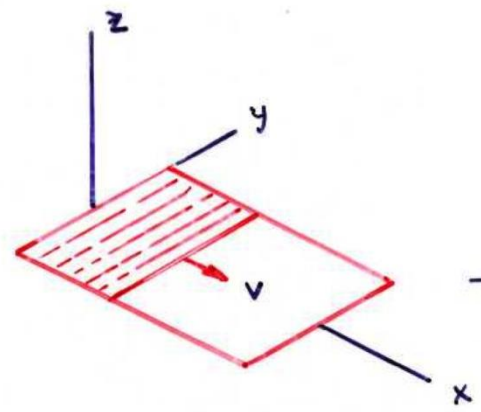

v = RUPTURE FRONT VELOCITY

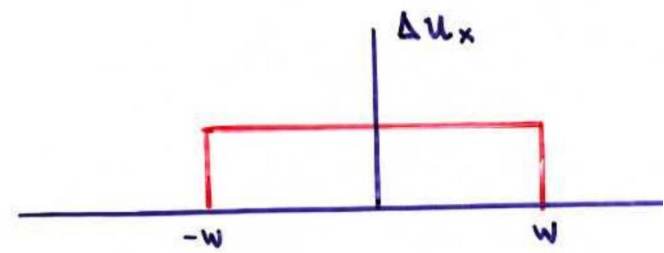

SLIP

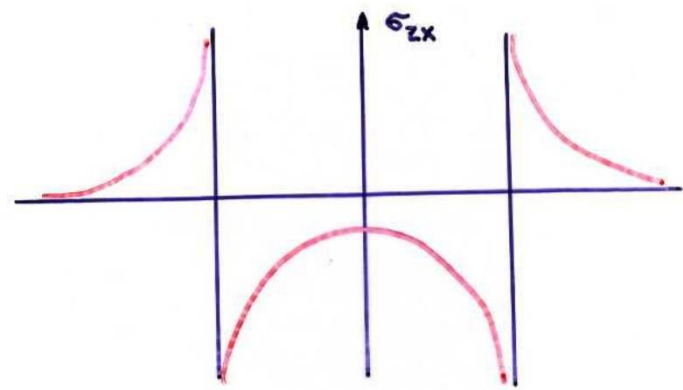

STRESS



Fisica Terrestre 2022-2023

Giovanni Costa

MODELLO DI FRATTURA CIRCOLARE MADARIAGA

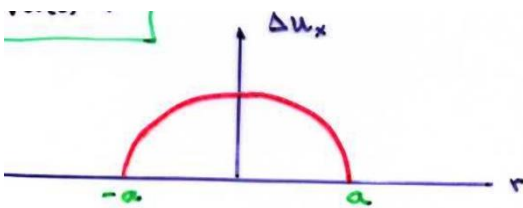
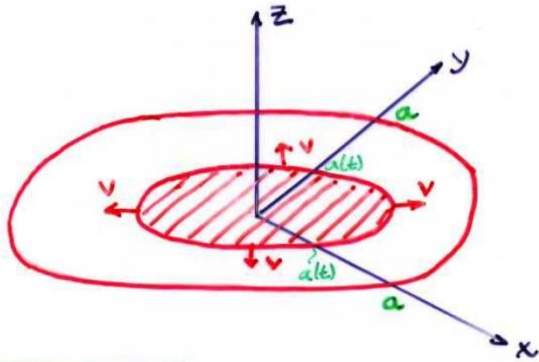

SLIP

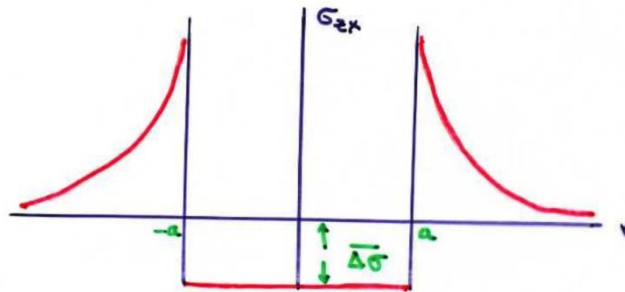

STRESS

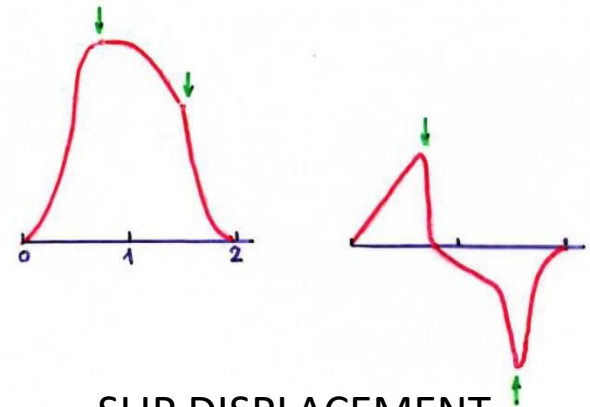

SLIP DISPLACEMENT
AND VELOCITY OF P
WAVES



Fisica Terrestre 2022-2023

Giovanni Costa

I modelli finora discussi non riescono a spiegare le osservazioni neanche nel campo lontano nel caso di grossi eventi ($M \approx 8$) e frequenze basse. Tantomeno riescono a spiegare la grande complessità osservata nei segnali ad alta frequenza (broadband, accelerogrammi) ottenuti vicino alla sorgente.

La complessità di tali segnali è pertanto da associare alle condizioni di eterogeneità della crosta (lungo la faglia).

La rottura della faglia non è liscia ed uniforme ma variabile ed eterogenea nello spazio. Porzioni di faglia che erano sottoposte a grandi sforzi prima del terremoto possono produrre grossi impulsi di radiazione, mentre altre parti della faglia offrono una resistenza molto grande in modo da fermare la rottura.

Pertanto alla fine degli anni '70 vennero proposti i seguenti modelli per spiegare le complessità osservate.

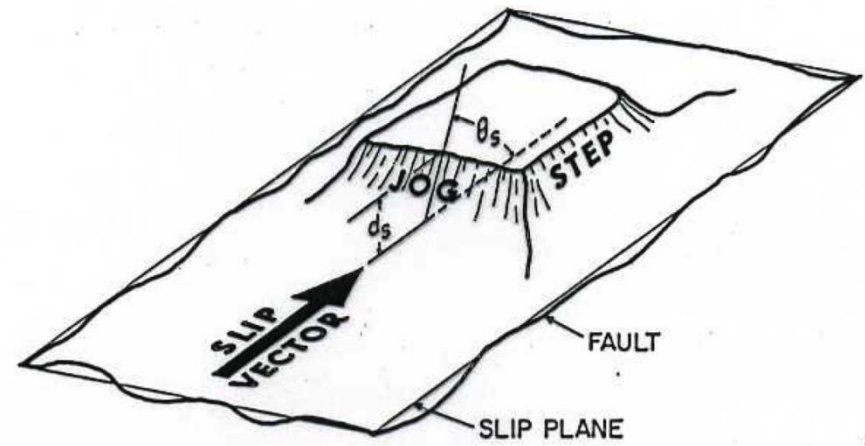

Fig. 3.28 Schematic diagram illustrating the definition of jogs and steps.

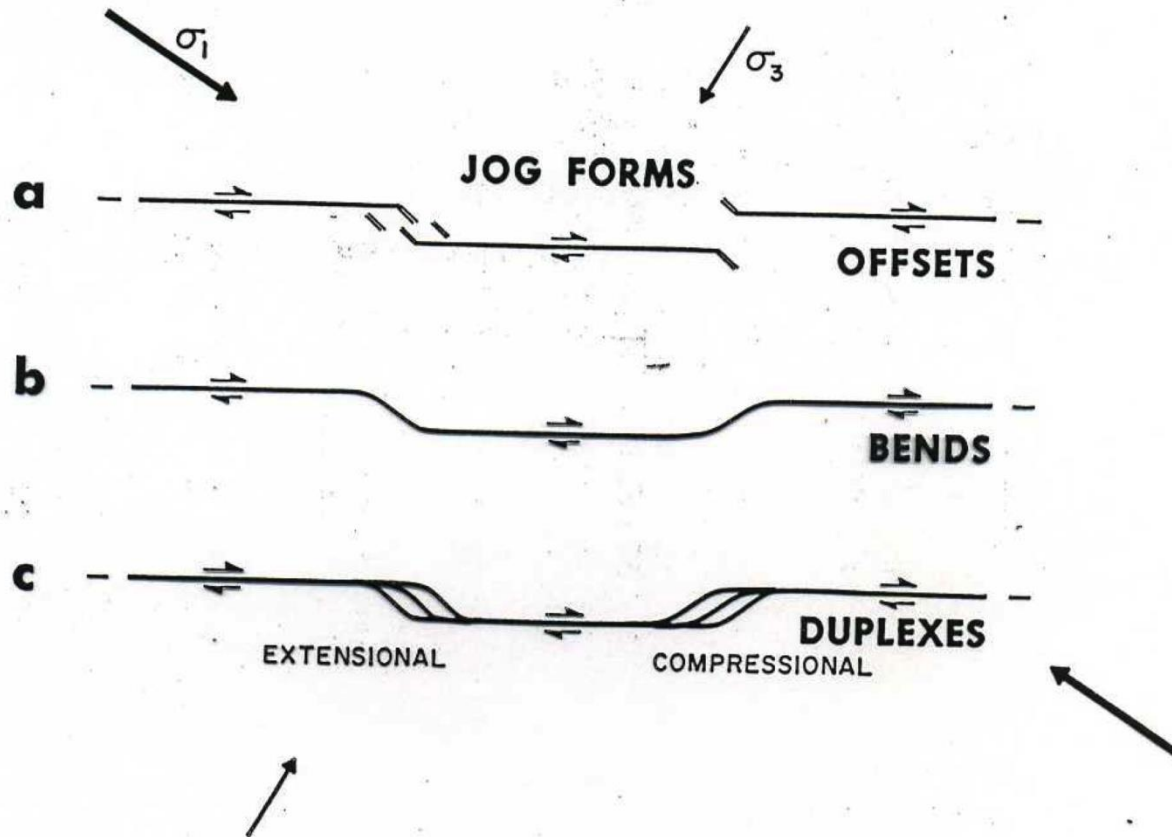

Fig. 3.29 Schematic diagram illustrating different types of stepover structures.

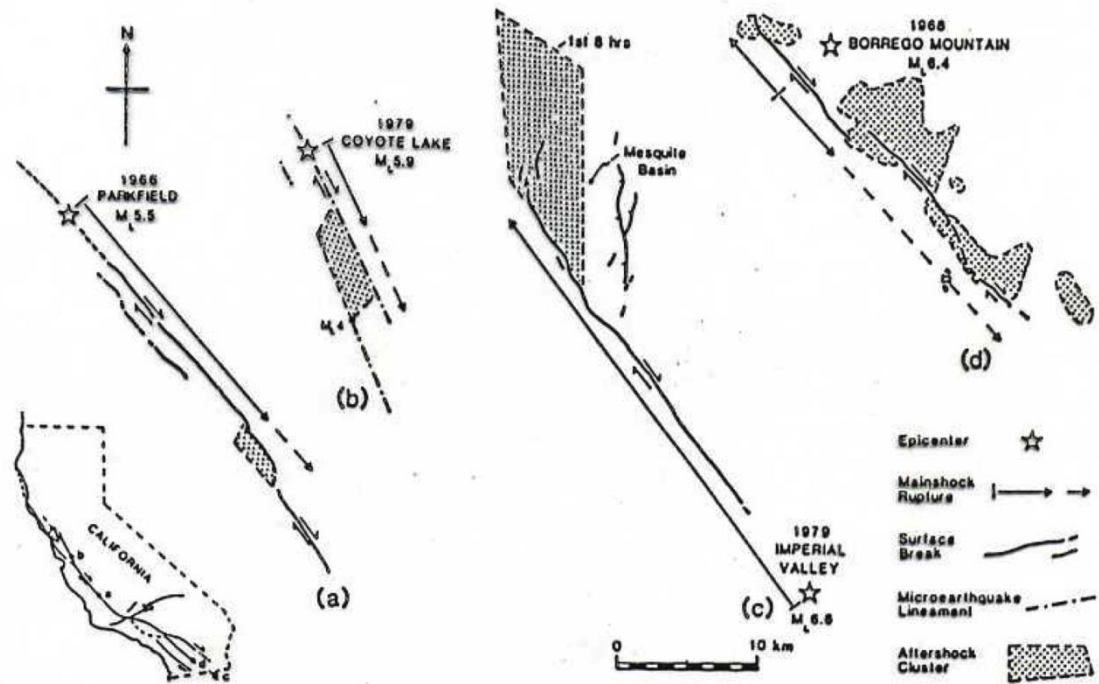
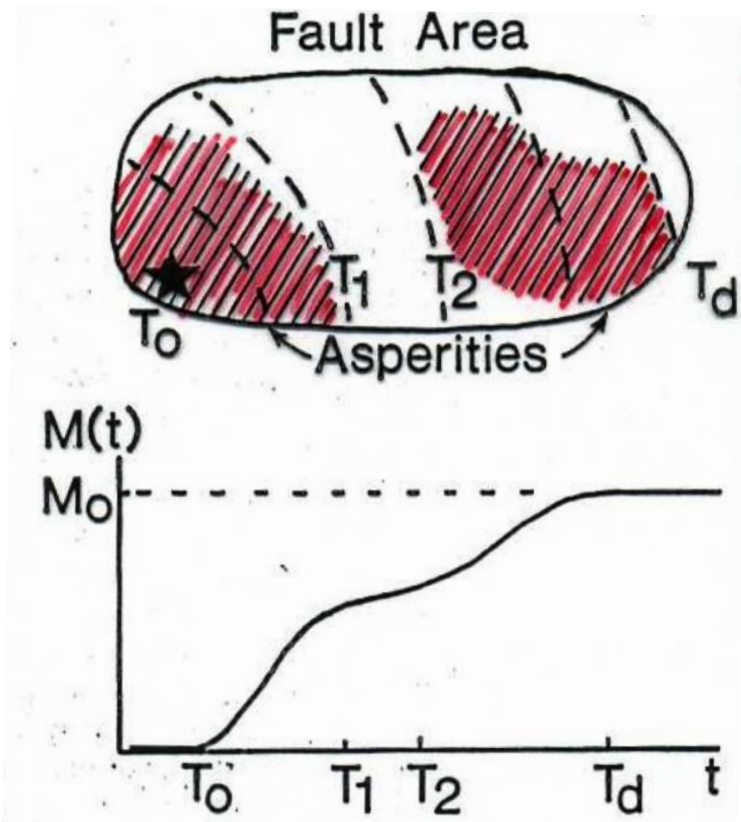

Fig. 3.33 Sketches showing ruptures terminated at jogs in the San Andreas fault zone: (a) Parkfield, 1966; (b) Coyote Lake, 1979; (c) Imperial Valley, 1979; (d) Borrego Mtn., 1968. (From Sibson, 1986c.)



Momento sismico rilasciato e funzione temporale della sorgente. “L’area di faglia” mostra una ipotetica storia di rottura dove il fronte di rottura inizia all’ipocentro (stella) ed attraversa l’area di faglia. Le linee tratteggiate indicano il fronte di rottura in tempi diversi. L’area di faglia è eterogenea, per esempio, ci sono due regioni con alto momento rilasciato: asperità. Nel plot di $M(t)$, il momento sismico si accumula fino a raggiungere il valore finale, M_0 , al tempo T_d .

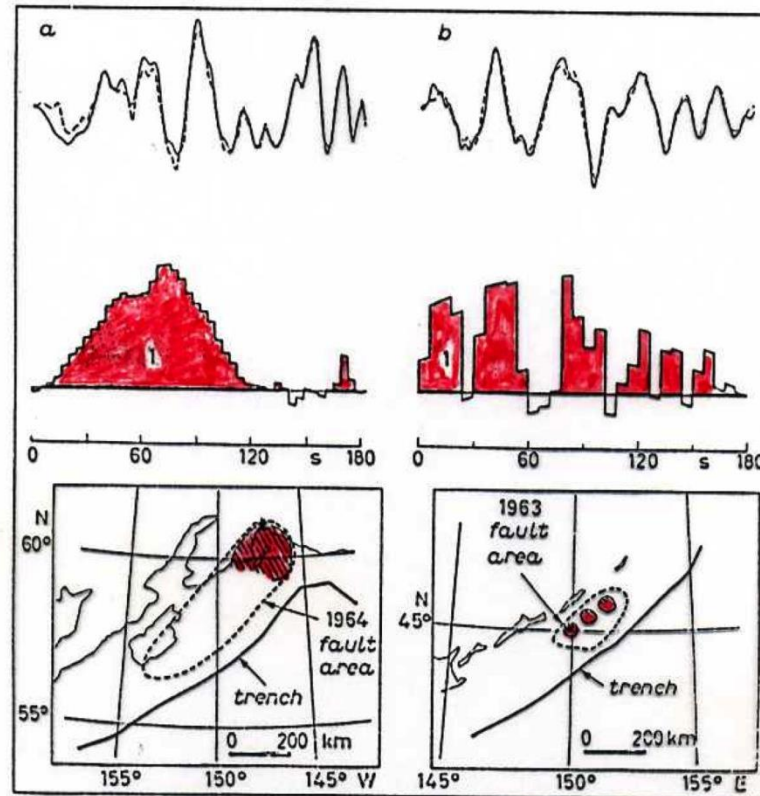

FIGURE 11.31 The source time functions for the 1964 Alaska and 1963 Kuril Islands earthquakes. Note the variation in temporal moment release, which is interpreted in terms of different fault zone stress heterogeneity, or asperities. (From Ruff, 1983.)



Fisica Terrestre 2022-2023

Giovanni Costa

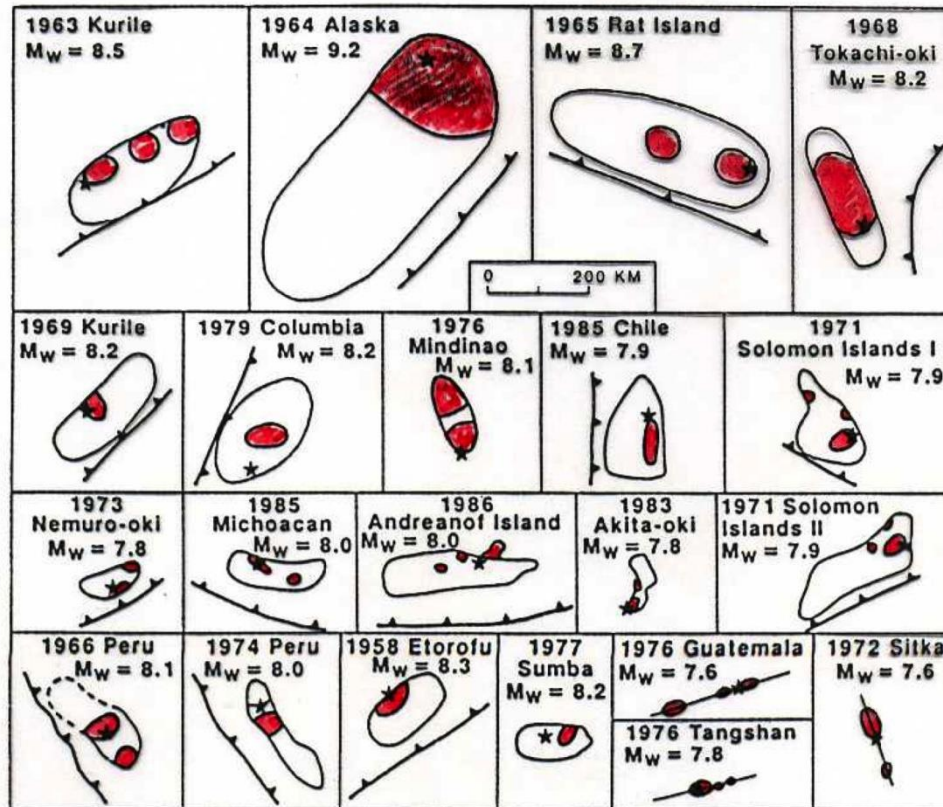
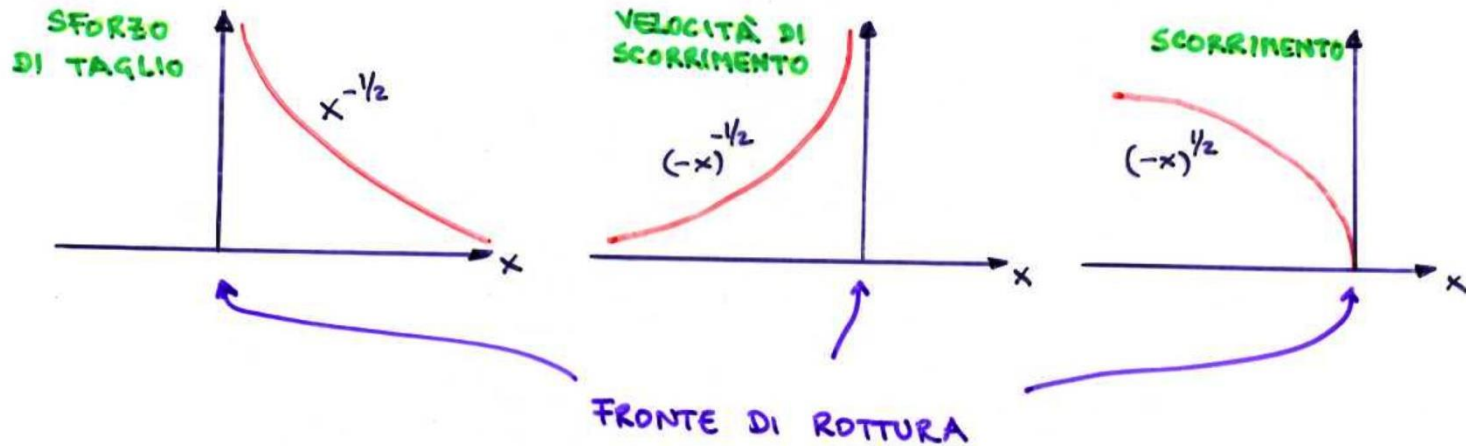

FIGURE 11.32 Schematic map-view summaries of aftershock zones (solid lines) and regions of high seismic moment release (stippled regions) inferred from seismic-wave analysis for 21 major earthquakes. Subduction zone events are shown with the nearby trench axis. (From Thatcher, *J. Geophys. Res.* **95**, 2609–2623, 1990; © copyright by the American Geophysical Union.)



Fisica Terrestre 2022-2023

Giovanni Costa



Poiché la radiazione delle onde sismiche è controllata dalla velocità di scorrimento ad essa risulta massima ai bordi della rottura. E' il fronte di rottura a produrre radiazioni ad alta frequenza il resto della faglia irradia le frequenze basse.



Fisica Terrestre 2022-2023

Giovanni Costa

MODELLO A BARRIERE (DAS e AKI, 1977)

La faglia è caratterizzata da **sforzi uniformi** lungo la sua estensione. I valori di **sforzo critico** (σ_y) risultano estremamente variabili. Le regioni ad alta resistenza costituiscono **barriere (B)** che impediscono la propagazione della rottura.

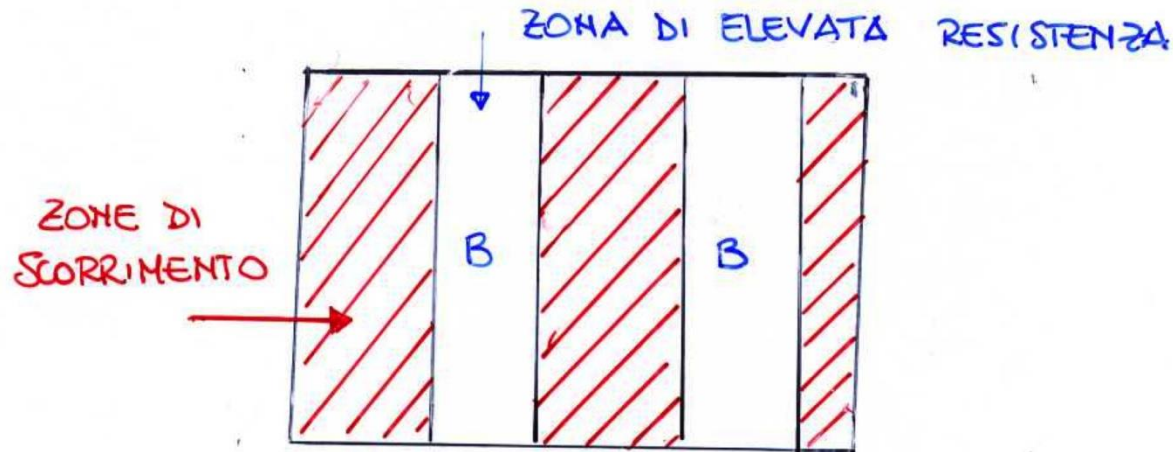



Fisica Terrestre 2022-2023

Giovanni Costa

MODELLO A BARRIERE (DAS e AKI, 1977)

Sforzi prima del terremoto

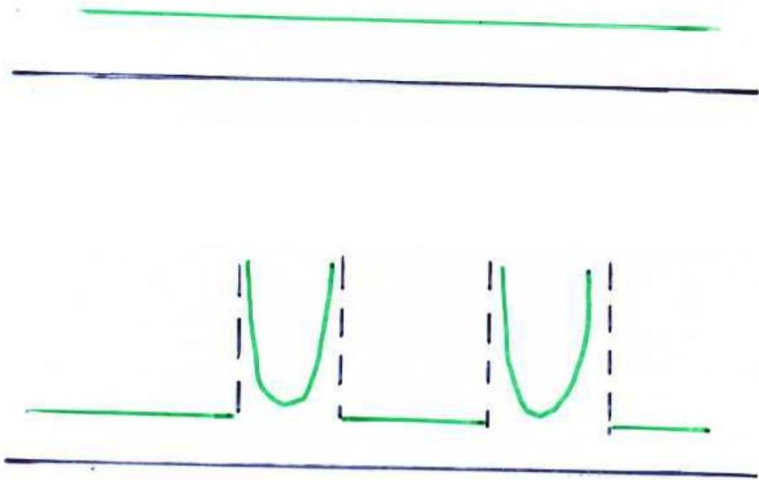

Distribuzione degli sforzi dopo il terremoto: la faglia è interessata da una distribuzione di sforzi eterogenea

SCORRIMENTO
SUL
PANO DI FAGLIA

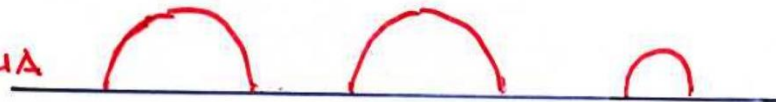



Fisica Terrestre 2022-2023

Giovanni Costa

MODELLO AD ASPERITA' (KANAMORI e STEWART, 1978)

Propone uno stato di **sforzi** estremamente variabile sull'intera area di faglia. Le zone sottoposte a sforzo elevato sono le **asperità** che, rompendosi, danno luogo ad un terremoto complesso. Alla fine della rottura gli sforzi sul piano di faglia sono omogenei.

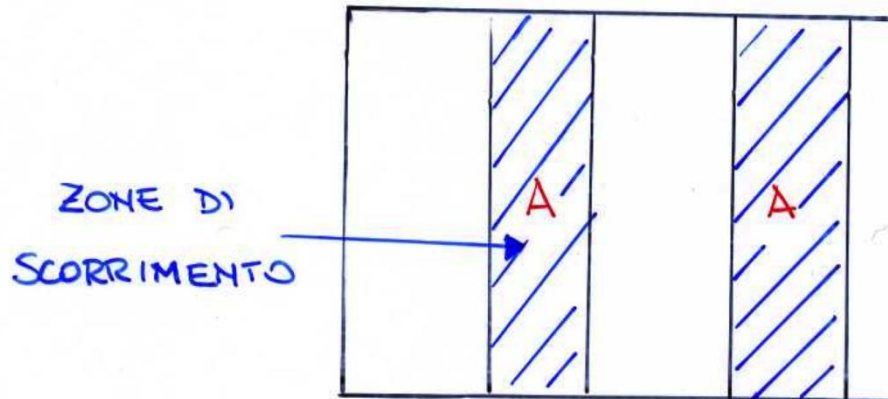



Fisica Terrestre 2022-2023

Giovanni Costa

MODELLO AD ASPERITA'
(KANAMORI e STEWART, 1978)

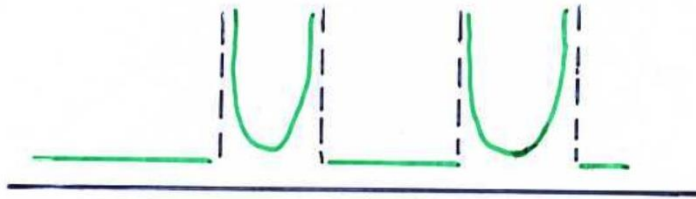

Sforzi prima del terremoto



Sforzi dopo la rottura

SCORRIMENTO
SUL PIANO
DI FAGLIA





Fisica Terrestre 2022-2023

Giovanni Costa

Rupture Time (seconds)

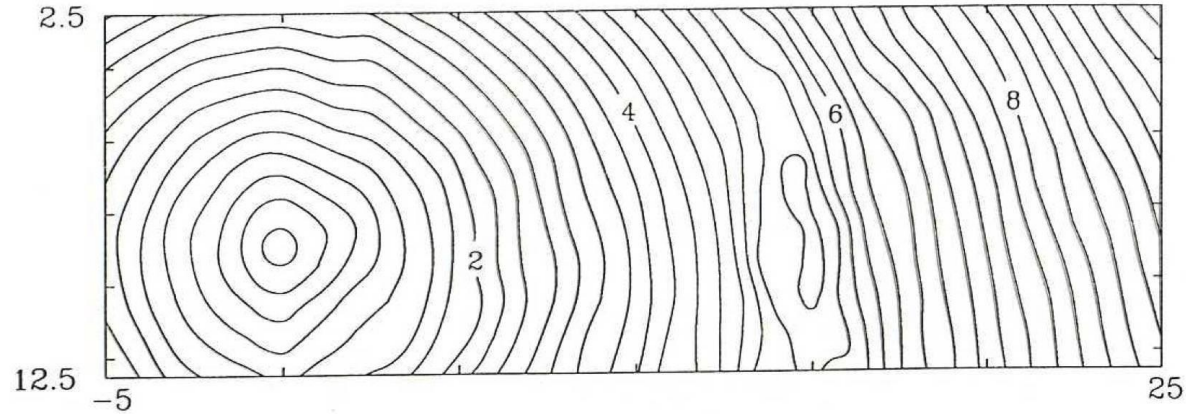

Slip Amplitude (cm)

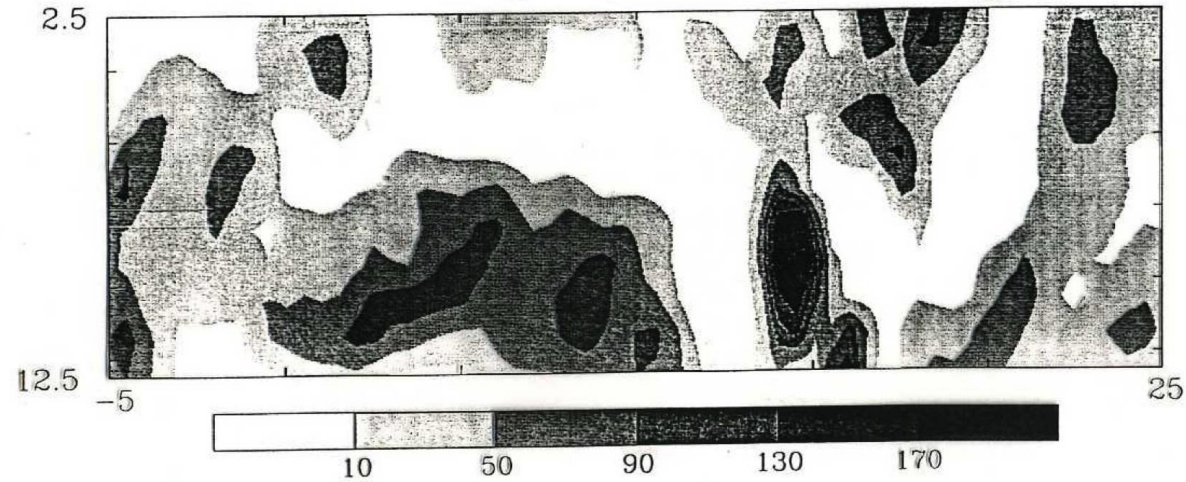



Fisica Terrestre 2022-2023

Giovanni Costa

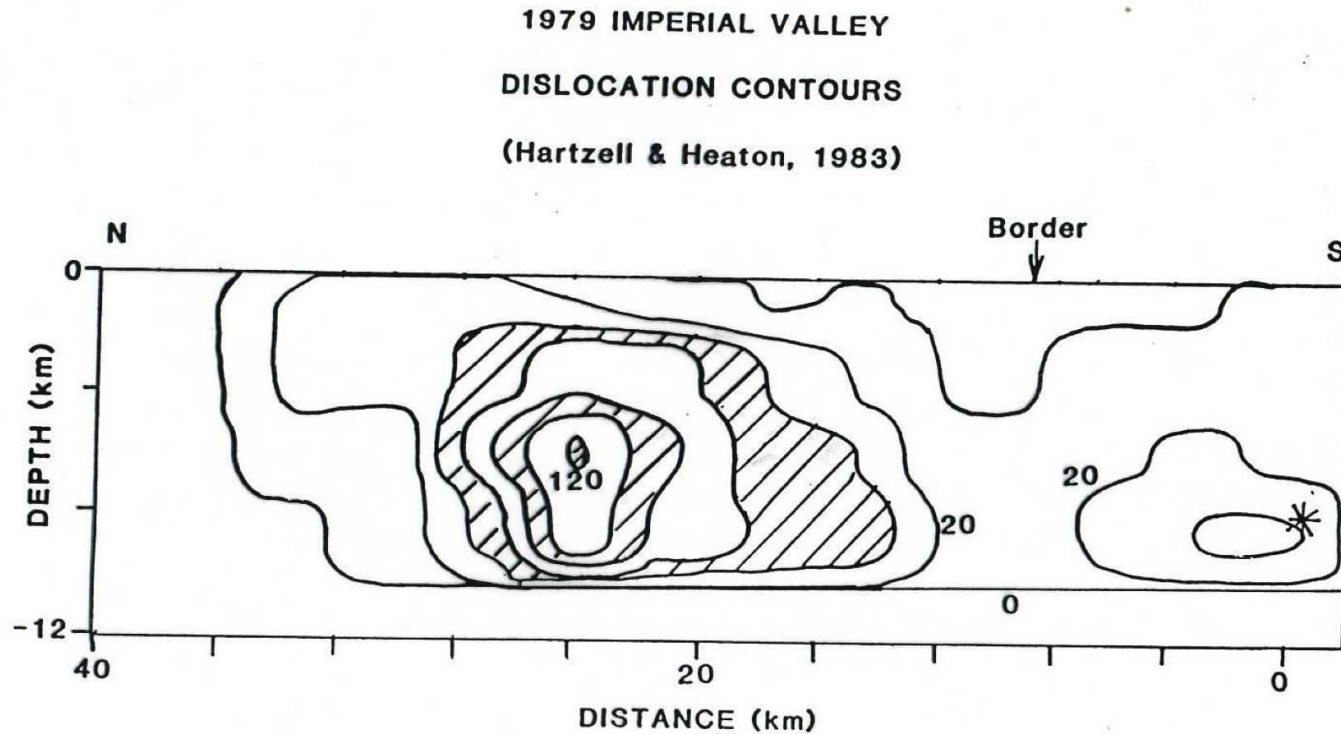
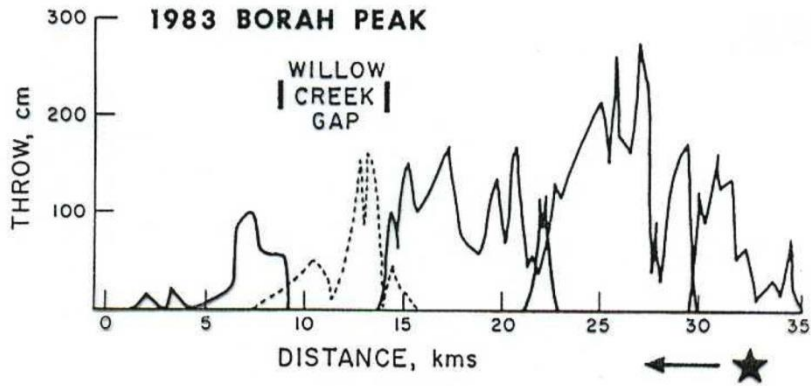

Figure 8. Slip distribution (cm) for 1979 Imperial Valley earthquake. Hypocenter shown by star. After Hartzell and Heaton, 1983.



Fisica Terrestre 2022-2023

Giovanni Costa



a

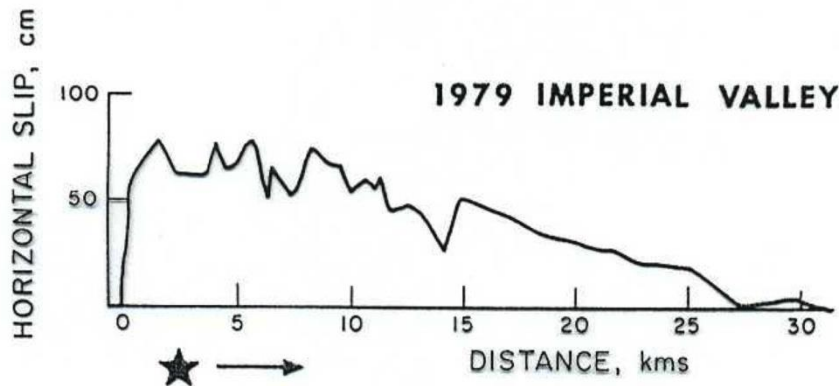

b

La distribuzione lungo lo strike dello scorrimento della superficie di due terremoti di lunghezza di faglia simile. (a) Borah Peak, Idaho, 1983: faglia normale. (b) Imperial Valley, California, 1979: faglia strike-slip. Dati da Sharp et al. (1982).