

Tentative plan a.a. 2021/22

Cell mechanics

Lecture 5

1. Introduction
2. Physical principles
3. Mechanics of motor proteins and cytoskeleton

4. Experimental techniques to study cell mechanics and mechanotransduction

5. Lab visit – experimental session

4. Experimental techniques to study cell mechanics and mechanotransduction

4.1. Cellular mechanotransduction (basic principles and examples)

4.2. An overview of experimental techniques to apply and measure forces

4.3. **Optical tweezers**, magnetic and acoustic tweezers

4.4. Super resolution optical microscopy techniques (STED, PALM)

Optical tweezers

- Optical trapping and manipulation principles: an homage to Arthur Ashkin
- Examples of OT applications in biophysics

Light – EM wave

$$\mathbf{S} = \mathbf{E} \times \mathbf{H}$$

Poynting vector

$$I = \langle S \rangle$$

Irradiance (W/m²) or Energy flux (J/s/m²)

$$P_{rad} = \frac{\langle S \rangle}{c} = \frac{I}{c}$$

Radiation pressure (Pa)

Light – particle / photon

$$p = \frac{h\nu}{c} = \frac{E_p}{c}$$

The momentum and the energy of a photon

$$I = \frac{N E_p}{A \Delta t}$$

Irradiance (W/m²)

$$P_{rad} = \frac{N F_p}{A} = \frac{N p}{A \Delta t} = \frac{N E_p}{A \Delta t c}$$

Pressure

$$P_{rad} = \frac{I}{c}$$

Radiation pressure – absorbed light (Pa)

Observation of the radiation pressure of light

1619 – Kepler :

suggests that the sun light drives the orientation of the comets tail

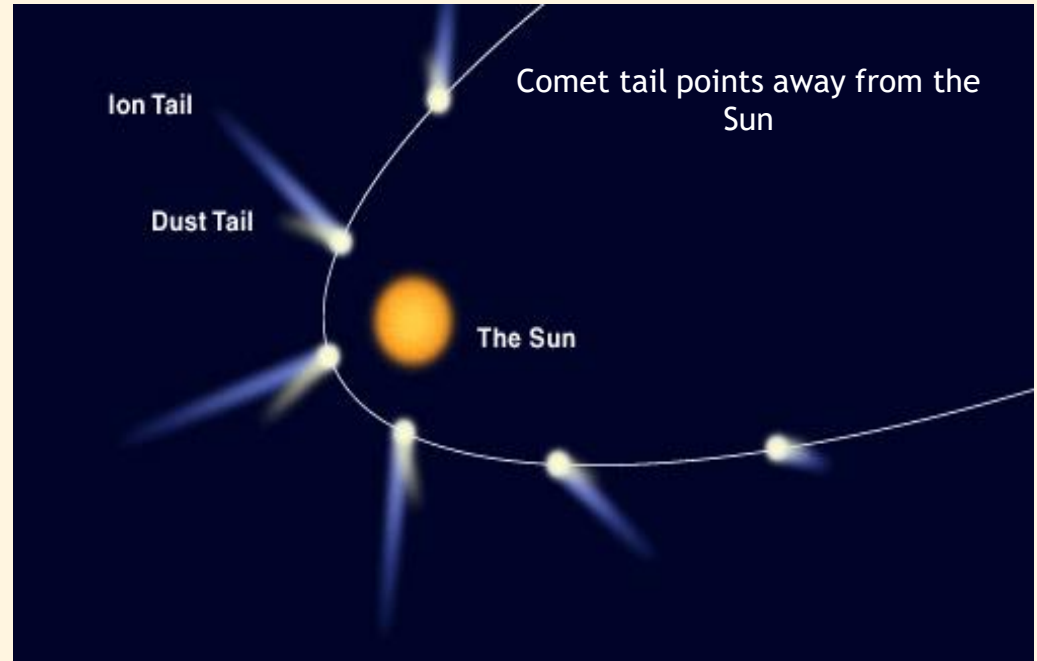

1873 – Maxwell :

“In a medium in which waves are propagated, there is a pressure in the direction normal to the waves and numerically equal to the energy in unit volume”

1900-1901 Lebedev, Nichols, Hull:

First measurement of the radiation pressure using a torsion balance

Forces generated by light on objects are in general very small and hence the effect is difficult to be detected

→ use LASER beam and SMALL objects !

Example:

How big is the force exerted by a ray of light reflected perfectly by a microbead ?

Geometrical optics approximation --> light rays

- reflection coefficient $R=1$
- (bead diam) $d > \lambda$ (light wavelength)
- $d = 2 \mu\text{m}$, $\lambda = 0.5 \mu\text{m}$

The magnitude of the momentum associated to the ray of light composed by N photons:

$$P = E / c = N h \nu / c$$

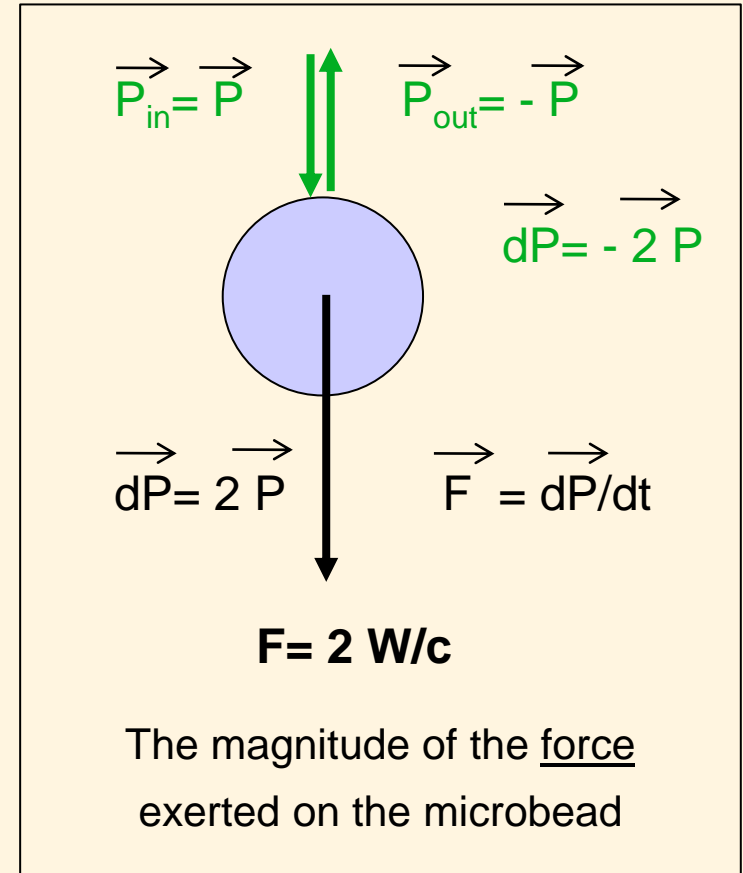

$N=1$ photon, $\rightarrow E \approx 2.5 \text{ eV}$, $W \approx 4 \times 10^{-19} \text{ W}$ $\rightarrow F \approx 2.7 \times 10^{-27} \text{ N}$ - very small

$N = 10^{15}$ photons, $W \approx 0.4 \text{ mW}$, $F \approx 2.7 \times 10^{-12} \text{ N} = 2.7 \text{ pN}$ - SMALL

1 pN is the gravitational force of a particle with a mass of 0.1 ng (10^{-10} grams) !

Is the magnitude of this force significant ?

1)

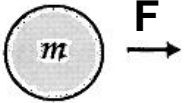

Microbead in free space (vacuum) - no dumping:

$F \approx 2.7 \text{ pN}$ - **SMALL** , but also the mass, m , of the microbead is small

$m \approx 8 \text{ pg}$ \rightarrow acceleration $a \approx F/m = 3.4 \times 10^2 \text{ [m/s}^2\text{]} = 34 \text{ g}$,

which is very **BIG** !

2)

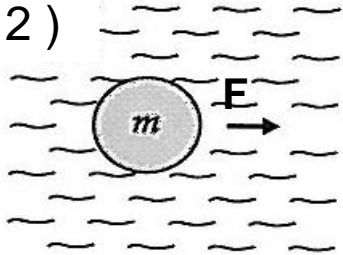

Microbead in liquid - damping:

$F \approx 3.6 \text{ pN}$

refractive index (water) $n_m = 1.33$; force by light : $F = 2 n_m W/c$;

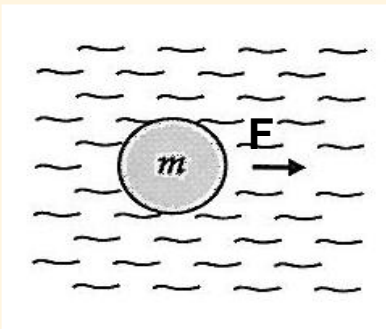

Microbead in liquid - dumping:

$F \approx 3.6 \text{ pN}$

refractive index (water) $n_m = 1.33$; force by light : $F = 2 n_m W/c$;

mass + dashpot model

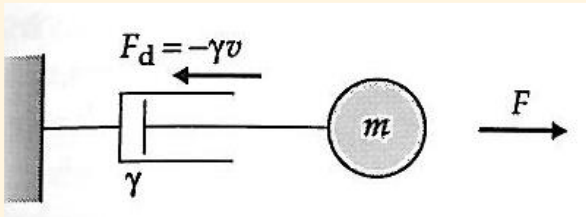

$$m \frac{dv}{dt} = F - \gamma v$$

$$v(t) = \frac{F}{\gamma} \left[1 - \exp\left(-\frac{t}{\tau}\right) \right]$$

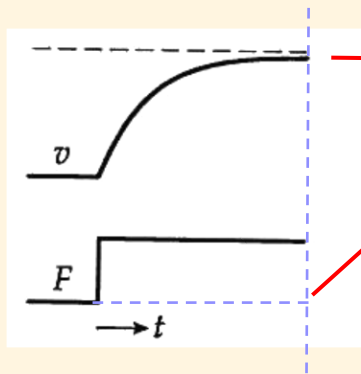

max velocity $v_t = \frac{F}{\gamma} = 360 \text{ } \mu\text{m / s}$

time constant $\tau = \frac{m}{\gamma} = 0.8 \text{ } \mu\text{s}$

- the max velocity is reached very fast and maintained until the force F is applied.
- When the force is cancelled the particle stops very fast.

For a small particle dumping is dominant over inertia because: $m \rightarrow d^3$, $\gamma \rightarrow d$

Mie scattering pattern

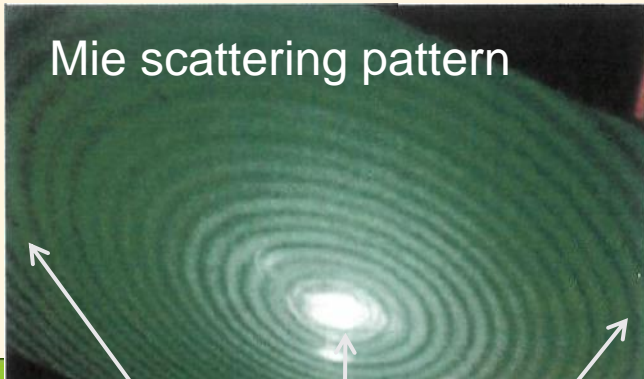

Optical Trapping and Manipulation of
Neutral Particles
Using Lasers

A Reprint Volume
with Commentaries

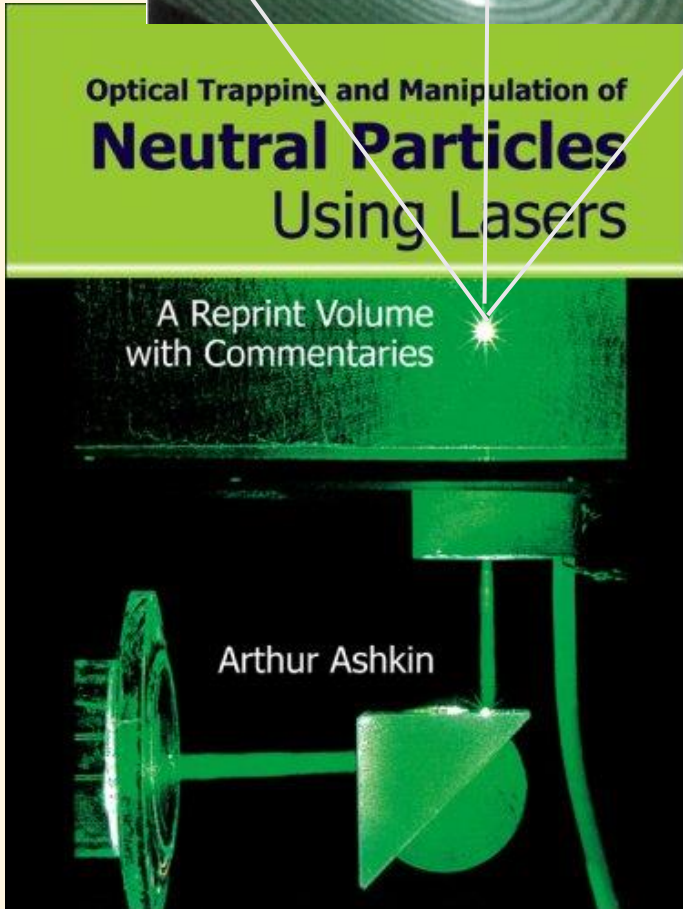

Arthur Ashkin

Scientific Publishing 2006

Arthur Ashkin, Bell Labs (1986)

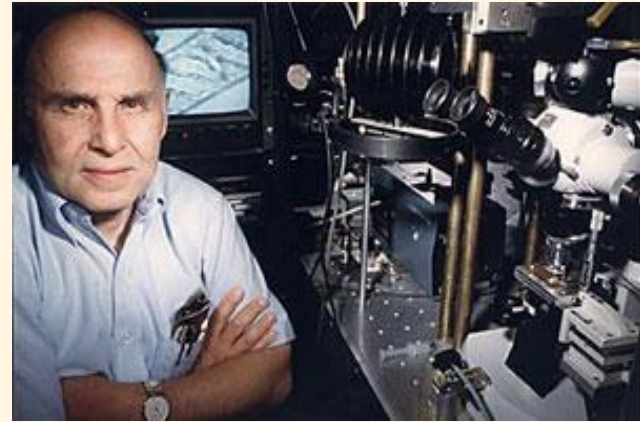

Optical levitation of microparticles in air

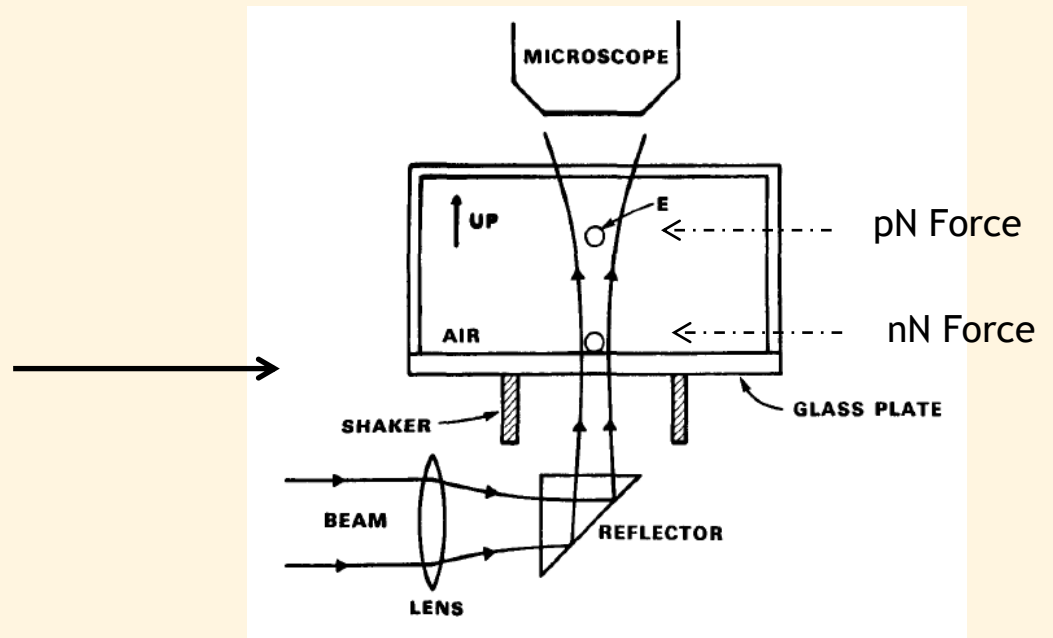

(hollow silica, beads, diam 50-75 μm)

Force induced by a ray of light by **refraction** on a bead in water

reflection only
R=1

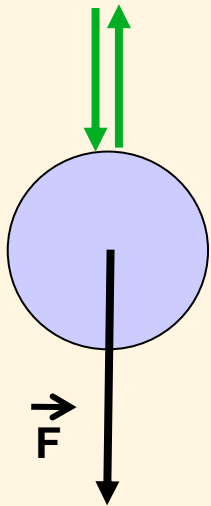

refraction only,
R=0; $n_b > n_m$

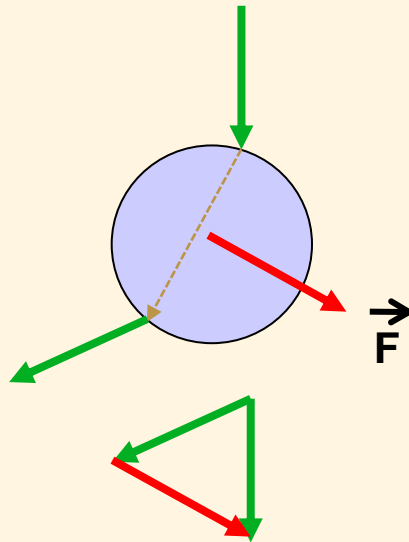

The magnitude of the force:

$$F = Q n_m W_{in} / c$$

the incident momentum /s
of a ray of power W_{in}

Q - dimensionless factor, $Q \leq 2$
Q - function of shape, material

Considering the photon flux
impinging on and leaving the sample,
and the conservation of momentum

$$\bar{F} = \frac{n}{c} \iint (S_{in} - S_{out}) \cdot dA$$

Simplified ray optics diagrams of the scattering force and gradient force components of the radiation force on a dielectric Mie particle ($d > \lambda$)

Uniform Intensity

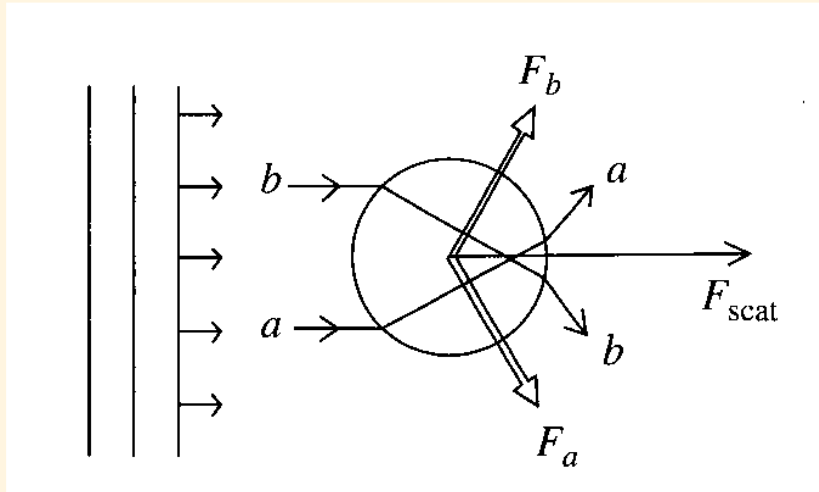

Plane wave

high index particle $n_p > n_m$

Origin of the scattering force - \mathbf{F}_{scat}

in the direction of the intensity of the incident plane wave beam

A. Ashkin, *Biophys. J.* 611, 569 (1992)

Forces of a single-beam gradient laser trap on a dielectric sphere in the ray optics regime

Ashkin 1970 -> Ashkin Book (2006)

Scattering and gradient forces

Gaussian Intensity

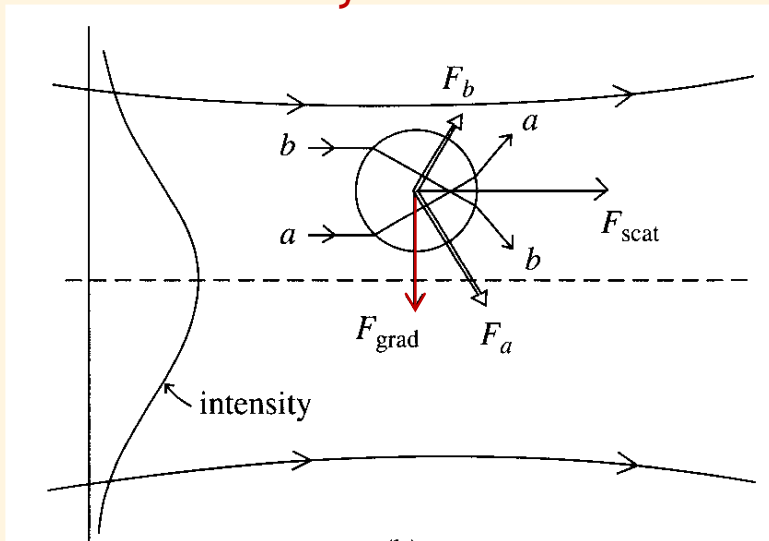

high index particle $n_p > n_m$

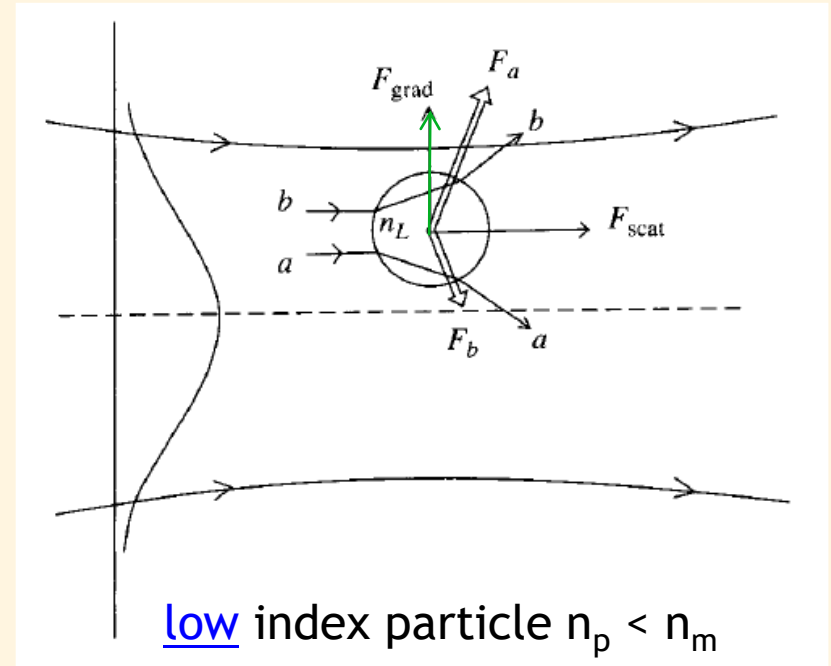

low index particle $n_p < n_m$

mildly focused Gaussian wave beam

Moderate Intensity GRADIENT

Origin of the transverse gradient force component - \mathbf{F}_{grad}
for a particle located off-axis

Midly focused laser beams (low NA lens)

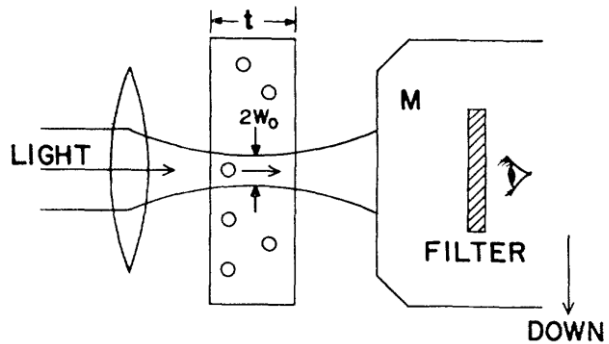

2D trapping

Single laser beam focused through a lens with low NA

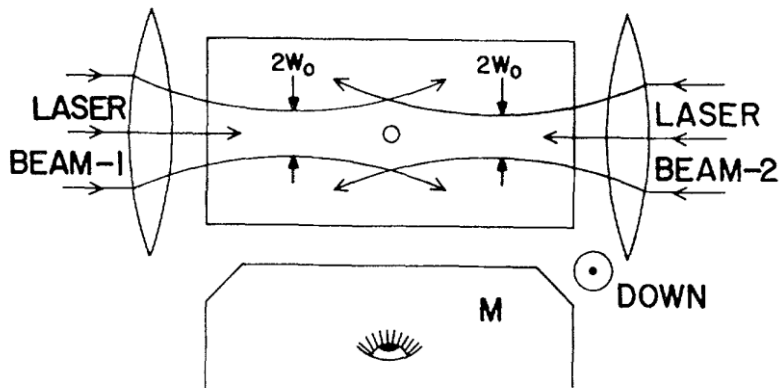

3D trapping

Counter propagating laser beams

Seminal PAPER for OT

Experimental results: dielectric microparticles in water and water droplets in air

It is hypothesized that similar acceleration and trapping are possible with atoms and molecules using light tuned to specific transitions.

Nevertheless, Ashkin had some problems to publish the paper

The Bell Labs Internal reviewer gave a negative evaluation, made of four points:

1. *there is no new physics here*
2. *the reviewer could not actually find anything wrong with this work*
3. *the work could probably be published somewhere*
4. *but not in Phys. Rev. Lett.* 😊😊😊

Fortunately, Ashkin had no publishing problem with the Phys Rev Lett.

From this story, we have at least two lessons to take home:

1. If you write a paper and you are convinced about its value do not give up even if the review is negative
2. When you review a paper, do not be superficial and pay attention to its originality and possible impact in the field.

Dual Laser Optical Tweezers DLOT

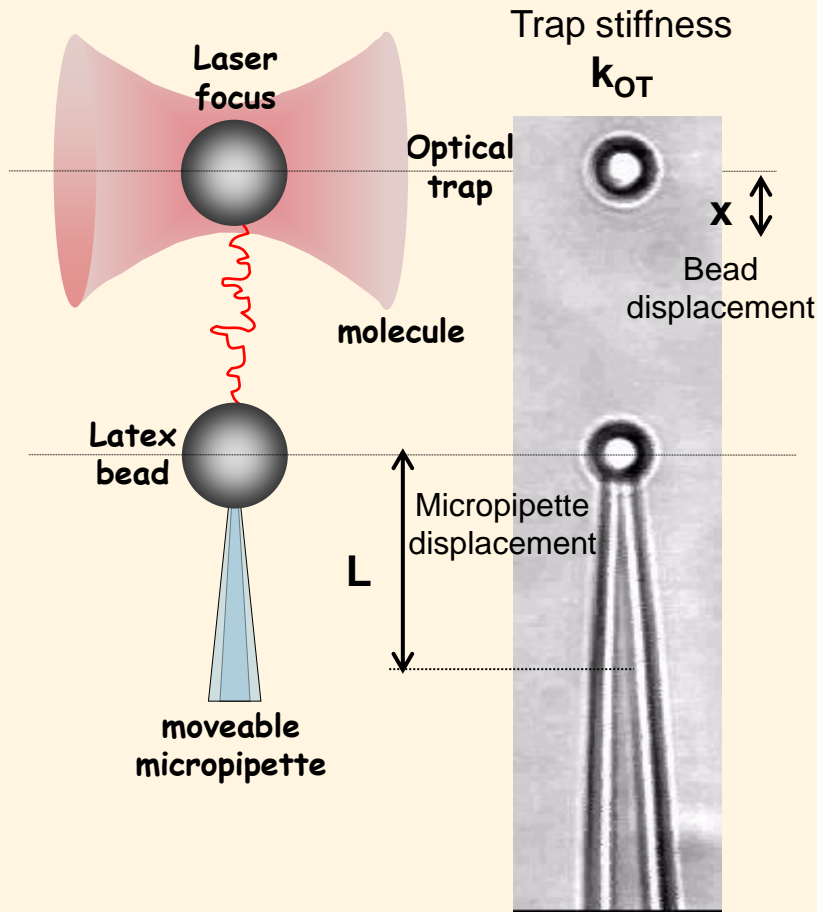

Counterpropagating beams + detection

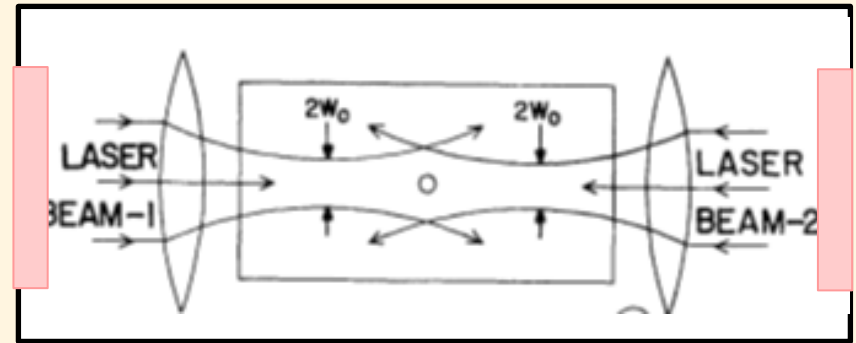

stretching λ -phage DNA

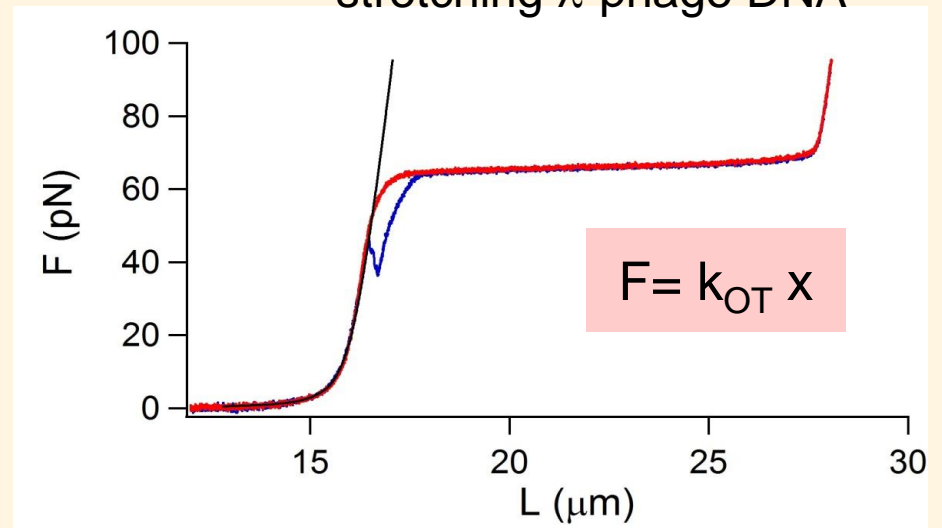

The DNA molecule undergoes a structural change at ~ 65 pN that implies 70% elongation and is likely involved in the modulation of the access to genetic information

collab with V. Lombardi, P. Bianco, Florence Univ.

Observation of a single-beam gradient force optical trap for dielectric particles

A. Ashkin, J. M. Dziedzic, J. E. Bjorkholm, and S. Chu, *Opt.Lett.* 11, 288 (1986)

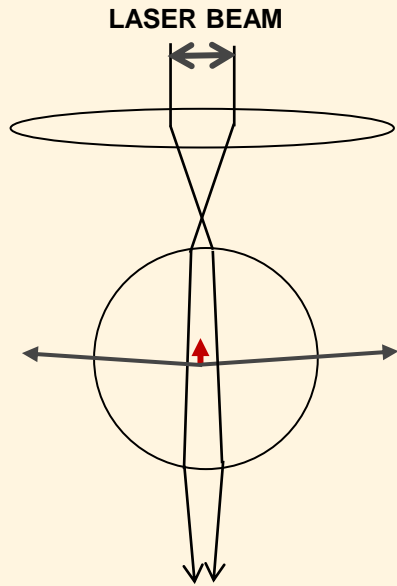

Force generated by **refraction** of a **midly** focused laser beam on a transparent microparticle in water.

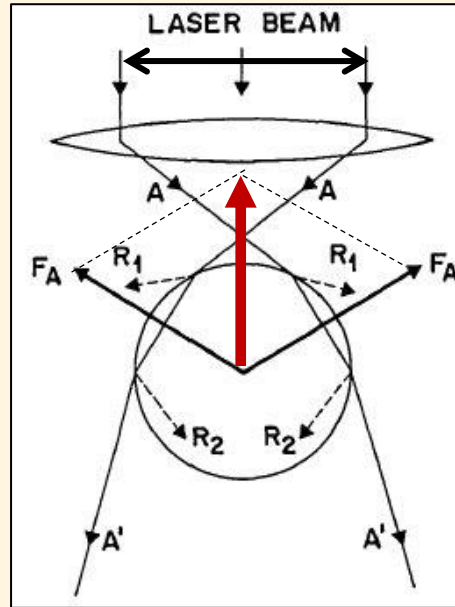

Force generated by a **tightly** focused laser beam.

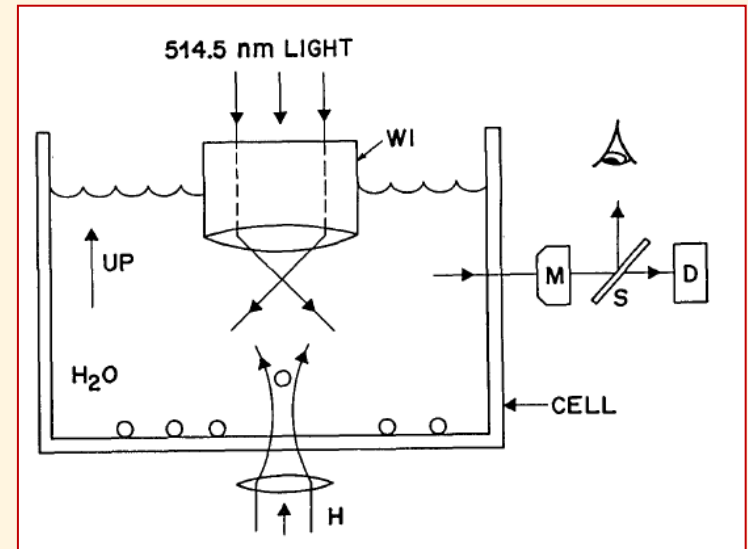

Sketch of the basic apparatus.
Size of particles :
10 μm (Mie) to 25 nm (Rayleigh)

Acceleration and trapping of particles by radiation pressure

A. Ashkin, *Phys. Rev. Lett.* 24, 156 (1970)

Observation of a single-beam gradient force optical trap for dielectric particles

A. Ashkin, J. M. Dziedzic, J. E. Bjorkholm, and S. Chu, *Opt.Lett.* 11, 288 (1986)

Forces on submicrometric Rayleigh particles:

Gradient Force

$$\vec{F}_{grad} = -\nabla U = -p\nabla\vec{E} = -\alpha(E \cdot \nabla)\vec{E}$$

$$U = -\vec{p} \cdot \vec{E}$$

$$F_{grad} = -\frac{n_b}{2} \alpha \nabla E^2 = -\frac{n_b^3 r^3}{2} \left(\frac{m^2 - 1}{m^2 + 2} \right) \nabla E^2$$

p - polarization vector,
α - polarizability
E - optical electric field

Scattering Force

$$F_{scat} = P_{scat}/c$$

I_0 – incident beam intensity
r – particle radius

$$F_{scat} = \frac{I_0}{c} \frac{128\pi^5 r^6}{3\lambda^4} \left(\frac{m^2 - 1}{m^2 + 2} \right)^2 n_b$$

Conditions for trapping stability

axial stability

$$R = \frac{F_{grad}}{F_{scat}} = \frac{3\sqrt{3}}{64\pi^5} \frac{n_b^2}{\left(\frac{m^2 - 1}{m^2 + 2} \right)} \frac{\lambda^5}{r^3 \omega_0^2} \geq 1$$

transverse
stability

$$\exp(-U/kT) \ll 1 \leftrightarrow U > 10kT,$$

where $U = n_b \alpha E^2 / 2$ is the potential of the gradient force

the time to pull a particle into the trap should be less than

the time for the particle to diffuse out of the trap by Brownian motion

Size of particles that
can be trapped
(polystyrene latex):
14 nm (theory)
25 nm (experimental)

What is an Optical / Laser Tweezers ? (in practice)

A laser beam **tightly** focused through a high Numerical Aperture (NA) objective

A. Ashkin *et al* *Opt. Lett.* 1986

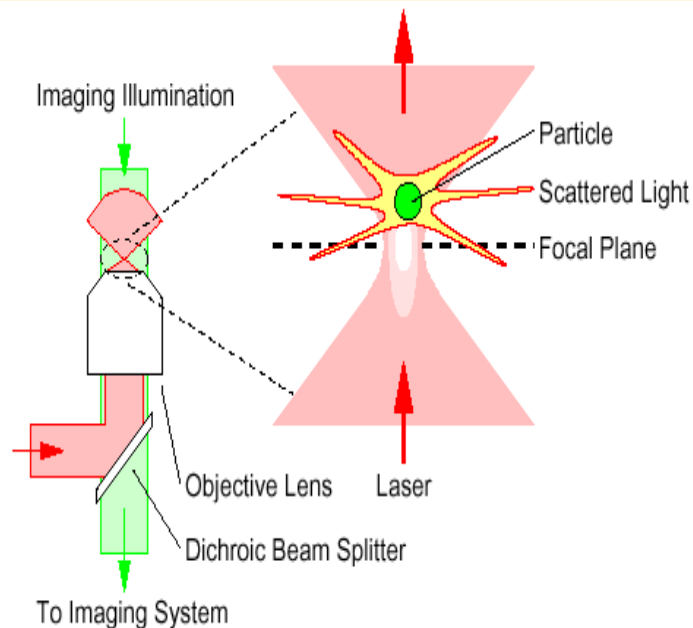

$$F = Q \frac{n_m W}{c}$$

Ex: **F= 1.33 pN** for
 $W = 1 \text{ mW}$, $n_m = 1.33$, $Q = 0.3$

F – trapping force

Q – dimensionless efficiency coefficient

W – power of the laser beam

n_m – refractive index of the medium

c – light speed in vacuum

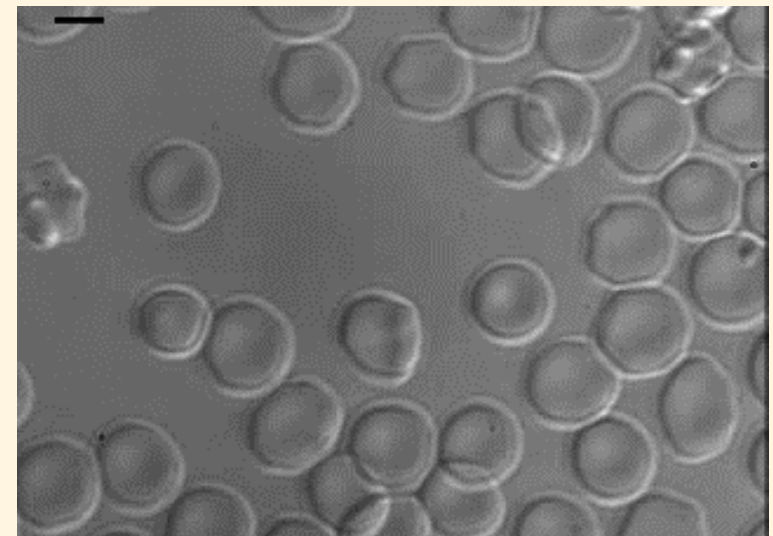
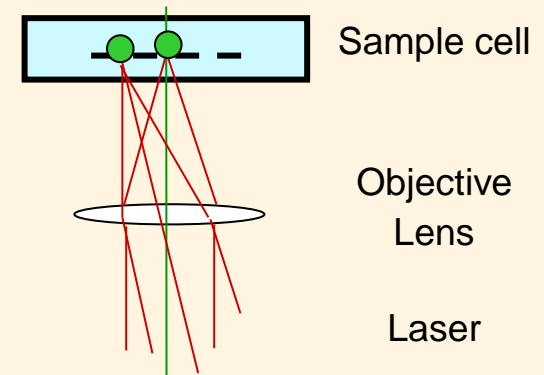

Example of human erythrocyte trapping
 2004 - OM Lab

Examples of trapping

IR OT tweezers @ 970 nm

silica microbeads

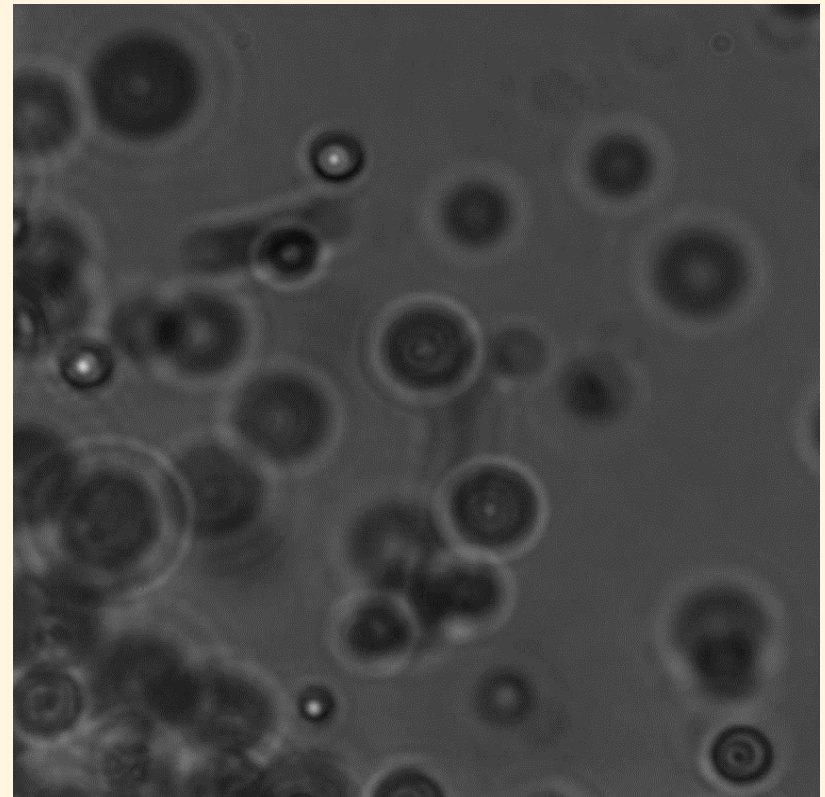
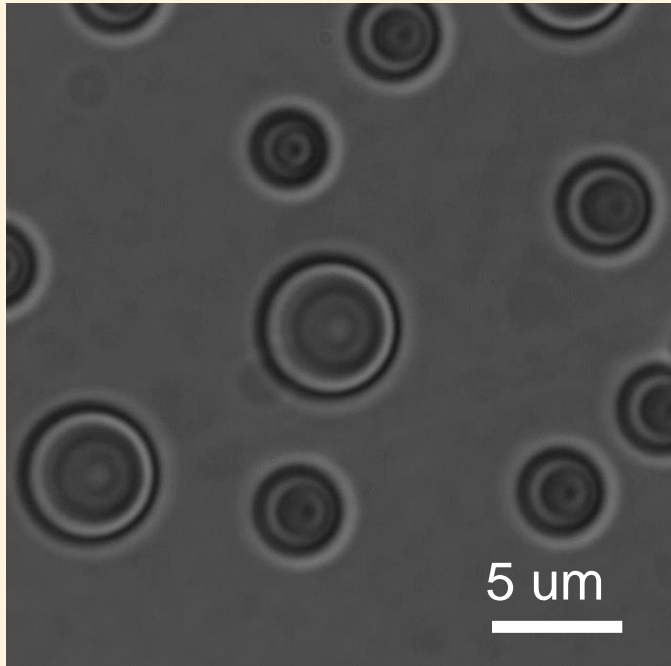

Power at the sample plane

$P = 5 \text{ mW}$

$P = 120 \text{ mW}$

**Why it took 16 years (1970-1986)
to get to the single beam 3D trapping ?**

PRL 24 156 1970

ACCELERATION AND TRAPPING OF PARTICLES BY RADIATION PRESSURE

A. Ashkin

Bell Telephone Laboratories, Holmdel, New Jersey 07733

(Received 3 December 1969)

Opt.Lett. 11 288 1986

Observation of a single-beam gradient force optical trap for dielectric particles

A. Ashkin, J. M. Dziedzic, J. E. Bjorkholm, and Steven Chu

AT&T Bell Laboratories, Holmdel, New Jersey 07733

Received December 23, 1985; accepted March 4, 1986

PRL 57 314 1986

Experimental Observation of Optically Trapped Atoms

Steven Chu, J. E. Bjorkholm, A. Ashkin, and A. Cable

AT&T Bell Laboratories, Holmdel, New Jersey 07733

(Received 14 April 1986)

Atom cooling -- > optical molasses

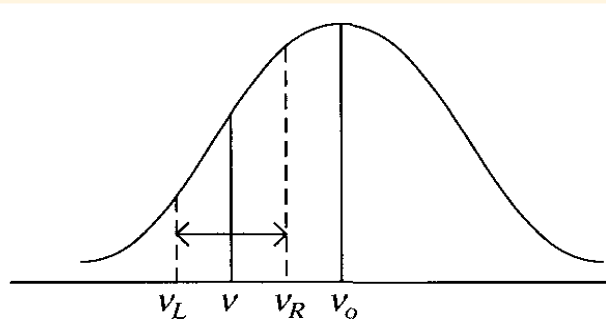

$$\nu < \nu_o$$

$$F = -\gamma v$$

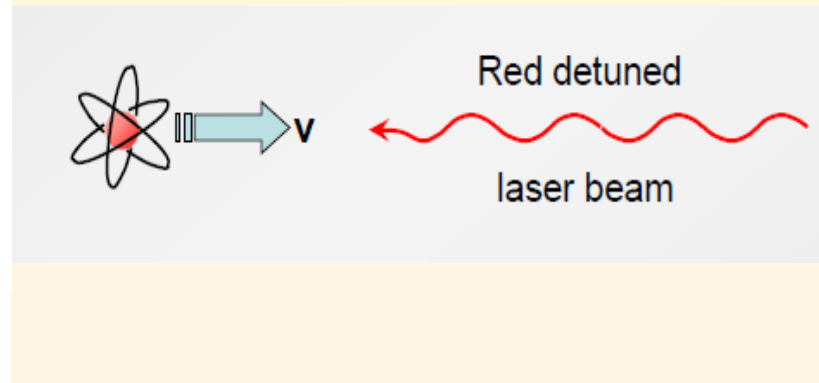

- Neutral atom travels with velocity \mathbf{v} to the right, laser beam propagates to the left
- Laser frequency ν is slightly lower than the electronic transition in the atom \rightarrow resonant interaction with atom
- Doppler effect \rightarrow red detuned laser to $\nu_R \rightarrow$ interaction / absorption increases
- The atom velocity is reduced when a photon is absorbed
- Emission is randomly distributed as direction and hence the effect in terms of momentum change for the atom is cancelled.
- If the absorption and emission are repeated many times, the average speed (and therefore the kinetic energy) of the atom will be reduced.

1D direction optical molasses

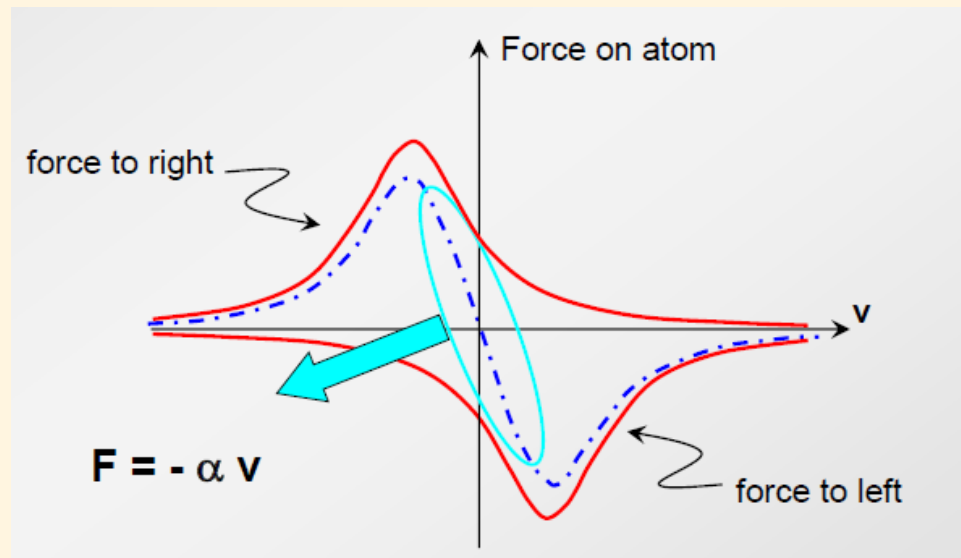
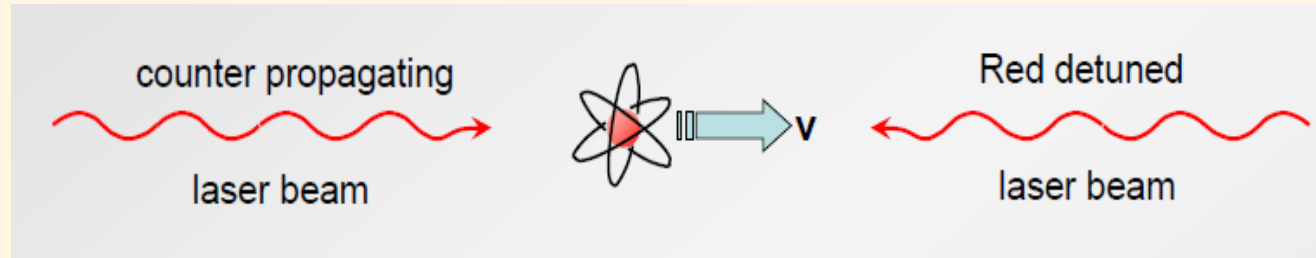

3D direction optical molasses – slow down the atoms / laser cooling

Doppler limit: $T = h\nu / K_B \sim 10^{-4}$ K

3D direction optical molasses + MOT

Magneto-optical trapping (MOT)

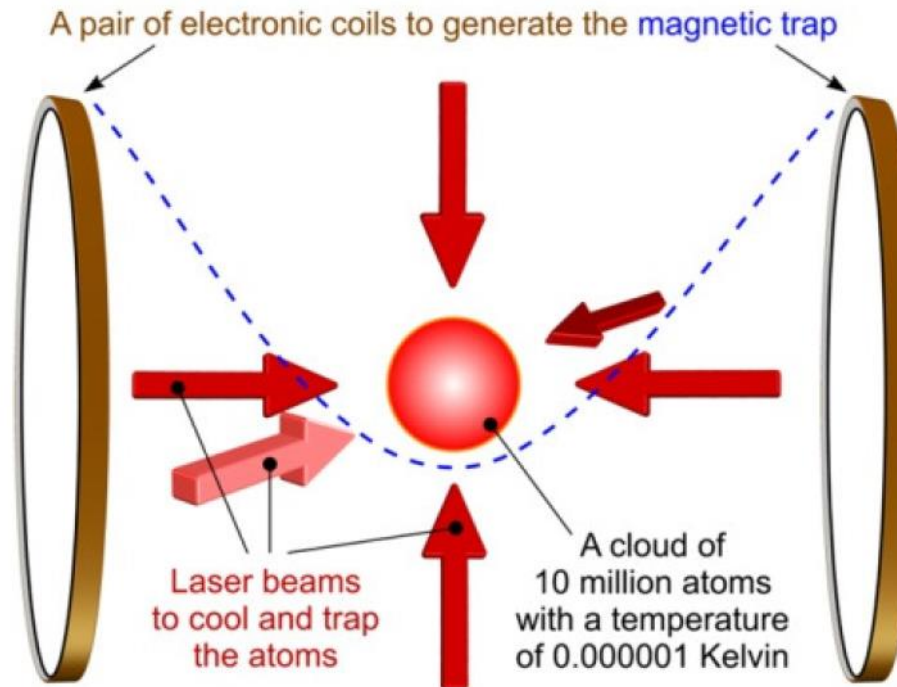

$$T = 10^{-6} \text{ K}$$

Two important pieces of science of atom cooling and trapping

VOLUME 57, NUMBER 3

PHYSICAL REVIEW LETTERS

21 JULY 1986

Experimental Observation of Optically Trapped Atoms

Steven Chu, J. E. Bjorkholm, A. Ashkin, and A. Cable
AT&T Bell Laboratories, Holmdel, New Jersey 07733

Volume 13, number 1

OPTICS COMMUNICATIONS

January 1975

COOLING OF GASES BY LASER RADIATION^{1*}

T.W. HÄNSCH^{2†} and A.L. SCHAWLOW

Department of Physics, Stanford University, Stanford, California 94305, USA

Two Nobel Prizes in Physics



The Nobel Prize in Physics 1997 was awarded jointly to Steven **Chu**, Claude **Cohen-Tannoudji** and William D. **Phillips** "for development of methods to cool and trap atoms with laser light."

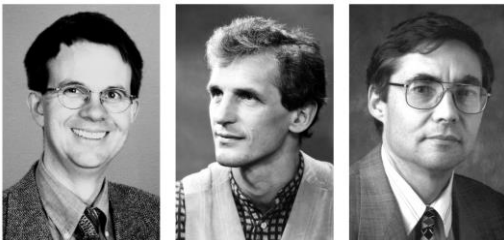

The Nobel Prize in Physics 2001 was awarded jointly to Eric A. **Cornell**, Wolfgang **Ketterle** and Carl E. **Wieman** "for the achievement of Bose-Einstein condensation in dilute gases of alkali atoms, and for early fundamental studies of the properties of the condensates."

Trapping biological samples

Are there sensitive issues when using optical tweezers to trap biological particles ?

1. The intensity at the trapping position (focal plane) is very high !
Absorption of light by different components of a biological sample is wavelength dependent !

Is the laser beam damaging the sample ?

If yes, which is the level of damage ?

2. Biological samples (e.g. viruses, bacteria, cells) have arbitrary shapes while the laser beam is symmetric.

Does this mismatch prevent trapping ?

First optical trapping of a biological sample

Tobacco Mosaic Virus (TMV) and *E. Coli*

TMV
shape & size

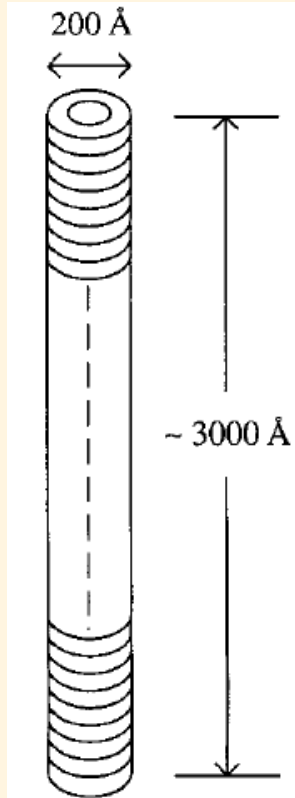

Apparatus used for optical trapping of TMV particles
and mobile bacteria

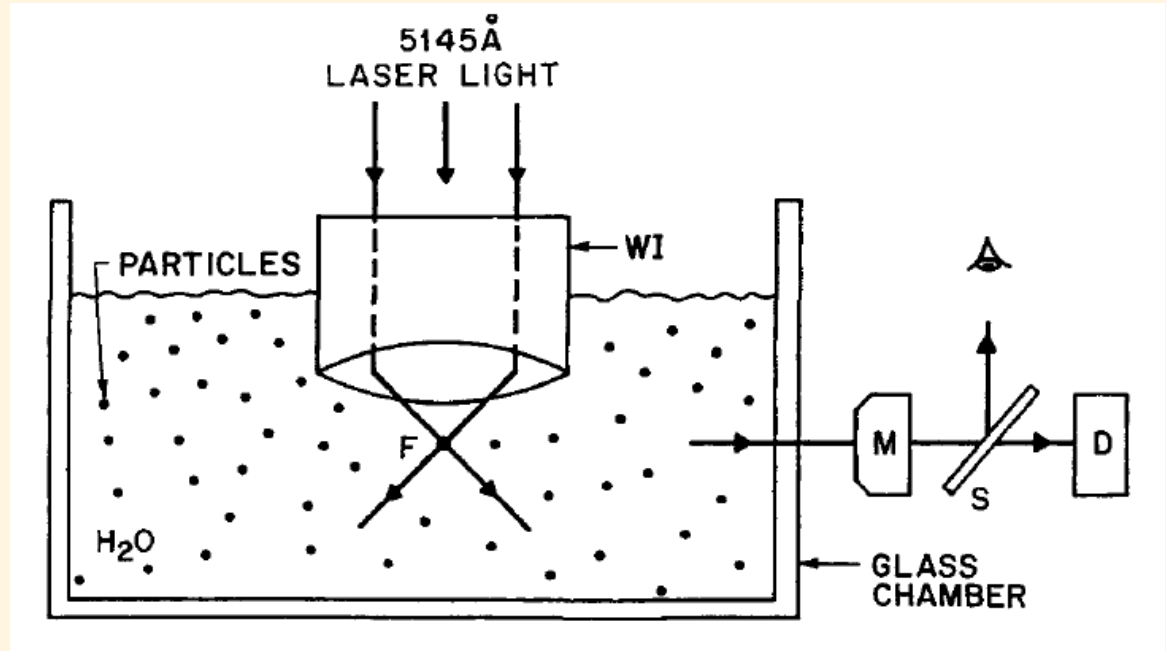

Bacteria (which are slightly larger than Rayleigh particles) trapping was accidentally observed and then rigorously characterized for *E. Coli* in a closed sample cell.

A. Ashkin and J.M. Dziedzic, "Optical trapping and manipulation of viruses and bacteria", *Science* 235, 1517 (1987)

Damage – free trapping of living cells with IR optical tweezers

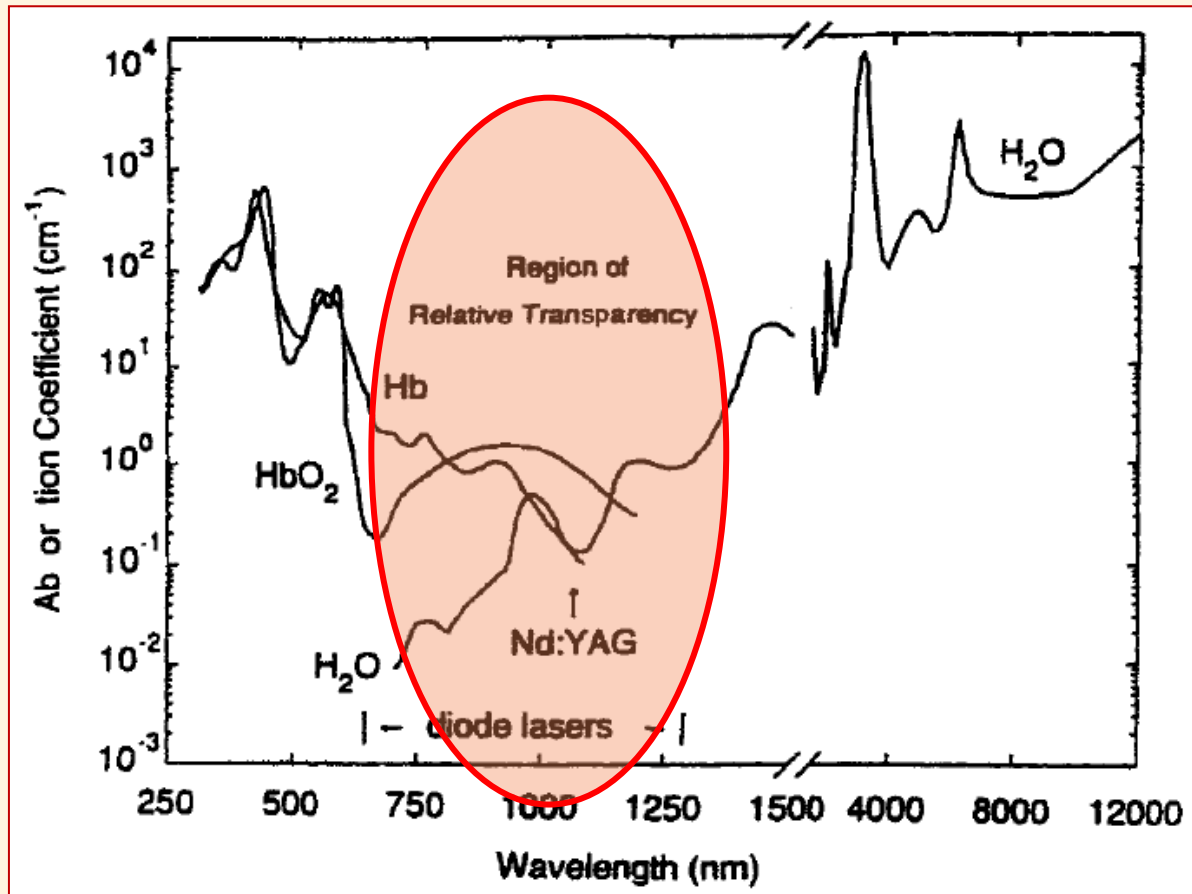

Plot of the optical absorption coefficients of hemoglobin (Hb), oxyhemoglobin (HbCh) and water versus the wavelength.

Damage – free trapping of living cells

A. Ashkin, J.M. Dziedzic, T. Yamane, “Optical trapping and manipulation of single cells using infrared laser beams”, *Nature* 330, 769 (1987)

Ashkin: “We tried red blood cells, plant cells, and the huge number of different types of protozoa, diatoms, and single cells of algae one can find in pond water.

One can trap almost any type of cells with IR beam without, or with limited damage.

Not only were the cell types quite varied, but also their sizes and shapes. Shape and optical properties of particles are crucial to the trapping process.

Optical traps are very tolerant on shape particle variation .

Intra-cellular trapping

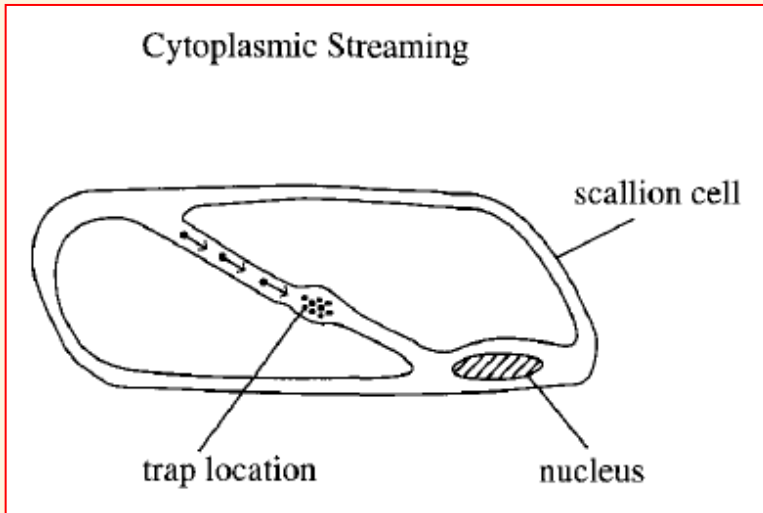

Internal cell manipulation. Collection of particles and a blob of cytoplasm trapped within a streaming channel of cytoplasm inside a living scallion cell. When released, they simply move on.

A. Ashkin and J. M. Dziedzic, Internal cell manipulation using infrared laser traps, *Proc. Natl. Acad. Sci. USA* **86**, 7914 (1989).

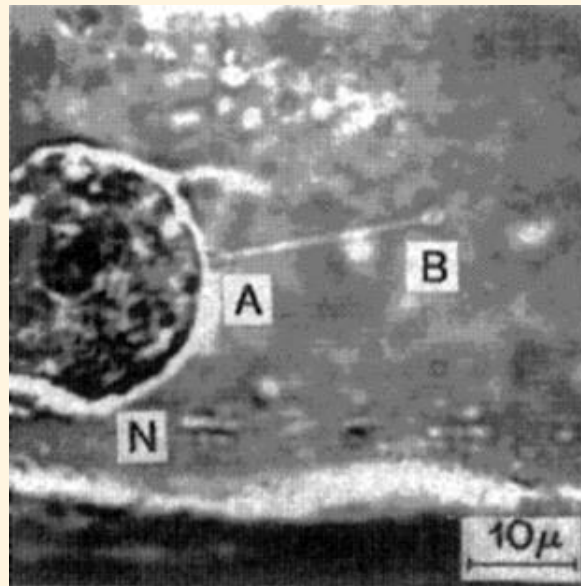



Arthur Ashkin
The Nobel Prize in Physics 2018

Born: 2 September 1922, New York, NY, USA

Affiliation at the time of the award: Bell Laboratories,
Holmdel, NJ, USA

Prize motivation: "for the optical tweezers and their
application to biological systems."

Prize share: 1/2

Arthur Ashkin invented optical tweezers that grab particles, atoms, viruses and other living cells with their laser beam fingers.

This new tool allowed Ashkin to realise an old dream of science fiction – using the radiation pressure of light to move physical objects.

He succeeded in getting laser light to push small particles towards the centre of the beam and to hold them there. Optical tweezers had been invented.

A major breakthrough came in 1987, when Ashkin used the tweezers to capture living bacteria without harming them. He immediately began studying biological systems and optical tweezers are now widely used to investigate the machinery of life.



Arthur Ashkin
The Nobel Prize in Physics 2018

Born: 2 September 1922, New York, NY, USA

Affiliation at the time of the award: Bell Laboratories,
Holmdel, NJ

y 2018

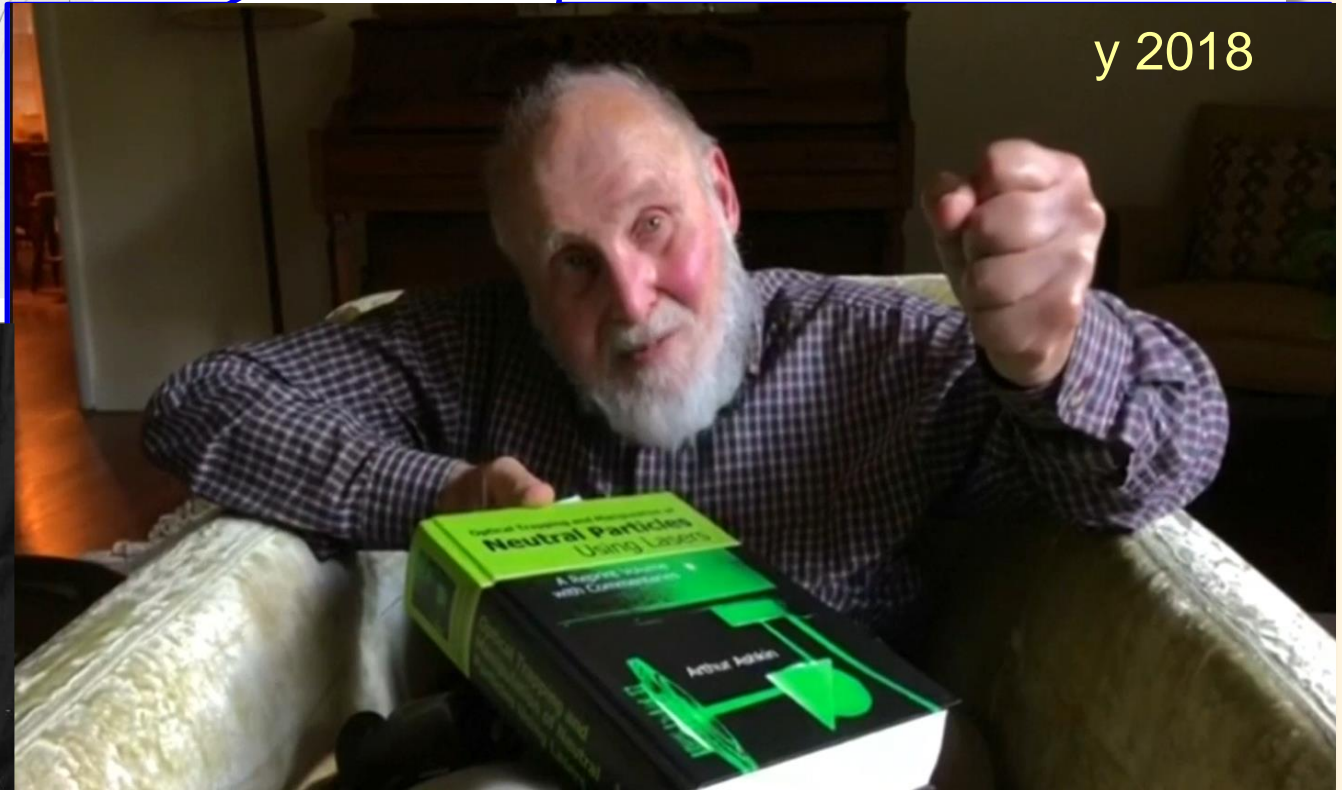

y 1958

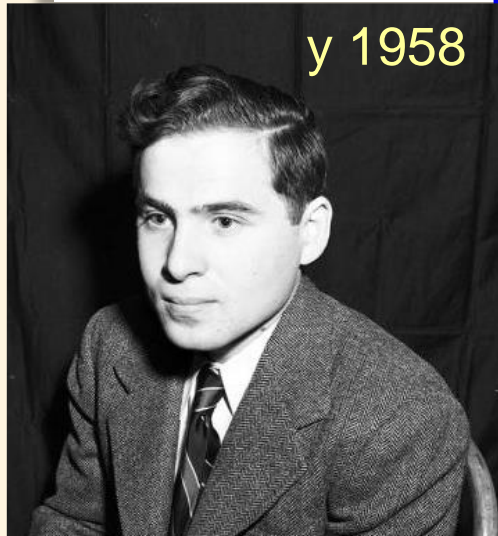

Optical Tweezers – some properties

What type of particles can be trapped ?

➤ **Material:**

- Dielectric (polystyrene, silica);
- Metallic (gold, silver, copper);
- **Biological** (cells, macro-molecules, intracellular structures, DNA filaments);
- Low index (ultrasound agent contrast); crystal or amorphous material.

➤ **Size:** 20 nm – 20 μ m

➤ **Shape:** spherical, cylindrical, arbitrary.

Range of forces that can be applied and measured : **0.1 – 200 pN**

Laser beam shaping (Bessel, Laguerre-Gaussian) allow multiple trapping and angular momentum transfer to particles (spin and orbital rotations)

Multiple trapping

How can we get multiple optical traps / tweezers?

1. **time-sharing a single beam among several different locations**

using galvano mirrors (GM), acousto-optic deflectors (AOD)

- Allow to obtain: 2D arrays of dynamic traps; modulate the strength of the traps individually
- GM are relatively cheap but have a lower frequency (kHz) and hence only few traps can be generated; AOD are more expensive but have a high frequency (MHz) and hence even tens of traps can be generated and controlled.

2. **split the beam into multiple beams**

using beam-splitter (BS) or spatial light modulators (SLM)

- BS allow to obtain 2 fixed traps with fixed strengths;
- SLM allows to obtain: 2D and 3D arrays of dynamic traps; modulate the strength of each trap individually; convert Gaussian beams to Laguerre-Gauss beams (to get helical-vortex beams) or Bessel beams

RBC in multiple traps, observed from two sides

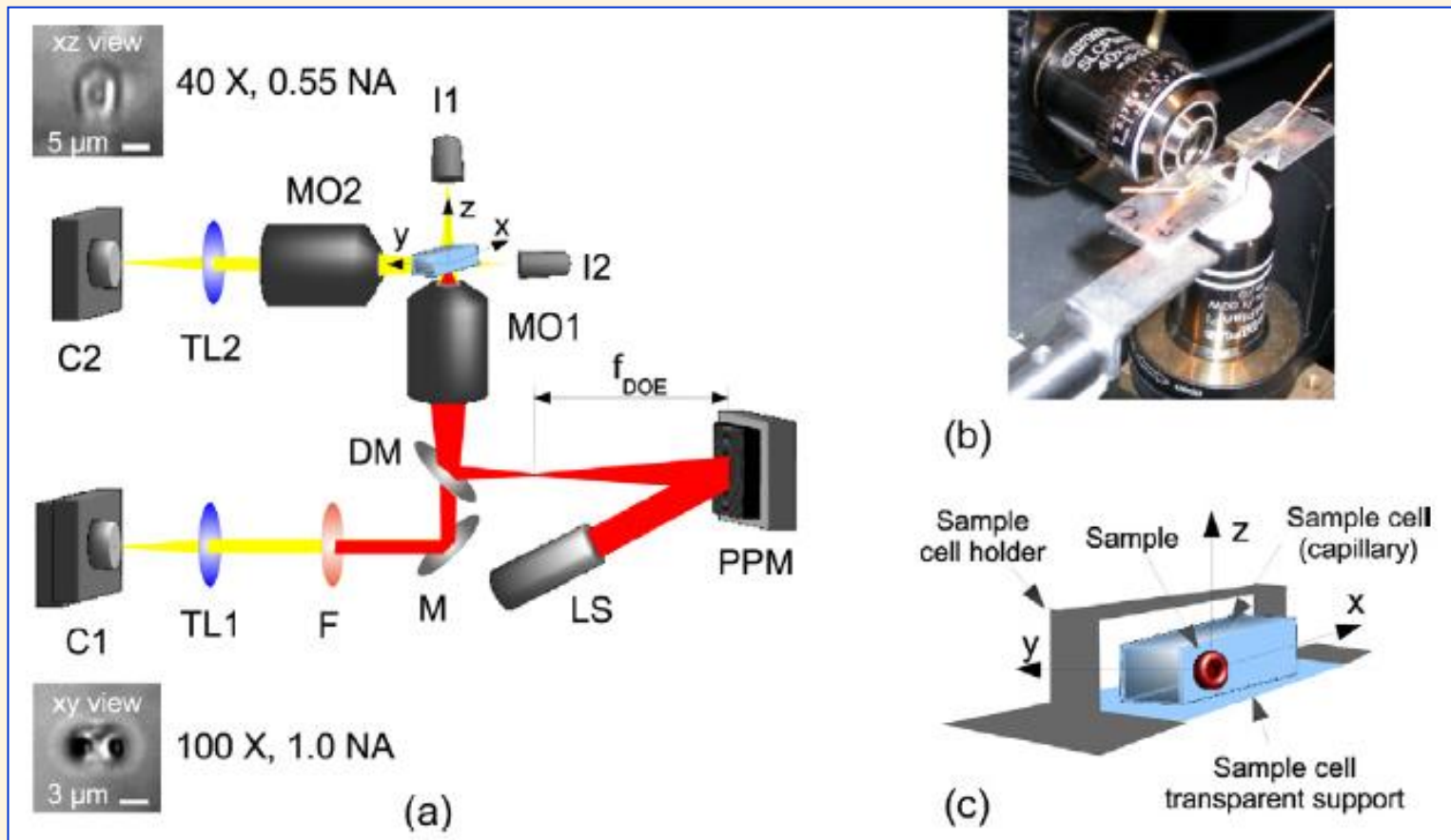

- (a) Schematic of the two-side imaging setup (not to scale). The red path corresponds to the trapping laser while yellow indicates the imaging paths. I1, I2: illumination, MO1, MO2: microscope objectives, DM: dichroic mirror, M: aluminum mirror, TL1, TL2: tube lenses, C1, C2: cameras, LS: laser source, PPM: programmable phase modulator (generally named Spatial Light Modulator – SLM);
- (b) a picture of part of the setup showing the two microscope objectives and the sample cell;
- (c) a schematic of the sample cell which allows multi-view imaging of the sample.

Single RBC manipulated (rotation) by **2 traps** and cell rotation monitored by two-side view

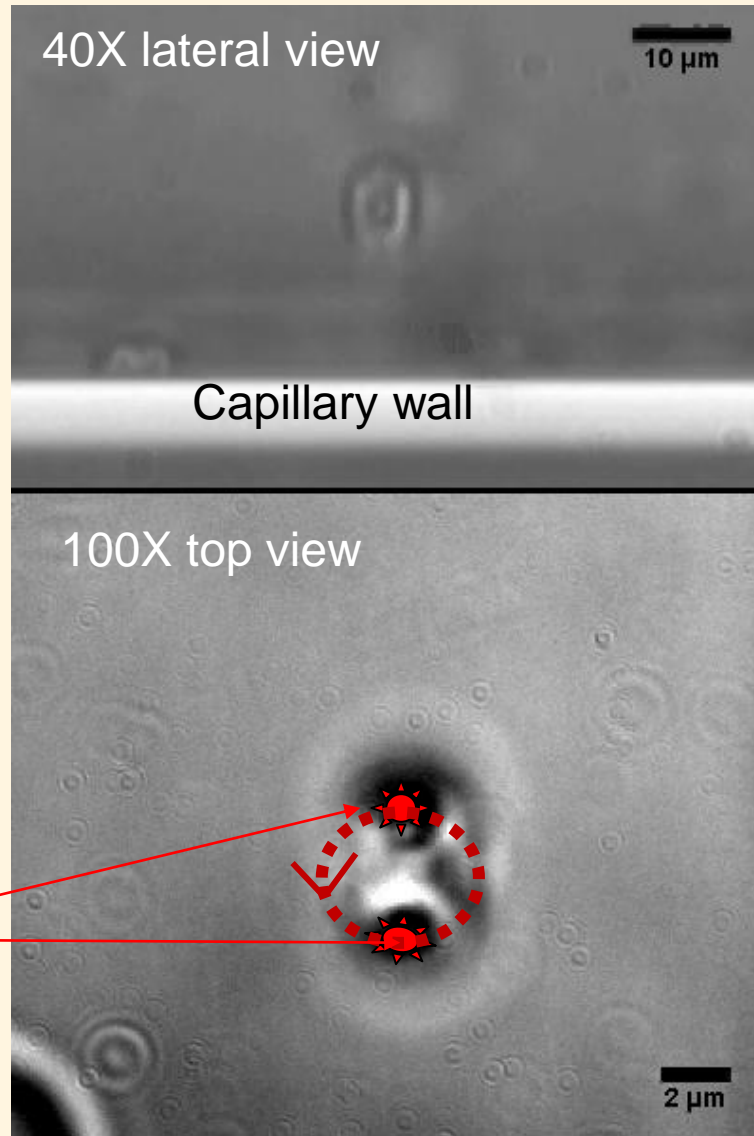

two optical traps
rotating

Cell (adherent on substrate) stressed mechanically by a cage of beads

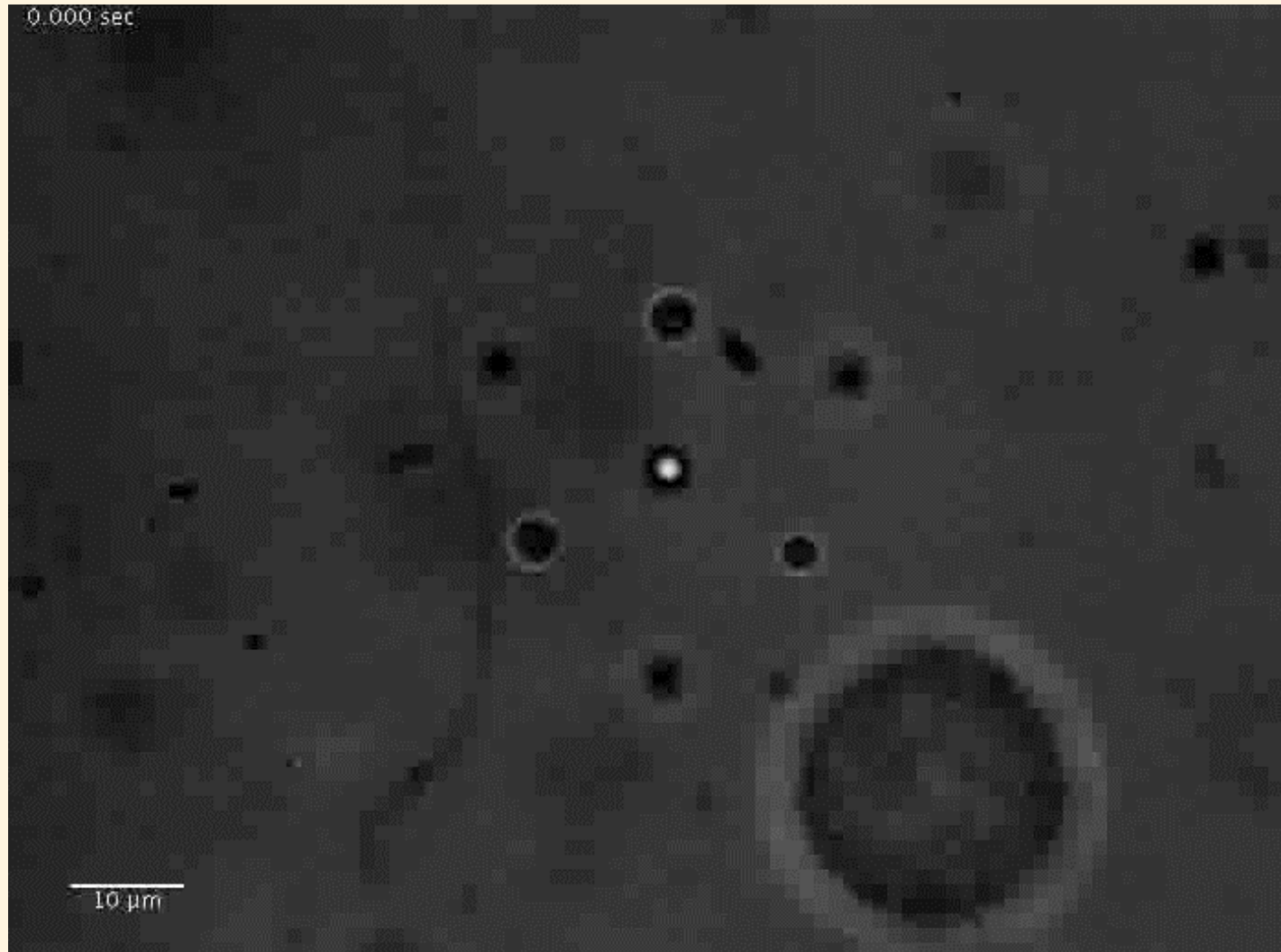

Examples of optical manipulation with Gaussian and LG beams

Ultrasound Contrast Bubble – LG 2D trap

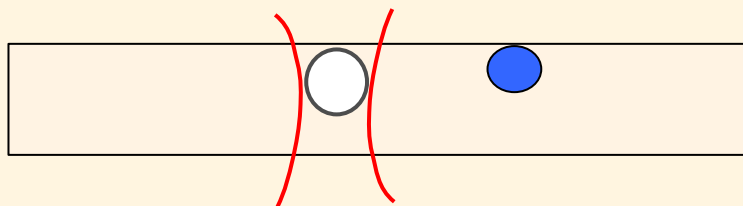
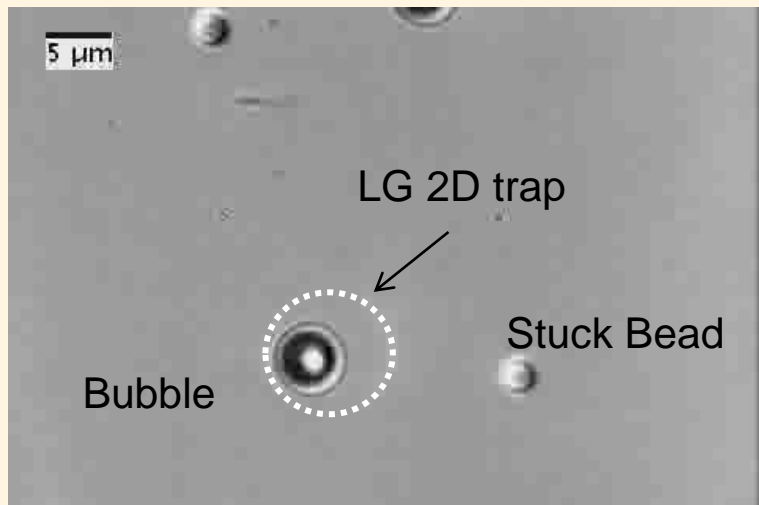

Gaussian TEM 00

Laguerre Gaussian LG 01

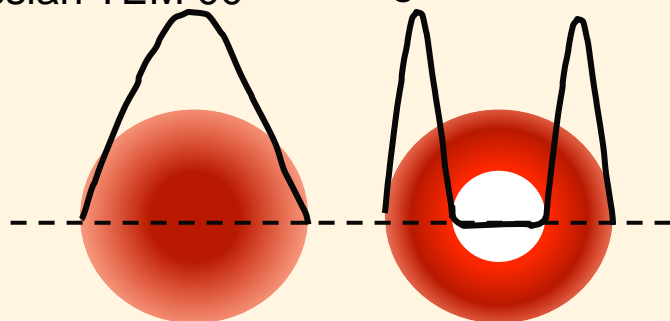

Very simple rotor - piece of glass

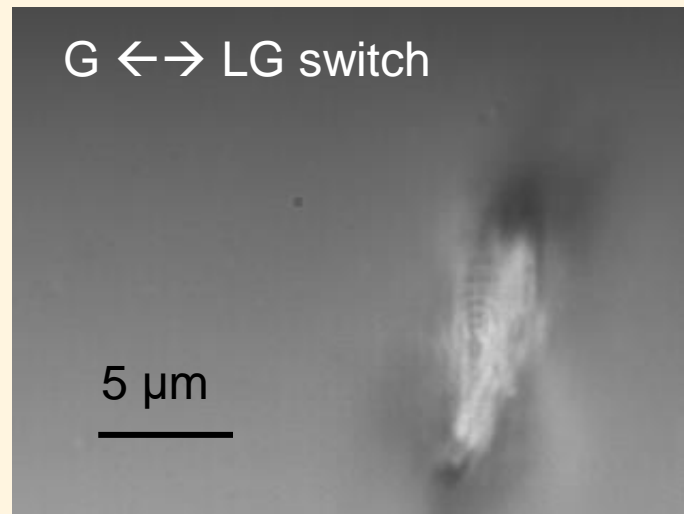

LG OAM transfer to silica bead

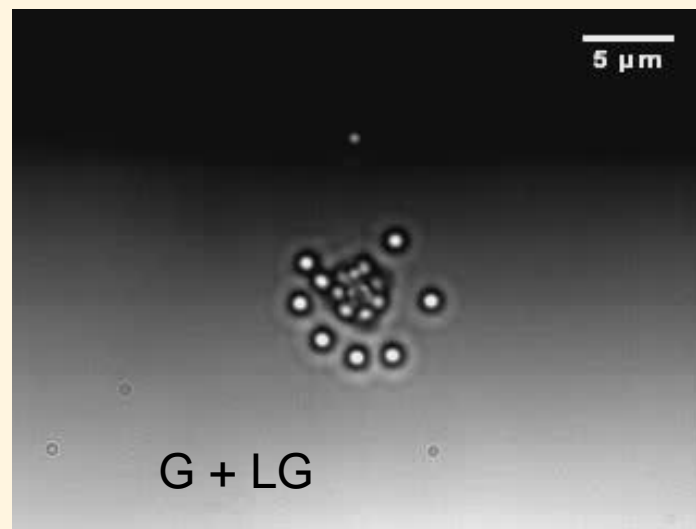

OAM = Optical Angular Momentum

Beside trapping and manipulation **OT can measure forces**
using the trapped bead as probe

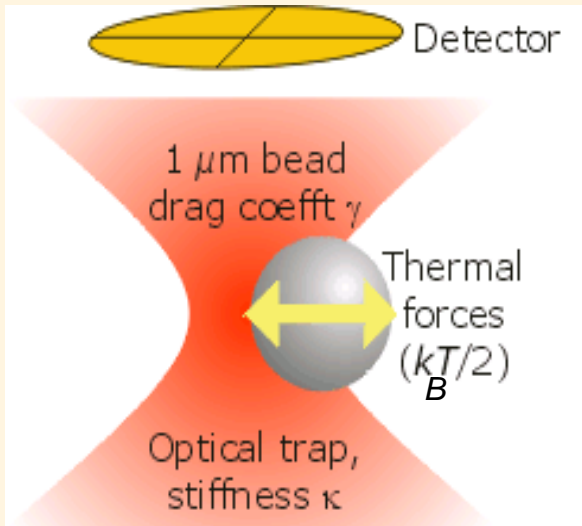

Schematic of a microbead
in an optical trap

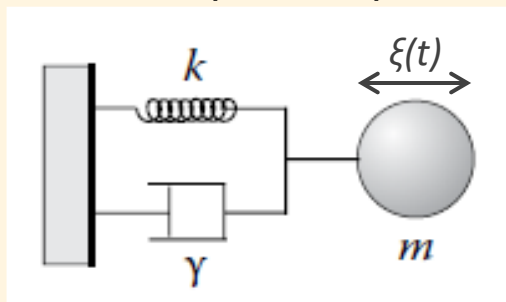

Equation of motion

$$m\ddot{x}(t) + \gamma_0\dot{x}(t) + \kappa x(t) = (2k_B T \gamma_0)^{1/2} \eta(t)$$

$$\dot{x}(t) + 2\pi f_c x(t) = (2D)^{1/2} \eta(t)$$

$$f_c \equiv \kappa / (2\pi\gamma_0)$$

$$D = k_B T / \gamma_0$$

f_c – corner frequency, c

It can be determined from the Power spectrum

Due to the optical force, the natural Brownian motion of the trapped bead is confined to the trapping region, near the focus of the objective.

Tracking the probe/bead with nm resolution

Bead position is determined by back focal plane (BFP) interferometry

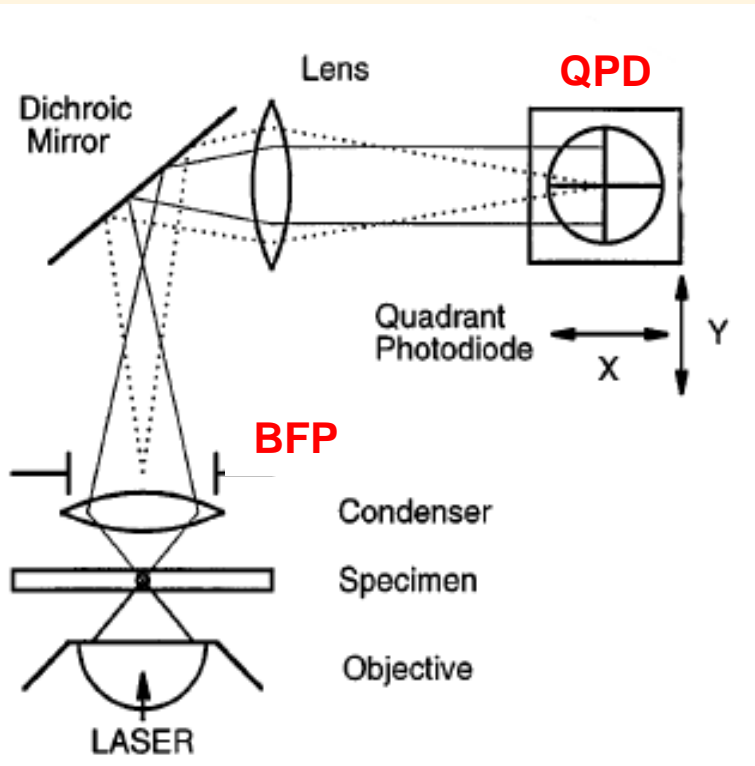

Interference pattern – position detection in X-
Y and Z

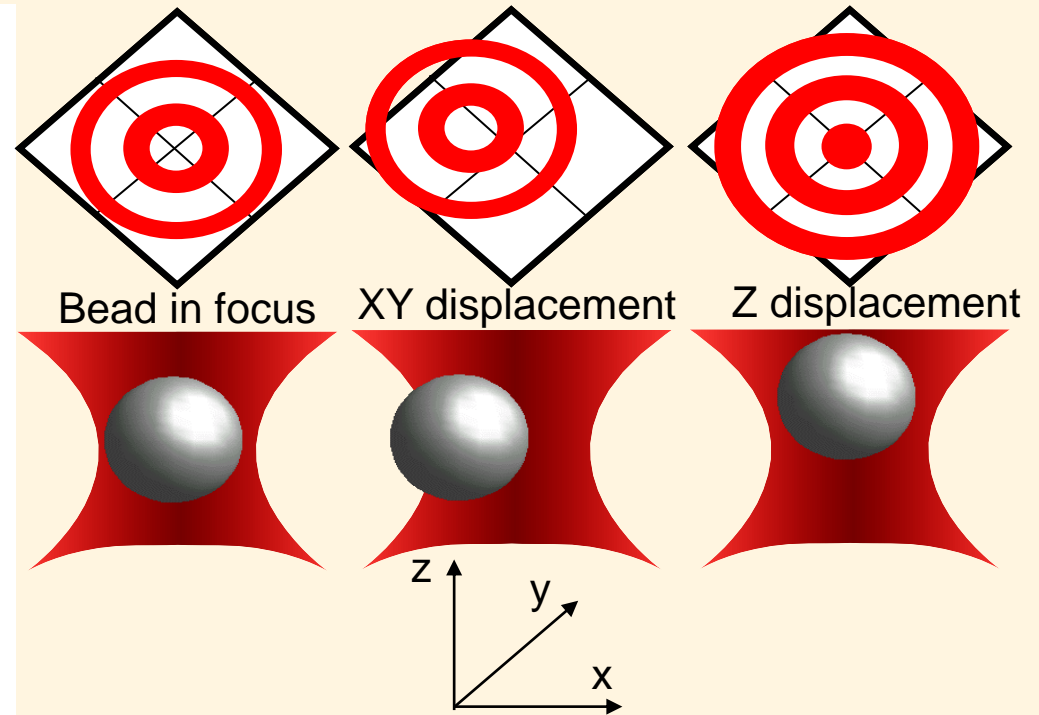

The **interference pattern** formed by the interference of the laser light scattered by the bead in the BFP is imaged onto a QPD

Sensitivity of the QPD is measured using a stuck microbead on the coverslip and a piezo to move the coverslip in controlled nm steps .

Determining the trap stiffness, k

Track the the bead position in the trap

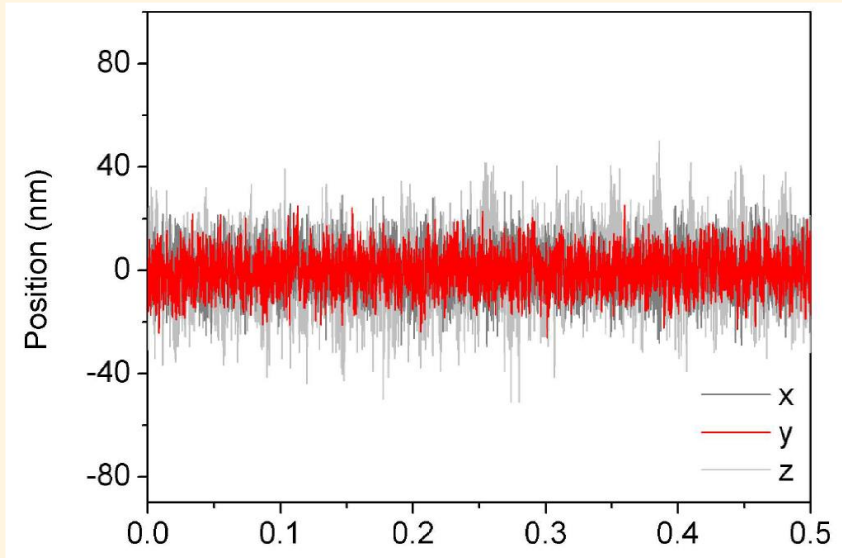

X, Y, Z - bead in trap

Position histogram, potential energy

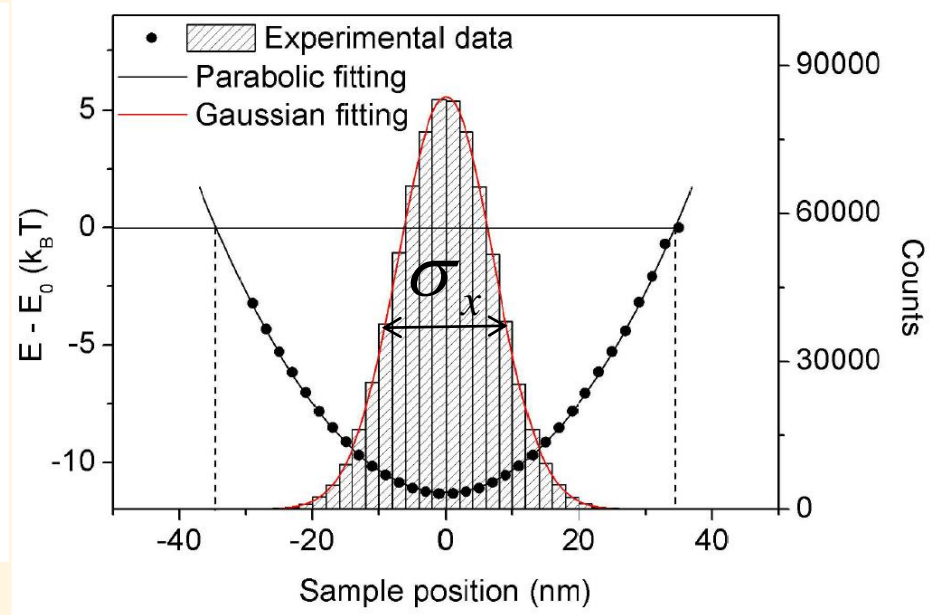

Probability density of the bead position
(Boltzmann statistics)

$$\rho(x, y) = C \exp\left(\frac{-U(x, y)}{k_B T}\right)$$

$$\rho(x, y) = C e^{\frac{-k_x x^2}{2k_B T}} e^{\frac{-k_y y^2}{2k_B T}}$$

$$k_x = \frac{k_B T}{\sigma_x^2}$$

$$k_y = \frac{k_B T}{\sigma_y^2}$$

Example of two tracking traces of a trapped bead , with different stiffnesses

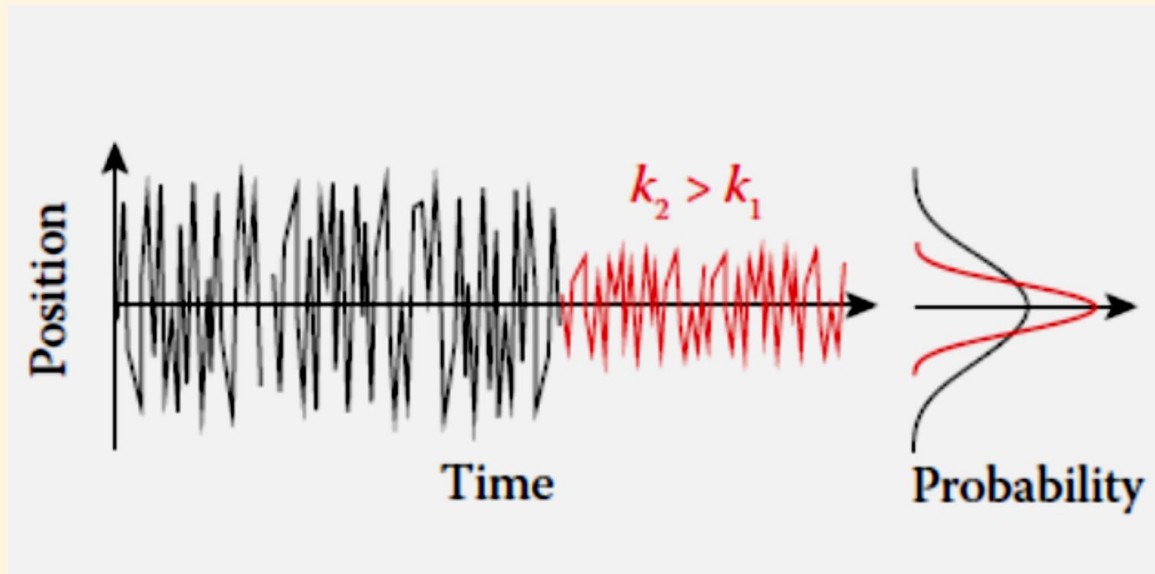

$$\frac{1}{2}k_B T = \frac{1}{2}k \langle x^2 \rangle \Rightarrow \langle x^2 \rangle = \sigma_x^2 = \frac{k_B T}{k}$$

$$p(x) = \frac{1}{Z} \exp\left[-\frac{U(x)}{k_B T}\right] = \frac{1}{Z} \exp\left(-\frac{x^2}{2\frac{k_B T}{k}}\right)$$

Determine the trap stiffness using the Power Spectrum Density (PSD)

The power spectrum $S_v(f)$ of the signal $sv(x)$ is:

$$S_v(f) = |F(s)|^2$$

F- Fourier transform

$S_v(f)$ - measured power spectrum

$S(f)$ - density Lorentzian fit

$$S_x(f) = \frac{k_B T}{\pi^2 \gamma (f_c^2 + f^2)}$$

f_c - corner frequency

$$f_c = k/2\pi\gamma = 1/2\pi\tau$$

f_c - corner frequency

$$f \ll f_c \Rightarrow S_x(f) = 4k_B T \gamma / k^2$$

k, γ

k - trap stiffness

γ - Stokes drag coefficient

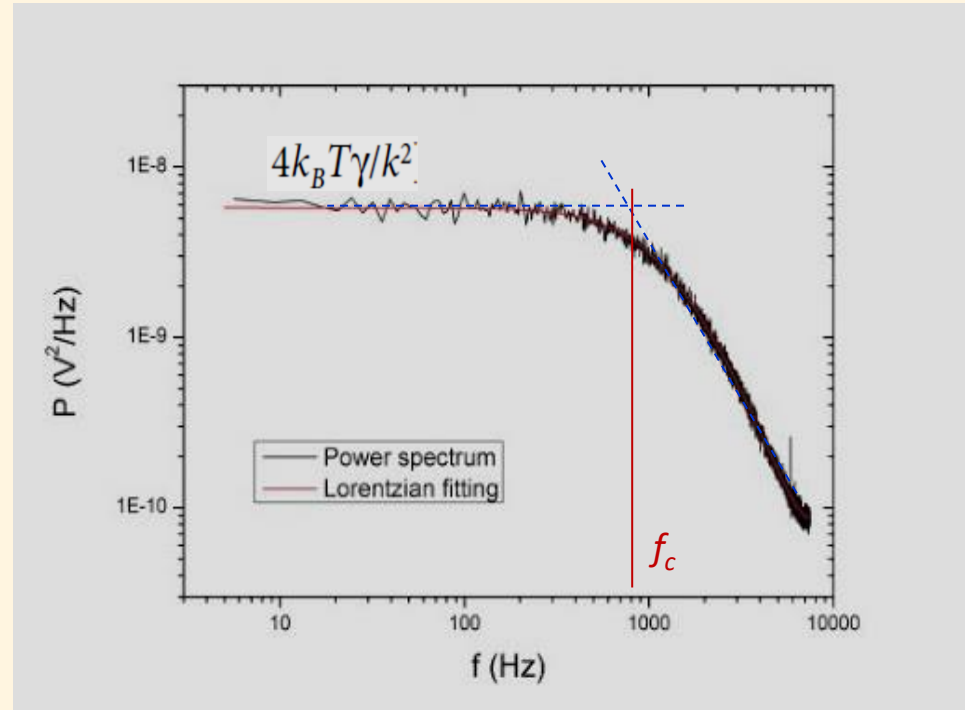

The power spectrum (black) of a trapped 1 μm silica bead acquired at 10 KHz and fitted to a Lorentzian (red).

Examples of three different PSD in relation with the trap stiffness k and drag coefficient γ

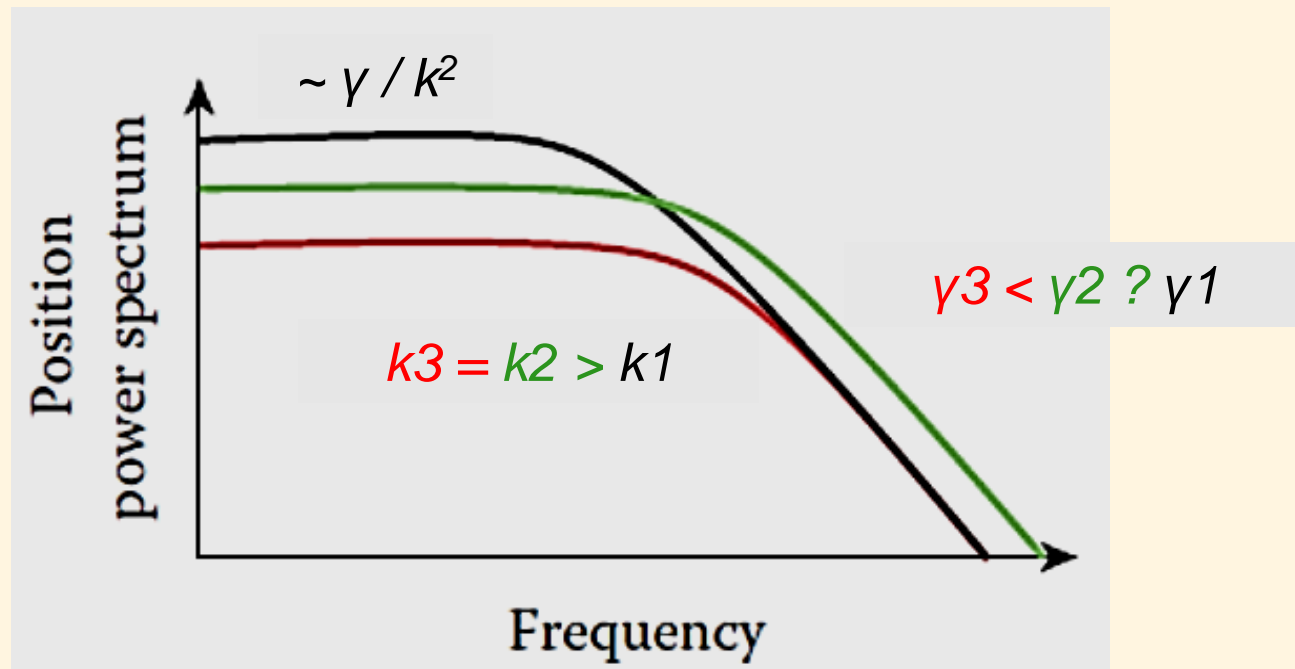

Measuring an external force exerted on the bead

Measuring the displacement Δ of the particle and knowing the stiffness of the trap K we get F :

$$F = K \Delta$$

$F = (F_x, F_y, F_z)$ Force

$K = (K_x, K_y, K_z)$ stiffness of the trap

$\Delta = (\Delta_x, \Delta_y, \Delta_z)$ Displacement

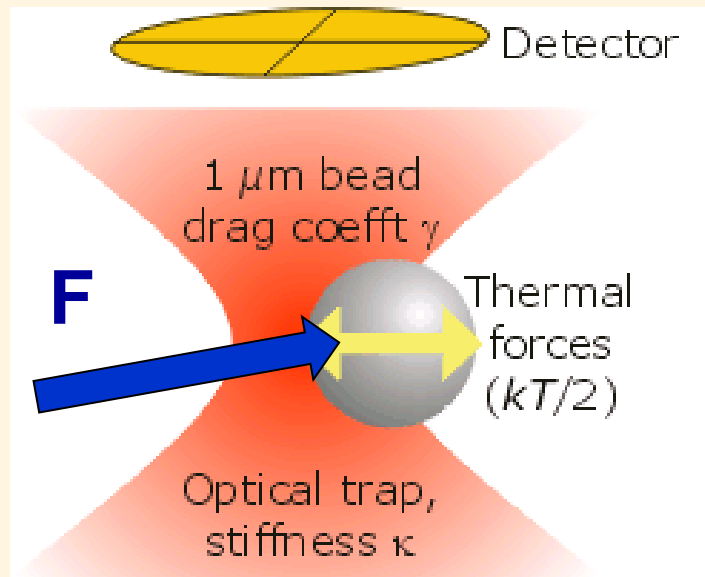

OT allows measuring forces in 3D !

Typical values for **OT** : $K_{OT} = 0.001 - 0.5 \text{ pN/nm}$

Typical values for **AFM**: $K_{AFM} = 1 - 1000 \text{ pN/nm}$

**OT and AFM are
complementary
Techniques**

Optical Tweezers to locally probe living cells

(experimental approaches)

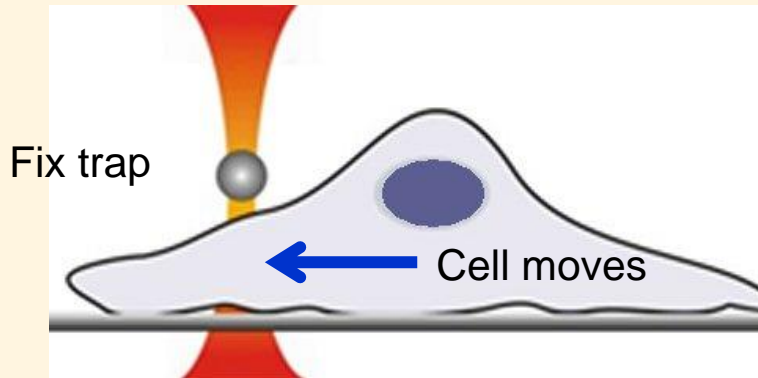

Touch / intercept

Measure forces when the cell or part of the cell moves

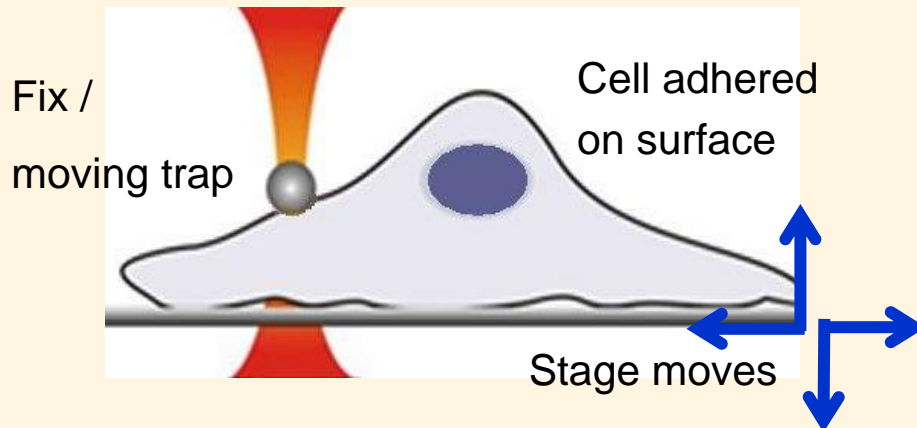

Pull / Push

Local adhesion / binding

Local viscoelasticity (tether membrane, indentation)

Local mechanical stimulation - mechanotransduction

Force exerted by Filopodia of Growth Cone during Protrusion

2 Days In Vitro hippocampal neuron from mouse

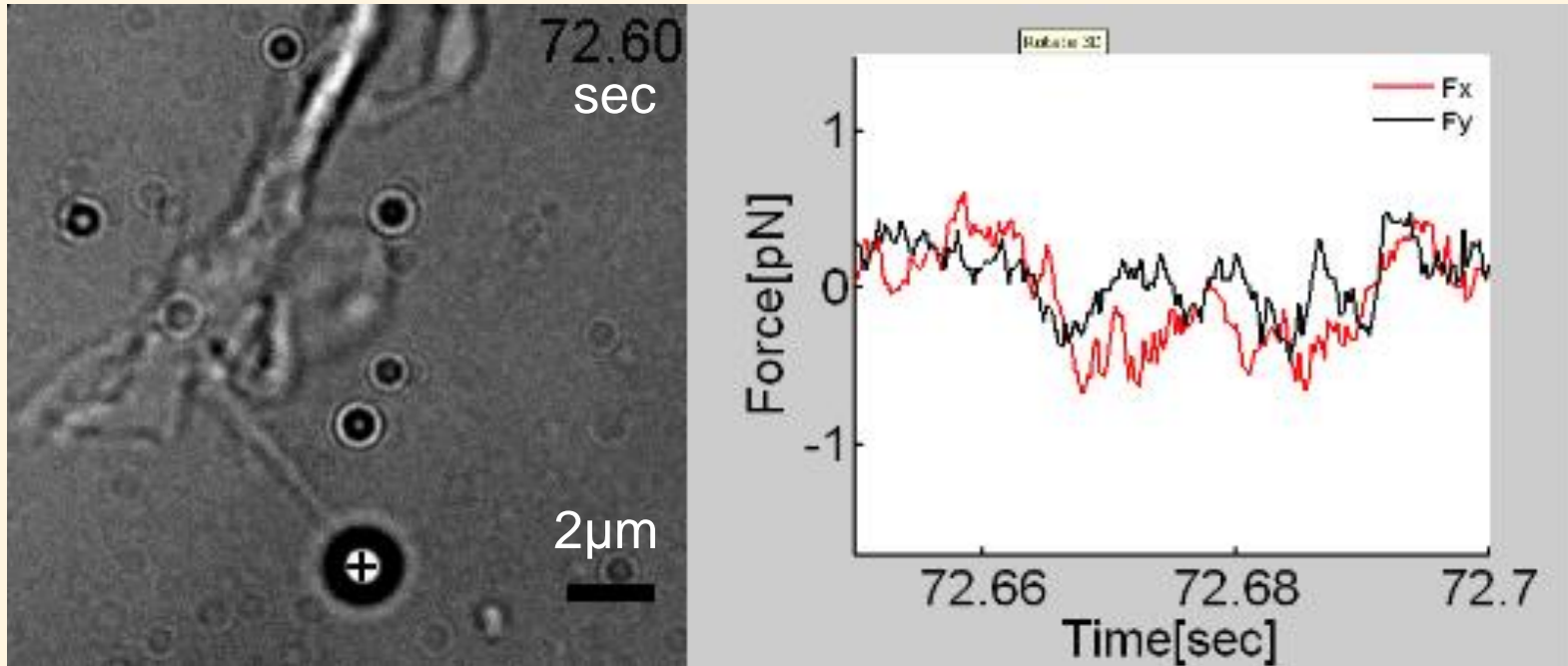

The force and protrusion due to actin polymerization of the bundle of actin filaments in the filopodia is observed.

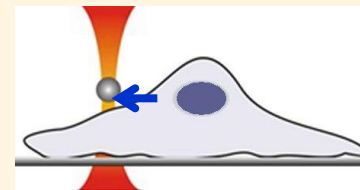

Cojoc, D, ... & Torre, V, PLoS One 2 (10), e1072 (2007)

Difato, F, Pinato, G & Cojoc, D, *Int. J. Mol. Sci.* **14**, 8963 (2013) - REVIEW

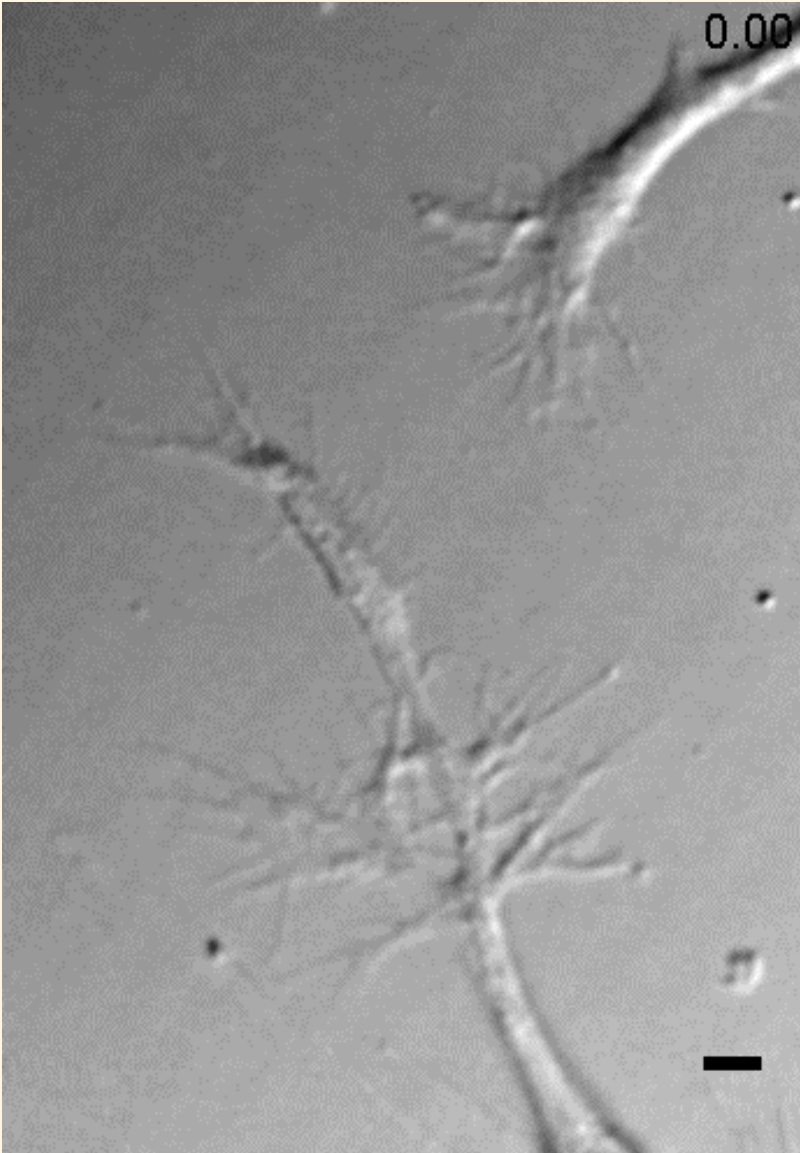

Cell membrane indentation

AFM

$k = 150 \text{ pN/nm}$,
 $A_{\text{PF}} = 1 \mu\text{m}$,
 $f_{\text{PF}} = 200 \text{ Hz}$,
 $F_{\text{SP}} = 1 \text{ nN}$

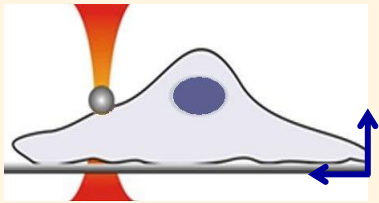

OT

$k = 0.015 \text{ pN/nm}$,
 $A = 1 \mu\text{m}$,
 $f = 0.2 \text{ Hz}$,
 $F = 5\text{-}20 \text{ pN}$

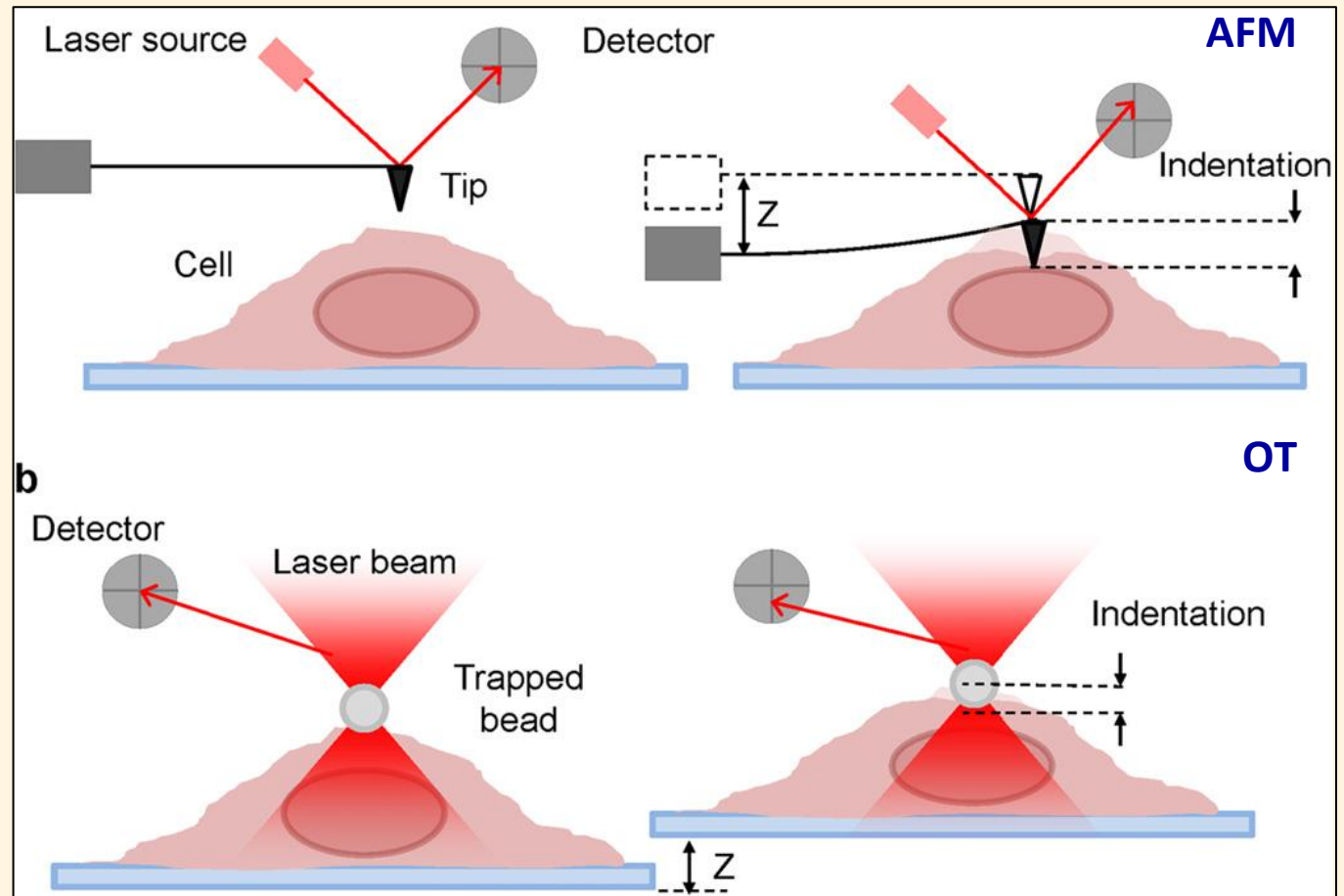

Young's modulus is extracted from the Force – Indentation curve using the Hertz model

Indentation

$$I_d = (\text{Stage disp}) - (\text{Bead disp})$$

$$E = \left[\frac{3(1-\nu^2)}{4\sqrt{I_d} \cdot l} \right] \cdot S$$

$$E = 1150 \cdot S$$

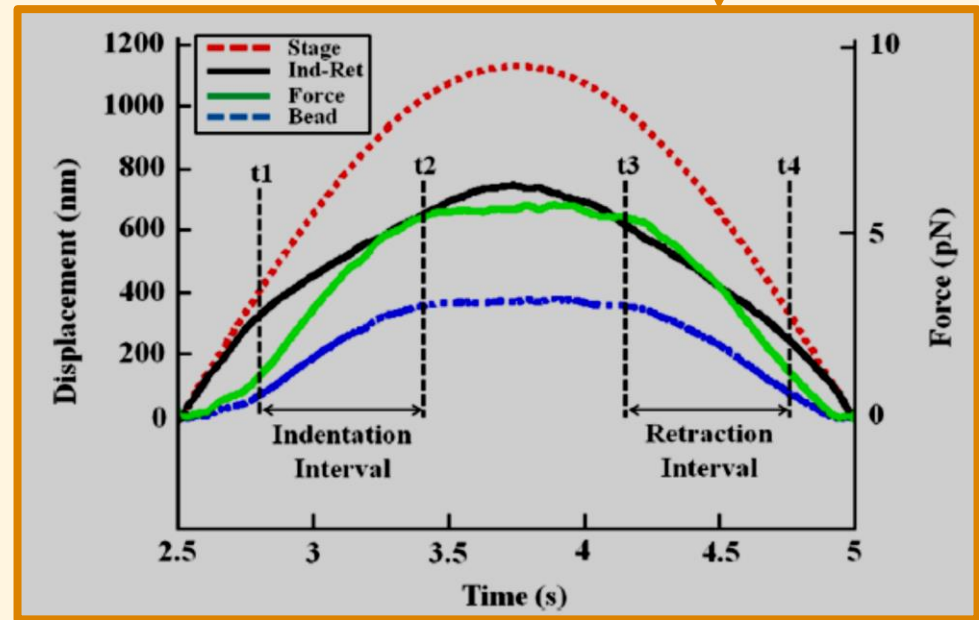
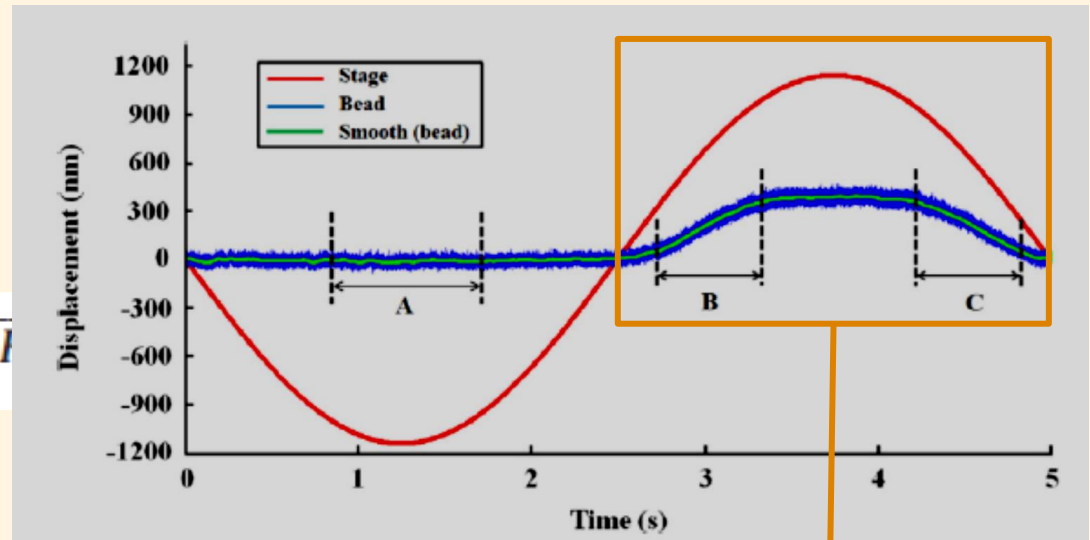

Example of Force – Indentation curve

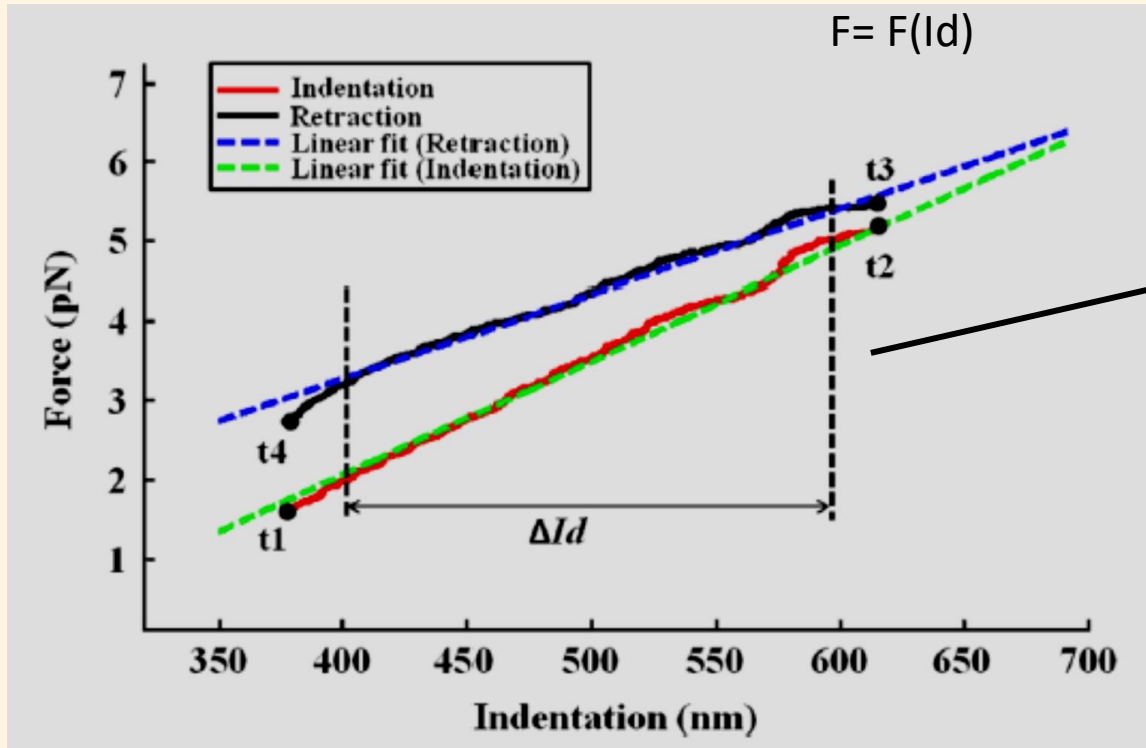

Elastic behavior

$$E = \left[\frac{3(1 - \nu^2)}{4\sqrt{Id \cdot R}} \right] \cdot (F/Id)$$

E – Young's modulus
 ν - Poisson's coefficient
 R – bead radius

E – is determined by fitting the $F(Id)$ curve

Breast cancer cell model

Normal myoepithelial

Luminal breast cancer

Basal breast cancer cells

Non neoplastic

Low metastastic potential

High metastatic potential

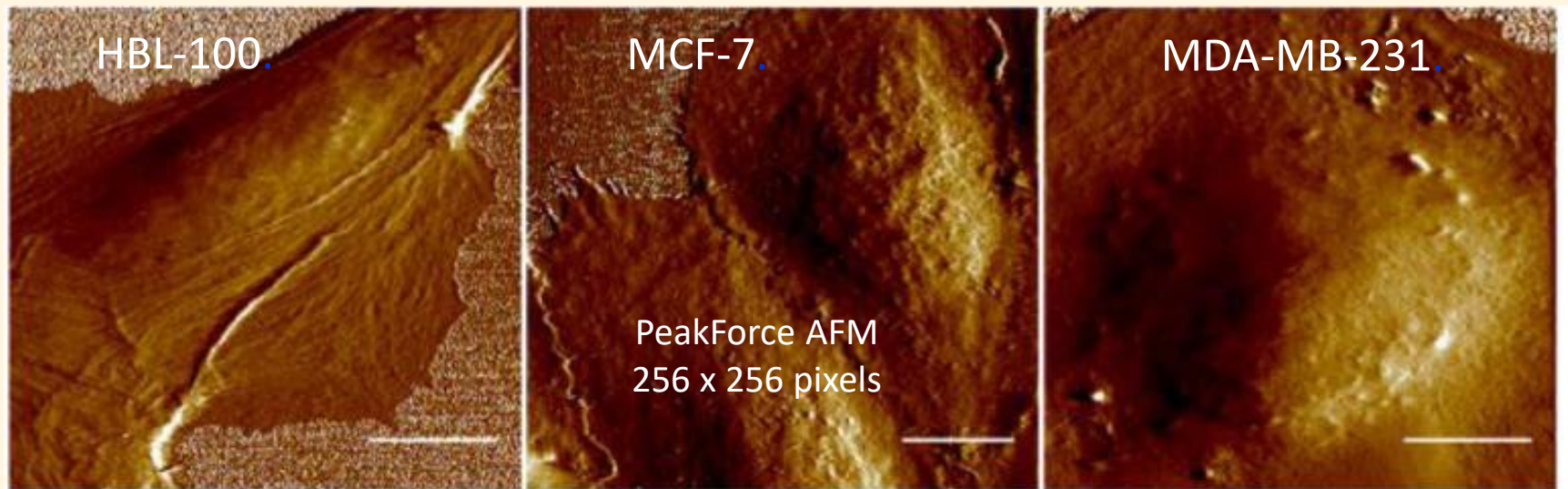
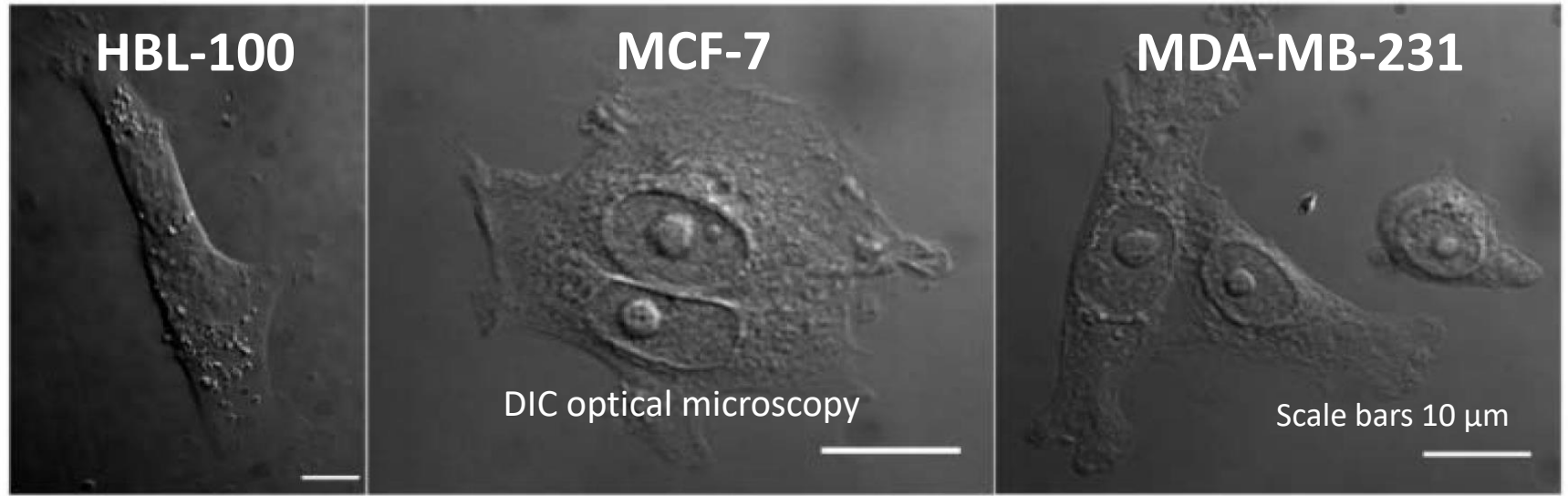

Where to indent for a good reliability ?

properties

Indent at three different locations:

- L1 – Nuclear region
- L2 - Intermediate
- L3 – leading edge

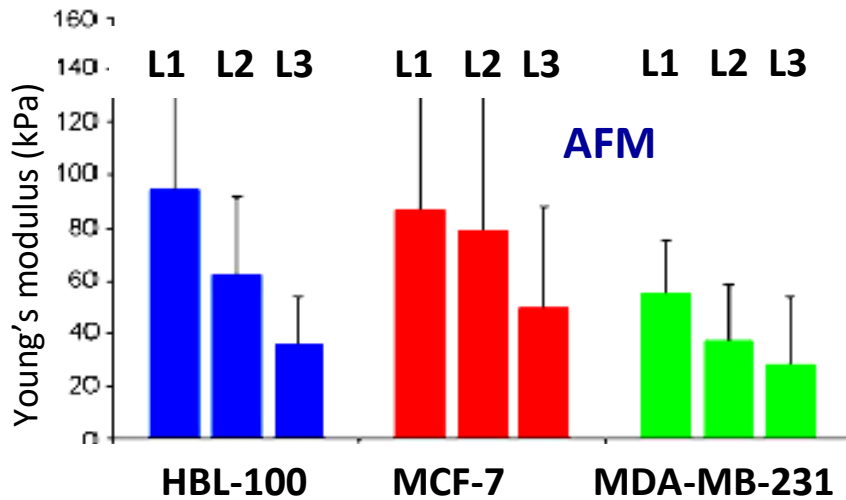
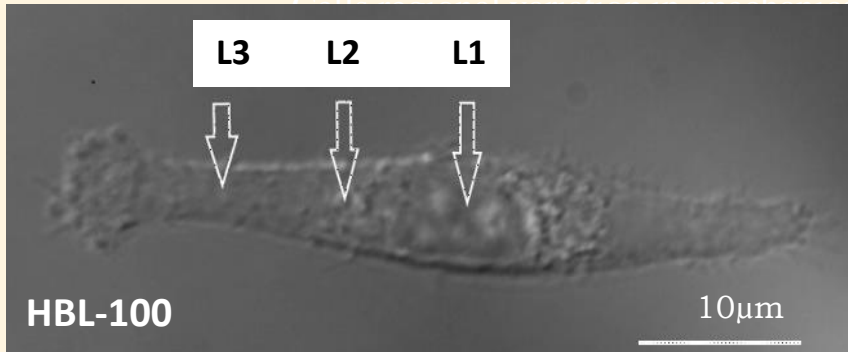

Cell stiffness variation over the cell

OT measurements are similar as trend

Cells are stiffer at the nuclear region (L1) for all the cell lines.

The nuclear region is the most reliable since it is well defined topographically

Cell stiffness measured above the nuclear region

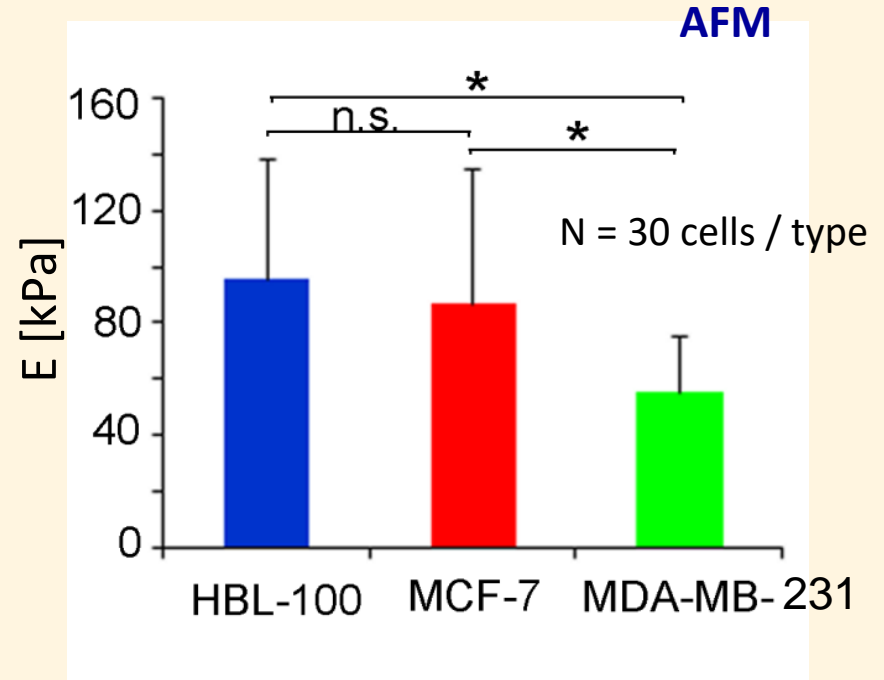
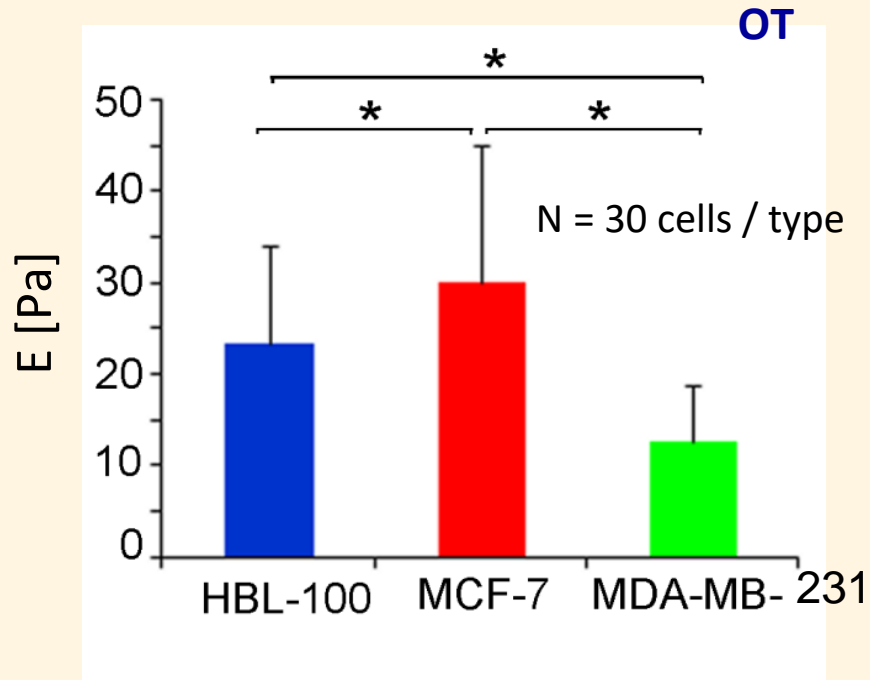

- **MDA – MB- 231 cells (high metastatic potential)** are significantly **softer** than the other two cell types
- The **result is confirmed both by OT and AFM** techniques
- The absolute values obtained for E are different because the force range and the loading rate are very different for OT and AFM indentation

Is the cell stiffness a material constant or it changes / adapt to environment conditions ?

Is the cell stiffness influenced by the cell microenvironment ?

We investigated cell stiffness changes when :

- cell is in contact with more than 2 cells
- Substrate stiffness is changed

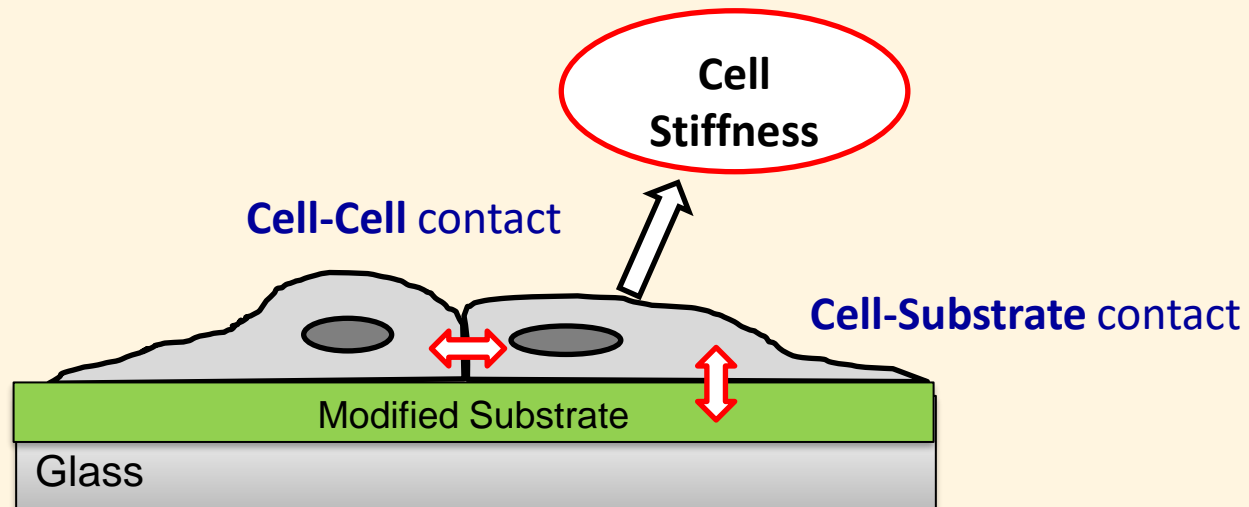

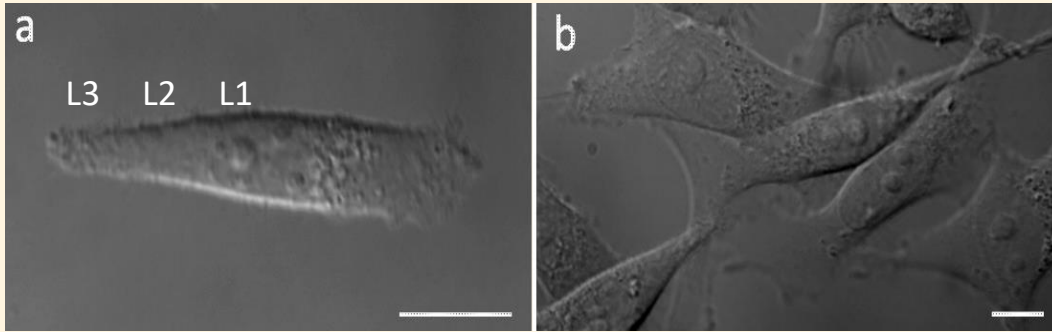

Each cell was indented at three different locations:
 L1 - Center (nucleus)
 L2 - Nucleus edge
 L3 -Leading edge

Isolated cell

Connected cell

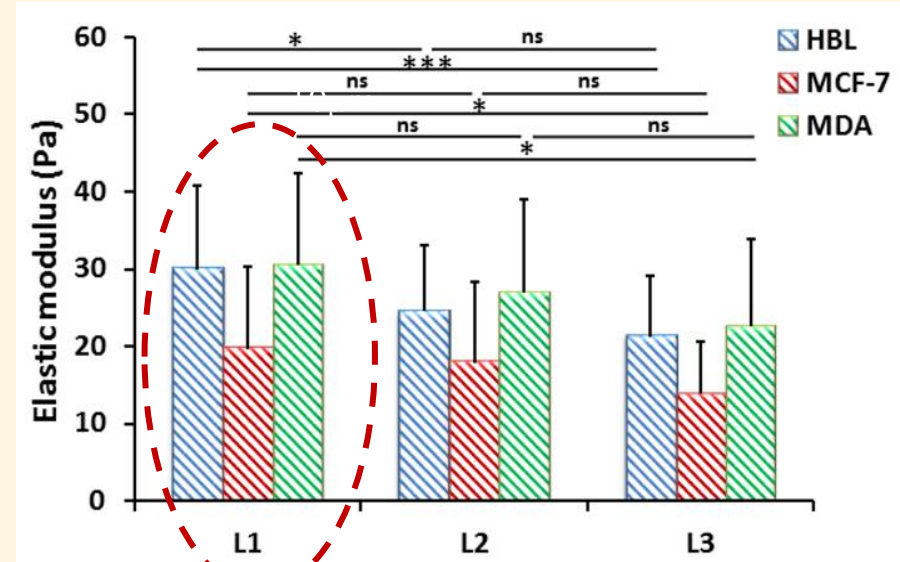
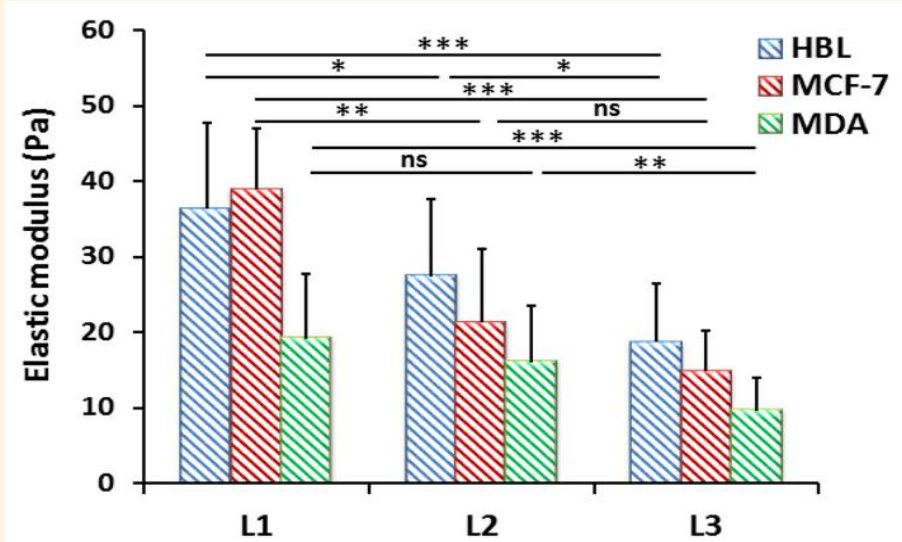

- **MDA cells get stiffer when in contact, looking similar to HBL and MCF**
- MCF and HBL become softer when in contact.

Substrate stiffness changes

Polydimethylsiloxane (PDMS): biocompatible polymer , controlled stiffness

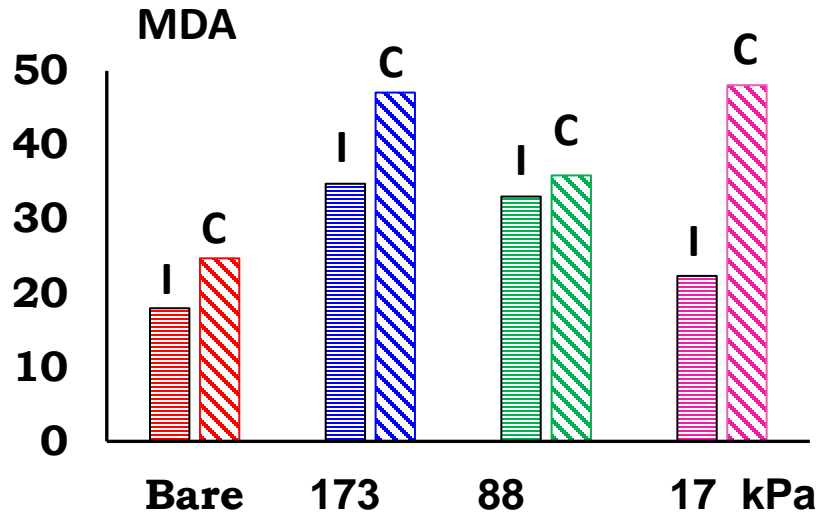
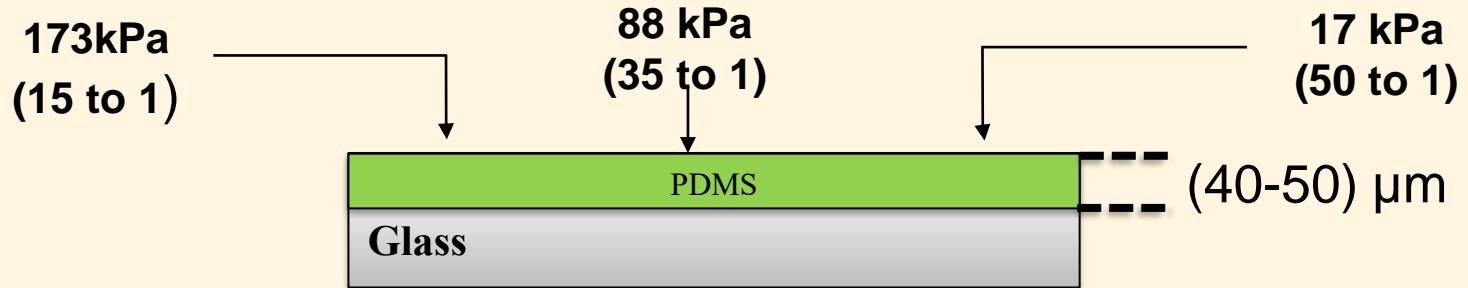

MDA stiffness on softer substrates:

- I - Isolated decreases
- C - Connected increases considerably

HBL-100 stiffness on softer substrates:

- isolated decreases
- connected increases

Main conclusions:

- 1. Cell stiffness does depend on the environment
(Extracellular matrix - cell, cell-cell)**
- 2. The stiffness of MDA-MB-231 cells (high metastatic potential)
changes much more than the stiffness of the other two cell lines.**



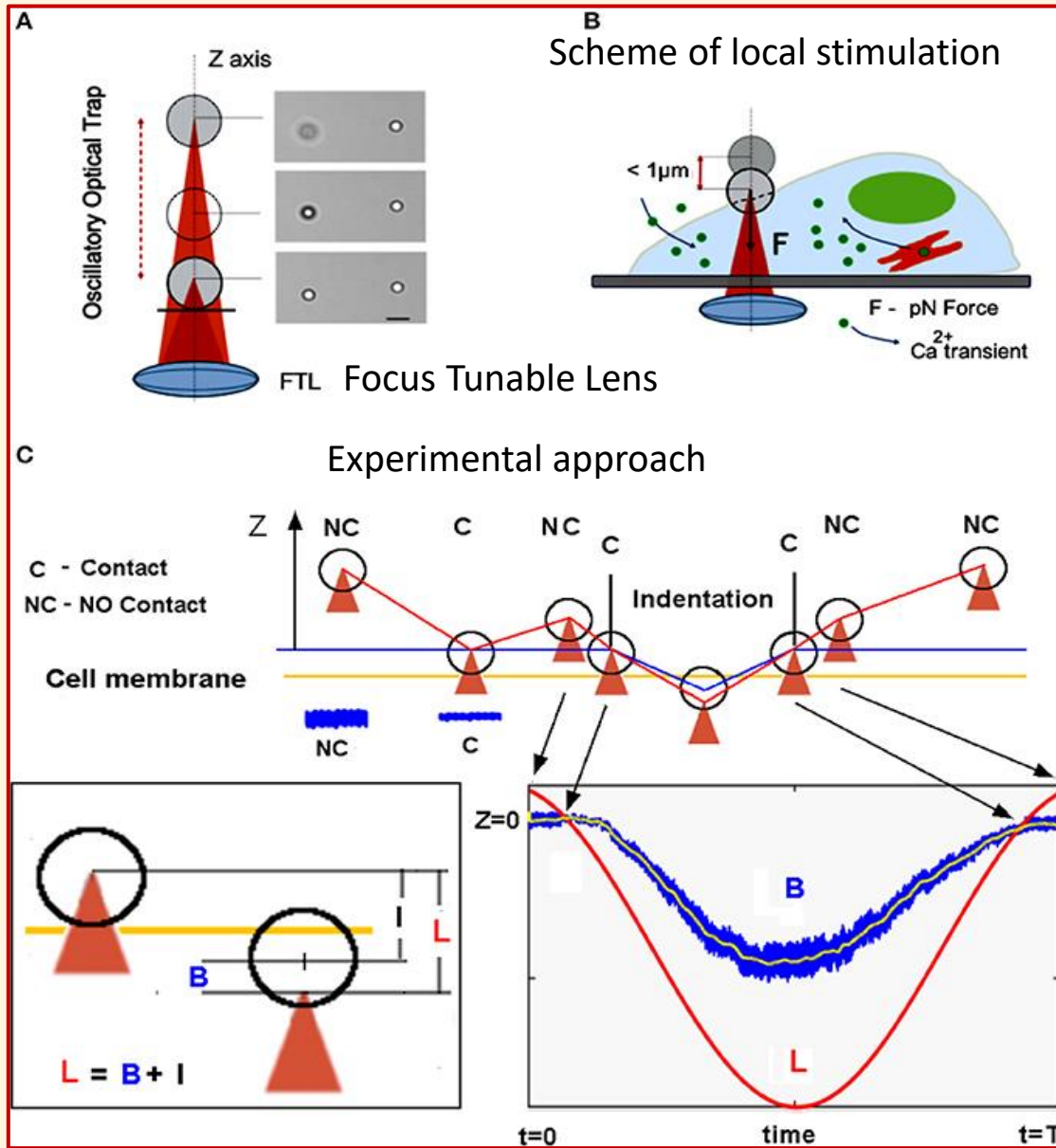

Forces expressed by neurons during development, cell-cell and cell ECM interaction are in pN-nN range.

We study the effect of mechanical stimulation of neuronal cells with controlled piconewton forces .

- Mouse neuroblastoma NG108-15
- Rat hippocampal neurons (1-2 days postnatal)

F. Falleroni *et al*,
Frontiers Cell Neurosci, 2018

F. Falleroni *et al*, submitted

Ca²⁺ transients evoked by calibrated mechanical stimulations

Brightfield

Calcium Imaging

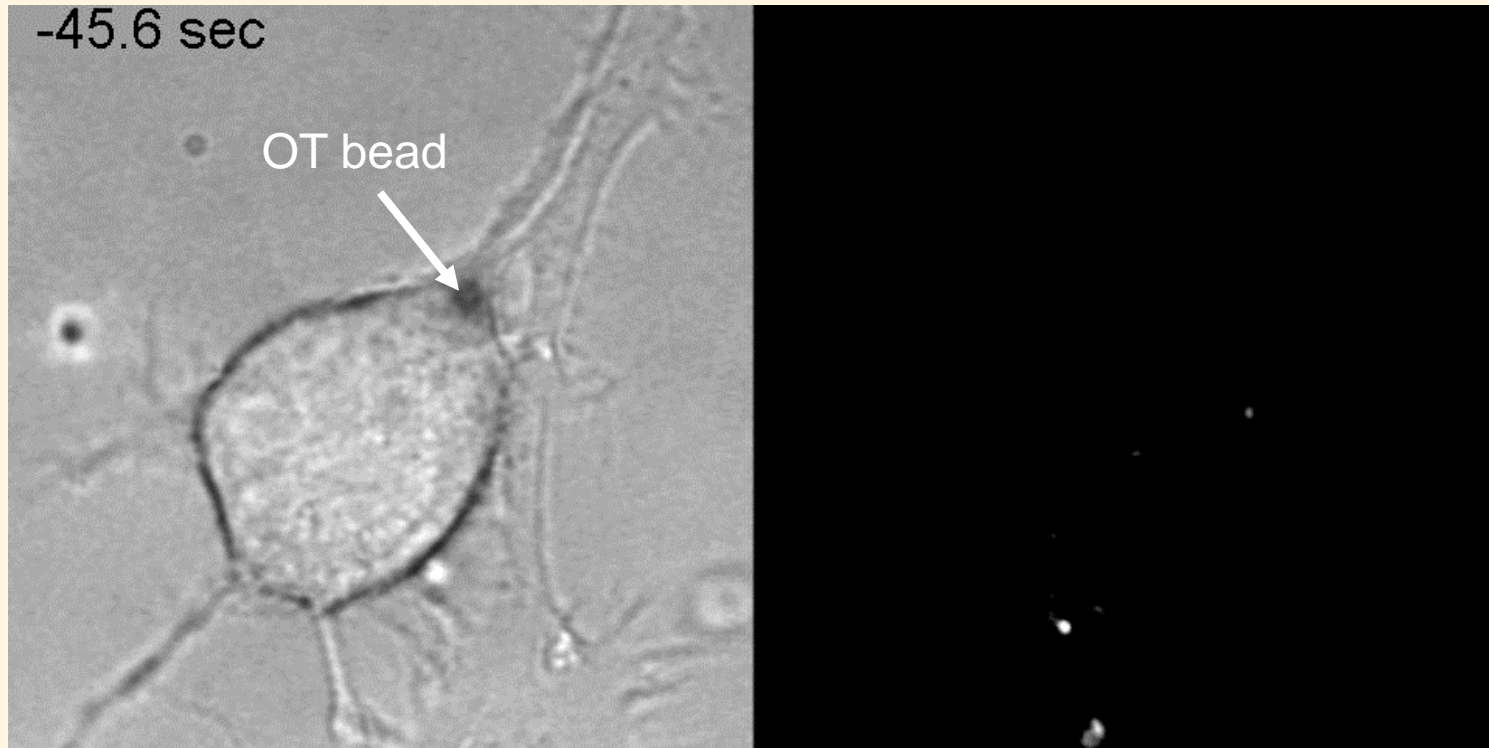

mouse neuroblastoma NG108-15

Ca²⁺ transients evoked by calibrated mechanical stimulations

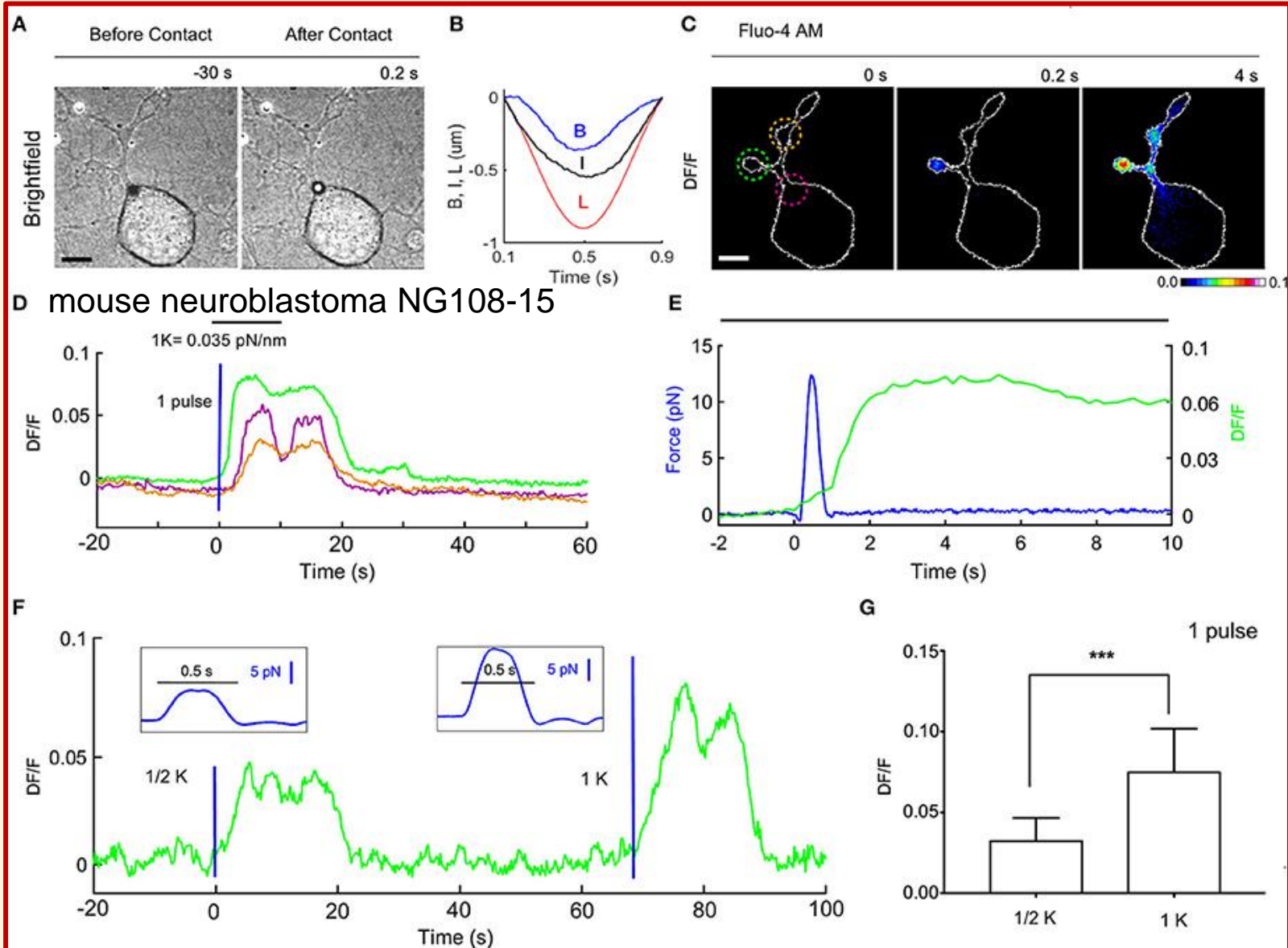

This work shows that very tiny forces 5–20 pN are able to trigger mechanosensitive channels and calcium intracellular response in neurons.

Mechanosensitivity in the rods of *Xenopus laevis*

Force is applied by an OT bead on the OS and IS (outer inner segment) of the rod

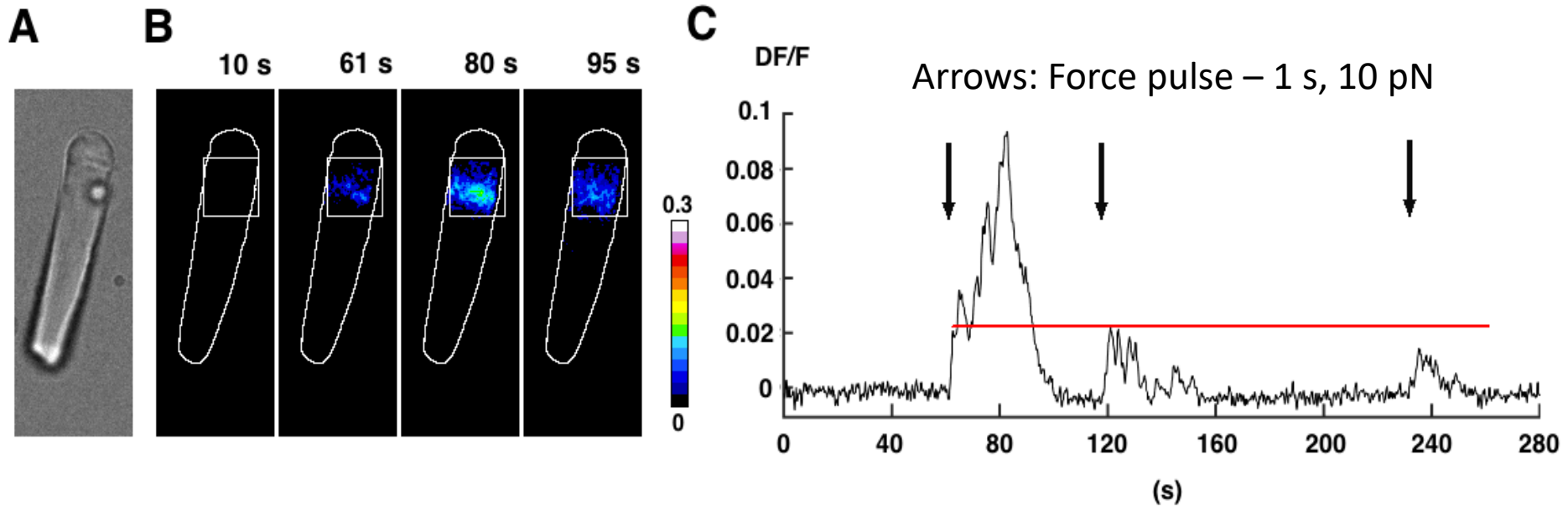

Ca²⁺ response of *X. laevis* rods to pN force pulses

Light-induced changes in rod OS length

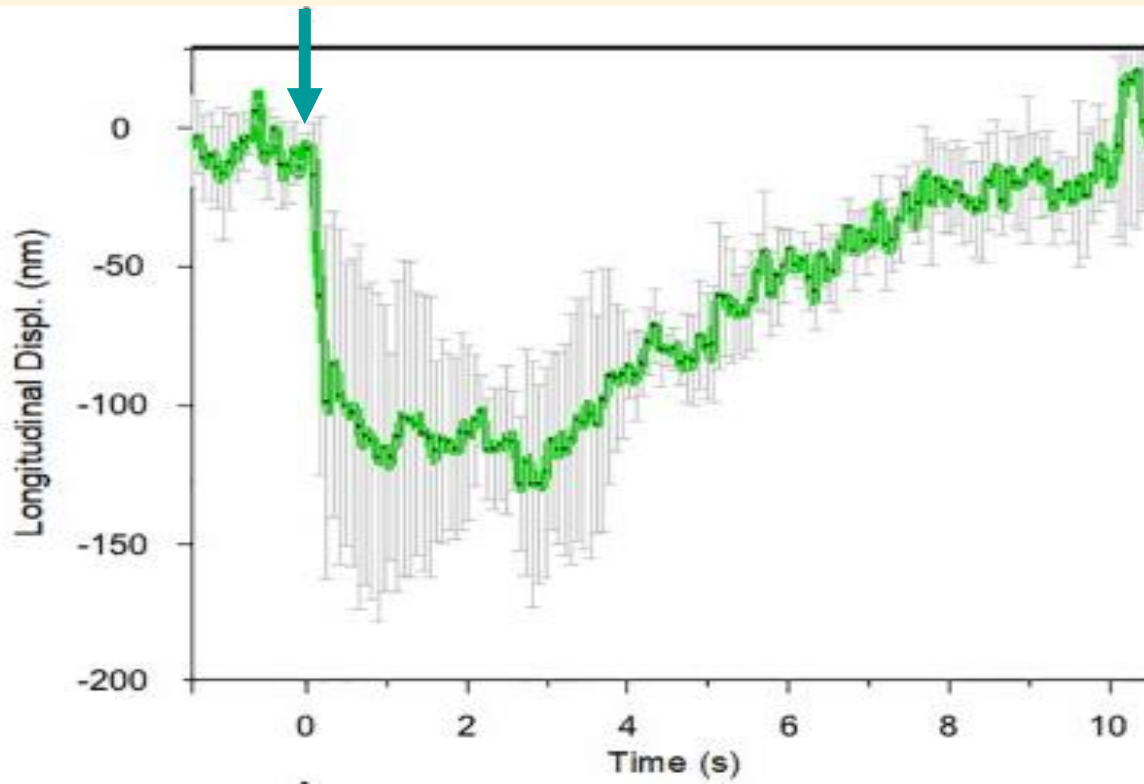
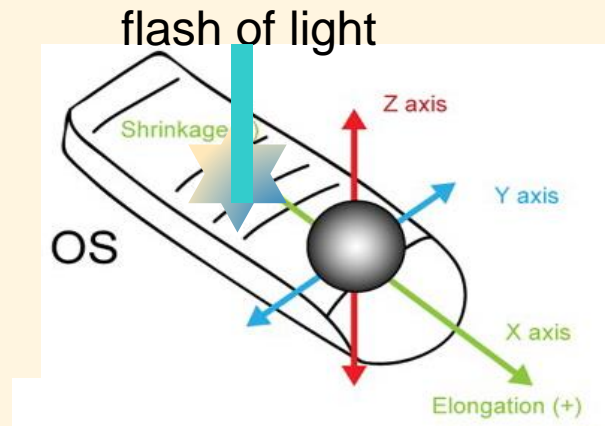
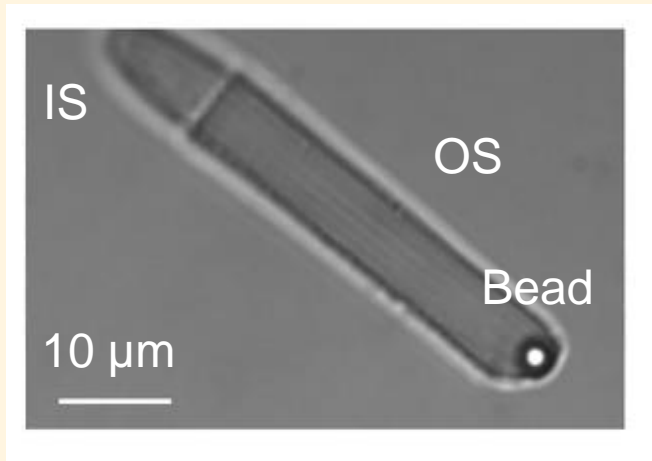

A bead is placed in contact with the tip and its displacement measured in response of a flash of light (491 nm)

Results:

- 1) mechanical stimulation—of the order of 10 pN—applied briefly to either the OS or IS evokes calcium transients;
- 2) bright flashes of light induce a rapid shortening of the OS;
- 3) inhibition of MSCs (TRPC1, Piezo 1, Piezo 2) decreases the duration of photoresponses to bright flashes

Bocchero U, et al. (2020) Mechanosensitivity is an essential component of phototransduction in vertebrate rods. *PLoS Biol* 18(7): e3000750.

<https://doi.org/10.1371/journal.pbio.3000750>