

# La fotochimica



*G. Ciamician*

**Giacomo Luigi  
Ciamician**

**Trieste 1857 –  
Bologna 1922**

Chissà che in avvenire non sia possibile mandare in effetto delle reazioni fotochimiche, come sarebbe la seguente: gli ultimi prodotti della combustione, i rifiuti che le fabbriche mandano nell'aria, sono l'anidride carbonica e il vapore acqueo. **Dato un opportuno catalizzatore** si dovrebbe potere, con la partecipazione dell'energia solare, trasformarli in metano ed ossigeno i quali, bruciando, ridarebbero, naturalmente, in forma di calore tutta l'energia acquistata dal sole. Quando un tale sogno fosse realizzato le industrie sarebbero ricondotte ad un ciclo perfetto, a macchine che produrrebbero lavoro colla forza della luce del giorno, che non costa nulla e non paga tasse!

*(Giacomo Luigi Ciamician)*

**Impariamo a imitare la natura e a fare come le piante, piuttosto che fare concorrenza alle piante con l'industria chimica fondata sul "catrame".**

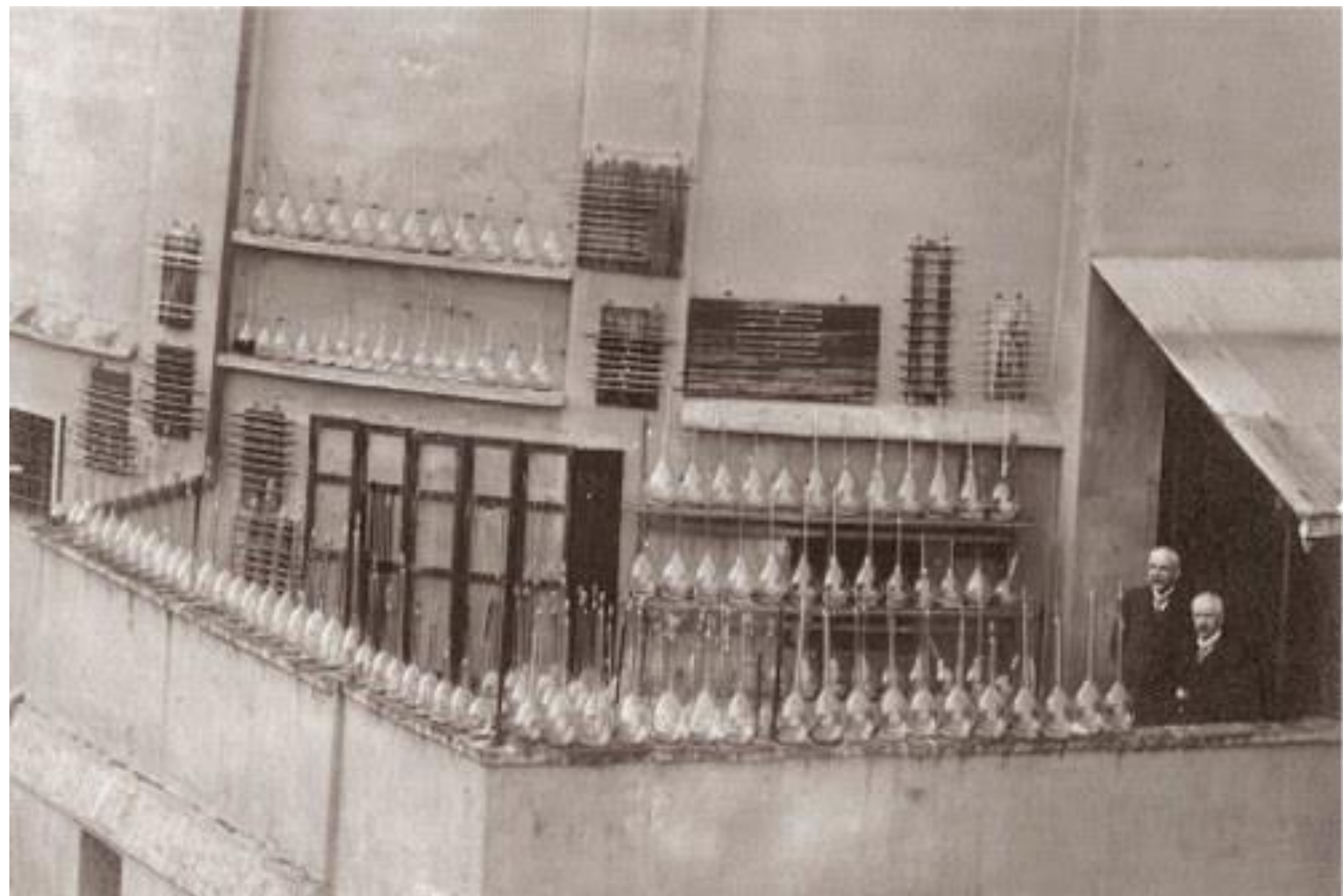

# SCIENCE

FRIDAY, SEPTEMBER 27, 1912

## CONTENTS

<i>The Photochemistry of the Future: PROFESSOR GIACOMO CIAMICIAN</i> .....	385
<i>The First International Eugenics Congress: PROFESSOR RAYMOND PEARL</i> .....	395
<i>Industrial Education in the Philippines</i> ....	396
<i>Graduates from American Colleges and Universities</i> .....	397
<i>The Harpswell Laboratory</i> .....	397
<i>Scientific Notes and News</i> .....	398
<i>University and Educational News</i> .....	400
<i>Discussion and Correspondence:—</i>	
<i>The Policy of the Geological Survey: DR. GEO. OTIS SMITH. School Grades—to What Type of Distribution shall they conform? DR. A. P. WEISS</i> .....	401
<i>Scientific Books:—</i>	
<i>Colman on Nature's Harmonic Unity: PROFESSOR ARNOLD EMCH. Case's Revision of the Amphibia and Pisces of the Permian of North America: DR. MAURICE G. MEHL</i> ....	407
<i>Notes on Infectious Abortion in Cattle: DR. FRANK M. SURFACE</i> .....	409
<i>Special Articles:—</i>	
<i>The Effects of Alkaloids on the Development of Fish (Fundulus) Embryos: DR. J. F. MCCLENDON. On the Relationship between the Bilateral Asymmetry of the Unilocular Fruit and the Weight of the Seed which it produces: DR. J. ARTHUR HARRIS. Heat Conductivity of Crystals: DR. R. W. CLARK. Some Curious Cases of Selective Reflection in Ultra-violet Light: GUSTAVE MICHAUD</i> .....	412

MESS. intended for publication and books, etc., intended for review should be sent to the Editor of SCIENCE, Garrison-on-Hudson, N. Y.

## THE PHOTOCHEMISTRY OF THE FUTURE<sup>1</sup>

MODERN civilization is the daughter of coal, for this offers to mankind the solar energy in its most concentrated form; that is, in a form in which it has been accumulated in a long series of centuries. Modern man uses it with increasing eagerness and thoughtless prodigality for the conquest of the world and, like the mythical gold of the Rhine, coal is to-day the greatest source of energy and wealth.

The earth still holds enormous quantities of it, but coal is not inexhaustible. The problem of the future begins to interest us, and a proof of this may be seen in the fact that the subject was treated last year almost at the same time by Sir William Ramsay before the British Association for the Advancement of Science at Portsmouth and by Professor Carl Engler before the *Versammlung deutscher Naturforscher und Aerzte* at Karlsruhe. According to the calculations of Professor Engler Europe possesses to-day about 700 billion tons of coal and America about as much; to this must be added the coal of the unknown parts of Asia. The supply is enormous but, with increasing consumption, the mining of coal becomes more expensive on account of the greater depth to which it is necessary to go. It must therefore be remembered that in some regions the deposits of coal may become practically useless long before their exhaustion.

Is fossil solar energy the only one that may be used in modern life and civilization? That is the question.

<sup>1</sup> General lecture before the International Congress of Applied Chemistry, New York, September 11, 1912.

# THE PHOTOCHEMISTRY OF THE FUTURE (1912)

GIACOMO CIAMICIAN (1857-1922)

(Translation supplied by the author)

*Modern civilization is the daughter of coal for this offers to mankind the solar energy in its most concentrated form: that is in a form in which it has been accumulated in a long series of centuries.*

*And if in a distant future the supply of coal becomes completely exhausted, civilization will not be checked by that, for life and civilization will continue as long as the sun shines! If our black and nervous civilization, based on coal, shall be followed by a quieter civilization based on the utilization of solar energy, that will not be harmful to progress and to human happiness.*

*The photochemistry of the future should not however be postponed to such distant times; I believe that industry will do well in using from this every day all the energies that nature puts at its disposal. So far, human civilization has made use almost exclusively of fossil solar energy. Would it not be advantageous to make better use of radiant energy?*

# Fotochimica e fotofisica

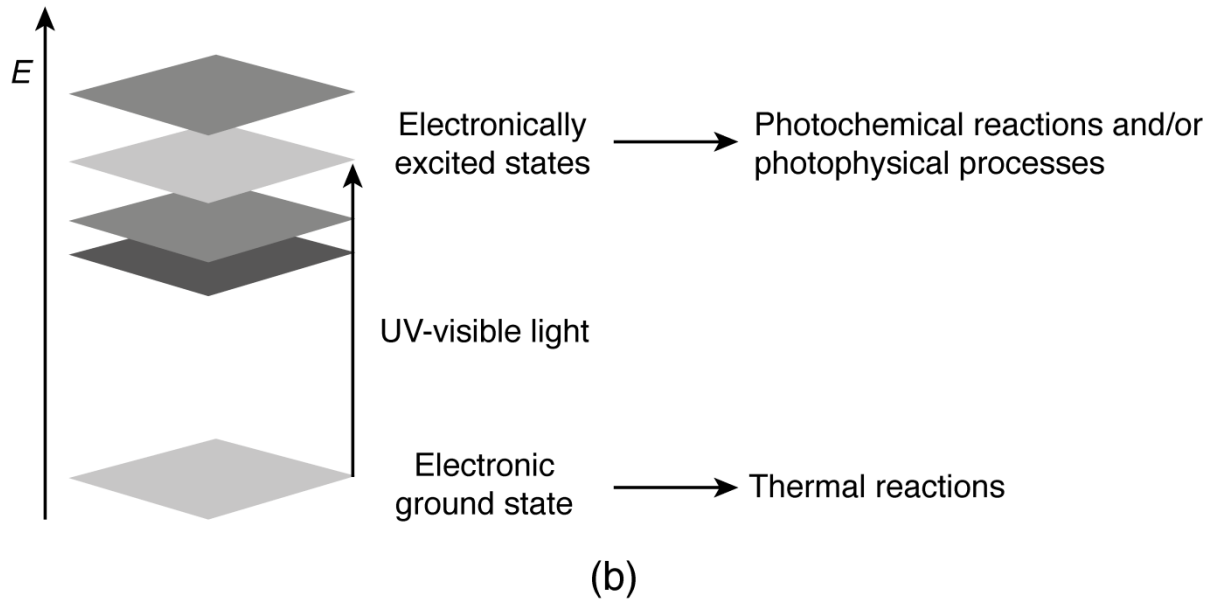
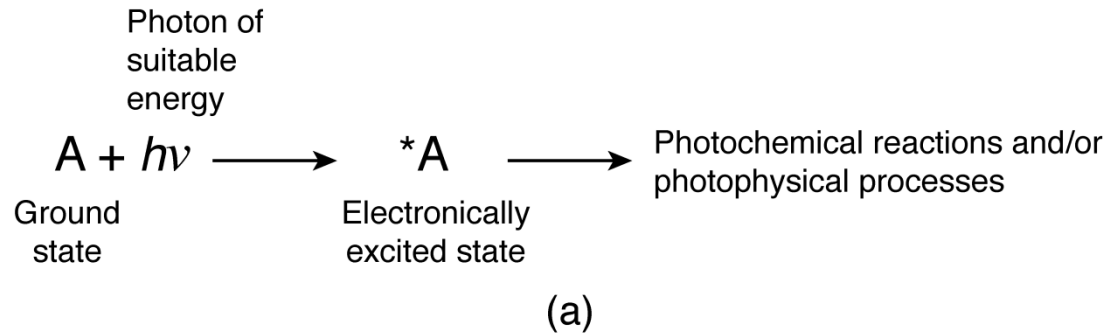

# Energie coinvolte

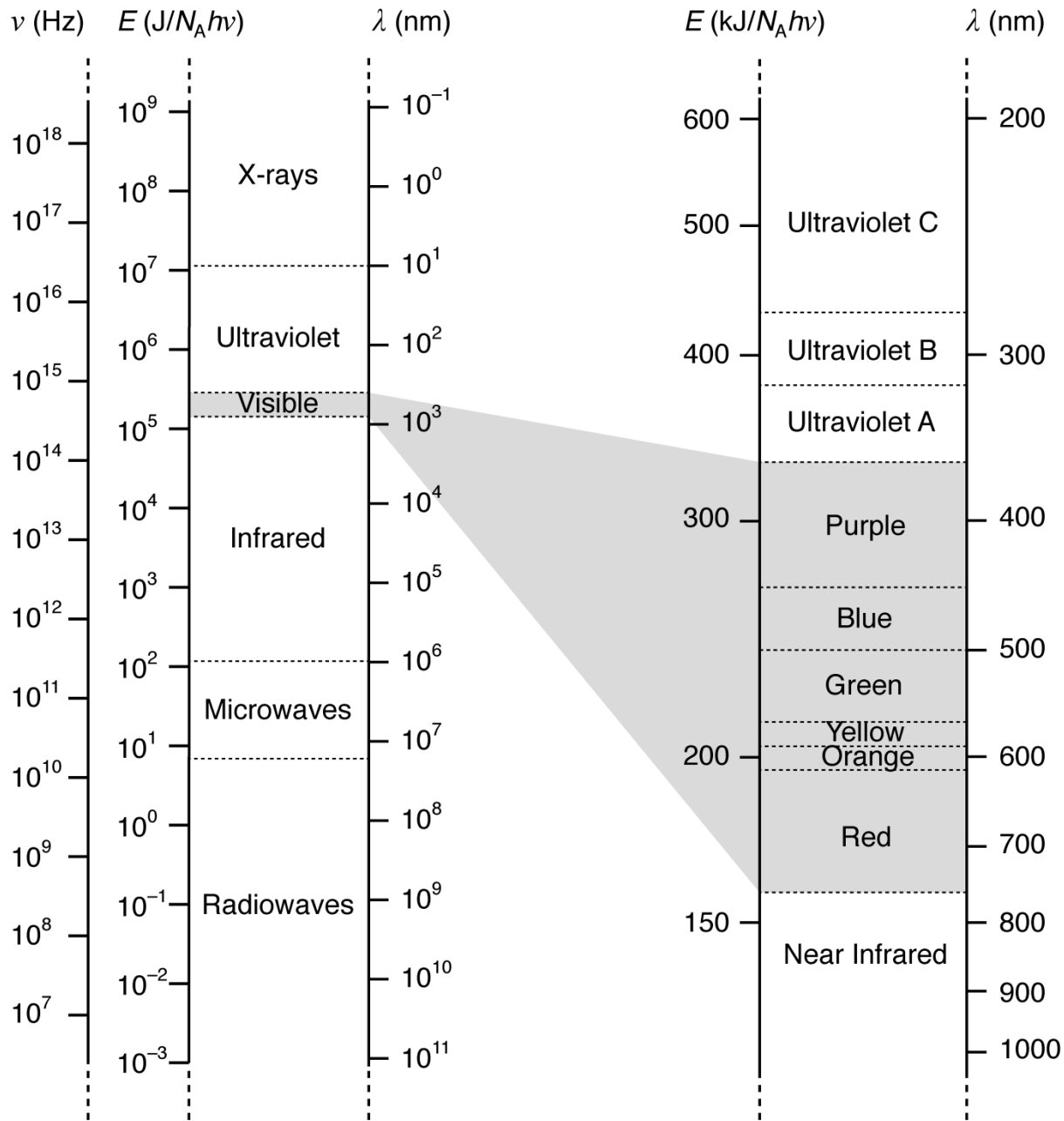

# *Energie coinvolte*

Il paradigma più semplice e più comune:

*Una molecola assorbe un fotone.*

Energia di **un FOTONE** a **200 nm** =  $9.95 \cdot 10^{-19}$  J

Energia di **un FOTONE** a **1000 nm** =  $1.99 \cdot 10^{-19}$  J

Una mole di fotoni = un **EINSTEIN**

Energia di **un EINSTEIN** a **200 nm** = 599 kJ (143 kcal)

Energia di **un EINSTEIN** a **1000 nm** = 119.8 kJ (28.6 kcal)

# *Aspetti quantitativi*

**La legge di Grotthus-Draper:**

***Solo la luce assorbita è efficace nel produrre un cambiamento fotochimico.***

**La legge di Lambert - Beer:**  $A = \log (I_0/I) = \epsilon bc$



# Aspetti quantitativi

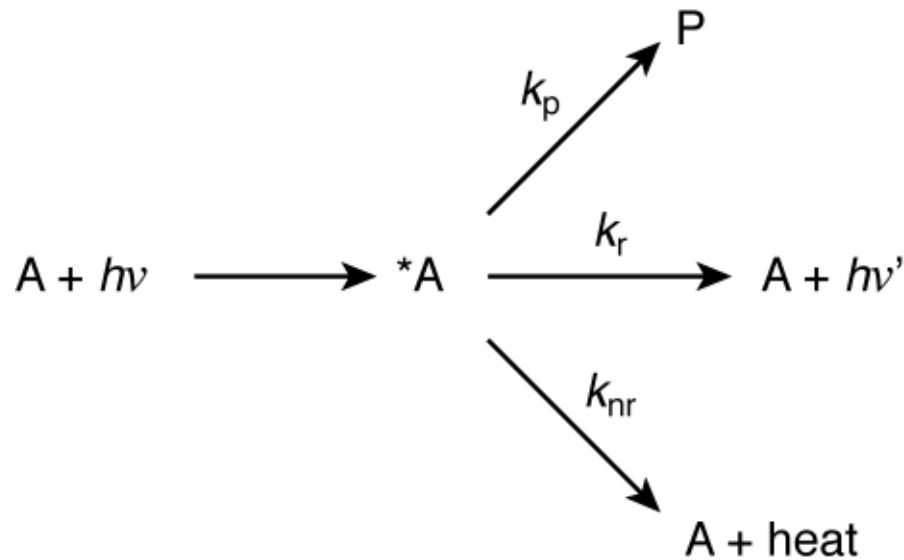

## Processo primario

Photoreaction  
(chemical reaction)

Luminescence  
(radiative deactivation)

Degradation to heat  
(non radiative deactivation)

**Tempo di vita dello stato eccitato:**

$$\tau(*A) = \frac{1}{k_p + k_r + k_{nr}} = \frac{1}{\sum_j k_j}$$

**Efficienza di un processo:**

$$\eta_i(*A) = \frac{k_i}{\sum_j k_j} = k_i \tau(*A)$$

# Aspetti quantitativi

**Resa quantica di un processo:**

$$\Phi_i = \frac{\text{Number of molecules undergoing that process}}{\text{Number of photons absorbed by the reactant}}$$

**In condizioni di stato stazionario:**

$$\frac{d[*A]}{dt} = I_m - k_p[*A] - k_r[*A] - k_{nr}[*A] = 0$$

**Resa quantica del processo p:**

$$\Phi_p = \frac{k_p[*A]}{I_m} = \frac{k_p}{k_p + k_r + k_{nr}}$$

**Resa quantica del processo i:**

$$\Phi_i = \frac{k_i}{\sum_j k_j} \quad \longrightarrow \quad \Phi_i = k_i \tau(*A) = \eta_i(*A)$$

# Processi fotofisici

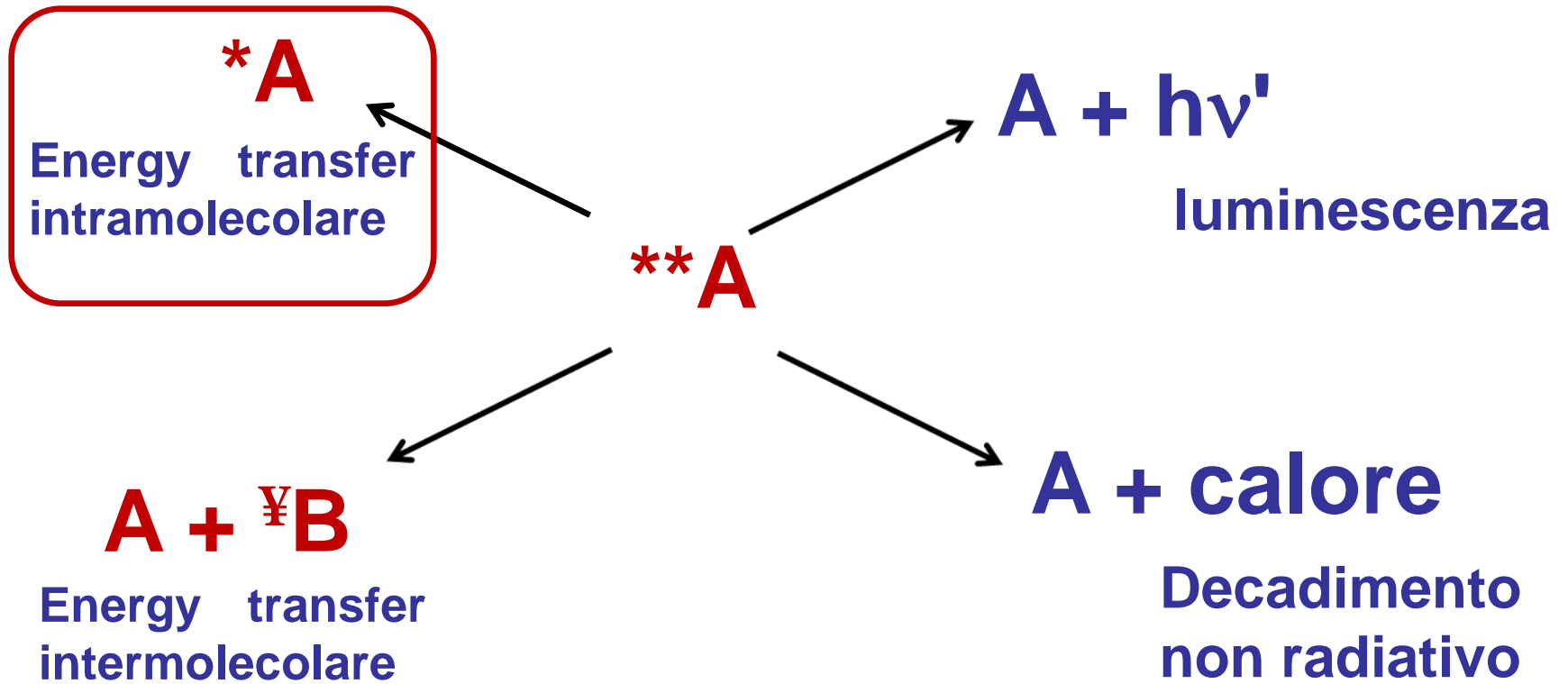

# Rappresentazione schematica dell'insieme dei processi fotofisici e fotochimici

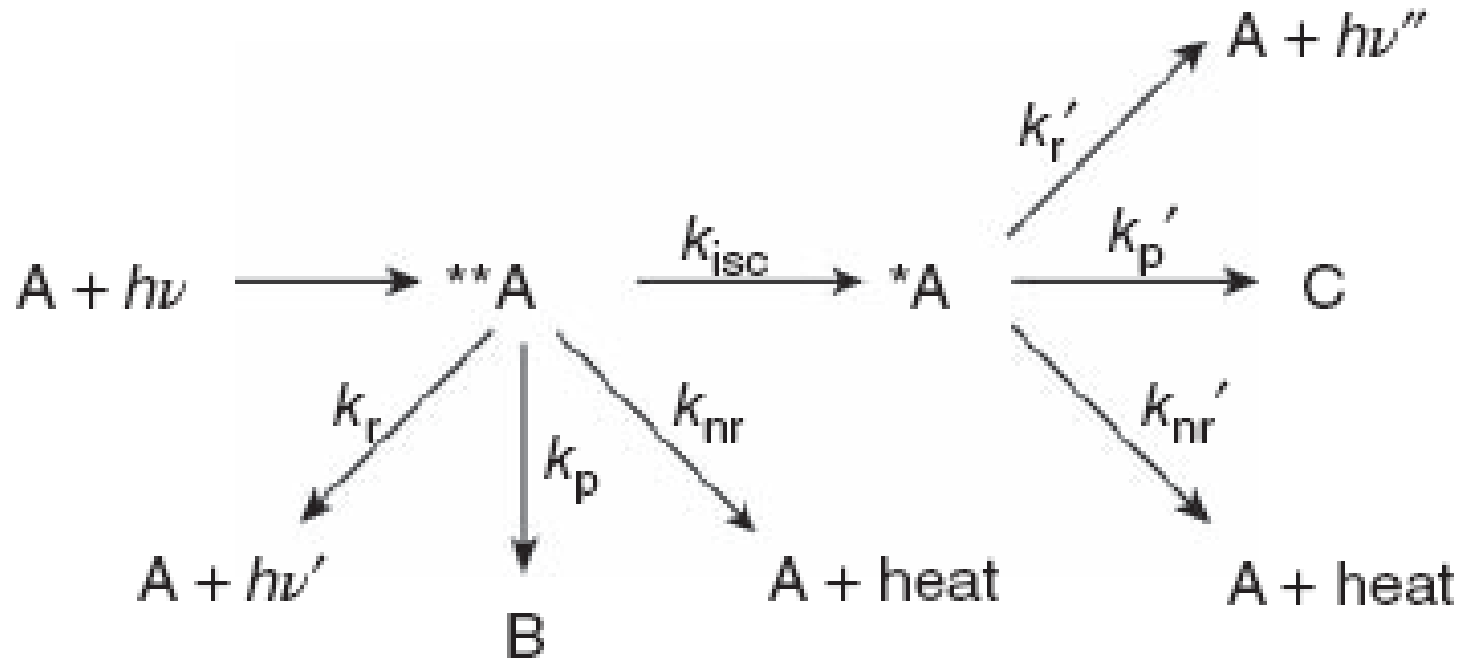

# Il Diagramma di Jablonski

S = stato di singoletto

T = stato di tripletto

i.c. = internal conversion

i.s.c. = intersystem crossing

v.r. = rilassamento vibrazionale

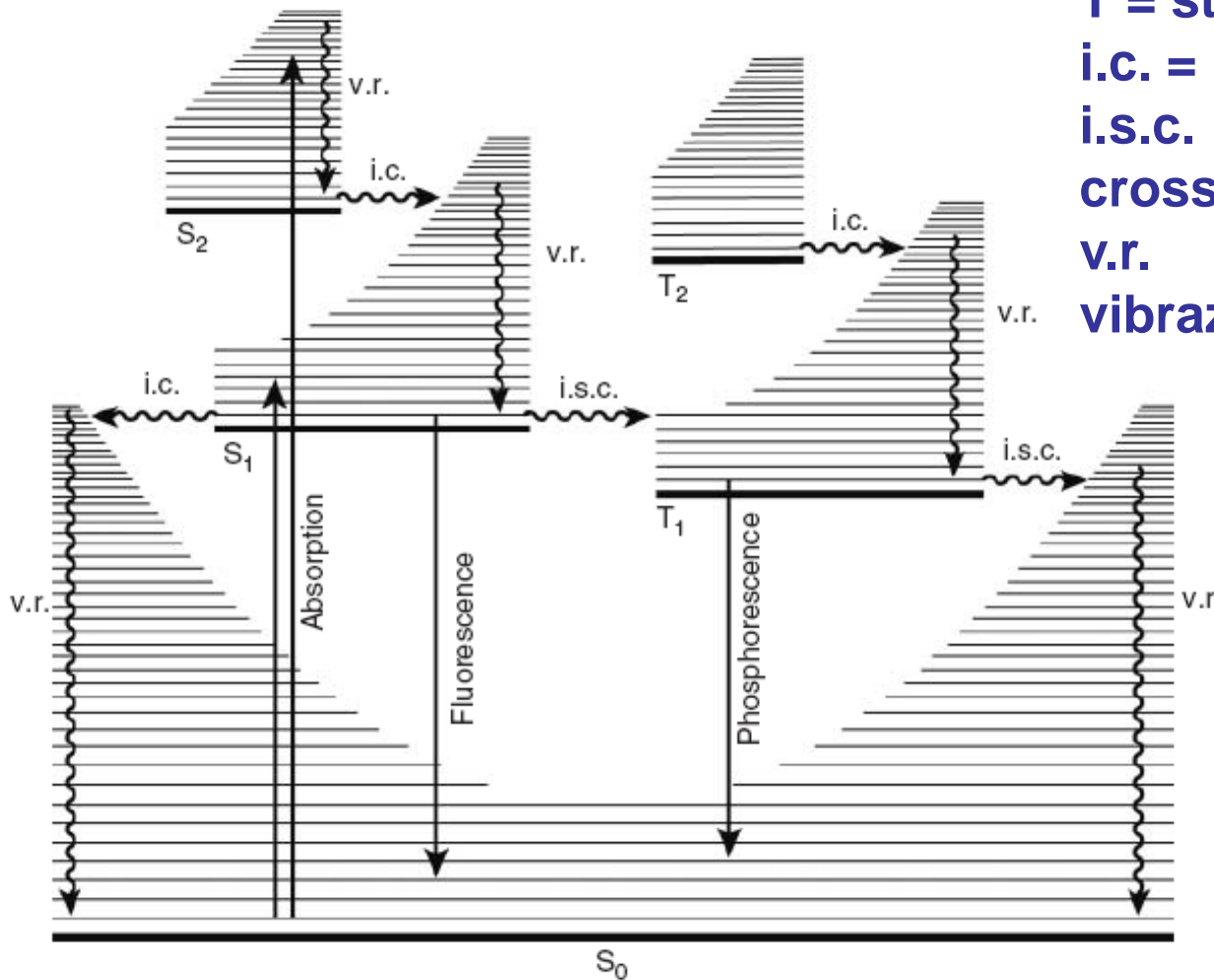

# *Transizioni elettroniche possibili per complessi ottaedrici $ML_6$*

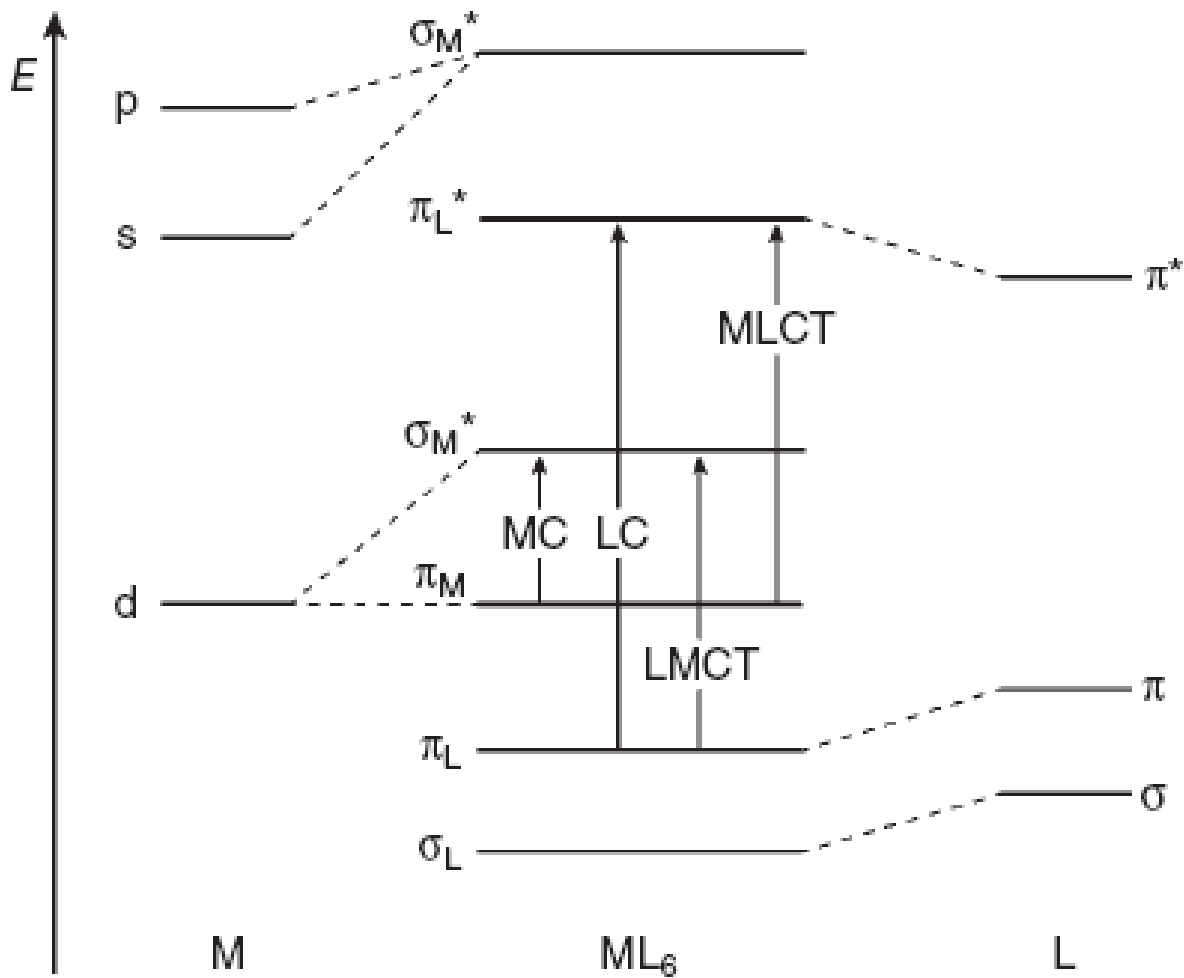

# Il Diagramma di Tanabe-Sugano di $[\text{Cr}(\text{en})_3]^{3+}$

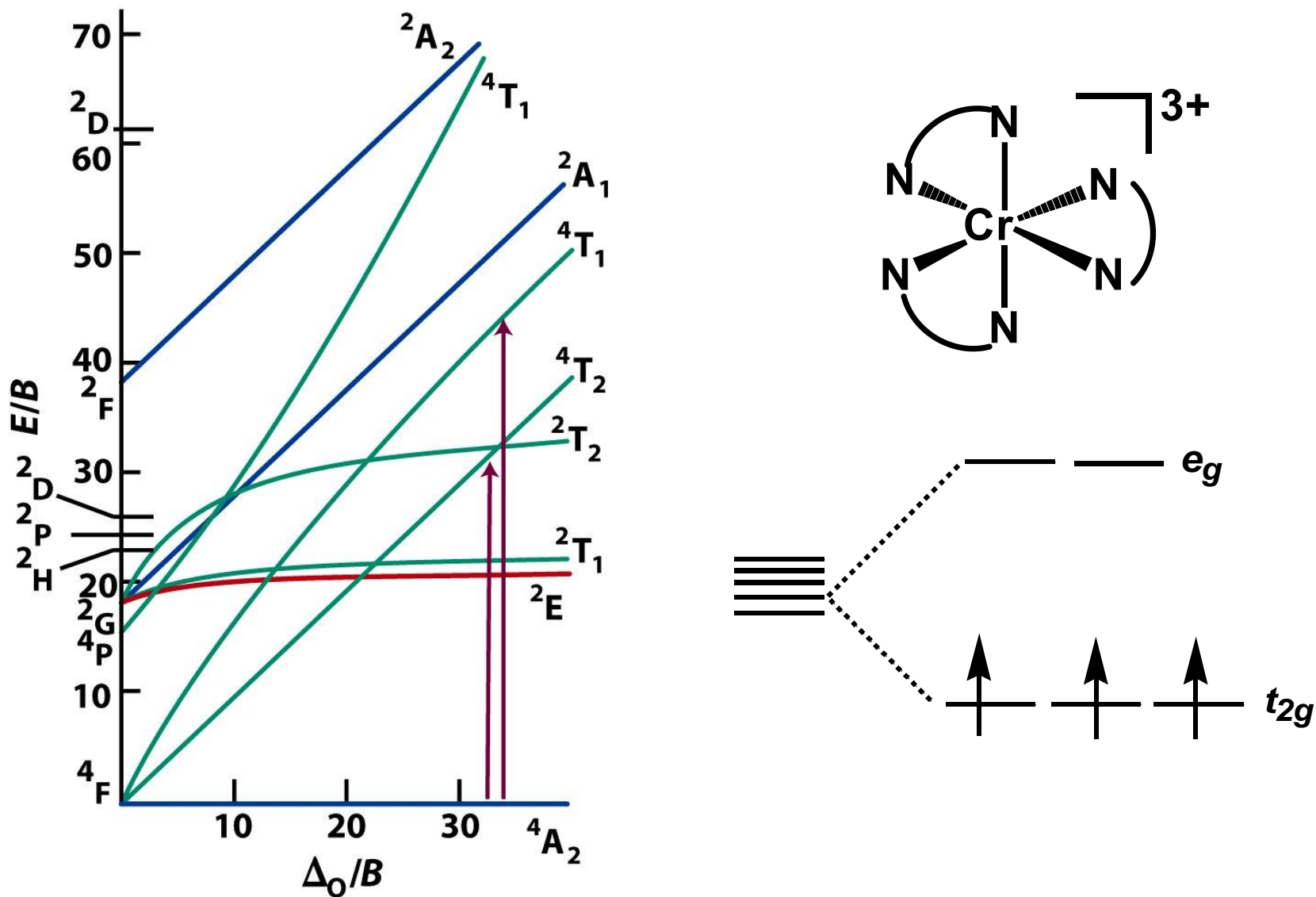
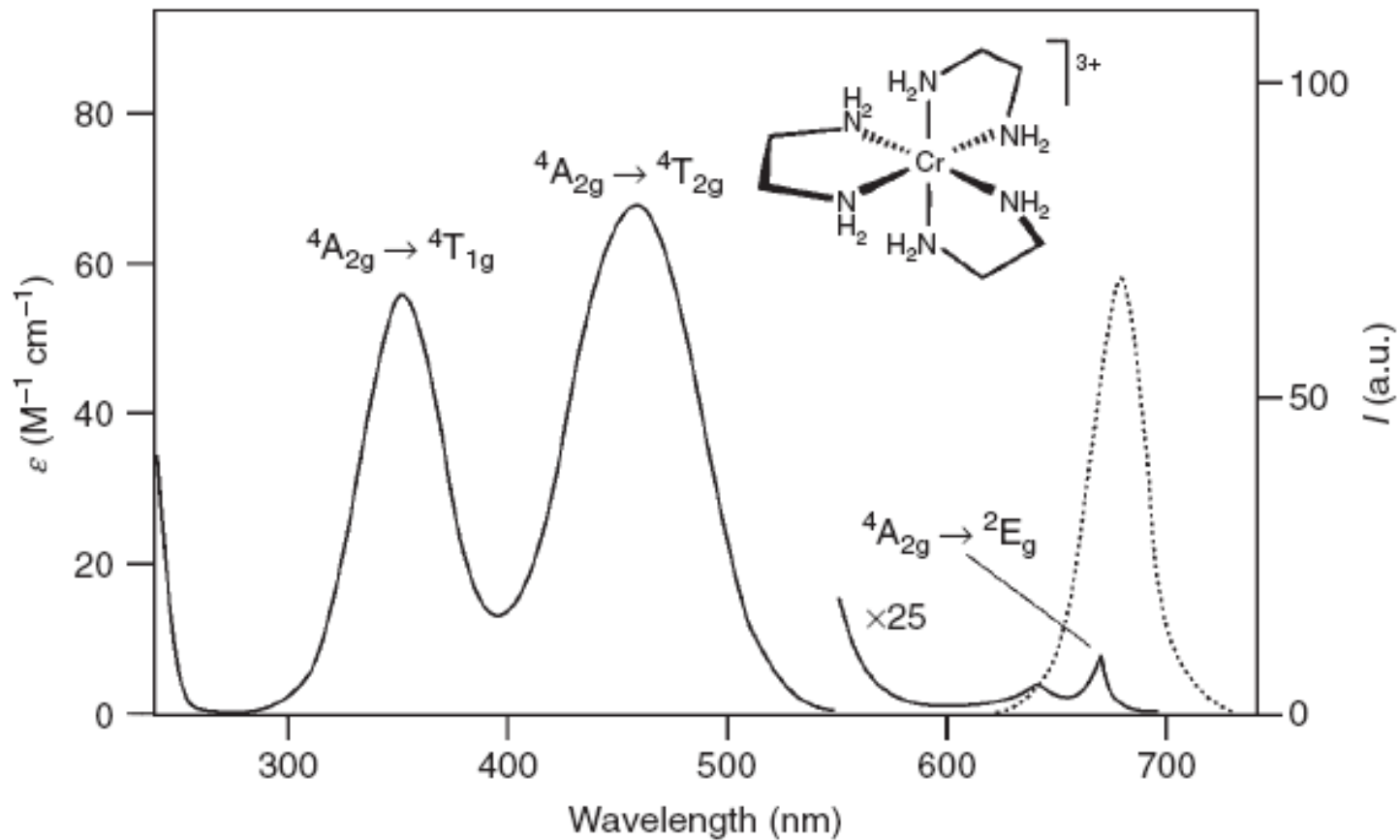

Figure 19-27

Shriver & Atkins Inorganic Chemistry, Fourth Edition

© 2006 by D. F. Shriver, P. W. Atkins, T. L. Overton, J. P. Rourke, M. T. Weller, and F. A. Armstrong

# Spettro in assorbimento e in emissione di $[\text{Cr}(\text{en})_3]^{3+}$





# Diagramma di Jablonski di $[\text{Cr}(\text{en})_3]^{3+}$

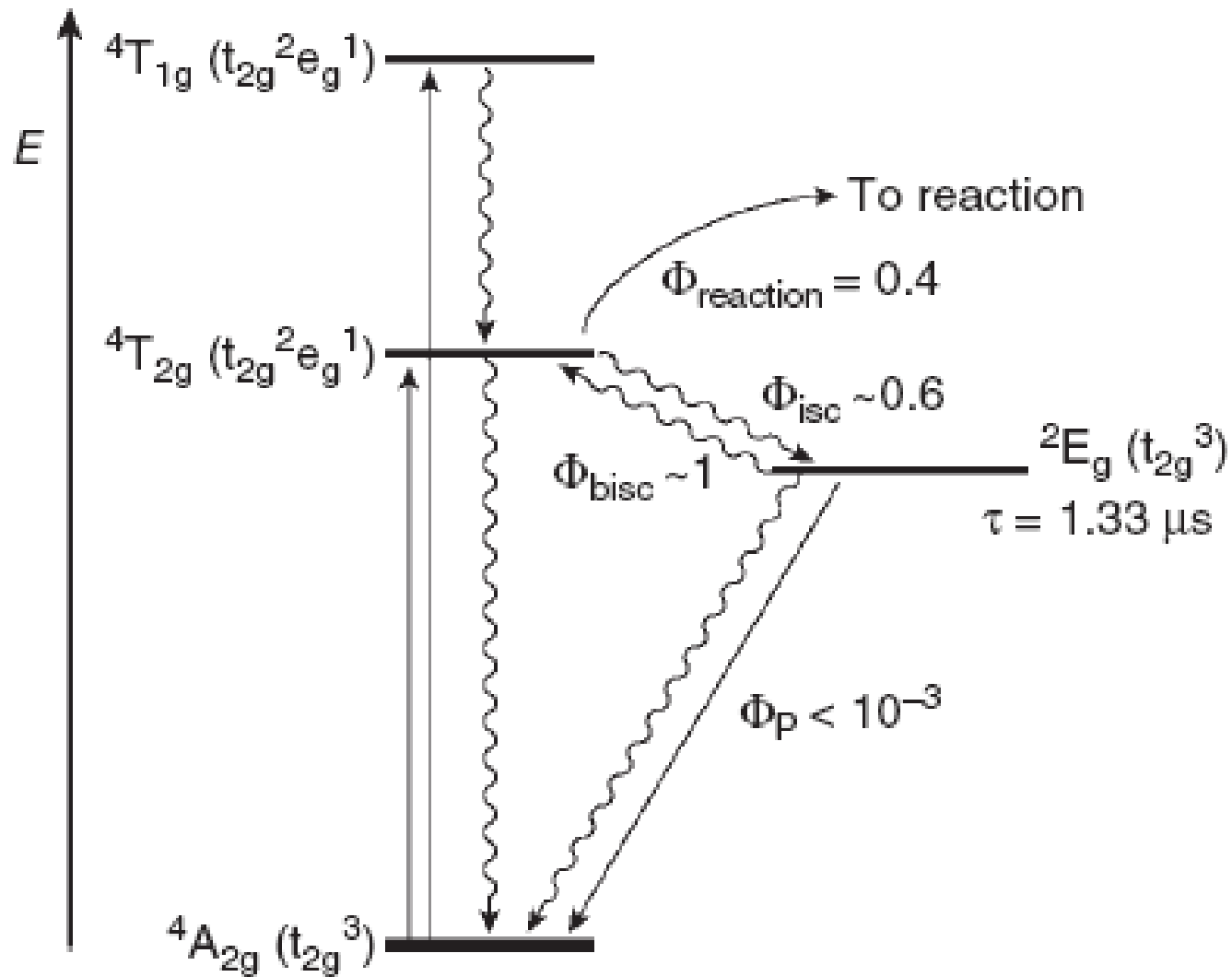

# Diagramma degli orbitali di frontiera per $[Ru(bpy)_3]^{2+}$

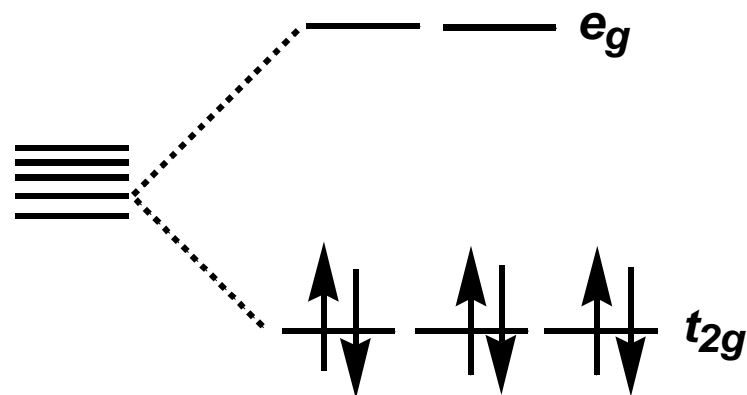
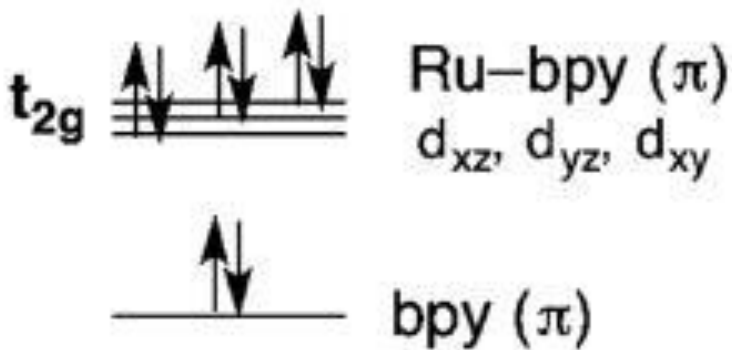
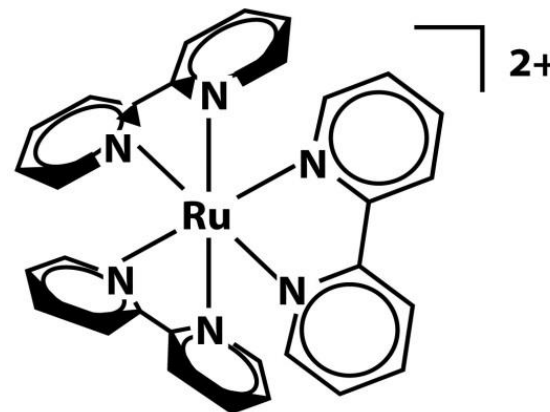
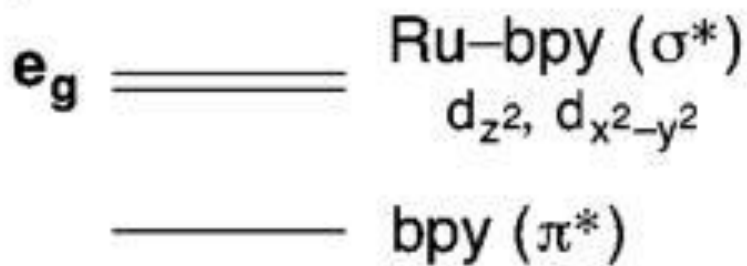

# *Spettro di assorbimento e in emissione di $[Ru(bpy)_3]^{2+}$*

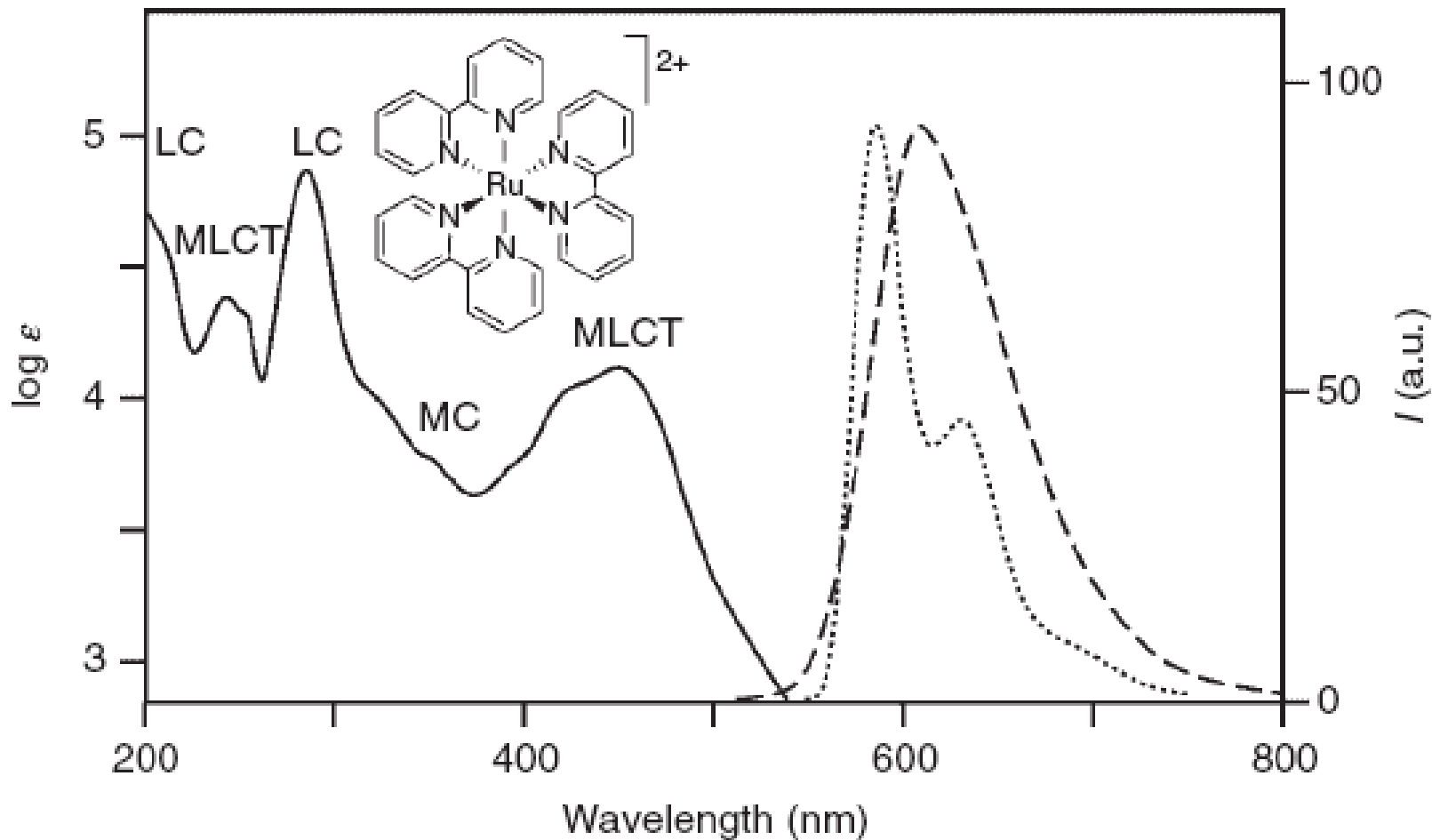

# Diagramma di Jablonski di $[Ru(bpy)_3]^{2+}$

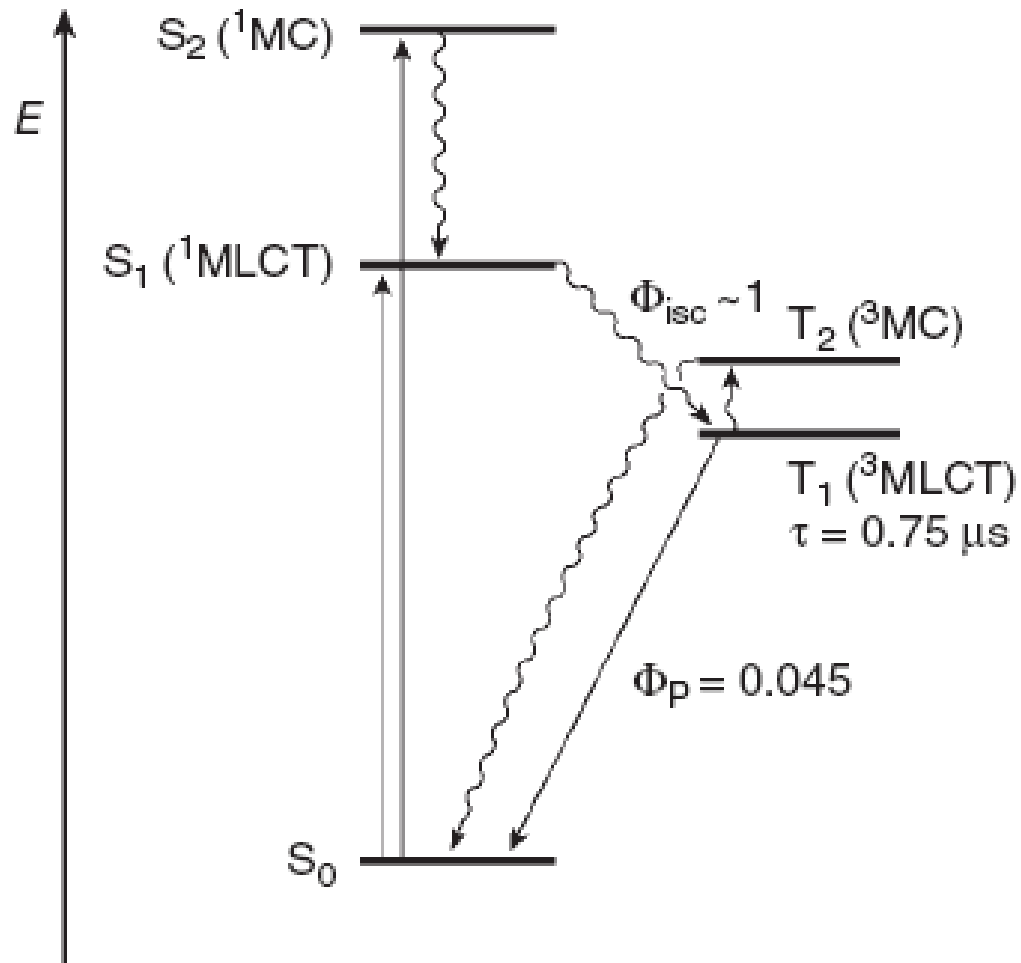

# *Lo stato eccitato come una **nuova molecola***

**Proprietà differenti** tra stato fondamentale e stato eccitato:

- ✓ Tempo di vita;
- ✓ Energia;
- ✓ Geometria;
- ✓ Momento di dipolo;
- ✓ Trasferimento di elettroni;
- ✓ Trasferimento di protoni;
- ✓ Aggregazione.

# *Tempo di vita*

**Tempo di vita** dello stato eccitato per processi con cinetica del primo ordine

$$\tau(^*A) = \frac{1}{k_p + k_r + k_{nr}} = \frac{1}{\sum_j k_j}$$

**$10^{-12}$  s – decine di s**

---

---

# *Energia*

**Energia** dello stato eccitato si intende la differenza di energia tra il livello vibrazionale più basso dello stato eccitato e il corrispondente nello stato fondamentale.

**$150 - 1250 \text{ kJ mol}^{-1} > E_{gs}$**

# Energia e cammini di reazione

## Aspetti cinetici

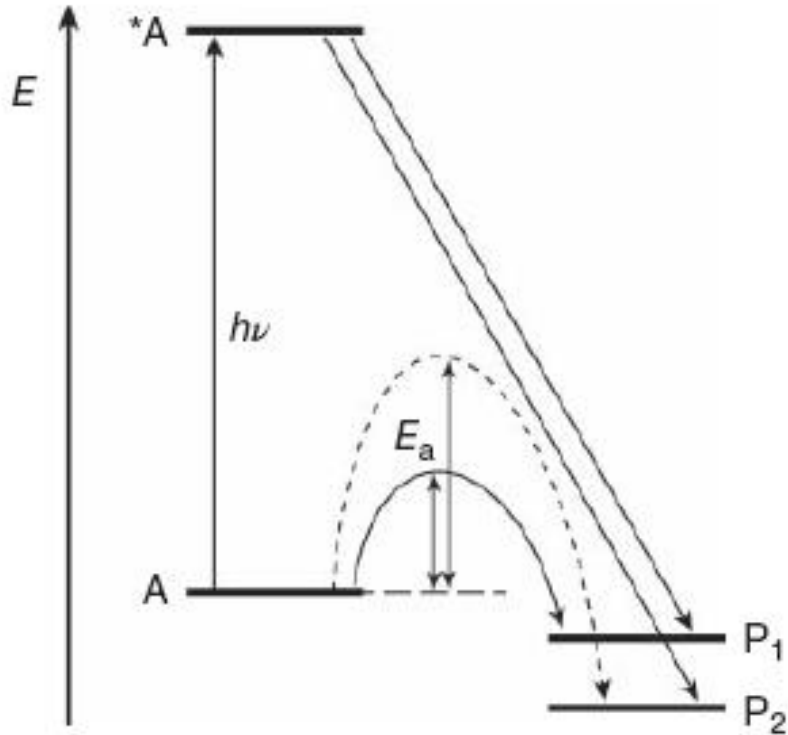

## Aspetti termodinamici

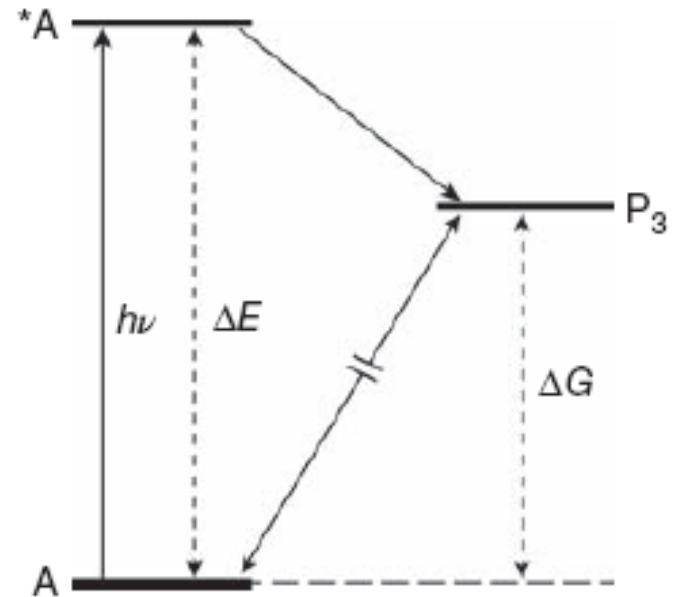

Nelle reazioni fotochimiche la **selettività** è assicurata dalle **peculiari proprietà elettroniche** dello stato eccitato.

# *Geometria*

Se la **configurazione elettronica** dello stato eccitato è significativamente **diversa** da quella dello stato fondamentale, allora è ragionevole attendersi che la **geometria** dello stato eccitato **sia diversa** da quella dello stato fondamentale.



# Geometria

Ground state

Excited state

H<sub>2</sub>O

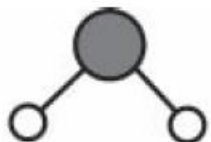

$^1A_1$   $\mu \neq 0$



$^3\Pi_u$   $\mu = 0$

CO<sub>2</sub>

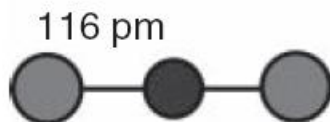

$^1\Sigma_g$   $\mu = 0$

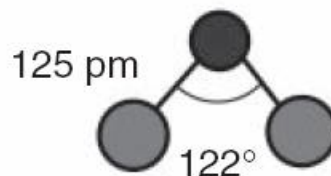

$^1B_2$   $\mu \neq 0$

NH<sub>3</sub>

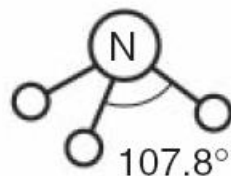

$^1A_1$

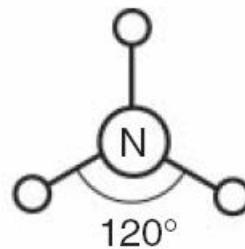

$^1A_2''$

CH<sub>2</sub>O

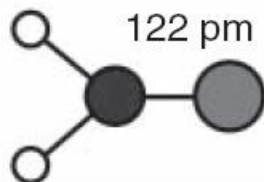

$^1A_1$   $\mu = 2.3$  D

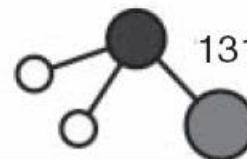

131 pm  $\mu = 1.3$  D

$^3A''$  ( $n \rightarrow \pi^*$ )

# Momento di dipolo

Il momento di dipolo nello stato elettronico eccitato può essere diverso che nello stato fondamentale, come conseguenza sia della variazione di geometria, che della semplice redistribuzione degli elettroni.

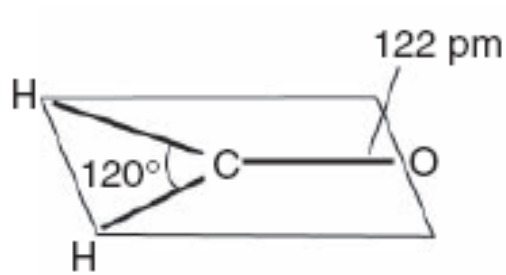

$^1A_1$

(a) Planar,  $\mu = 2.3$  D

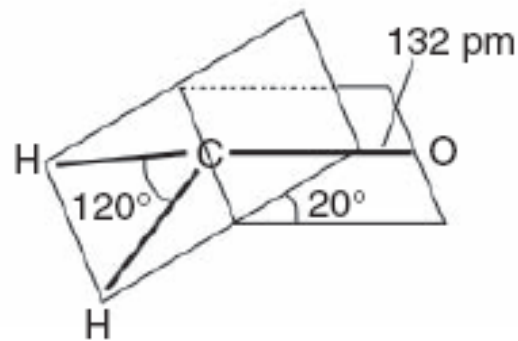

$^1A_2 (n, \pi^*)$

(b) Bent,  $\mu = 1.6$  D

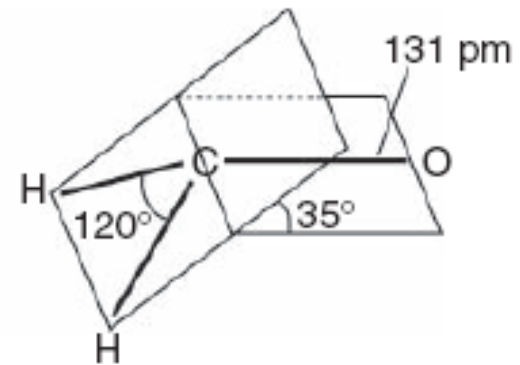

$^3A_2 (n, \pi^*)$

(c) Bent,  $\mu = 1.3$  D

# La formaldeide

CH<sub>2</sub>O

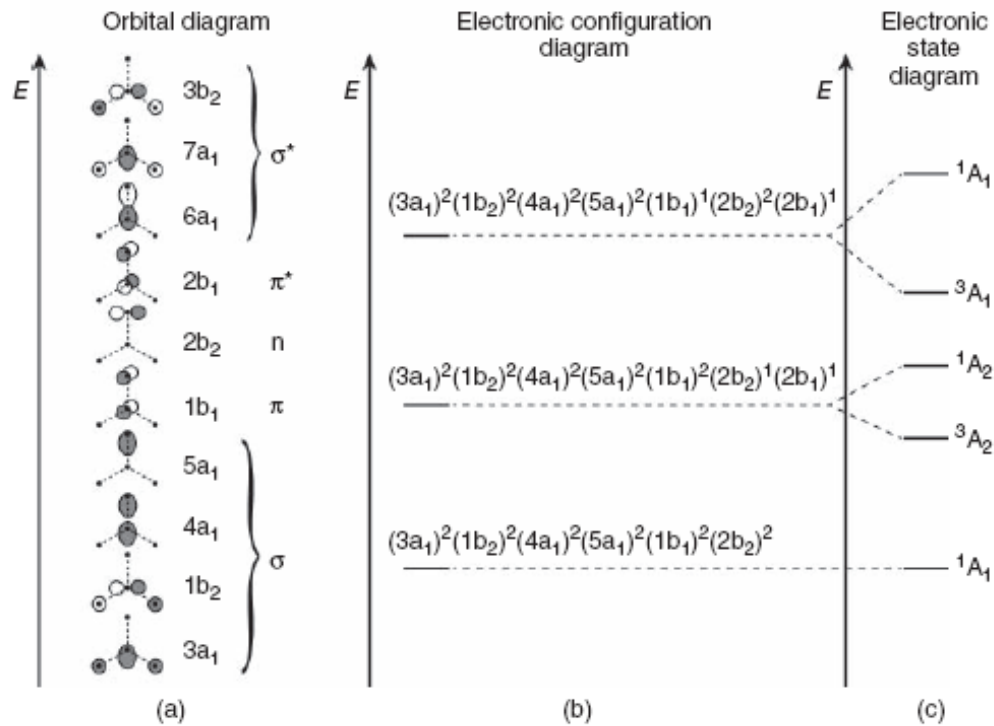
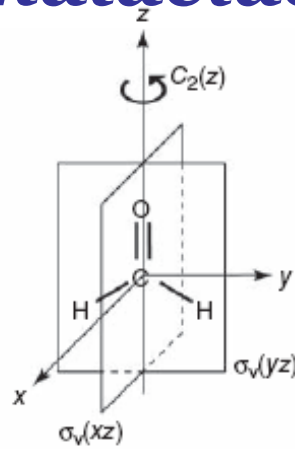

# Trasferimento di elettroni

Le molecole nel loro **stato elettronico eccitato** sono sia dei **migliori donatori** che dei **migliori accettori di elettroni** che la stessa specie nello **stato fondamentale**.

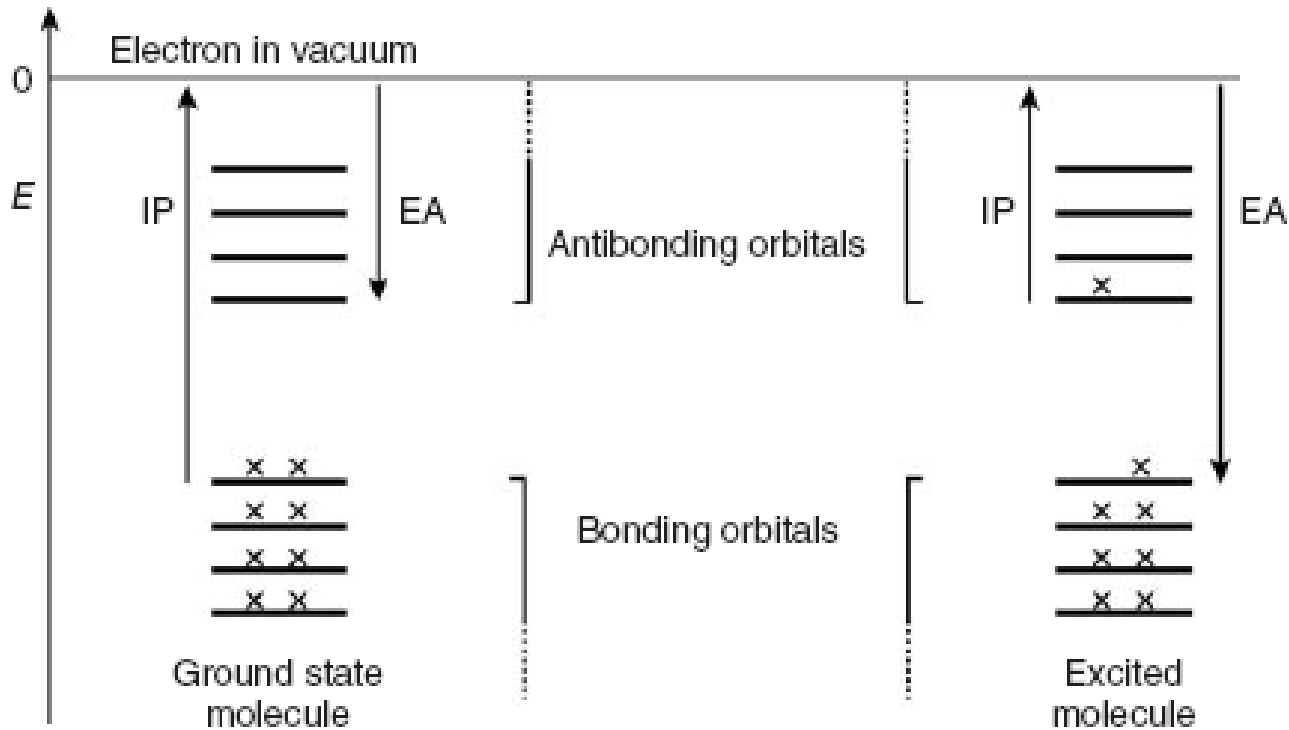

# Elettrochimica dello stato eccitato

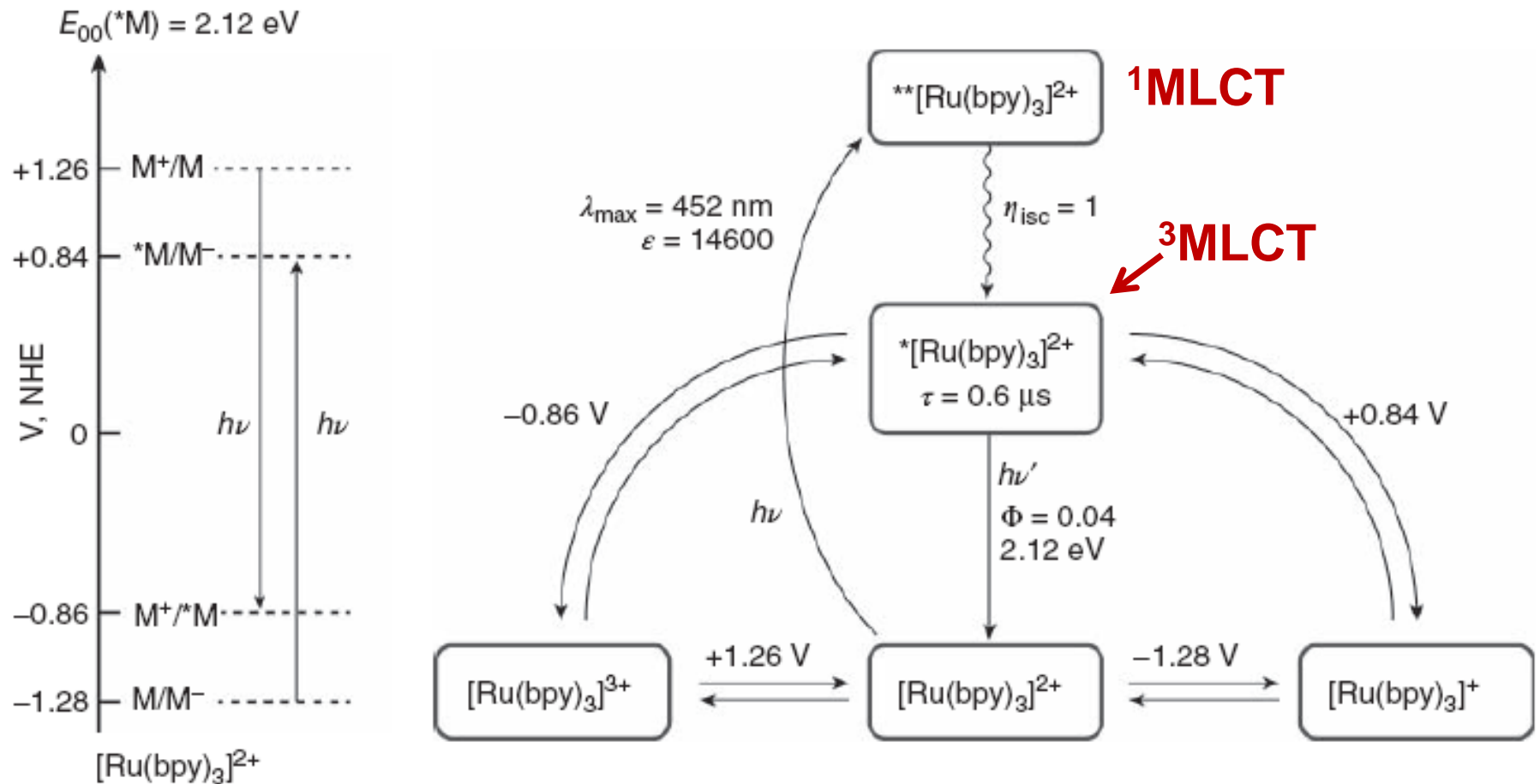

agente riducente migliore  
per 2.12 V (1.26 V + 0.86 V)

agente ossidante migliore  
per 2.12 V (0.84 V + 1.28 V)

## Processi possibili per lo stato eccitato

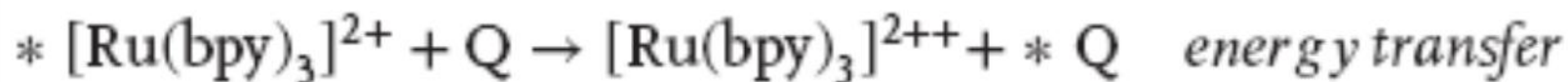

agente **ossidante** migliore per 2.12 V (0.84 V + 1.28 V)

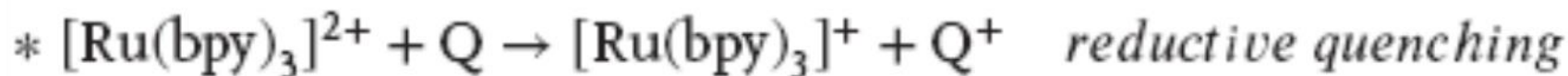

agente **riducente** migliore per 2.12 V (1.26 V + 0.86 V)

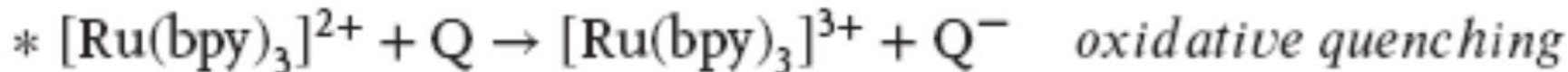

# Trasferimento di protoni

La redistribuzione di carica dovuta all'assorbimento di luce influenza il comportamento acido-base di una molecola.

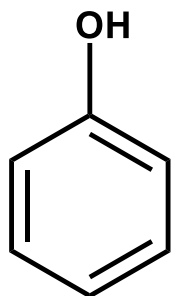

$$pK_a(S_0) = 10$$

$$pK_a(S_1) = 4$$

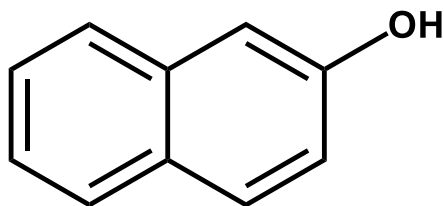

$$pK_a(S_0) = 9.5$$

$$pK_a(S_1) = 3.1$$

# Trasferimento di protoni

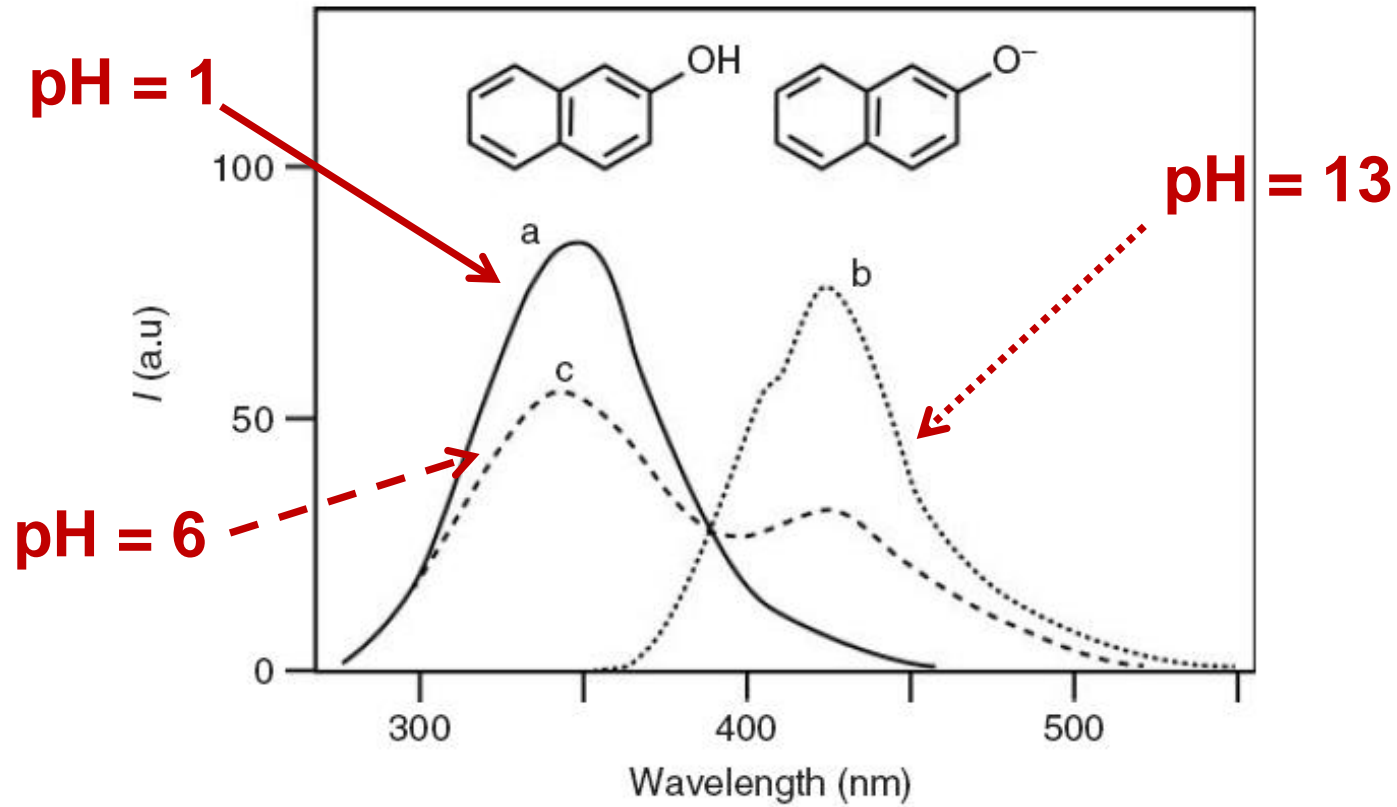

## Reazione adiabatica

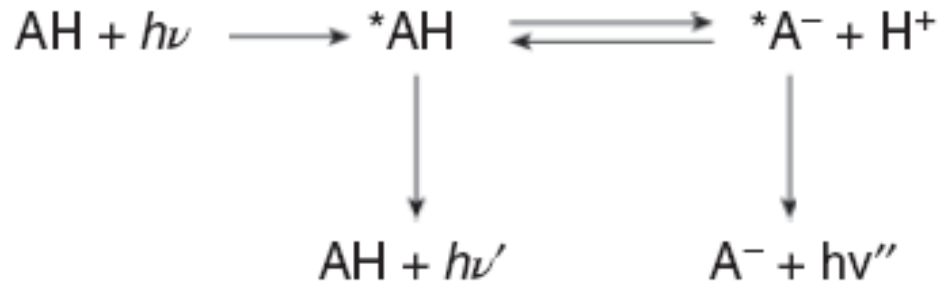



# *Eccimeri ed ecciplessi*

**Eccimero:**  $*A + A \rightarrow *[A - A]$  *excimer*



**Ecciplesso:**  $*A + B \rightarrow *[A - B]$  *exciplex*



# *Eccimeri ed ecciplessi*

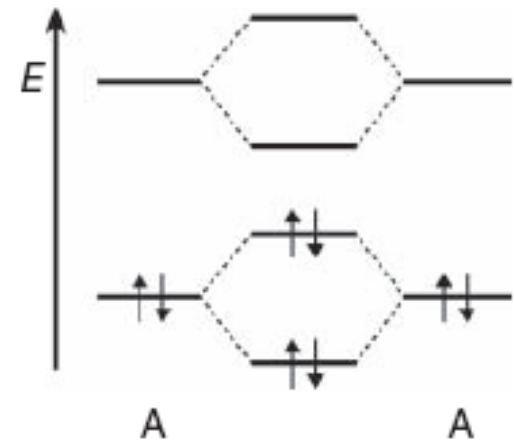
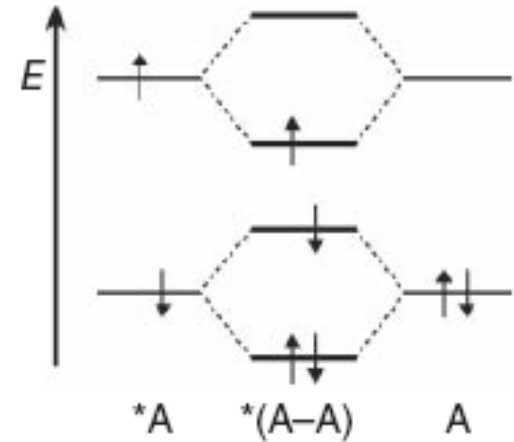
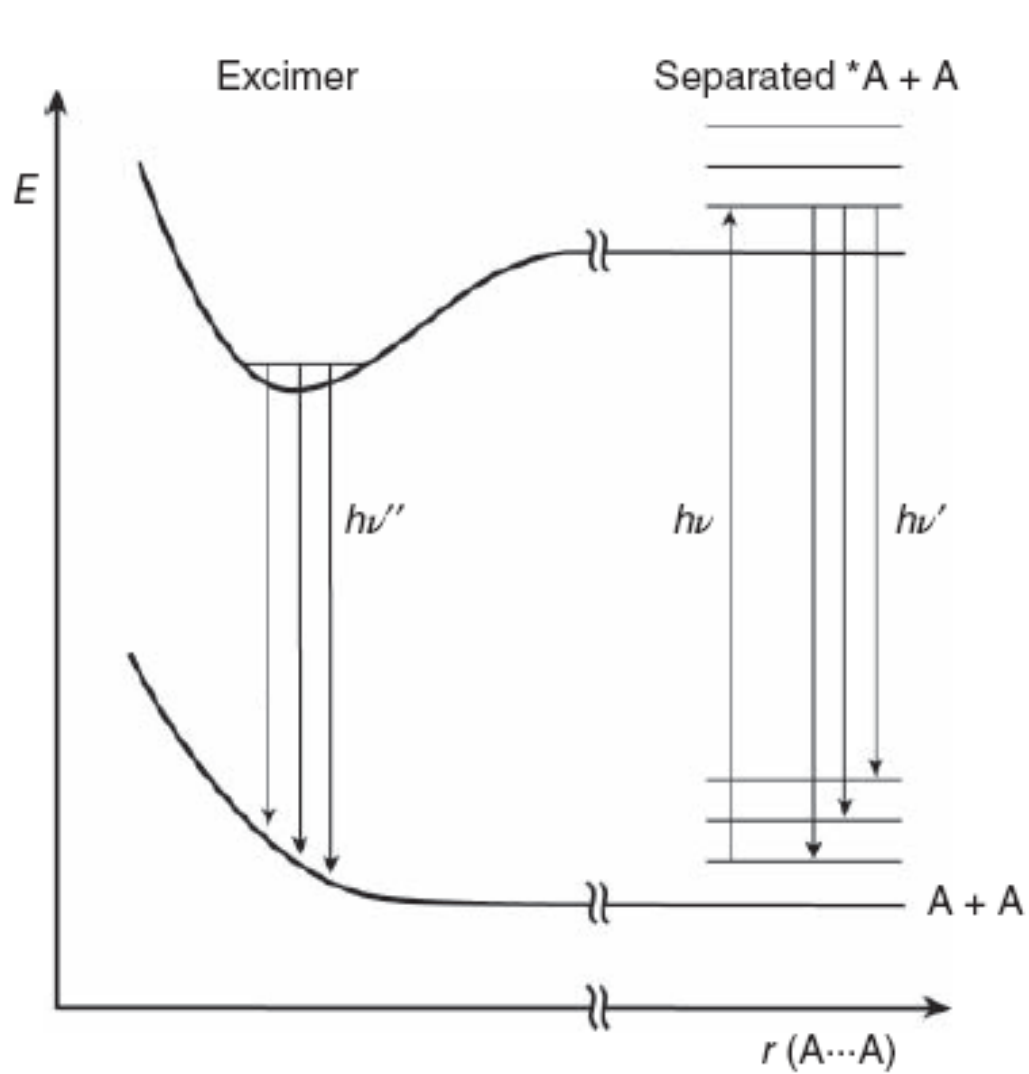

# *Spettro di emissione del pirene*

