

- trasformazione sulla variabile tempo
- proprietà dei segnali
- segnali elementari
 - tempo continuo
 - tempo discreto
- energia e potenza

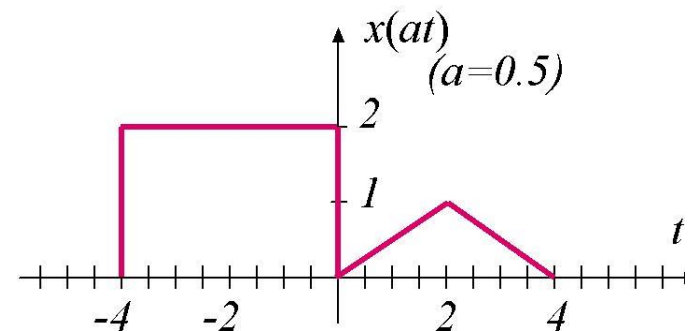

Trasformazioni di variabile

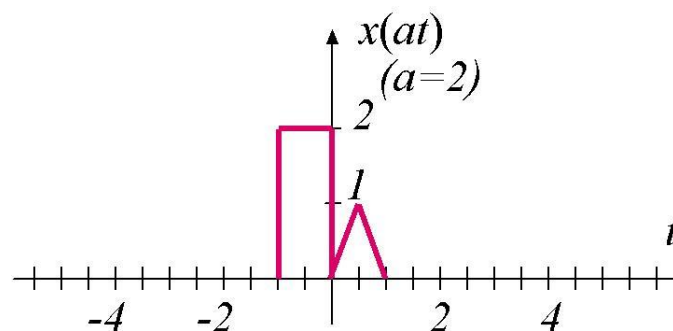
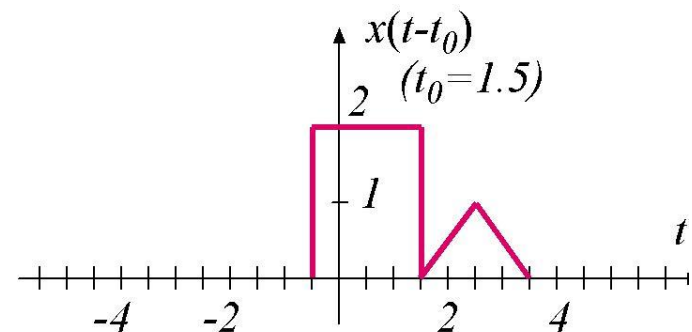
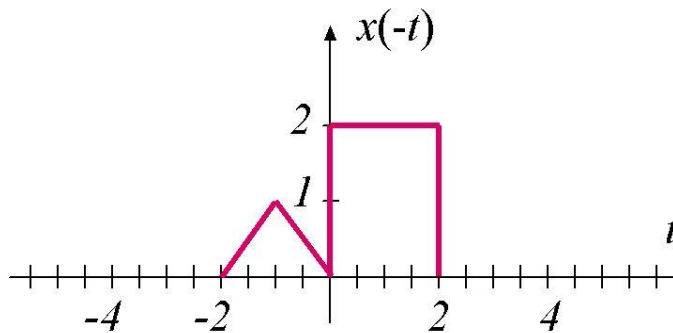
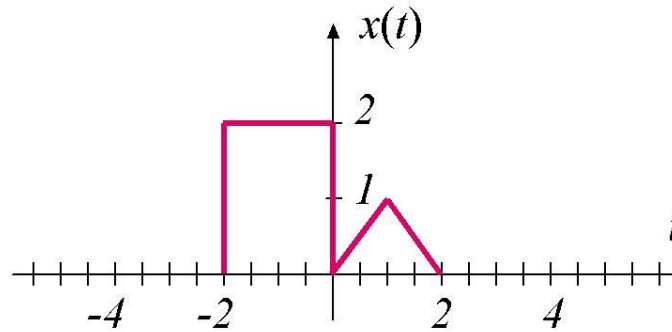

Parità

Un segnale è pari se:

$$x(t) = x(-t) \quad \forall t$$

$$x[n] = x[-n] \quad \forall n$$

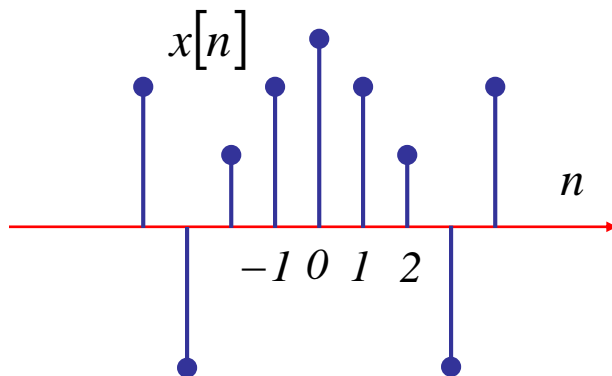
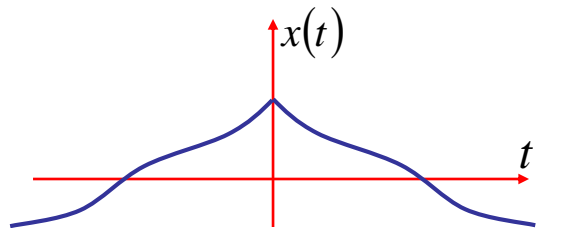

Un segnale è dispari se:

$$x(t) = -x(-t) \quad \forall t$$

$$x[n] = -x[-n] \quad \forall n$$

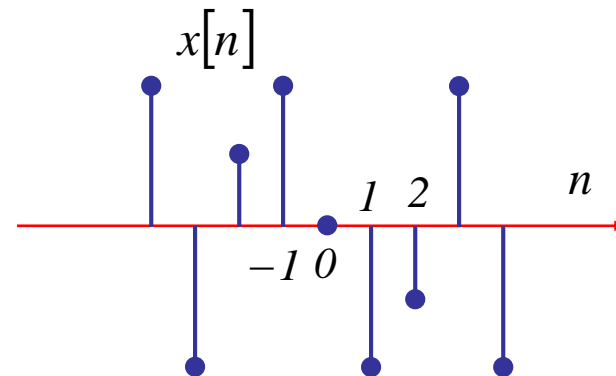
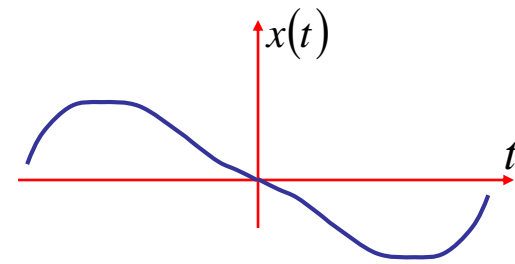

Parte pari – Parte dispari

Ogni segnale può essere scomposto nella somma di un **segnale pari e uno dispari**

$$x(t) = x_p(t) + x_d(t)$$

$$x_p(t) = \frac{x(t) + x(-t)}{2}$$
$$x_d(t) = \frac{x(t) - x(-t)}{2}$$

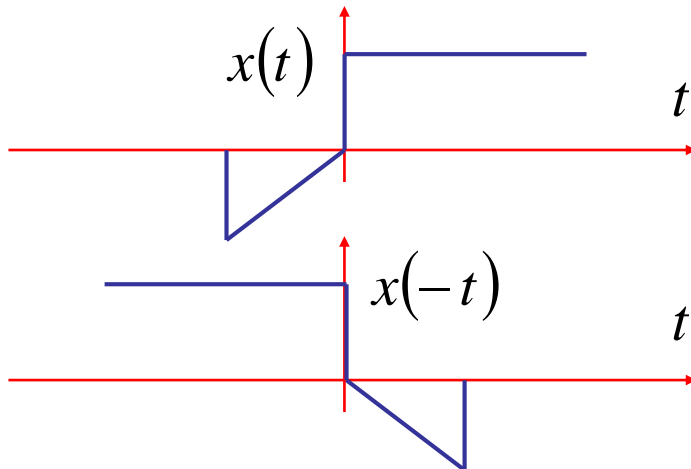

La scomposizione è **unica**

$$x[n] = x_p[n] + x_d[n]$$

$$x_p[n] = \frac{x[n] + x[-n]}{2}$$
$$x_d[n] = \frac{x[n] - x[-n]}{2}$$

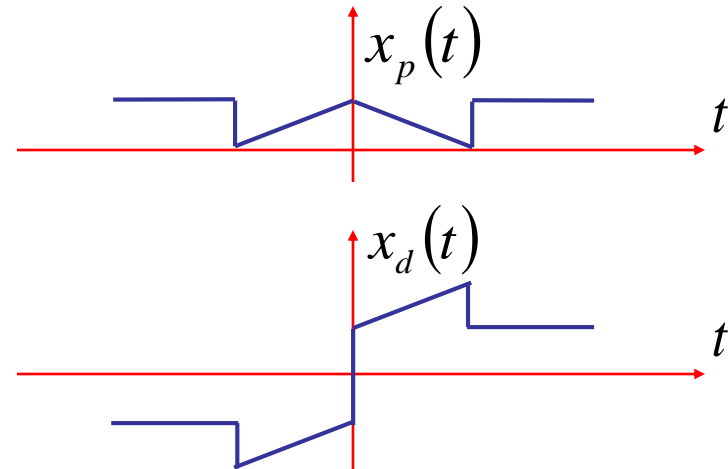

Periodicità

Un segnale $x(t)$ è **periodico** se esiste un numero **reale** $T \neq 0$ tale che:

$$x(t + T) = x(t) \quad \forall t$$

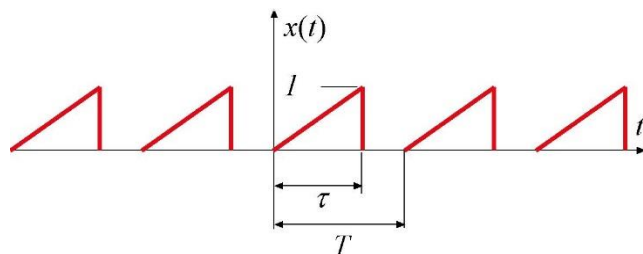

Periodo:

Il più piccolo valore di T per cui

$$x(t + T) = x(t) \quad \forall t$$

Un segnale $x[n]$ è **periodico** se esiste un numero **INTERO** $N \neq 0$ tale che:

$$x[n + N] = x[n] \quad \forall n$$

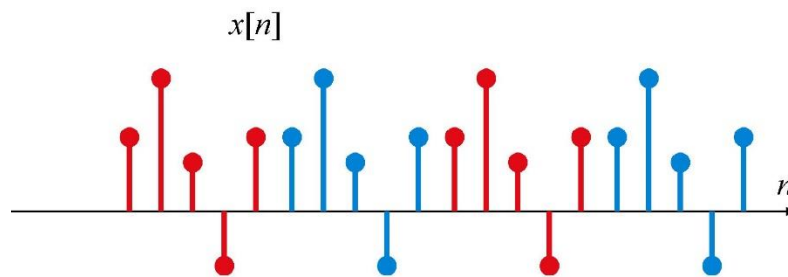

Periodo:

Il più piccolo valore di N per cui

$$x[n + N] = x[n] \quad \forall n$$



Segnali elementari tempo-continuo

Esponenziale complesso:

$$x(t) = Ce^{at}$$

C e a complessi

Casi particolari:

C e a reali

esponenziale reale

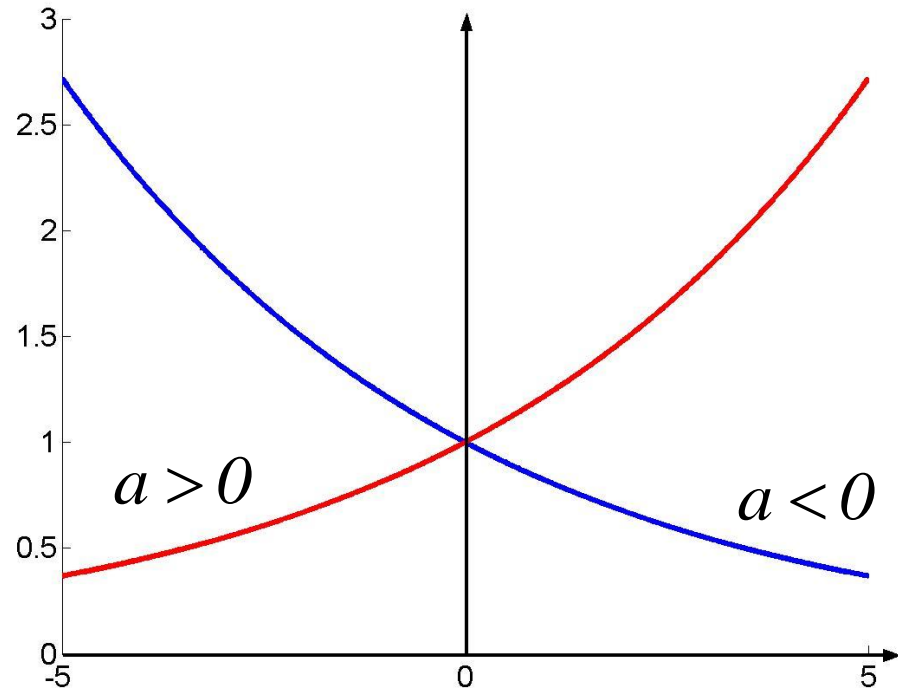

C reale

a immaginario $= j\omega_0 = j2\pi f_0$

$$x(t) = e^{j\omega_0 t}$$

Segnale periodico di periodo $T = \frac{2\pi}{\omega_0} = \frac{1}{f_0}$

Formule di Eulero

$$e^{j\omega_0 t} = \cos\omega_0 t + j \sin\omega_0 t$$

$$e^{-j\omega_0 t} = \cos\omega_0 t - j \sin\omega_0 t$$

$$\cos\omega_0 t = \frac{e^{j\omega_0 t} + e^{-j\omega_0 t}}{2}$$

$$\sin\omega_0 t = \frac{e^{j\omega_0 t} - e^{-j\omega_0 t}}{2j}$$



Segnali elementari tempo-continuo

Proprietà del segnale $x(t) = e^{j\omega_0 t}$

I segnali

$$\phi_k(t) = e^{jk\omega_0 t}$$

con k intero sono in relazione armonica tra loro

$$\phi_k(t) = e^{jk\omega_0 t} \Rightarrow \text{periodico di periodo } \frac{2\pi}{k\omega_0} = \frac{1}{kf_0}$$

$$\text{ma anche di periodo } \frac{2\pi}{\omega_0} = \frac{1}{f_0}$$

Pertanto:

$$y(t) = \sum_{k=-\infty}^{+\infty} C_k e^{jk\omega_0 t} \quad \text{segnale periodico di periodo } T = \frac{2\pi}{\omega_0} = \frac{1}{f_0}$$



Esponenziale complesso: caso generale

C complesso $\longrightarrow C = |C|e^{j\theta}$

a complesso $\longrightarrow a = \sigma + j\omega_0$

$$Ce^{at} = |C|e^{\sigma t} \cos(\omega_0 t + \theta) + j|C|e^{\sigma t} \sin(\omega_0 t + \theta)$$

Tipico andamento della parte reale o immaginaria

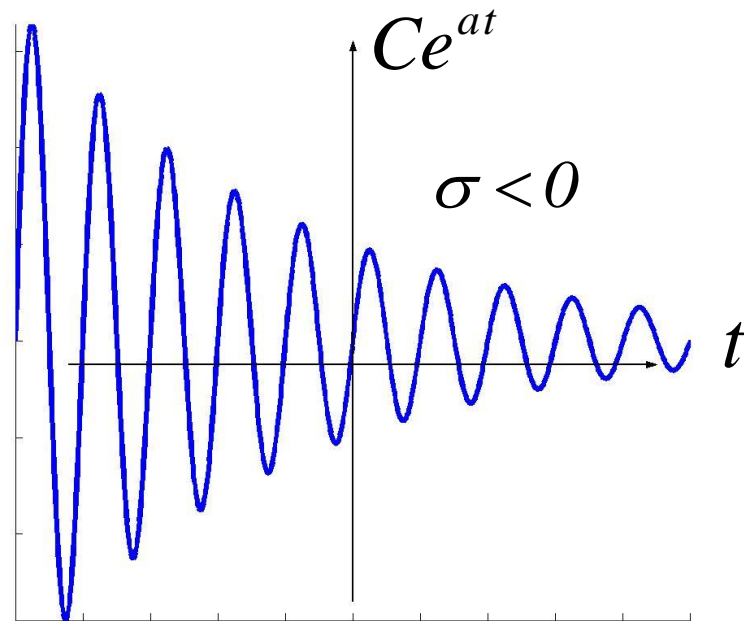

Segnali elementari tempo-continuo

Gradino unitario
Heaviside step function

$$u(t) = \begin{cases} 0, & t < 0 \\ 1, & t > 0 \end{cases}$$

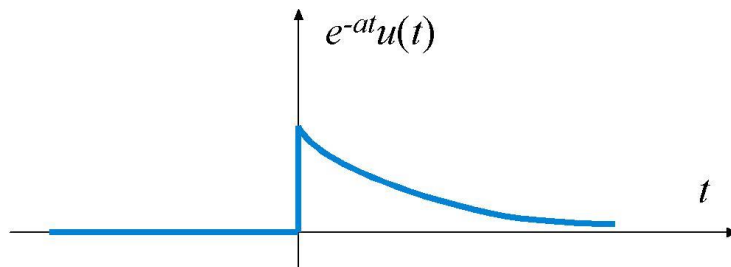
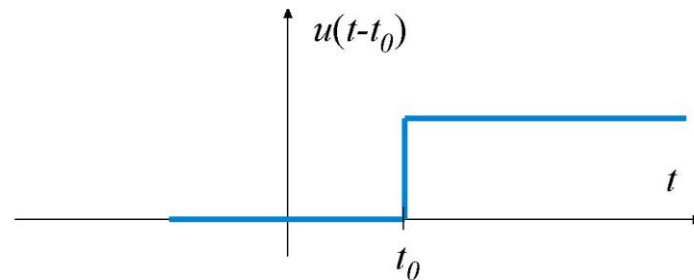
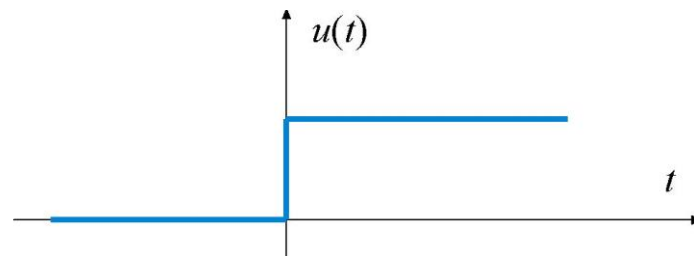

altre definizioni

$$u(t) = \begin{cases} 0, & t \leq 0 \\ 1, & t > 0 \end{cases}$$

$$u(t) = \begin{cases} 0, & t < 0 \\ 1, & t \geq 0 \end{cases}$$

$$u(t) = \begin{cases} 0, & t < 0 \\ \frac{1}{2}, & t = 0 \\ 1, & t > 0 \end{cases}$$

Tipico impiego della
funzione gradino



Impulso unitario (δ - Dirac)

$$x(t) = \delta(t)$$

“**funzione**” che opera in maniera particolare sotto il segno di integrazione:

$$\int_{-\infty}^{+\infty} \delta(t) dt = \int_{-\varepsilon}^{+\varepsilon} \delta(t) dt = \int_a^a \delta(t) dt = 1$$

$(0 \in a)$

$$\int_{-\infty}^{+\infty} f(t) \delta(t) dt = f(0)$$

$$\int_{-\infty}^{+\infty} f(t) \delta(t - t_0) dt = f(t_0)$$

$$\int_{-\infty}^{+\infty} f(t) \delta^n(t - t_0) dt = f^n(t_0)$$

$$f(t) \delta(t) = f(0) \delta(t)$$

$$f(t) \delta(t - t_0) = f(t_0) \delta(t - t_0)$$



Segnali elementari tempo-continuo

Definizione della funzione $\delta(t)$ come limite di una successione di funzioni:

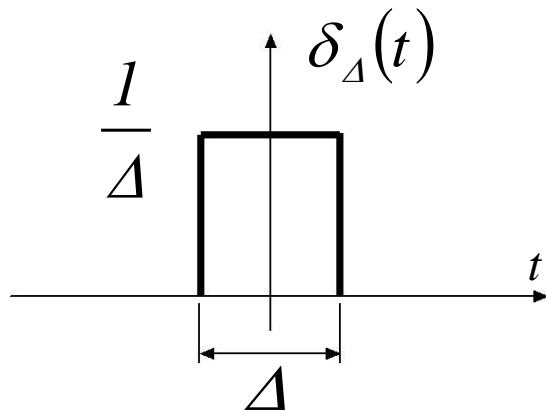

$$\int_{-\infty}^{+\infty} \delta_{\Delta}(t) dt = 1 \quad \forall \Delta$$
$$\lim_{\Delta \rightarrow 0} \delta_{\Delta}(t) = \delta(t)$$

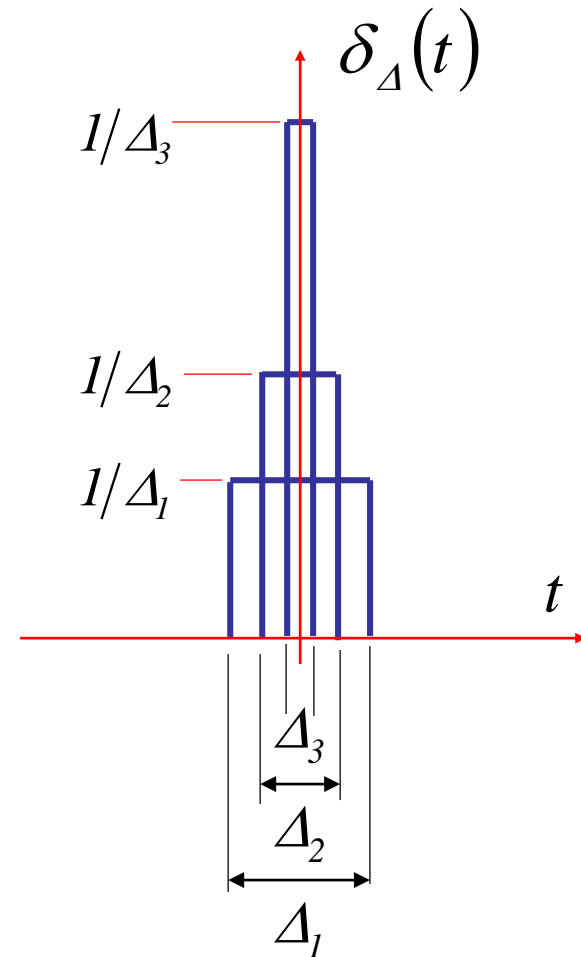

Segnali elementari tempo-continuo

- Un impulso di utilizzo pratico

$$\delta_a(t) = \frac{\sin(a\pi t)}{\pi t}$$

$$\delta'_a(t) = \frac{a\pi t \cos(a\pi t) - \sin(a\pi t)}{\pi t^2}$$

$$\delta''_a(t) = \frac{(2 - (a\pi t)^2) \sin(a\pi t) - 2a\pi t \cos(a\pi t)}{\pi t^3}$$

$$\delta''_a(0) = \frac{-a^3 \pi^2}{3}$$

$$\int_{-\infty}^{+\infty} \delta_a(t) dt = 1 \quad \forall a$$

$$\lim_{a \rightarrow \infty} \delta_a(t) = \delta(t)$$

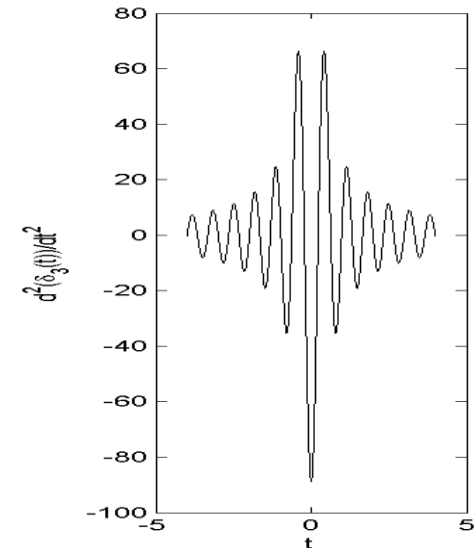
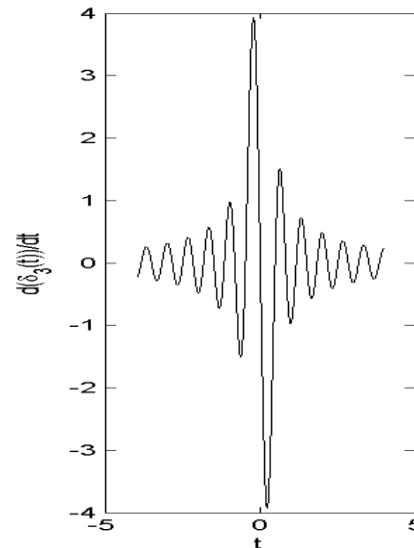
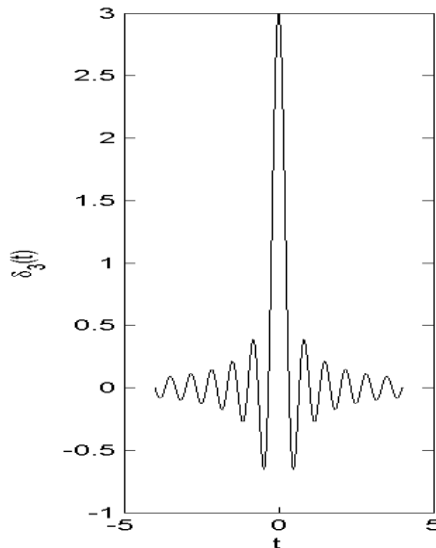

Relazioni tra $u(t)$ e $\delta(t)$

$$u(t) = \int_{-\infty}^t \delta(\tau) d\tau$$

$$\delta(t) = \frac{du(t)}{dt}$$

$$\lim_{\Delta \rightarrow 0} u_{\Delta}(t) = u(t)$$

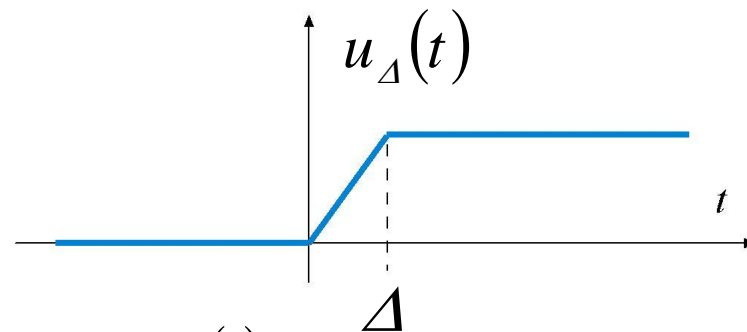

$$\delta_{\Delta}(t) = \frac{du_{\Delta}(t)}{dt}$$

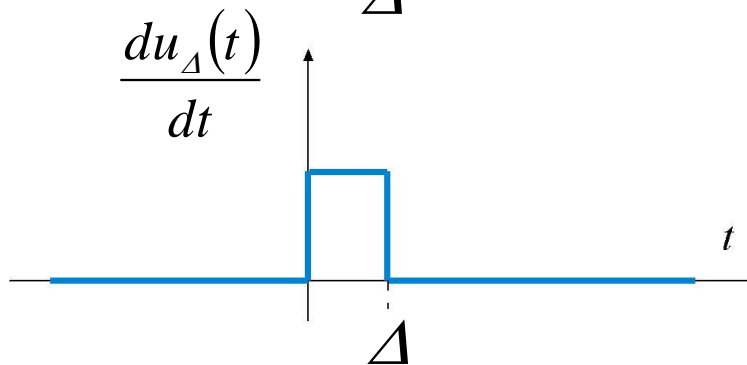

$$\lim_{\Delta \rightarrow 0} \delta_{\Delta}(t) = \delta(t)$$



Segnali elementari tempo-discreto

Gradino unitario $u[n] = \begin{cases} 0, & n < 0 \\ 1, & n \geq 0 \end{cases}$

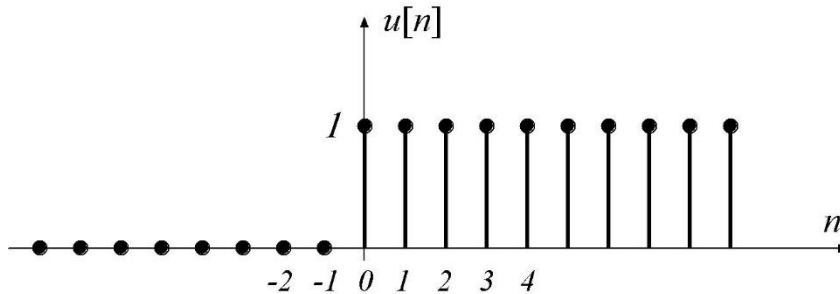

Impulso unitario $\delta[n] = \begin{cases} 0, & n \neq 0 \\ 1, & n = 0 \end{cases}$

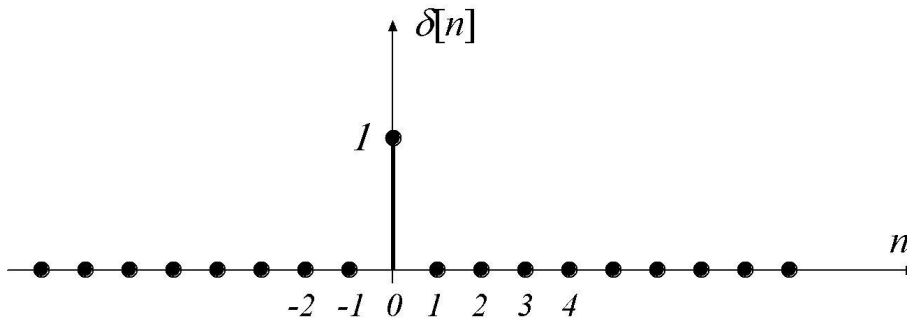

Relazioni tra
 $\delta[n]$ e $u[n]$

$$\delta[n] = u[n] - u[n-1]$$

$$u[n] = \sum_{k=-\infty}^n \delta[k]$$

$$x[n]\delta[n] = x[0]\delta[n]$$



Segnali elementari tempo-discreto

Esponenziale complesso

Forma generale:

$$\left\{ \begin{array}{l} x[n] = z^n \quad z \text{ complesso} \\ z = |z|e^{j\omega} \end{array} \right.$$

z reale

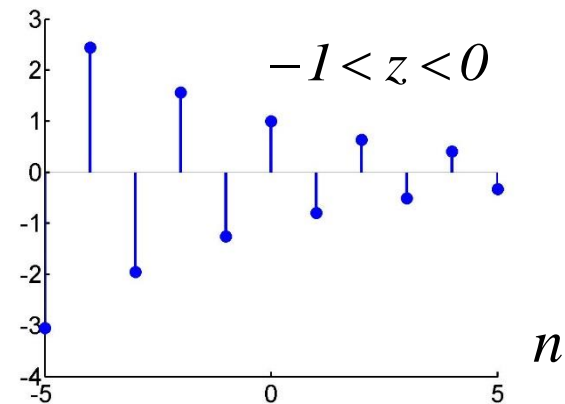
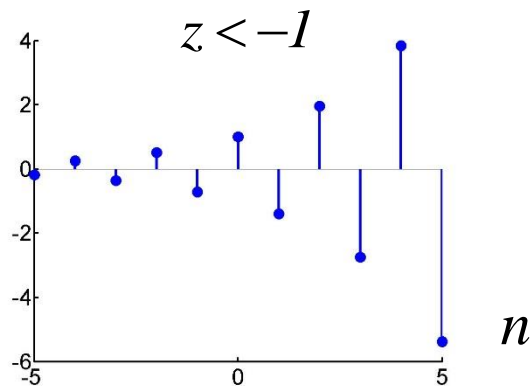
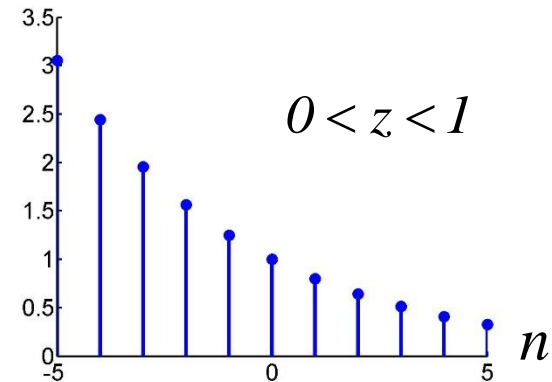
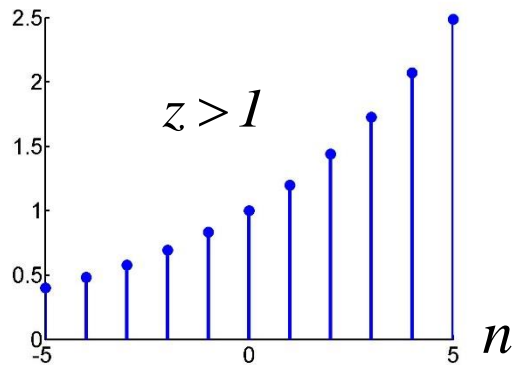

$$|z| = 1$$
$$z = e^{j\omega_0}$$

$$x[n] = z^n = e^{j\omega_0 n}$$

Proprietà:

- a) Valori ω_0 che differiscono per un multiplo di 2π danno luogo alla medesima funzione

$$e^{j(\omega_0 + 2k\pi)n} = e^{j\omega_0 n} e^{j2k\pi n} = e^{j\omega_0 n} = 1$$

I valori di ω_0 su un intervallo lungo 2π (es.: $0, 2\pi$)

generano tutte le possibili funzioni $e^{j\omega_0 n}$ distinte



b) In generale non esiste un intero N tale che: $e^{j\omega_0 n} = e^{j\omega_0(n+N)}$

In generale $e^{j\omega_0 n}$ non è periodica

$$e^{j\omega_0 n} \text{ è periodica soltanto se } \omega_0 = m \frac{2\pi}{N}$$

In questo caso:

$$e^{j\omega_0 n} = e^{jmn \frac{2\pi}{N}}$$

$$e^{j\omega_0(n+N)} = e^{jmn \frac{2\pi}{N}} e^{jm2\pi} = e^{j\omega_0 n} = 1$$

→ Periodica di periodo N



Esempio

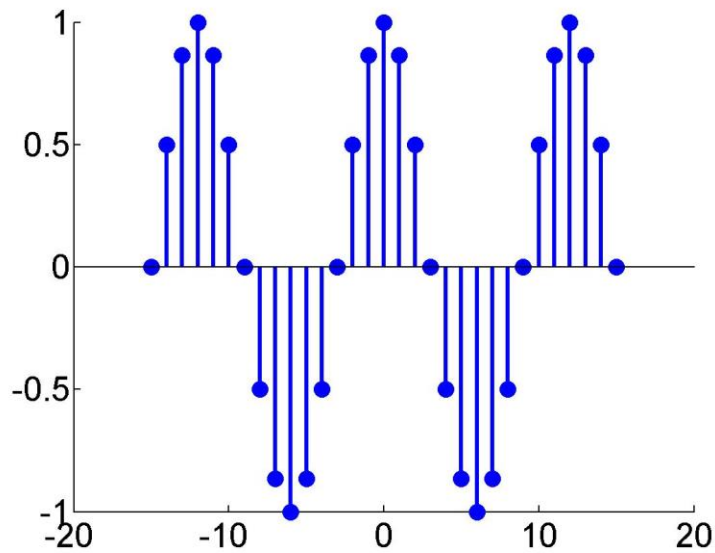

$$\cos\left(\frac{2\pi}{12}n\right)$$

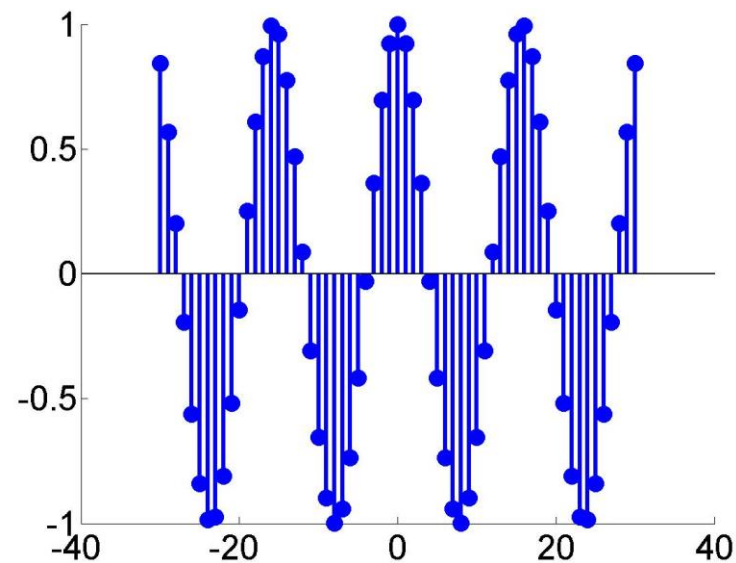

$$\cos(n/2.5)$$



c) I segnali:

$$\phi_k[n] = e^{jk \left(\frac{2\pi}{N} \right) n} \quad k = 0, \pm 1, \dots$$

con k intero sono in relazione armonica tra loro

- sono tutti periodici di periodo N
- ci sono soltanto N distinti segnali $\phi_k[n]$

Caso generale:

$$x[n] = C \left(|z| e^{j\omega_0} \right)^n \quad \text{con} \quad C = |C| e^{j\theta}$$

$$x[n] = |C| |z|^n \{ \cos(\omega_0 n + \theta) + j \sin(\omega_0 n + \theta) \}$$



Esempio:

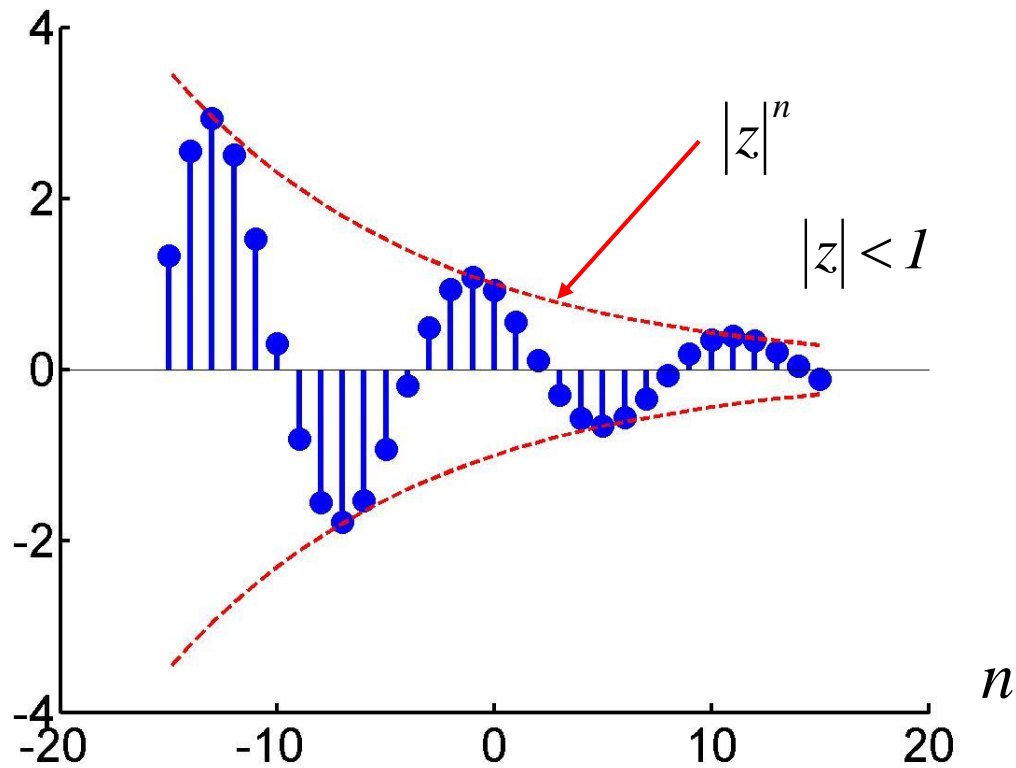

Energia e potenza

Ipotesi:

il segnale $x(t)$ ($x[n]$) considerato rappresenti una tensione (o una corrente) applicata ad una resistenza di 1 ohm

$|x|^2(t)$ Potenza istantanea
all'istante t

$\int_{t_1}^{t_2} |x|^2(t) dt$ Energia sviluppata
nell'intervallo $t_2 - t_1$

$$T = t_2 - t_1$$

$\frac{1}{T} \int_{t_1}^{t_2} |x|^2(t) dt$ Potenza media
nell'intervallo T

$|x|^2[n]$ Potenza istantanea
all'istante n

$\sum_{n=n_1}^{n_2} |x|^2[n]$ Energia sviluppata
nell'intervallo n_1, n_2

$$N = n_2 - n_1 + 1$$

$\frac{1}{N} \sum_{n=n_1}^{n_2} |x|^2[n]$ Potenza media
nell'intervallo N



Classificazione segnali

Segnali di energia

$$\int_{-\infty}^{+\infty} |x(t)|^2 dt = E < \infty$$

Segnali di potenza

$$\int_{-\infty}^{+\infty} |x(t)|^2 dt = \infty$$

$$\lim_{T \rightarrow \infty} \frac{1}{T} \int_{-T/2}^{+T/2} |x(t)|^2 dt = P < \infty$$

Segnali di energia

$$\sum_{n=-\infty}^{+\infty} |x|^2 [n] = E < \infty$$

Segnali di potenza

$$\sum_{n=-\infty}^{\infty} |x|^2 [n] = \infty$$

$$\lim_{N \rightarrow \infty} \frac{1}{2N+1} \sum_{n=-N}^N |x[n]|^2 = P < \infty$$



- trasformazioni di un segnale causate da trasformazioni della variabile tempo: $t \rightarrow -t$, $t \rightarrow t - t_0$, $t \rightarrow at$
- alcuni segnali possono essere: pari, dispari, periodici
- principali segnali elementari a tempo continuo
 - impulso ideale $\delta(t)$
 - gradino unitario $u(t)$
 - esponenziale complesso ($C \exp(\beta t)$, $\exp(j\omega t)$)
- principali segnali elementari a tempo discreto
 - impulso ideale $\delta[n]$
 - gradino unitario $u[n]$
 - esponenziale complesso ($C z^n$, $\exp(j\Omega n)$)

