

Course of Geodynamics

Dr. Magdala Tesauro

Course Outline:

1. Thermo-physical structure of the continental and oceanic crust
2. Thermo-physical structure of the continental lithosphere
3. Thermo-physical structure of the oceanic lithosphere and oceanic ridges
- 4. Rheology and mechanics of the lithosphere**
5. Plate tectonics and boundary forces
6. Hot spots, plumes, and convection
7. Subduction zones systems
8. Orogens formation and evolution
9. Sedimentary basins formation and evolution

Stress

Stress:

- Force exerted per unit area of a surface (Pa). Any stress acting upon a surface can be expressed in terms of a normal stress perpendicular to the surface and two components of shear stress in the plane of the surface.
- The state of stress within a medium is specified by the magnitudes and directions of three *principal stresses* mutually orthogonal and termed σ_1 , σ_2 , and σ_3 (maximum, intermediate and minimum principal stresses) that act on three planes in the medium along which the shear stress is zero.
- Normal force per unit area on horizontal planes increases linearly with depth: the part due to the weight of the rock overburden is known as lithostatic pressure (or stress). If the normal surface forces are all equal and are equal to the weight of overburden, the rock is in a lithostatic state of stress.

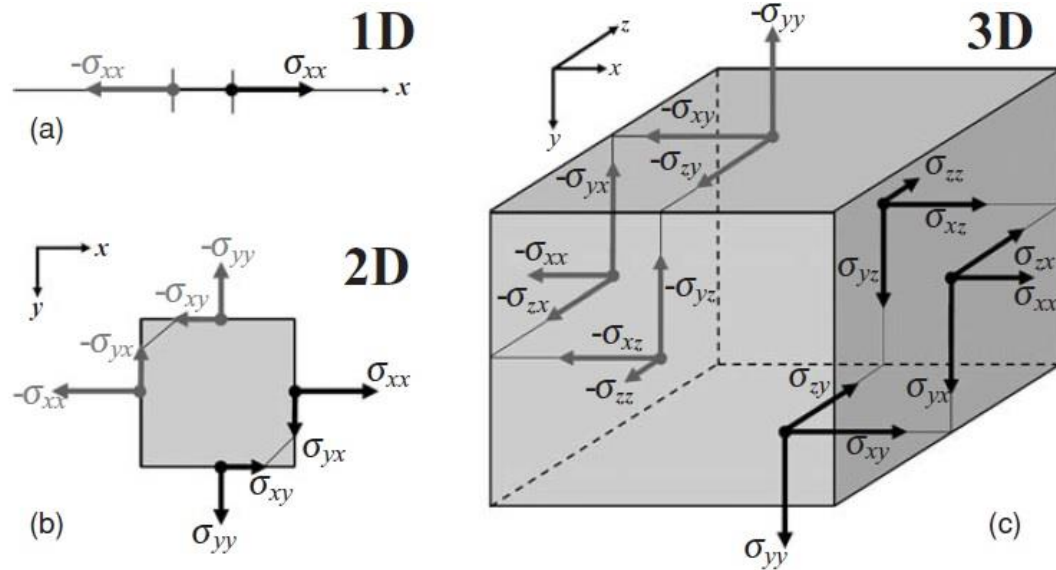

- In case of tectonic forces acting on a rock mass the normal forces are not equal and the total horizontal surface force has two components: a lithostatic term ($\rho_c g h$) and a tectonic contribution (deviatoric stress, $\Delta\sigma_{xx}$) $\sigma_{ij} = \rho_c g h + \sigma'_{ij}$ with ρ_c density of the continents.
- Normal stresses can be either *tensile* when they tend to pull on planes or *compressive* when they push on planes.
- Horizontal deviatoric stresses may result from uplift producing excess potential energy.

Stress

The state of stress of a single point inside a rock (i.e. a unit cube) is given by nine numbers, all of which have the units of force per area:

$$\sigma = \begin{pmatrix} \sigma_{11} & \sigma_{12} & \sigma_{13} \\ \sigma_{21} & \sigma_{22} & \sigma_{23} \\ \sigma_{31} & \sigma_{32} & \sigma_{33} \end{pmatrix} = \begin{pmatrix} \sigma_{xx} & \sigma_{xy} & \sigma_{xz} \\ \sigma_{yx} & \sigma_{yy} & \sigma_{yz} \\ \sigma_{zx} & \sigma_{zy} & \sigma_{zz} \end{pmatrix}$$

The first index indicates the direction in which the stress component acts, while the second one indicates the normal to the plane on which this stress component acts.

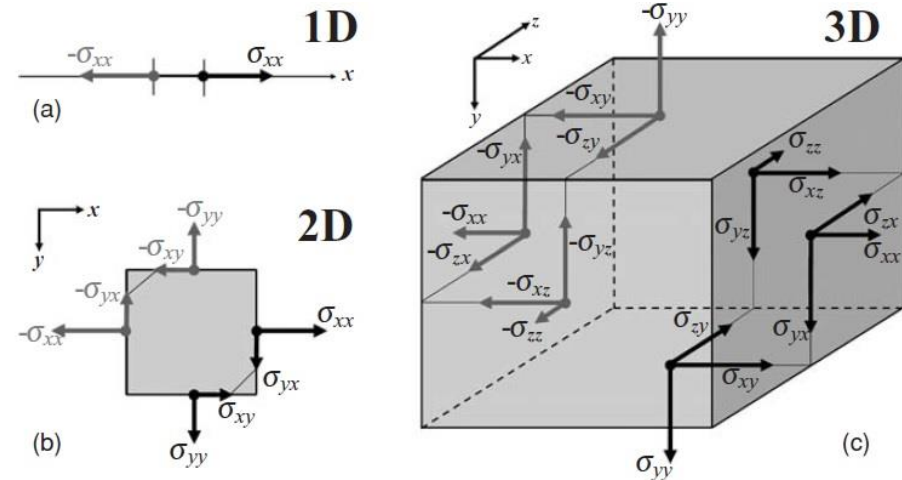

The state of stress at a point may always be characterized by only three principal stresses:

$$\sigma' = \begin{pmatrix} \sigma'_{xx} & 0 & 0 \\ 0 & \sigma'_{yy} & 0 \\ 0 & 0 & \sigma'_{zz} \end{pmatrix} = \begin{pmatrix} \sigma_1 & 0 & 0 \\ 0 & \sigma_2 & 0 \\ 0 & 0 & \sigma_3 \end{pmatrix}$$

- The new coordinate system was chosen so that the x' axis is parallel to the largest of the three principal stresses.
- The principal stresses are often oriented roughly parallel to the vertical and the horizontal directions, since the shear stresses at the earth's surface and base of the lithosphere are both negligible.

Stress

Normal stresses are always located on the main diagonal of the matrix, which is symmetric relative to the main diagonal:

$$\begin{aligned}\sigma_{ij} &= \sigma_{ji} \\ \sigma_{xy} &= \sigma_{yx} \quad \sigma_{xz} = \sigma_{zx} \quad \sigma_{yz} = \sigma_{zy}\end{aligned}$$

- The **mean stress** σ_m (or pressure) is given by the mean of the three principal stresses: $\sigma_m = P = \frac{\sigma'_{xx} + \sigma'_{yy} + \sigma'_{zz}}{3} = \frac{\sigma_1 + \sigma_2 + \sigma_3}{3}$

In the case of a *hydrostatic stress state* (which is the state of a fluid *at rest*) all shear stresses are zero and all normal stresses are equal to each other:

$$\begin{aligned}\sigma_{xy} &= \sigma_{yx} = \sigma_{xz} = \sigma_{zx} = \sigma_{yz} = \sigma_{zy} = 0 \\ \sigma_{xx} &= \sigma_{yy} = \sigma_{zz} = P\end{aligned}$$

- Pressure is an invariant: it does not change by changing the coordinate system.
- Pressure is often considered as corresponding to the hydrostatic condition everywhere and it is computed as a function of depth y and vertical density profile $\rho(y)$:

$P_0 = 0.1$ MPa is pressure on the Earth's surface:

$$P(y) = P_0 + g \int_0^y \rho(y) dy$$

Stress

Deviatoric stresses (σ'_{ij} or τ) are deviations of stresses from the hydrostatic stress state (mean stress): $\sigma'_{ij} = \sigma_{ij} - P\delta_{ij}$.

where δ_{ij} is the *Kronecker delta*: $\delta_{ij} = 1$ when $i=j$ and $\delta_{ij} = 0$ when $i \neq j$, i and j are coordinate indices (x, y, z)

$$\begin{aligned}\sigma'_{xx} &= \sigma_{xx} - P & \sigma'_{xy} &= \sigma'_{yx} = \sigma_{xy} = \sigma_{yx} \\ \sigma'_{yy} &= \sigma_{yy} - P & \sigma'_{xz} &= \sigma'_{zx} = \sigma_{xz} = \sigma_{zx} \\ \sigma'_{zz} &= \sigma_{zz} - P & \sigma'_{yz} &= \sigma'_{zy} = \sigma_{yz} = \sigma_{zy}\end{aligned}$$

- The **deviatoric stress** is a tensor (τ), which can be defined as the deviation of the stress tensor from pressure:

$$\tau = \begin{pmatrix} \tau_{xx} & \tau_{xy} & \tau_{xz} \\ \tau_{yx} & \tau_{yy} & \tau_{yz} \\ \tau_{zx} & \tau_{zy} & \tau_{zz} \end{pmatrix} = \begin{pmatrix} \sigma_{xx} - P & \sigma_{xy} & \sigma_{xz} \\ \sigma_{yx} & \sigma_{yy} - P & \sigma_{yz} \\ \sigma_{zx} & \sigma_{zy} & \sigma_{zz} - P \end{pmatrix}$$

For a coordinate system parallel to the principal stress directions:

$$\tau' = \begin{pmatrix} \tau'_{xx} & 0 & 0 \\ 0 & \tau'_{yy} & 0 \\ 0 & 0 & \tau'_{zz} \end{pmatrix} = \begin{pmatrix} \sigma_1 - \sigma_m & 0 & 0 \\ 0 & \sigma_2 - \sigma_m & 0 \\ 0 & 0 & \sigma_3 - \sigma_m \end{pmatrix}$$

- The sum of the normal deviatoric stresses is zero: $\sigma'_{xx} + \sigma'_{yy} + \sigma'_{zz} = 0$ since $\sigma_{xx} + \sigma_{yy} + \sigma_{zz} = 3P$

- The **differential stress** is the magnitude of the difference between the largest and the smallest principal stresses: $\sigma_d = \sigma_1 - \sigma_3$

The value of the differential stress and the characteristics of deviatoric stress both influence the extent and type of distortion experienced by a body.

Stress

The total stress tensor is the sum of the isotropic stress tensor plus the deviatoric stress tensor:

$$\begin{pmatrix} \sigma_{xx} & \sigma_{xy} & \sigma_{xz} \\ \sigma_{yx} & \sigma_{yy} & \sigma_{yz} \\ \sigma_{zx} & \sigma_{zy} & \sigma_{zz} \end{pmatrix} = \begin{pmatrix} P & 0 & 0 \\ 0 & P & 0 \\ 0 & 0 & P \end{pmatrix} + \begin{pmatrix} \sigma_{xx} - P & \sigma_{xy} & \sigma_{xz} \\ \sigma_{yx} & \sigma_{yy} - P & \sigma_{yz} \\ \sigma_{zx} & \sigma_{zy} & \sigma_{zz} - P \end{pmatrix}$$

The *second invariant* of the deviatoric stress tensor can be calculated as follows:

$$\sigma_{II} = \sqrt{1/2 \sigma'_{ij}{}^2}$$

(the indices *ij* imply a *summation*)

$$\sigma_{II} = \sqrt{1/2 (\sigma'_{xx}{}^2 + \sigma'_{yy}{}^2 + \sigma'_{zz}{}^2 + \sigma_{xy}^2 + \sigma_{yx}^2 + \sigma_{xz}^2 + \sigma_{zx}^2 + \sigma_{yz}^2 + \sigma_{zy}^2)}$$
 Since the stress tensor is symmetric:

$$\sigma_{II} = \sqrt{1/2 (\sigma'_{xx}{}^2 + \sigma'_{yy}{}^2 + \sigma'_{zz}{}^2) + \sigma_{xy}^2 + \sigma_{xz}^2 + \sigma_{yz}^2}$$

Strain

Strain (ϵ) is defined as any change in the size or shape of a material caused by the stress application and is usually expressed as ratios that describe changes in the configuration of a solid, such as the change in the length of a line divided by its original length (In case of simple axial and shear deformations):

$$\gamma = \frac{\Delta L}{L}$$

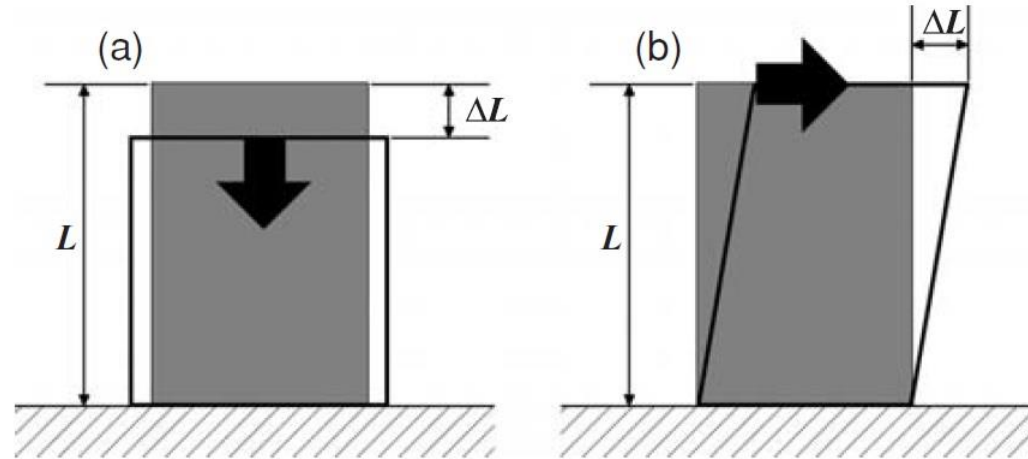

In case of more complex deformation *Strain tensor ϵ_{ij}* :
$$\epsilon_{ij} = \frac{1}{2} \left(\frac{\partial u_i}{\partial x_j} + \frac{\partial u_j}{\partial x_i} \right)$$

where i and j are coordinate indices (x, y, z) and x_j and x_i are spatial coordinates

In 3D, we can define nine tensor components:

Three normal strain components:
$$\epsilon_{xx} = \frac{1}{2} \left(\frac{\partial u_x}{\partial x} + \frac{\partial u_x}{\partial x} \right) = \frac{\partial u_x}{\partial x}$$

$$\epsilon_{yy} = \frac{1}{2} \left(\frac{\partial u_y}{\partial y} + \frac{\partial u_y}{\partial y} \right) = \frac{\partial u_y}{\partial y}$$

$$\epsilon_{zz} = \frac{1}{2} \left(\frac{\partial u_z}{\partial z} + \frac{\partial u_z}{\partial z} \right) = \frac{\partial u_z}{\partial z}$$

Six shear strain components:
$$\epsilon_{xy} = \epsilon_{yx} = \frac{1}{2} \left(\frac{\partial u_x}{\partial y} + \frac{\partial u_y}{\partial x} \right)$$

$$\epsilon_{xz} = \epsilon_{zx} = \frac{1}{2} \left(\frac{\partial u_x}{\partial z} + \frac{\partial u_z}{\partial x} \right)$$

$$\epsilon_{yz} = \epsilon_{zy} = \frac{1}{2} \left(\frac{\partial u_z}{\partial y} + \frac{\partial u_y}{\partial z} \right)$$

Strain

Stress and strain tensors are very different physical quantities:

- Stress characterizes the distribution of forces acting in a continuum at a given moment of time
- Strain quantifies in an integrated way the entire *deformation history* of the continuum from the initial state, up until this given moment.

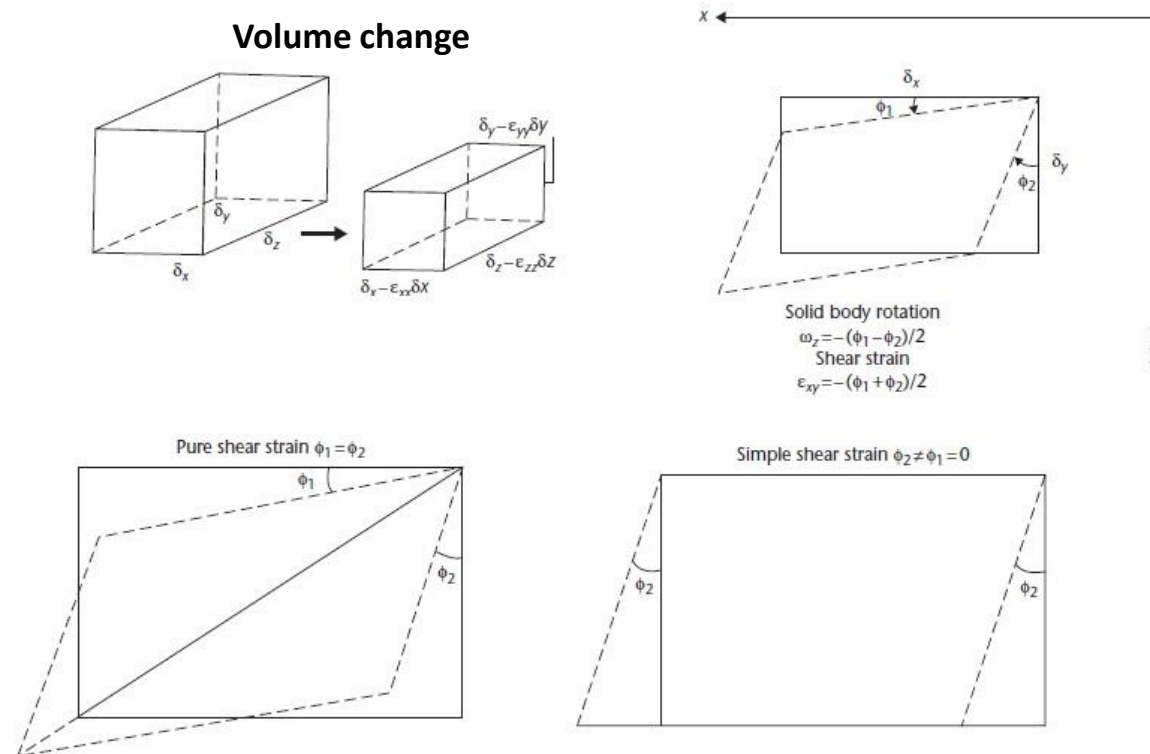

- Volume change or dilatation is the sum of the strain components ($\epsilon_{xx} + \epsilon_{yy} + \epsilon_{zz}$)
- Volume elements may change their position without changing their shape (Displacement)
- Shear strain may distort the shape of an element of a solid (e.g., rectangle) and is determined by the angles through which the sides of the rectangle are rotated (ϕ_1 and ϕ_2).
- If $\phi_1 = \phi_2$ no solid body rotation occurs, deformation is the result only of shear strains (pure shear: uniform extension with depth).
- If $\phi_2 \neq \phi_1 = 0$ the body has undergone simple shear (asymmetrical extension)

Strain Rate

- In geodynamic modelling, it is convenient to use the **strain rate**, which characterizes the dynamics of changes in the internal deformation rather than the **strain** which characterizes the total amount of deformation compared to the initial state.

The strain rate tensor $\dot{\epsilon}_{ij}$ is the time derivative of the strain tensor ϵ_{ij} :

$$\dot{\epsilon}_{ij} = \frac{1}{2} \left(\frac{\partial v_i}{\partial x_j} + \frac{\partial v_j}{\partial x_i} \right)$$

In 3D we can define nine tensor components:

Three normal components:	$\dot{\epsilon}_{xx} = \frac{1}{2} \left(\frac{\partial v_x}{\partial x} + \frac{\partial v_x}{\partial x} \right) = \frac{\partial v_x}{\partial x}$ $\dot{\epsilon}_{yy} = \frac{1}{2} \left(\frac{\partial v_y}{\partial y} + \frac{\partial v_y}{\partial y} \right) = \frac{\partial v_y}{\partial y}$ $\dot{\epsilon}_{zz} = \frac{1}{2} \left(\frac{\partial v_z}{\partial z} + \frac{\partial v_z}{\partial z} \right) = \frac{\partial v_z}{\partial z}$	Six shear strain components:	$\dot{\epsilon}_{xy} = \dot{\epsilon}_{yx} = \frac{1}{2} \left(\frac{\partial v_x}{\partial y} + \frac{\partial v_y}{\partial x} \right)$ $\dot{\epsilon}_{xz} = \dot{\epsilon}_{zx} = \frac{1}{2} \left(\frac{\partial v_x}{\partial z} + \frac{\partial v_z}{\partial x} \right)$ $\dot{\epsilon}_{yz} = \dot{\epsilon}_{zy} = \frac{1}{2} \left(\frac{\partial v_y}{\partial z} + \frac{\partial v_z}{\partial y} \right)$
--------------------------	--	------------------------------	--

By analogy to the stress tensor, the strain rate tensor can also be subdivided to isotropic $\dot{\epsilon}_{kk}$ (which is an invariant) and deviatoric components $\dot{\epsilon}'_{ij}$

$$\dot{\epsilon}_{kk} = \dot{\epsilon}_{xx} + \dot{\epsilon}_{yy} + \dot{\epsilon}_{zz} = \frac{\partial v_x}{\partial x} + \frac{\partial v_y}{\partial y} + \frac{\partial v_z}{\partial z} = \text{div}(\bar{v}).$$

$$\dot{\epsilon}'_{ij} = \dot{\epsilon}_{ij} - \delta_{ij} \frac{1}{3} \dot{\epsilon}_{kk},$$

The second invariant of the deviatoric strain rate tensor is calculated as follows: $\dot{\epsilon}_{II} = \sqrt{1/2 \dot{\epsilon}'_{ij}{}^2}$.

Deformation Laws

When the stress applied to rocks cannot be compensated elastically permanent (brittle/plastic) deformation will occur (continuous, irreversible deformation without fracturing).

On geological time scales and lithospheric length scales deformation mechanisms can be described:

- Brittle deformation: It only describes a stress state and not a relationship between stress and strain.
- Plastic deformation: It states that a constant stress is required to deform the rock: regardless how much or how fast we deform, the required force is always the same.
- Ductile deformation: It is a generic term, indicating that the deformation is not elastic and not brittle.
- Elastic deformation: It states that the *strain* of a rock is proportional to the applied *total stress* (it is the only deformation mechanism which is not permanent).
- Viscous deformation: It is the law that is most commonly used to describe ductile deformation on the crustal scale. Viscous means that the strain *rate* of a rock is proportional to the applied *deviatoric stress*.

		Deformation laws	
brittle		no deformation law but a stress state; usually described with plastic law	
plastic	(ductile)	constant stress; example: sand	
viscous	(ductile)	stress and strain rate are proportional	- linear (Newtonian) - non linear (power law)
elastic		stress and strain are proportional	

Rocks' deformation

- Beyond the elastic limit (depending on T and P), rocks deform by either brittle fracturing or by ductile flow. The *yield stress* (or yield strength) is the value of the differential stress above the elastic limit at which deformation becomes permanent.
- Rock rheology in the short term (seconds or days) is different from that of the same material stressed over durations of months or years. Lithosphere behaves as strong material over geological time ($> 10^6$) and thus it is able to bend under surface loads, store elastic stresses responsible for seismicity, and transmit stresses over large horizontal distances.

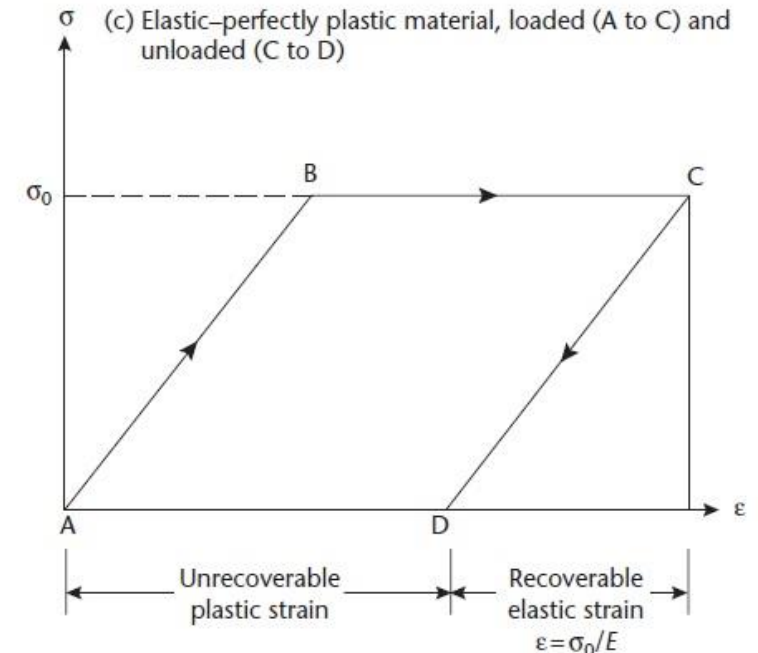
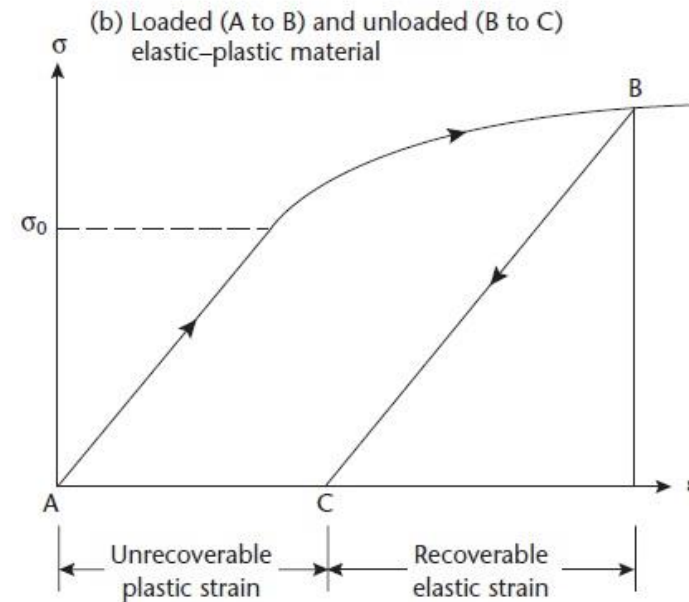
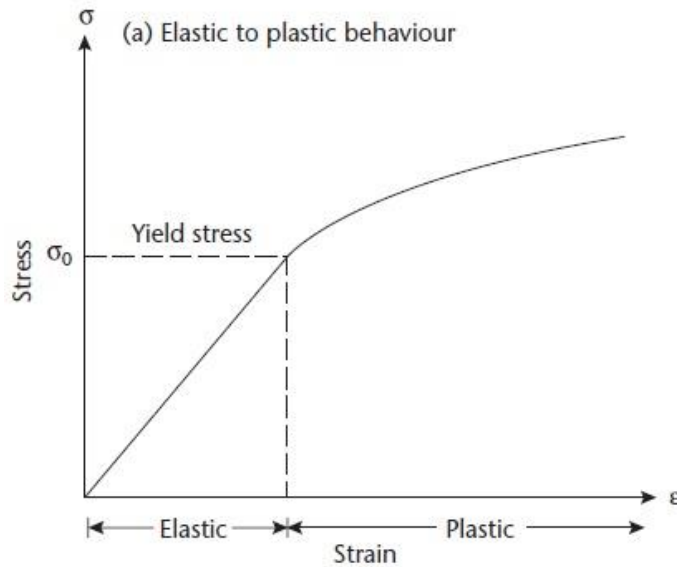

Relationship between stress σ and strain ϵ for elastic and ductile deformation

Rocks' deformation: brittle fracture

When the stress applied to rocks cannot be compensated elastically permanent (brittle/plastic) deformation will occur (continuous, irreversible deformation without fracturing).

- In the viscous regime, only deviatoric stresses cause deformation
- Elastic deformation occurs in response to the total stress state: Considering only uniaxial loading: $\sigma_{xx} = E\epsilon_{xx}$
 E =Young's Modulus

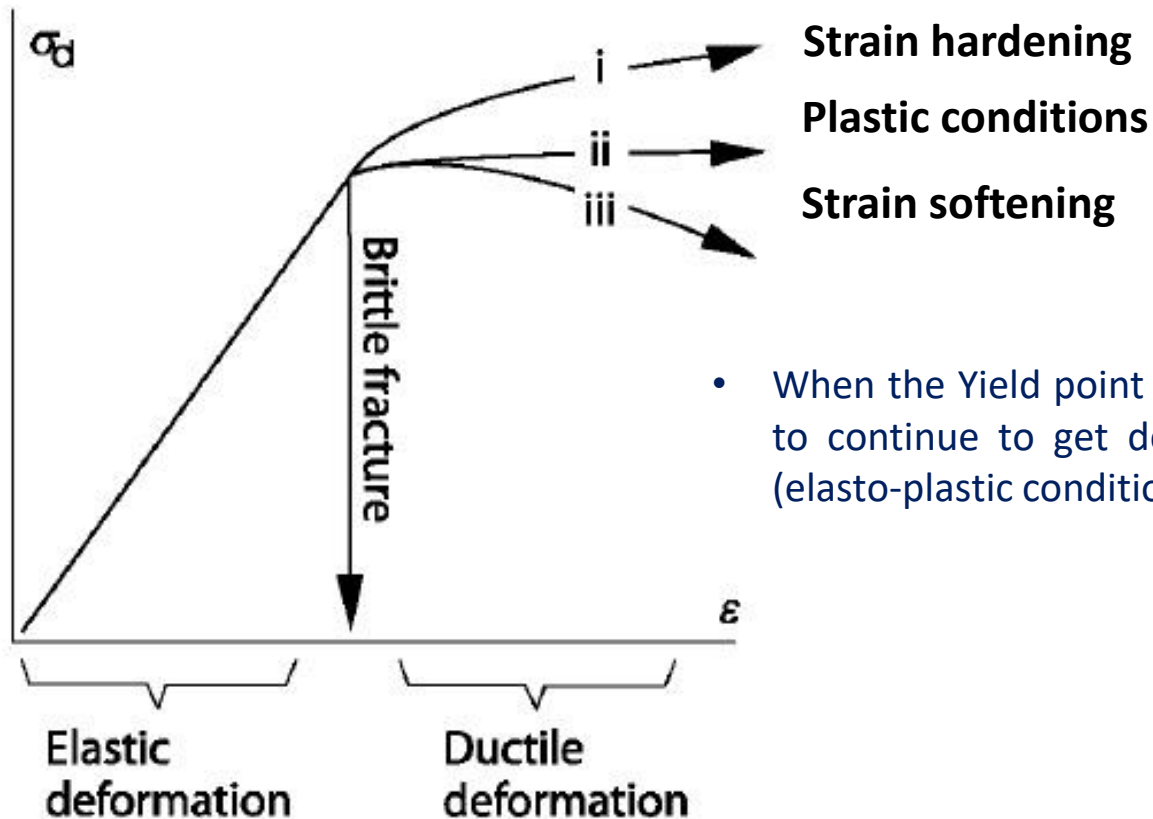

- When the Yield point is reached (the point at which the elastic deformation becomes ductile), to continue to get deformation it is needed to increase (strain hardening), leave constant (elasto-plastic conditions, ideal case) or decrease (strain softening) the stress applied.

Rocks' deformation: brittle fracture

- Rocks deform by creating new cracks or by friction along pre-existing cracks.
- Brittle failure is described with Mohr-Coulomb criterion, representing the critical state at which failure occurs.
- Failure occurs when the shear stress on a given plane reaches a critical value τ_c (σ_s^c) that is a function of the normal stress acting on that plane σ_n : $\tau_c = \sigma_0 + \mu\sigma_n$ (Byerlee's law), where σ_0 is the cohesion (the resistance of the material to shear fracture on a plane of zero normal stress) and μ ($\tan(\phi)$) is the friction coefficient.

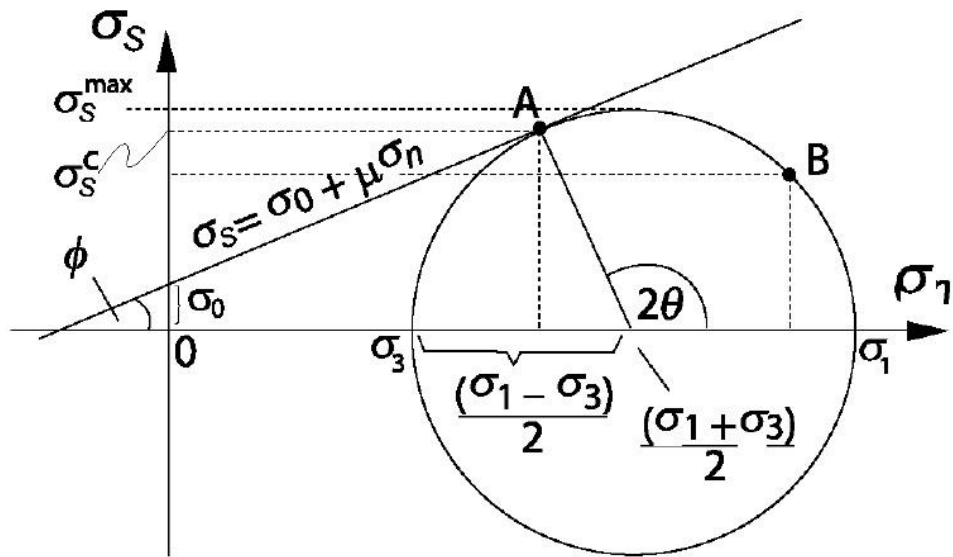

The brittle failure of a rock occurs when: $\sigma_s^c = \sin 2\theta(\sigma_1 - \sigma_3)/2$.

- The shear stress (σ_s^{\max}) is the largest on planes that lie at an angle of 45° to the principal stress direction.
- The maximum shear stress (σ_s^{\max}) a rock can support is half as large as the applied differential stress:

$$\sigma_s^{\max} = \frac{\sigma_1 - \sigma_3}{2}$$

- $\tan \phi = \mu$, ϕ is the angle between the considered plane and the directions of the principal stresses.
- ϕ is about 30° - 40° , equivalent to an internal coefficient of friction between 0.6-0.8.

Rocks' deformation: brittle fracture

- Brittle fracture is likely caused by progressive failure along a network of micro- and meso-scale cracks and occurs where the local stress maxima exceed the strength of the rock
- The crack orientations relative to the applied stress determine the location and magnitude of local stress maxima.
- When the magnitude of the tensile stress exceeds the tensile strength of the material, cracks orthogonal to this stress fail first and an extension fracture occurs.
- Cracks close under compression (probably at depths of >5 km) due to increasing overburden pressure, which implies that the compressive strength of a material is much greater than the tensile strength. Where all cracks are closed, fracturing depends upon the inherent strength of the material and the magnitude of the differential stress.
- Faults preferentially form at angles of 45° on either side of the maximum principal compressive stress when a critical shear stress on the planes is exceeded.
- This critical shear stress (τ_c) depends upon the normal stress (σ_n) on planes of potential failure and the coefficient of internal friction (μ) on those planes (0.6-0.8 for the rocks), which resists relative motion across them:

Mohr-Coulomb criterion: $\tau_c = \sigma_0 + \mu\sigma_n$

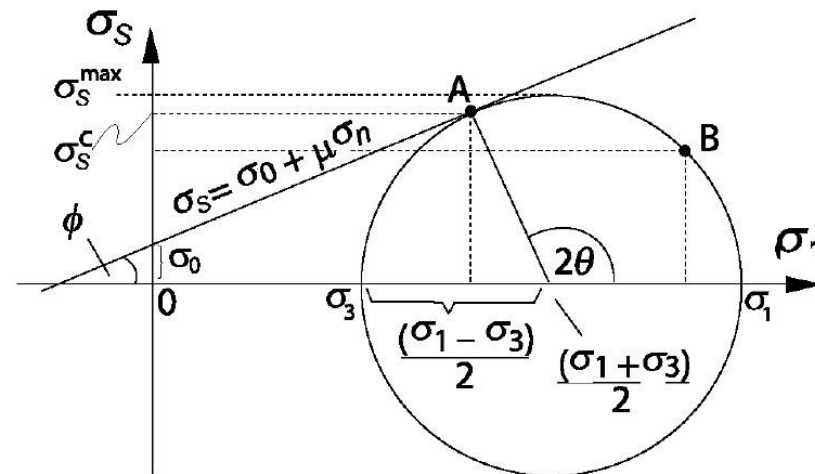

Rocks' deformation: brittle fracture

If fluid pressure plays a role, Mohr-Coulomb criterion is formulated as:

$\tau_c = \sigma_0 + \mu(\sigma_n - P_f)$, where P_f is the pore fluid pressure, then $\tau_c = \sigma_0 + \mu\sigma_n(1-\lambda)$, where $\lambda = P_f / \sigma_L$ (if $\sigma_n \sim \sigma_L$) is the ratio of pore fluid pressure to lithostatic stress (σ_L). If $\lambda = 1$, $\tau_c = \sigma_0$.

$\lambda=0$, 'dry' conditions. $\lambda=0.7$ wet conditions. $\lambda=0.37$ intermediate conditions (when the stress state is hydrostatic).

If preexisting cracks occur in a rock the remaining cohesion is negligible compared to the cohesion of an intact rock (Amonton's law):

$$\tau_c = \mu\sigma_n$$

At pressure below 200 MPa, the crust may be characterized by an internal coefficient of friction around: 0.85, then:

$$\tau_c = 0.85\sigma_n \quad \text{and} \quad \tau_c = 0.85\sigma_n(1-\lambda)$$

Rocks at a depth between 5 km – 15 km will fail at roughly 100 – 300 MPa

- Pore fluid pressure enhances fracturing by reducing the frictional coefficient and counteracting the normal stresses (σ_n) across the fault.
- The effect of pore fluid pressure explains faulting at depth, which would otherwise appear to require very high shear stresses because of the high normal stresses.

Rocks' deformation: Brittle fracture

Under compressional closed crack regime, the type of faulting which results depends upon which of the principal stresses is vertical: normal, strike-slip, and thrust faults occur depending on whether σ_1 , σ_2 or σ_3 is vertical.

Anderson's Theory reformulated the Mohr-Coulomb law in terms of differential stress ($\sigma_1 - \sigma_3$) and lithostatic stress ($\sigma_L = \rho gz$)

He took three cases to represent reverse faults, normal faults, and strike slip faults and assumed that $\sigma_L = \sigma_3$, $\sigma_L = \sigma_1$ and $\sigma_L = \sigma_2 = (\sigma_1 + \sigma_3)/2$.

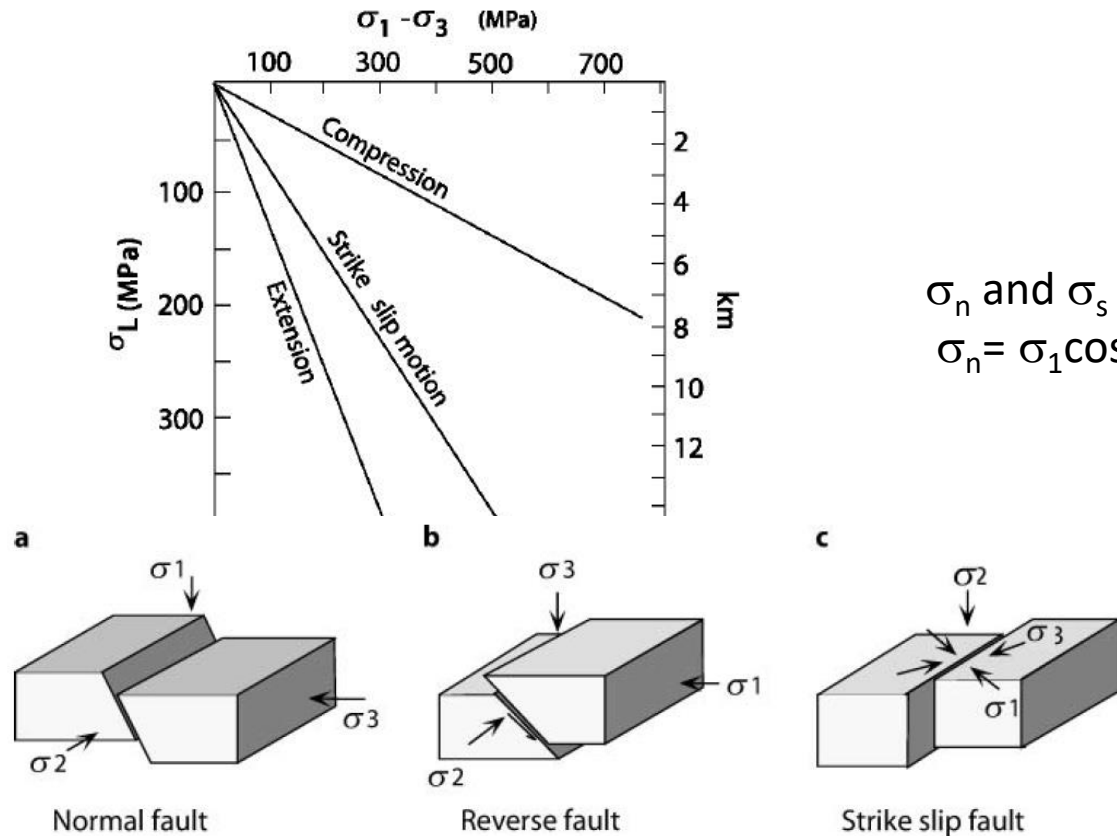

σ_n and σ_s are related to the maximum and minimum principal stresses:

$$\sigma_n = \sigma_1 \cos^2 \theta_s + \sigma_3 \sin^2 \theta_s$$

σ_1 = maximum principal stress
 σ_2 = intermediate principal stress
 σ_3 = minimum principal stress

Reverse fault:
$$\sigma_1 - \sigma_3 = \frac{2(\sigma_0 + \mu\sigma_L(1 - \lambda))}{\sqrt{\mu^2 + 1} - \mu}$$

Normal fault:
$$\sigma_1 - \sigma_3 = \frac{-2(\sigma_0 - \mu\sigma_L(1 - \lambda))}{\sqrt{\mu^2 + 1} + \mu}$$

Strike slip fault:
$$\sigma_1 - \sigma_3 = \frac{2(\sigma_0 + \mu\sigma_L(1 - \lambda))}{\sqrt{\mu^2 + 1}}$$

Rocks' deformation: brittle fracture

Near to the surface, at low temperatures, rocks deform in a brittle manner following an elasto-plastic rheology:

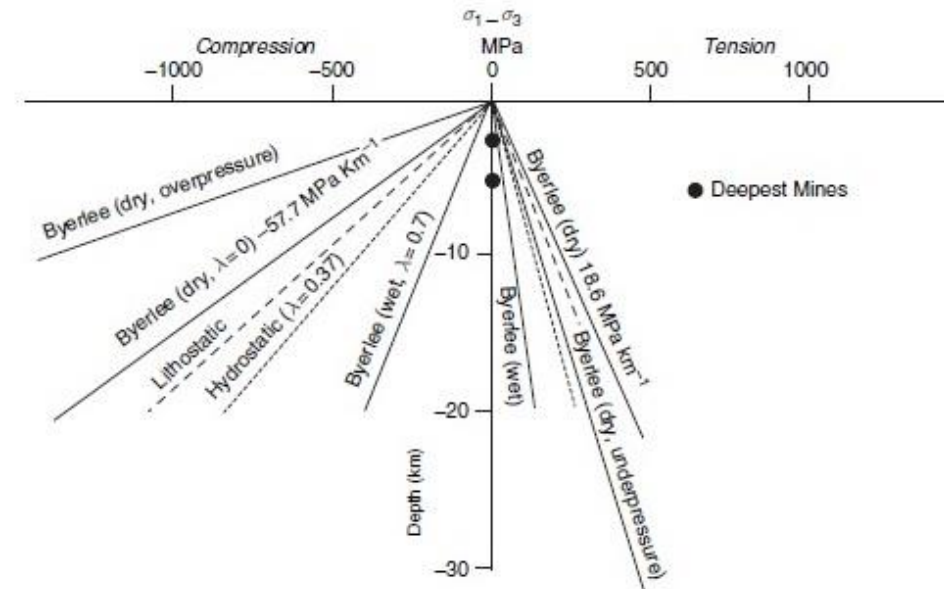
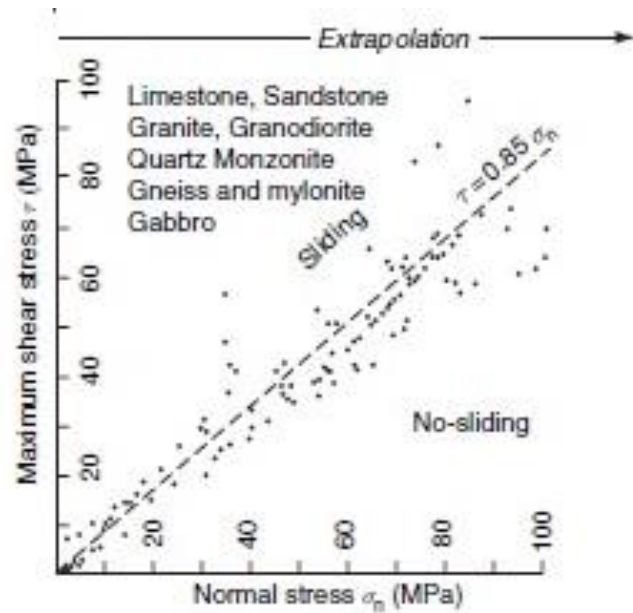

Presence of fluids decreases brittle strength by a factor of 5

Before breaking, they follow a linear relation between stress and strain

The activation of **broken bodies** follows **Byerlee's law**

The strength of a non-fractured and of a fractured body depend only on the confining pressure (=depth).

It does not depend on:

- temperature
- lithology (very weakly dependence through density)
- strain rate

Rocks' deformation: brittle fracture

Crustal strength profile for a quartz (Byerlee's friction) muscovite

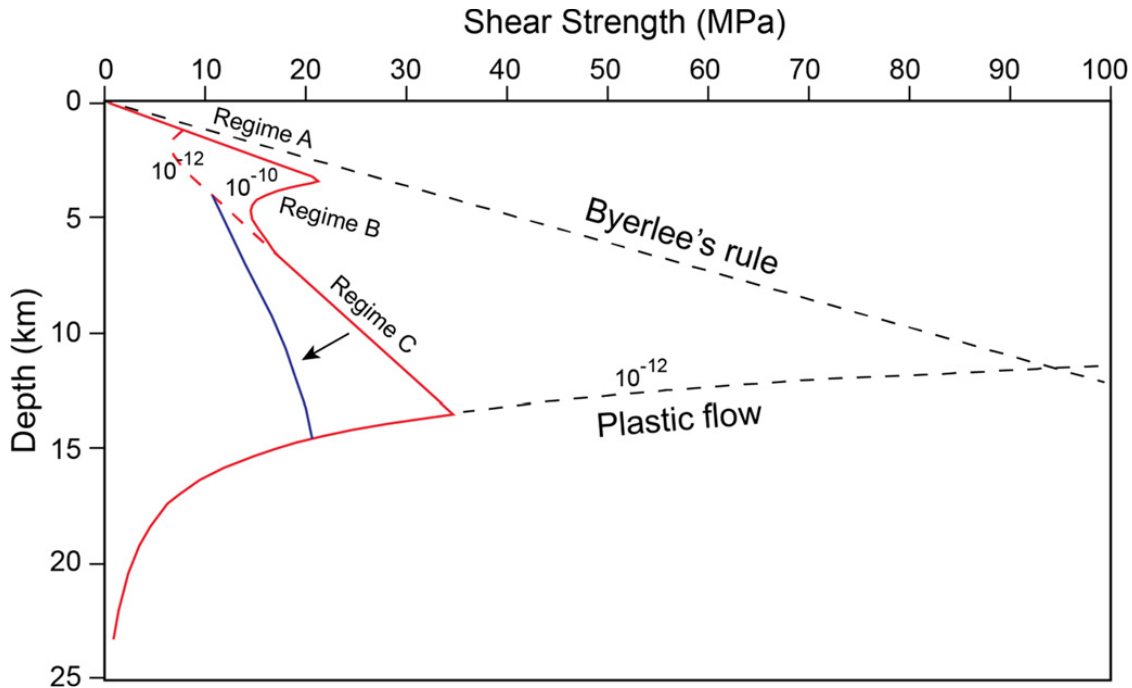

Three main deformation regimes in which the strength is dominated by: A) cataclastic deformation; B) pressure solution; C) frictional sliding on phyllosilicate foliae.

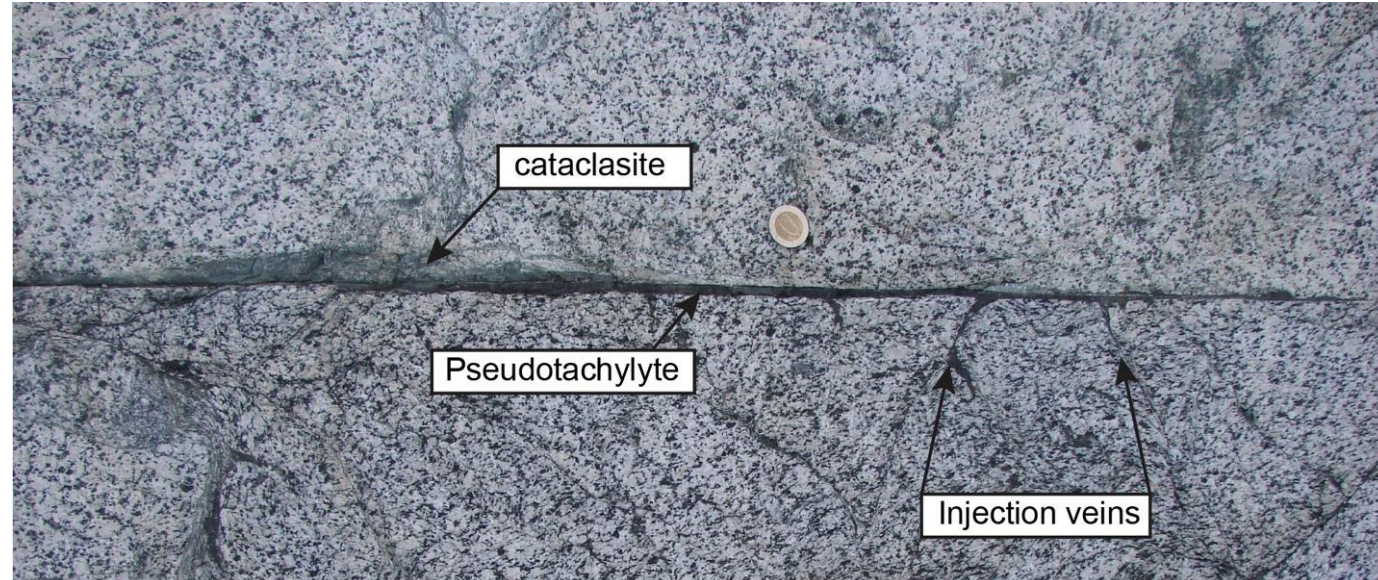

Cataclasite and pseudotachylyte bearing faults surround relatively intact blocks of tonalite, and pseudotachylyte overprints cataclasites.

Colletini et al., 2019, EPSL, 519

- Fault weakening induced by fluid-assisted reaction softening that can take place during the long-term evolution of the fault. Reaction softening promotes the replacement of strong minerals with phyllosilicates.
- This weakening originates at the grain-scale and is transmitted to the entire fault zone via the interconnectivity of the phyllosilicate-rich zones resulting in a friction coefficient as low as $0.1 < \mu < 0.3$.

Rocks' deformation: brittle fracture



Colletini et al., 2019, EPSL, 519

Reaction softening with increasing strain

- At the onset of deformation fracturing associated to cataclasis increases permeability favoring the influx of fluids (blue arrows) into the fault zone.
- Fluids react with the fine-grained cataclasite promoting dissolution of the strong granular phases and precipitation of phyllosilicates (green lines).
- At high strains the microstructure consists of an interconnected phyllosilicate-rich network where the deformation is predominantly accommodated by frictional sliding along the phyllosilicate lamellae. The phyllosilicate network is also a low-permeability horizon for transversal fluid flow favoring the development of fluid overpressure (blue zones).

Rocks' deformation: brittle fracture

Frictional properties of phyllosilicate-rich faults

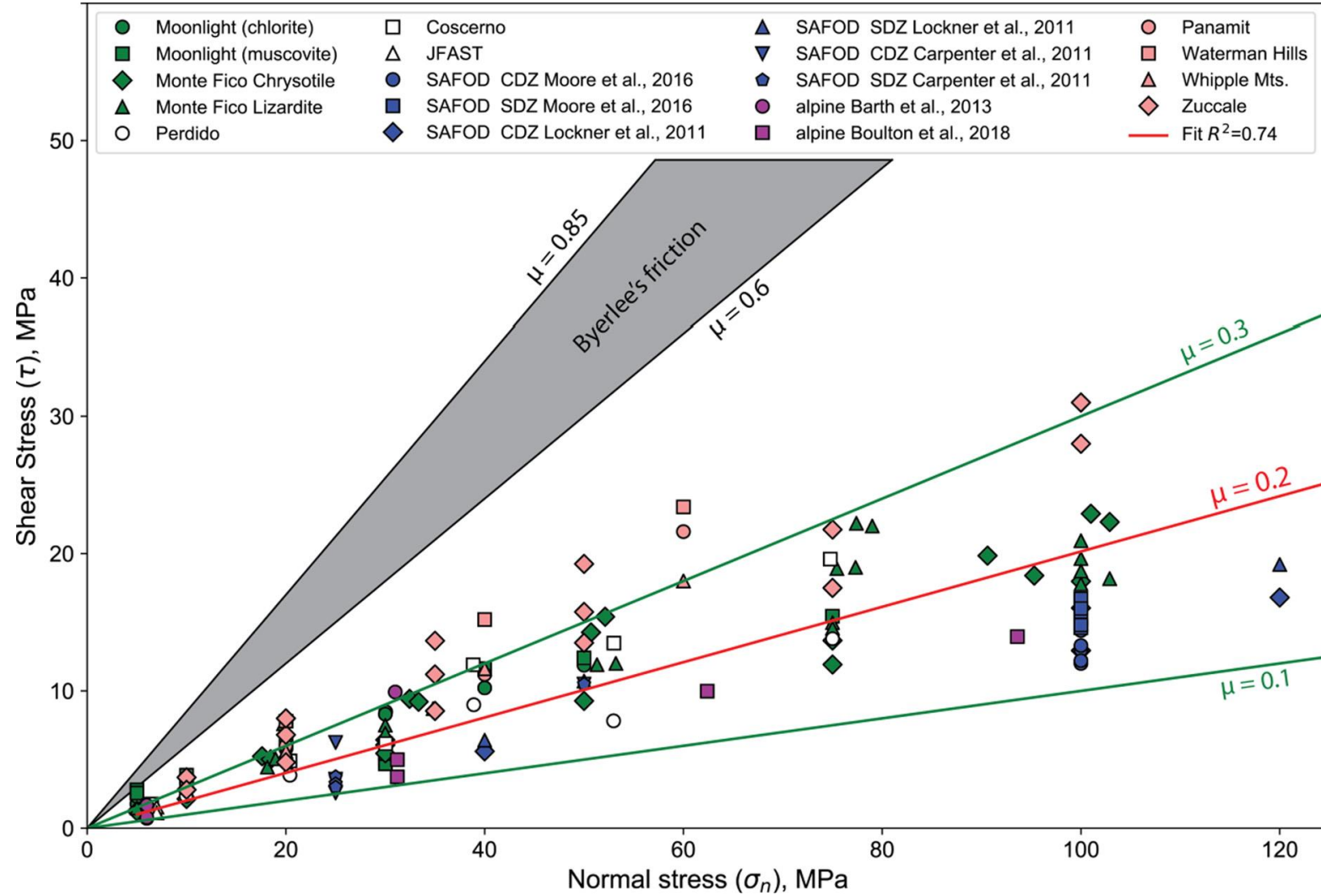

Rocks' deformation: brittle fracture

- Byerlee's laws describe the relationship between shear stresses and normal stresses (which relate to depth in the crust) in general, without explaining the spatial orientation of failure planes relative to the *principal stresses*.

Byerlee's law

Rheological parameters for the brittle deformation

In situ/lab: $\Delta\sigma = \sigma_1 - \sigma_3 = \alpha\rho gz(1 - \lambda)$

$\alpha = 1 - R^{-1}$	Normal faulting	$\alpha \sim 0.7$
$\alpha = R - 1$	Thrust faulting	$\alpha \sim 3$
$\alpha = (R - 1) / (1 + \beta(R - 1))$	Strike Slip	
$R = ((1 + \phi^2)^{1/2} - \phi)^{-2}$		
$\beta = (\sigma_2 - \sigma_3) / (\sigma_1 - \sigma_3) < 1$		

parameter	value/unit	definition
$\mu(<500\text{MPa})$	0.8	coefficient of friction in the crust
$\mu(>500\text{MPa})$	0.6	coefficient of friction in the mantle
$\sigma_0(<500\text{MPa})$	0	cohesion of the crust
$\sigma_0(>500\text{MPa})$	60 MPa	cohesion of the mantle
λ	0.4 and 0.8	pore fluid/lithostatic pressure ratio
z_c	35 km	thickness of the crust
z_l	125 km	thickness of the lithosphere
ρ_c	2 750 kg m ⁻³	density of the crust
ρ_m	3 300 kg m ⁻³	density of the mantle lithosphere

Rheology and strength of the lithosphere

Byerlee's law differs for tension and compression as a result of corresponding differences in brittle deformation (fault development)

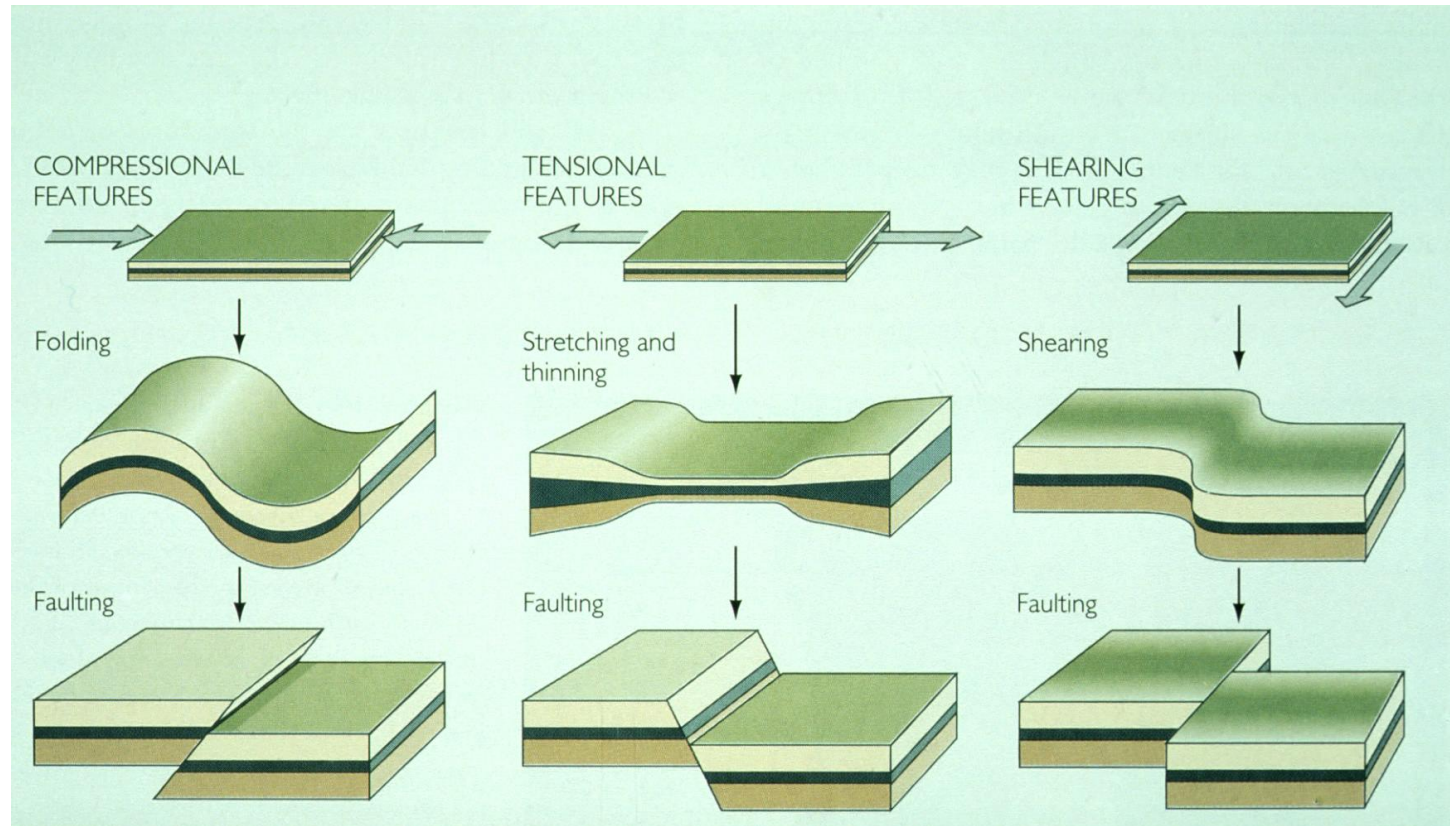

Rocks Ductile Deformation

mylonites

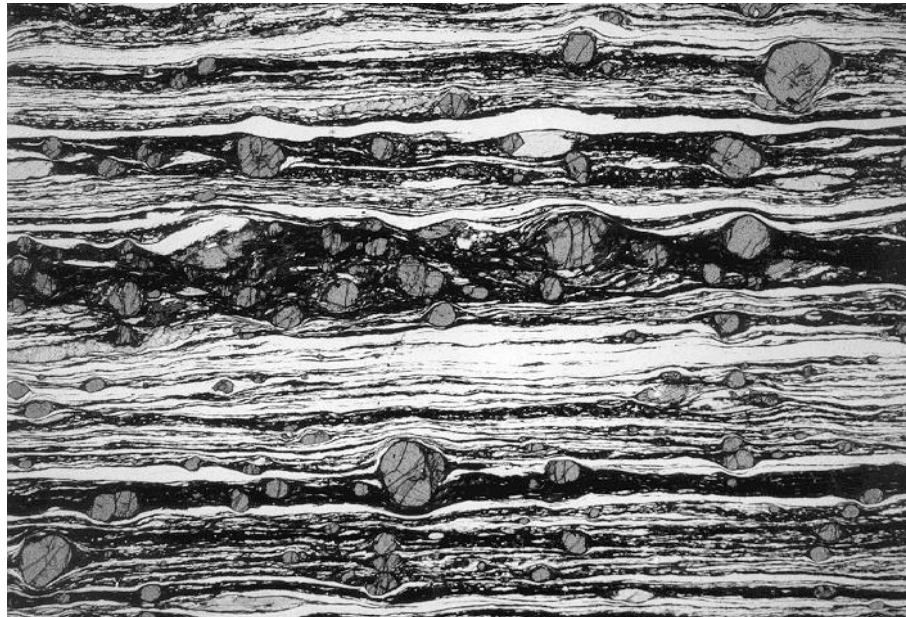
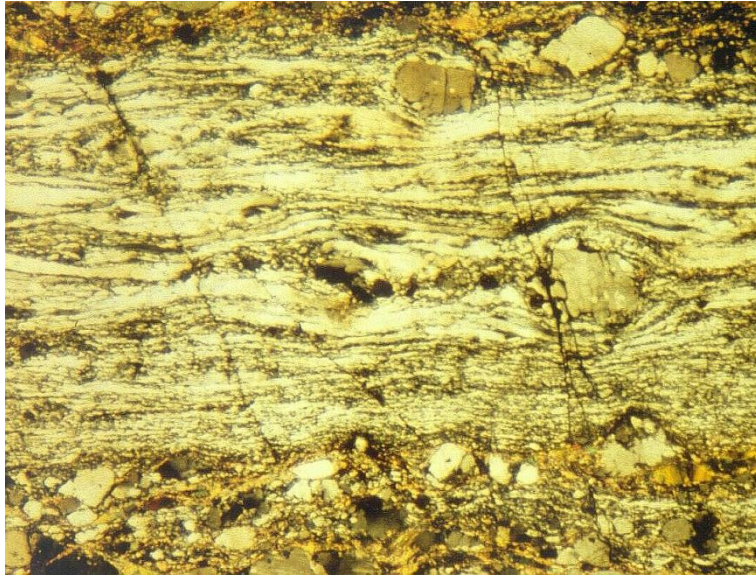

Soft (viscous) bands go through the entire rock and reflect huge deformations

Viscous deformation

- Plastic deformation describes the stress state at which rocks start to flow but not the amount of stress that occurs.
- Ductile deformation is related to the ability of materials to change form irreversibly, without fracturing.
- Viscous behaviour applies when the deformational stress is a function of strain rate.

Viscous deformation of ideal fluids is described by a proportionality between deviatoric stress (τ) and strain rate

$$\tau = 2\eta\dot{\epsilon} \quad \text{where } \eta \text{ is the dynamic viscosity}$$

The factor two derives from definition used in fluidodynamics: $\dot{\gamma} = 2\dot{\epsilon}$

A fluid that behaves according to a linear relationship is called *Newtonian fluid* (the larger the deviatoric stress that is applied, the faster the rock will deform)

Viscosity is strongly temperature dependent (Arrhenius relationship)

A_0 = pre-exponent constant

Q = Activation energy (J mol^{-1})

R = universal gas constant ($8.314472 \text{ J mol}^{-1} \text{ K}^{-1}$)

T = absolute temperature

$$\eta = A_0 e^{Q/RT}$$

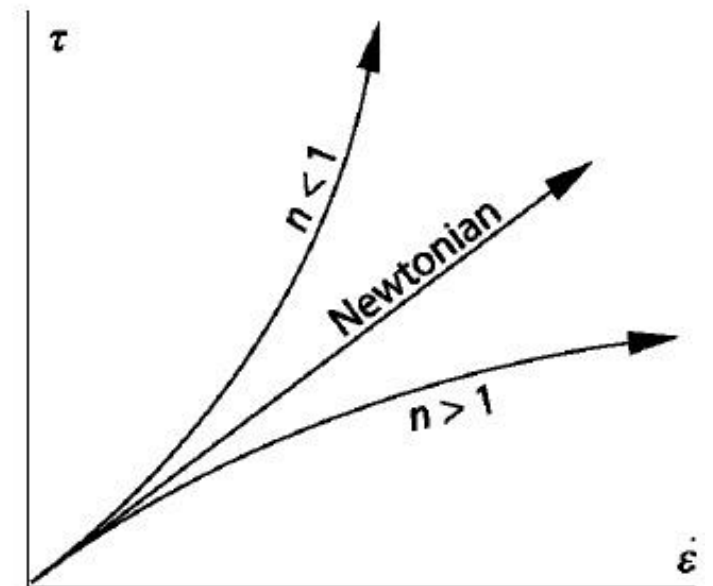

Viscosity trends toward infinity for $T=0$ and decreases exponentially to asymptotically approach the value A_0 at high temperatures

Rocks rarely deform as a Newtonian fluid, usually there is not a linear relationship between τ and η

$$\tau^n = A_{\text{eff}} \dot{\epsilon} \quad \text{with } n \text{ power law exponent (between 2 and 4 for most of rocks) and } A_{\text{eff}} \text{ is a material constant (Pa}^n \text{ s)}$$

Stress during viscous deformation depends on temperature, strain rate, and material constants, but not on confining pressure.

Viscous deformation

Diffusion and Dislocation creep

Viscous deformation implies a permanent distortion of a crystal lattice without fracture

- Diffusion creep results from the diffusion of atoms and vacancies through the interior and along the boundaries of crystalline grains.
- Dislocation creep results from migration of lines/planes defect

Diffusion Creep

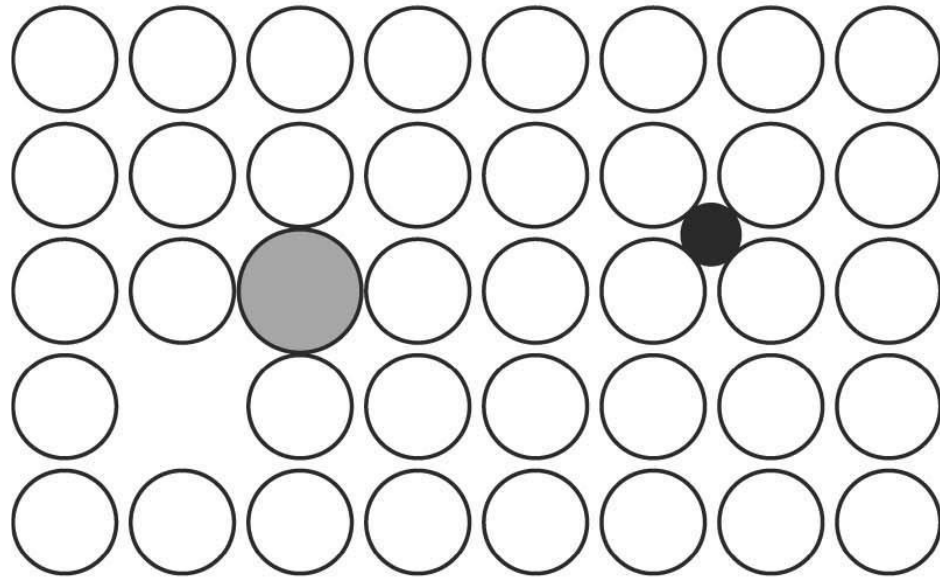

(a) (b)

(c)

Dislocation Creep

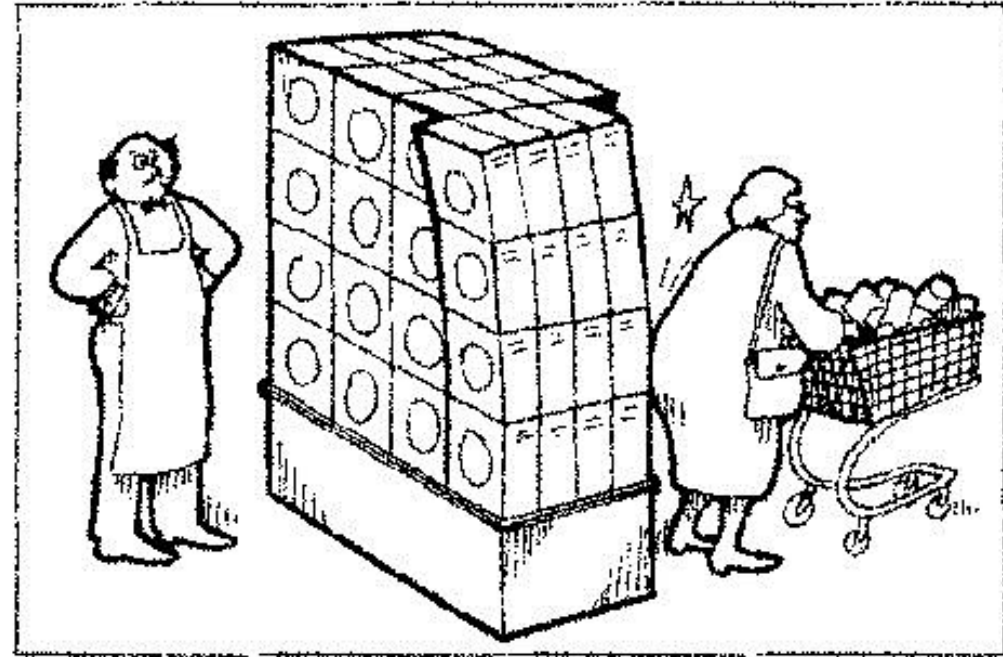

Viscous deformation

(Diffusion creep)

- Ductile deformation is rock-type dependent: Even small variations of mineral composition may result in quite different ductile properties.
- There are two major mechanisms of ductile deformation: **diffusion creep** and **dislocation creep** (different types: dislocation climb, glide, screw, edge, etc.).

Diffusion creep results from the diffusion of atoms and vacancies through the interior and along the boundaries of crystalline grains in a stress gradient and is dominant at $T \gg 1330 \text{ }^\circ\text{C}$ at relatively low stress.

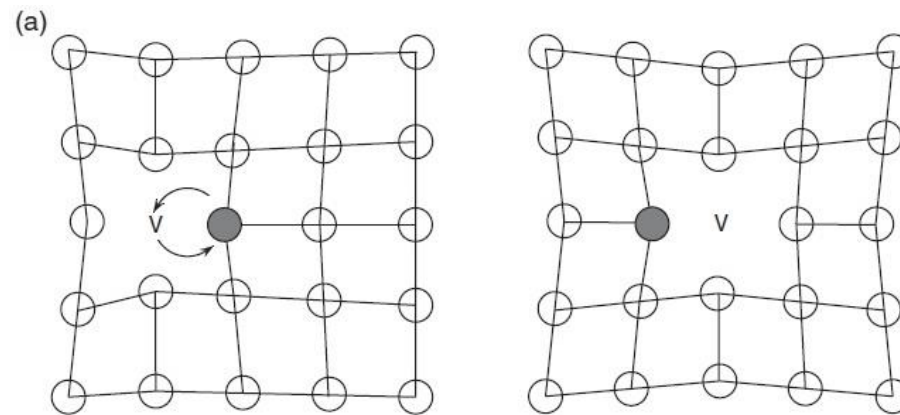

Diffusion creep is characterised by a linear (*Newtonian*) relationship between the strain rate $\dot{\epsilon}$ and an applied shear stress σ_s : $\dot{\epsilon} = A_{diff} \sigma_s$

where A_{diff} is a proportionality coefficient which depends on grain size, P - T conditions, oxygen and water fugacity.

Diffusion creep (as dislocation creep) is often calibrated from experimental data using a simple parameterized relationship (also called *flow law*) between the applied *differential stress* $\Delta\sigma$ (the difference between maximal and minimal applied stress) and the resulting *ordinary strain rate*:

$$\dot{\epsilon}^d = A a^{-m} \Delta\sigma^n \exp(-H/(RT))$$

$\dot{\epsilon}^d$ is the shear strain rate, a is a grain size, m is a diffusion constant, A is a material constant, n is power law constant, $\Delta\sigma = \sigma_1 - \sigma_3$, R is Boltzmann's gas constant, H is creep activation enthalpy ($H = Q + PV$, where Q is activation energy, P is pressure, and V is activation volume), and T is absolute temperature.

Viscous deformation

(Dislocation creep and Dorn Law)

- Dislocation creep results from migration of dislocations (gliding motions of a large number of imperfections in the crystalline lattice structure) and is dominant at higher stresses (< 200 MPa) and low temperature ($T > 300 \text{ }^\circ\text{C} < 1330 \text{ }^\circ\text{C}$).
- The strain produced depends on the dislocation density, which increases with the stress applied and results in a non-linear (*non-Newtonian*) relationship between the strain rate and deviatoric stress: $\dot{\epsilon} = A_{disl} \tau^n$

A_{disl} = proportionality coefficient, independent on grain size, but dependent on P - T conditions, oxygen and water fugacity, and $n=2-4$ is the stress exponent.

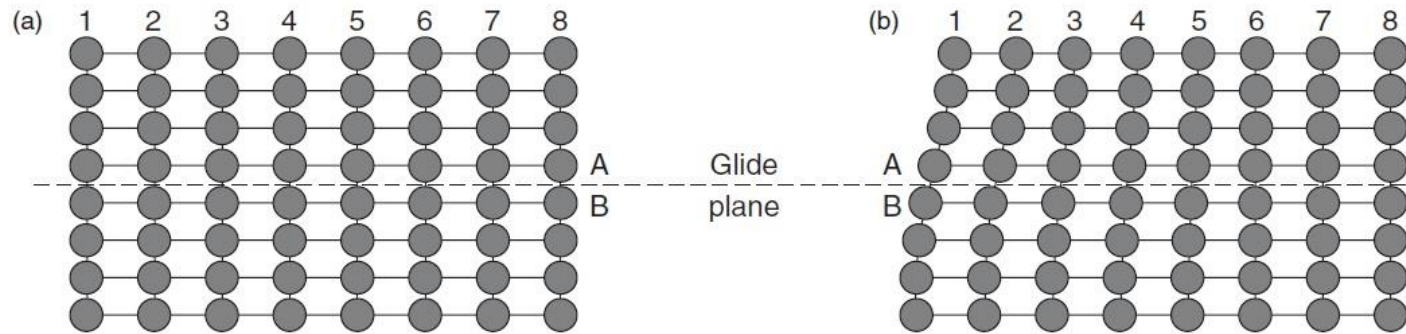

Parameterized relationship between the applied *differential stress* $\Delta\sigma$ (the difference between maximal and minimal applied stress) and the resulting *ordinary strain rate* for dislocation creep gives:

$$\dot{\epsilon}^d = A \Delta\sigma^n \exp(-H(RT)^{-1})$$

At moderate-temperature–high-stress conditions, $m=0$ and $n=2-4$ (Non Newtonian Fluid)

The **Peierls mechanism or Dorn Law** is a temperature-dependent mode of plastic deformation (also called *exponential creep*) which takes over from the dislocation creep mechanism at elevated stresses (> 200 MPa):

$$\sigma_{DL} = \sigma_D \left(1 - \left[-\frac{RT}{E_D} \ln\left(\frac{\dot{\epsilon}}{A_D}\right) \right]^{\frac{1}{2}} \right)^2 \quad \text{Demouchy et al., 2013, PEPI, 220}$$

σ_D is the Peierls stress that limits the strength of the material, A_D is a material constant for the Peierls creep ($\text{Pa}^{-2}\text{s}^{-1}$), E_D is the activation energy (J mol^{-1}).

- Stress during viscous deformation depends on temperature, strain rate, and material constants, but not on confining pressure.**

Viscous deformation (Effective Viscosity)

In rocks and mineral aggregates, both dislocation and diffusion creep can occur simultaneously under applied stress, which can be expressed in the following relation for the effective viscosity:

$$\dot{\epsilon}_{ij} = \dot{\epsilon}_{ij(disl)} + \dot{\epsilon}_{ij(diff)} \quad \dot{\epsilon}_{ij} = \frac{\sigma'_{ij}}{2\eta_{eff}}, \quad \dot{\epsilon}_{ij(disl)} = \frac{\sigma'_{ij}}{2\eta_{disl}}, \quad \dot{\epsilon}_{ij(diff)} = \frac{\sigma'_{ij}}{2\eta_{diff}}$$

In order to use the experimentally parameterized equations in numerical modelling, one needs to reformulate it in terms of an **effective viscosity** (η_{eff}), written as a function of the second invariant of either the deviatoric stress (σ_{II}), or strain rate ($\dot{\epsilon}_{II}$).

$$\sigma_{II} = 2\eta_{eff}\dot{\epsilon}_{II} \quad \eta_{eff} = \frac{\sigma_{II}}{2\dot{\epsilon}_{II}} \quad \eta_{eff} = \frac{\tau_s}{\dot{\epsilon}} = A_{eff}^{1/n} \times \dot{\epsilon}^{(1/n)-1}$$

The reformulation should also take into account the type of performed rheological experiments in order to establish the proper relations between σ_{II} and σ_d , as well as between $\dot{\epsilon}_d$ and $\dot{\epsilon}_{II}$

In case of an axial compression experiment:

$$\sigma_d = \sqrt{3}\sigma_{II} \quad \dot{\epsilon}_d = \frac{2}{\sqrt{3}}\dot{\epsilon}_{II}$$

In case of simple shear experiments:

$$\sigma_d = 2\sigma_{II} \quad \dot{\epsilon}_d = 2\dot{\epsilon}_{II}$$

Viscous deformation

(Diffusion creep and Dislocation creep)

Typical example of experimental data on ductile flow in rocks
(olivine aggregates, power, and Dorn flow laws for different temperature–stress domains)

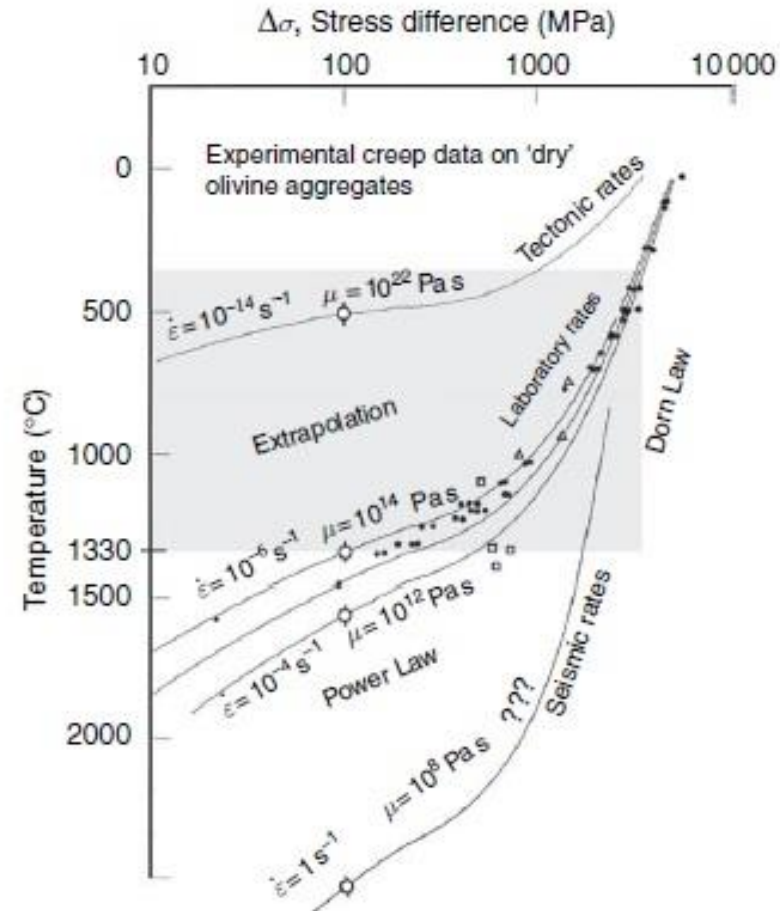

μ = predicted viscosity values, for 100 MPa stress level.

- The typical strain rates used in experiments (10^{-6} – 10^{-4} s^{-1}) are 10 orders of magnitude higher than those in nature (10^{-14} – 10^{-17} s^{-1}), which poses a serious question on the possibility of extrapolation.

Dominant process responsible for the flowing rock

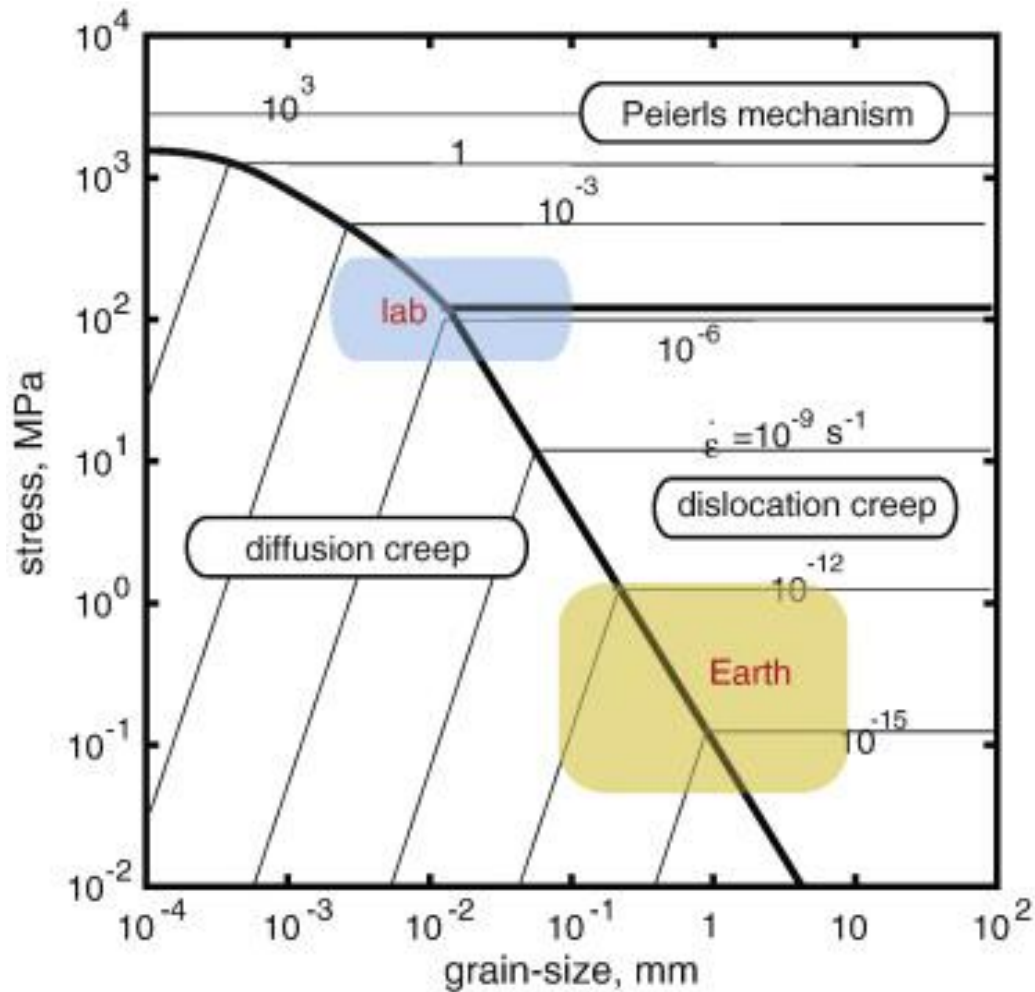

- For many deformation mechanisms, increase in temperature has an effect similar to a decrease in strain rate.
- Therefore, extrapolation of experimental results to geologically realistic strain rates is possible by 'projection' of data from experiments carried out at higher temperature.

Dominant process responsible for the flowing rock

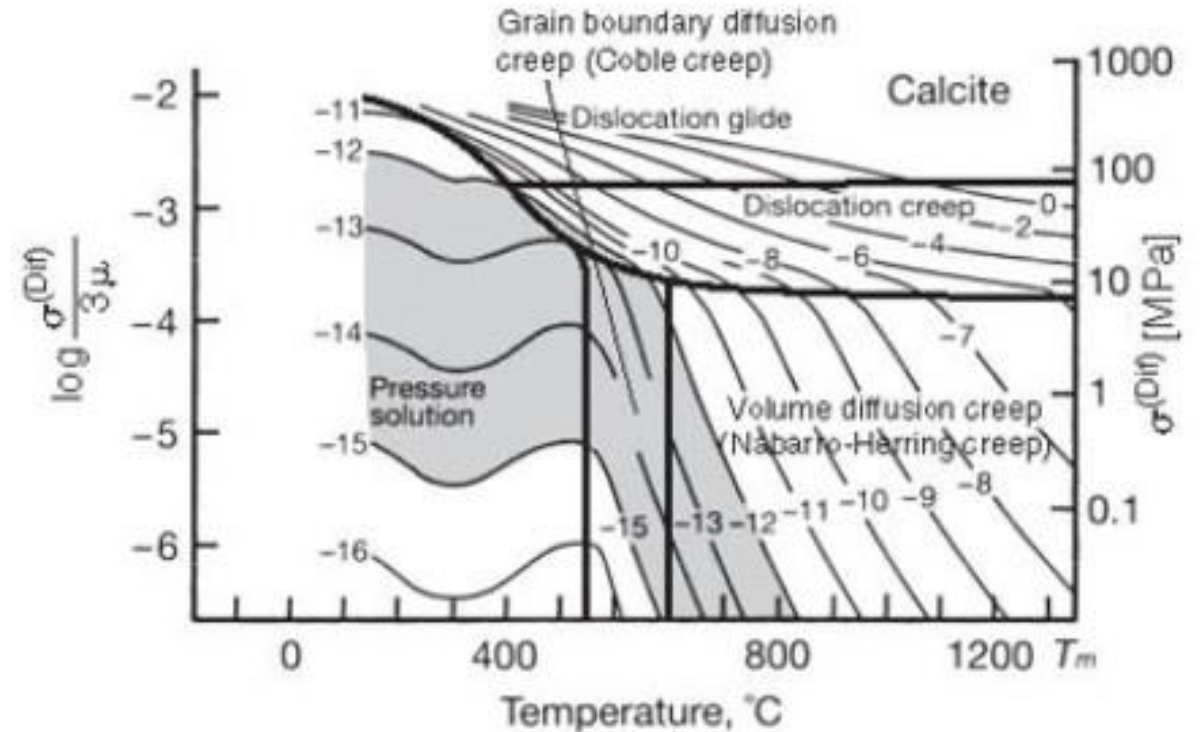
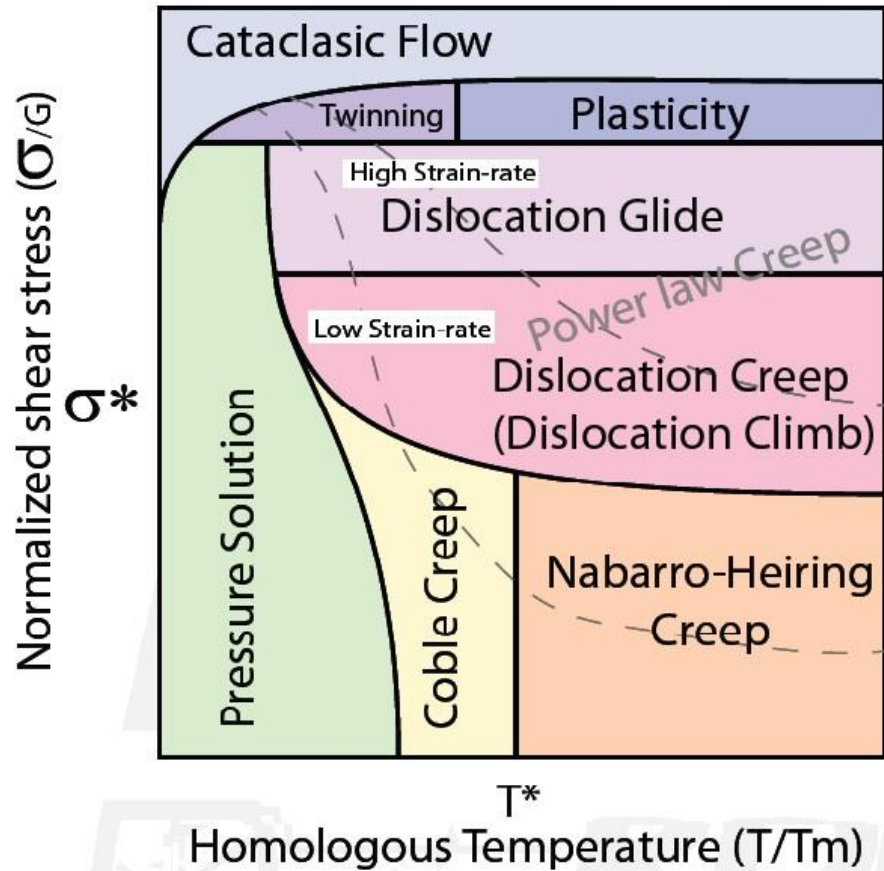

- **Cataclasis:** Normal pressure dependent fracturing, frictional sliding between particles.
- **Dislocation creep:** Movement of dislocations through the crystal lattice.
- **Pressure-Solution:** Dissolution of grain boundaries, low temperature and mostly triggered from interstitial fluids.
- **Coble Creep:** Vacancies diffuse around the grain margins (change in shape of a crystal).
- **Nabarro-Herring Creep:** Vacancies moving through a crystal (change in shape of a crystal).

Pressure Solution

Stylolite in limestone

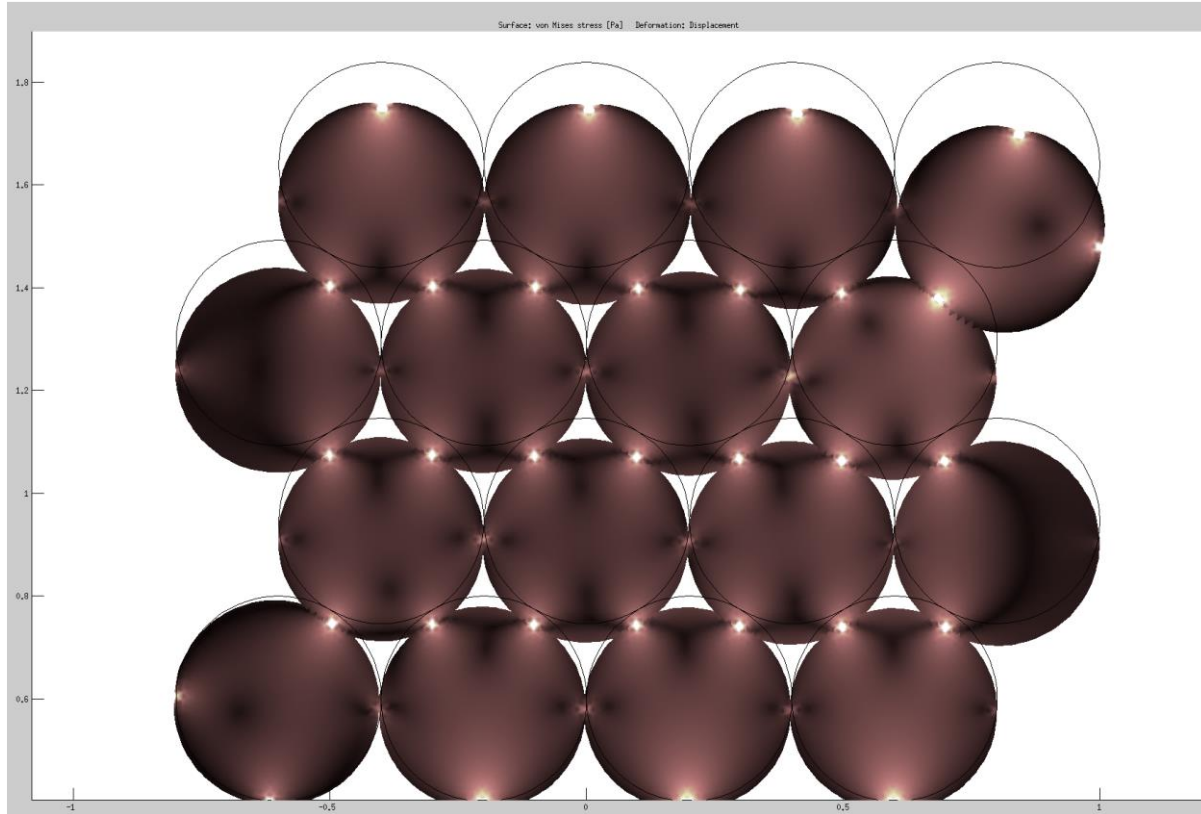

- Pressure-Dissolution occurs on systems bearing an inter-granular fluid (solid diffusion is too slow): It consists in the localized dissolution of grain boundaries generated from high differential pressure source points.
- Dissolved material is diffused away from sites of high solubility to low solubility.

Strength of the Lithosphere

The lithosphere is a layer cake with layers with different composition and rheology

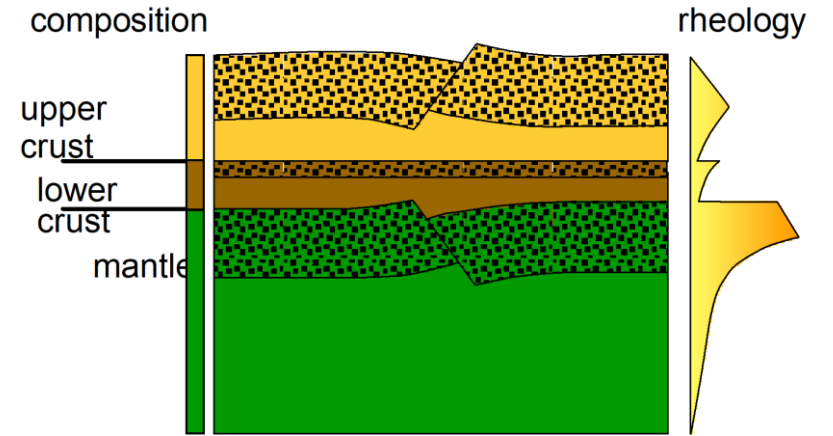

An attempt to clarify terminology issues

Rheology <i>(relations between applied stress and obtained strain)</i>
<p>Elasto plastic: Flow-law independent from strain rate, grain-size and temperature. Strong dependency on pressure</p>
<p>Viscous: Flow laws strongly dependent on grain-size, strain-rate and temperature. Little dependence on pressure</p>

Deformation mechanisms <i>(physical behaviour of the rock during deformation)</i>
<p>Cataclasis: Grains are fractured or slide against each other. Dilation occurs. The rock loses continuity</p>
<p>Creep: Various mechanisms: dislocation glide and creep, solid state diffusion, pressure solution, grain boundary sliding.... The rocks does not loose continuity</p>



Geometry <i>(Distribution of deformation in the considered body)</i>
<p>Discrete: Shear zones are observed separating domains with little deformation</p>
<p>distributed: The entire body is deformed</p>
<p>Ductile!</p>

Strength of the Lithosphere (Yield Strength Envelopes)

Strength describes the critical value which the differential stress must reach to cause permanent deformation

- The strength profile describes the rheology of the continental lithosphere.
- It is composed of straight lines for brittle fracture (increases with depth because of pressure) and curved lines for viscous deformation (decreases with depth because of the increase of temperature).
- A rock at a given depth will deform according to the deformation mechanism that requires less stress.

(tension)
(compression)

$$\sigma_{brittle} = 0.7 * \rho * g * z$$

$$\sigma_{brittle} = 3 * \rho * g * z$$

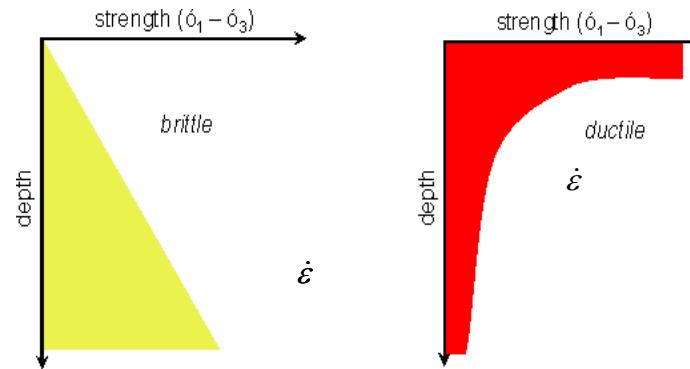

Dislocation creep for stress < 200 MPa

$$\dot{\epsilon} = \sigma_{ductile}^n A \exp(-Q / RT)$$

Dorn Law for stress > 200 MPa

$$\sigma_{DL} = \sigma_D (1 - [-\frac{RT}{E_D} \ln(\frac{\dot{\epsilon}}{A_D})]^{1/2})^2$$

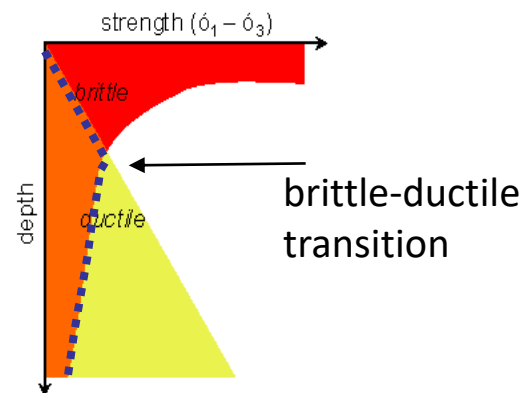

$\dot{\epsilon}$ = strain-rate

σ = differential stress

T = temperature

Q or E_D = activation energy of creep

R = universal gas constant

σ_D = Peierls stress

A_D = material constant for the Peierls creep

Creep parameters

Diffusion creep at $T \gg 1330 \text{ }^\circ\text{C}$

$$\dot{\epsilon}^d = A a^{-m} \Delta\sigma^n \exp(-H/(RT))^{-1}$$

Power Law for stress < 200 MPa

$$\dot{\epsilon} = \sigma_{ductile}^n A \exp(-Q/RT)$$

Dorn Law for stress > 200 MPa

$$\sigma_{DL} = \sigma_D \left(1 - \left[-\frac{RT}{E_D} \ln\left(\frac{\dot{\epsilon}}{A_D}\right)\right]^{\frac{1}{2}}\right)^2$$

Table 1 Commonly inferred parameters for diffusion creep, $n = 1$

Rock/mineral	A ($\text{s}^{-1} \text{Pa mm}^m$)	m	Q (kJ mol^{-1})	Comments
Dry Olivine	7.7×10^{-8}	1-3	536	Karato <i>et al.</i> (1986)
Wet Olivine	1.5×10^{-9}	1-3	498	Karato <i>et al.</i> (1986)

Karato S (1986) Does partial melting reduce the creep strength of the upper mantle? *Nature* 319: 309-310.

Table 2 Commonly inferred parameters of dislocation creep

Rock/mineral	A ($\text{MPa}^{-n} \text{s}^{-1}$)	n	Q (kJ mol^{-1})	Comments
Wet quartzite	10^{-4}	2.4	160	Brace and Kohlstedt (1980) Kirby and Kronenberg (1987); Kohlstedt <i>et al.</i> (1995)
Wet quartzite	1.1×10^{-4}	4	223	Gleason and Tullis (1995) (Figure 3b)
Dry quartzite	6.3×10^{-6}	2.4	156	Ranally and Murphy (1987)
Dry diabase	$10^{-3.7}$	3.4	260	Kirby (1983)
Dry diabase	2.0×10^{-4}	3.4	260	Kirby (1983)
Columbia diabase (weak)	190 ± 110	4.7 ± 0.6	485 ± 30	Mackwell <i>et al.</i> (1998) (Figure 3b)
Maryland diabase (strong)	8 ± 4	4.7 ± 0.6	485 ± 30	Mackwell <i>et al.</i> (1998)
Granite (wet)	2×10^{-4}	1.9	140	Mackwell <i>et al.</i> (1998)
Wet diorite	3.2×10^{-2}	2.4	212	Ranally (1995)
Dry mafic granulite	1.4×10^4	4.2	445	Wilks and Carter (1990)
Undried adirondac granulite	3.18×10^{-4}	3.1	243	Wilks and Carter (1990)
Undried pikwitonei granulite	1.4×10^4			Wilks and Carter (1990) (Figure 3b)
Dry olivine	10^4	3	520	Chopra and Paterson (1984)
Dry olivine	4.8	3.0	502	Evans and Kohlstedt (1995)
Dry dunite	4.85×10^4	3.5	535	Hirth and Kohlstedt (1996)
Microgabbro	5×10^9	3.4	497	Wilks and Carter (1990)
Wet Olivine (dunite)	275.6	4.45	498	Chopra and Paterson (1981)
Wet Olivine	4.876×10^6	3.5	515 ± 30	Hirth and Kohlstedt (1996)
Wet Aheim dunite	2.6	4.5	498	Evans and Kohlstedt (1995)
Dry Anita Bay dunite	4.5	3.6	535	Chopra and Paterson (1981)
Wet Synthetic San Carlos olivine	1.5×10^6	3	250	Karato <i>et al.</i> (1986)
Dry Synthetic olivine	5.4	3.5	540	Karato <i>et al.</i> (1986)
Wet Synthetic olivine	3.3	3.0	420	Karato <i>et al.</i> (1986)
wet Anita Bay dunite	955	3.4	444	Chopra and Paterson (1984)
wet Aheim dunite	417	4.48	498	Chopra and Paterson (1984) Figure 3b
Dry olivine	4.85×10^4	3.5	535	Chopra and Paterson (1981) Figure 3b
Olivine (Dorn's dislocation glide) at $\sigma_1 - \sigma_3 \geq 200 \text{ MPa}$				$\dot{\epsilon}_0 = 5.7 \times 10^{11} \text{ s}^{-1}$, $\sigma_0 = 8.5 \times 10^3 \text{ MPa}$; $H^* = 535 \text{ kJ mol}^{-1}$

Table 3 Peierls plasticity

Rock/mineral	τ_0 (MPa)	$\dot{\epsilon}$ (s^{-1})	Q (kJ mol^{-1})	Comments
Synthetic olivine	8500	5.7×10^{-11}	536	Karato <i>et al.</i> (1998)
San Carlos peridotite	9100	1.3×10^{-12}	498	Goetze and Evans (1979)

Rheology of the Lithosphere

Dependency of viscous deformation on temperature, strain rates, and regime of deformation

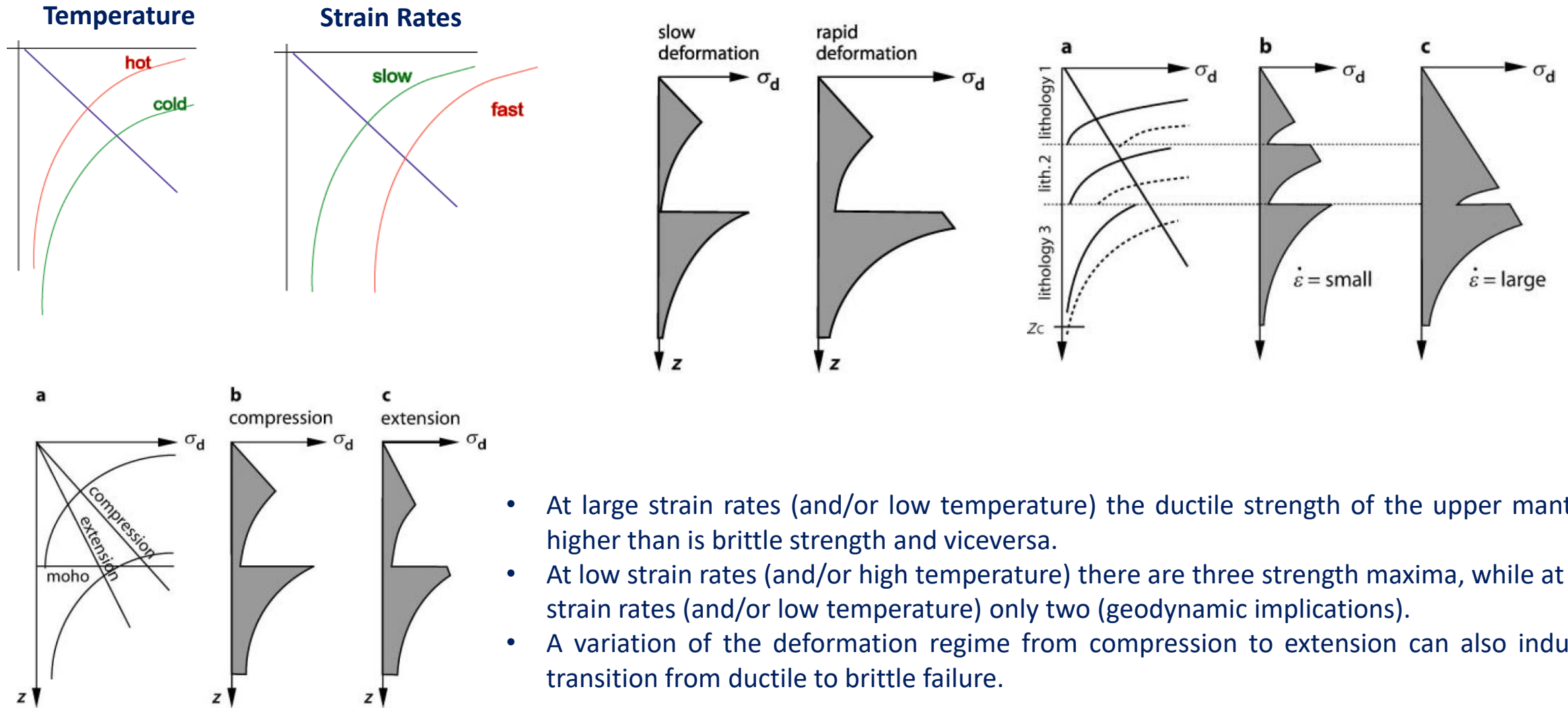

- At large strain rates (and/or low temperature) the ductile strength of the upper mantle is higher than is brittle strength and viceversa.
- At low strain rates (and/or high temperature) there are three strength maxima, while at high strain rates (and/or low temperature) only two (geodynamic implications).
- A variation of the deformation regime from compression to extension can also induce a transition from ductile to brittle failure.

Rheological strength profiles

Characteristic geometry of strength profiles:

- Oceanic geotherms are time dependent and there is no radiogenic heat production in the oceanic lithosphere.
- The rheology of oceanic lithosphere is therefore largely governed by the rheology of olivine (only one maximum in the strength profile).
- Continental lithosphere is very heterogeneous in terms of thickness and composition and thus its strength profile has a variable number of maxima.

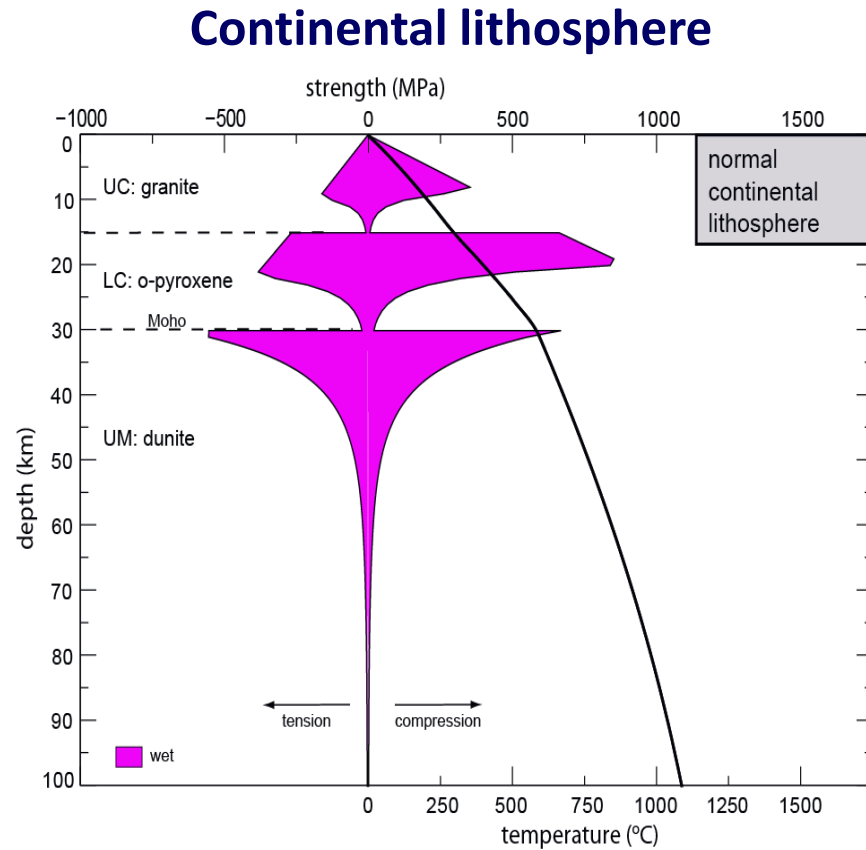
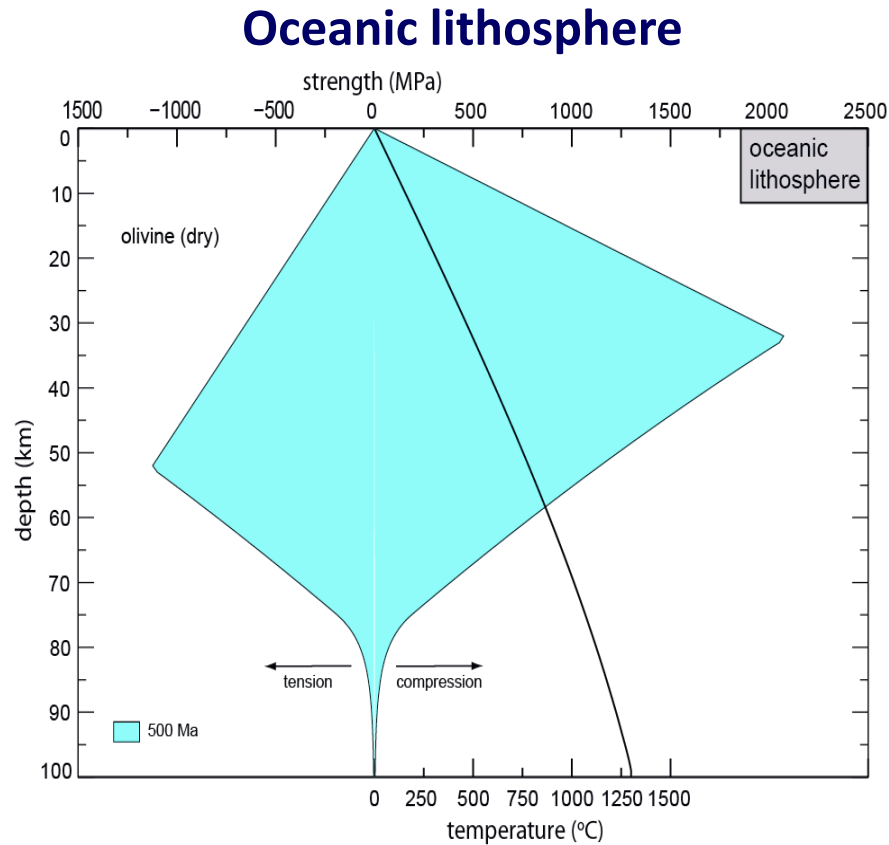

Rheological strength profiles

A colder lithosphere implies a mechanically stronger lithosphere

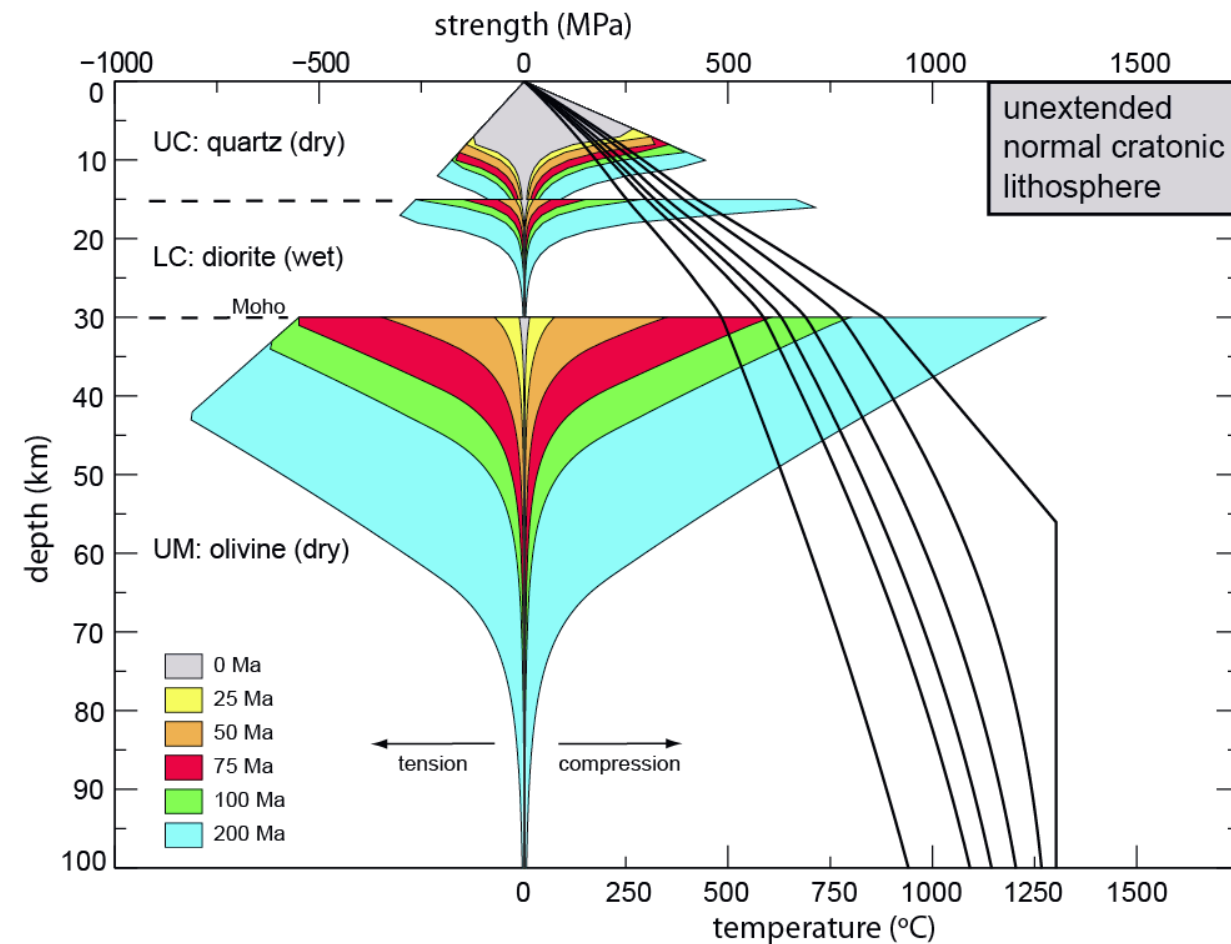

The presence of water causes the mechanical strength to decrease significantly

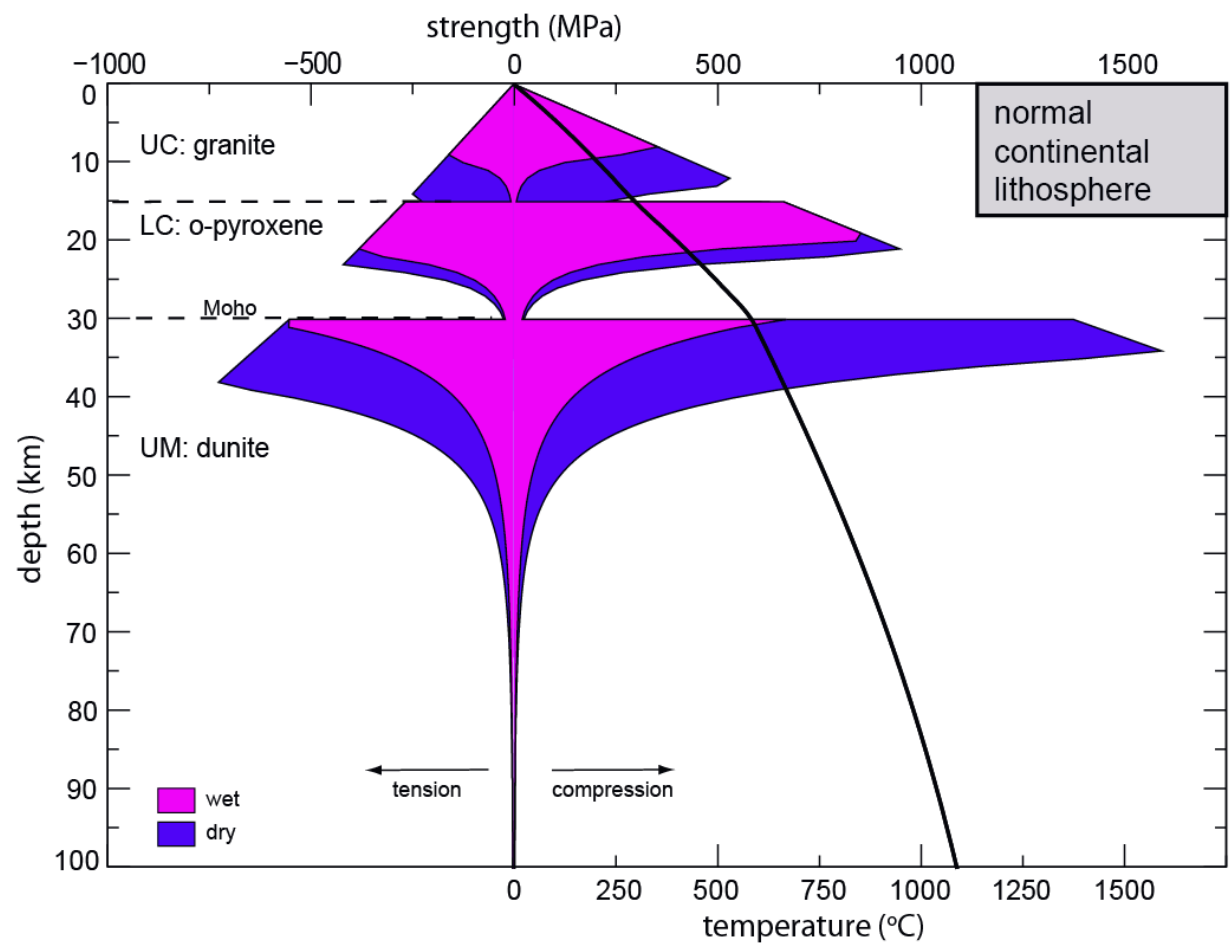

Rheological strength profiles

YSEs crustal thickness dependency

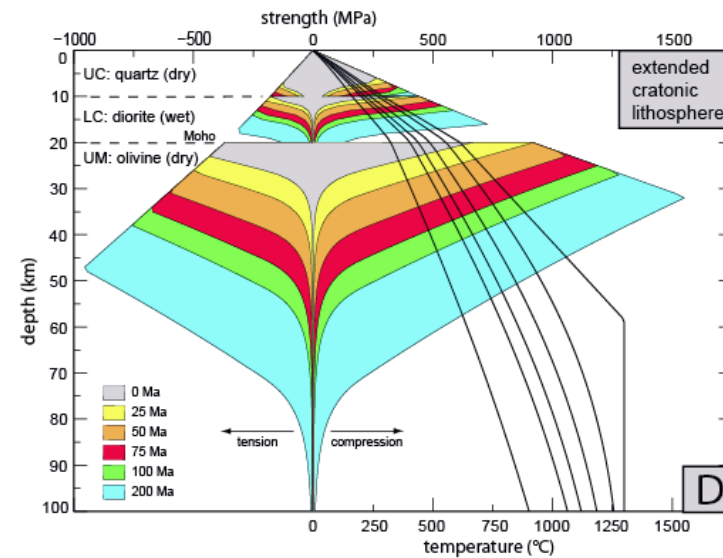
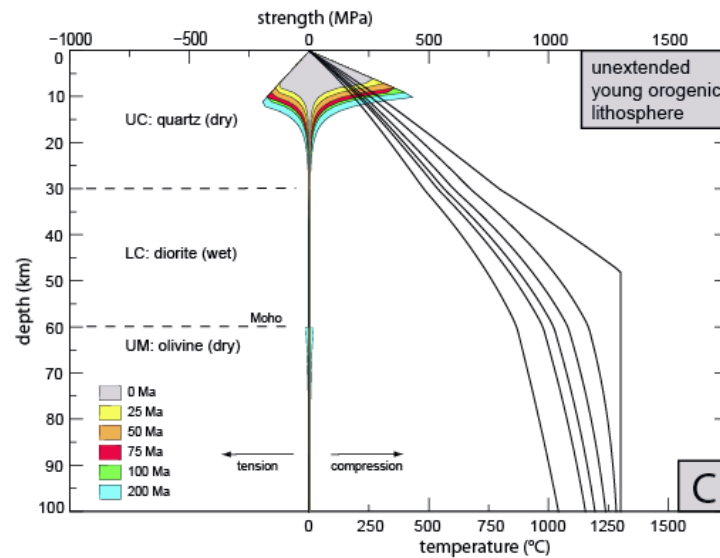
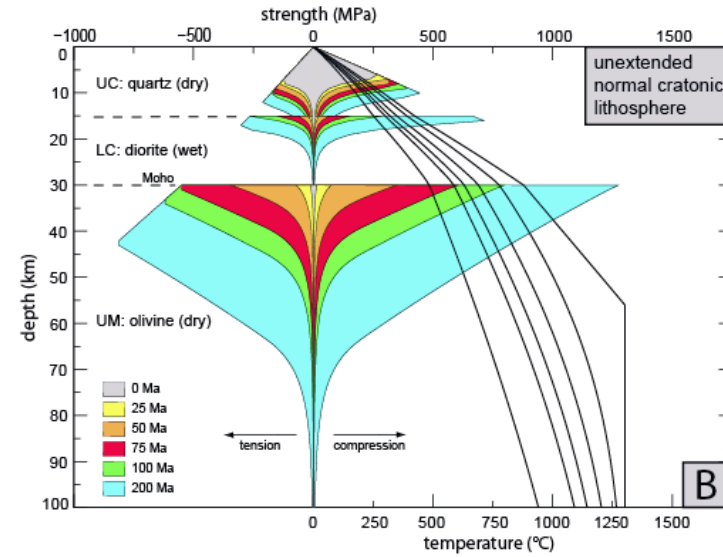
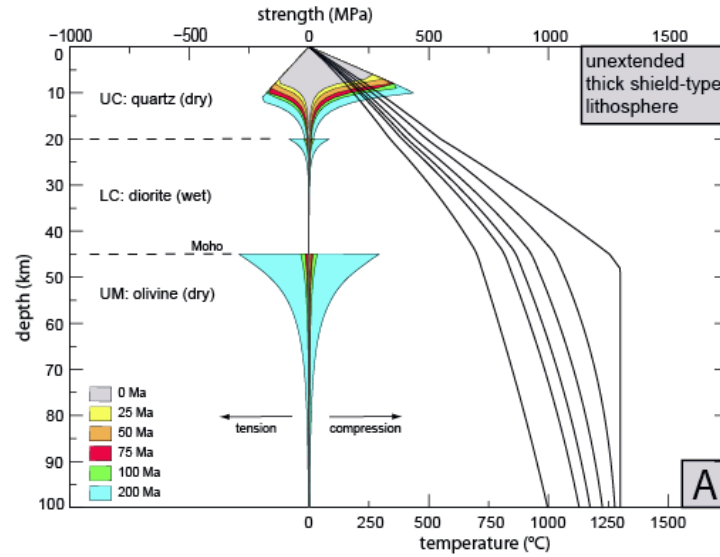

Rheological strength profiles

YSEs rheology dependency

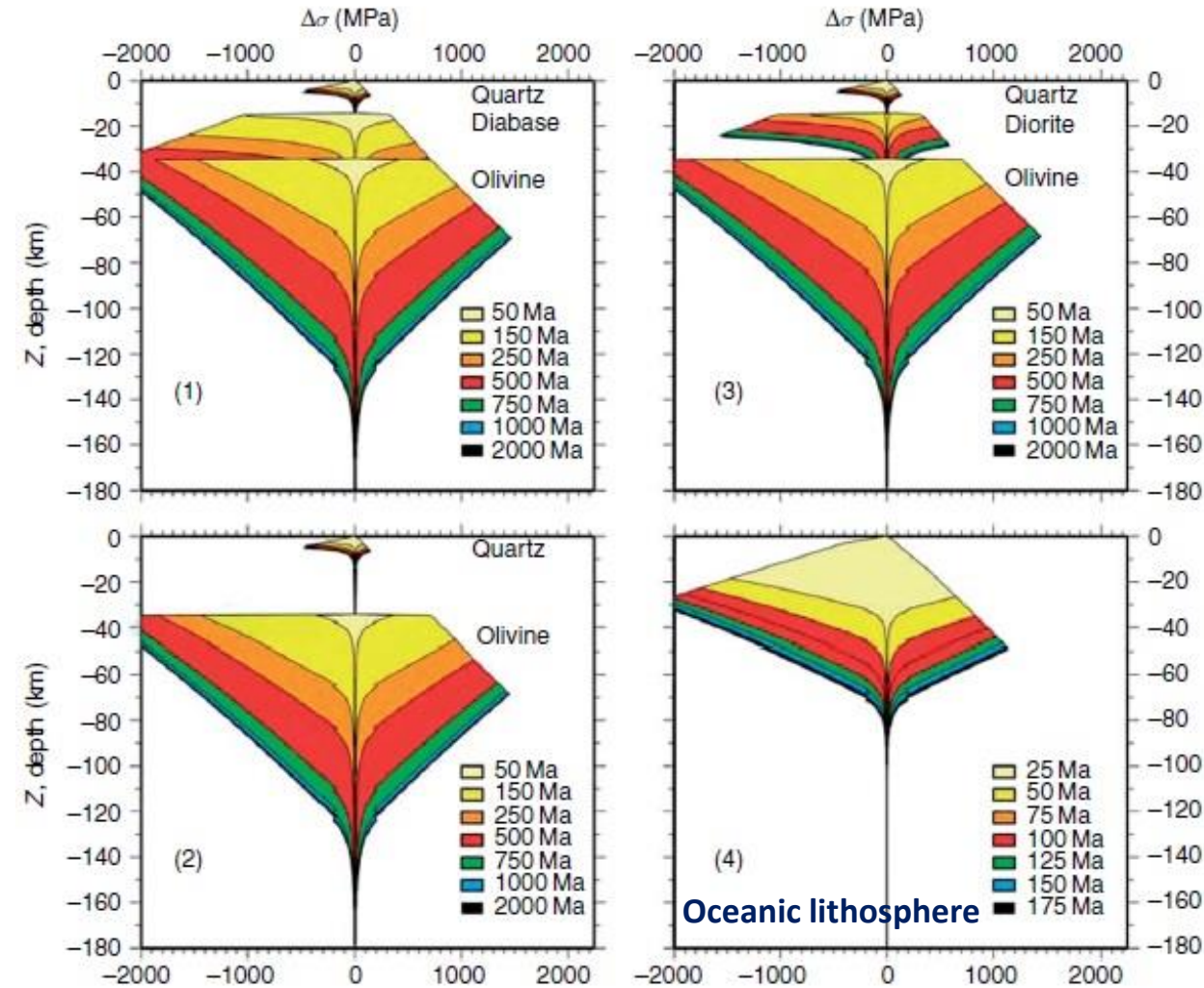

YSEs strain rates dependency

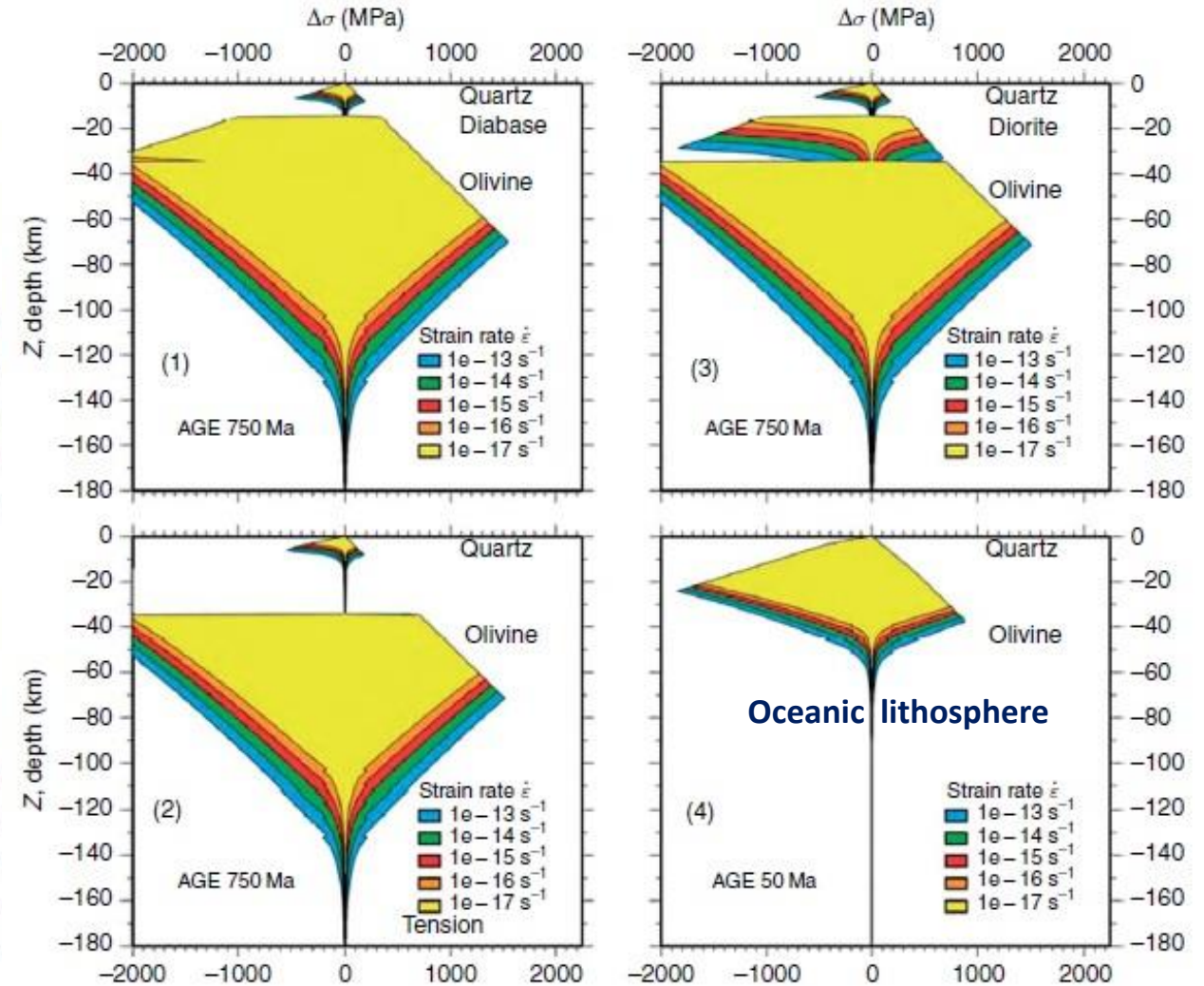

Rheological strength profiles

Influence of compositional variations, plate thickness (100 or 200 km), and fluid content on continental YSE

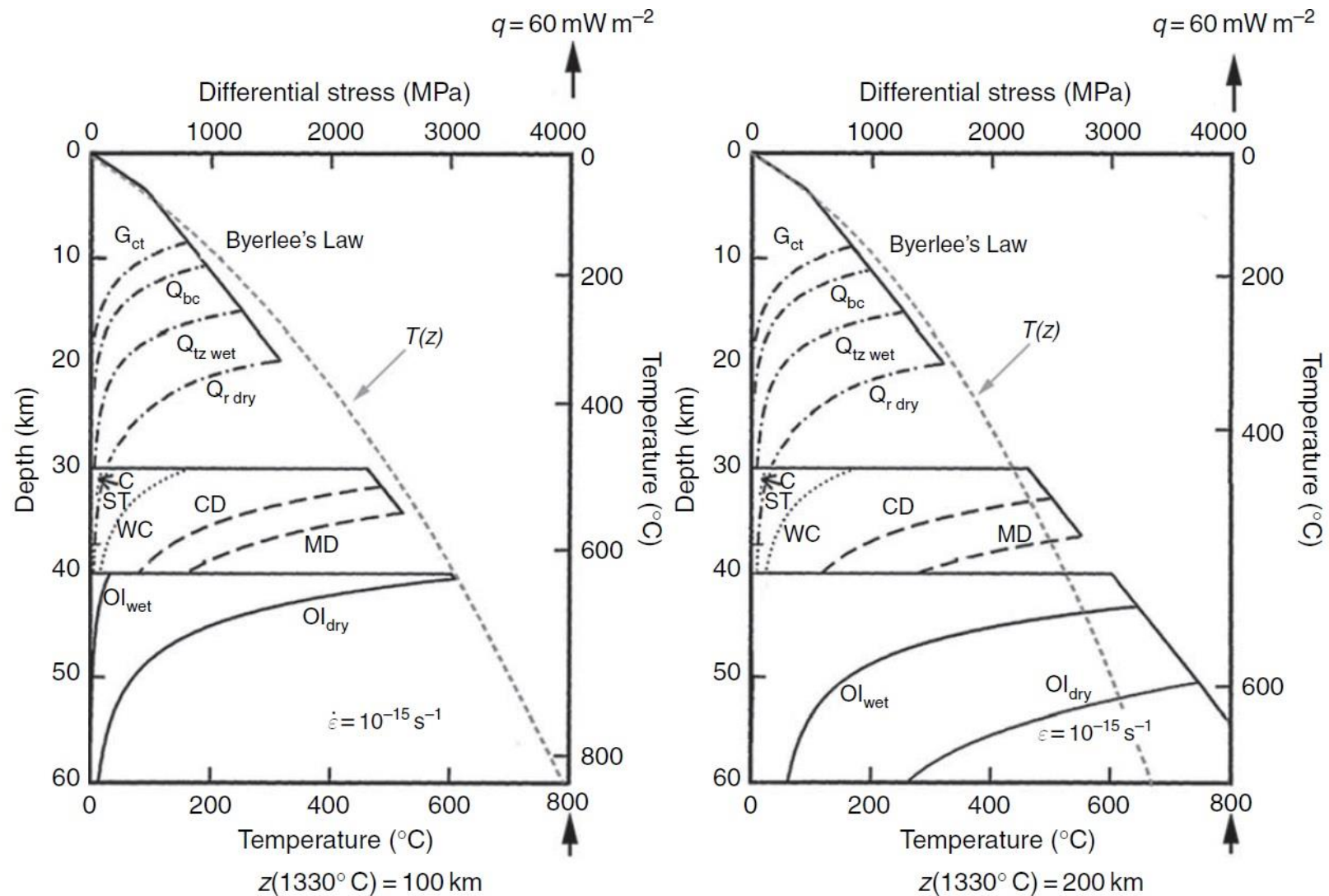

Upper Crust: Q_{bc} dry quartzite, Q_{tz} wet quartzite, G_{ct} is wet granite Q_r is for extra strong dry quartz; CD, dry Columbia diabase; MD, dry Maryland diabase; WC, Pikwitonei granulate; ST and C, diabase, Ol_{dry} and Ol_{wet} , dry and wet dunite;

Rheological strength profiles

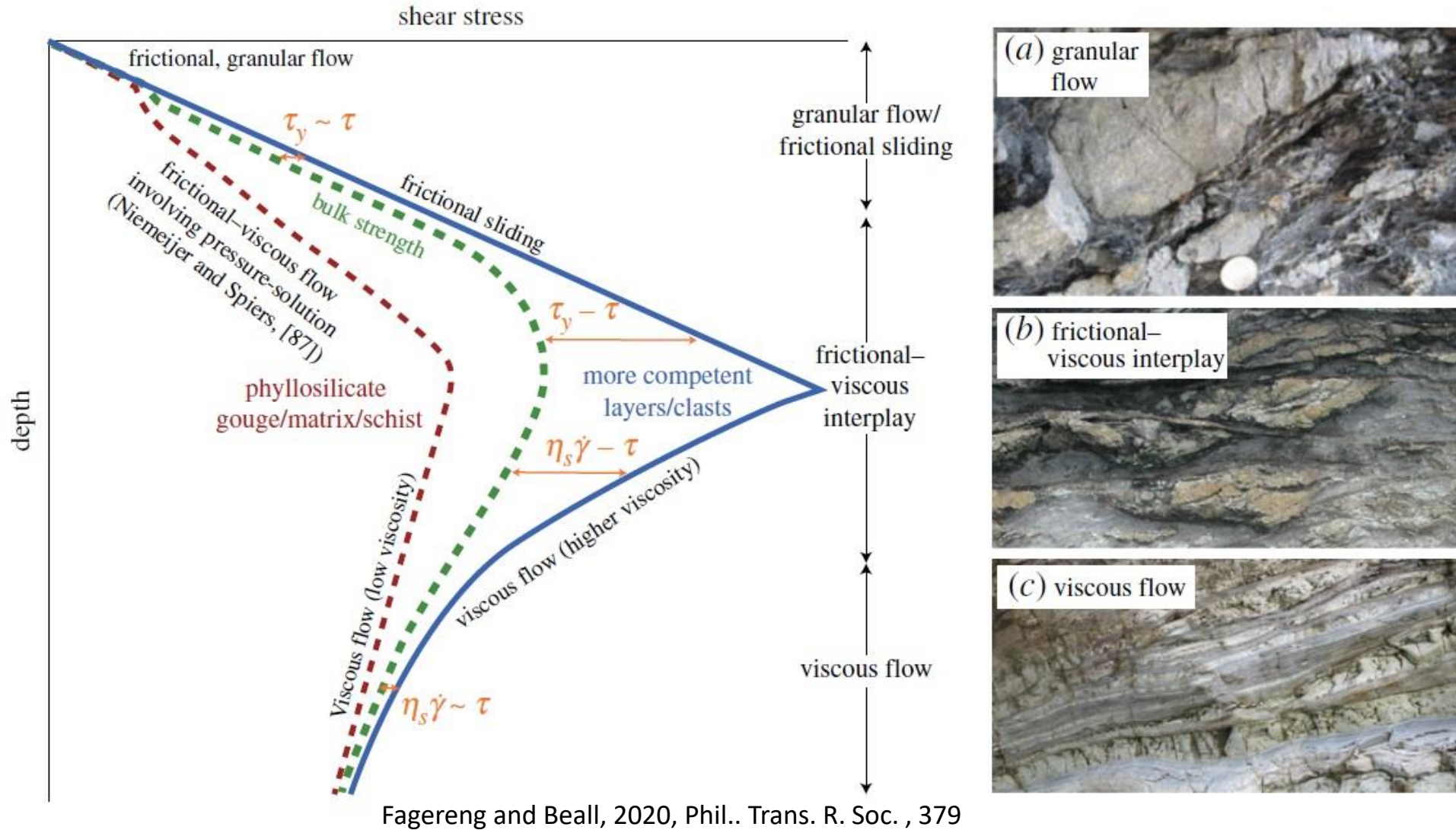

- The stress driving bulk deformation (intermediate, dashed green curve) is expected to be similar to the frictional yield strength ($\tau \sim \tau_y$) in the frictional regime, and similar to the viscous strength of competent material at the imposed strain rate ($\tau \sim \eta_s \dot{\gamma}$) in the viscous regime. Deviations from these conditions are associated with the frictional-viscous interplay zone.

Temperature and Deformation of Continental Lithosphere

Surface Heat Flow

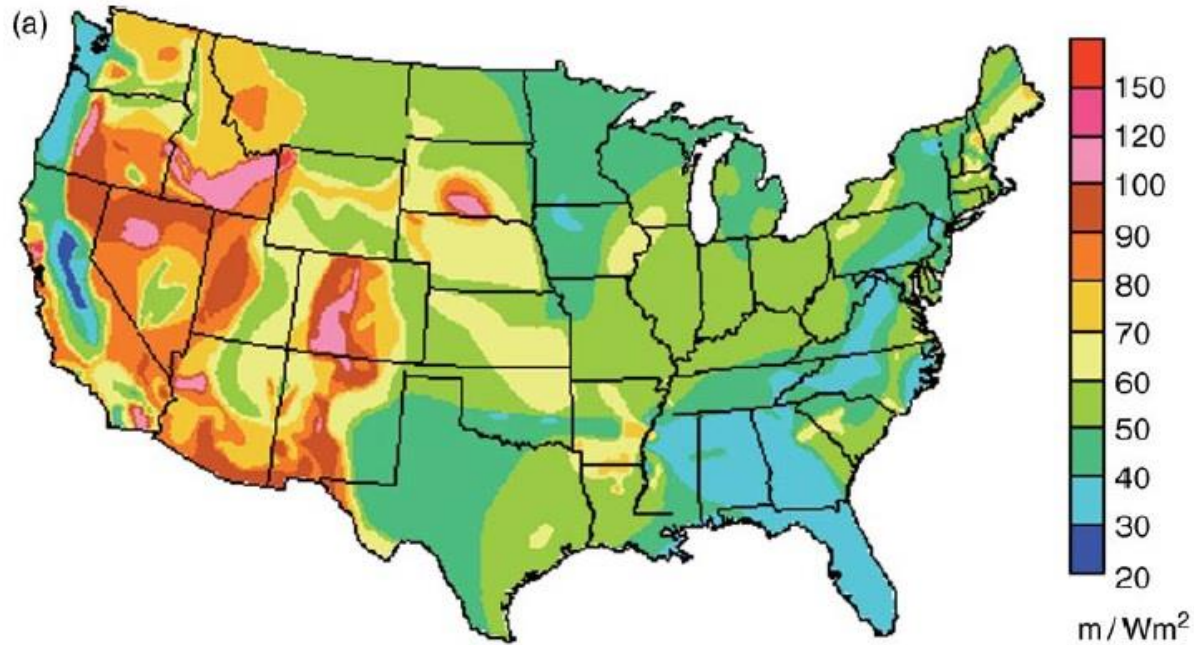

Seismic Hazard

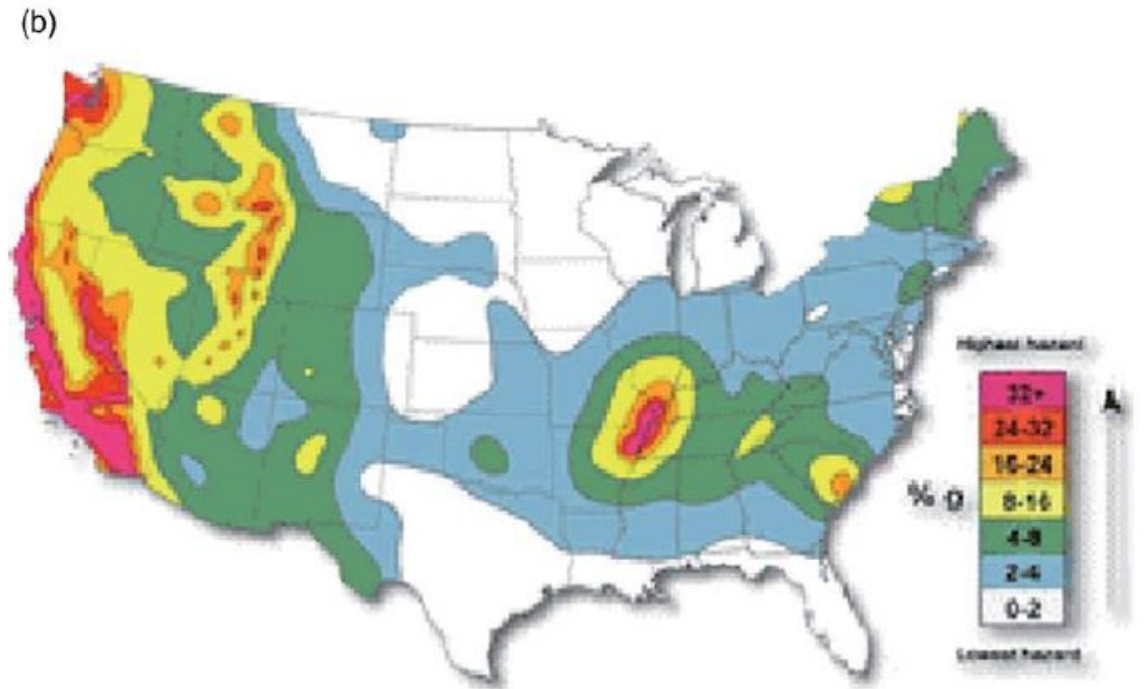

There is a strong correlation between regions high crustal temperature and regions of high deformation rate in terms of high seismic hazard.

Global Strain Rate Model from Geodetic Velocities

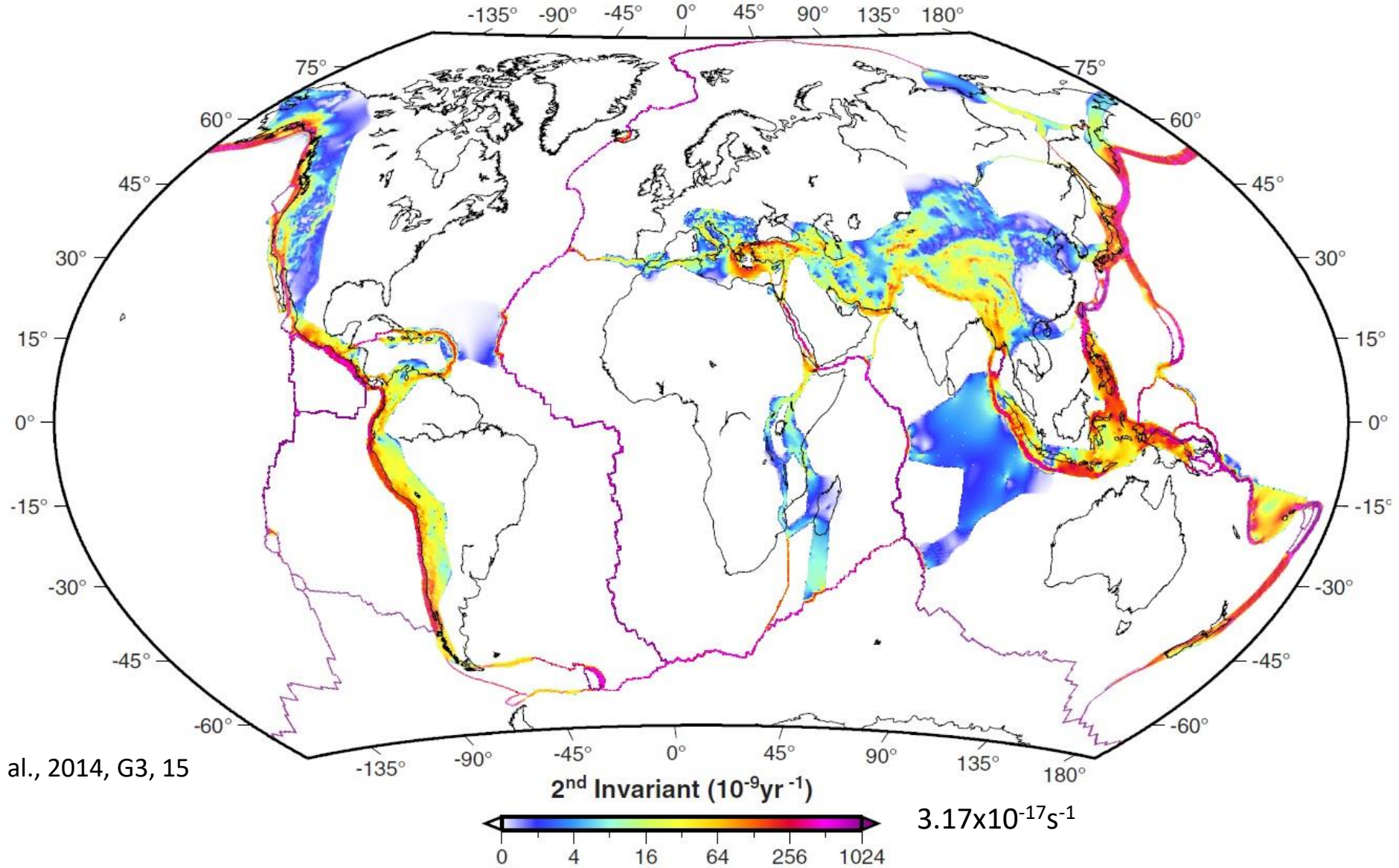

Kreemer et al., 2014, G3, 15

White areas were assumed to be rigid plates and no strain rates is calculated there

Integrated Strength of the Lithosphere

- To consider the deformation of the entire continental plates we need to estimate the mean stresses averaged over the entire lithosphere or vertically integrated strength, F_1 (Pa m or N m⁻¹).
- F_1 is the the force acting in the direction normal to the plate per meter length of plate that is required to deform a plate for a given strain rate.

Construction of 3D rheological strength models of the continental lithosphere

$$F_1 = \int_0^{z_1} (\sigma_1 - \sigma_3) dz$$

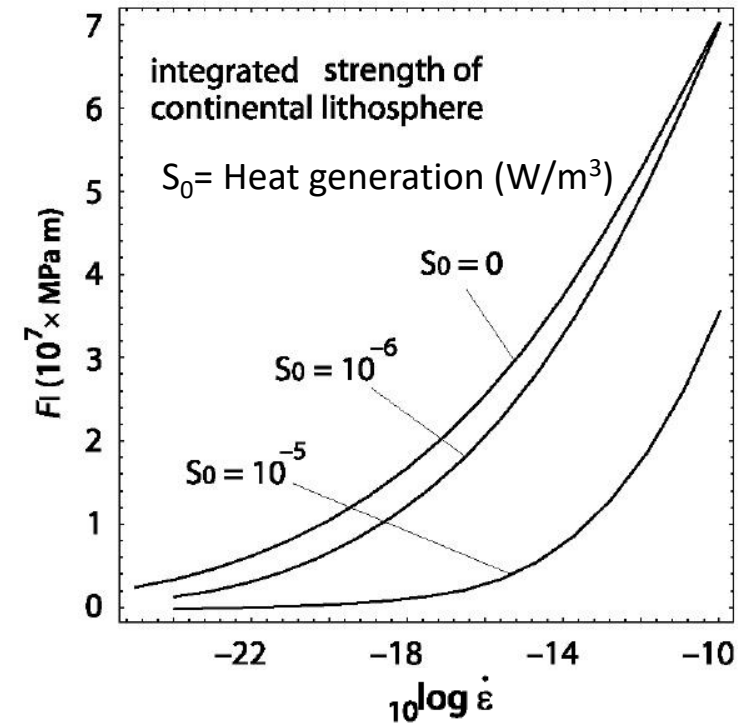
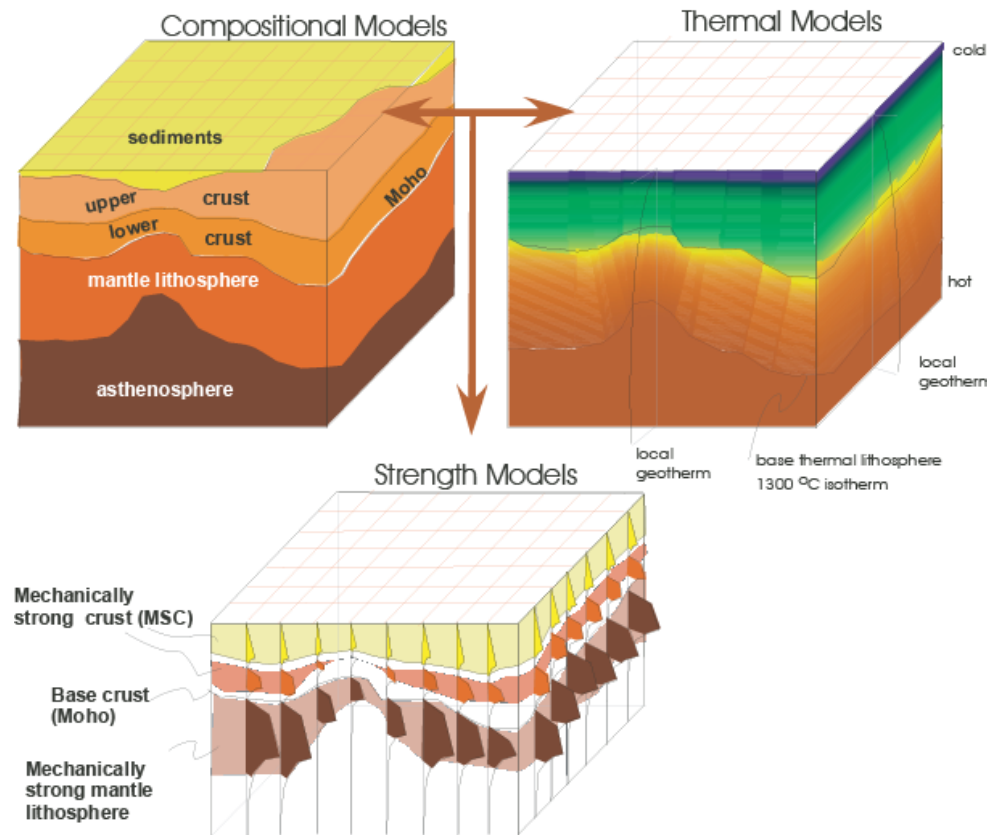

Integrated Strength of the Lithosphere, (Dependency on Crustal Thickness, and Differentiation Index)

- Crustal differentiation effectively lowers the temperature at the base of the crust, allowing stabilization of a thicker crust.
- The effect of temperature on thermal conductivity results in higher Moho temperature than in calculations with uniform conductivity.

Low Integrated Strength < 1×10^{13} N m⁻¹ (Pa m)

High Integrated Strength > 1×10^{13} N m⁻¹ (Pa m)

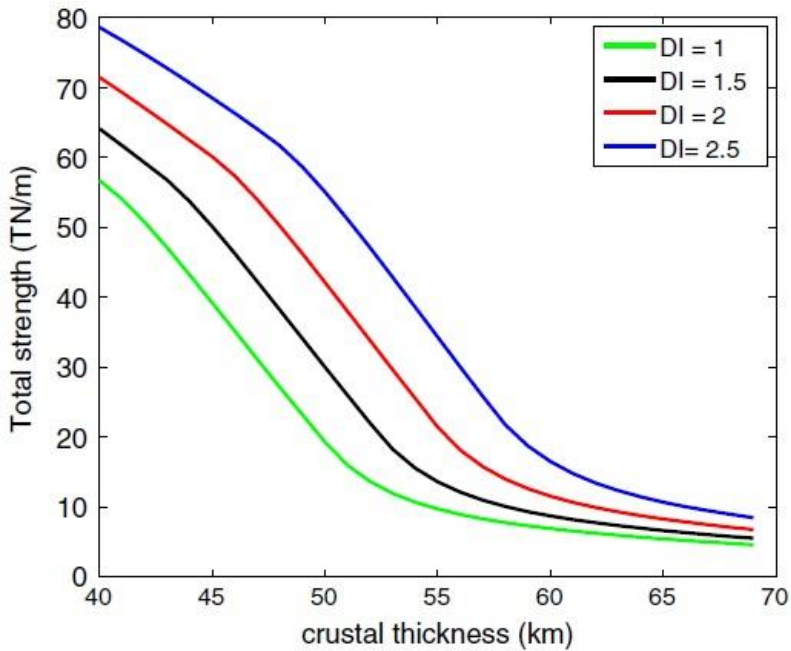

$$A_{CRUST} = 0.8 \mu\text{Wm}^{-3}$$

Enriched Crustal Thickness of *HPE*, D=15 km

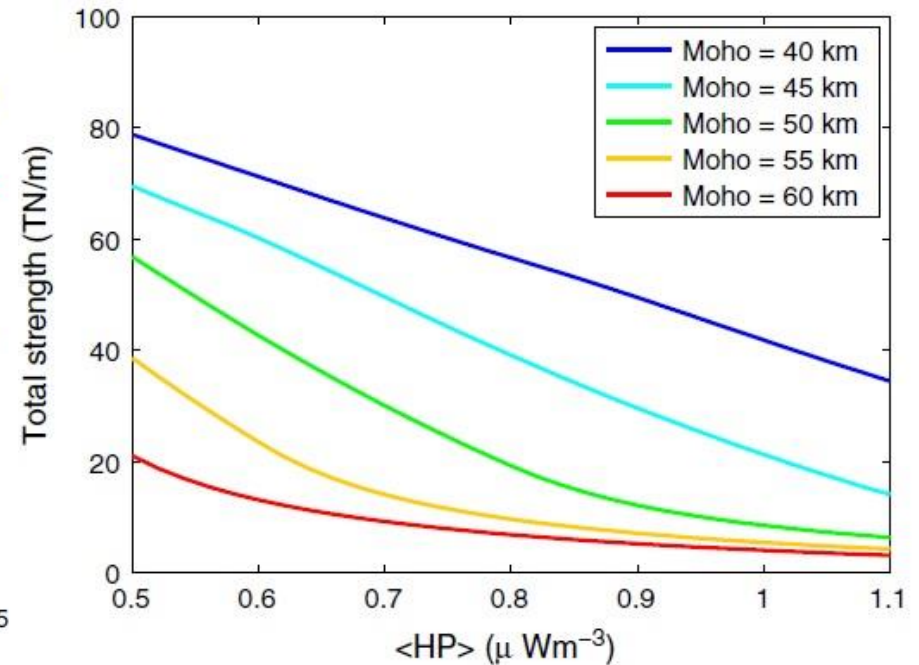
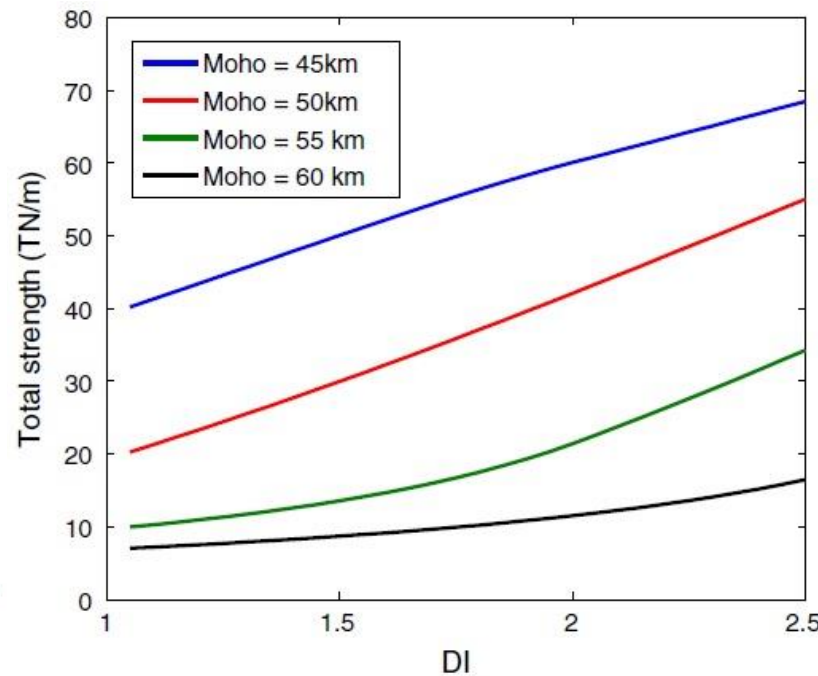

DI=1.

Integrated Strength of the Oceanic Lithosphere

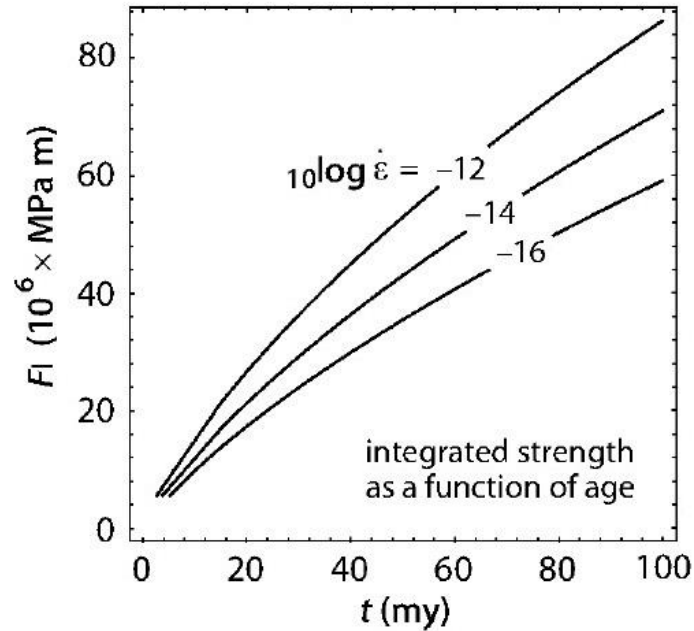
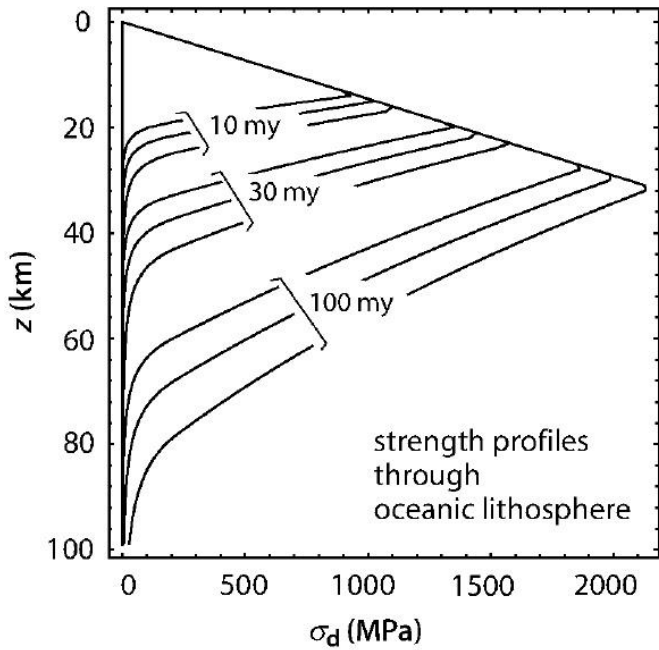

Strain rate with which oceanic lithosphere will deform in response to ridge push

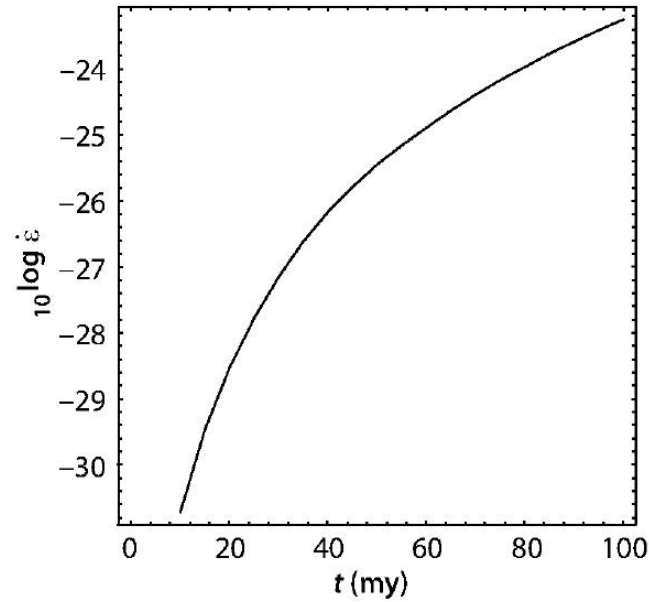
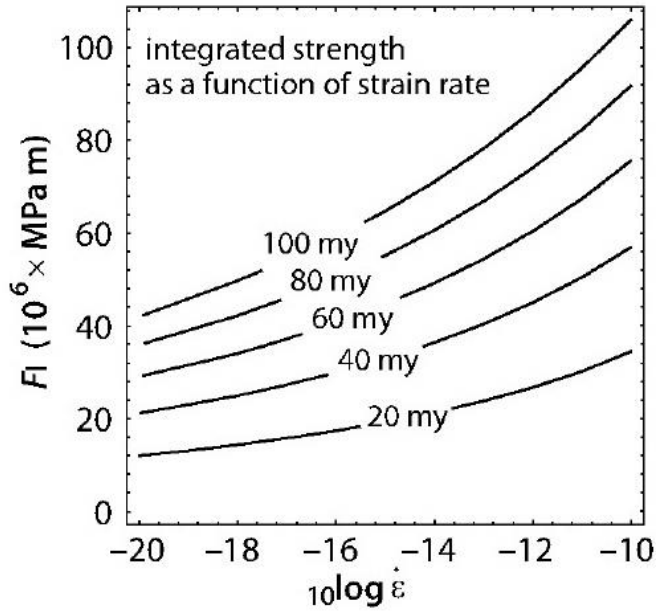

- Integrated strength of oceanic lithosphere increases with age and is higher than for continental lithosphere.
- An oceanic plate is a passive transmitter of stresses from the mid-oceanic ridge to the continents.
- Strain rate with which oceanic lithosphere would deform under its own ridge push against age of oceanic lithosphere shows that $\dot{\epsilon}$ is negligible.

Strain Rates variations

(Total integrated strength fixed to $\sim 3 \times 10^{12} \text{ N m}^{-1}$)

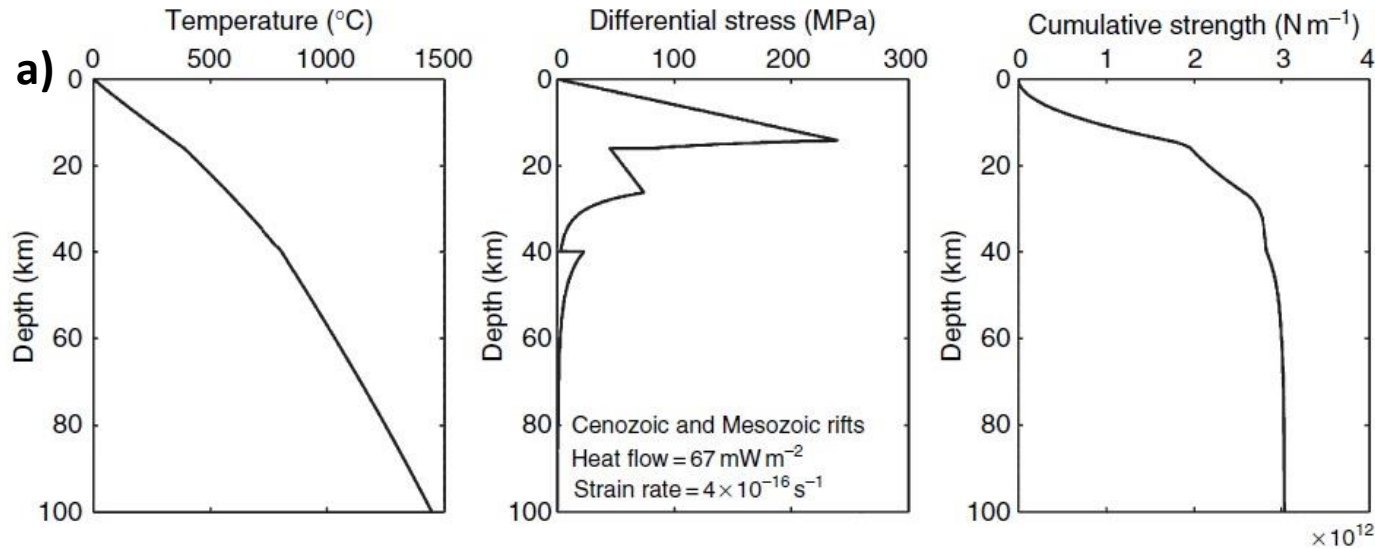

a) Meso-Cenozoic Rifts: Most of the total tectonic force is located in the strong brittle crust. Little force is required to cause deformation at a relatively high strain rate (10^{16} s^{-1}), because of the high lithospheric temperatures.

b) Archean Cratons: Lower crust and upper mantle are considerably stronger and the total force available is sufficient to only deform the lithosphere at a negligible strain rate (10^{29} s^{-1}).

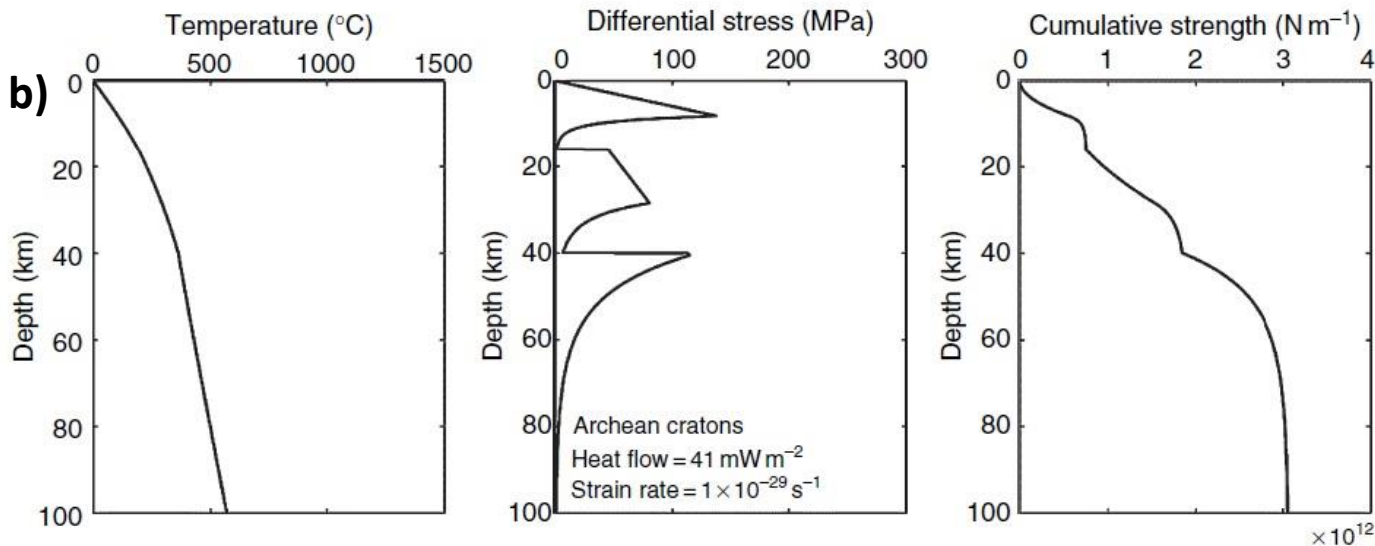

Differential stress is estimated, so that the integrated strength does not exceed the assumed total force/length available to deform the lithosphere ($3 \times 10^{12} \text{ N m}^{-1}$).

World Strength Maps

Integrated lithospheric strength (Pa m)

'Soft' rheology (UC=Dry Quartzite; LC=Wet Diorite)

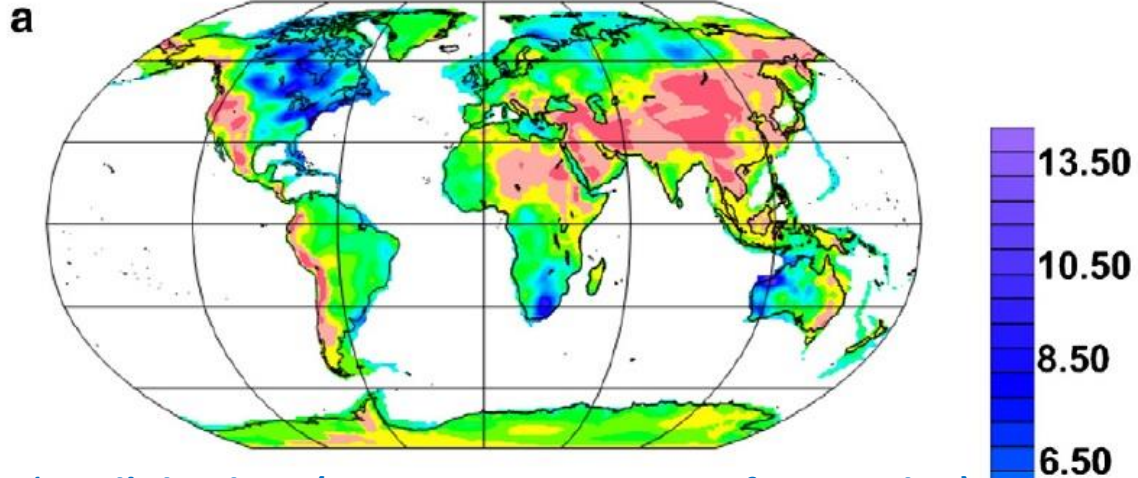

'Hard' rheology (UC=Dry Granite; LC=Mafic Granulite)

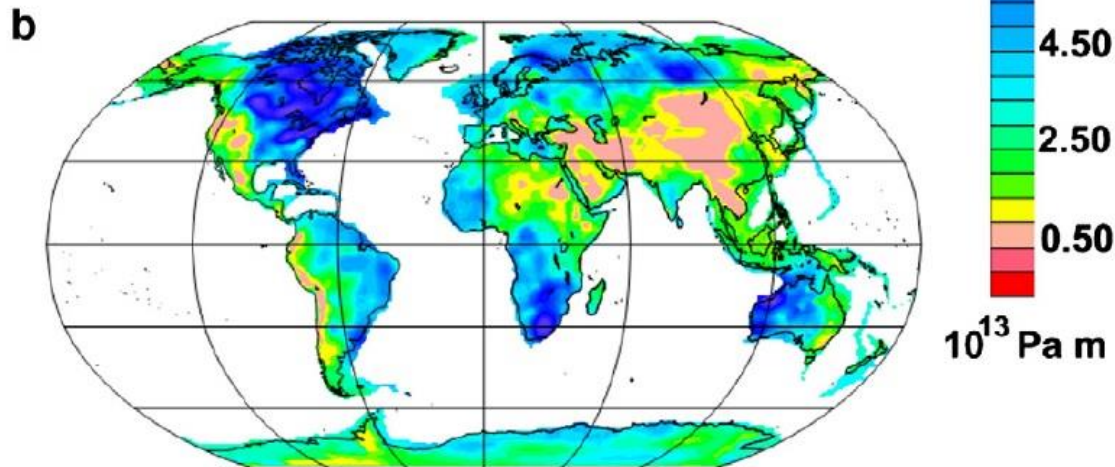

Percentage of crustal strength (%)

'Soft' rheology (UC=Dry Quartzite; LC=Wet Diorite)

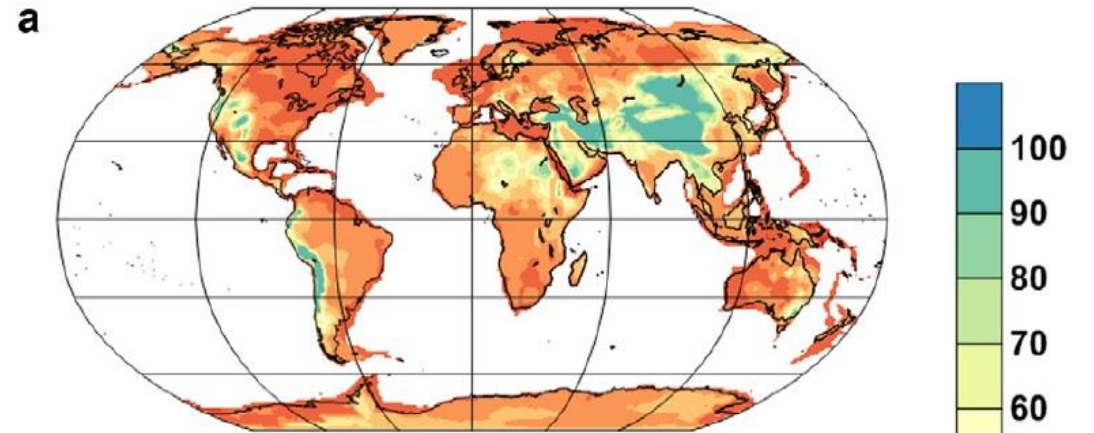

'Hard' rheology (UC=Dry Granite; LC=Mafic Granulite)

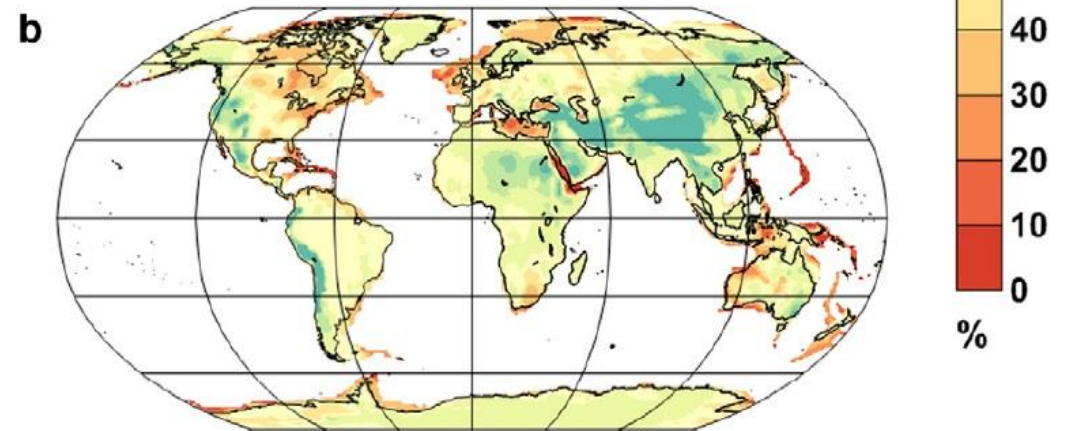

North America Thermal and Rheological model of the Lithosphere

Thermal Model

Rheological Model

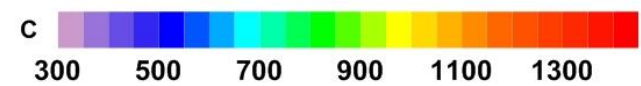
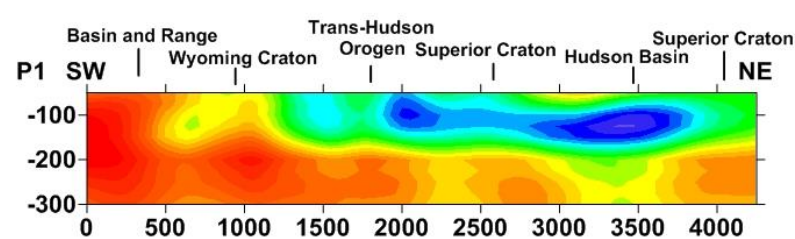
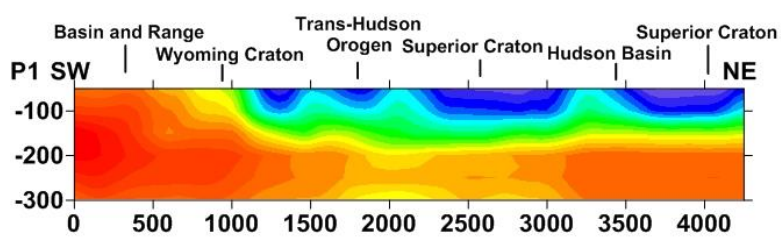
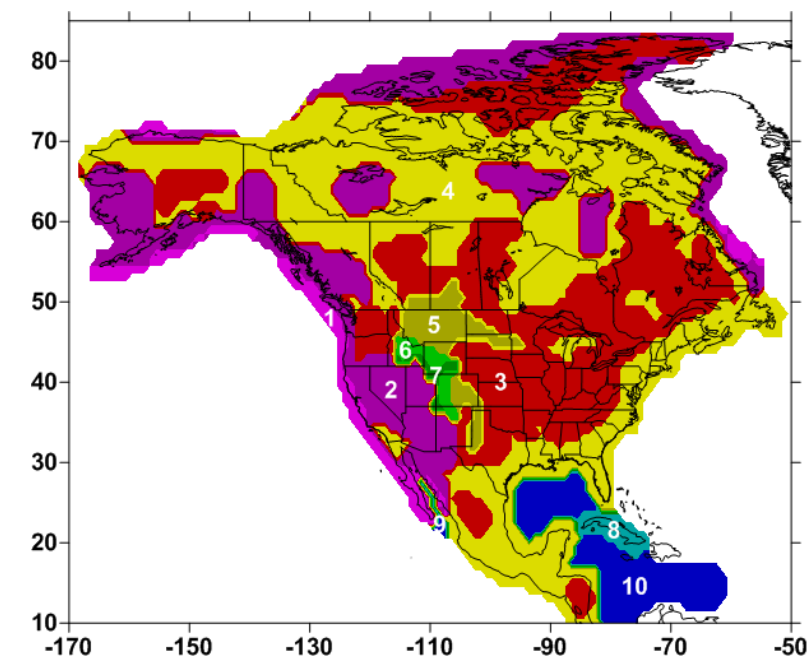
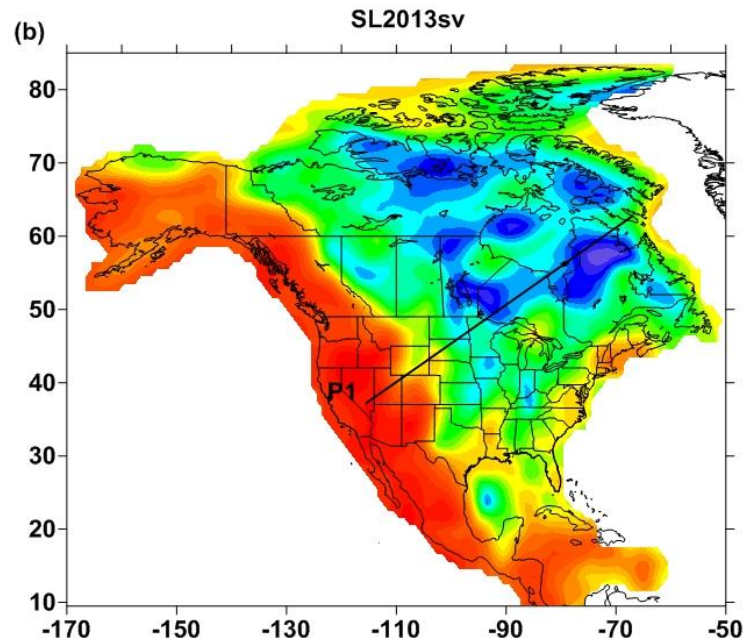
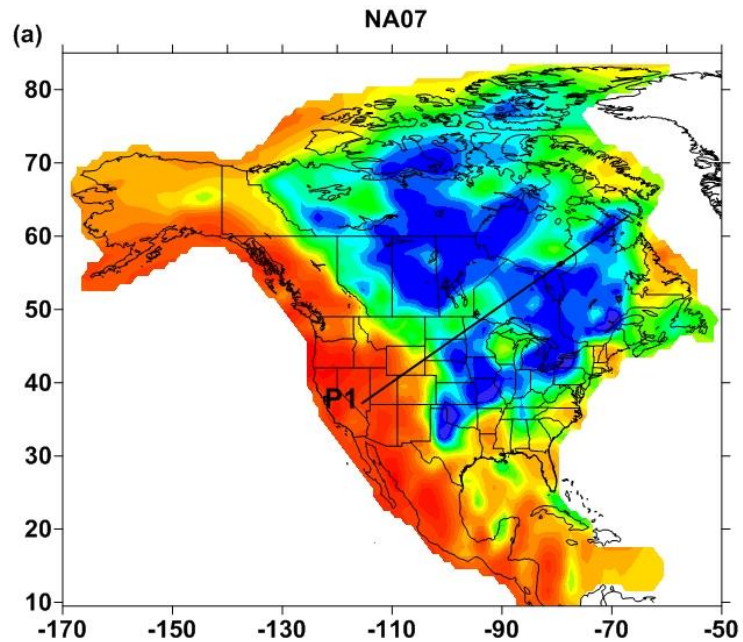

Upper Crust	Middle Crust	Lower Crust
1 Quartzite	Diorite	Diorite
2 Quartzite	Diorite	Diabase
3 Granite	Diorite	Mafic Granulite
4 Granite	Diorite	Diabase
5 Granite	Diabase	Mafic Granulite
6 Quartzite	Diabase	Diabase
7 Quartzite	Diorite	Mafic Granulite
8 Granite	-	Mafic Granulite
9 Quartzite	-	Diorite
10 -	Diabase	-

Tesauro et al., 2015, G3

North America Strength model of the Lithosphere

Integrated lithospheric Strength

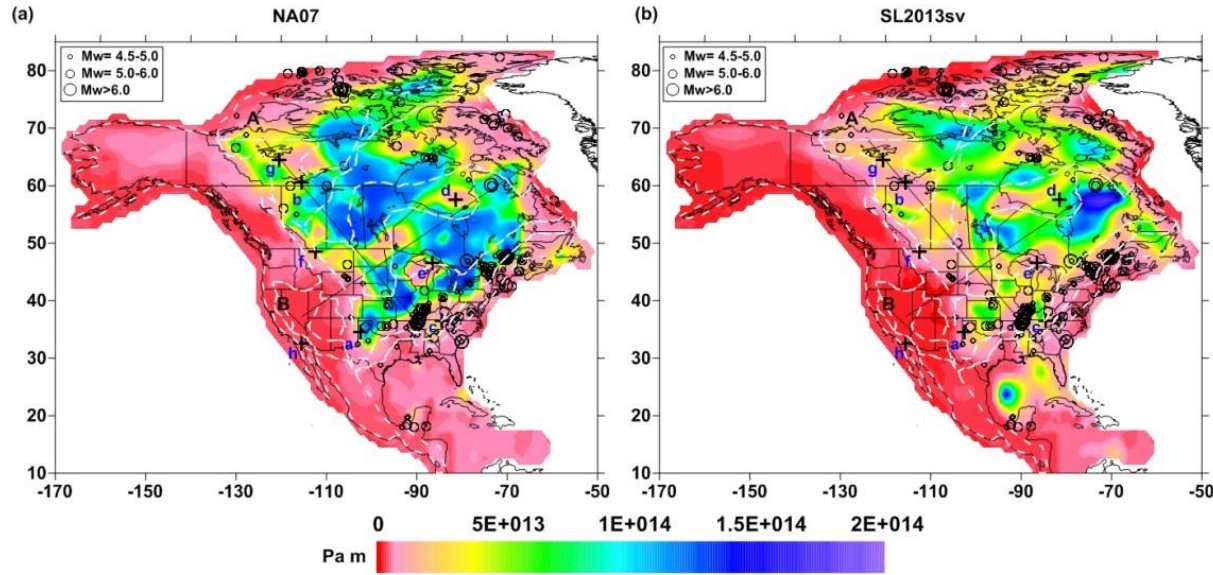

Integrated Crustal Strength and Percentage

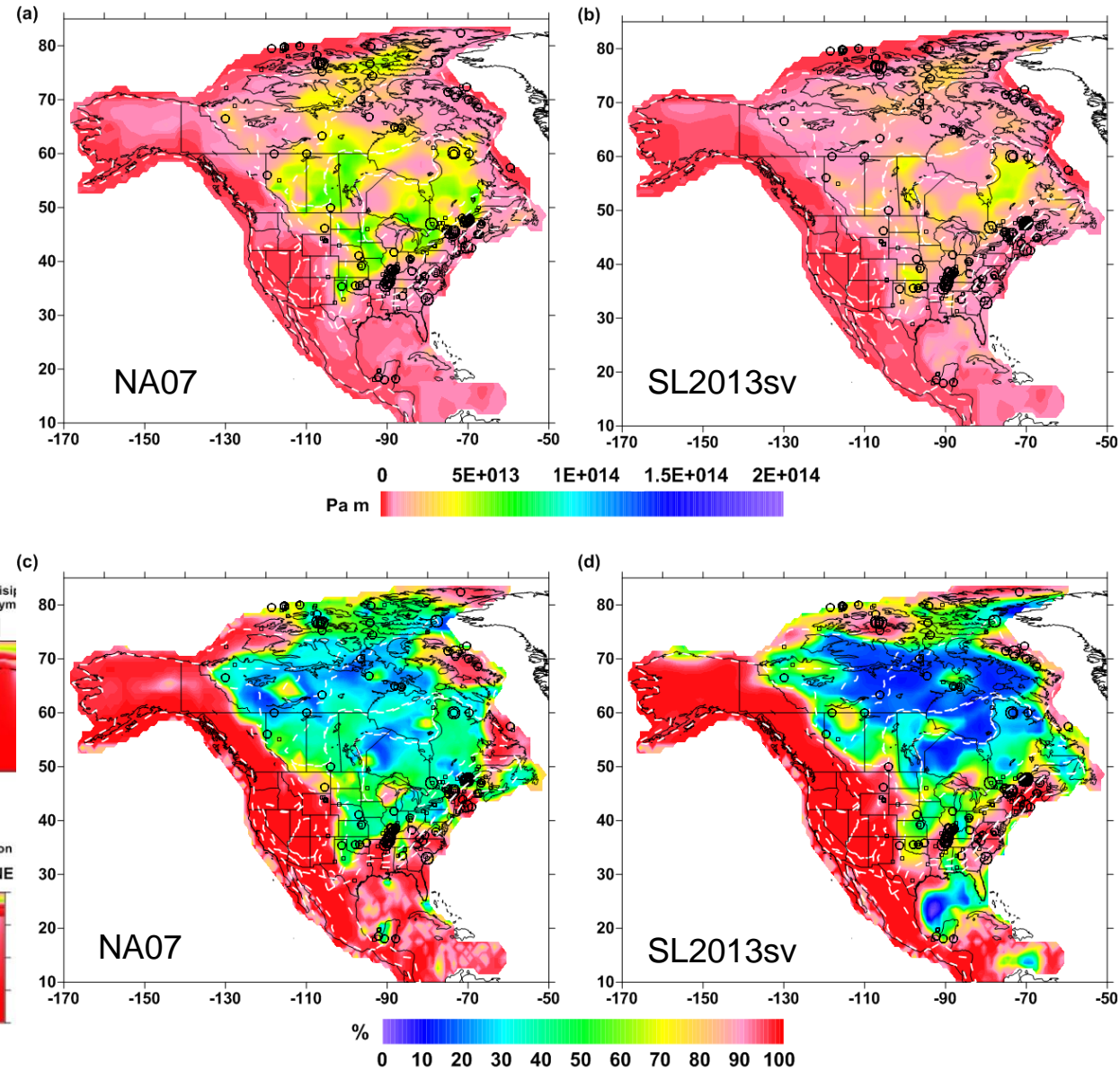

North America Strength model of the Lithosphere (strain rates influence)

Integrated lithospheric Strength

NA07

SL2013sv

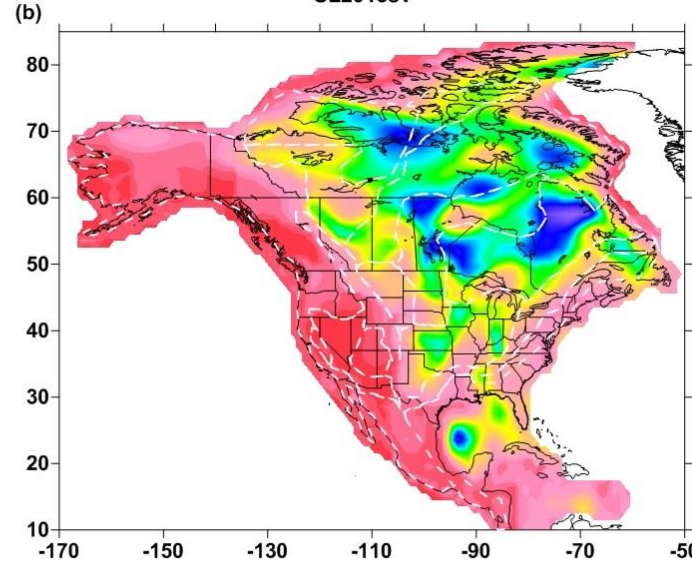
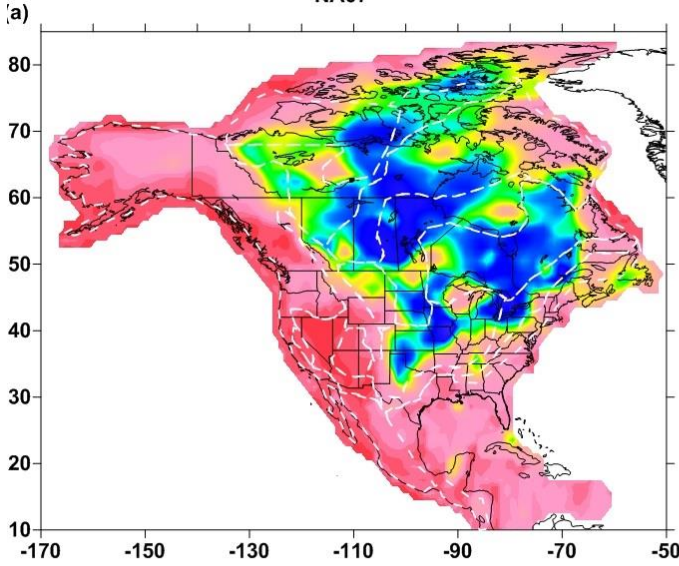

Strain rate: 10^{-14} s^{-1}

Integrated lithospheric Strength

0 5E+013 1E+014 1.5E+014 2E+014
Pa m

Strain rate: 10^{-16} s^{-1}

Tesauro et al., 2015, G3

(a)

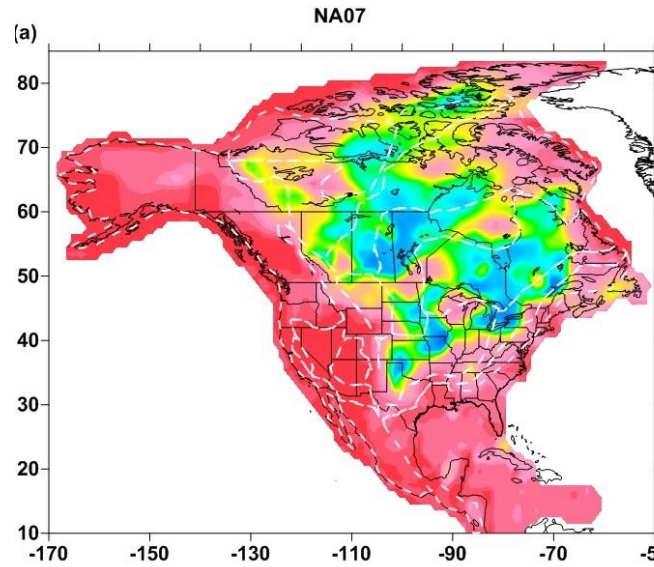

(b)

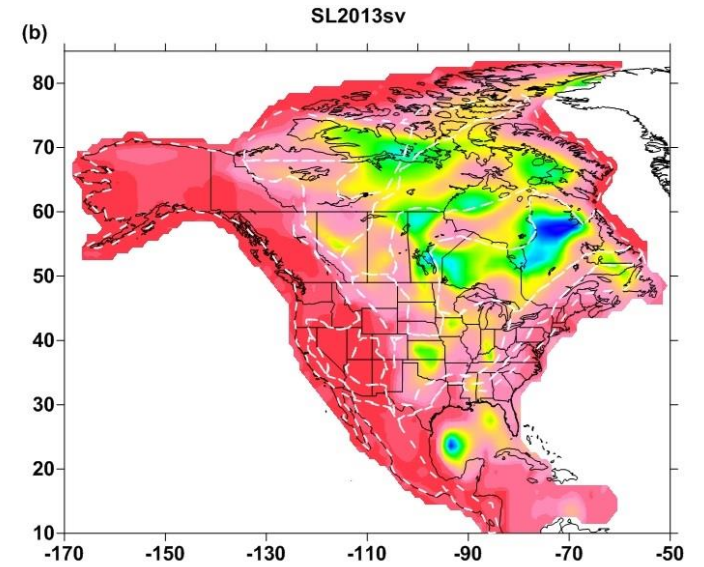

0 5E+013 1E+014 1.5E+014 2E+014
Pa m

Evolution in time of rheological strength models

Rheological strength evolution during crustal thinning

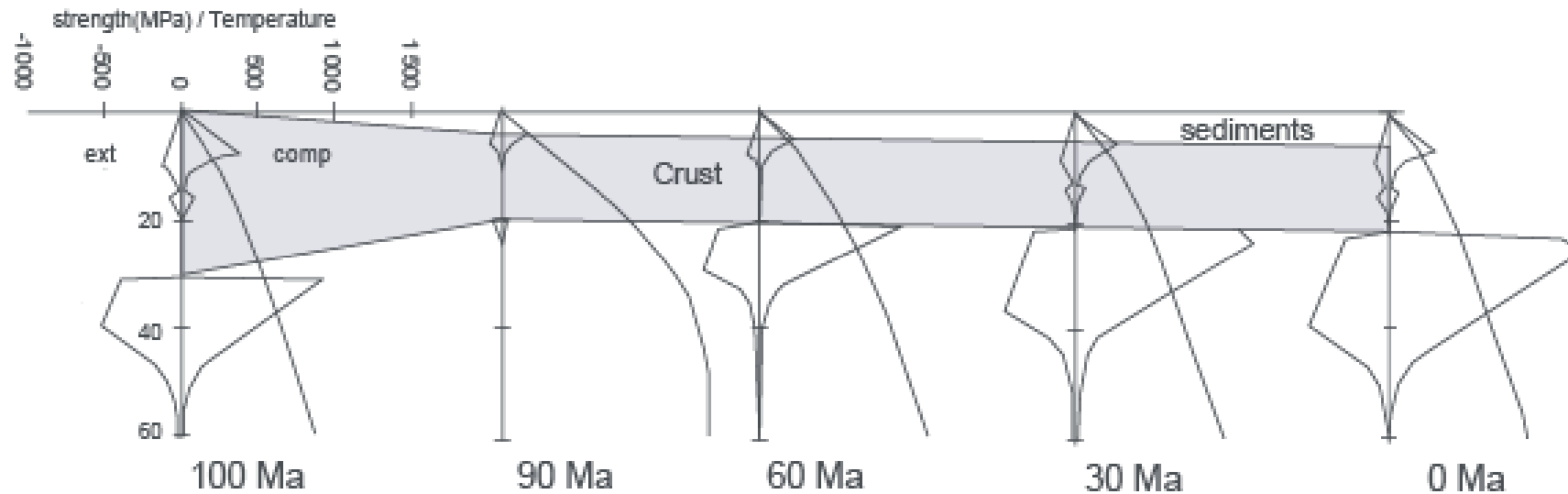
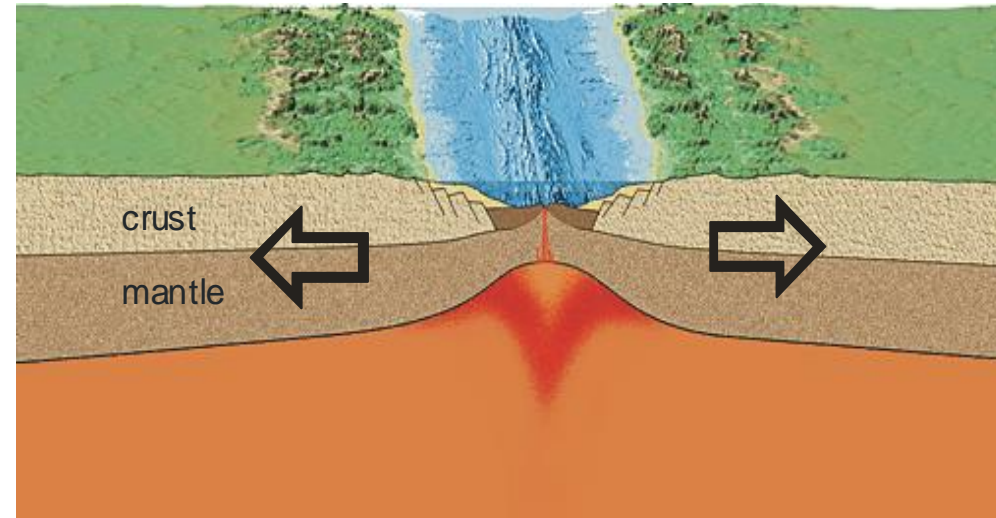

Uncertainties on strength and integrated strength estimates

1) Uncertainties of rocks mechanics data:

- In the lab experiments refer to uniaxial deformation, but rocks deform in several planes.
- Experimental strain rates (10^{-8} - 10^{-4} s $^{-1}$) are ten times faster than geological strain rates (10^{-18} - 10^{-14} s $^{-1}$).
- Experiments refer to simple monophase minerals or representative rocks (small samples and homogeneous structure).
- Water content influences rock strength ('dry' and 'wet' are generic terms).
- Volatile fugacities and chemical reactions modify the mechanical behaviour of rocks.
- Temperature-pressure (P-T) conditions in the lab are not the same occurring in natural conditions.

2) Uncertainties of the Synthetic Yield Strength Envelopes

- Uncertainties of values of temperature and strain rate

3) Uncertainties on deformation mechanisms in nature

- Elastic, brittle, ductile deformation can occur simultaneously

4) Other factors (frictional heating, pressure, fluid content)

- Frictional heating may decrease ductile strength, cause metamorphic changes, or change fluid content
- Few data on the rheology of the metamorphic rocks.

Flexural Rigidity

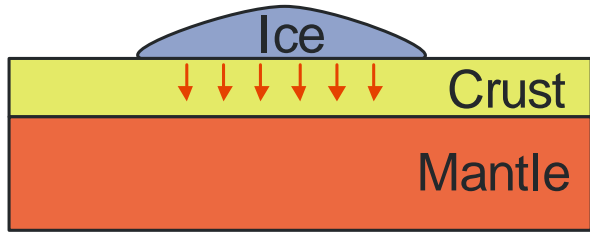

Development of thick ice sheet:
lithosphere is subjected to additional
weight

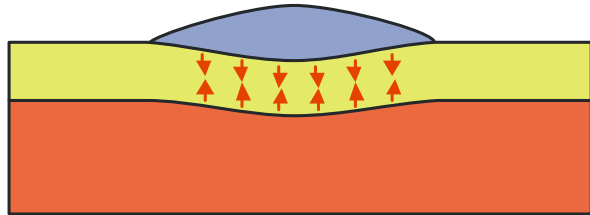

Isostatic response: flexural bending

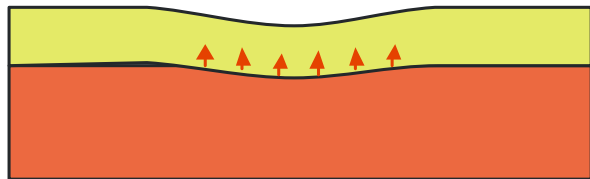

Melting of ice sheet: isostatic response is
uplift now



Recovery towards starting situation

- Bending of the lithosphere can occur as result of the growth of major ice masses, magmatic and topographic growth of oceanic seamount chains, load of major river deltas.
- Amplitude and wavelength of the deflection depend on the material properties and effective elastic thickness of the plate.

Flexure of the lithosphere

What relations do you have with your neighbours?

None: local compensation

- Vertical movements are confined to the area where load changes take place
- Nothing happens in the surroundings

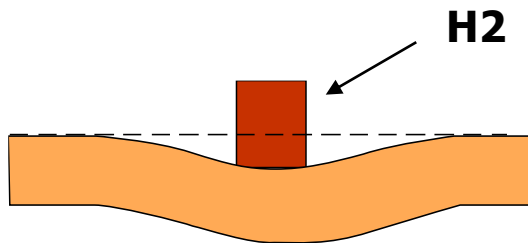

A lot contacts: regional compensation

- the width of the area affected increases
- the amplitudes decrease

In the extreme case of a lithosphere with infinite strength

- No subsidence
- All changes in mass translate in topography

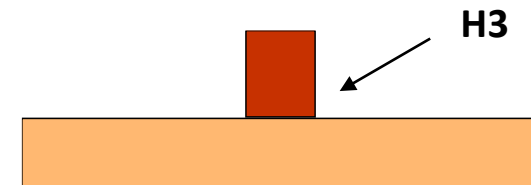
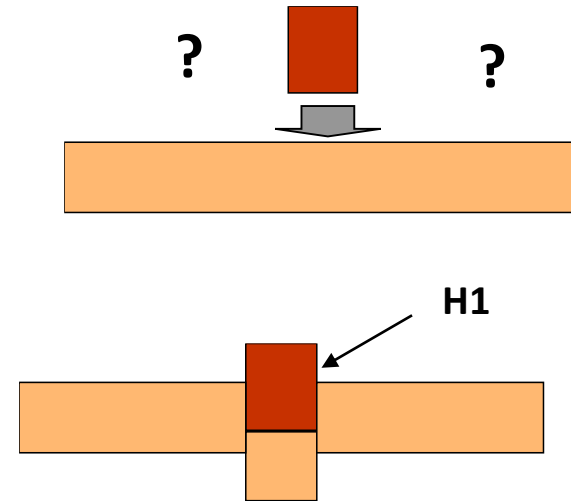

Lithospheric strength (changing in space and time) controls the reaction to changing loads

Flexure of the lithosphere

Flexural isostasy is a stress balance that considers horizontal elastic stress

- Elastic Deformation of Oceanic Lithosphere: seamount, bending of subducting plate.
- Elastic Deformation of Continental Lithosphere: passive continental margin, molasse basin (weight of the mountain belt is partly compensated by an internal loads).

When integrating the horizontal normal stresses σ_{xx} , over the thickness of the elastic plate h , the bending moment M is proportional to the curvature of the plate:

$$M = \int_{-h/2}^{h/2} \sigma_{xx} z dz \quad \longrightarrow \quad M = -D \frac{d^2 w}{dx^2}$$

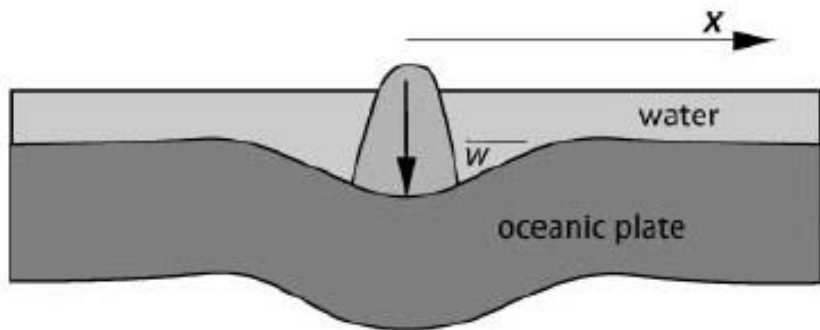

$-\frac{d^2 w}{dx^2}$ = the rate of change in slope of the deflection

D = plate rigidity

w = vertical deflection

x = horizontal distance

- The bending moment M is related to the curvature of the plate, since forces on the end section exert a torque about the midpoint of the plate.
- If the force on an element of thickness dz on the end of the plate is $\sigma_{xx} dz$, then this force will exert a torque about the midpoint ($z = 0$) of $\sigma_{xx} z dz$.

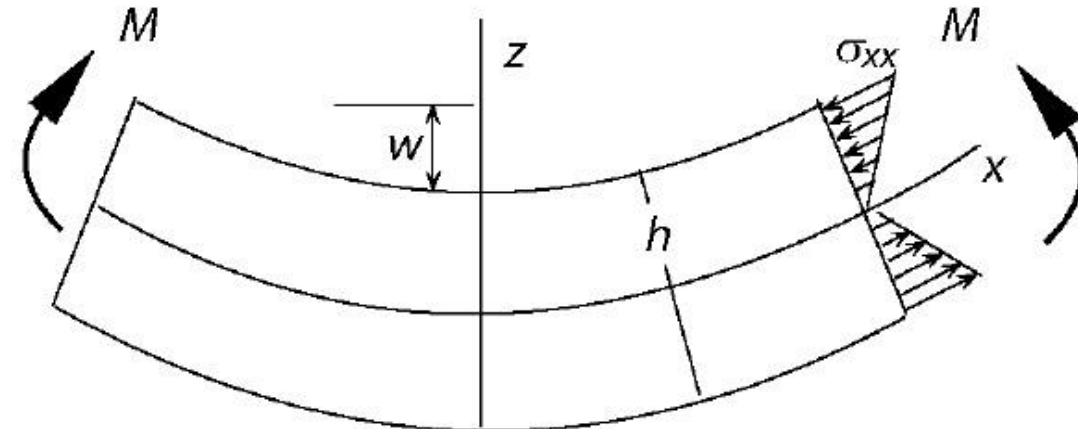

Flexure of the lithosphere

$$M = -D \frac{d^2 w}{dx^2} \longrightarrow$$

coupled with a force balance equation that relates bending moments, the vertical load q , any applied horizontal forces F and the shear forces, we obtain the general flexural equation:

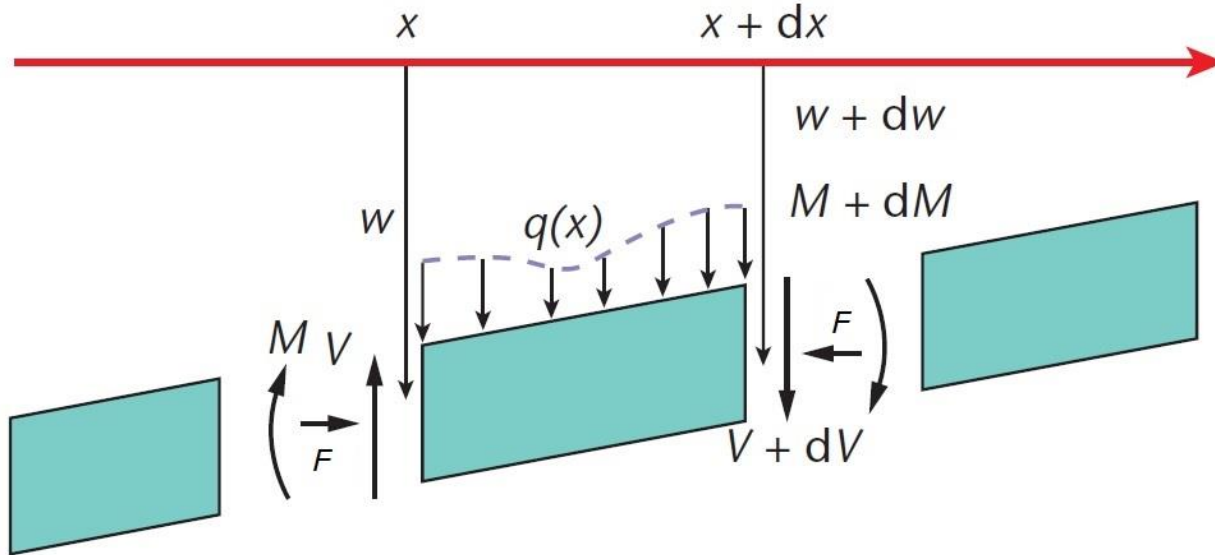

$$-F \frac{d^2 w}{dx^2} + \frac{d^2 M}{dx^2} = -q(x)$$

$$\downarrow$$

$$D \frac{d^4 w}{dx^4} = q(x) - F \frac{d^2 w}{dx^2}$$

q_x = a series of internal and external loads acting upwards and downwards onto a plate (stress)

A downward force per unit area $q(x)$ is exerted on the plate by the applied load and on the end sections there is a net shear force per unit length V and horizontal force F per unit length, which is independent of x .

Flexure of the lithosphere

The downward force exerted by the mountain range on the plate is given by the vertical normal stress (the *external* or *positive* load) $q_{ext} = \rho_c g H$. The buoyancy force (the *internal* or *negative* load) has the magnitude $q_{int} = (\rho_m - \rho_c) g w$, where w is the deflection of the plate. The net load that is applied to the plate is:

$$q(x) = q_{ext} - q_{int} = \rho_c g H(x) - (\rho_m - \rho_c) g w$$

In oceanic lithosphere (narrow island chains on large oceanic plates):

1. We assume that there are no horizontal forces applied to the plate
2. We assume that the vertical load (V_0 or q_a) is only applied at a single location (there is no dependence of the load on x).

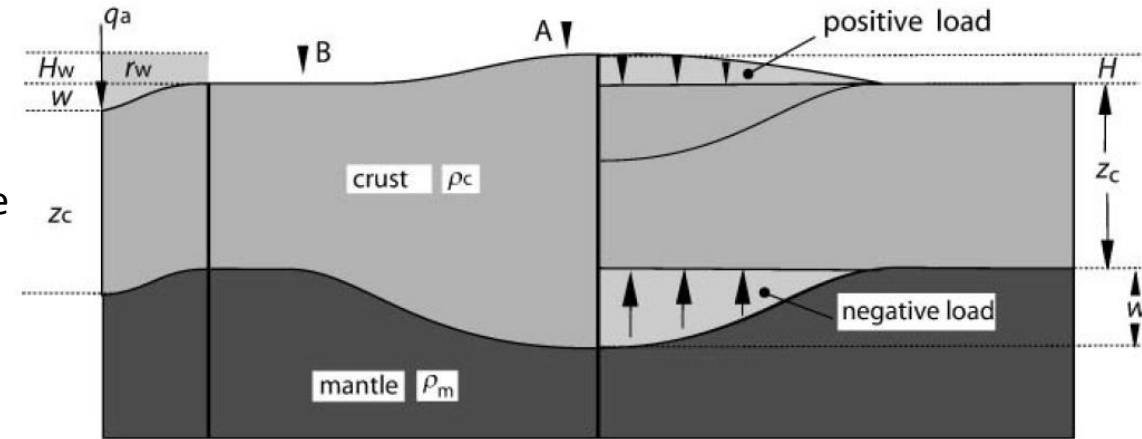
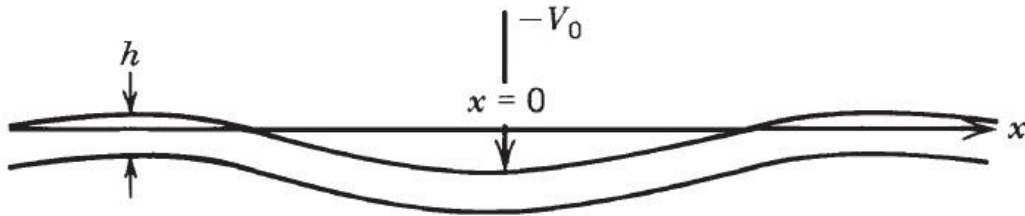

Assuming that the downwards deflected region is filled with water:

$$q = q_a - (\rho_m - \rho_w) g w \quad \text{The flexural equation becomes: } D \frac{d^4 w}{dx^4} = -(\rho_m - \rho_w) g w$$

After integration, the constants D , g , ρ_m and ρ_w often occur in the following relationship: $\alpha = \left(\frac{4D}{g(\rho_m - \rho_w)} \right)^{1/4}$ $\alpha = \text{flexure parameter}$

For appropriately formulated boundary and initial conditions (e.g. the load applies only at $x = 0$, symmetry of the deflection, so that $dw/dx = 0$ at $x = 0$)

We solve the previous equation:
$$w = w_0 e^{-x/\alpha} (\cos(x/\alpha) + \sin(x/\alpha))$$

w_0 = maximum deflection of the plate directly underneath the load $w \rightarrow w_0$ for $x \rightarrow 0$

Flexure of the lithosphere

Subducting oceanic plate :

The loading of the subducting oceanic plate may be viewed as a line-loading by the margin of the upper plate. Boundary conditions must be assumed that describe a broken half plate which is subjected to a load at its end. For appropriately formulated boundary conditions the flexural equation can be solved:

$$w = w_0 e^{-x/\alpha} (\cos(x/\alpha))$$

Shape of elastically bent plates

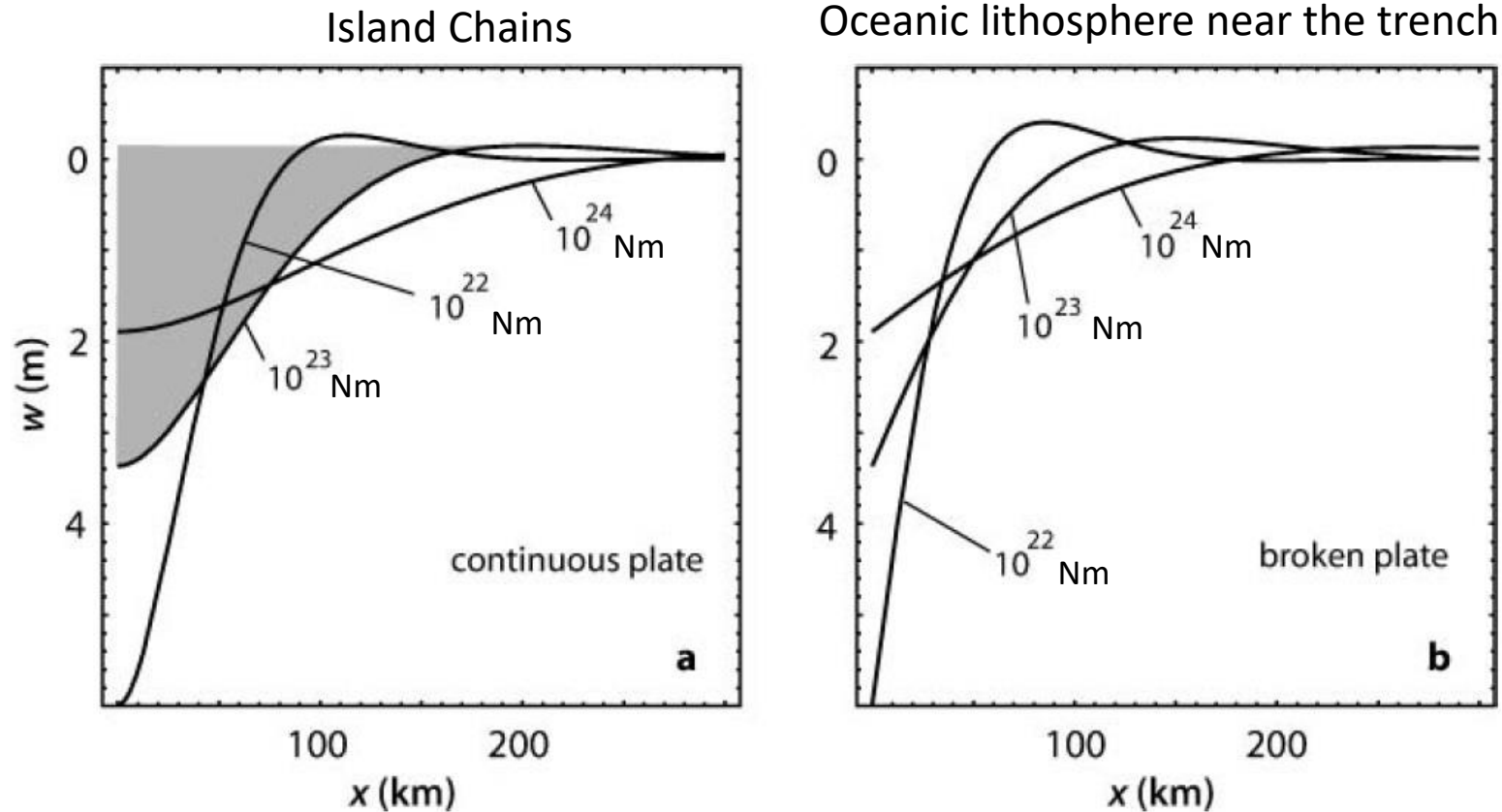

Strength vs Effective Elastic Thickness (T_e)

- Lithosphere responds to surface and subsurface loads by bending, characterized by vertical deflection, $w(x)$, and local radius of curvature, $R_{xy}(x)$, or curvature

$$K(x) = -R_{xy}^{-1} = \partial^2 w / \partial x^2$$

- The amplitude and wavelength, λ , of bending depend on the flexural rigidity D or equivalent elastic thickness T_e :

$$D = ET^3/12(1-\nu^2)$$

where E = Young's Modulus and ν = Poisson Coefficient

- T_e is the geometric measure of the flexural rigidity of the lithosphere, which describes the resistance to bending under the application of vertical loads (it is a measure of the integrated bending stress).

Flexure

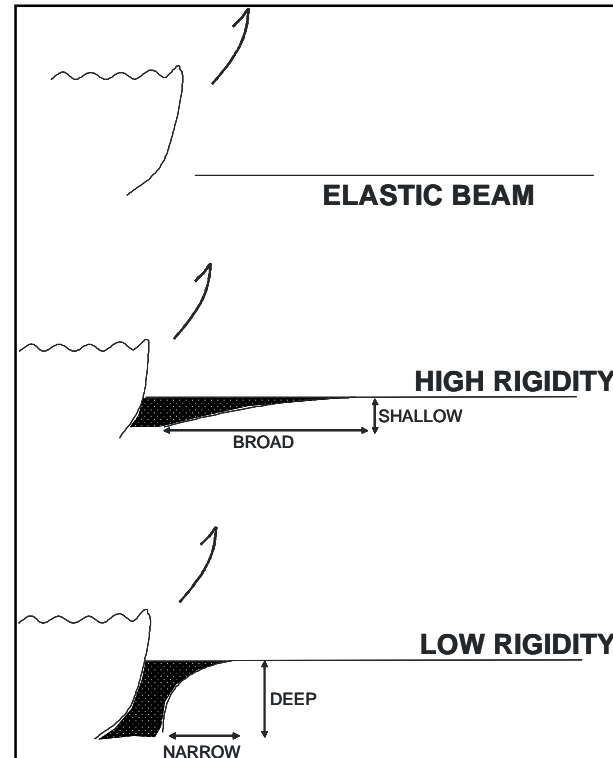

Rheology of the Lithosphere including elasticity

Elastic deformation is instantaneous and may be used to infer a stress state.

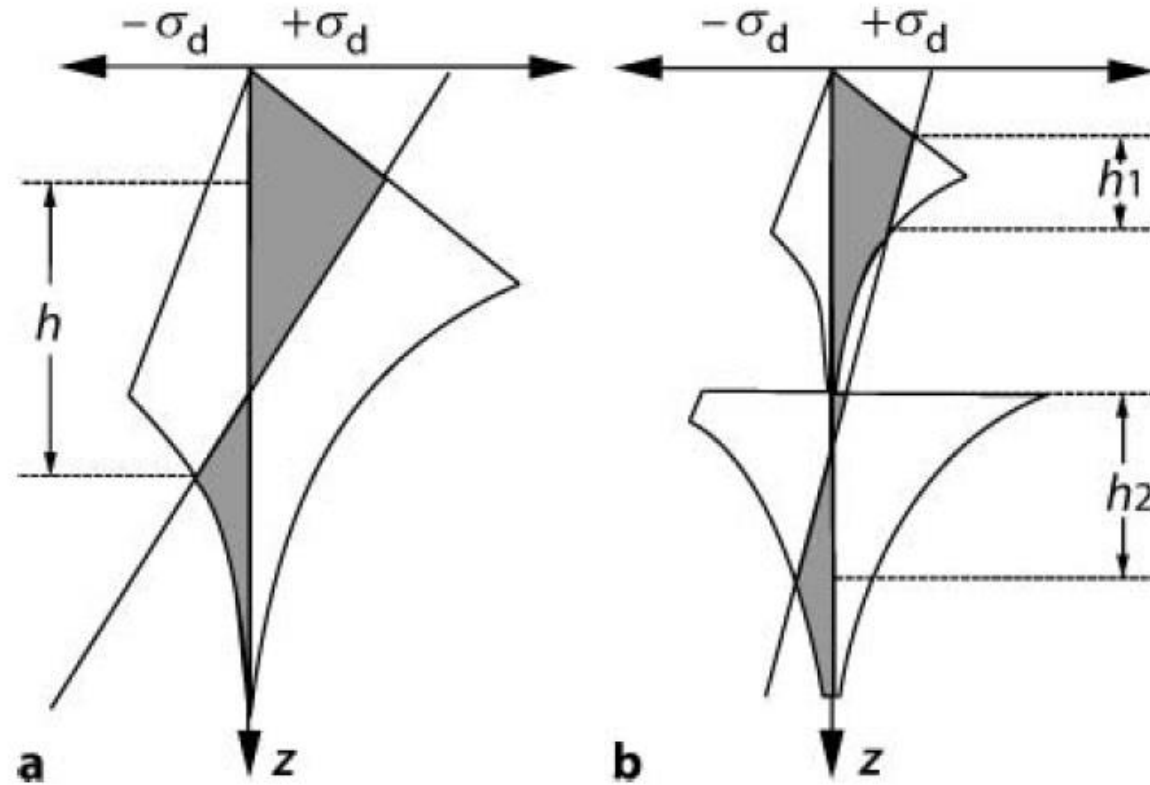

- In a downward bent elastic lithosphere there is a stress neutral layer in the middle of the lithosphere (above the lithosphere is in compression and below in extension).
- In the central part of the lithosphere elastic stress can support internal loads, since it is smaller of brittle and viscous stresses.

Te of oceanic lithosphere

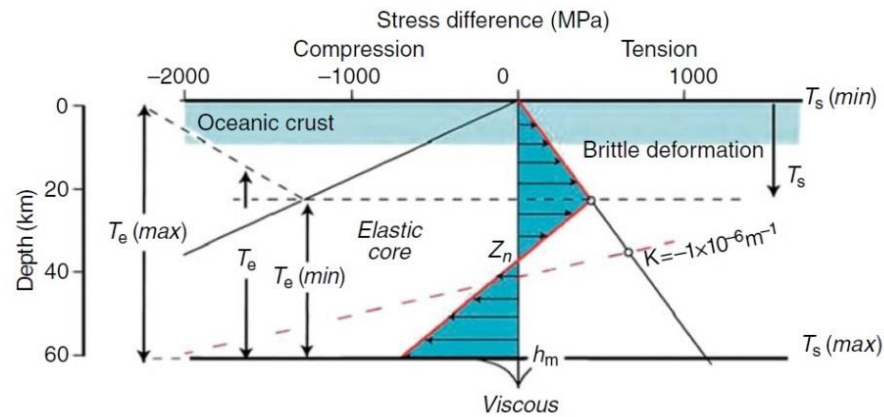
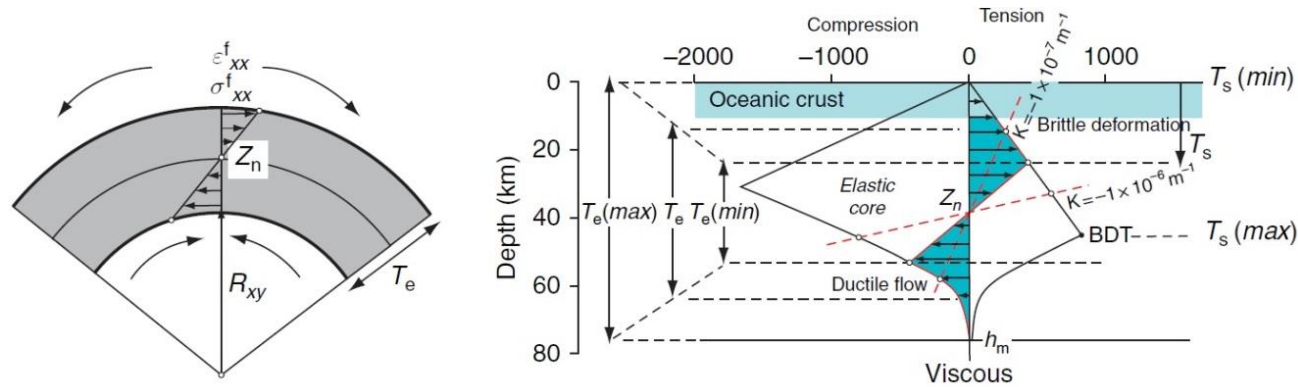

- Flexural strain in a bending plate increases with distance from the neutral plane.
- The uppermost and lowermost parts of the plate are subject to higher strains and may experience brittle or ductile deformation as soon as the strain cannot be supported elastically.
- T_e approximately equals the size of the 'elastic core' plus half size of the underlying brittle zone and half size of the ductile zone beneath.
- T_s (seismogenic thickness) corresponds to the depth of the intersection of the moment curvature curve (red continuous lines) with the brittle deformation field, but could extend from the surface, $T_s(\min)$, to the brittle–ductile transition (BDT), $T_s(\max)$.
- T_e could extend from the thickness of the elastic core, $T_e(\min)$, to the thickness of the entire elastic plate, $T_e(\max)$.
- Both T_s and T_e depend on the moment generated by the load and, hence, the plate curvature. Yet, T_s increases with curvature while T_e decreases.

Te of oceanic lithosphere

Correlation between the observed flexural strength T_e and age- T of the oceanic lithosphere

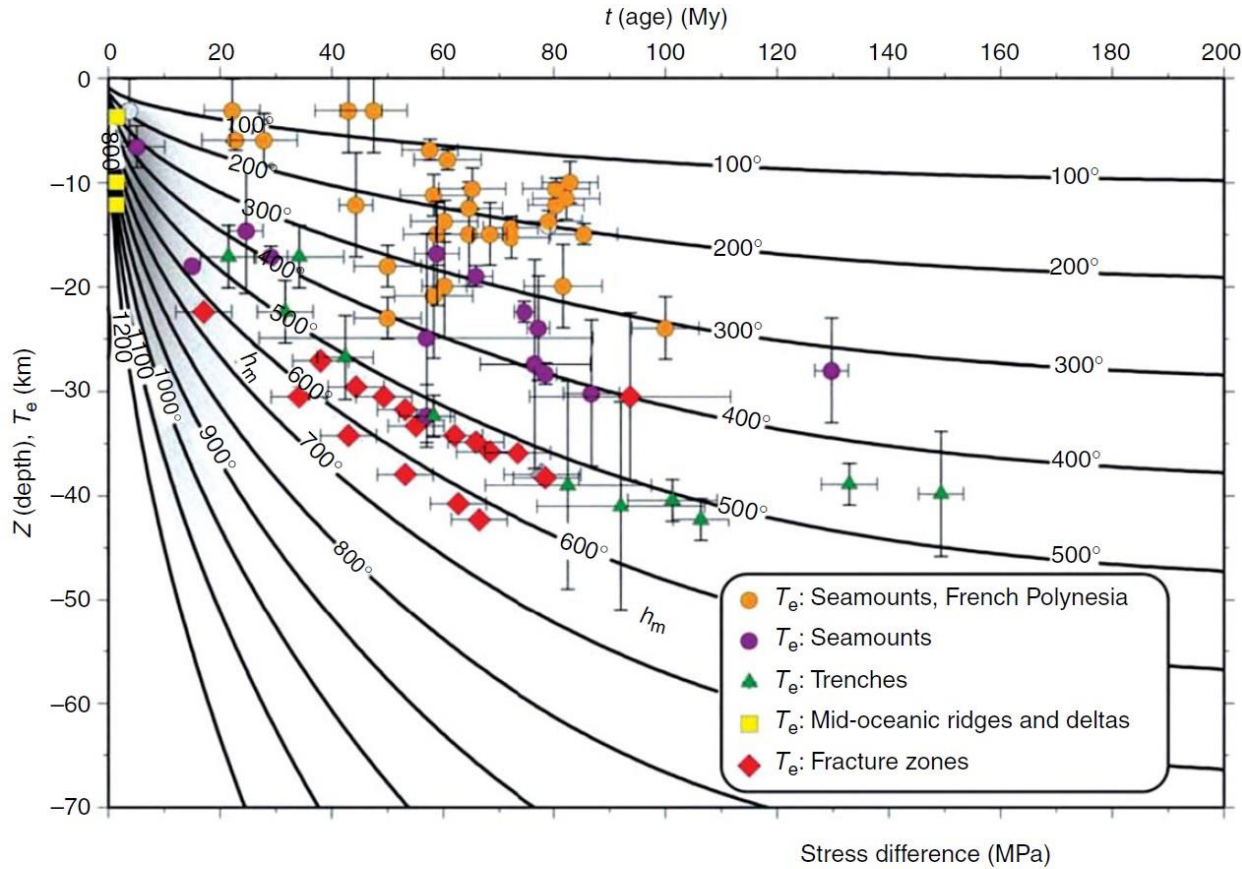

- T_e is between 2-40 km (correlates with the isotherm 400-500 °C) and depends on load and plate age.
- T_s and T_e seem to correlate, but $T_s \ll T_e$.

YSE and T_e of the oceanic lithosphere as function of age and T

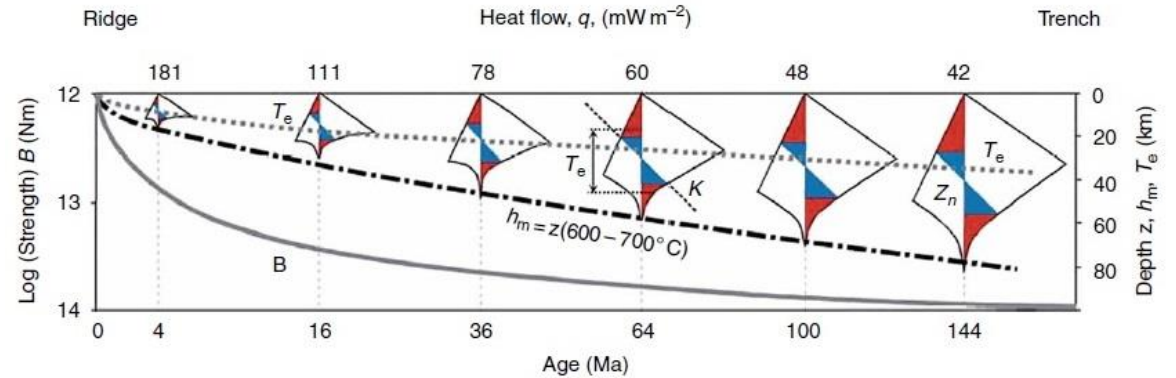

- A load emplaced on the lithosphere will be supported partly by the strength of the elastic core and partly by the brittle and ductile strength of the plate.

Seismogenic Thickness (T_s) vs Effective Elastic Thickness (T_e)

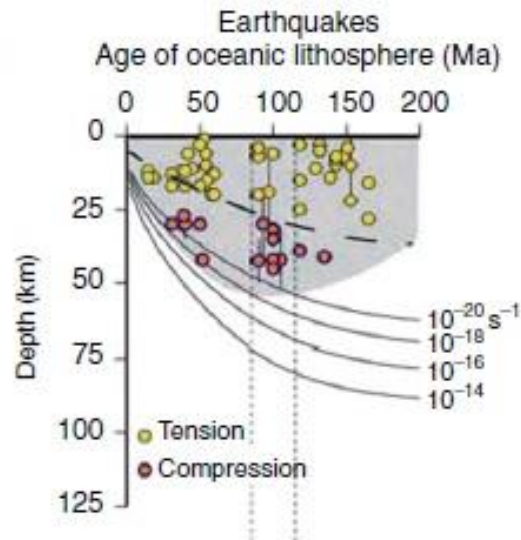
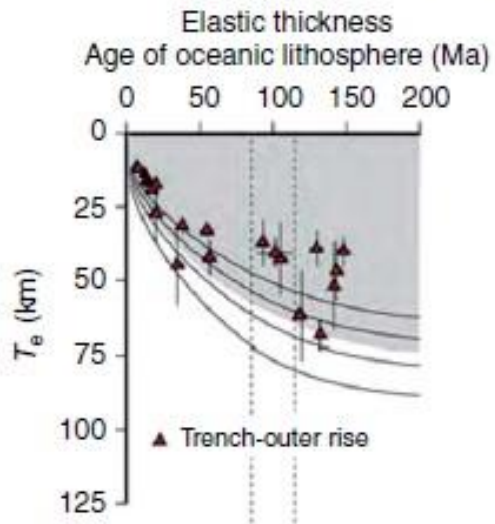
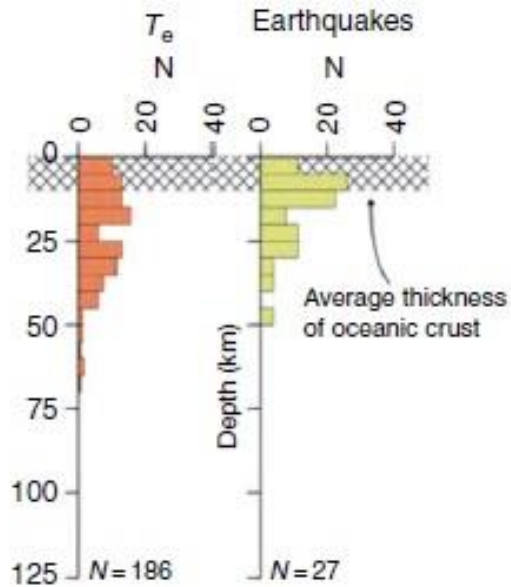

- Extensional earthquakes are shallower since extensional failure requires nearly two times smaller stress: earthquake depths are controlled by intraplate stress levels and decrease with increasing integrated strength of the lithosphere (B) if $B > F$ (tectonic force), since plate remains integer.
- Flexural stress may increase the value of T_s by a factor of 2–3, but at the same time it would decrease T_e by the same factor.
- Strong mechanical core associated with T_e is centered at the neutral plane of the plate, Z_n , while T_s is shifted to the surface.
- The upper crustal layers should fail easier than the lower mantle layers: At 50 km depth (the maximal depth of distributed seismicity), brittle rock strength is 2 GPa. Assuming 100 km thick lithosphere, one needs a horizontal tectonic force of 10^{14} Nm to reach this strength.
- For an elastic plate or brittle–elasto–ductile plate, Z_n is located roughly in its middle, at a depth $Z \sim 1/2 T_e(\text{max})$. In this case $T_s < 1/2 T_e$.
- Regions where earthquakes extend to great depths ($>40 \text{ km}$), such as in subduction–collision zones, are related to metastable mechanisms weakly related to rock strength.

Strength vs Effective Elastic Thickness (T_e)

The equivalent elastic thickness T_e of a plate with arbitrary rheology is given by:

$$M = -D \frac{\partial^2 w}{\partial x^2} = -E \frac{T_e^3}{12(1-\nu^2)} \frac{\partial^2 w}{\partial x^2} \quad T_e = \sqrt[3]{-M \frac{12(1-\nu^2)}{E} \left(\frac{\partial^2 w}{\partial x^2} \right)^{-1}} = \sqrt[3]{MK^{-1}G}$$

where $G = 12(1-\nu^2)E^{-1}$

T_e (YSE) reflects the integrated effect of all competent layers that are involved in the support of a load (including the weak ones). For a single-layer plate composed of n mechanically coupled rheological layers of thickness h_i :

$$T_e \approx b_1 + b_2 + \dots = \sum_n b_i$$

$T_e = nh$ if $h_1 = h_2 = h_3 \dots$

In a lithosphere composed of n mechanically decoupled layers (multilayer plates) there are several 'elastic' core inside the bending plate, T_e reflects the combined strength of all the brittle, elastic, and ductile layers. Then, T_e is not simply a sum of the thickness of these layers:

$$T_e(\text{YSE}) \sim (b_1^3 + b_2^3 + b_3^3 + \dots)^{1/3} = \left(\sum_{i=1}^n b_i^3 \right)^{1/3}$$

$T_e = n^{1/3}h$, if $h_1 = h_2 = h_3 \dots$. Then, T_e is reduced by a factor of $n^{2/3} = 40\text{-}50\%$ for $n < 4$.

The base of the mechanical competent layer in the continental mantle lithosphere, h_m , is referred to as isotherm of 700–750°C, below which the yielding stress is less than 10–20 MPa (for a strain rate = 10^{-15} s^{-1}).

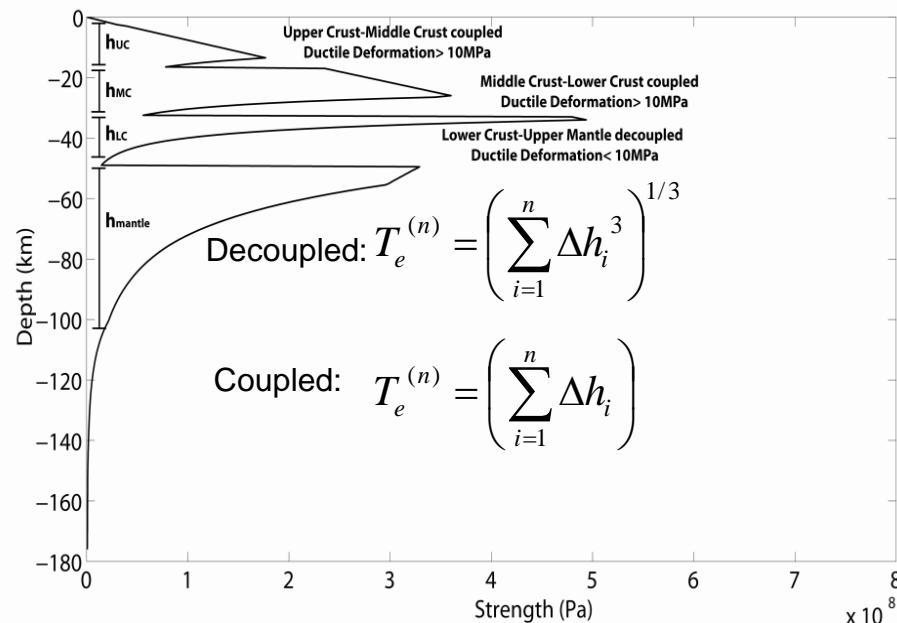

- ❑ For 'typical' continental lithosphere the weak ductile zones in the lower crust do not allow flexural stresses to be transferred between the strong brittle, elastic, or ductile layers of the 'jelly sandwich'.
- ❑ As result, there are several 'elastic' cores inside the bending plate. In such a multilayer plate stress levels (and thus T_e) are reduced, for the same amount of flexure, compared to a single plate.
- ❑ If the continental lithosphere is subject to large loads, it flexes, and the curvature of the deformed plate, K , increases. T_e (YSE) is a function of K and is given by: $T_e(\text{YSE}) = T_e(\text{elastic}) C(K, t, h_{c1}, h_{c2}, \dots)$

where C is a function of the curvature K , the thermal age t , and the rheological structure

Strength vs Effective Elastic Thickness (T_e)

Relationships between rheological structure, age, and Moho depth

Dependence of continental T_e on age and curvature of the lithosphere

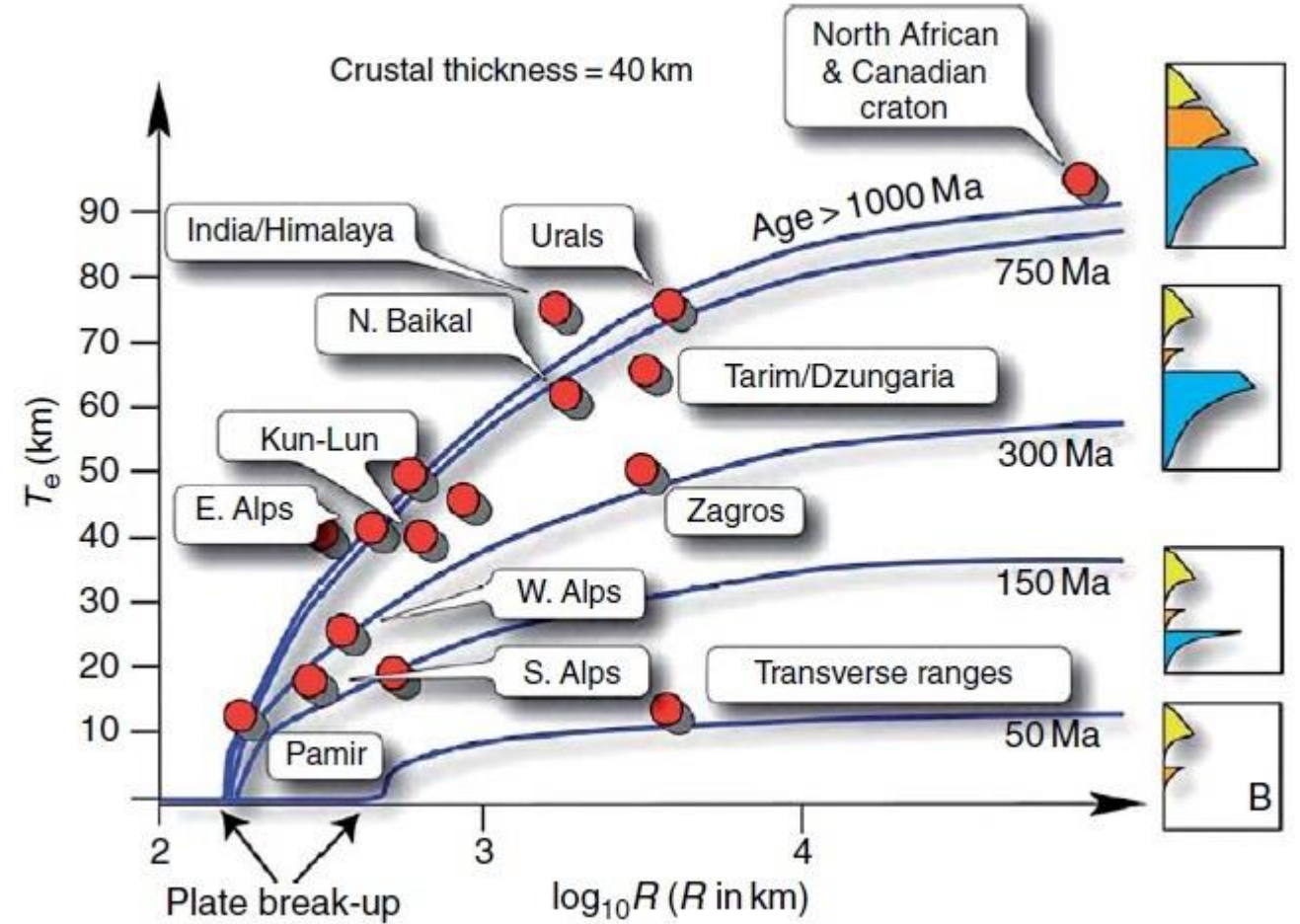
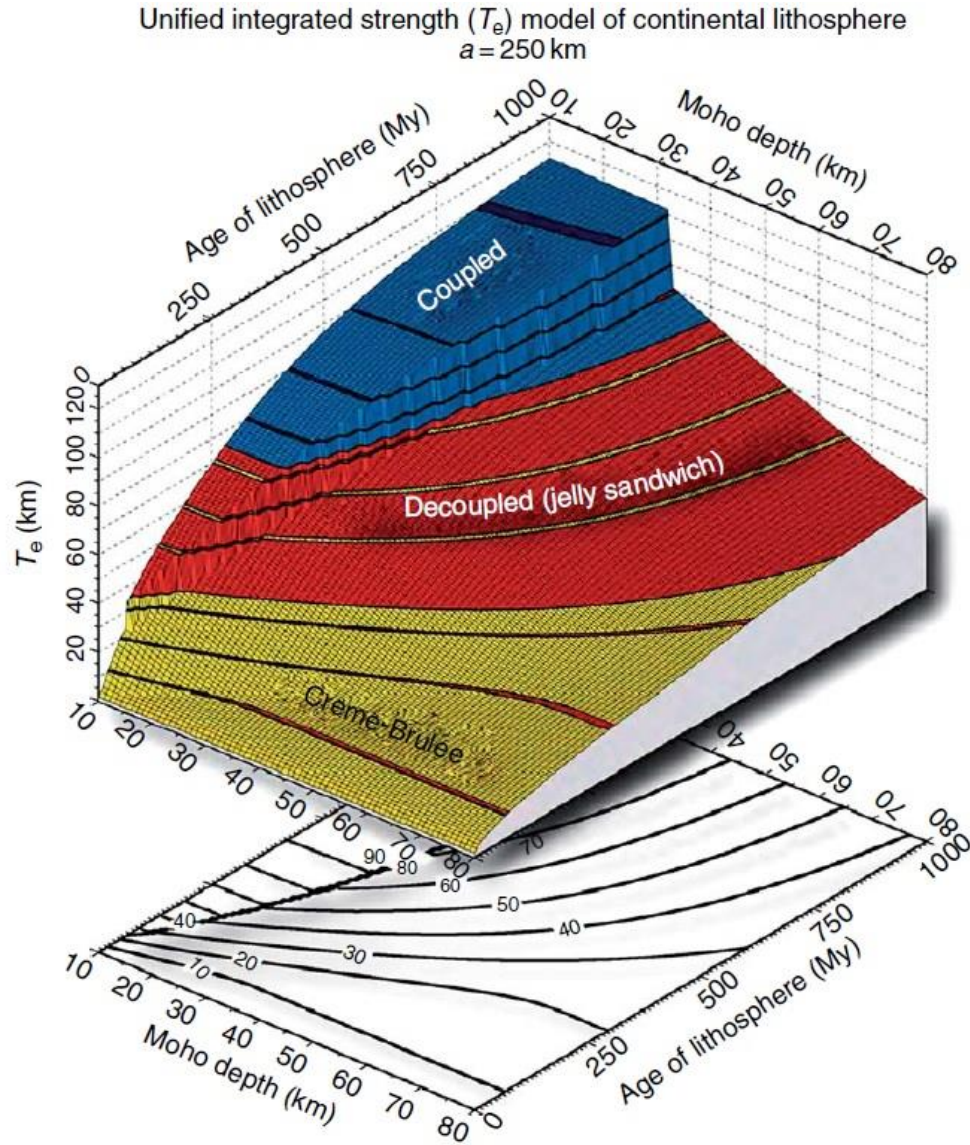

Strength vs Effective Elastic Thickness (T_e)

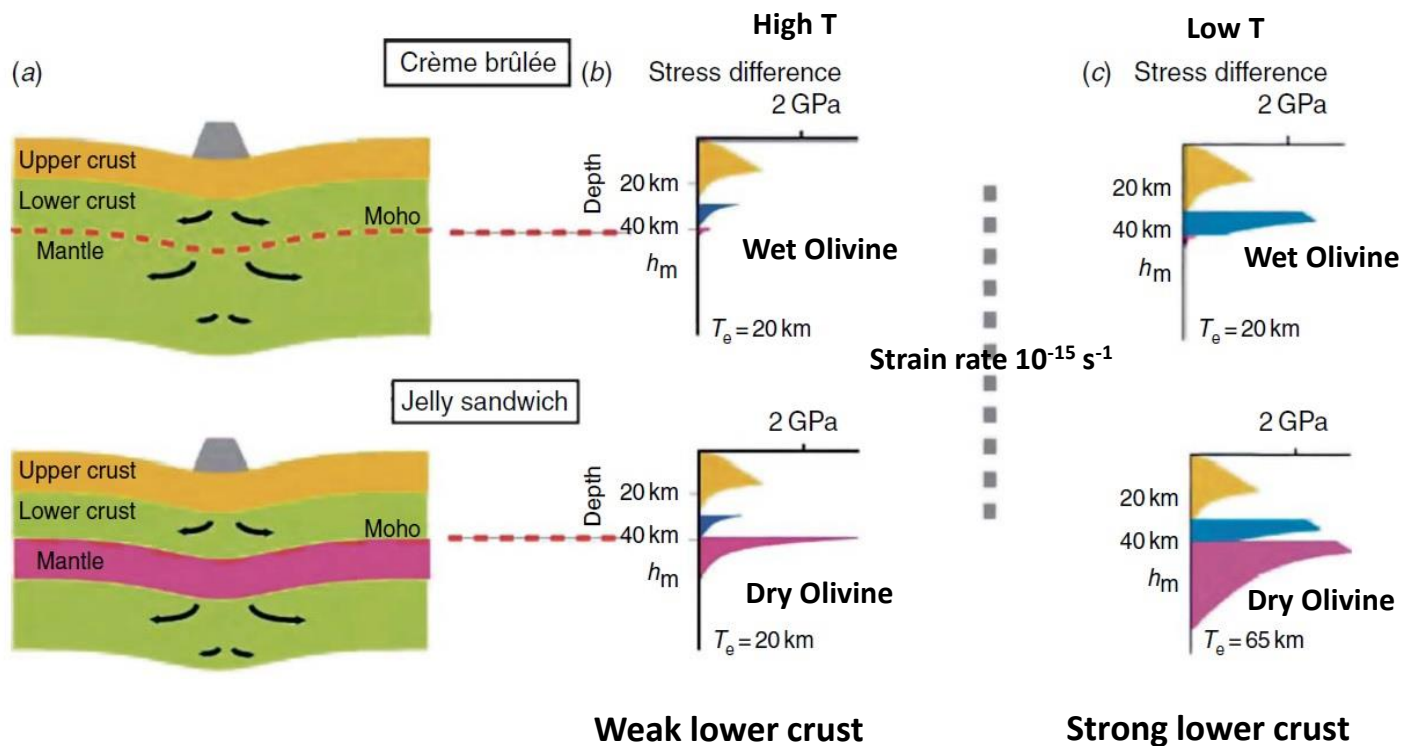

T_e vs age and temperature of continental lithosphere

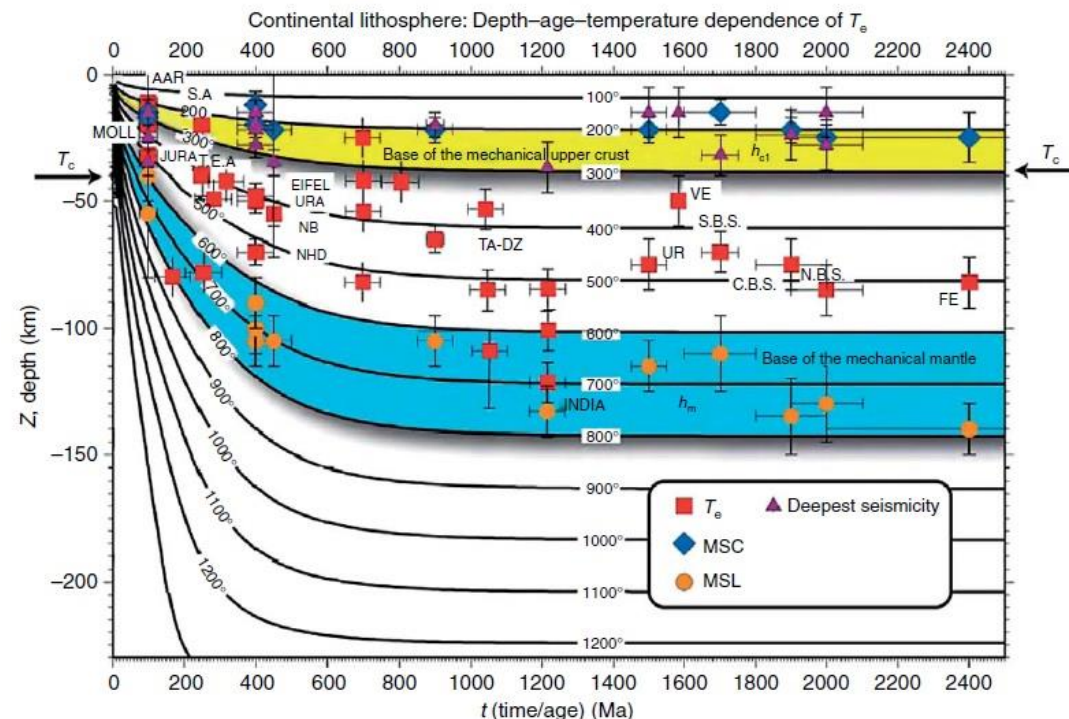

MSC = base of the mechanically strong crust
MSL = base of the mechanically strong lithosphere

E.A, Eastern Alps; W.A., Western Alps; AD, Andes (Sub Andean); AN, Apennines; AP, Appalachians; CR, Carpathians; CS, Caucasus; DZ, Dzungarian Basin; HM, Himalaya; GA, Ganges; KA, Kazakh shield (North Tien Shan); KU, Kunlun (South Tarim); NB, North Baikal; TA, Central and North Tarim; PA, Pamir; TR, Transverse Ranges; UR, Urals; VE, Verkhoyansk; ZA, Zagros. Post-glacial rebound zones: L.A., lake Algonquin; FE, Fennoscandia; L.AZ, lake Agassiz; L.BO, lake Bonneville; L.HL, lake Hamilton.

- Crème brûlée model: strength prevalently concentrated in the crust
- Jelly Sandwich model: strength distributed in both crust and upper mantle
- In the crème brûlée model, the strength is confined to the uppermost brittle layer of the crust and compensation is achieved mainly by flow in the weak upper mantle.
- In the jelly-sandwich model, the mantle is strong and the compensation for surface loads occurs mainly in the underlying asthenosphere.

Strength vs Effective Elastic Thickness (T_e)

Plate curvature, T_e , and T_s

For curvatures up to 10^{-6} m^{-1} T_e is always larger than T_s .

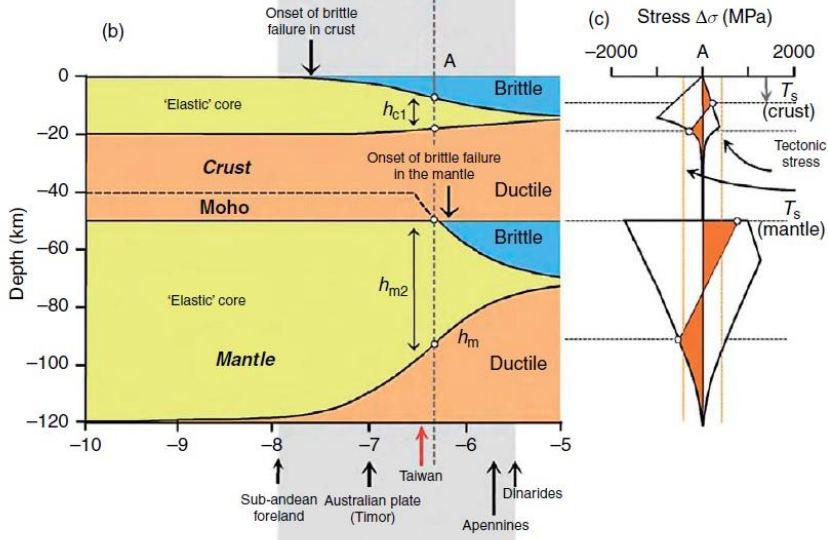
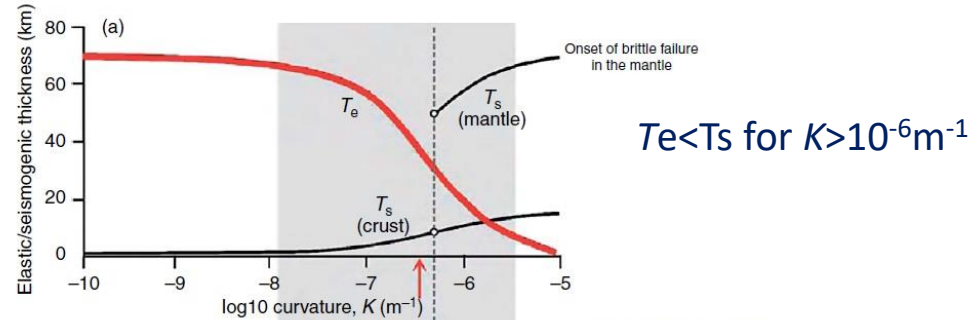

Weak lower crust

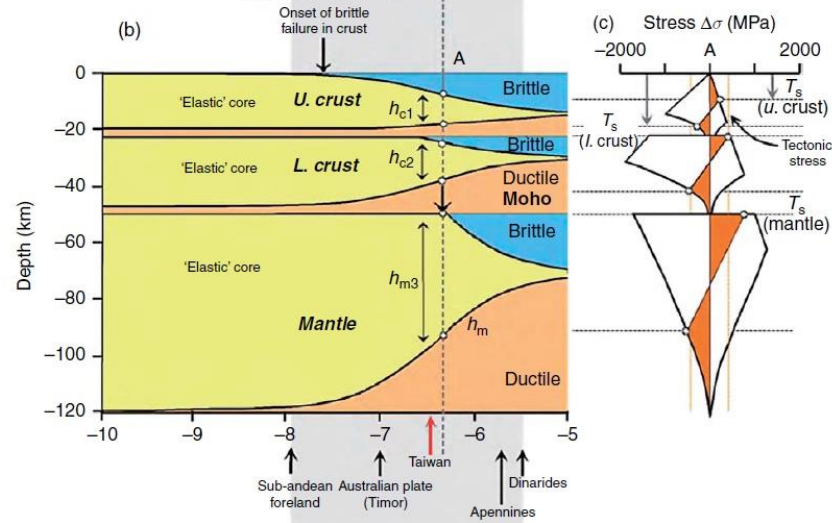
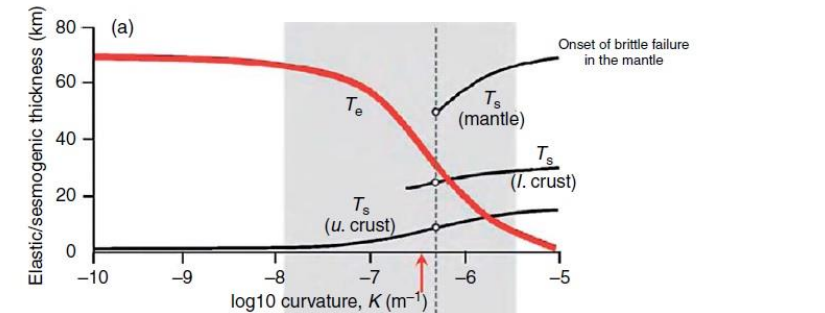

Strong lower crust

- T_s reflects the thickness of the uppermost weak brittle layers that respond on historical timescales to stresses by faulting and earthquakes.
- T_e reflects the integrated strength of the entire lithosphere that responds to long-term ($\sim \text{Myr}$) geological loads by flexure.
- The onset of brittle failure in the mantle does not occur until the amount of flexure and thus the curvature is very large ($>10^{-6} \text{ m}^{-1}$).

Strength vs Effective Elastic Thickness (T_e)

Plate curvature, T_e , and T_s

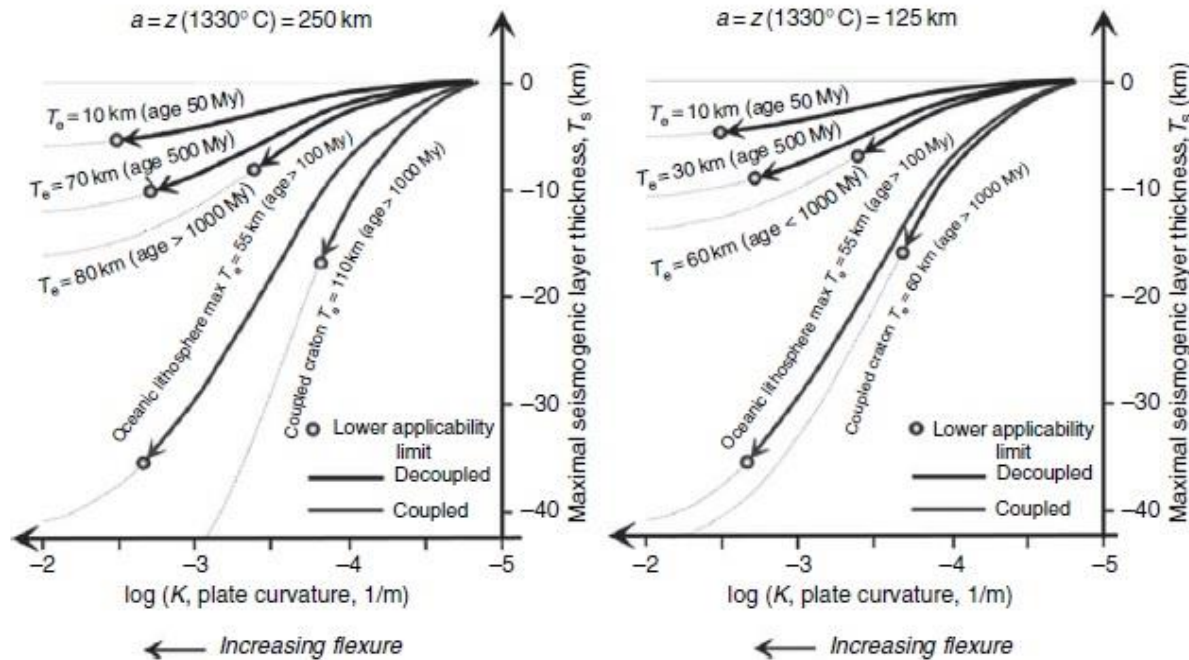
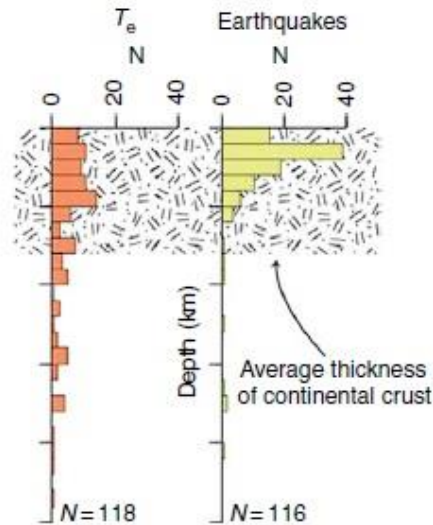

- In regions of **low curvature** the mantle is largely involved in the support of long-term flexural-type loads.
- In regions of **high curvature** the mantle may be seismic, but the support of long-term loads is confined to the crust.
- High T_e values limit the amount of curvature due to flexure and the ratio of T_e to T_s increases with thermal age (and strength).
- In the de-coupled case, T_s does not exceed 15km, while in the coupled case the values of T_s may grow, but as T_e increases the curvature decreases.
- Oceanic lithosphere is associated with the highest values of T_s , since the crust is thin (7 km), then always coupled with mantle lithosphere.
- Upper mantle can be weak at geological timescale (crème brûlée model) but not at seismic timescale: ductile creep cannot be activated at seismic timescale (for strain rate: 10^1 - 10^4 s^{-1} we need stress $> 1\text{GPa}$).
- Seismicity is mostly confined in the upper crust because of upper crust–mantle decoupling and/or insufficient level of intraplate stress compared to high brittle strength.
- Cases of deep seismicity occur more often in extensional settings (2-3 times higher stress for brittle failure in compression than in tension).

World Te Maps

Coupling/Decoupling conditions

'Soft' rheology: UC: 'dry quartzite' and LC='wet diorite'

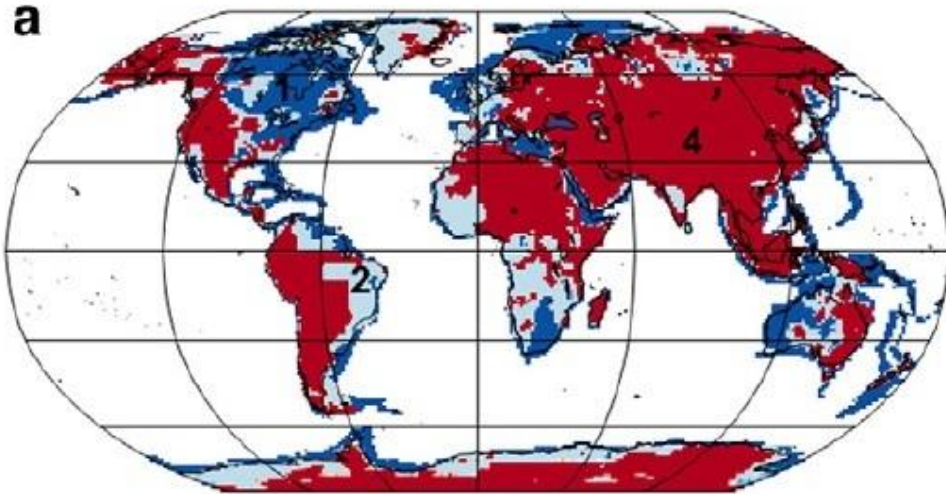

'Hard' rheology: UC= 'dry granite' and LC= 'mafic granulite'

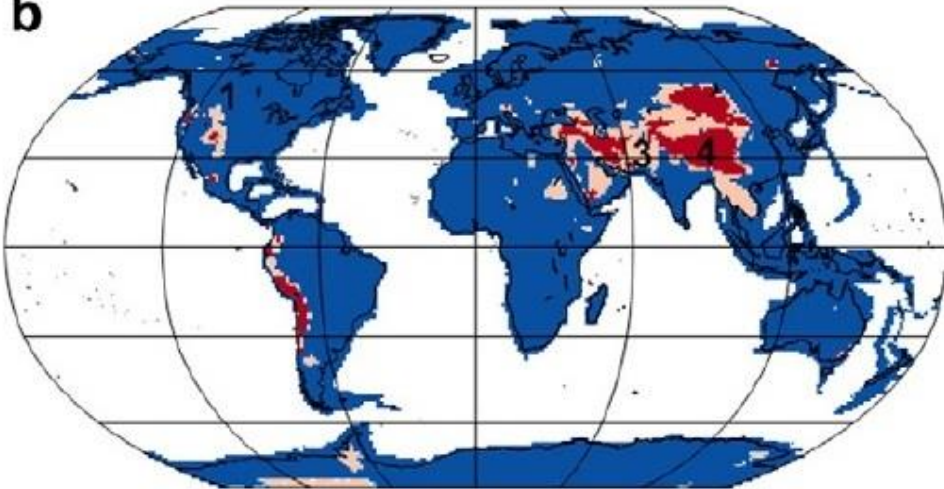

1 crustal layers and mantle lithosphere coupled (in blue); 2 crustal layers coupled and mantle lithosphere decoupled (in azure); 3 crustal layer decoupled and mantle lithosphere coupled (in pink); 4 crustal layers and mantle lithosphere decoupled (in red).

Te

'Soft' rheology: UC: 'dry quartzite' and LC='wet diorite'

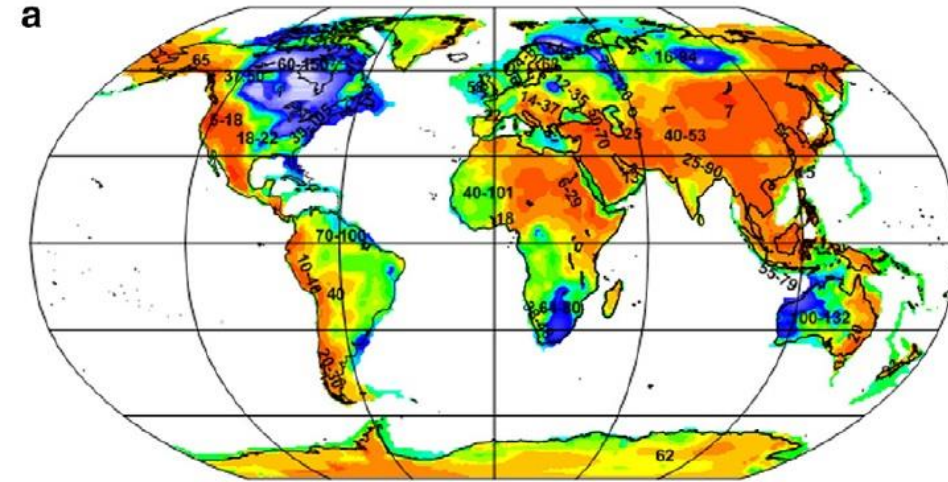

'Hard' rheology: UC= 'dry granite' and LC= 'mafic granulite'

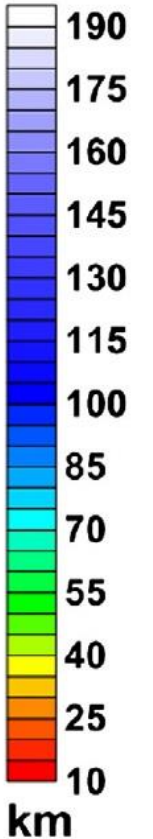
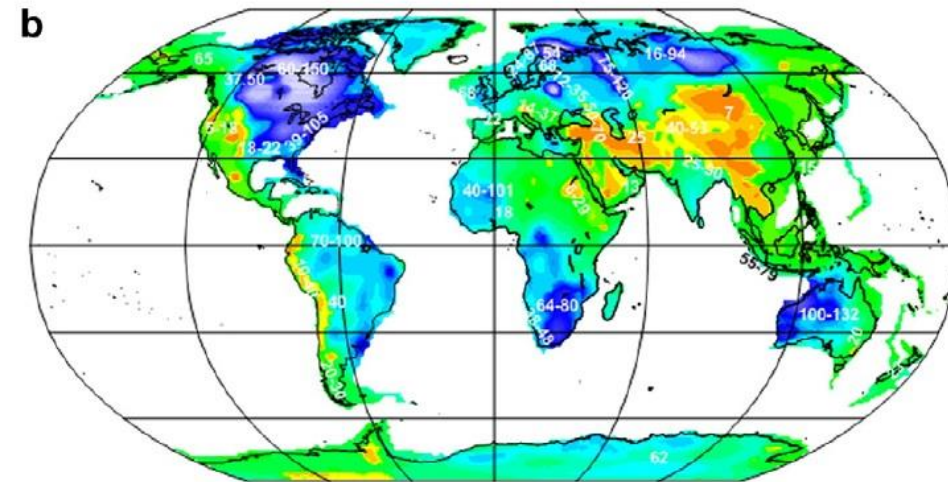

North America *Te* model of the Lithosphere

Coupling/Decoupling Conditions

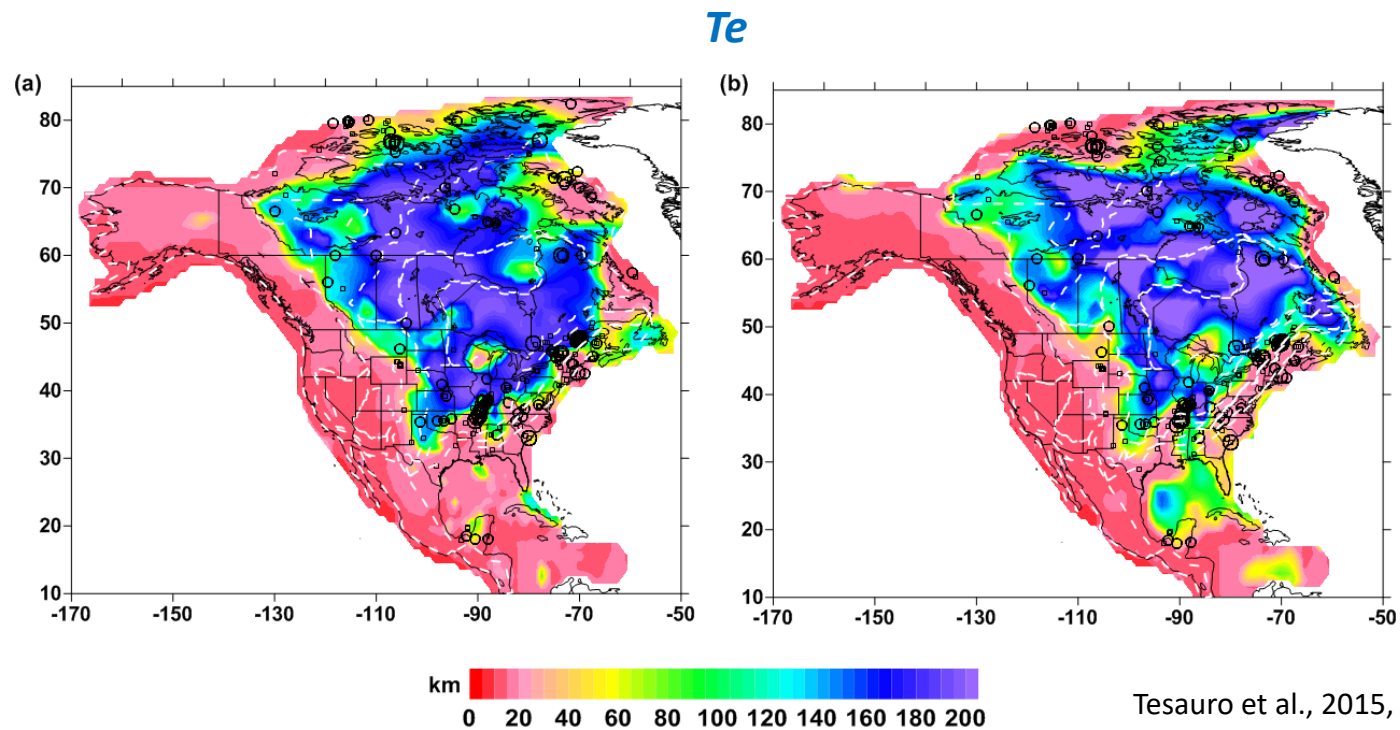
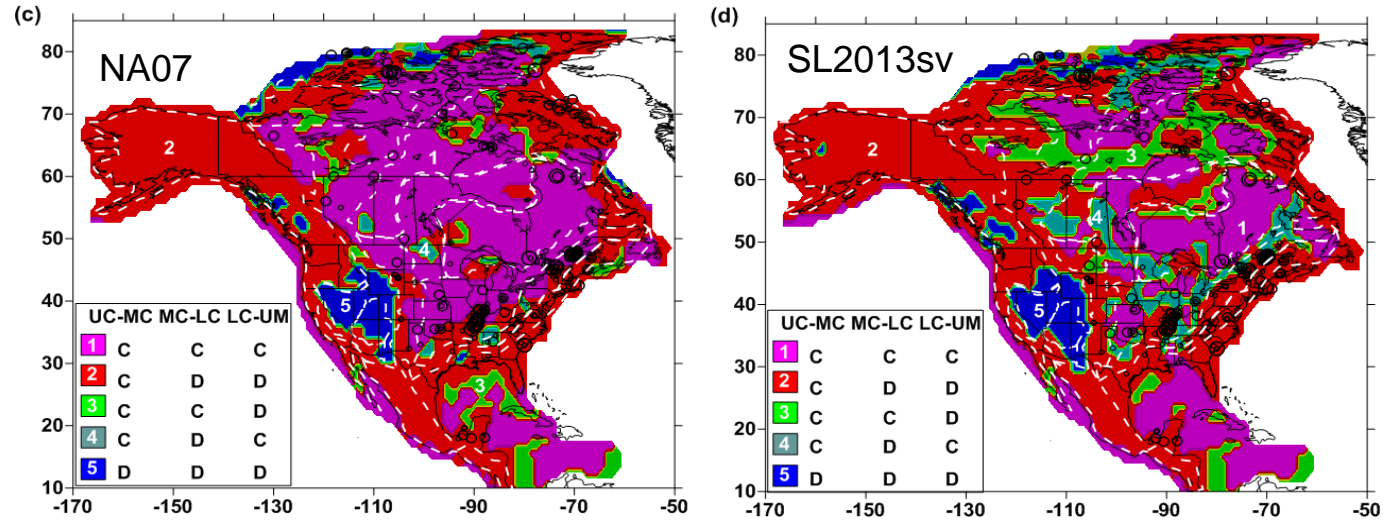

Te from gravity models

Forward modeling: the gravity anomaly due to a load (i.e. topographic surface) and its flexural compensation is calculated for different values of T_e and compared to the observed gravity anomaly. The 'best fit' T_e is then determined as the one that minimizes the difference between observed and calculated gravity anomalies.

In inverse (e.g., spectral) models: gravity and topography data are used to estimate T_e directly by computing the transfer function between them as a function of wavelength (e.g., admittance or coherence) and comparing it to model predictions.

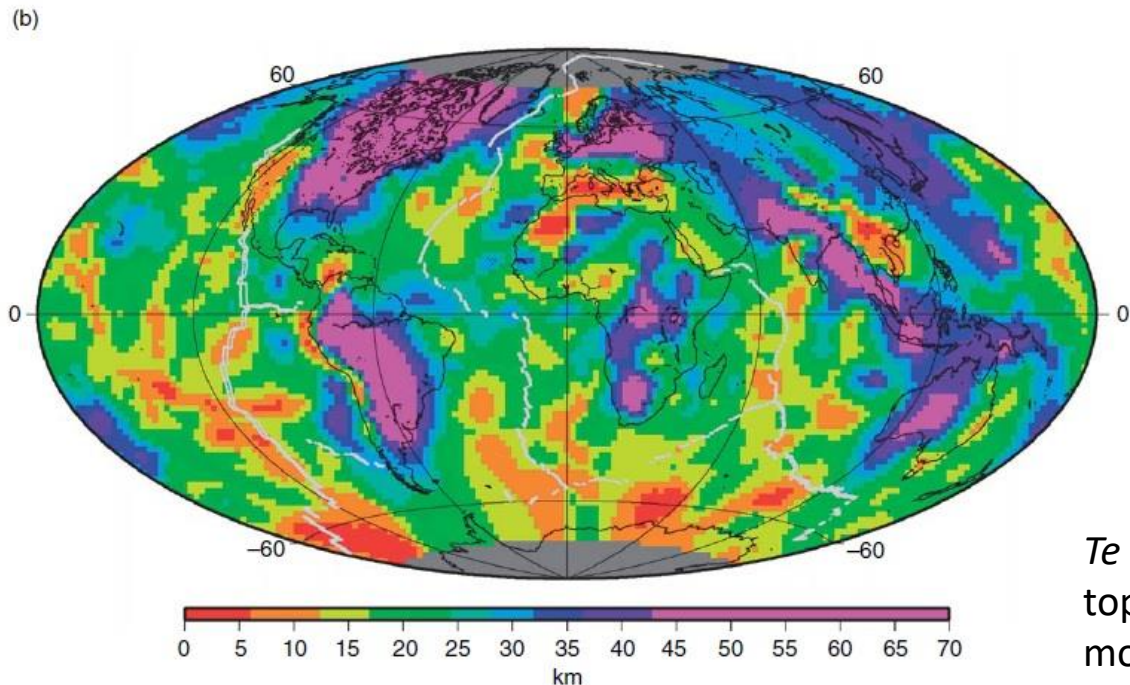
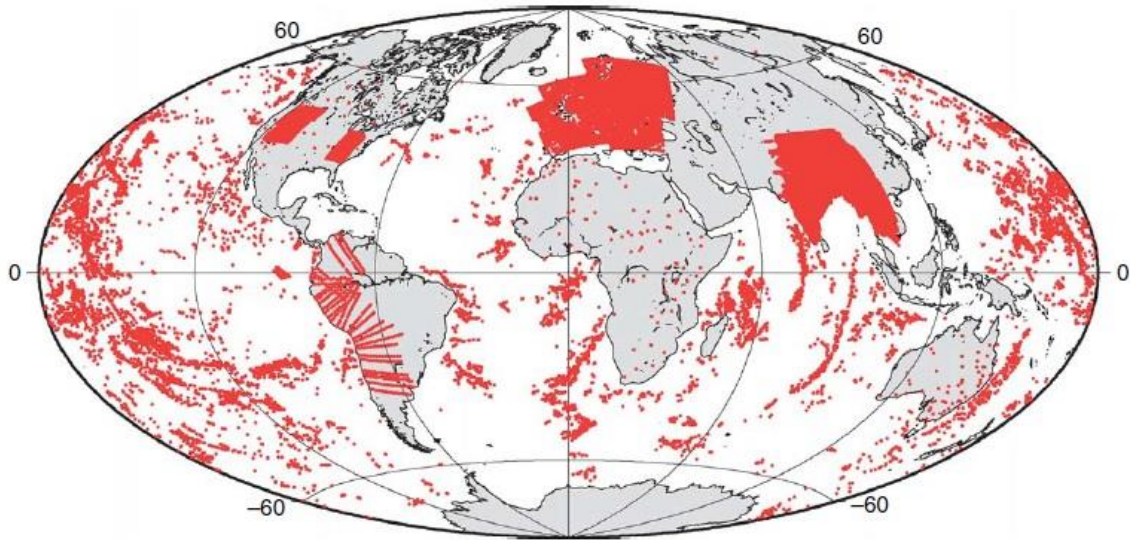

T_e estimates derived from studies of gravity anomaly and topography/bathymetry using both forward and inverse (i.e., spectral) modeling techniques. The map is based on a 2x2 grid of the T_e estimates.

Strength and stability

Crème-brûlée vs Jelly sandwich model

Depending on its viscosity the mantle lithosphere has the potential to sink as a result of Rayleigh–Taylor (RT) instability ($\rho_m > \rho_a$)

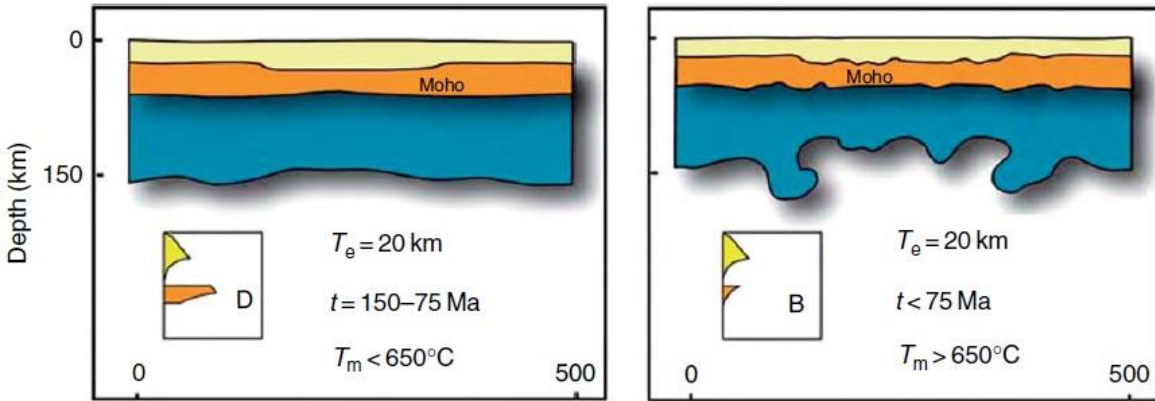

Instability growth time (t): the time it takes for the instability of a mantle root to be amplified with respect to its initial value.

The growing instability wavelength λ of a lithospheric mantle is Ad where $2.5 < A < 3.0$ and d the thickness of the lithospheric mantle. The corresponding growth time, $t_{\min} = B\mu(\rho_m - \rho_a)gd^{-1}$ where $6.2 < B < 13.0$ and g is the average gravity. We can evaluate t_{\min} for a particular μ (mantle viscosity) by assuming $(\rho_m - \rho_a) = 20 \text{ kgm}^{-3}$ and $80 < d < 100 \text{ km}$.

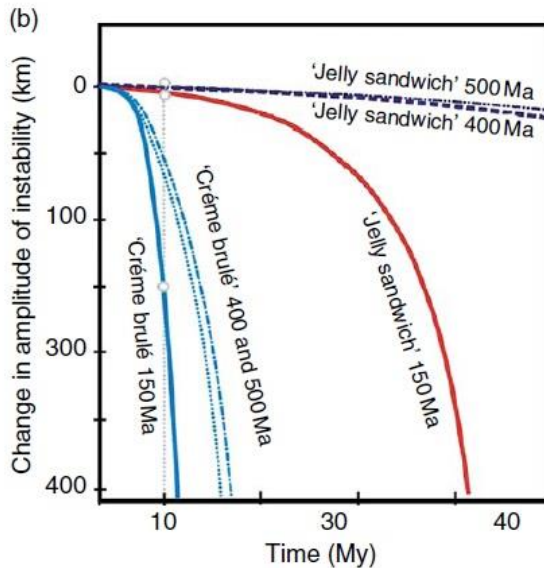

- For a **jelly-sandwich model** the continental mantle can support large stresses ($>2 \text{ GPa}$) and has a high viscosity ($10^{22} - 10^{24} \text{ Pa s}$), then t_{\min} will be long ($>0.05 - 2 \text{ Gyr}$), comparable with age of cratons.
- For a **crème brûlée model**, the stresses are small ($0 - 10 \text{ MPa}$) and the viscosity is low ($10^{19} - 10^{20} \text{ Pa s}$), then t_{\min} will be short ($0.2 - 2.0 \text{ Myr}$). This model implies that the tectonic features will collapse (surface tectonic feature will disappear) in few Myr.

□ By 10 My, the lithosphere disintegrates due to delamination of the mantle followed by its convective removal and replacement with hot asthenosphere.

Strength and stability

Crème-brûlée vs Jelly sandwich model

Deformation after 5 Myr, producing 300 km of shortening at 60 mm yr⁻¹

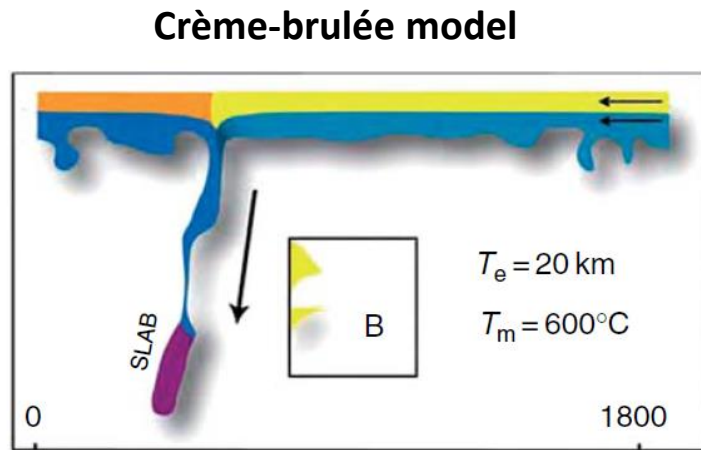
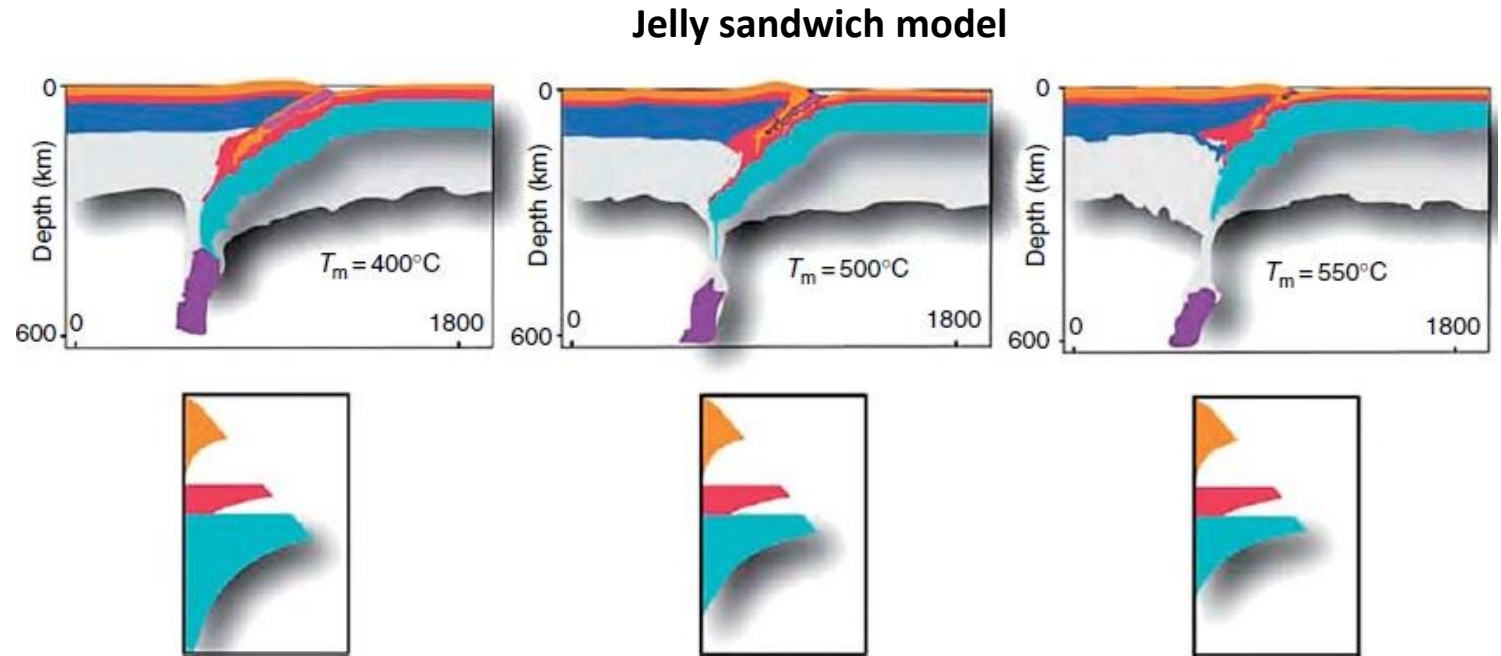
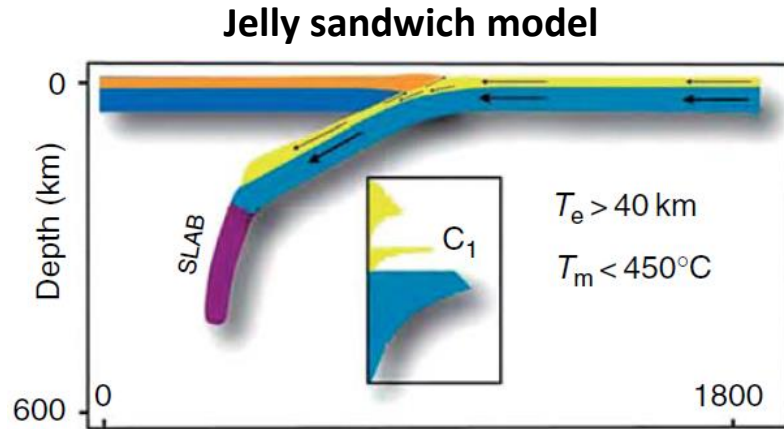

An increase of Moho temperature promotes RT instability

- Crème brûlée models are unable to explain those features of collisional systems that require subduction.
- Jelly-sandwich models produce stable subduction and can explain structural styles of collisional systems (e.g., those associated with slab flattening).

Folding models for continental lithosphere

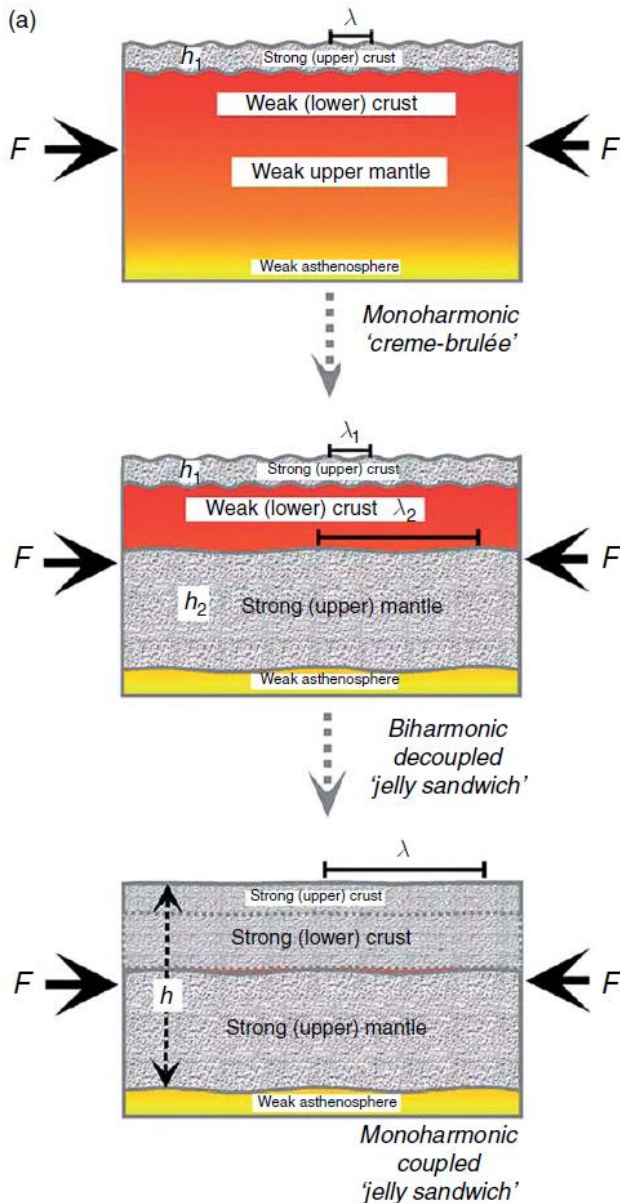

A very hot lithosphere causes one dominant **small** wave-length controlled by the upper crust (monoharmonic pattern).

Typical values: tens of kms

A normal lithosphere produces two dominant wave-lengths controlled by the crust and the upper mantle (decoupled biharmonic pattern).

A very cold lithosphere causes one dominant large wave-length controlled by the entire lithosphere (monoharmonic pattern).

Typical values: 150-400 km

Faults are controlled by the wavelength of folding and tend to localize at the inflection points of folds.

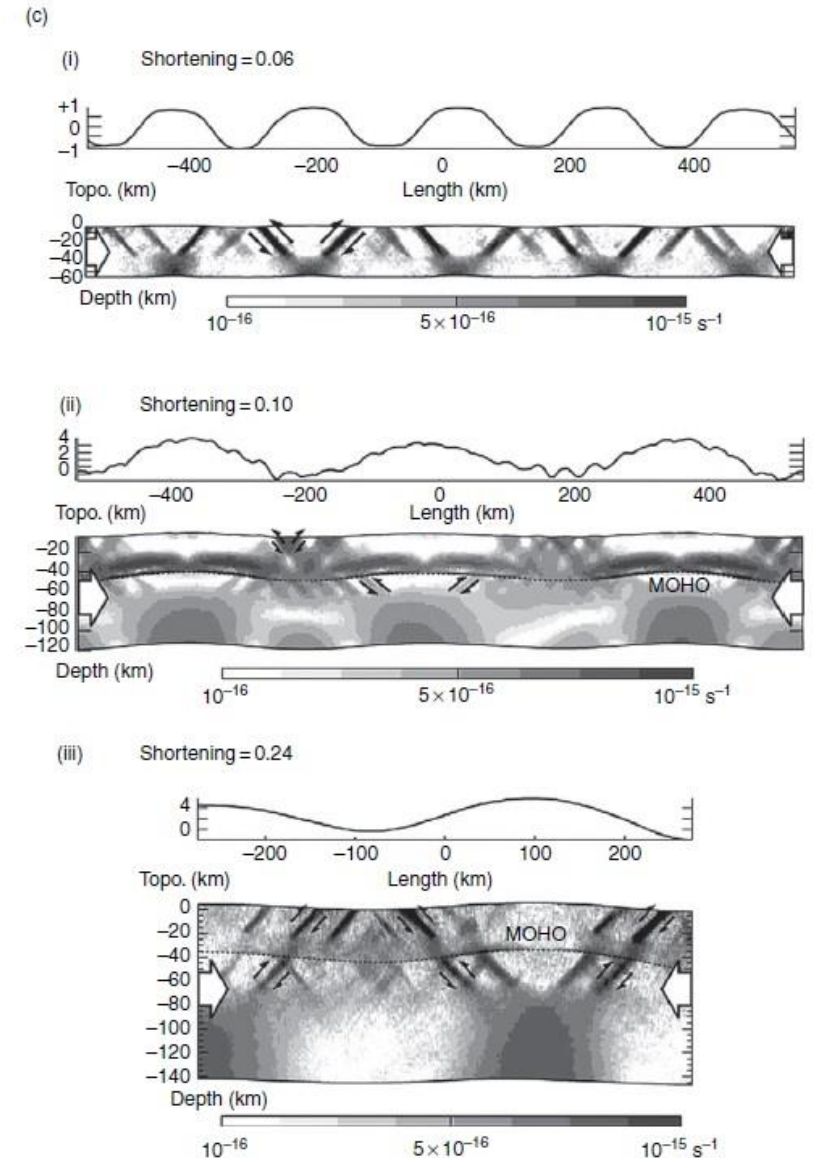

Folding models for continental lithosphere

Wavelength of crustal and lithospheric folding increases with thermal age of the lithosphere: The wavelengths, λ , of small-amplitude folding are proportional to 5–10 thickness of the competent layers: $\lambda < 5-10h \sim 5-10T_e$

In continental lithosphere, there may be several competent layers, which yield different folding wavelengths:

- In case of Central Asian lithosphere, two wavelengths are depictable: crustal (50–100 km) and mantle (300–350 km).
- In case of cratons (Central Australia), the folding wavelength reaches 600–700 km indicating a 60-km-thick competent layer.

High ratios λ/T_e (e.g., $\lambda/T_e > 10$) may be due to very weak lithosphere loaded by $\gg h_{sed}$, while small ratios λ/T_e (e.g., $\lambda/T_e < 4$) may be related to the amount of shortening.

Wavelength of folding vs age of continental lithosphere

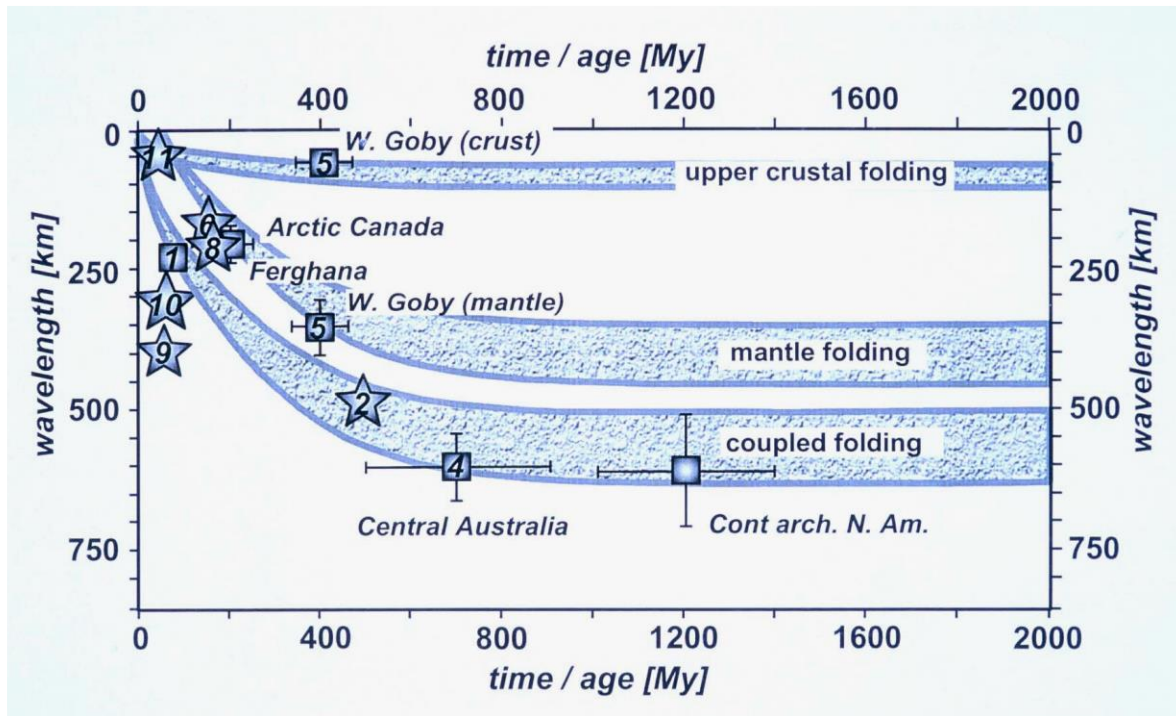

λ (km)	T_e (km)	λ/T_e	Thermal age (Ma)	t_0 , onset of folding (My BC)	Present state of folding	Type
200–250 (1)	< 40	>4–5	60	8	Active deformation	B
500–600(2)	50–70	10	400–600	60	preserved	N
200 (3)	30	6–7	200	60	preserved	B
200(present)-> 400–500 (preserved) (4)	25 (after recent reheating at 200 Ma)	8	>700	400–700	preserved	B
300–360 (5)	>15 *	>20	175–400	8–10	Active deformation	B
100–200 (6)	Not available, Approx. >30	4–6	>100	60	preserved	B/N
200 ? (7)	20–35	10–15	300	6	Active subsidence	N
200–250(8)	15	13	175	8–10	Active deformation	B/N
350–400 (9)	6–9 *	> 30	< 20	4–6	Active deformation	N
300 (10)	10–30	10	30	6–8	Active deformation	B/N
40(11)	20–25 *	2	< 20	6–8	Active deformation	N
50 (12)	20–25 *	2	20	6–8	Active subsidence	N
600 (13)	>100	6	>1200	1200	preserved?	B
60 (14)	<10	6	65	35–8 My	Active deformation	B/N

(1) Indian Ocean, (2) Russian platform, (3) Arctic Canada, (4) Central Australia, (5) Western Goby, (6) Paris Basin, (7) North Sea Basin, (8) Ferghana and Tadjik Basin, (9) Pannonian Basin, (10) Iberian Basin, (11) Southern Tyrrhenian Sea, (12) Gulf of Lion, (13) Transcontinental Arch of North America; (14) Norwegian sea.

Squares=regular folding Stars=irregular folding

References

Main Readings

Books:

- Stuwe, 2007, Kinematics: Morphology and Deformation (Chapter 4), Geodynamics of the Lithosphere, Springer.
- Stuwe, 2007, Mechanics: Force and Rheology (Chapter 5), Geodynamics of the Lithosphere, Springer.
- Burov, 2009, Plate Rheology and Mechanics, Treatise of Geophysics, vol. 6.
- Gerya, 2010, Stress and strain (Chapter 4), Introduction to numerical geodynamic modelling.

Articles:

- Tesauro et al., 2013, Global model for the lithospheric strength and effective elastic thickness. *Tectonophysics*, 602, 78–86.

Further readings:

- Collettini et al., 2019, Beyond Byerlee friction, weak faults and implications for slip behavior, *EPSL*, 519, 245-263.
- Fagereng and Beall, 2020, Is complex fault zone behaviour a reflection of rheological heterogeneity? *Phil.. Trans. R. Soc. A* 379: 20190421
- Kreemer et al., 2014, A geodetic plate motion and Global Strain Rate Model, *G3*, 15.
- Mareschal and Jaupart, 2013, Radiogenic heat production, thermal regime and evolution of continental crust, *Tectonophysics*, 609, 524-534.
- Tesauro et al., 2015, Variations of the lithospheric strength and elastic thickness in North America, *Geochem. Geophys. Geosyst.*, 16, doi:10.1002/2015GC005937.
- Watts, 2007, An Overview, *Treatise of Geophysics*, vol. 6, 1-48.