

Le strutture duttili

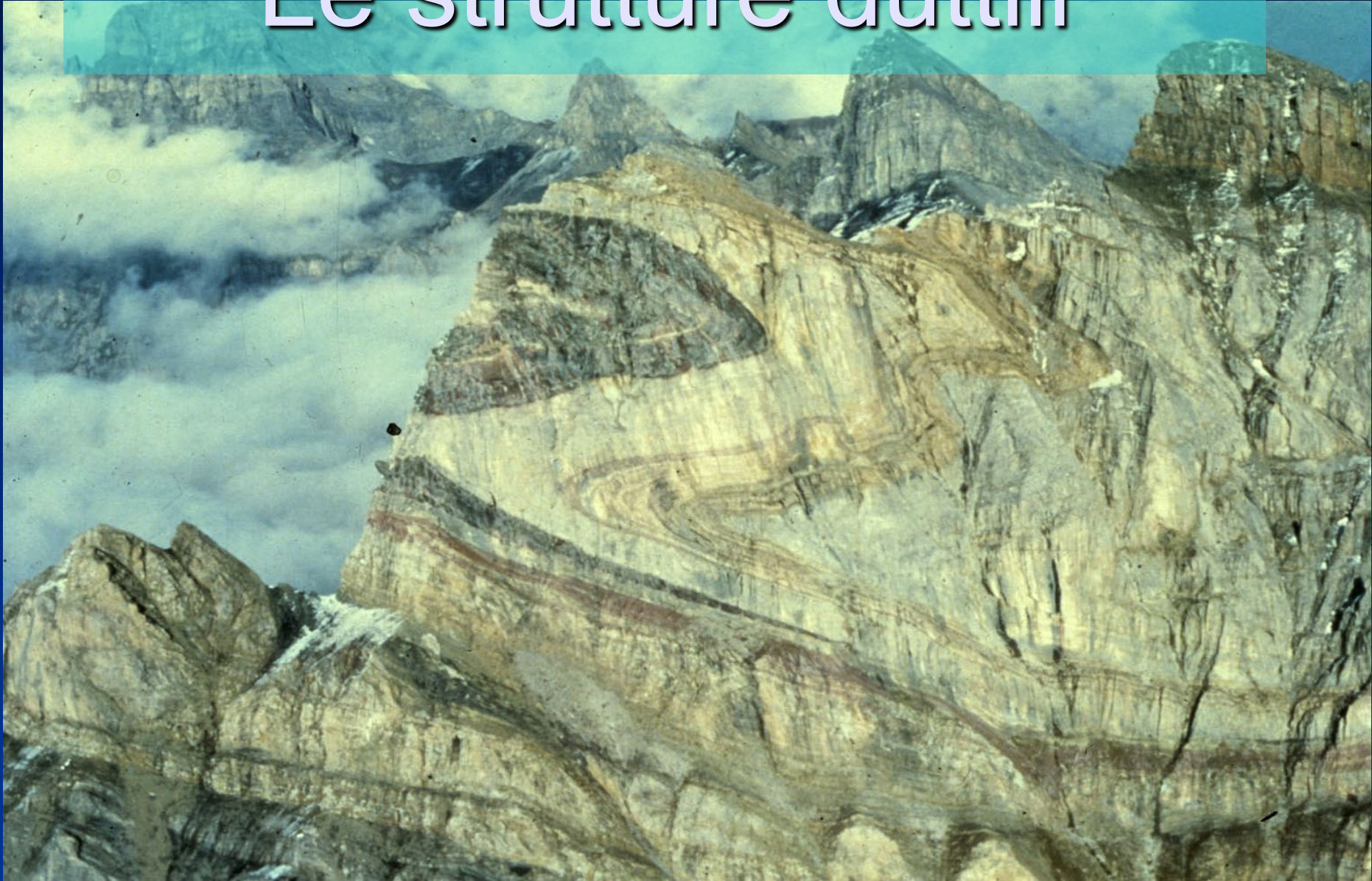

Da Ramsay and Huber, 1987

Immagini e fotografie tratte da:

- Barker A.J., 1990. Introduction to Metamorphic Structures and Microstructures. Chapman & Hall.
- Mercier J., Vergely P., 1996. Tettonica. Pitagora Editore.
- Mercier J., Vergely P., 1995. Tectonique, 2ème edition, Dunod.
- Passchier C.W., Trouw R.A.J., 2006. Microtectonics. Springer.
- Pini, materiale inedito.
- Price N.J., Cosgrove J.W., 1990. Analysis of Geological Structures. Cambridge University Press
- Ramsay J.G., 1967. Folding and Fracturing of Rocks. McGraw Hill.
- Ramsay J. G., Huber M. I., 1984. The Techniques of Modern Structural Geology. Volume 1: Strain analysis. Academic Press Inc.
- Ramsay J. G., Huber M. I., 1987. The Techniques of Modern Structural Geology. Volume 2: Folds and Fractures. Academic Press Inc.
- Suppe J., 1985. Principles of Structural Geology. Prentice-Hall Inc.
- van der Pluijm B., Marshak S., 2004. Earth Structure: An Introduction to Structural Geology and Tectonics, Second Edition. WW Norton & Company.



Da Ramsay and Huber, 1987

Le strutture duttili

CARATTERISTICHE:

- 1) Deformazione continua
- 2) Comportamento duttile della roccia

TIPICI:

- 1) Strutture da deformazione omogenea (*variazione forma oggetti, boudinage*)
- 2) Fabric (*foliazione, scistosità, clivaggio da crenulazione, lineazioni*)
- 3) Strutture da deformazione disomogenea (eterogenea) (*interazioni oggetti-matrice, zone di taglio duttile*)

Deformazione di oggetti

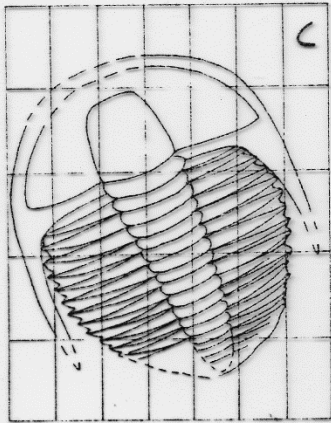

FIG. 3.66
DEFORMAZIONE DI
FOSSILI. C = STATO
INDEFORMATO
DA RAJSAJ E HUBER, 1984

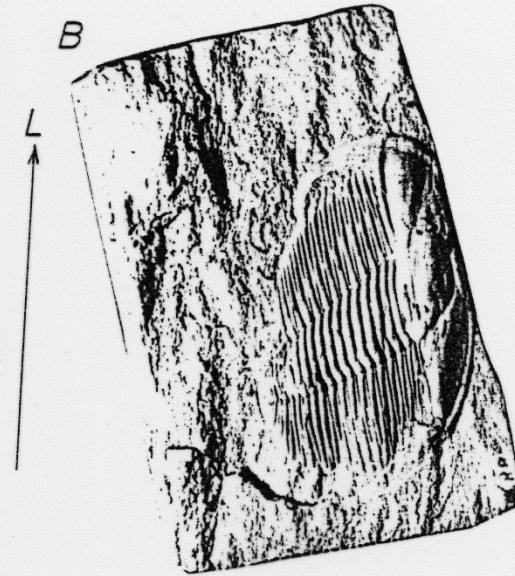
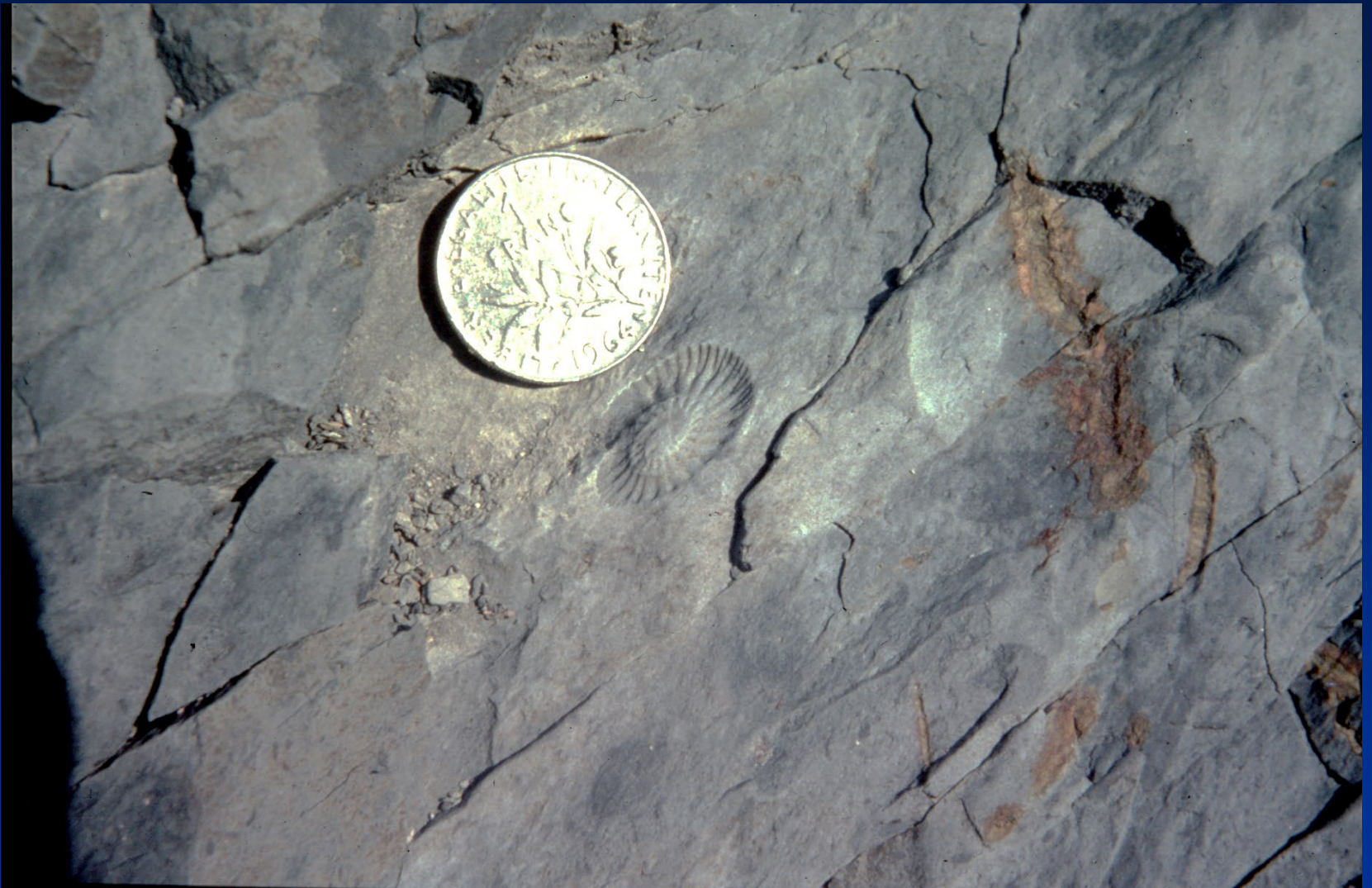

Figure 8.7. Two specimens of Angelina for the determination of principal strain ratio R (Question 8.1). L is the stretching lineation for both specimens.



Da Ramsay and Huber, 1987

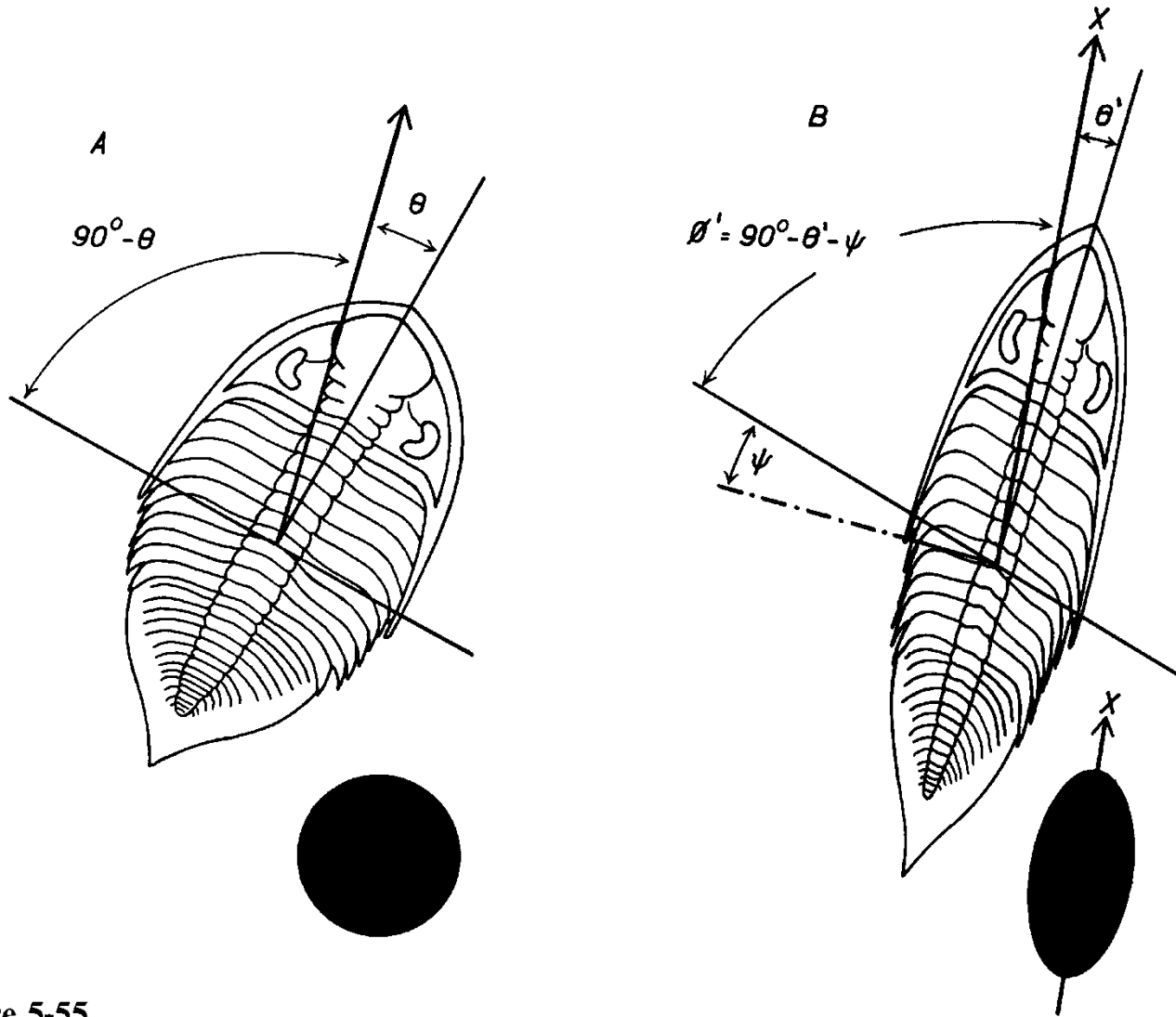

Figure 5-55

Changes in angle within an originally bilaterally symmetric fossil (A) as a result of strain (B). X is the direction of principal extensive strain, and ψ the angular shearing strain.

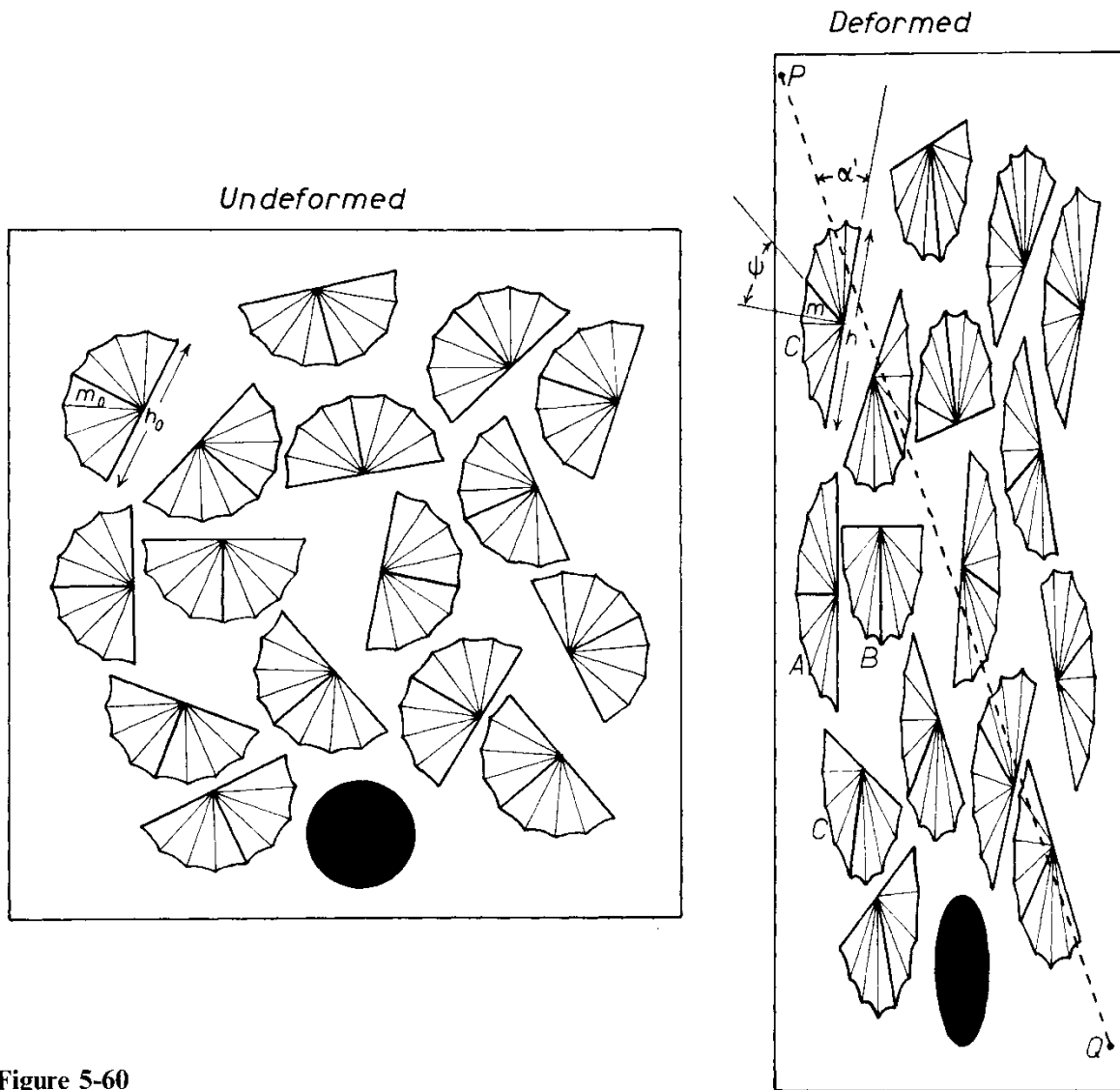
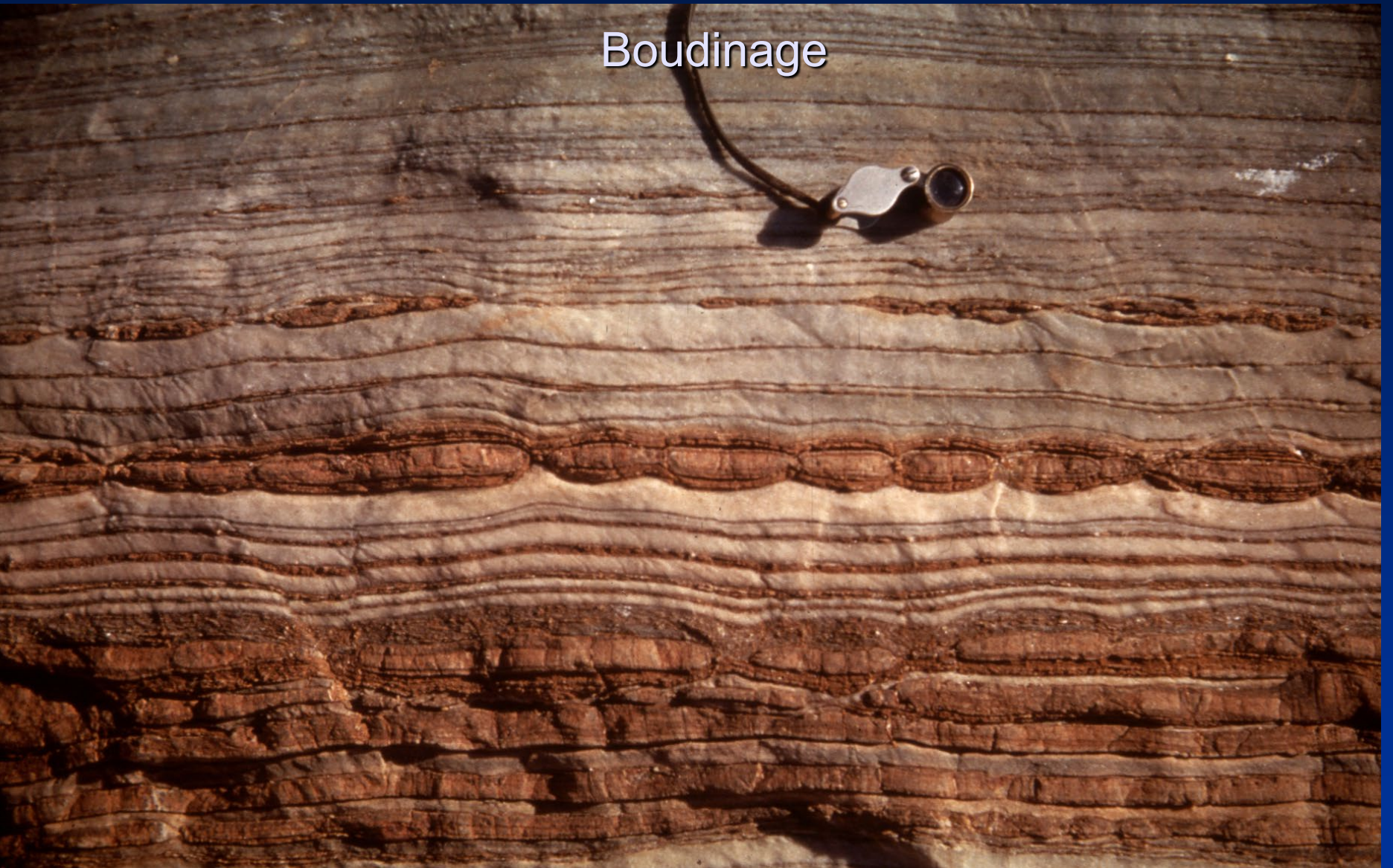

Figure 5-60

The shape changes in an assemblage of equal-sized, bilaterally symmetric fossils as a result of homogeneous strain. A is in the broad form, B the narrow form, and C the oblique form.

Boudinage



Da Ramsay and Huber, 1987



Da Ramsay and Huber, 1987

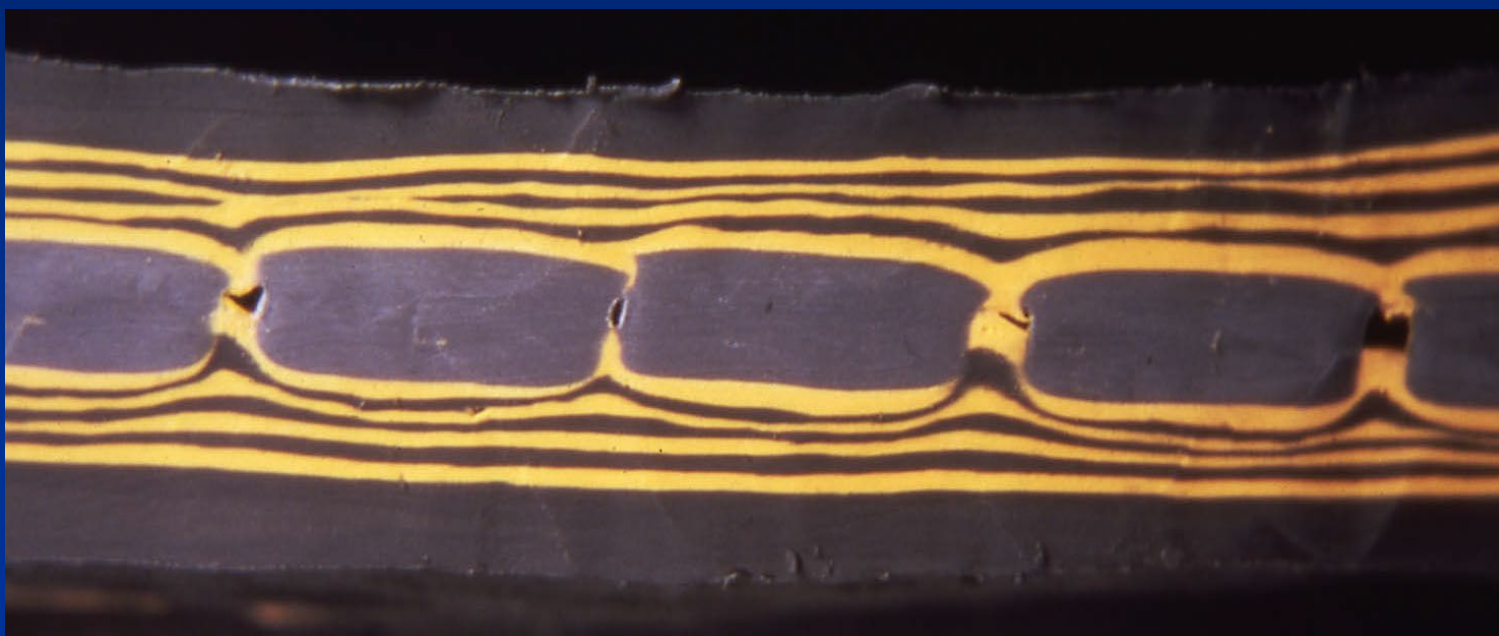

Da Ramsay and Huber, 1987



Da Ramsay and Huber, 1987

Boudinage

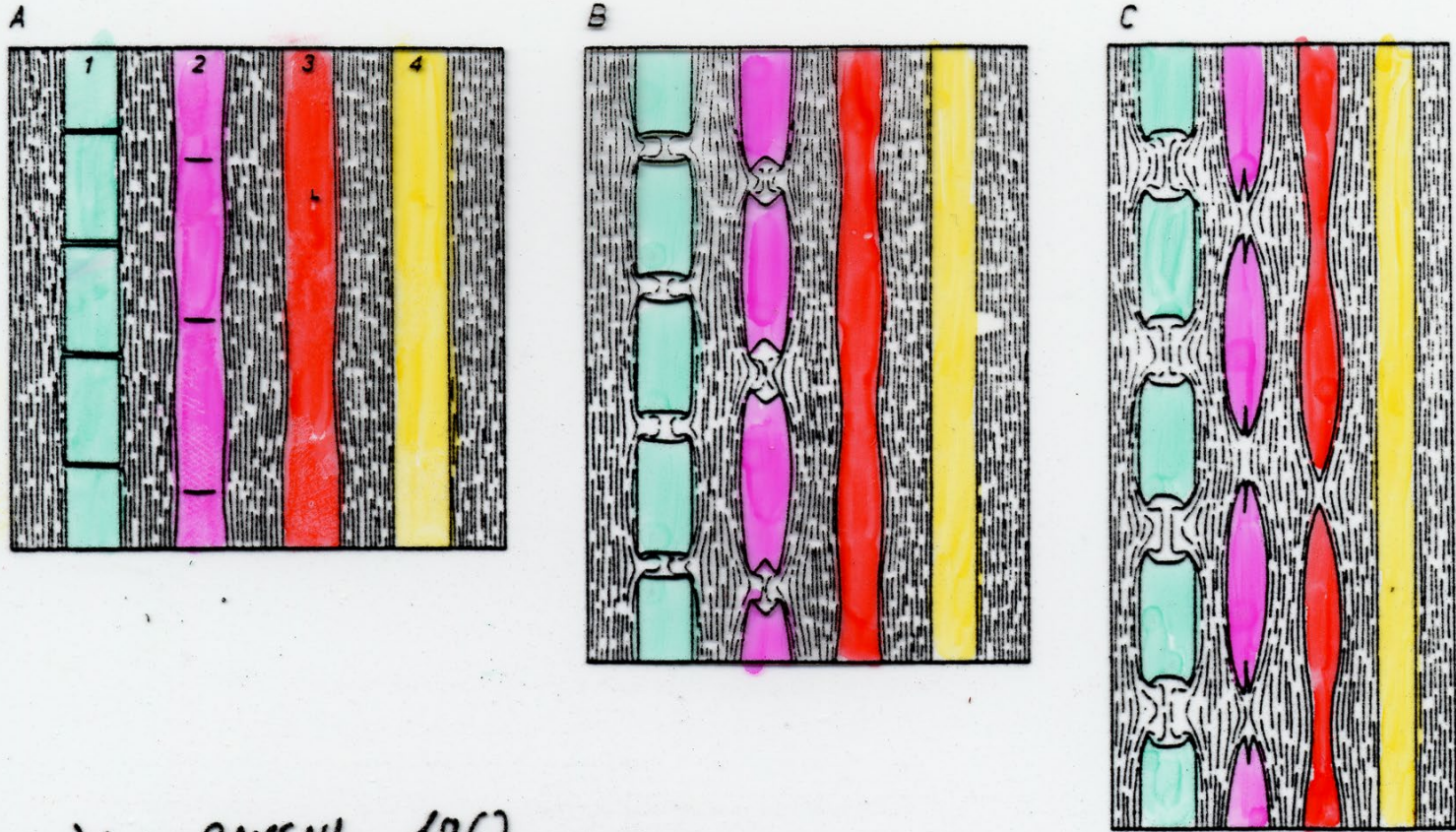

DA RAYSA, 1967



Boudinage asimmetrico

Chocolate boudinage



Fabric, foliazione, lineazione

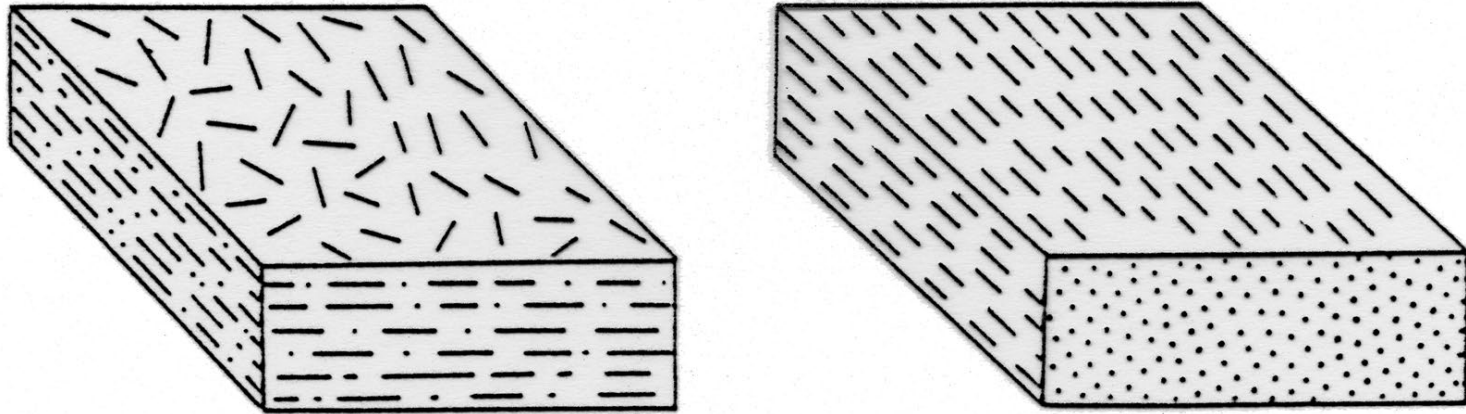

Schematic block diagrams to illustrate the difference between S-tectonites (a) with a pronounced foliation (planar texture), and L-tectonites (b) with a pronounced lineation (linear texture). Metamorphic rocks such as schists and mylonites are generally L-S-tectonites, and have both a linear and planar component.

Da Barker, 1990

Fabric, foliazione

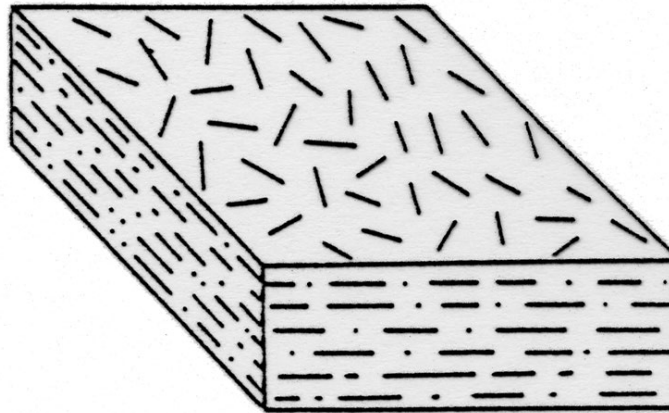

Schematic block diagrams to illustrate pronounced foliation (planar texture), and L-texture (linear and planar texture). Metamorphic rocks such as schists and gneisses exhibit both a linear and planar component.

Da Barker, 1990

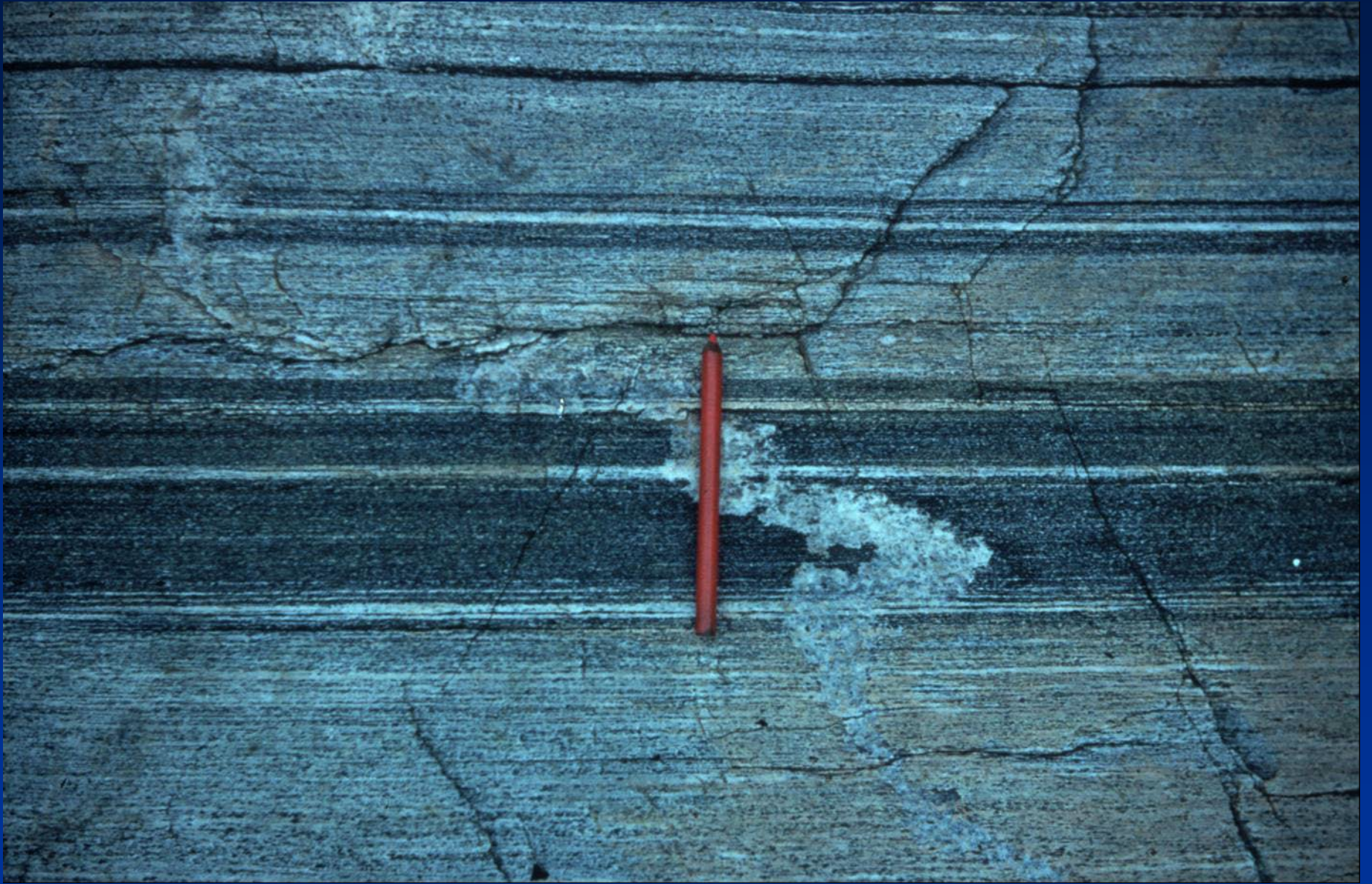

Da Ramsay & Huber, 1987

GA Pini



GA Pini

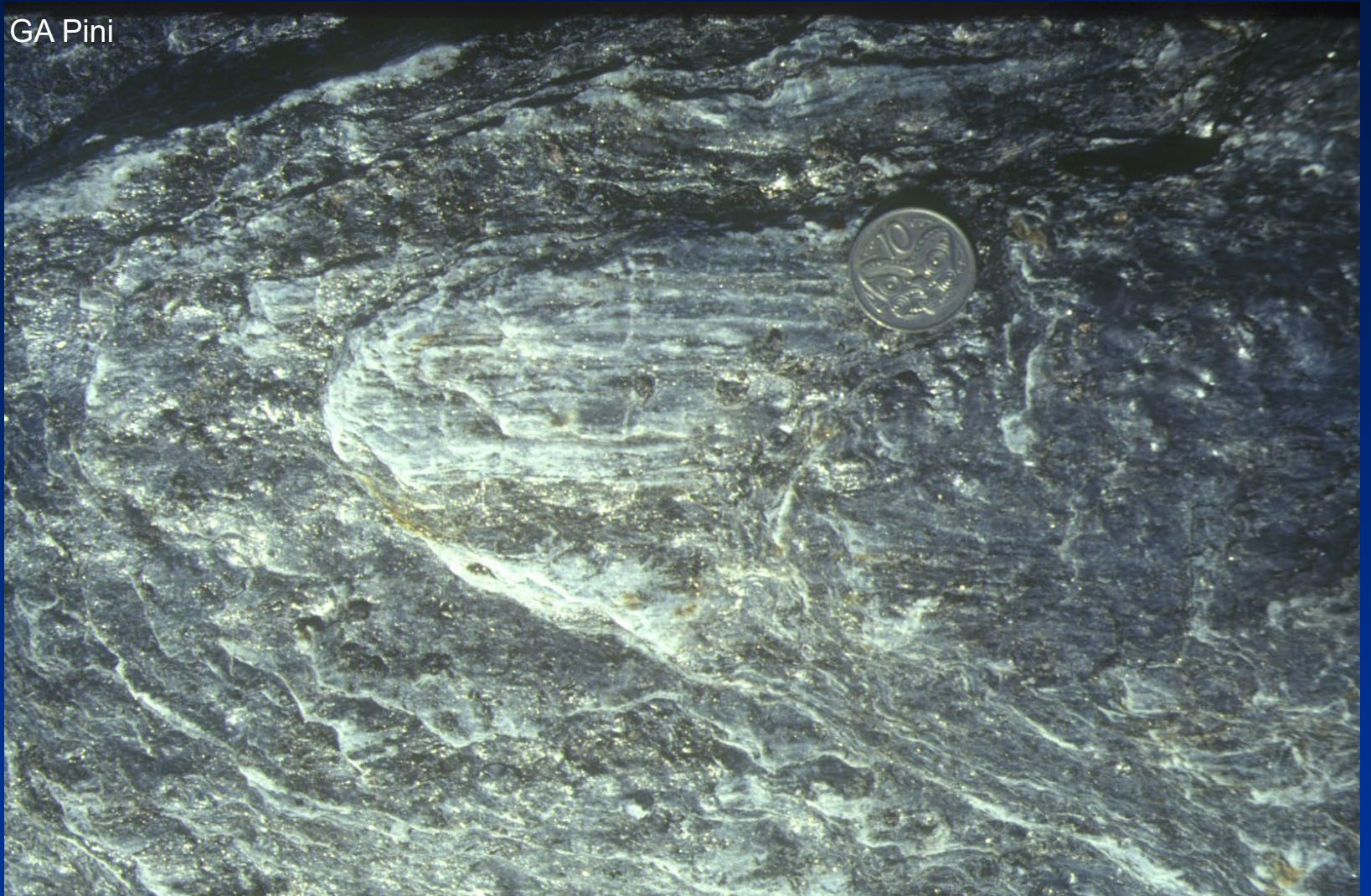



Da Ramsay & Huber, 1984



Da Ramsay and Huber, 1984

Slaty cleavage

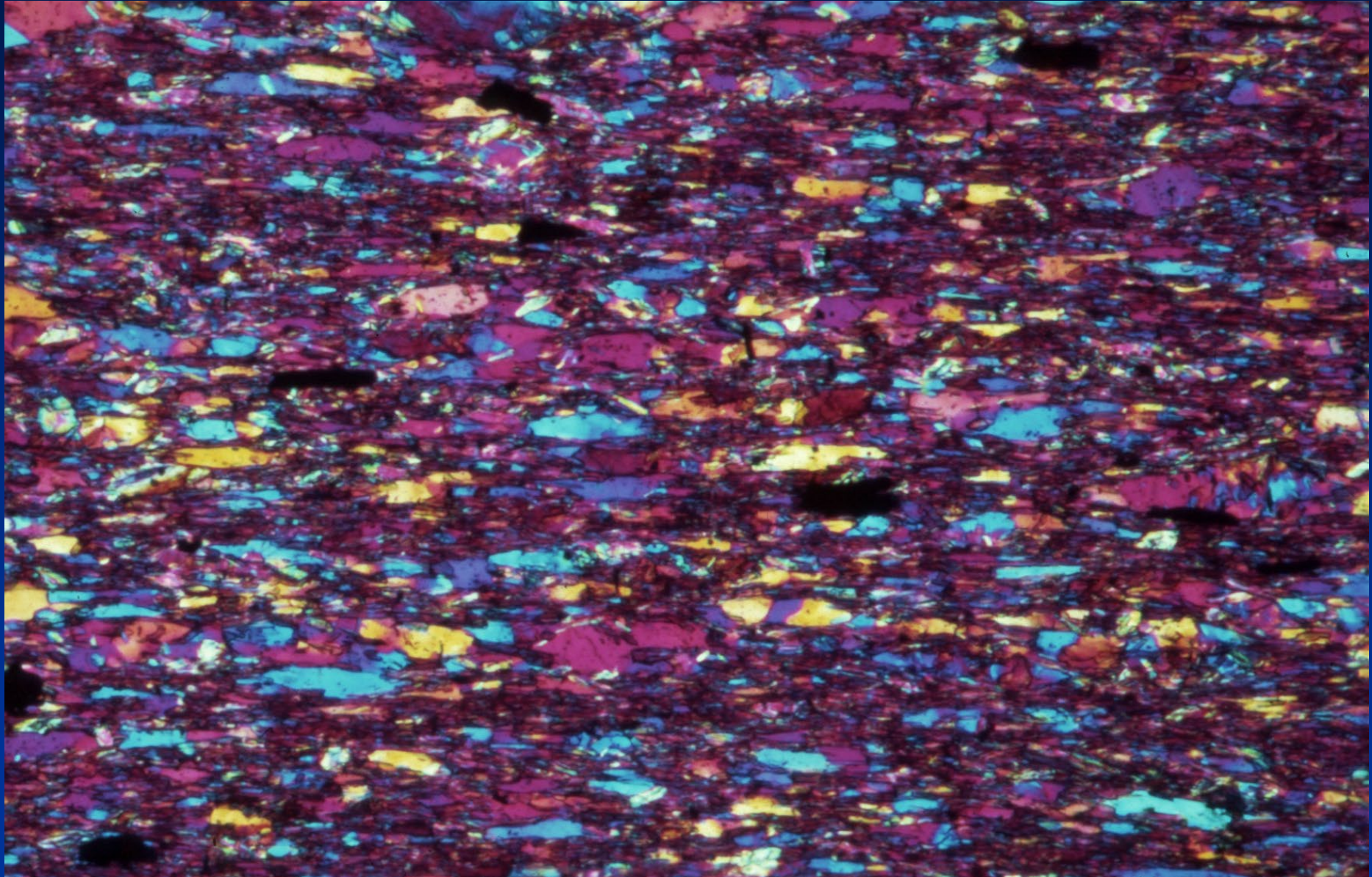

Gneis foliation (o scistosità)

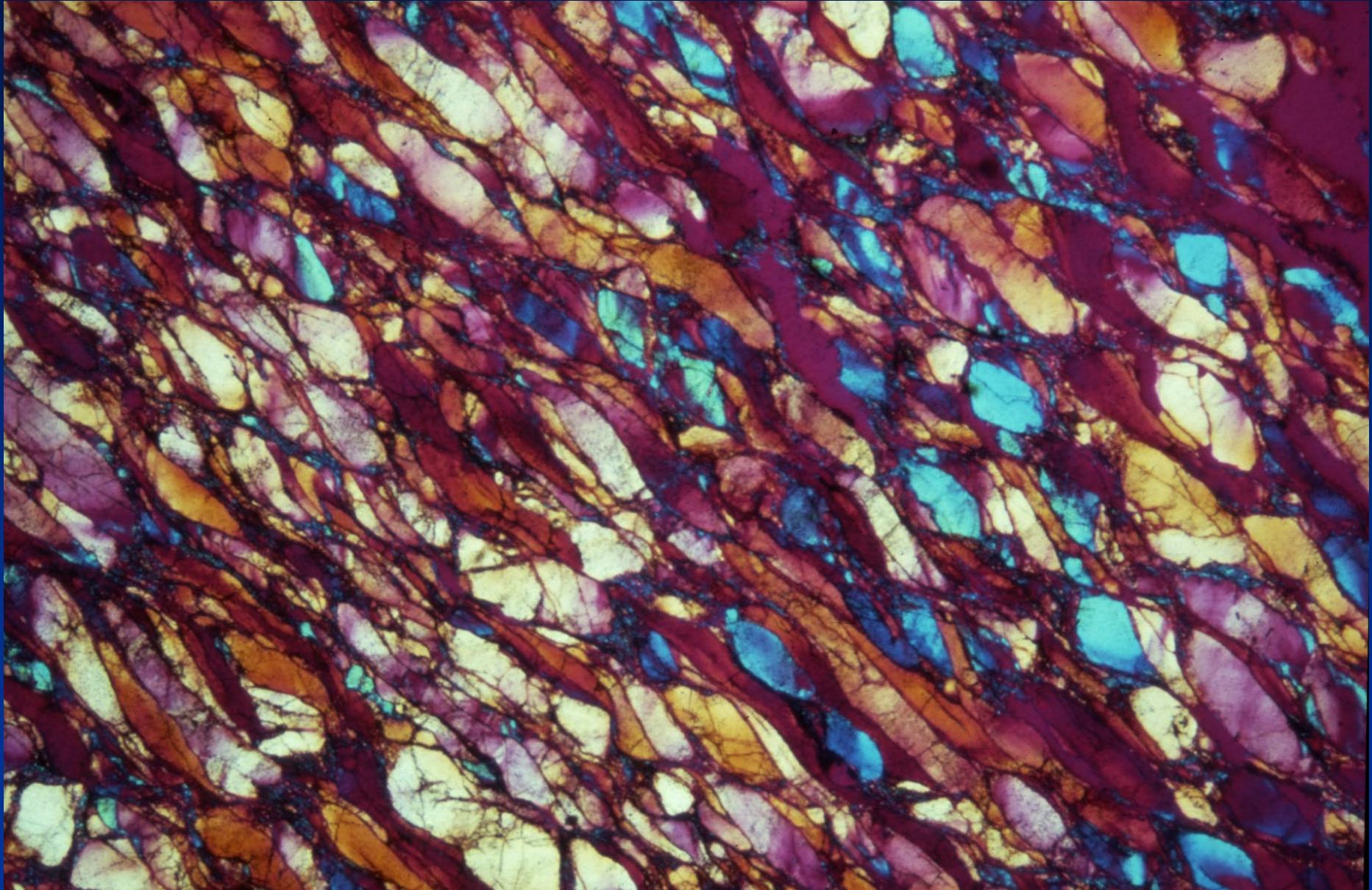

Fabric, lineazione

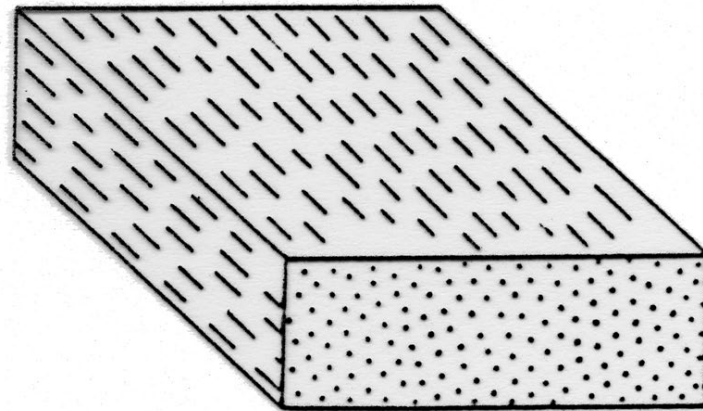

strate the difference between S-tectonites (a) with a
-tectonites (b) with a pronounced lineation (linear
nd mylonites are generally L-S-tectonites, and have

Lineazioni



Foliazione+lineazione (S-L)

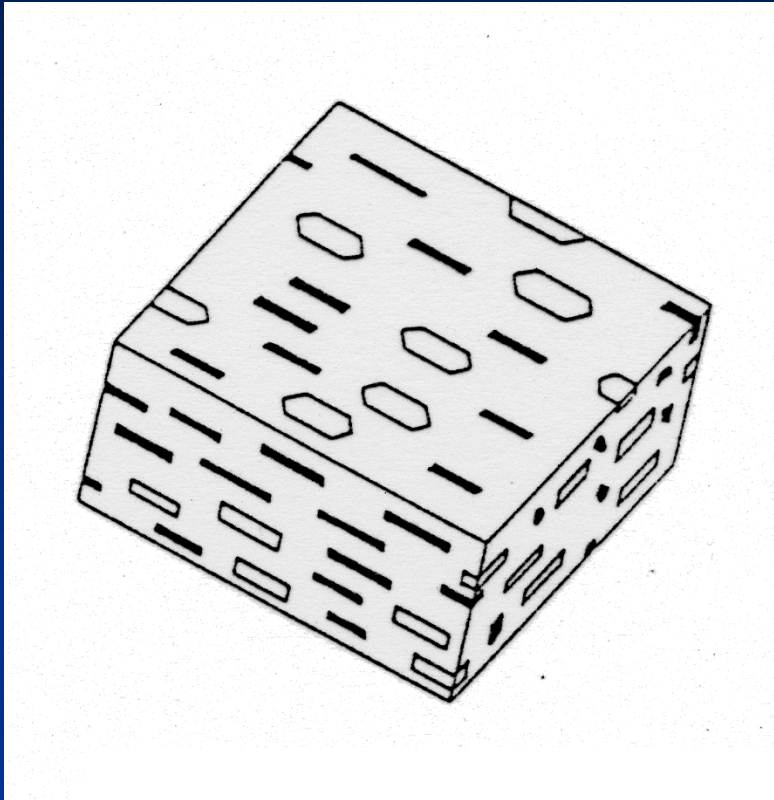

Da Nicolas, 1984

GA Pini



GA Pini

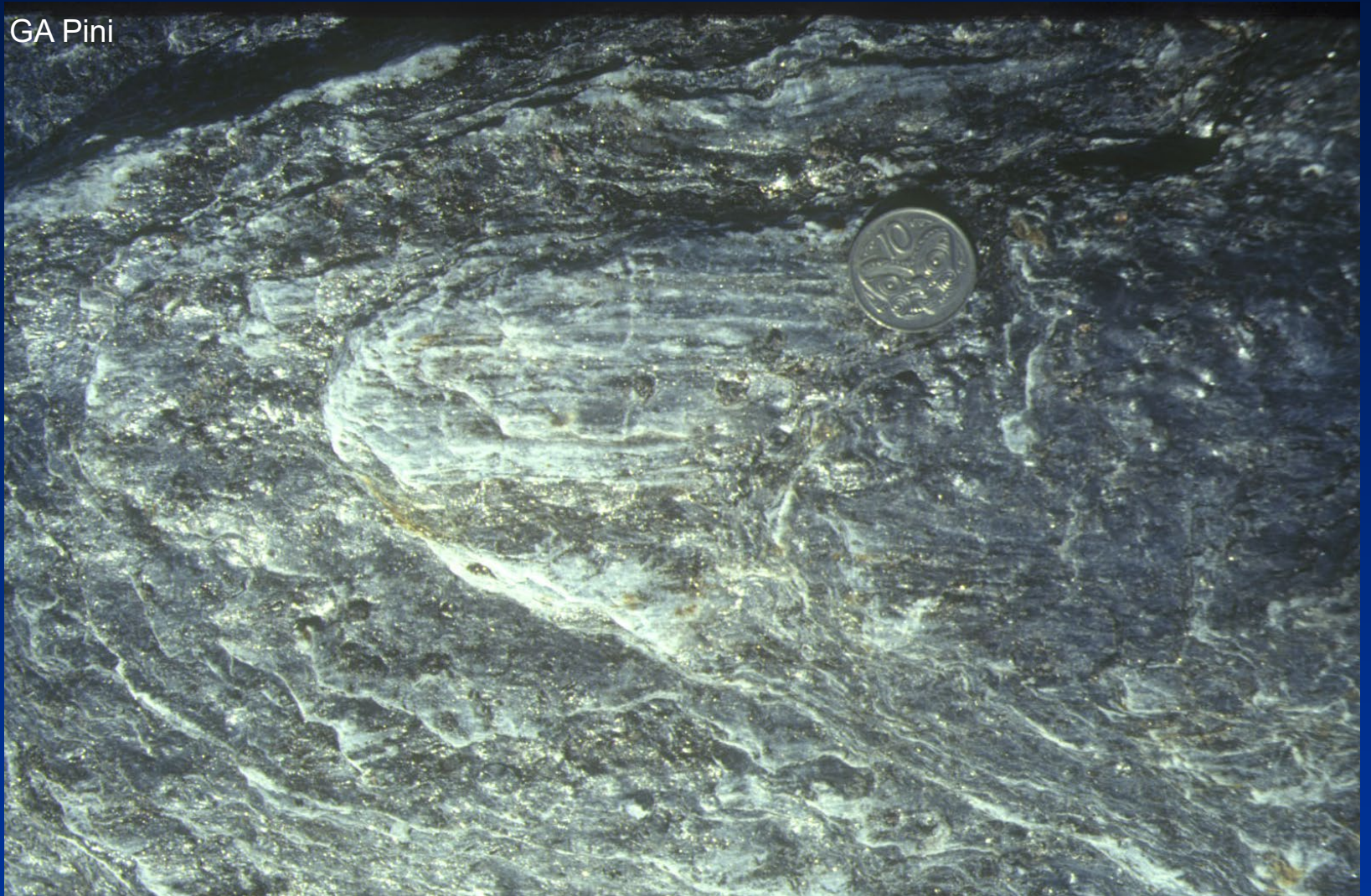

Strutture da deformazione disomogenea

GA Pini

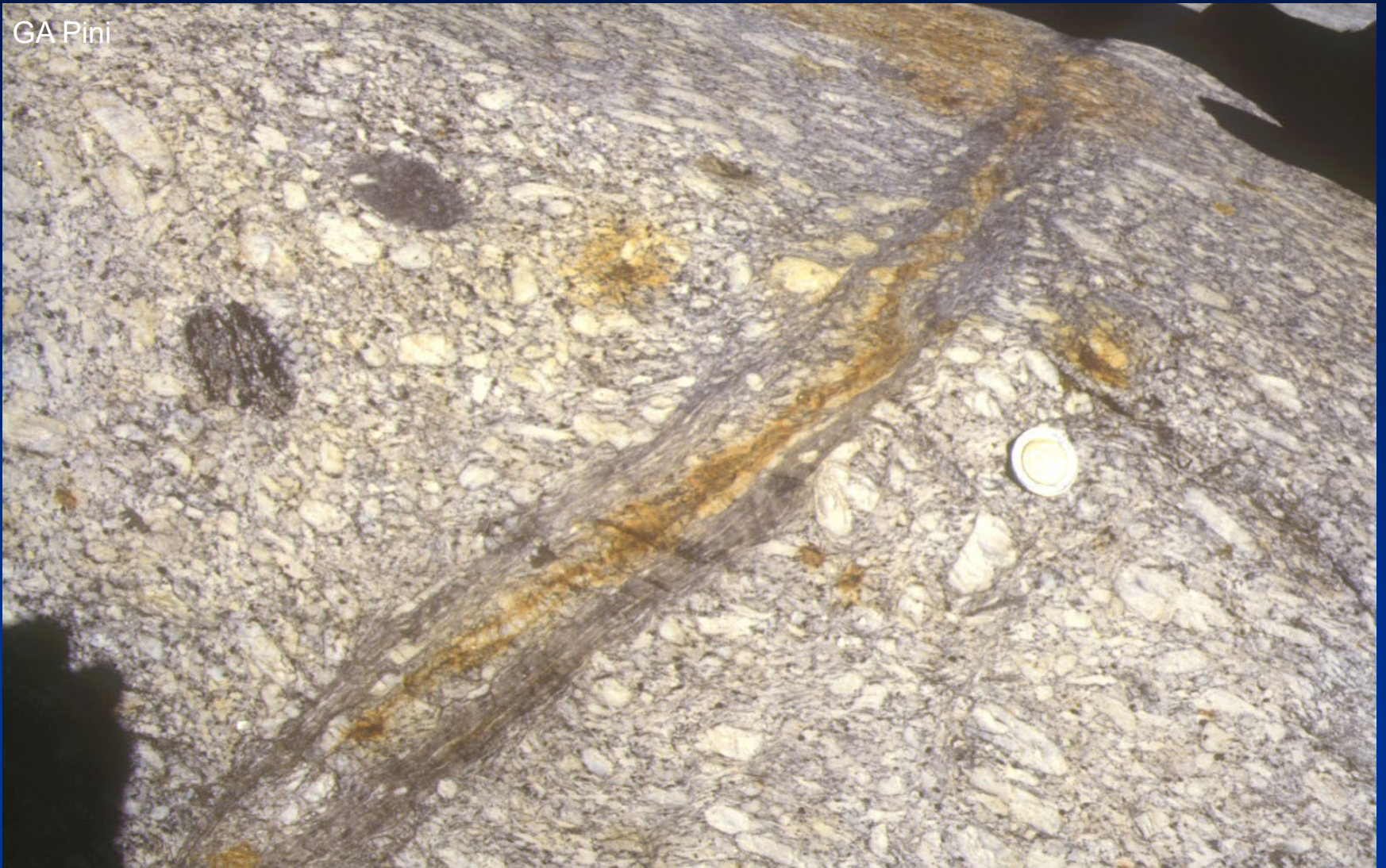

GA Pini

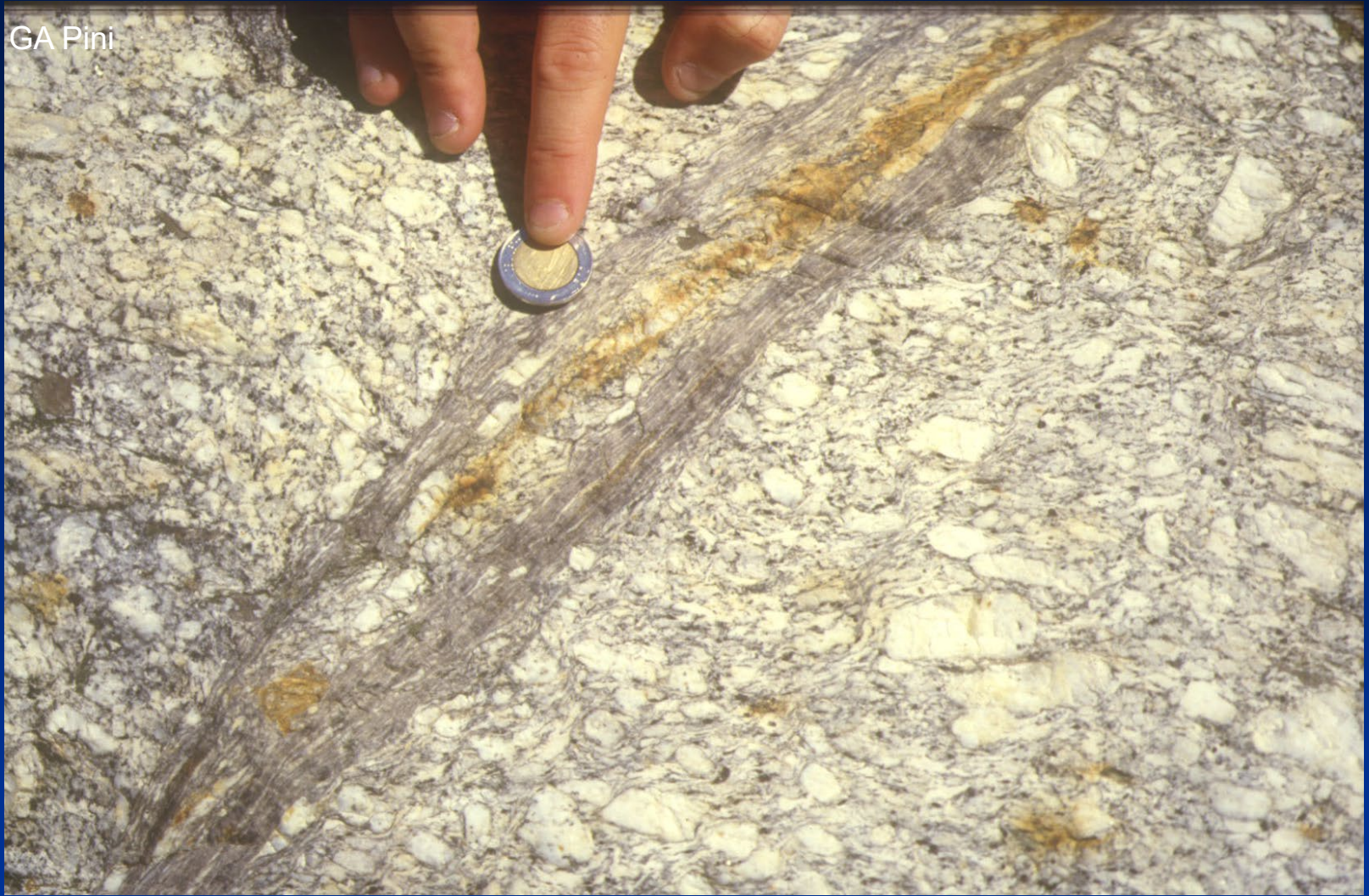

GA Pini

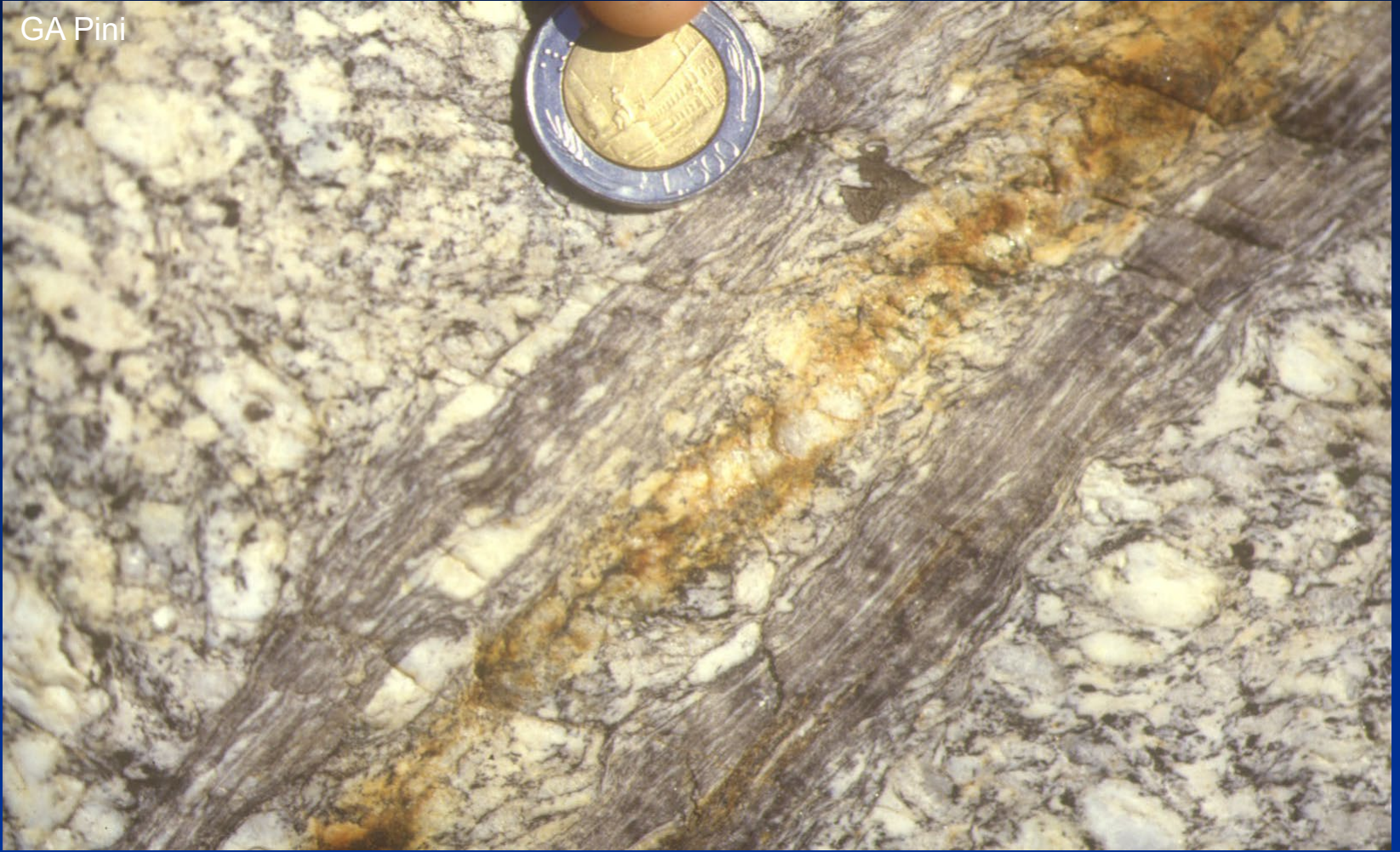

Strutture da deformazione disomogenea

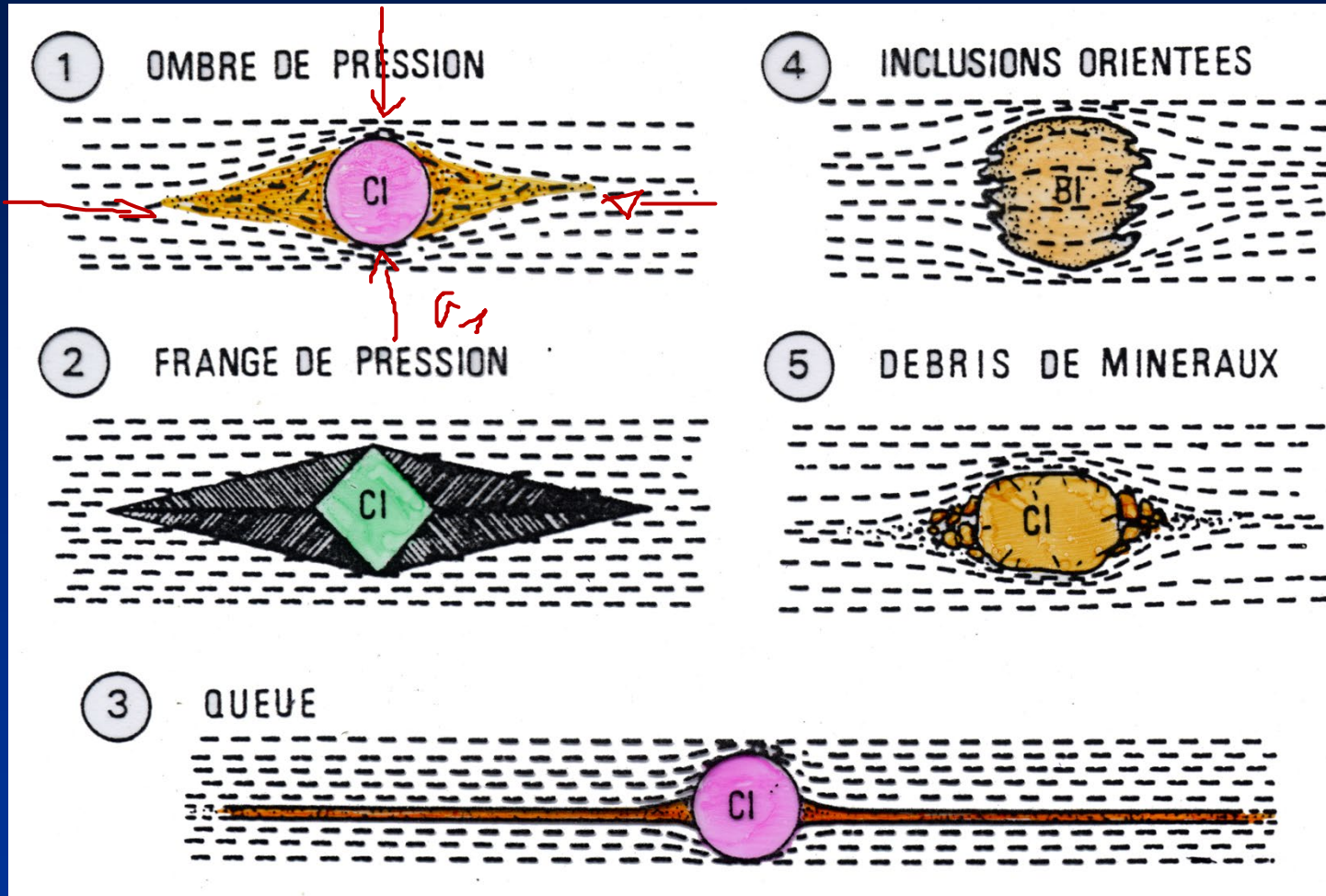

Da Mercier & Vergely, 1995

GA Pini

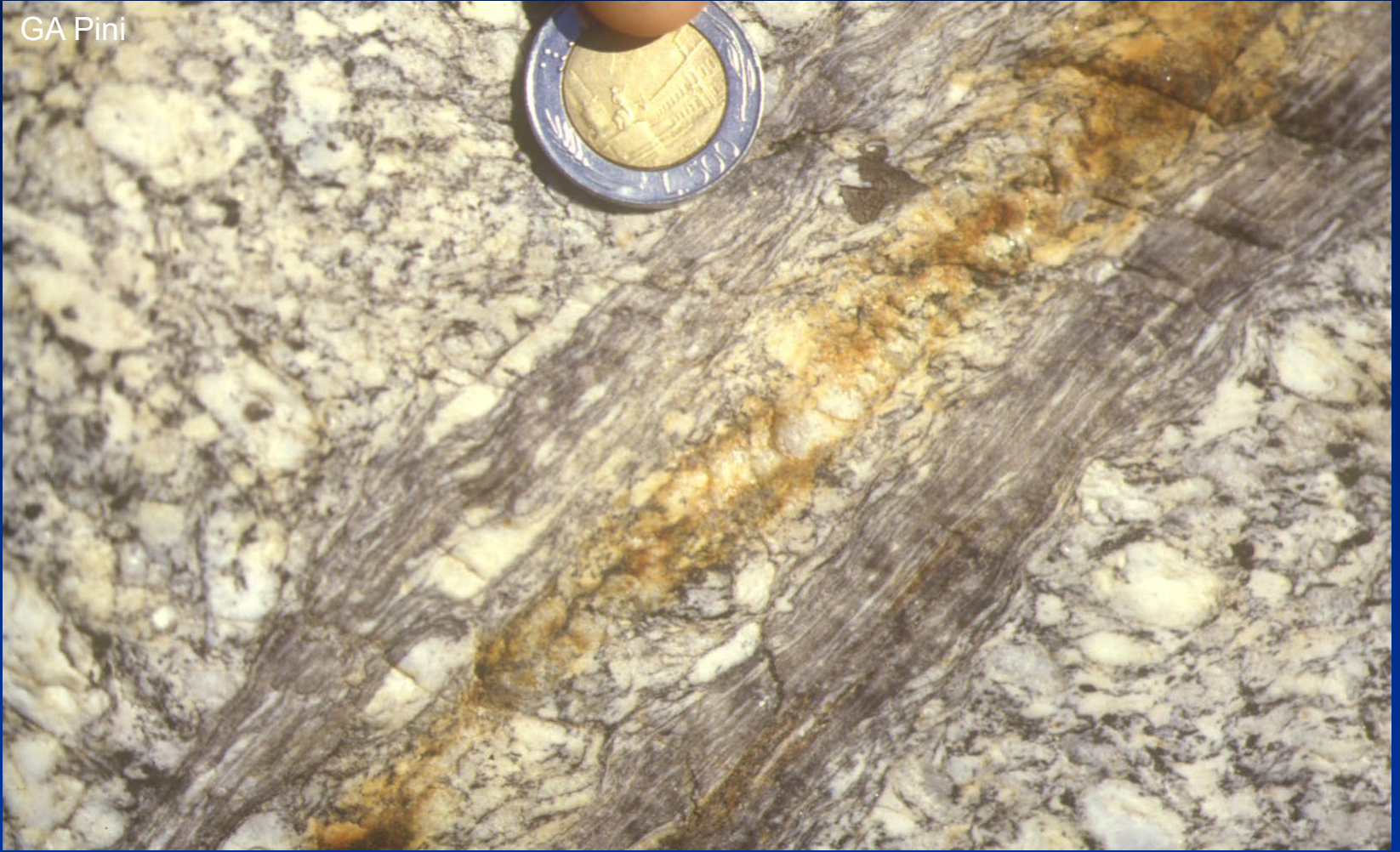



Figura 7.20. Relazioni tra simmetria delle strutture e modalità deformativa.



Passchier & Trouw, 2006

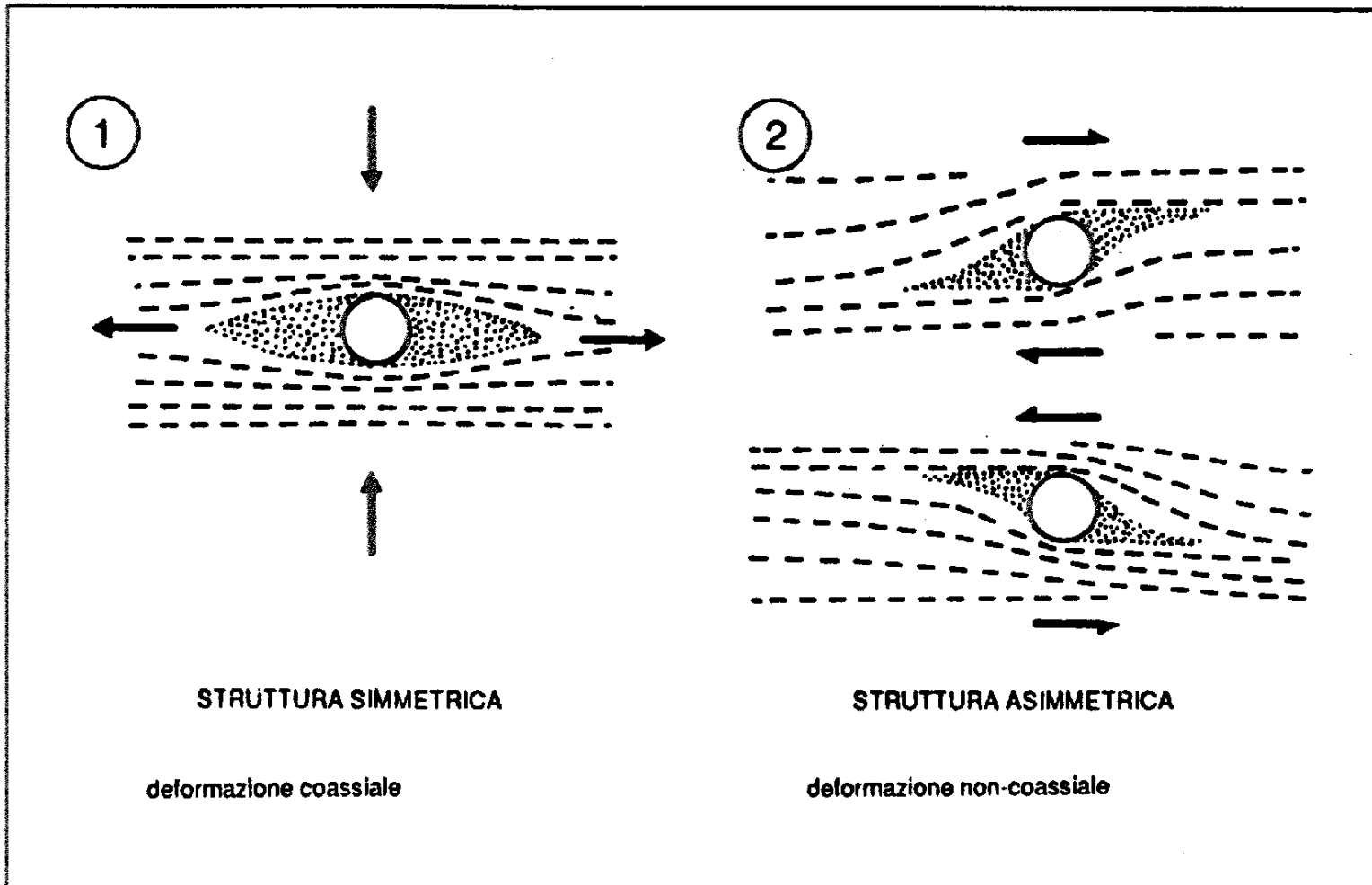
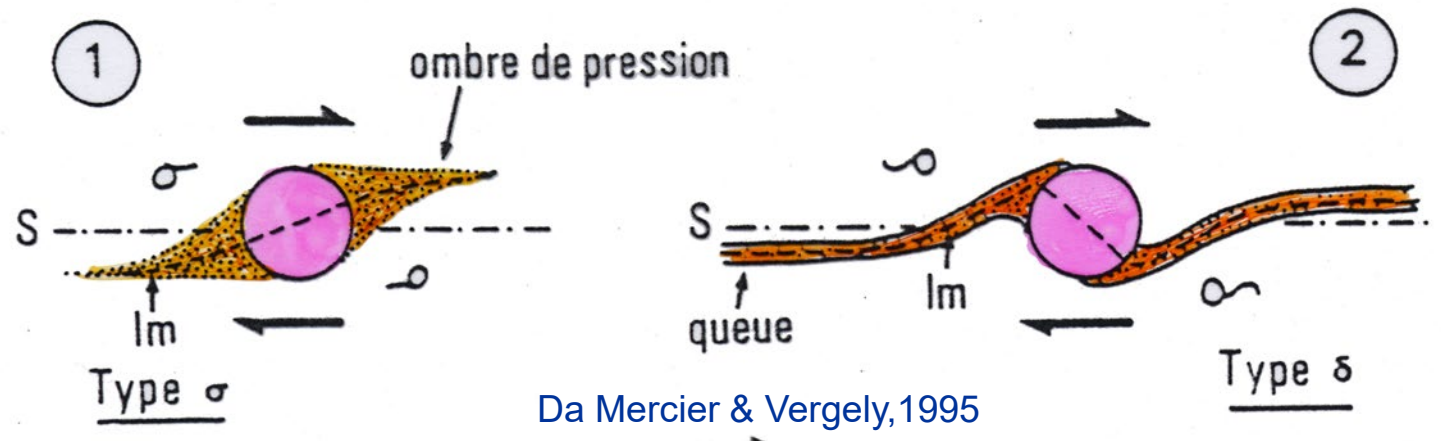
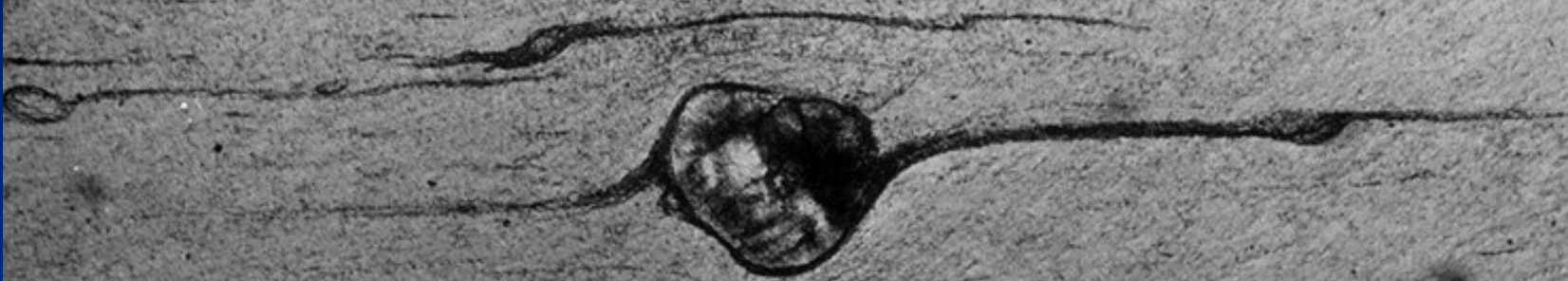

Da Mercier & Vergely, 1995

2

FRANGE DE PRESSION

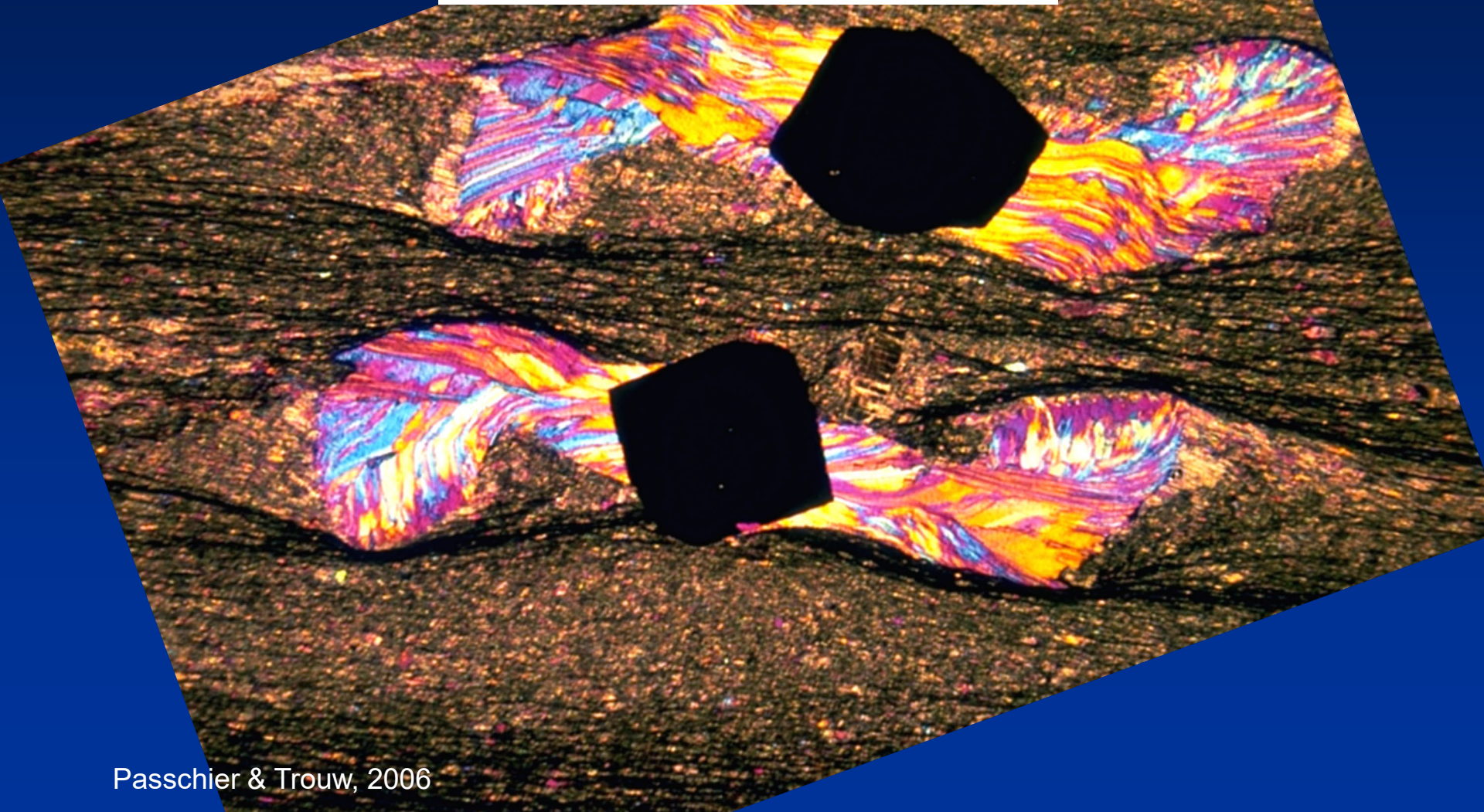

Fabric “snowball” a “S” nei porfiroclasti

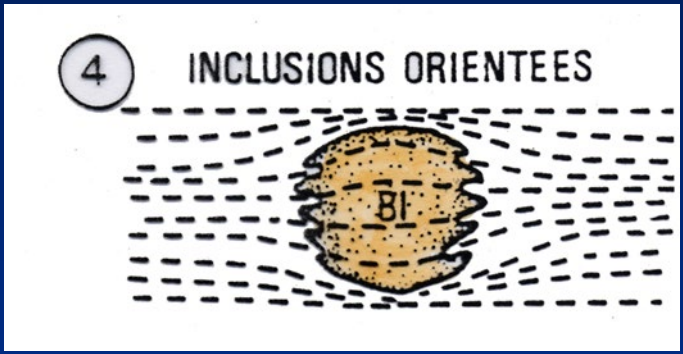

Da Mercier & Vergely, 1995

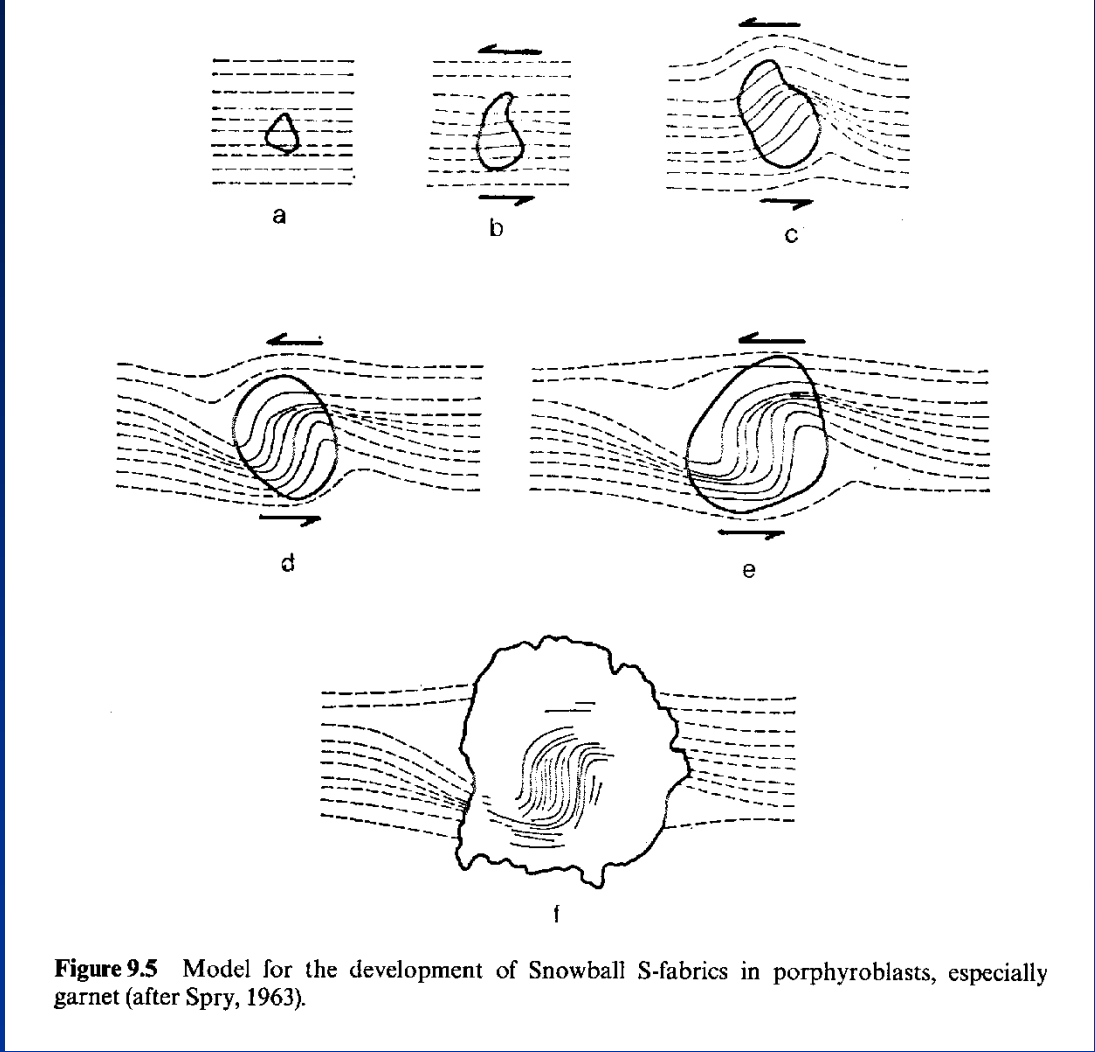
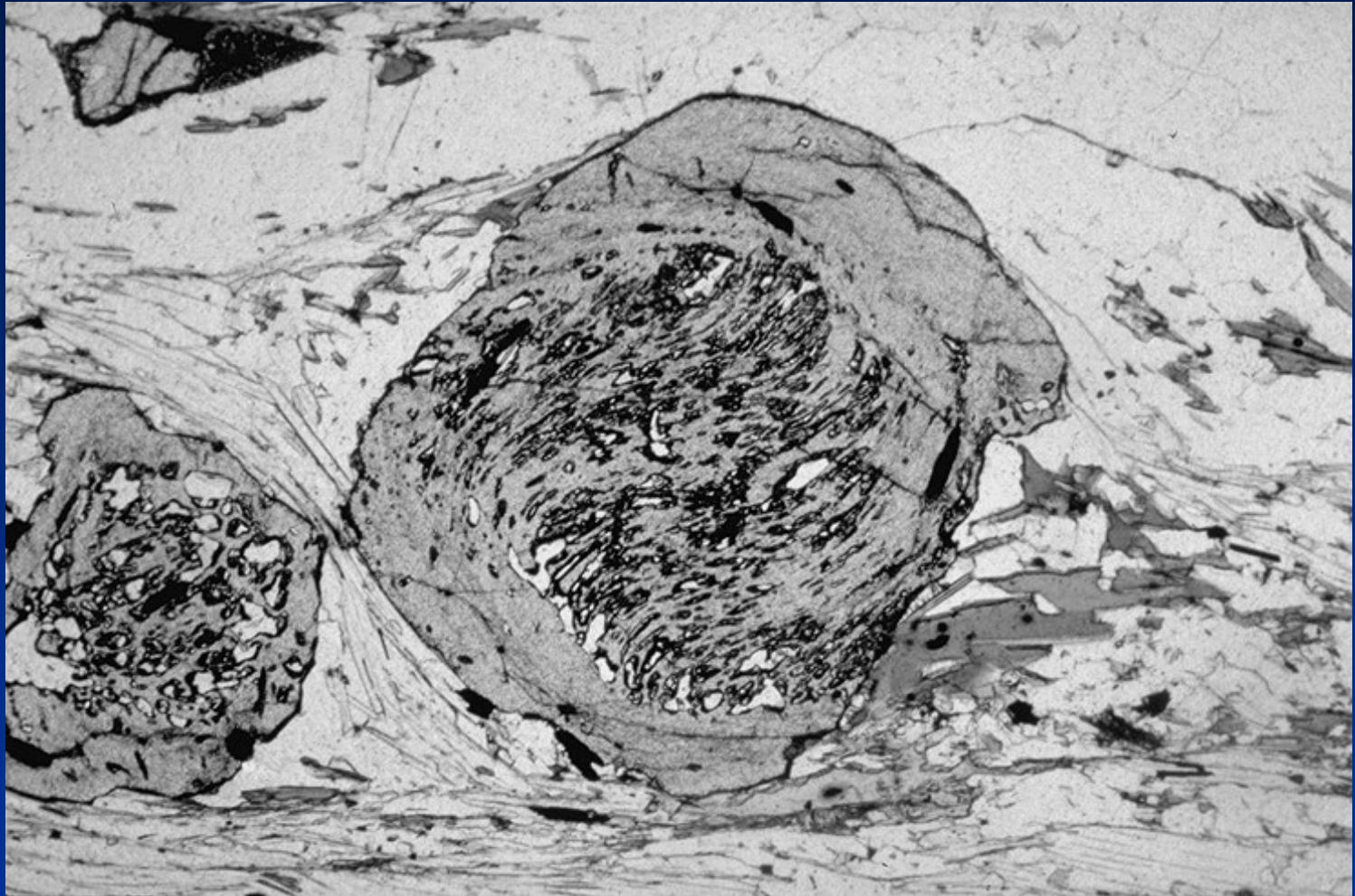
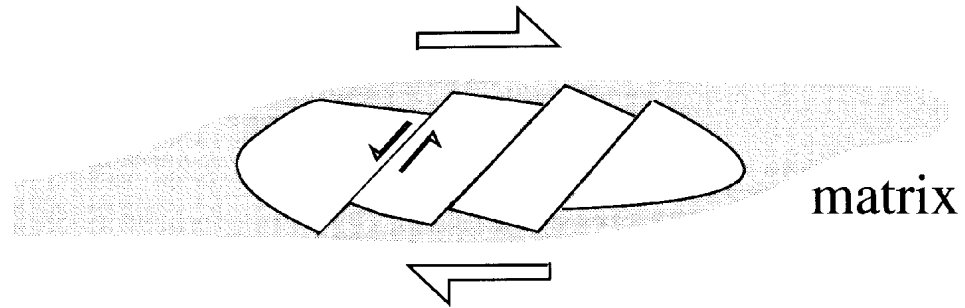

Figure 9.5 Model for the development of Snowball S-fabrics in porphyroblasts, especially garnet (after Spry, 1963).



Passchier & Trouw, 2006

antithetic microfaults or shear zones in grains



synthetic microfaults or shear zones in grains

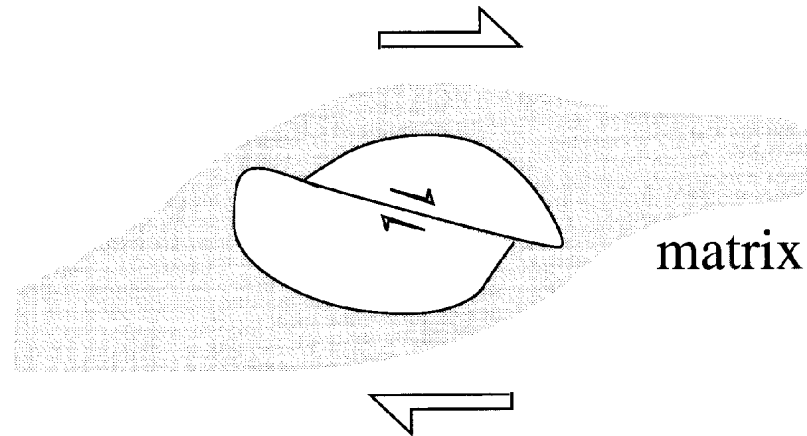
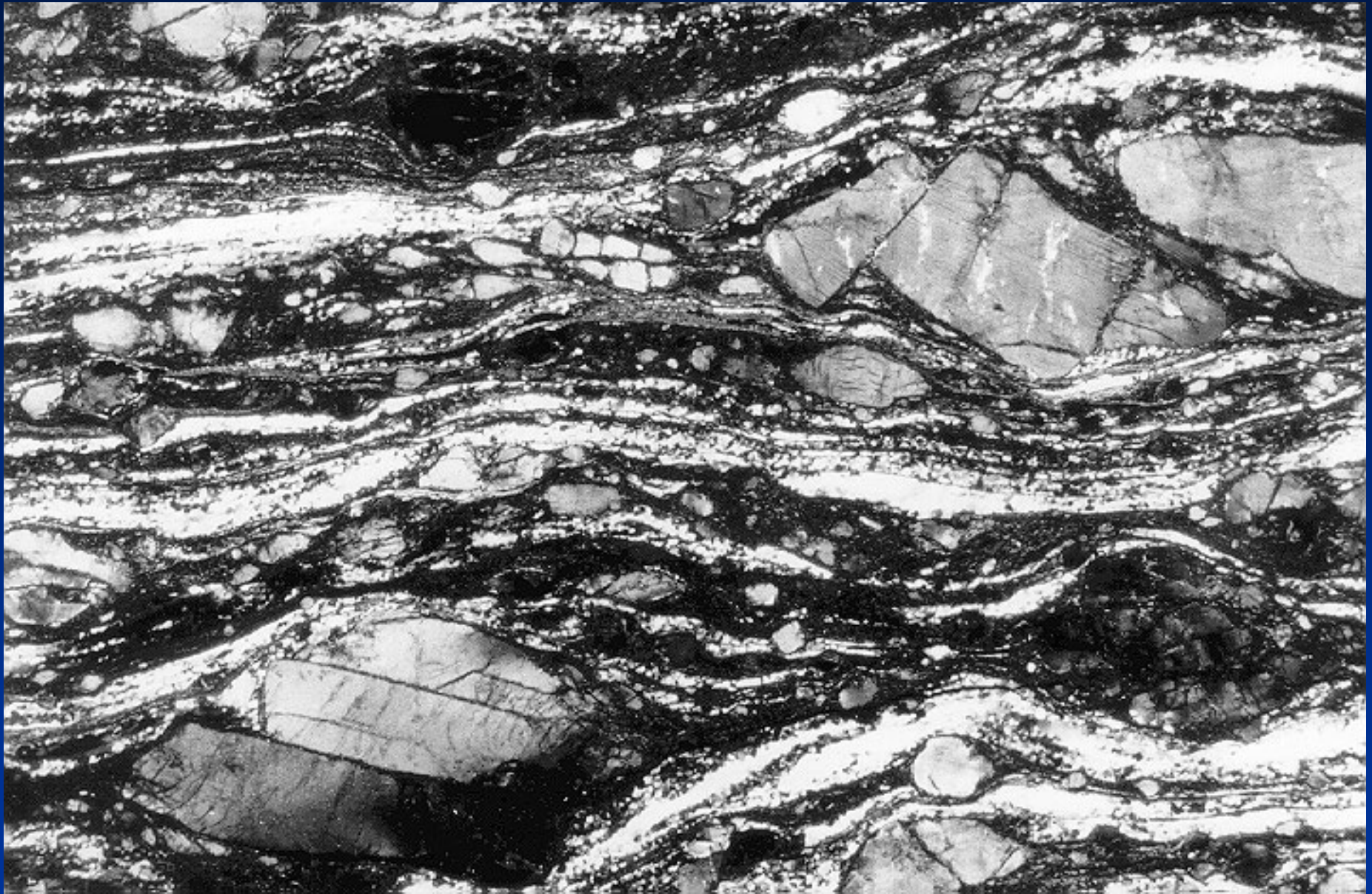
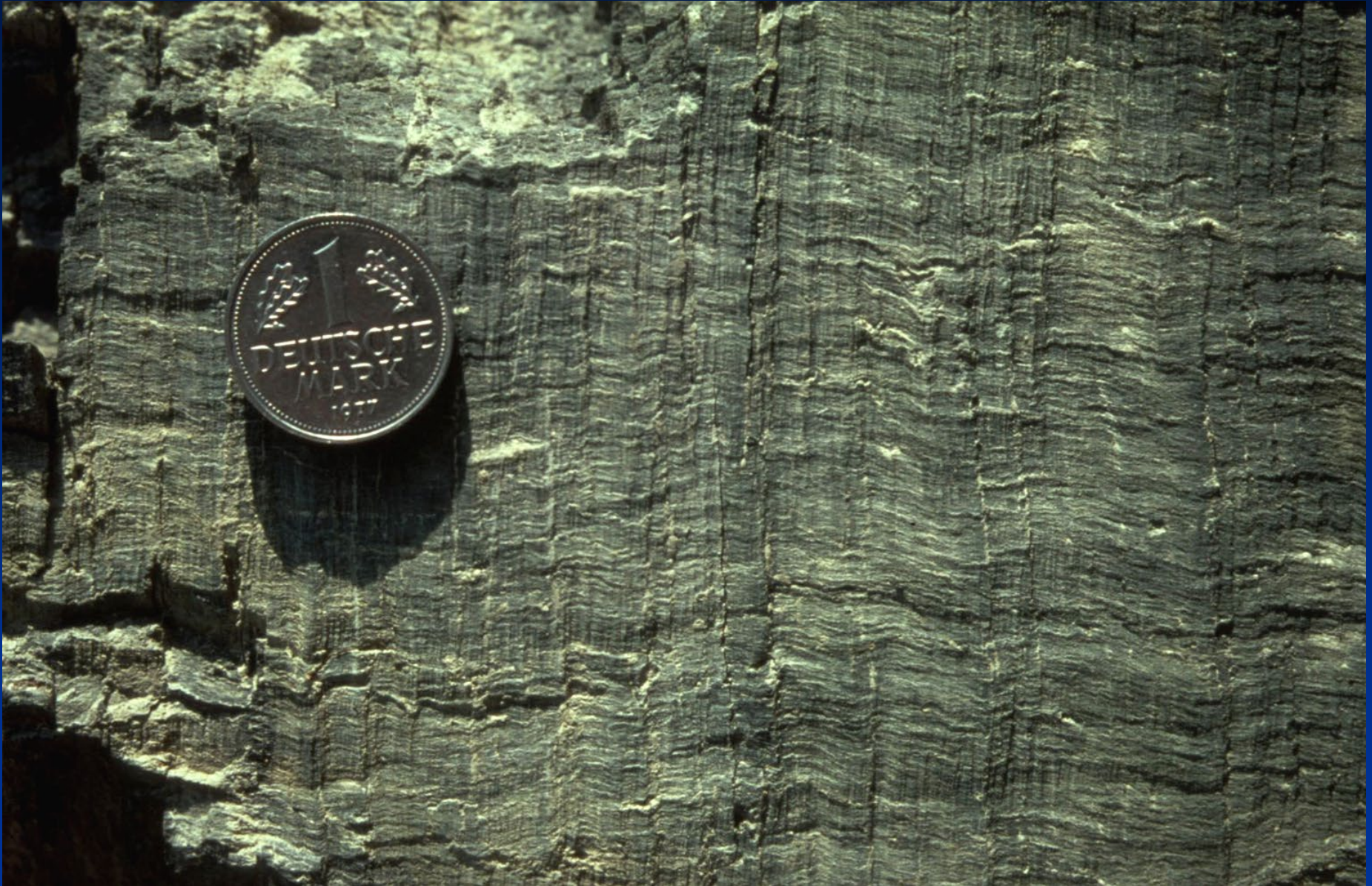

Fig. 5.31. Illustration of the two mechanisms of formation of stepped fragmented grains at similar bulk shear sense (*large arrows*)



Passchier & Trouw, 2006

Clivaggio da crenulazione



Da Ramsay and Huber, 1987



Da Ramsay and Huber, 1987

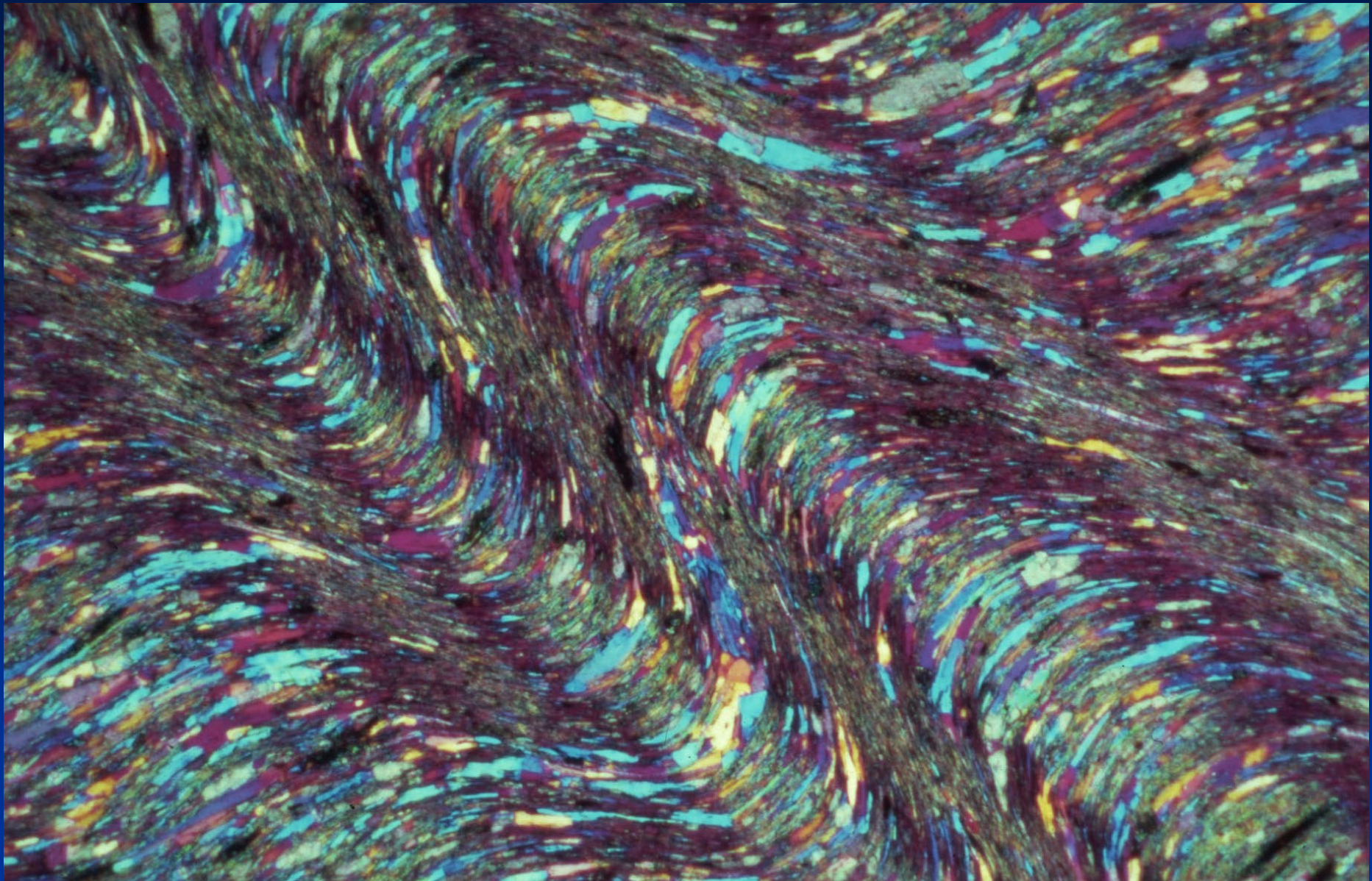

Da Ramsay and Huber, 1987



Passchier & Trouw, 2006

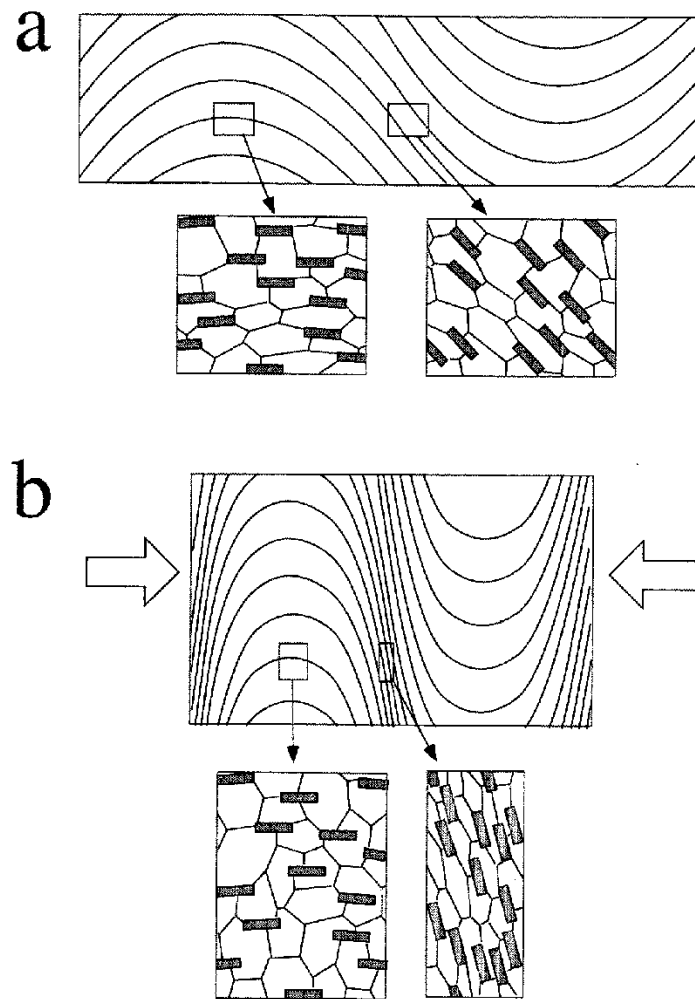
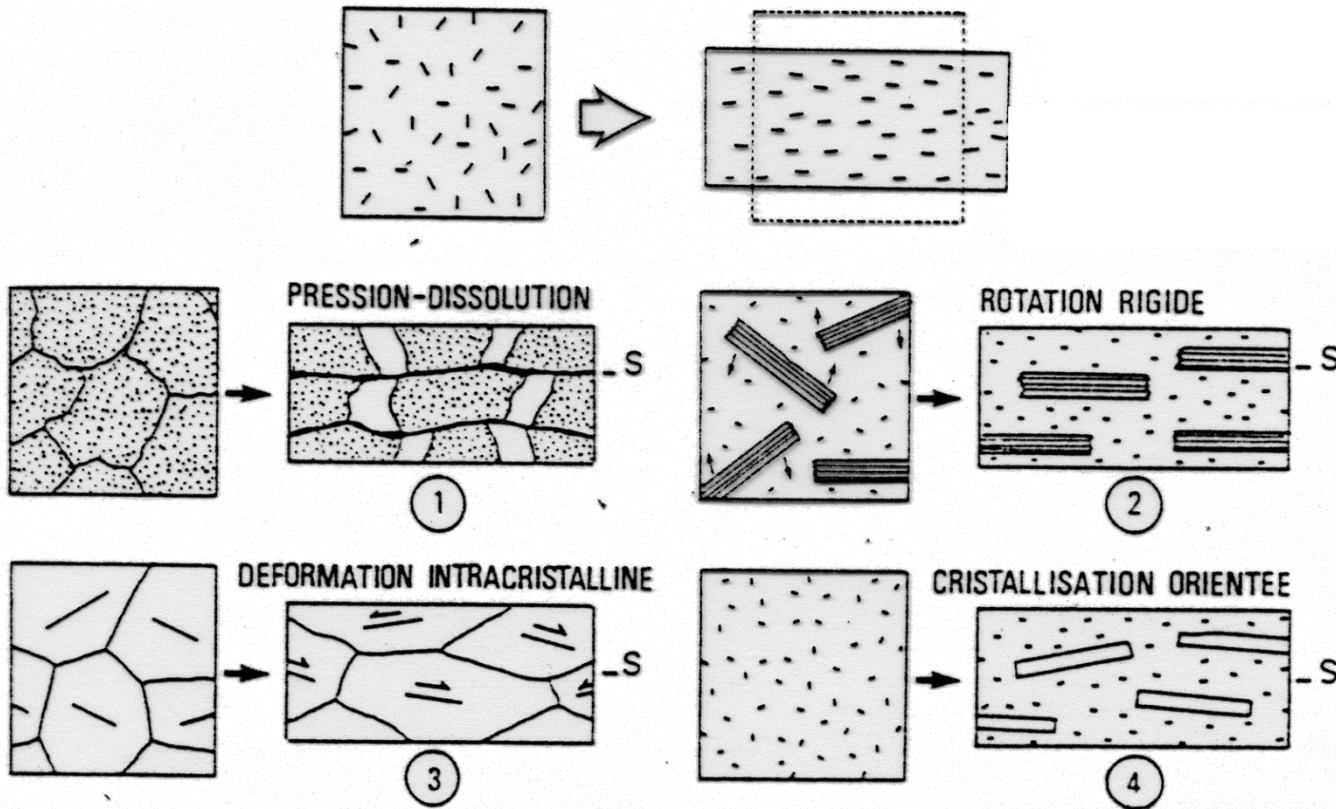
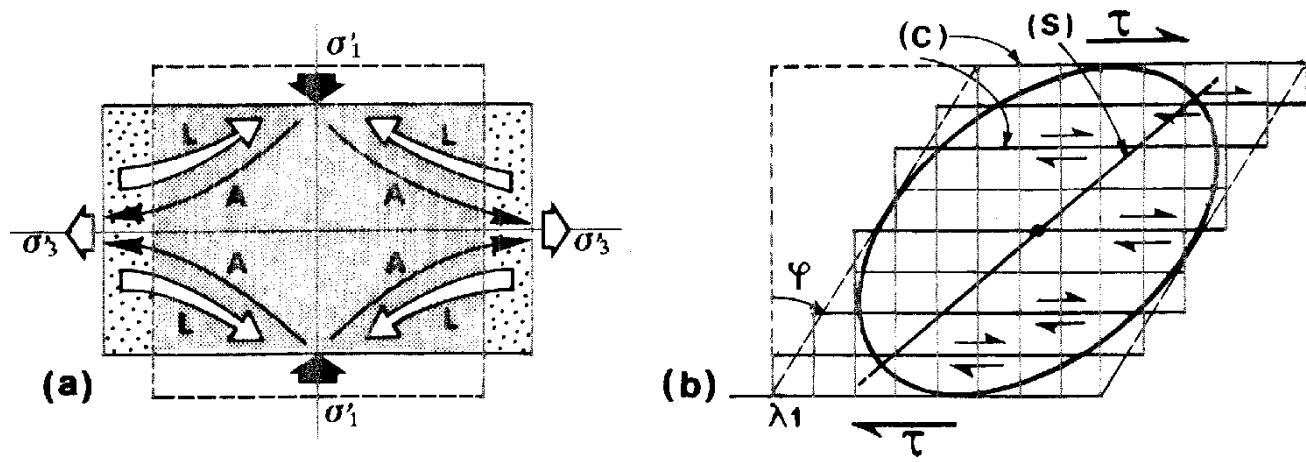

Fig. 4.21a,b. Progressive tightening of folds with formation of a differentiated crenulation cleavage (S_2) by preferential dissolution of quartz in fold limbs caused by the orientation of quartz-mica contacts with respect to the σ_1 direction; resolved normal stress over these contacts is higher in fold limbs than in hinges. **a** and **b** are two stages in progressive deformation (cf. Figs. 4.11, 4.12)

Genesi della foliazione





7.2. (a) Déformation coaxiale d'un cristal par diffusion des atomes (A) et des lacunes (L) ;
(b) Déformation non co-axiale d'un cristal par glissement sur une seule famille de plans cristallographiques.

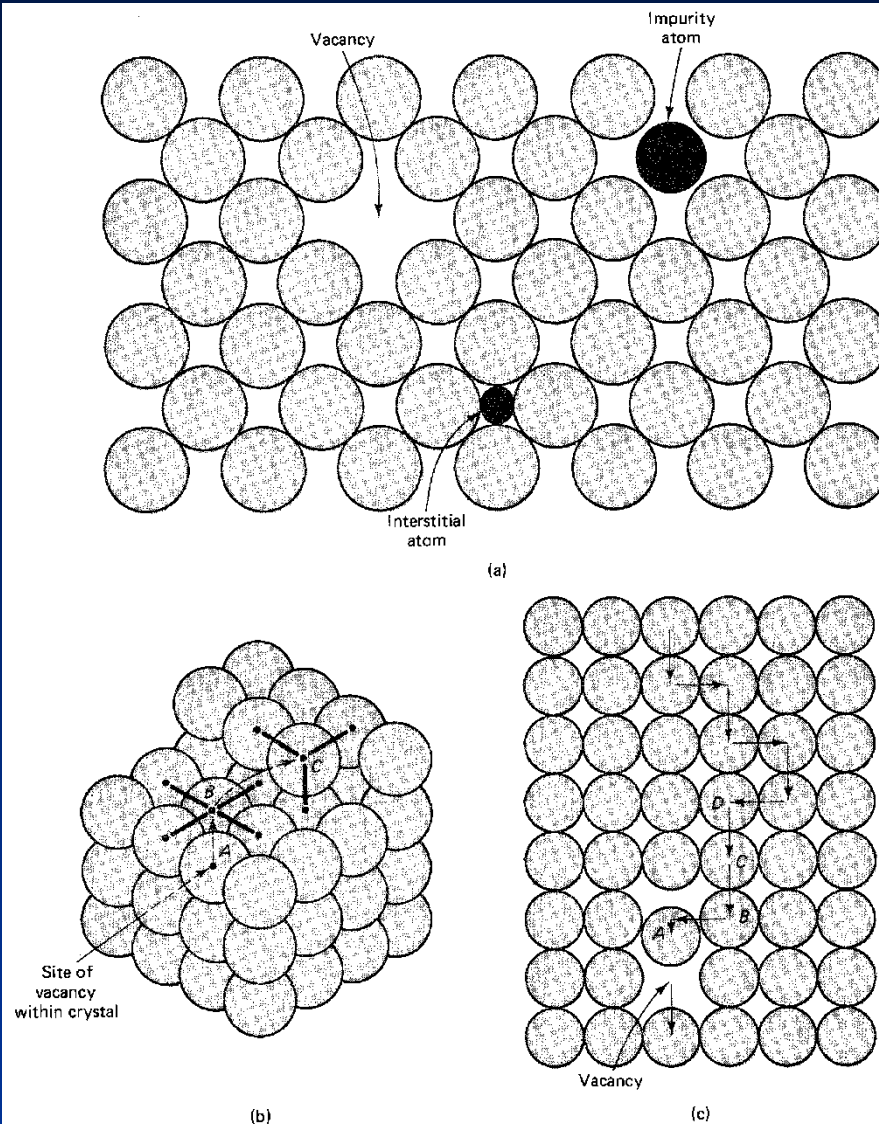
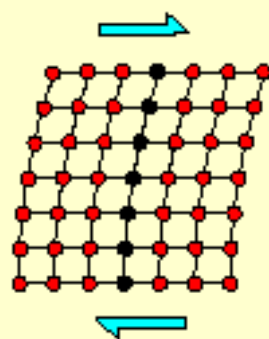
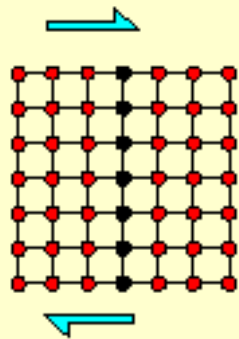
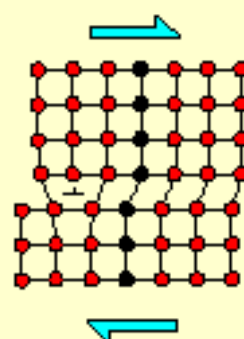

FIGURE 4-5 (a) Simple kinds of point defects. (b) Creation of a vacancy at *A*, one layer below the surface of the crystal, requires breaking five bonds of the atom at *B*, moving it to *C* on the surface of the crystal and forming three bonds, breaking five bonds of the atom at *A*, and moving it to *B*, forming four bonds. Thus the energy required to form the vacancy is the energy of the net three bonds broken. (c) Vacancies play an important role in solid-state diffusion. For example, atom *A* is moving into an adjacent vacancy, atom *B* may then move into the hole left by *A*, atom *C* may then move into the hole left by *B*, and so on, producing a flux of one atom downward across the crystal and one vacancy upward across the crystal.



elastic
deformation



introduction
of
dislocation

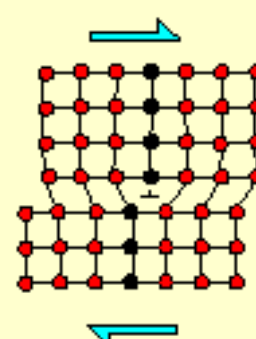

migration
of
dislocation

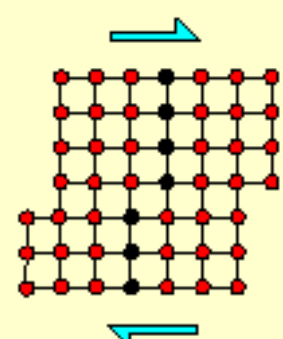

crystal shape has changed
without mechanical
fracturing or loss of crystal
structure

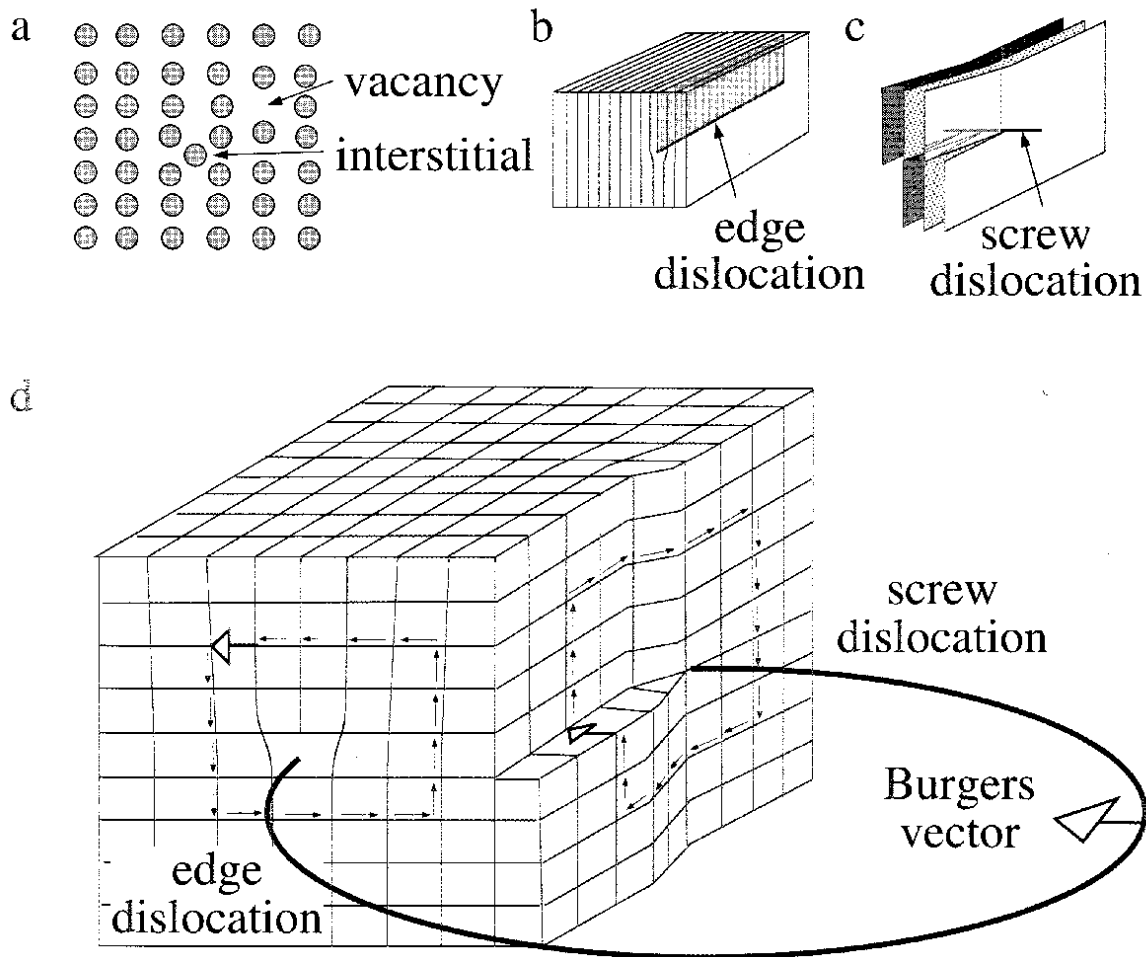
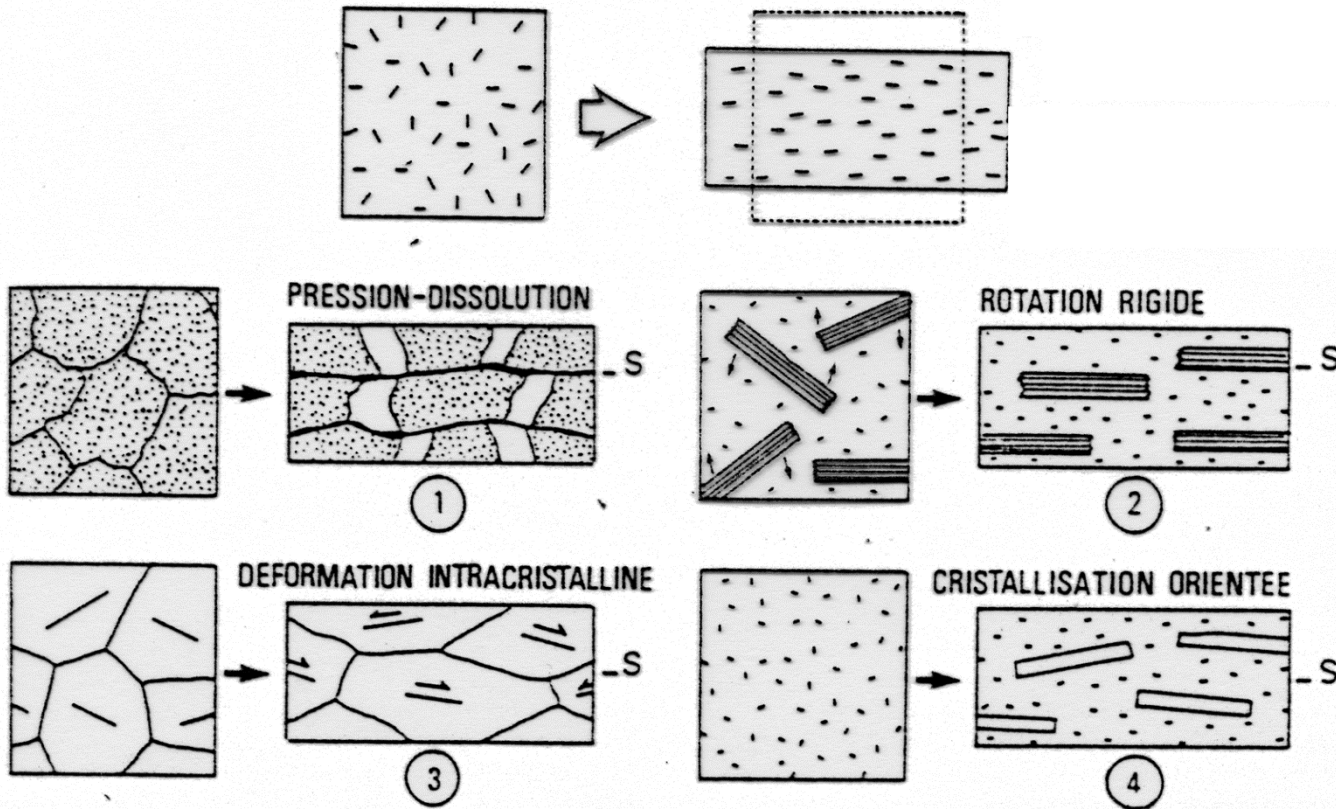

Fig. 3.7. **a** Lattice with two types of point defects. **b** Edge dislocation defined by the edge of a half-plane in a distorted crystal lattice. **c** Screw dislocation defined by a twisted lattice. **d** Dislocation with edge and screw dislocation regions in a

crystal. A square itinerary of small arrows around the dislocation is used to find the Burgers vector of the dislocation, indicated by *open arrows*

Genesi della foliazione



Da Mercier & Vergely, 1995

B. crystal plasticity

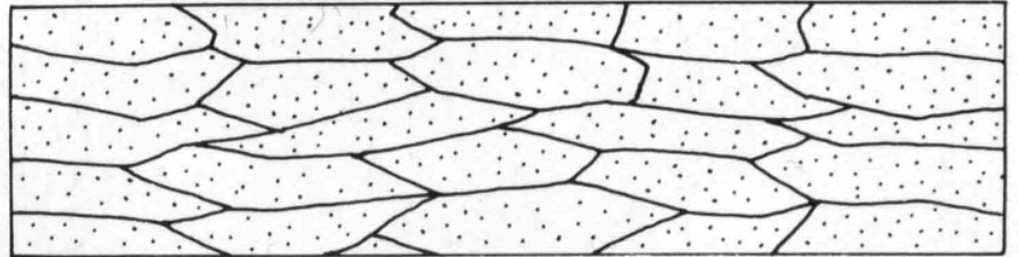

C. grain boundary sliding

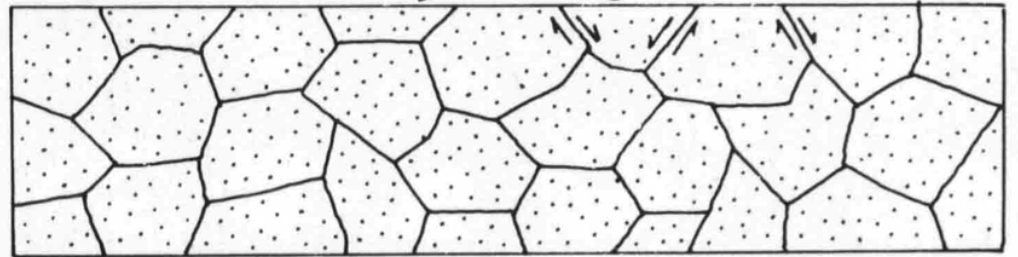

D. pressure solution

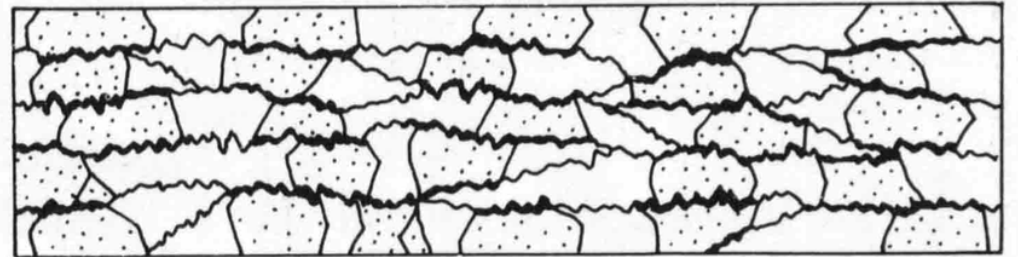

A. original aggregate

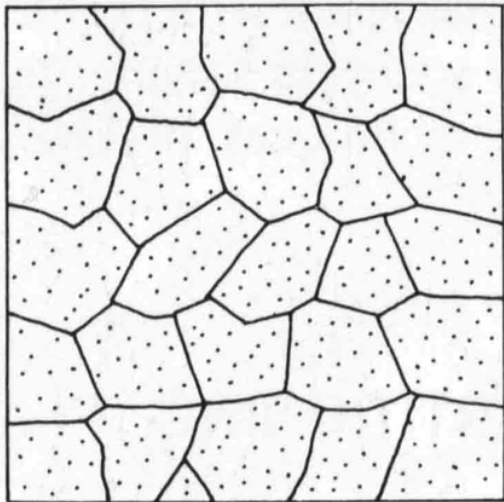

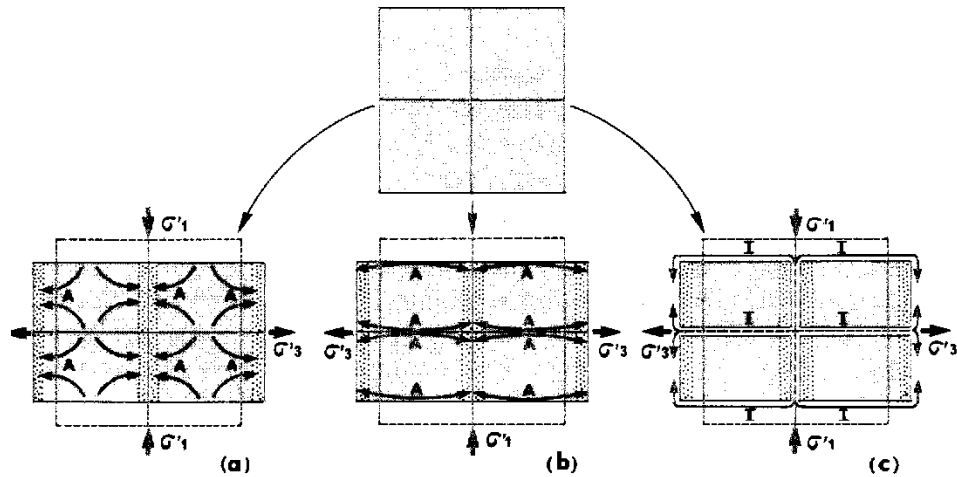

7.6. Mécanismes de transfert de matière par diffusion (a) fluage de Nabarro-Herring, (b) fluage de Coble et (c) par pression-dissolution. La forme initiale des grains est en tiretets. A : atomes, I : ions.

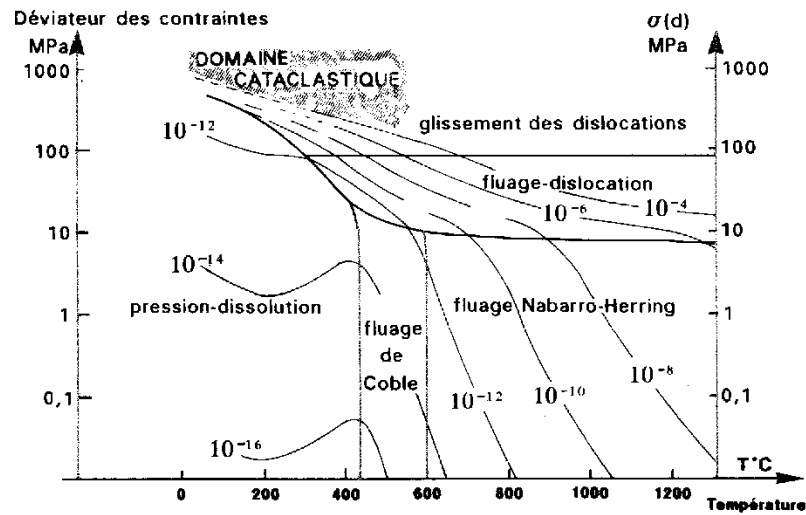

7.7. Carte des domaines (T - σ) de déformation de la calcite ; la taille des grains est de 100 μ et la pression de fluide de 100 MPa pour la pression-dissolution (d'après Rutter, 1976, *Phil. Trans. Roy. Soc. London*, A283, 43-54). Les courbes représentent les taux de déformation par seconde. On a considéré que pour $\dot{\epsilon} > 10^{-4} \text{ s}^{-1}$ la déformation est cataclastique à basse température.

Strutture fragili-duttili

(certi casi di boudinage; vene a schiera)

Strutture fragili-duttile: certi casi di boudinage

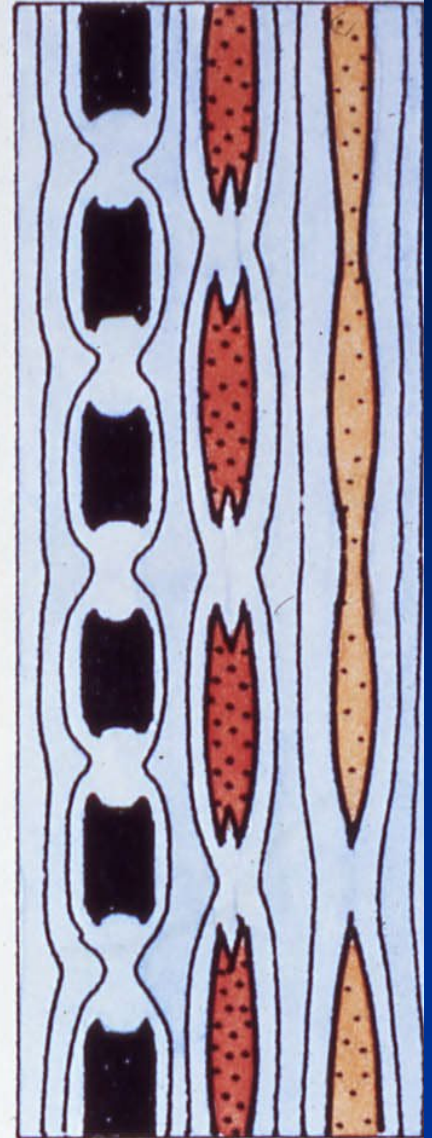
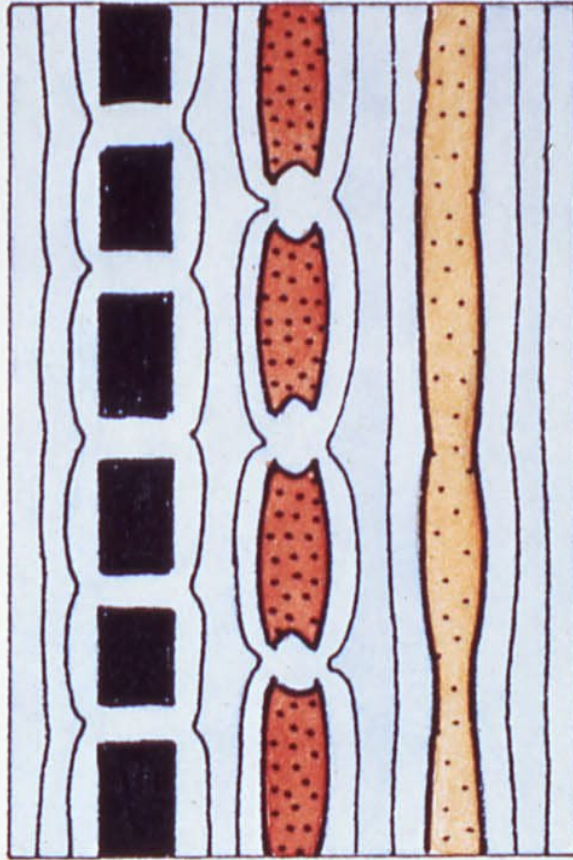
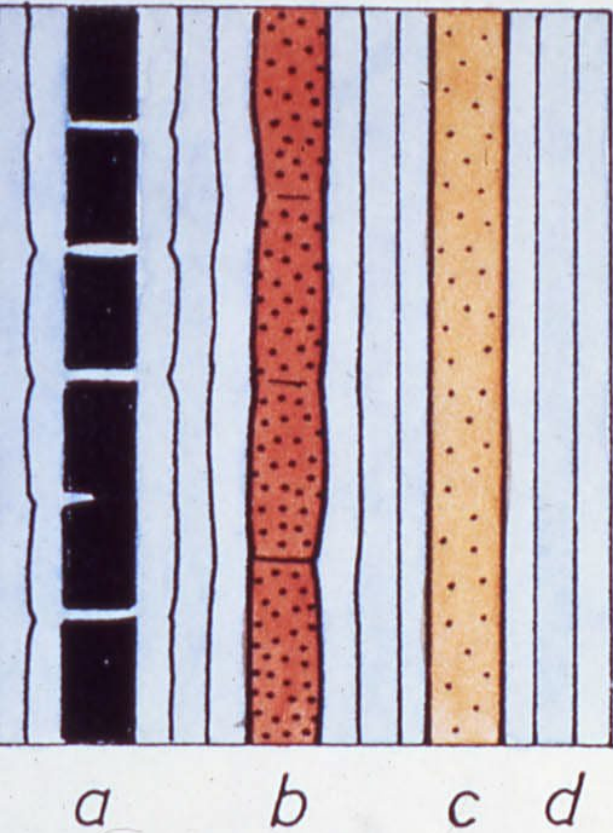

Strutture fragili-duttile: vene sigmoidali a schiera

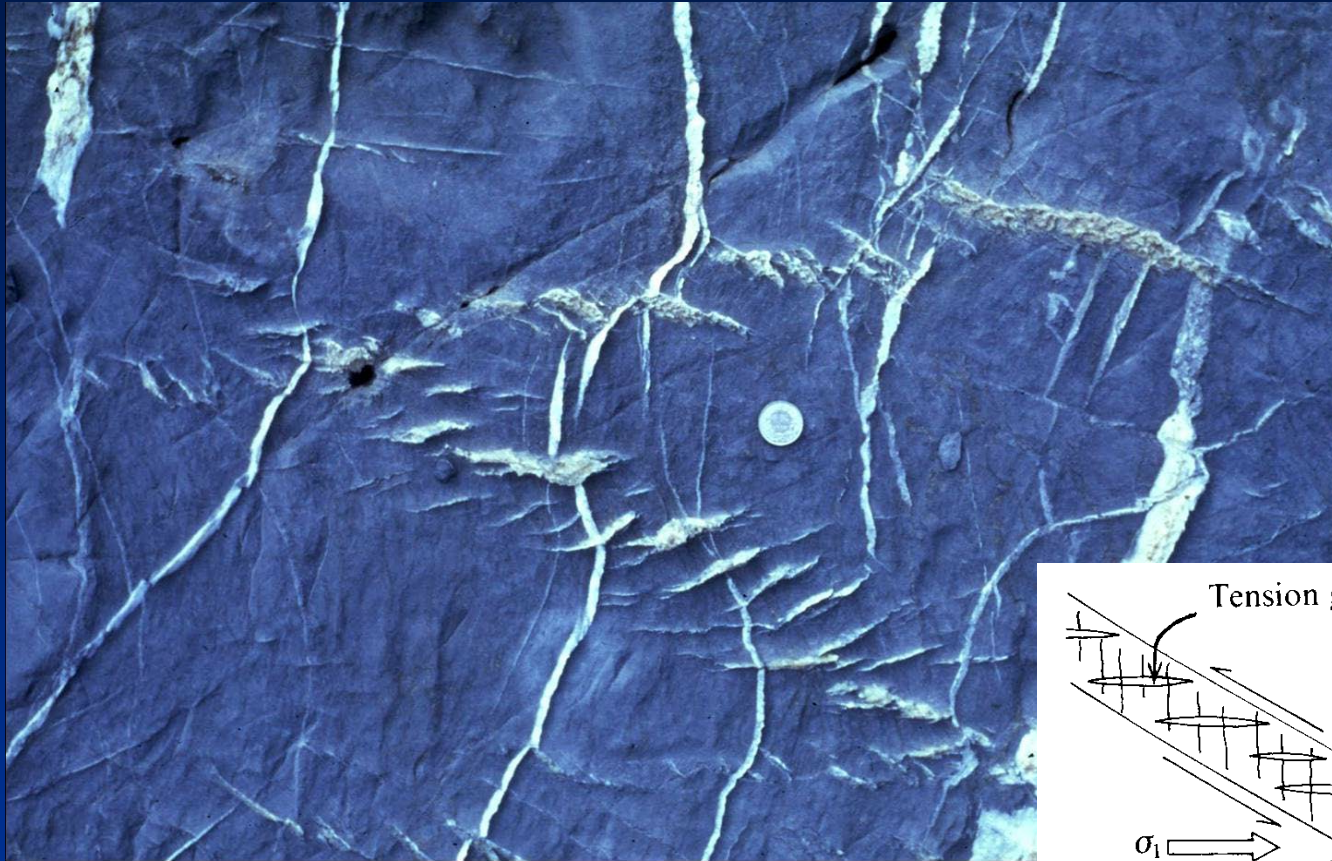

Da Ramsay and Huber, 1987

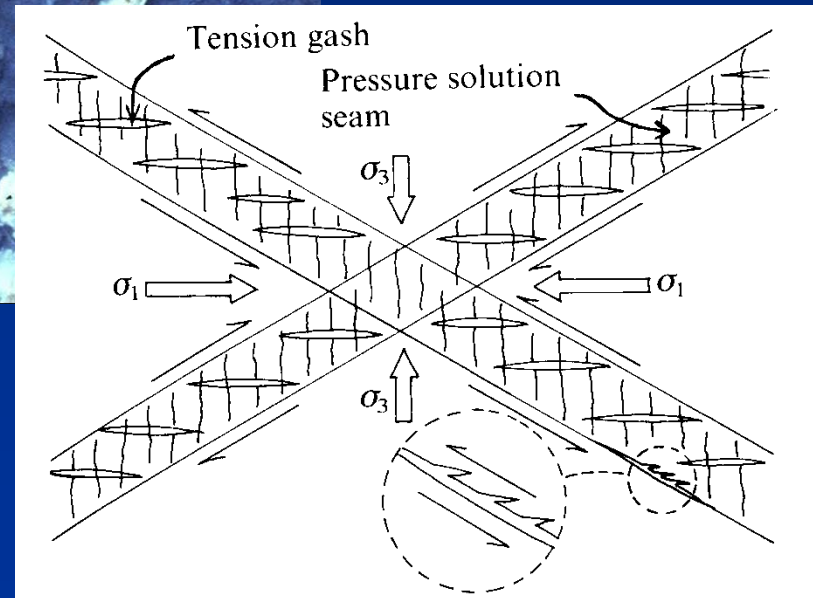

Da Price and Cosgrove, 1990



Da Ramsay and Huber, 1987

Da Mercier & Vergely, 1996



Figura 4.18. Squarci da tensione «en échelon» lungo una zona di taglio zz' .



Classificazione del Clivaggio

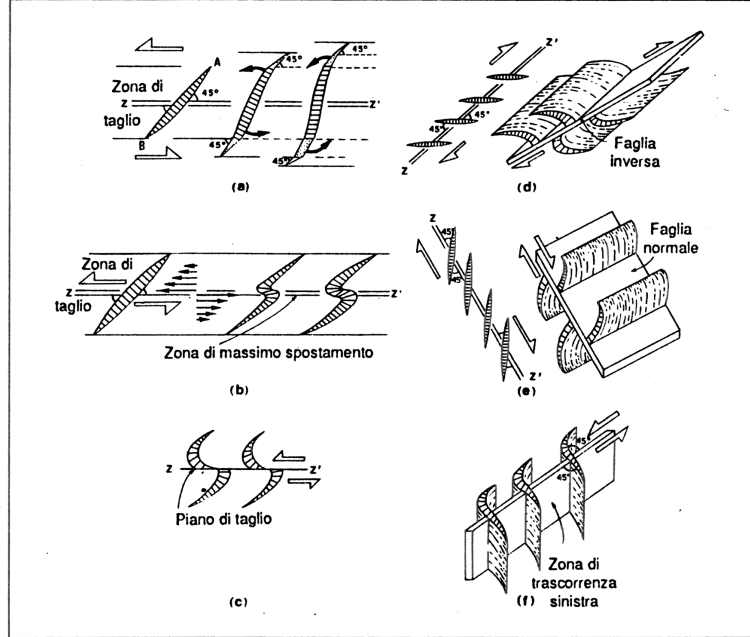
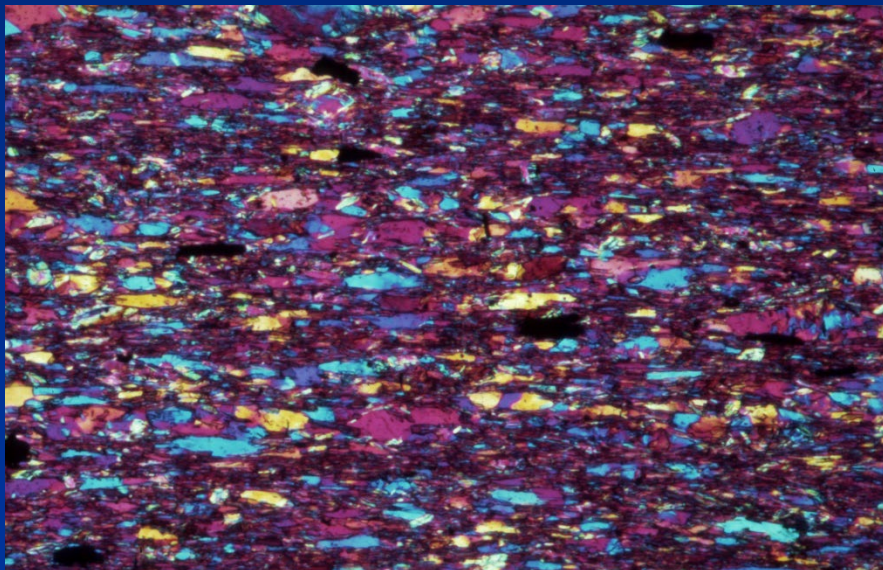
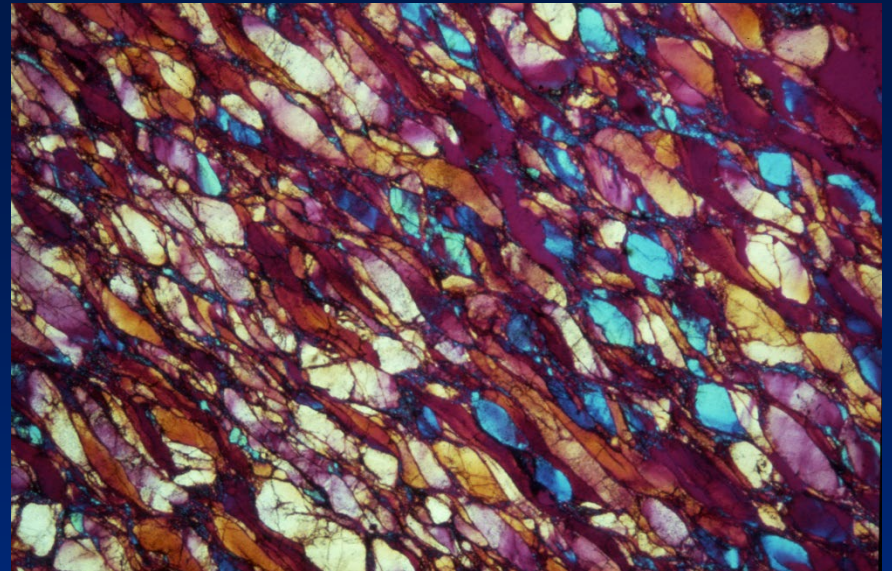

Passchier & Trouw, 2006

Cleavage domains e microlithons

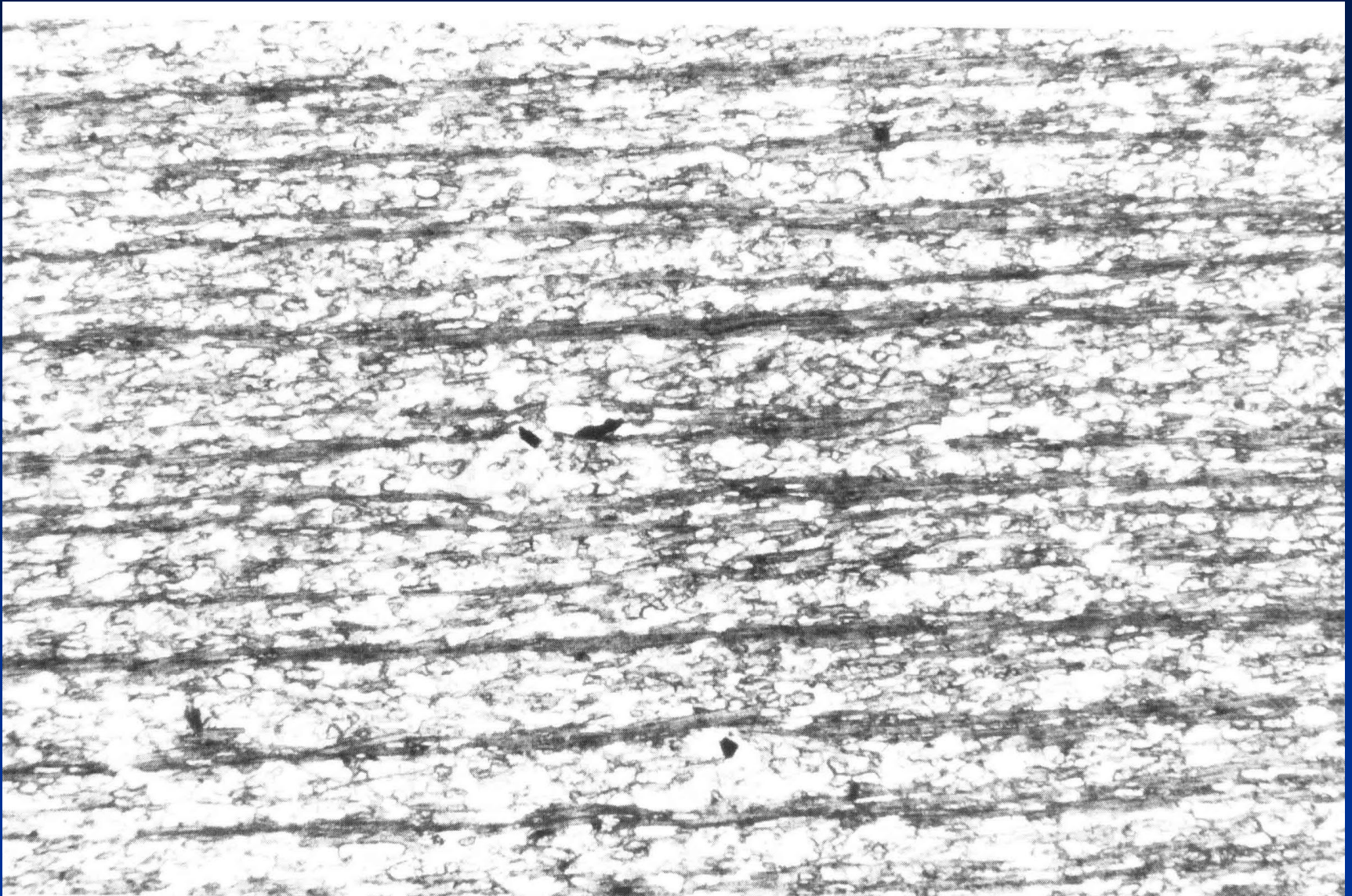

Morphological classification of foliations (using an optical microscope)

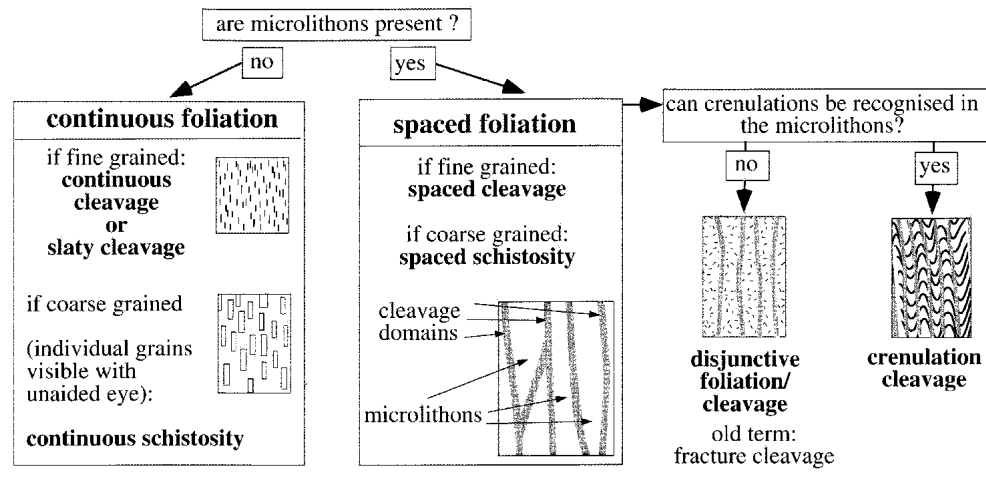

Useful criteria to describe spaced foliations :

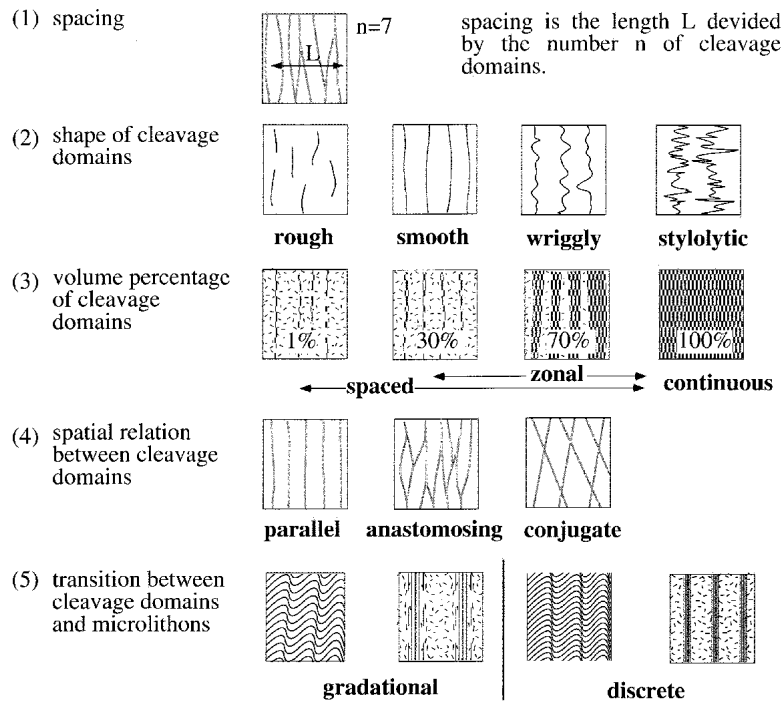
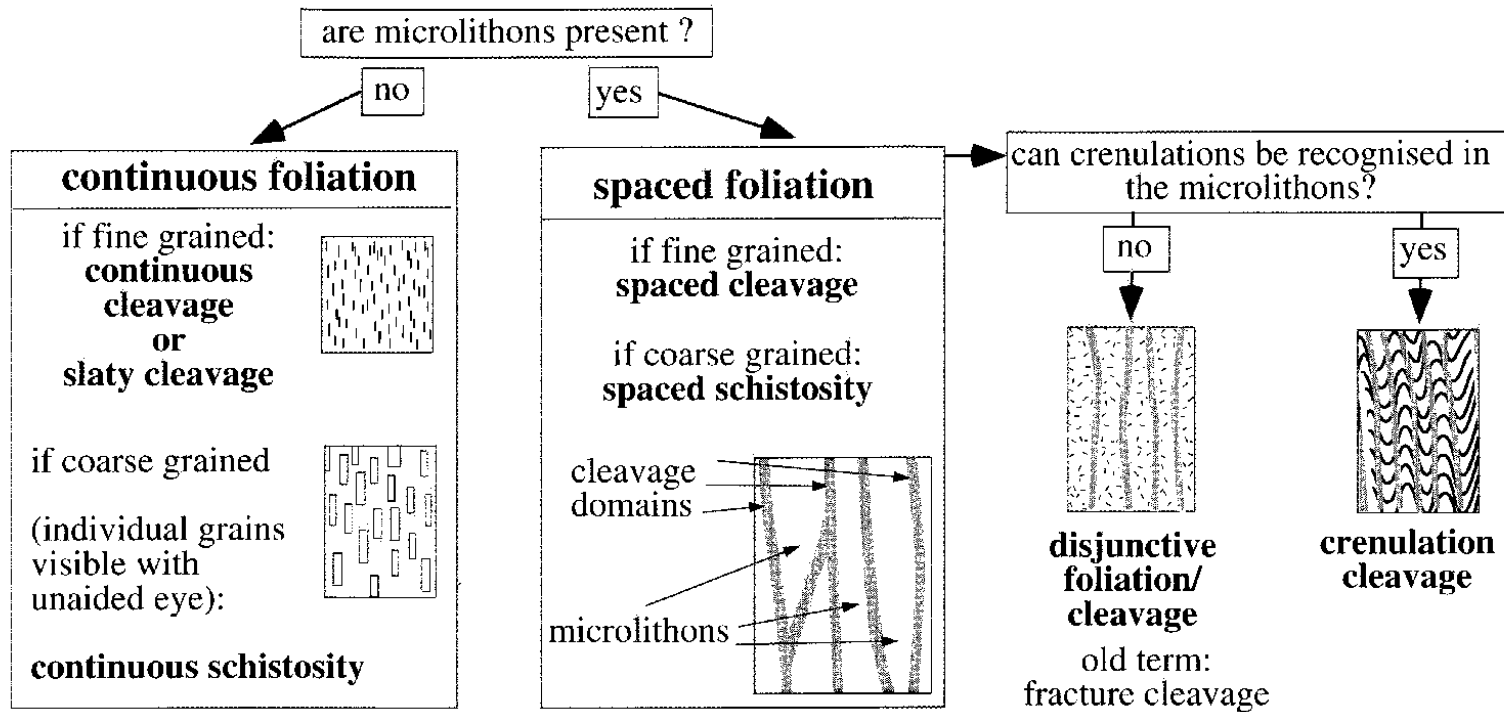

Fig. 4.6. Morphological classification of foliations using an optical microscope. (After Powell 1979 and Borradaile et al. 1982)

Morphological classification of foliations (using an optical microscope)



Useful criteria to describe spaced foliations :

(1) spacing

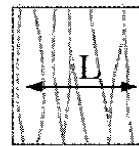

$n=7$

spacing is the length L divided by the number n of cleavage domains.

(2) shape of cleavage domains

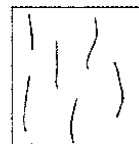

rough



smooth

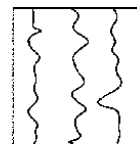

wriggly

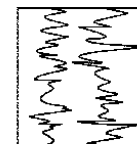

stylolitic

Useful criteria to describe spaced foliations :

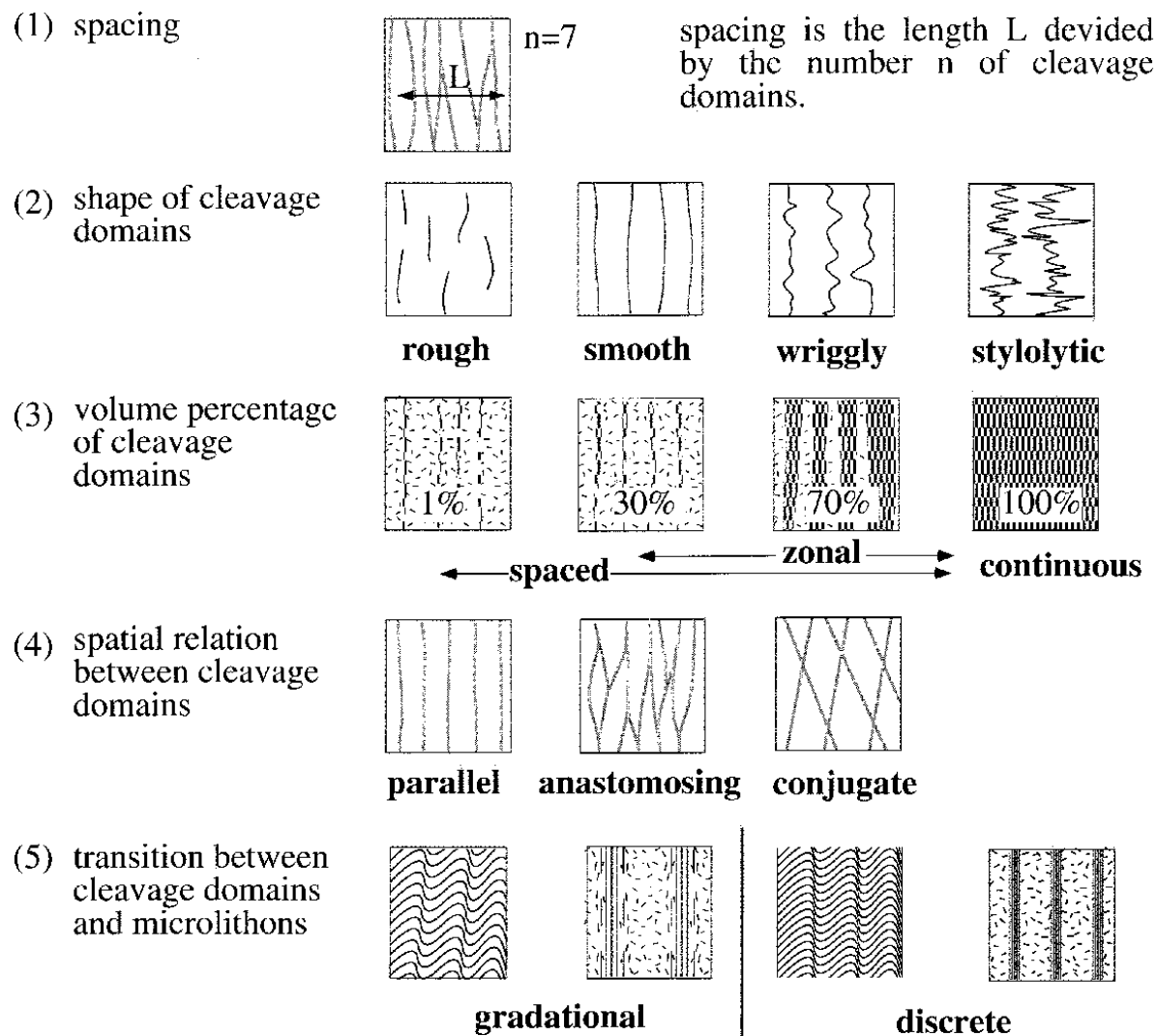

Fig. 4.6. Morphological classification of foliations using an optical microscope. (After Powell 1979 and Borradaile et al. 1982)