

## Recettori per molecole neutre

Legami idrogeno

Effetto idrofobico

Interazioni CH- $\pi$

Interazioni  $\pi$  stacking

pre organizzazione

# Recettori per molecole neutre

Interazioni CH- $\pi$  pre organizzazione (cavità profonde e rigide)

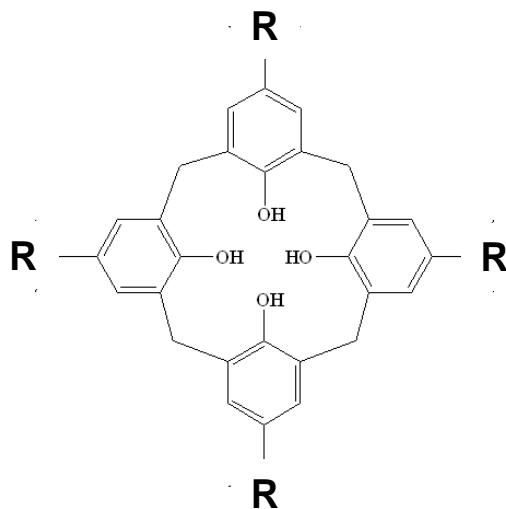

calix[4]arene

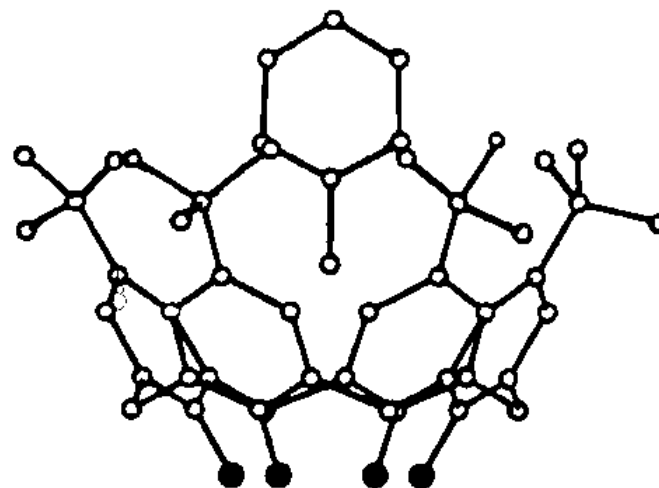

*p*-tert-Butylcalix[4]arene-toluene inclusion complex

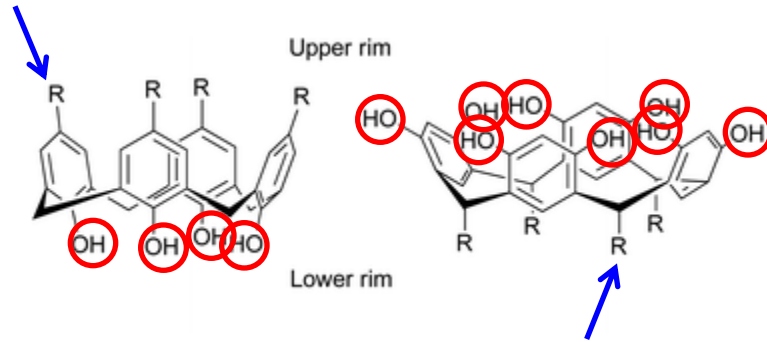
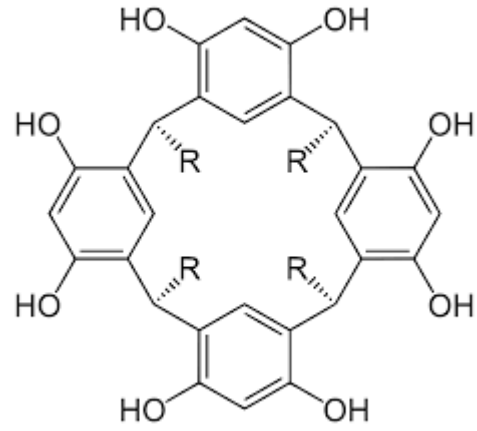
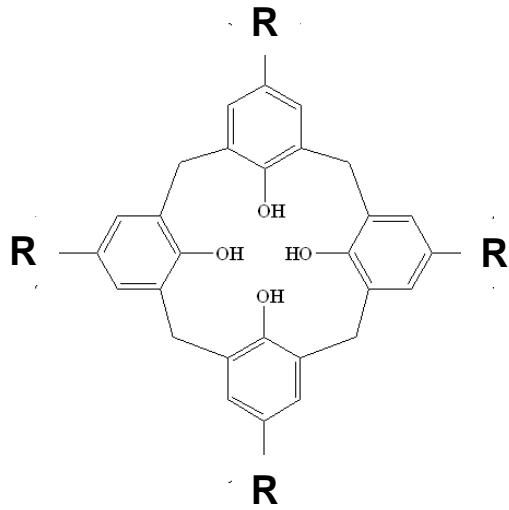

# [4] resorcinarene

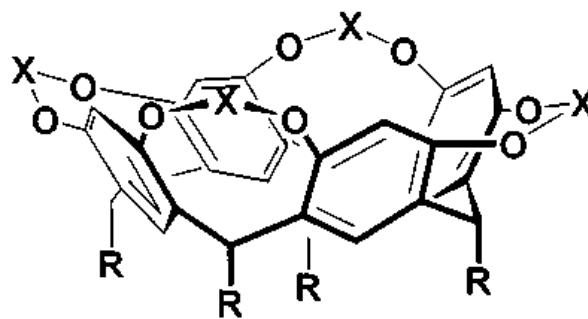
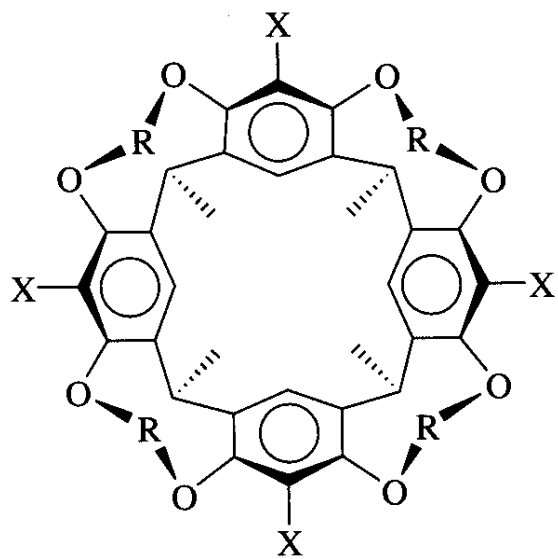

**2** R = Alkyl, Ar;  
X = (CH<sub>2</sub>)<sub>n</sub>, SiAlk<sub>2</sub>

Ciclofani concavi

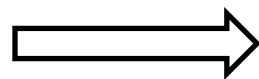

Cavitandi

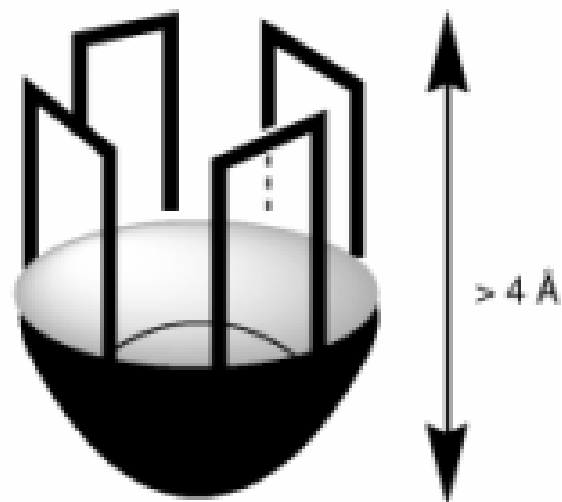
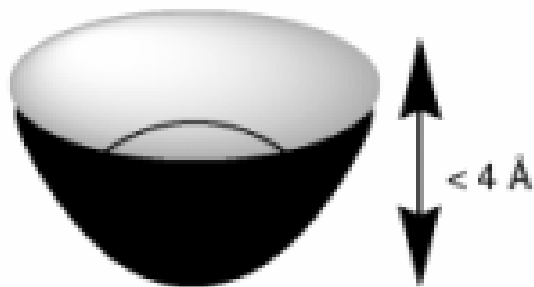

The studies of Cram<sup>13</sup> had established a barrier of some 10 to 12 kcal mol<sup>-1</sup> for the vase-to-kite interconversion. If this

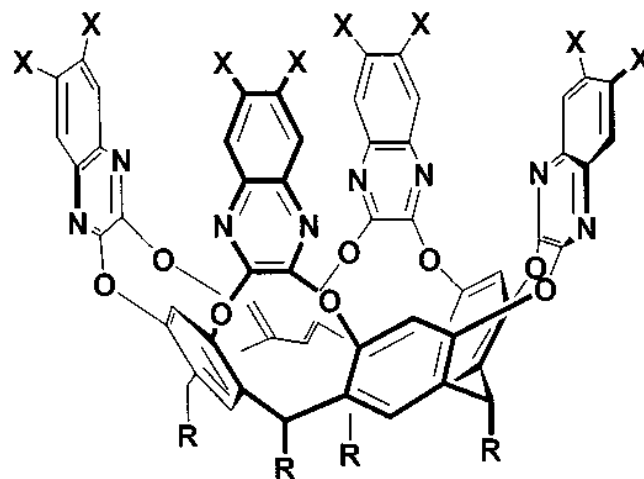
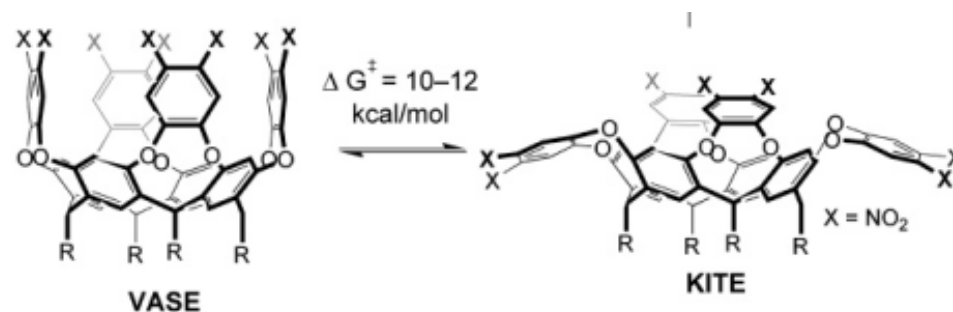

**3** R = Alkyl;  
 X = H, CH<sub>3</sub>, Hlg

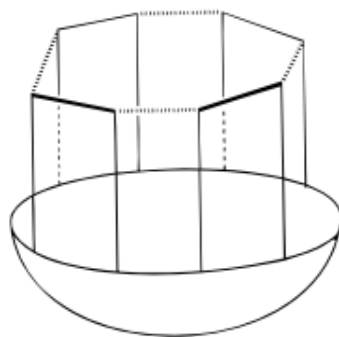
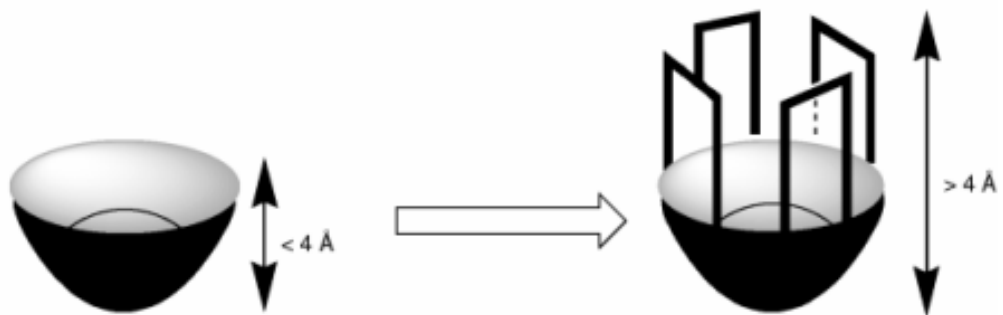

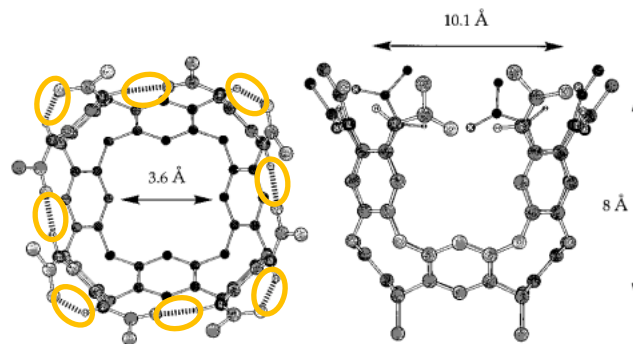
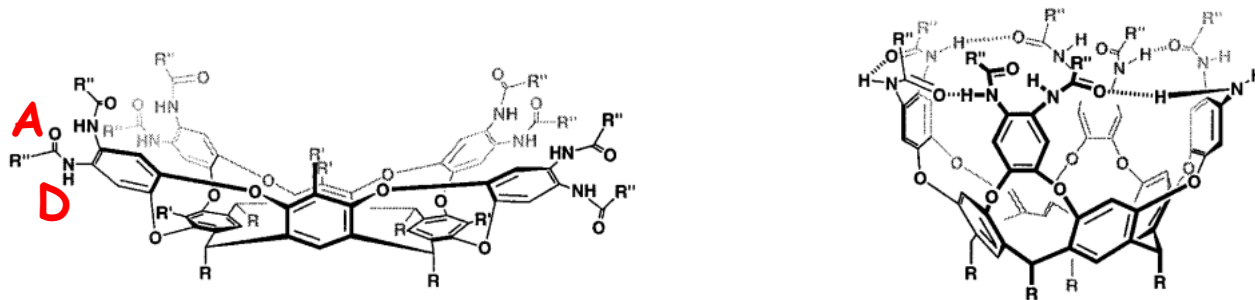
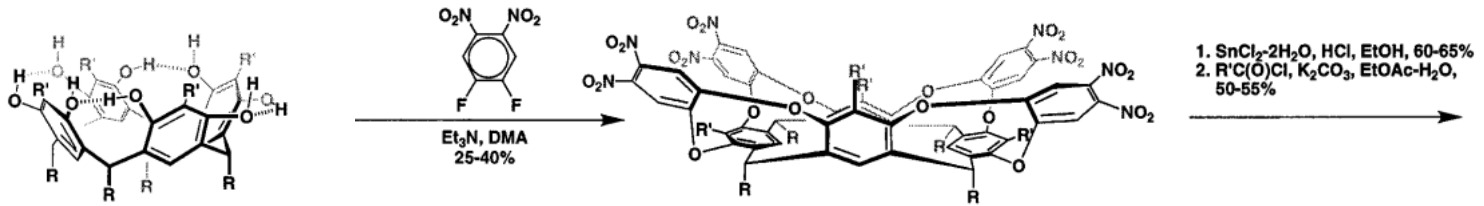



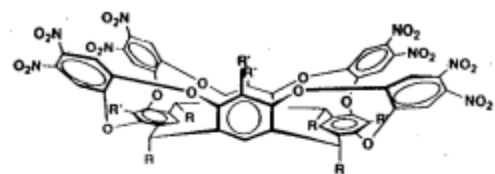

$\text{CDCl}_3, 295 \text{ K}$

4 c R =  $\text{C}_{11}\text{H}_{23}$ , R' = H

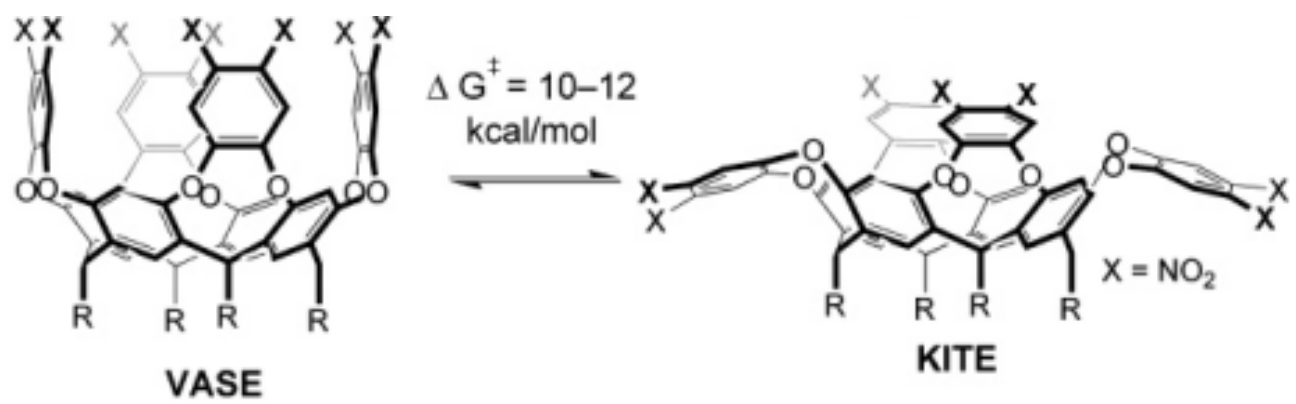
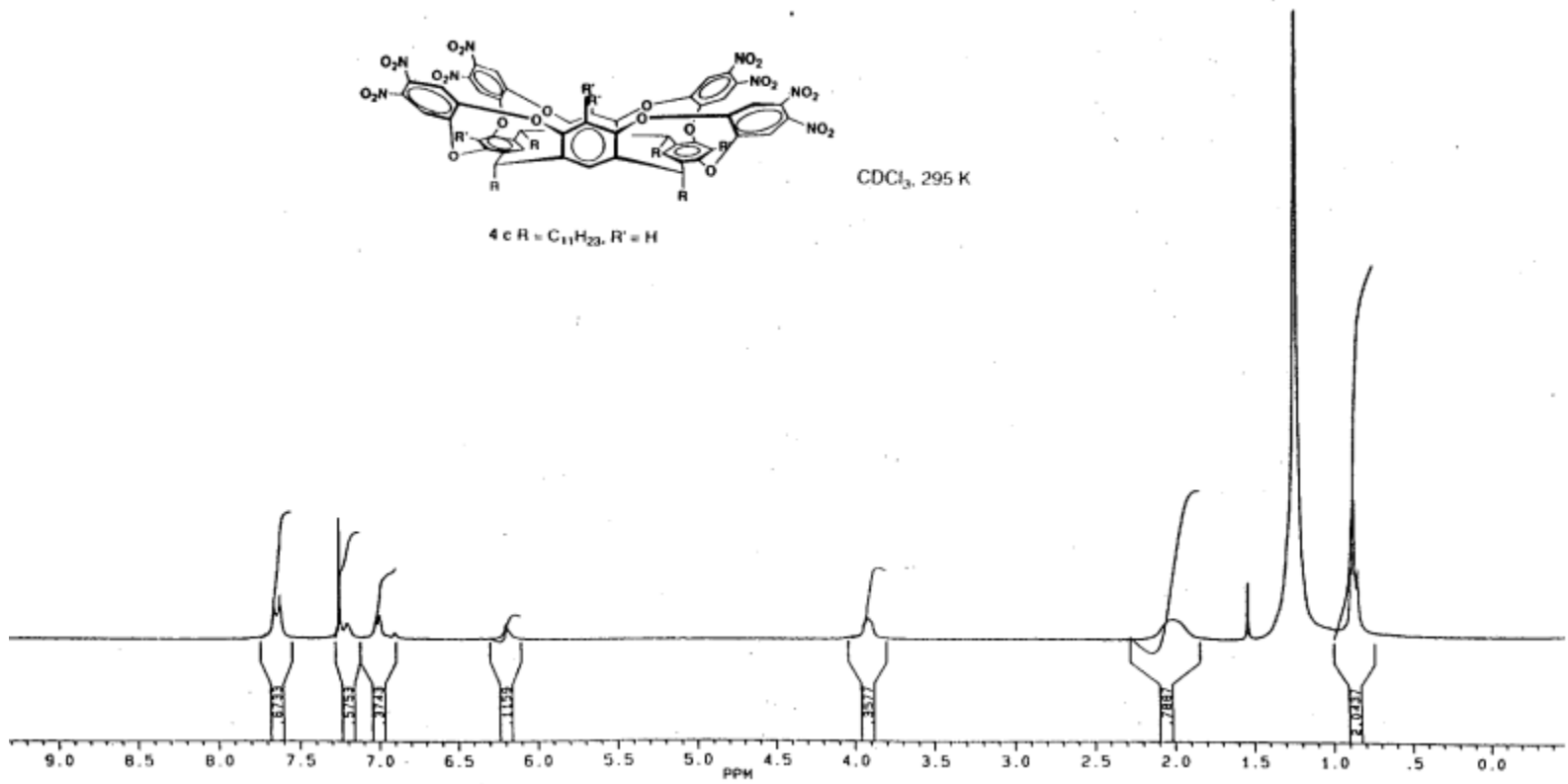

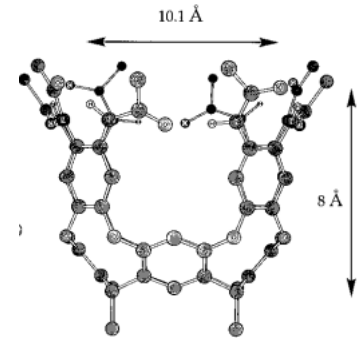

Spettro  $^1\text{H}$  NMR affilato

Segnale  $-\text{NH}$  spostato a campi bassi,

Spettro  $^1\text{H}$  NMR non varia con la concentrazione

Aggiunta solvente competitivo ( $\text{dmso}-d_6$ ):  
allargamento dei segnali

Stretching NH (IR)

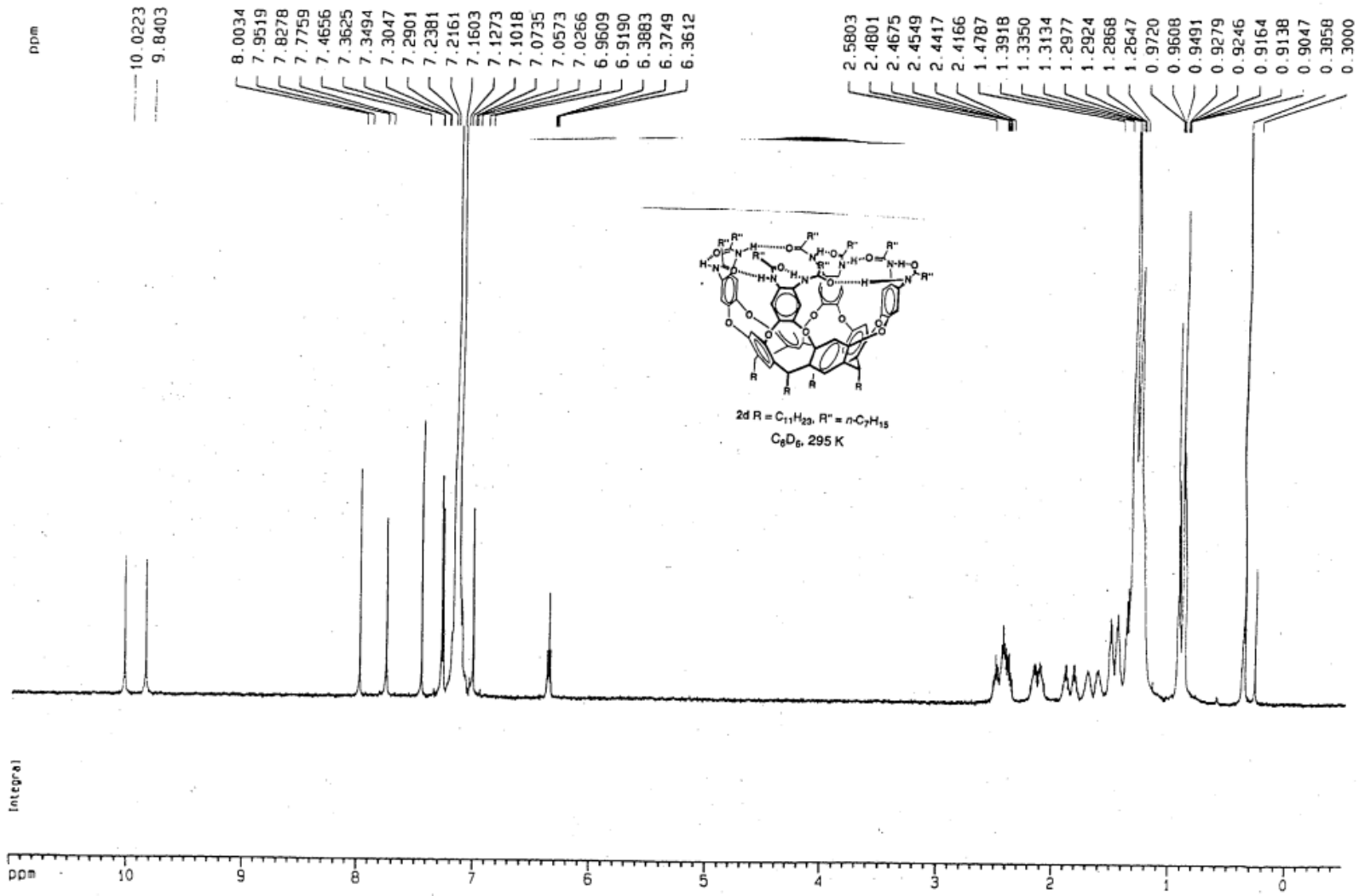

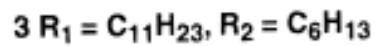
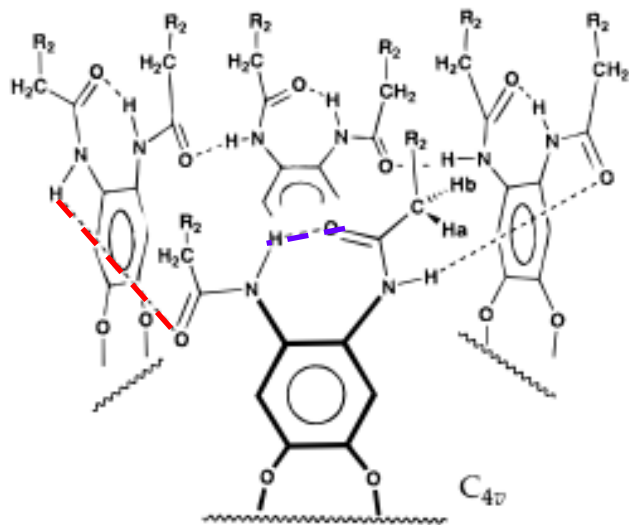

=

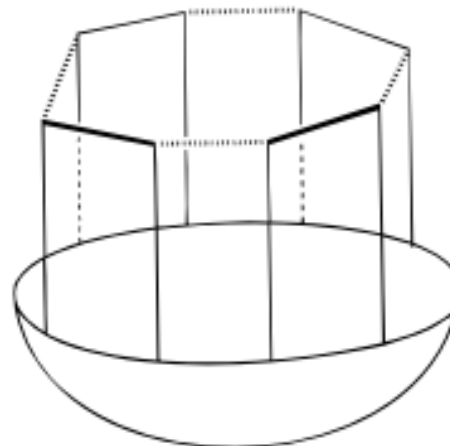

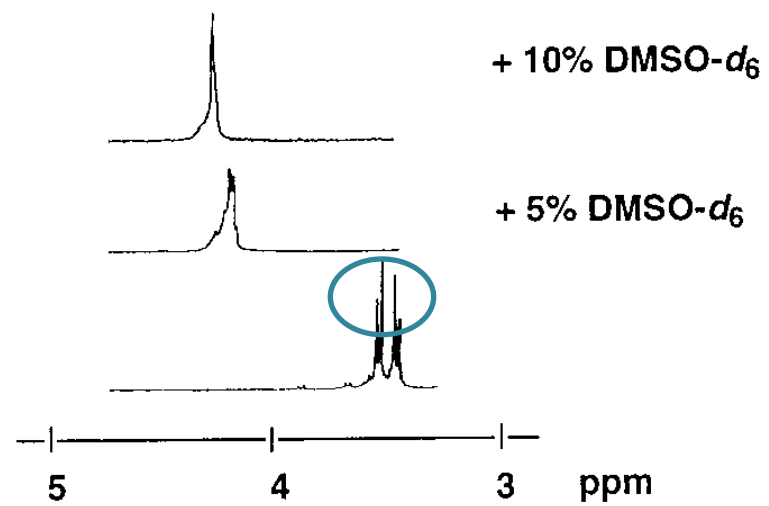
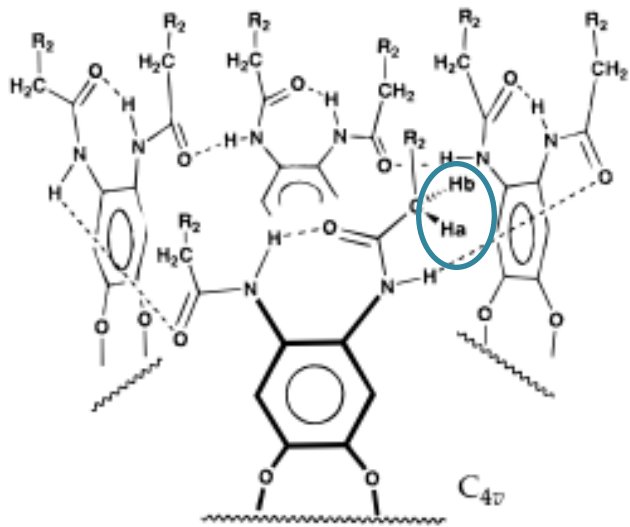
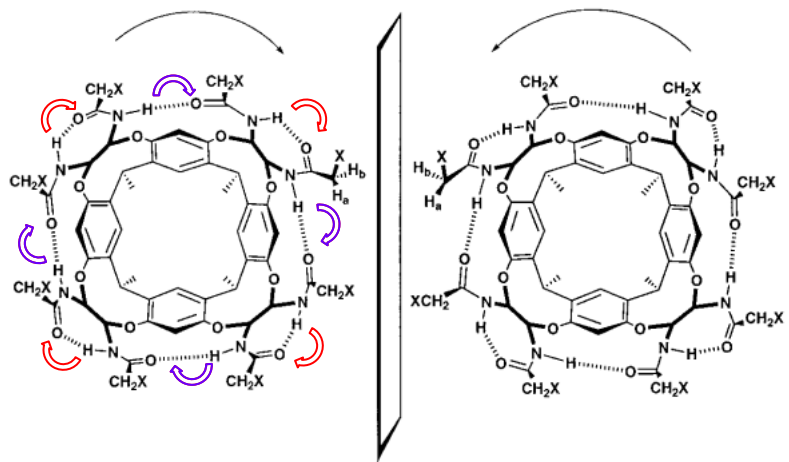

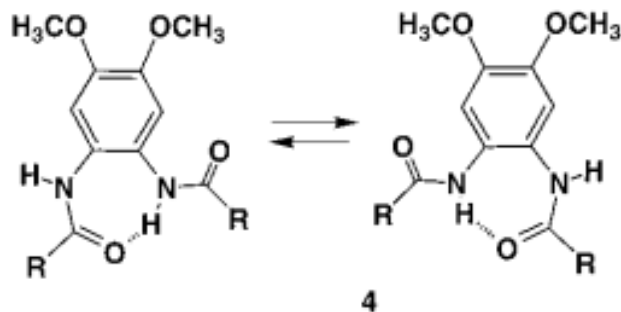

cavitand, four hydrogen bonds need to be broken: those that hold together adjacent rings. The typical costs of such ruptures in organic solvents are roughly 1 to 2 kcal mol<sup>-1</sup> per hydrogen bond,<sup>17</sup> so the additional 5 to 7 kcal mol<sup>-1</sup> is quite reasonable for the overall 17 kcal mol<sup>-1</sup> activation barrier to racemization.

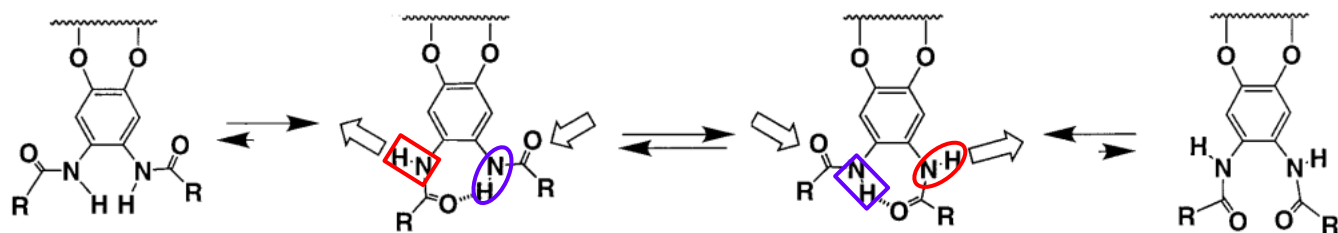



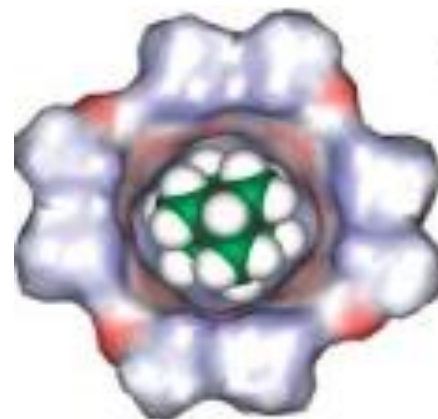
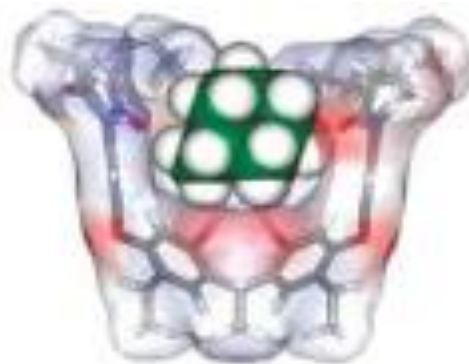
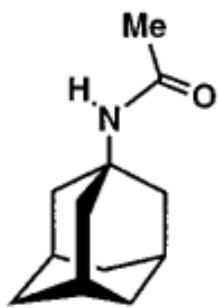

Stabilità migliaia di kcal/mol





In eccesso di guest: segnali NMR distinti per free and bound guest + evidenza di scambio da 2D EXSY

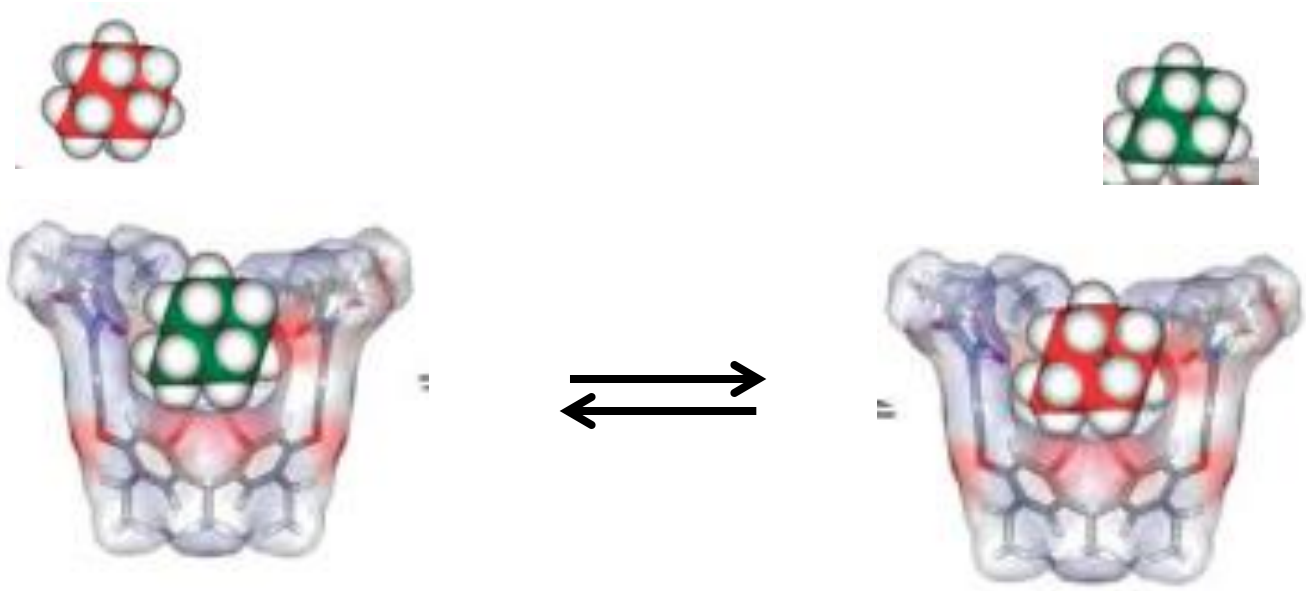

Scambio lento nella scala dei tempi NMR!!

Misura della cinetica di scambio (VT NMR):  
barriera cinetica di scambio di ca. 17 kcal mol<sup>-1</sup>

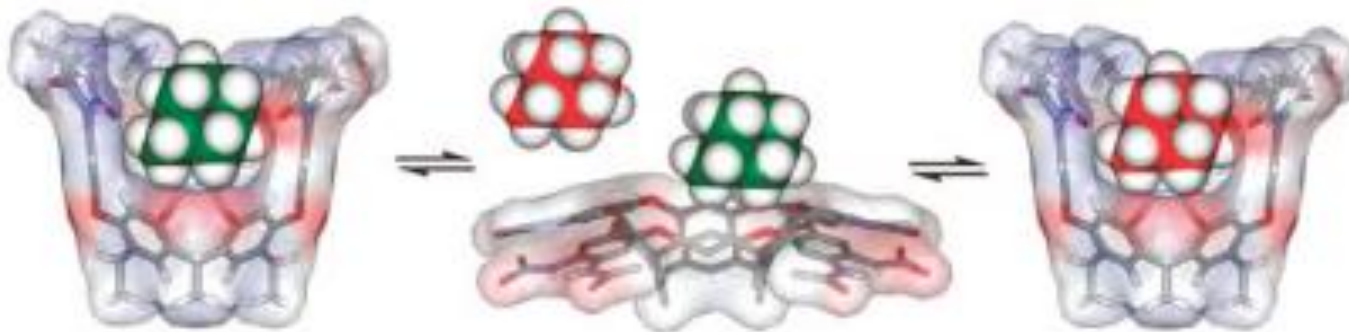
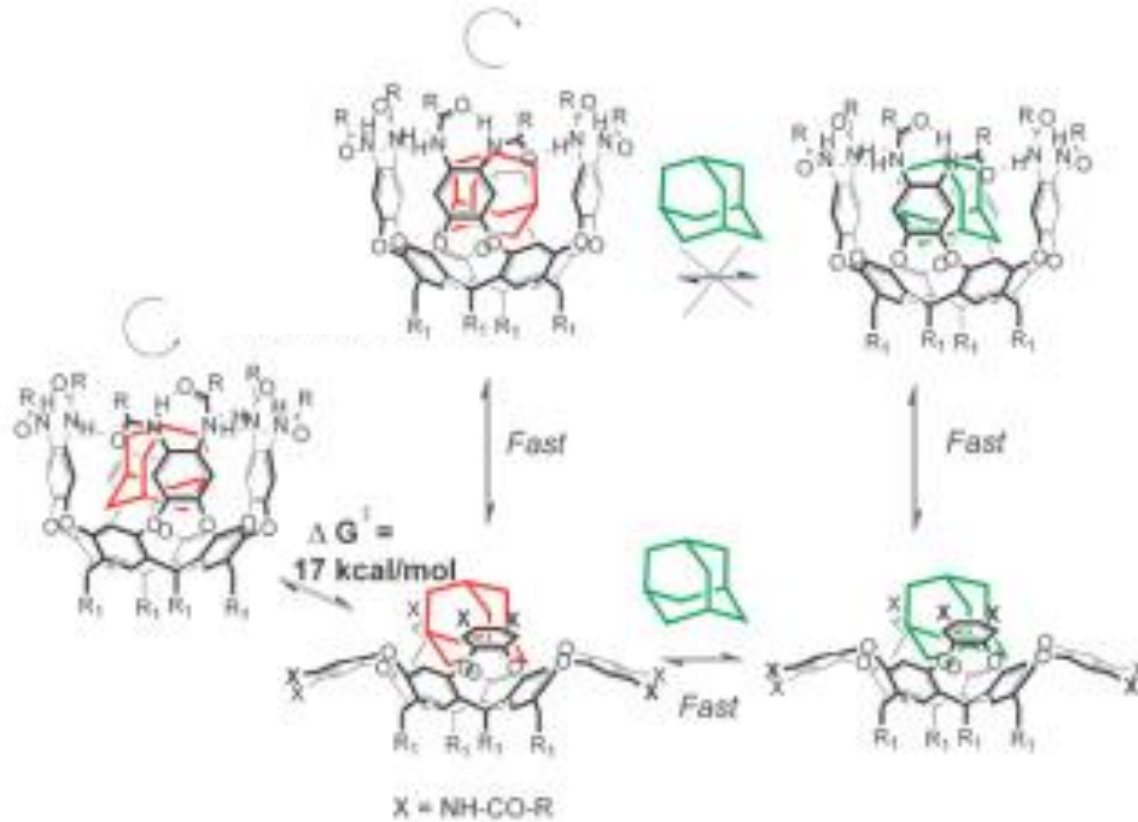

# Cavitandi funzionali?

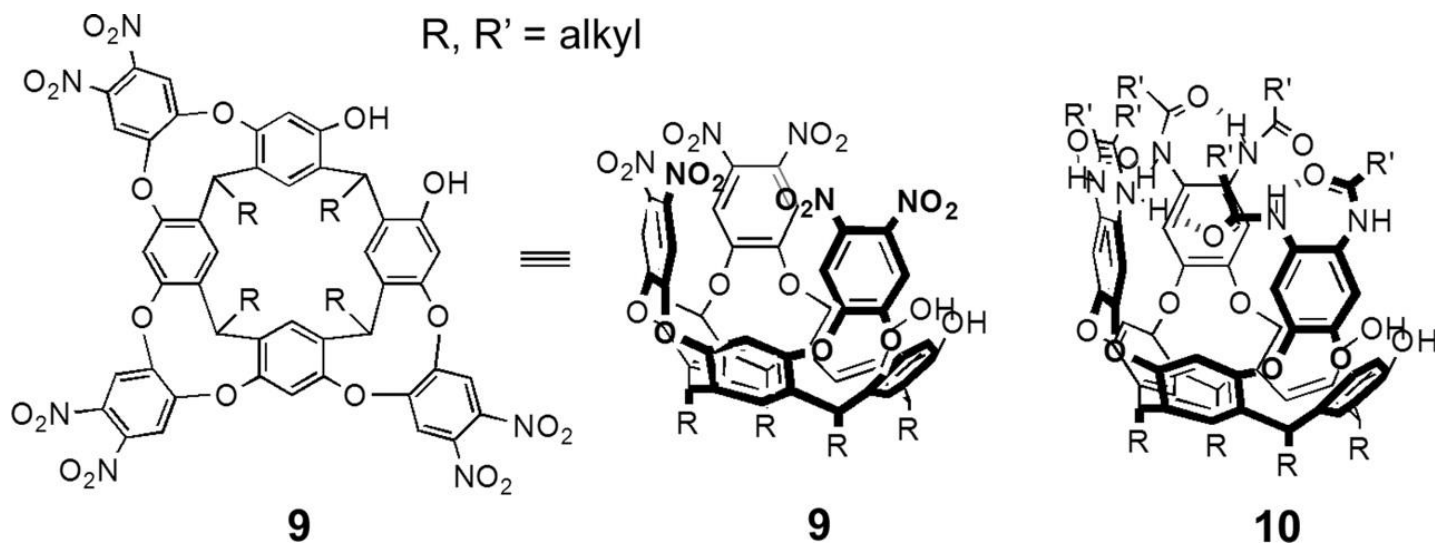

From the hexanitro precursor **9**, encountered as side-product in the preparation of the octanitro derivative, reduction and acylation to obtain hexamide **10**, followed by addition of the fourth wall and reduction to the diamine affords the common precursor to monofunctionalized cavitands.

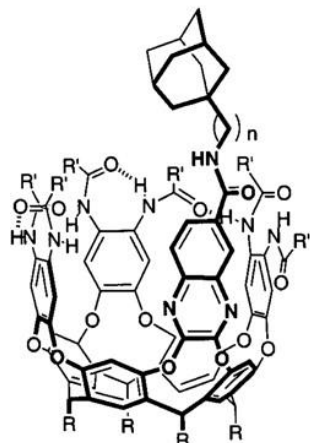

11

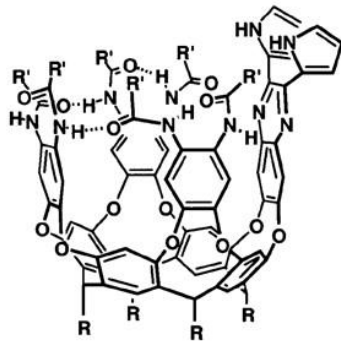

13

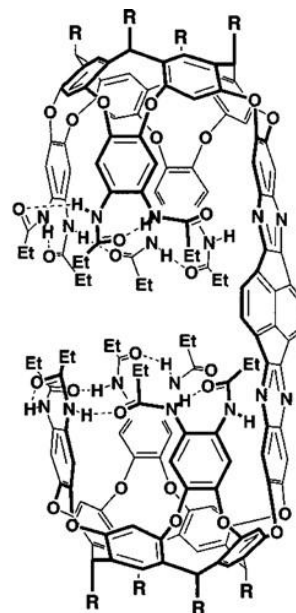

15

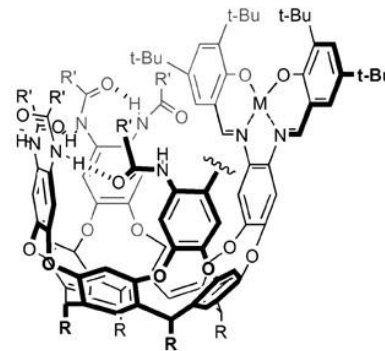

17

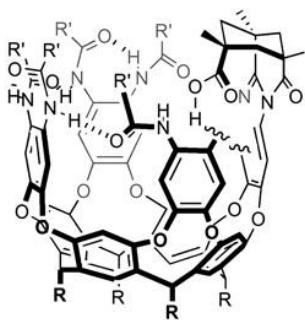

12

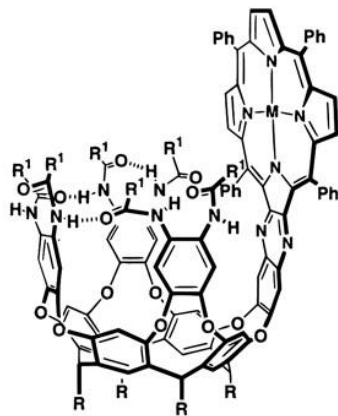

14

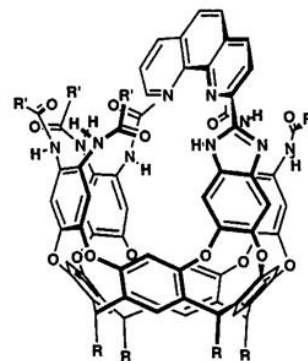

16

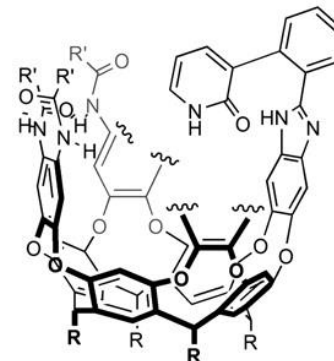

18

# Recettori per molecole neutre

Interazioni CH- $\pi$  pre organizzazione (cavità profonde e rigide)

## Ciclotriveratrilene CTV

condensazione 1,2-dimetossi benzene e formaldeide, H<sub>2</sub>O ac.

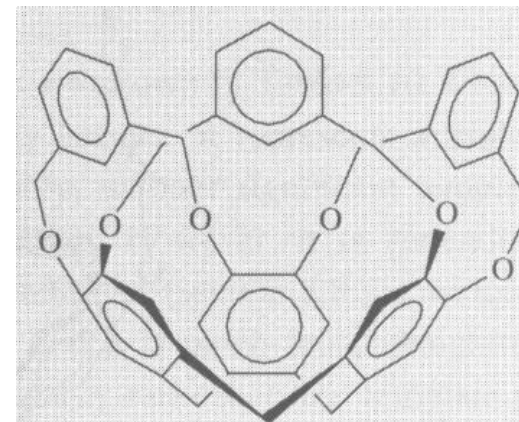
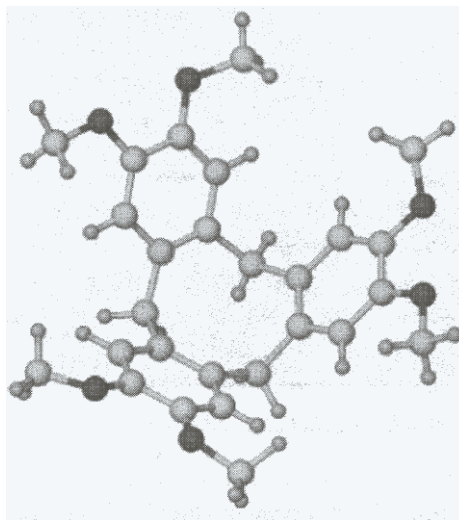
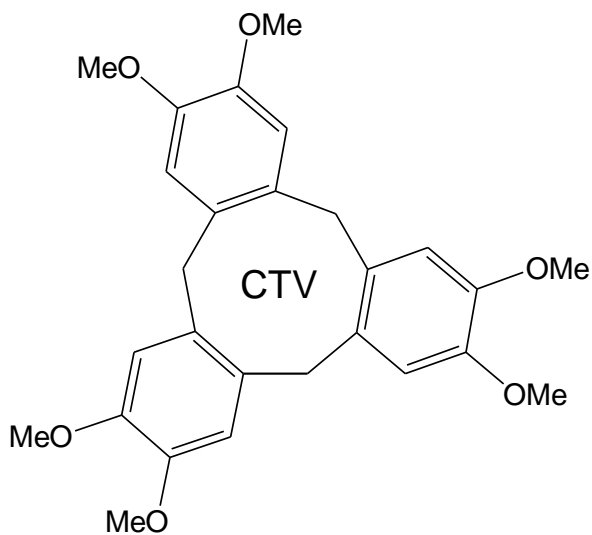

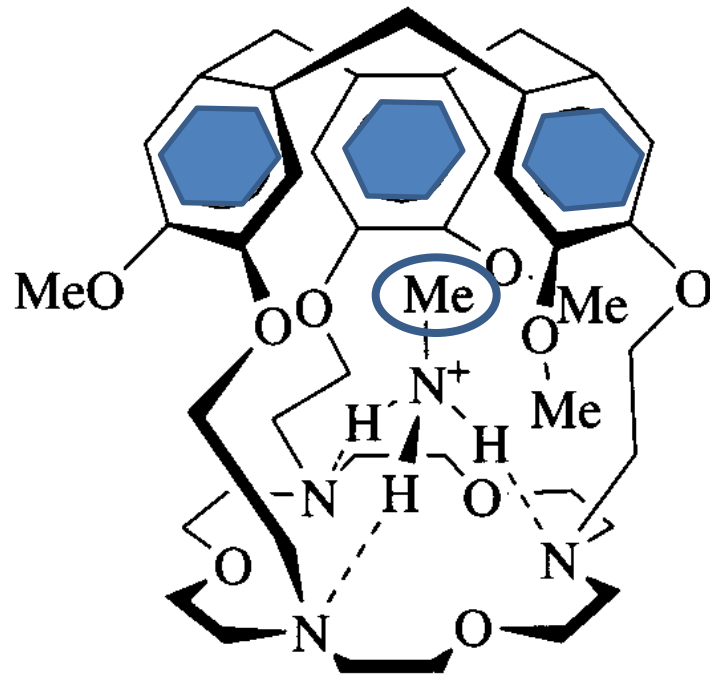

ciclotriveratrilene

corando

# Recettori per molecole neutre

Effetto idrofobico **esterno polare (e/o carico) tasca idrofobica**

Ciclodestrine – unità D-glucopiranosidiche (legami 1,4-glicosidici)

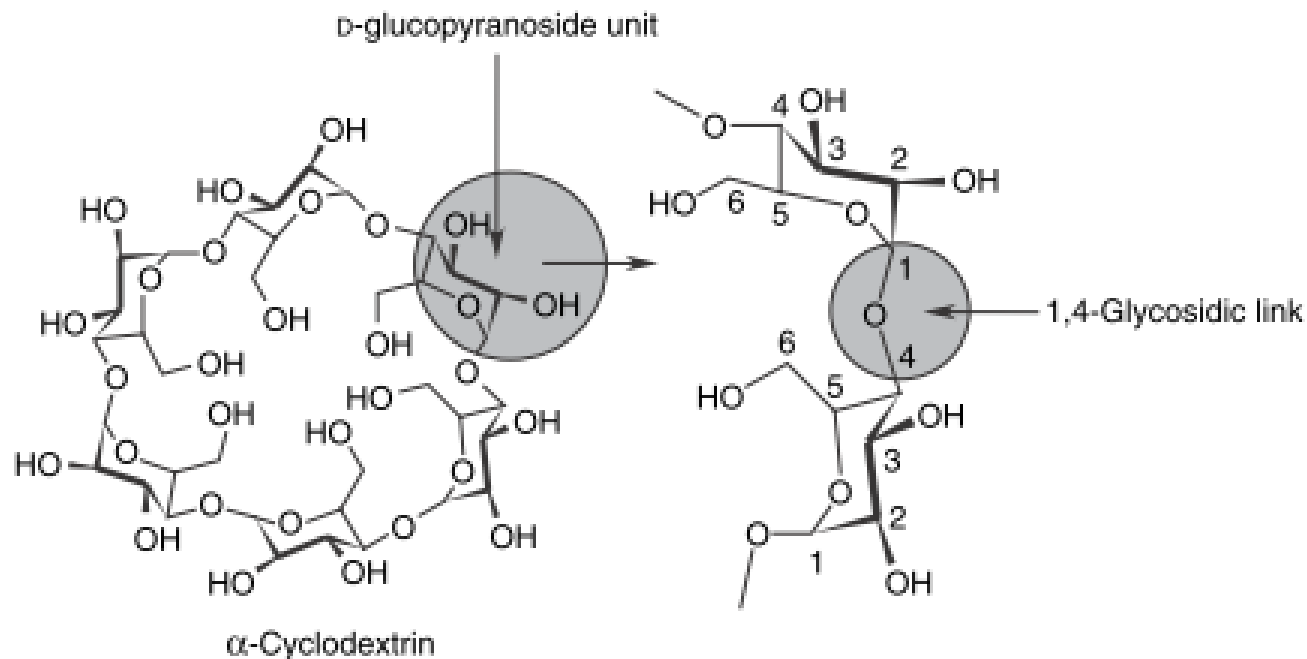



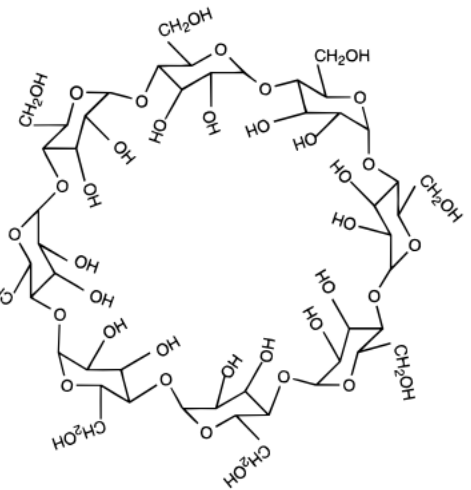
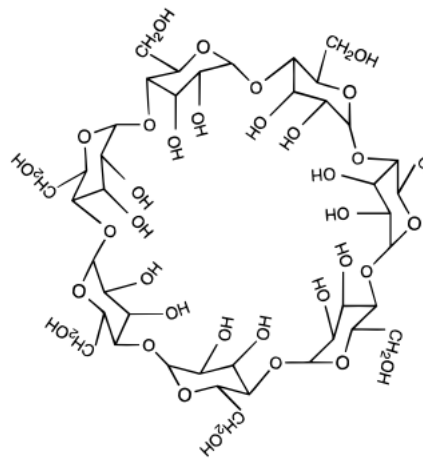
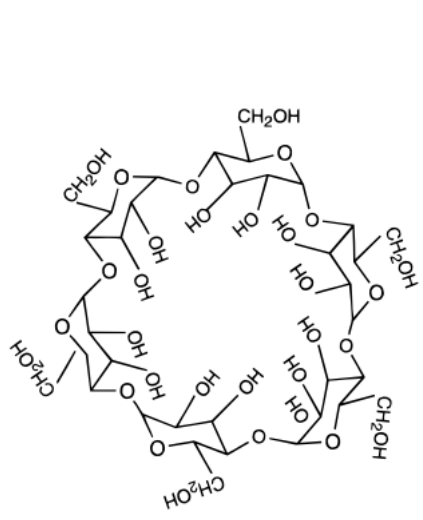
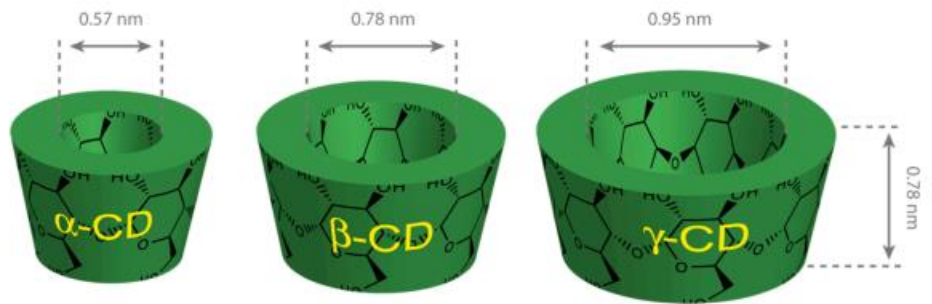

Solubilità (H<sub>2</sub>O):

$\alpha$  145g/L     $\beta$  18.5 g/L     $\gamma$  232 g/L

Size-fit, effetto idrofobico, vdW, dipolo-dipolo, legami a idrogeno..

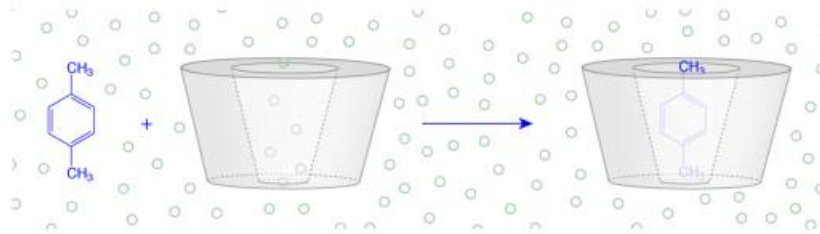

Complessi 1/1 o con varie stechiometrie

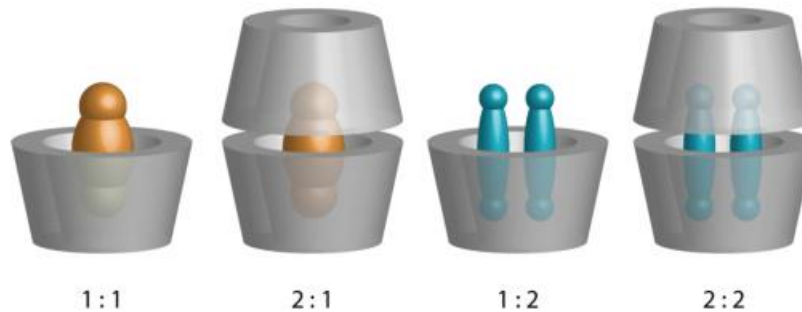

Derivatizz tramite gruppi OH:

alkyl/hydroxyalkyl/carboxyalkyl/ester/thiol/tosyl/...

non toxic...termostabili..airstable...

Production 1000 tons/year

Settori applicativi:

Farmaceutico: stabilità (luce aria). Biodisponibilità, formulazione, somministrazione..

Alimentare: aromi, spezie, emulsioni, colesterolo, vitamine

Cosmetico: lozioni solari

Analitici: grafting su supporti polimerici x cromatografia (HPLC chirale)

Cyclodextrins News

**Table 1. Recap of the Main Results of Freudenberg on Schardinger Dextrins**

year	result
1922	tosylated dextrins
1930	Schardinger dextrins: laboratory curiosities and/or unwanted byproducts of starch degradation Schardinger dextrins: chain molecules intermediate between maltose and starch
1935	the dextrins were lined with a hydrocarbon interior synthesis of Schardinger dextrins with high purity determination of molecular weights (five for $\alpha$ -dextrin and six for $\beta$ -dextrin) solubility differences of the dextrins chemical modification of dextrins (acetylation, methylation, saponification reactions)
1936	studies on the nature of the glycosidic bonds hypothesis on the cyclic nature
1938	cyclic chemical structure of dextrins hydrophobicity of the inner surface of the dextrins ability to form inclusion complexes Foundation of the Research Institute for the Chemistry of Wood and Polysaccharides
1939	description of the mechanism of action for <i>Bacillus macerans</i>
1943	cyclic structure composed of maltose units bound together by $\alpha(1\rightarrow 4)$ glycosidic linkages
1947	the first scheme for the isolation of pure fractions
1948	discovery of $\gamma$ -dextrin Freudenberg and Cramer demonstrated their conclusions on cyclic structure using optical activity data the first indication of the existence of dextrins comprising more than 8 glycosyl units
1950	structure of $\gamma$ -dextrin involvement of hydrophobic forces in the formation of the complexes possible existence of dextrins with 9 or 10 units of glucose
1953	first patent concerning applications in pharmaceutical formulations

# Cucurbiturili– unità glicolurile (legami metilenici)

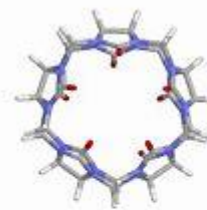
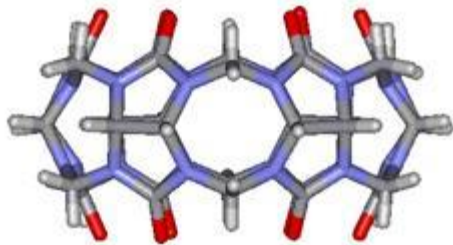
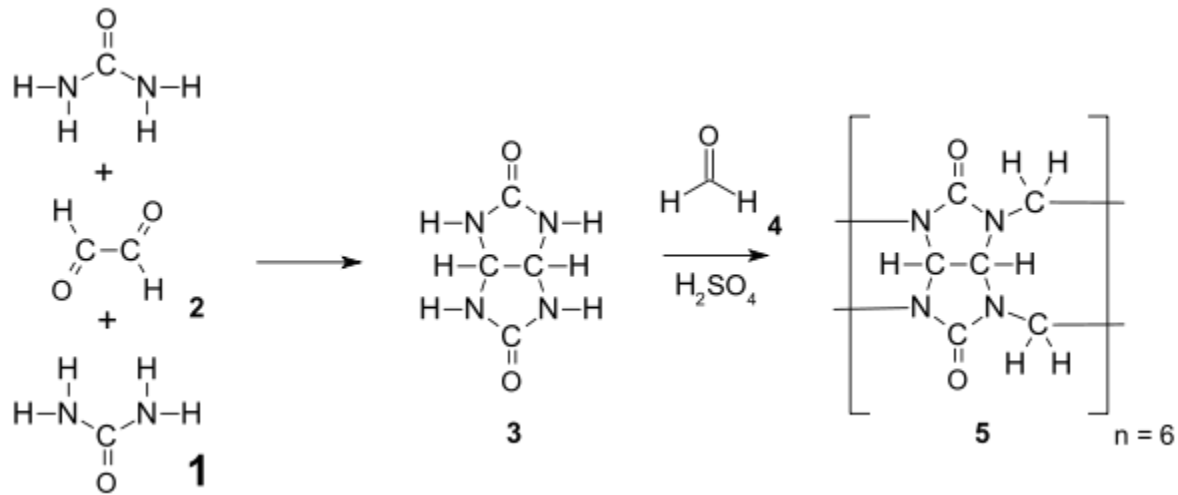

cucurbit[5]uril

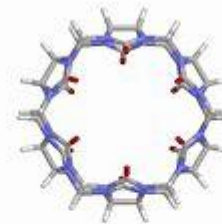

cucurbit[6]uril

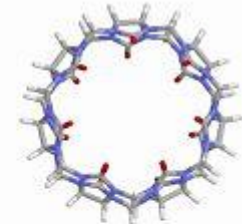

cucurbit[7]uril

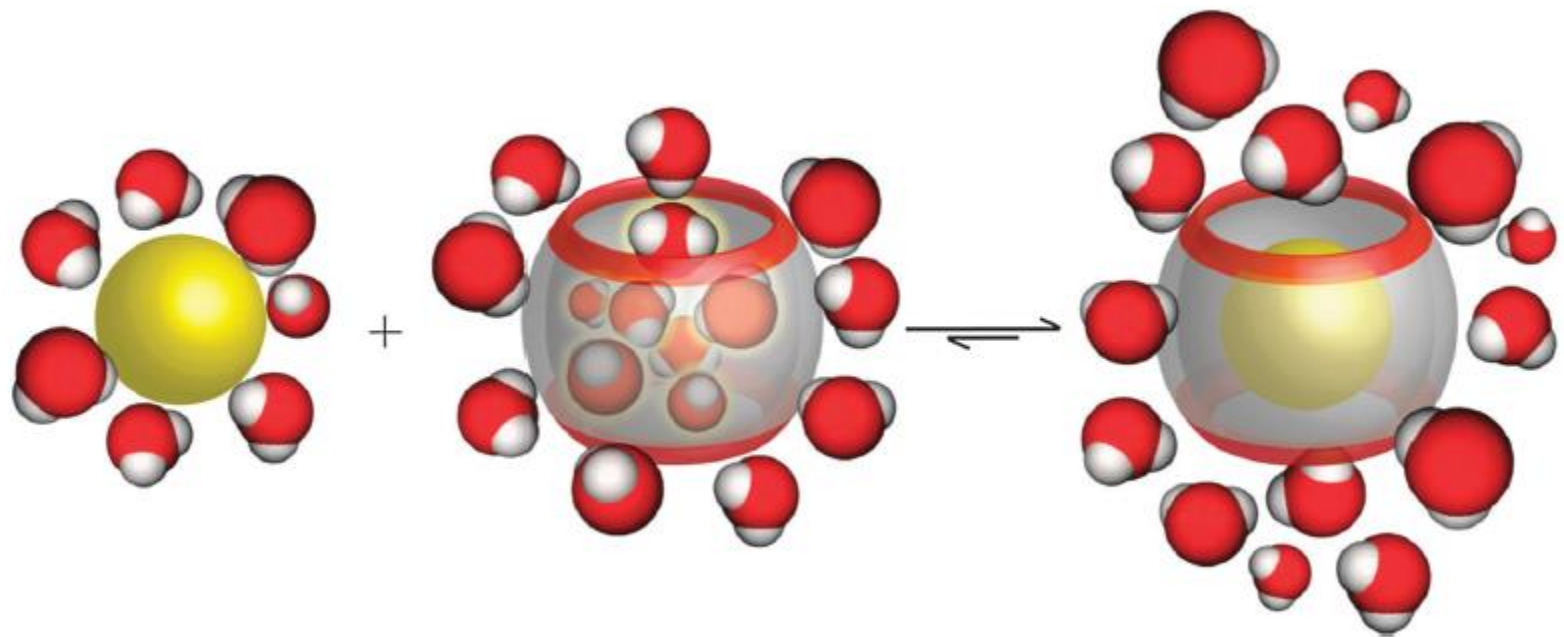

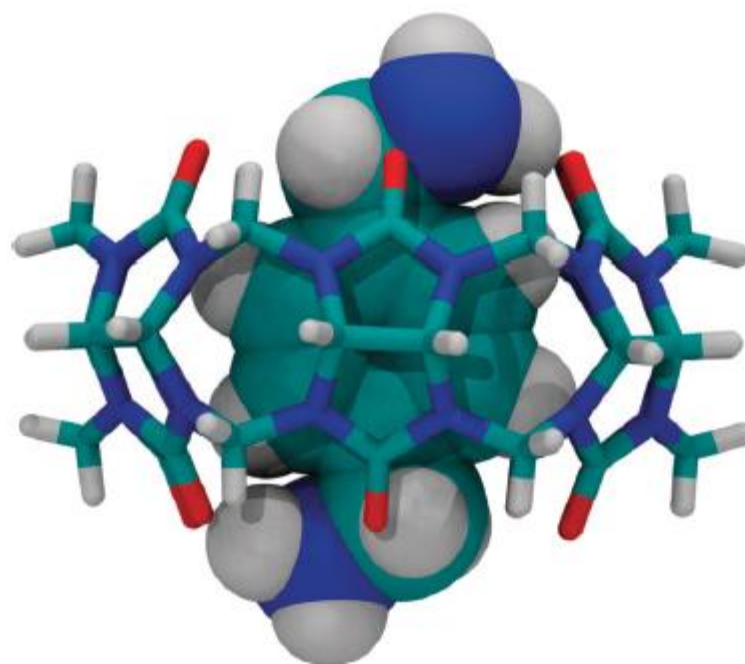

**Fig. 13** X-ray structure of the *p*-xylylenediammonium ion encapsulated by CB6, the first X-ray diffraction structure of a CB $n$  complex.<sup>127</sup>





Cite this: *Chem. Soc. Rev.*, 2015,  
44, 394

## Cucurbiturils: from synthesis to high-affinity binding and catalysis

Khaleel I. Assaf and Werner M. Nau\*

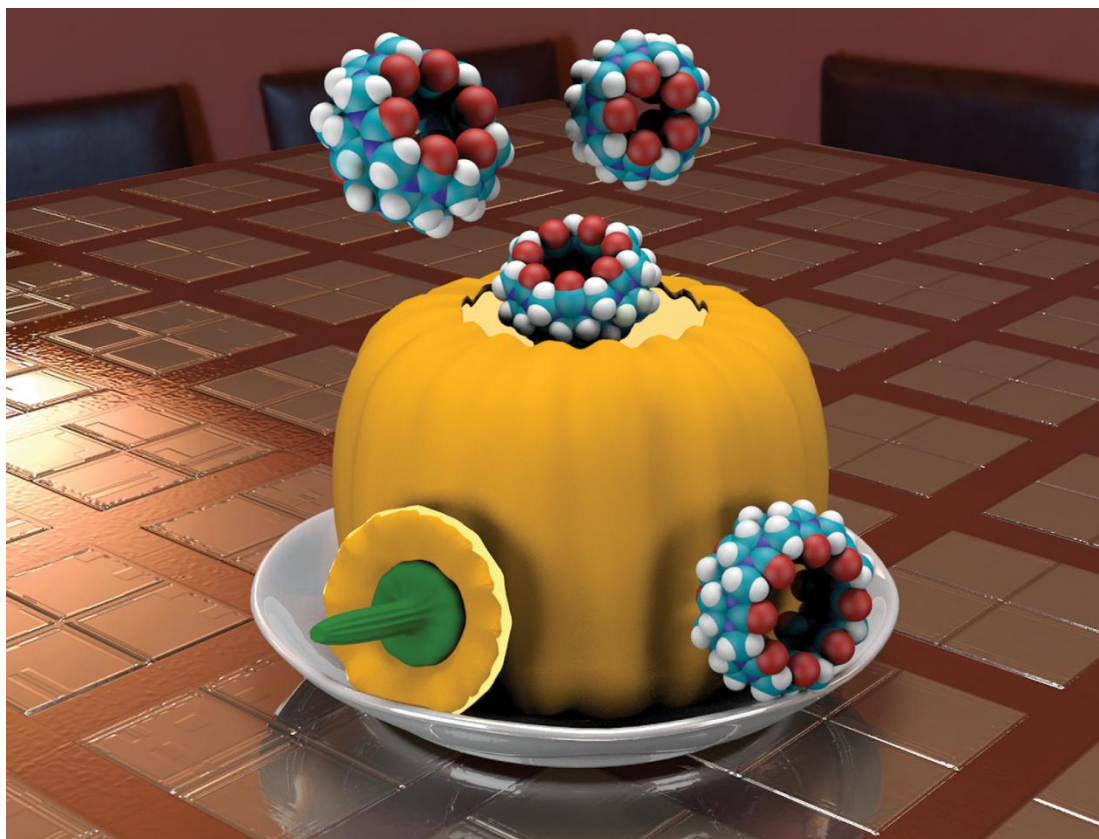



# Recettori per molecole neutre

Legami idrogeno **siti D A multipli**

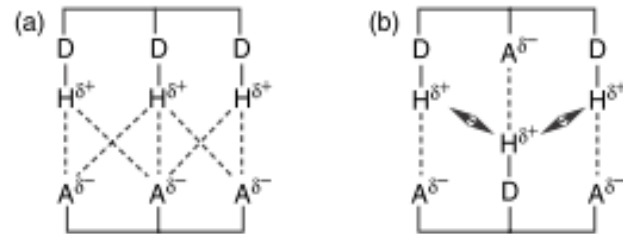

D Donor

A Acceptor

----- Attractive interaction

↔ Repulsive interaction

# Recettori per molecole neutre

Legami idrogeno preorganizzazione e complementarietà  
(direzionale)

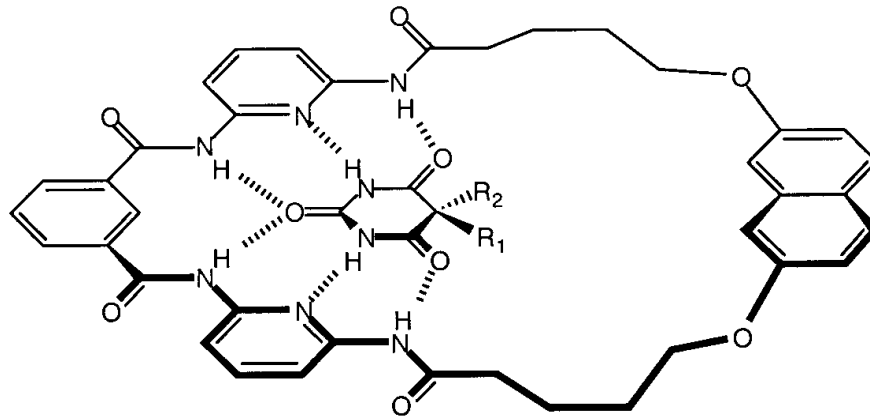

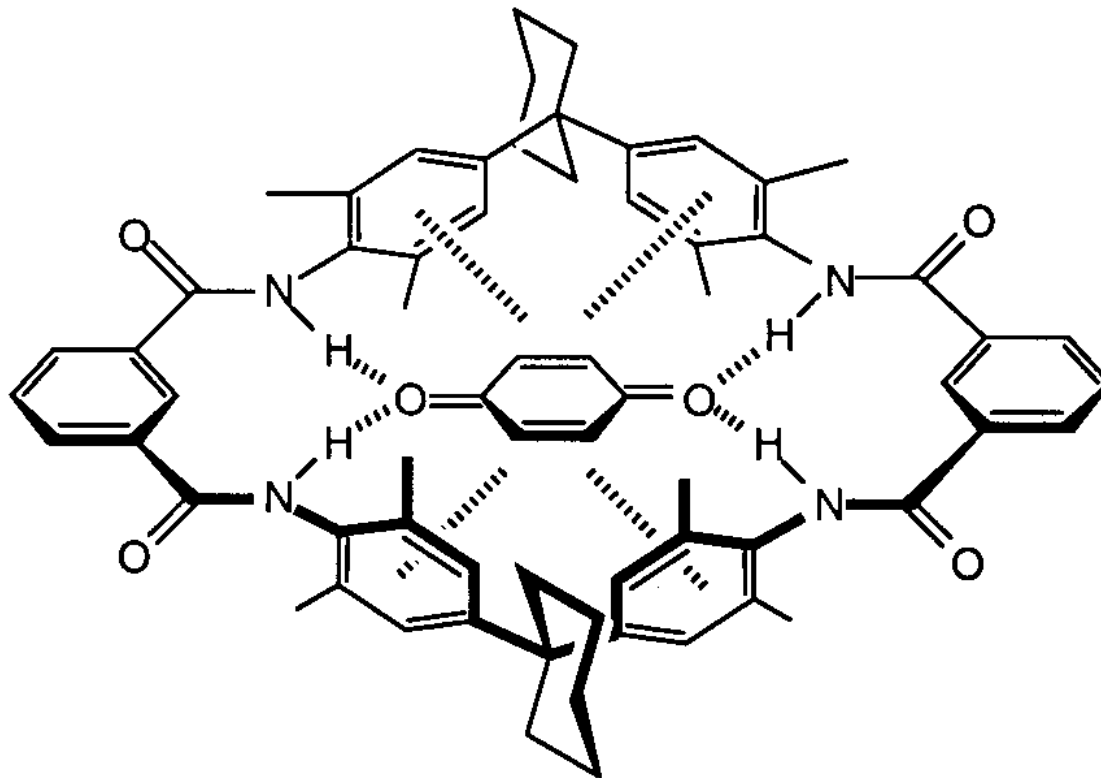

Receptor for benzoquinone which alters the electronic properties of the guest.