

# Tettonica a zolle, il sistema e i tipi di margini di placche

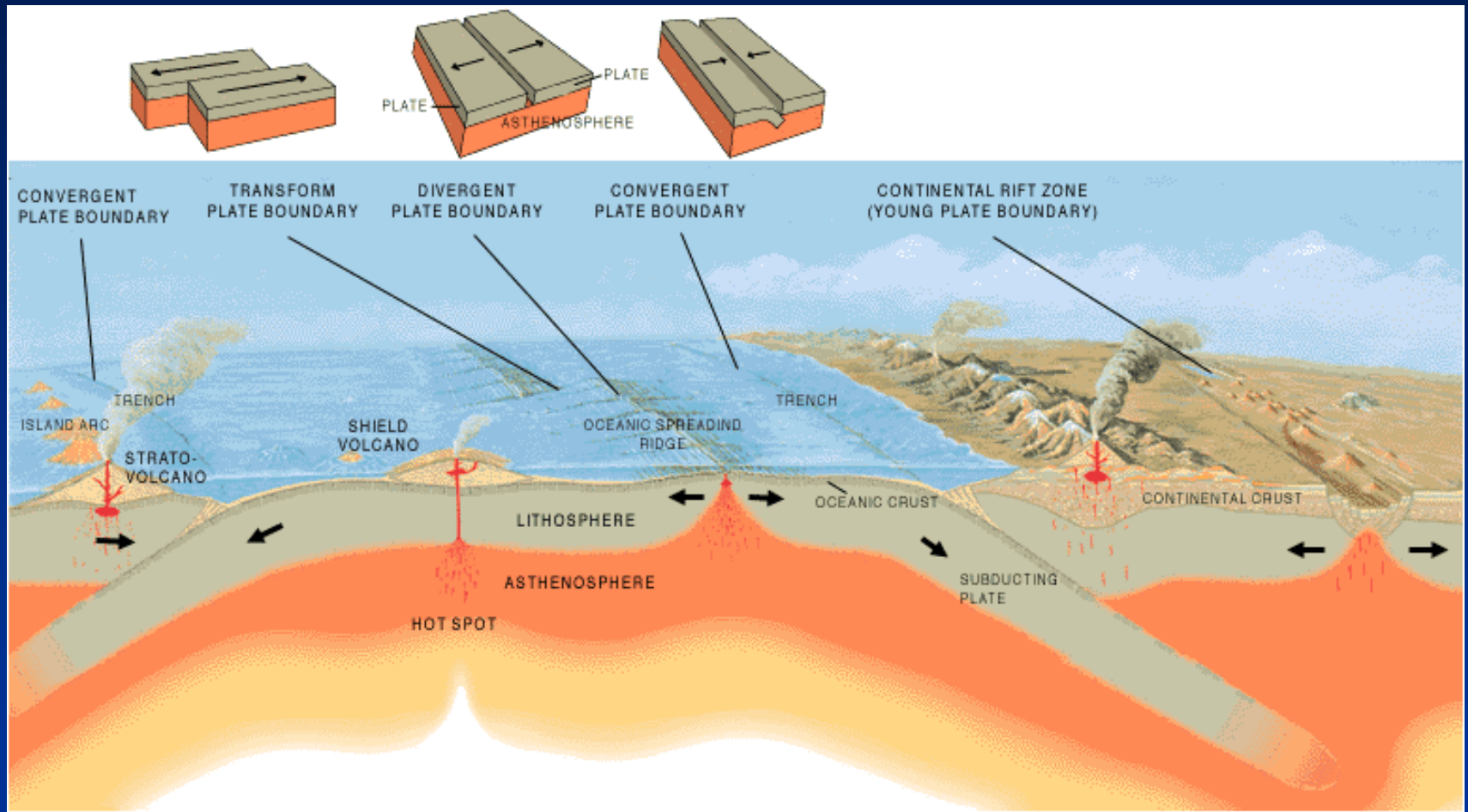

Da "The dynamic Earth" in USGS Web Site

# Tettonica diapirica

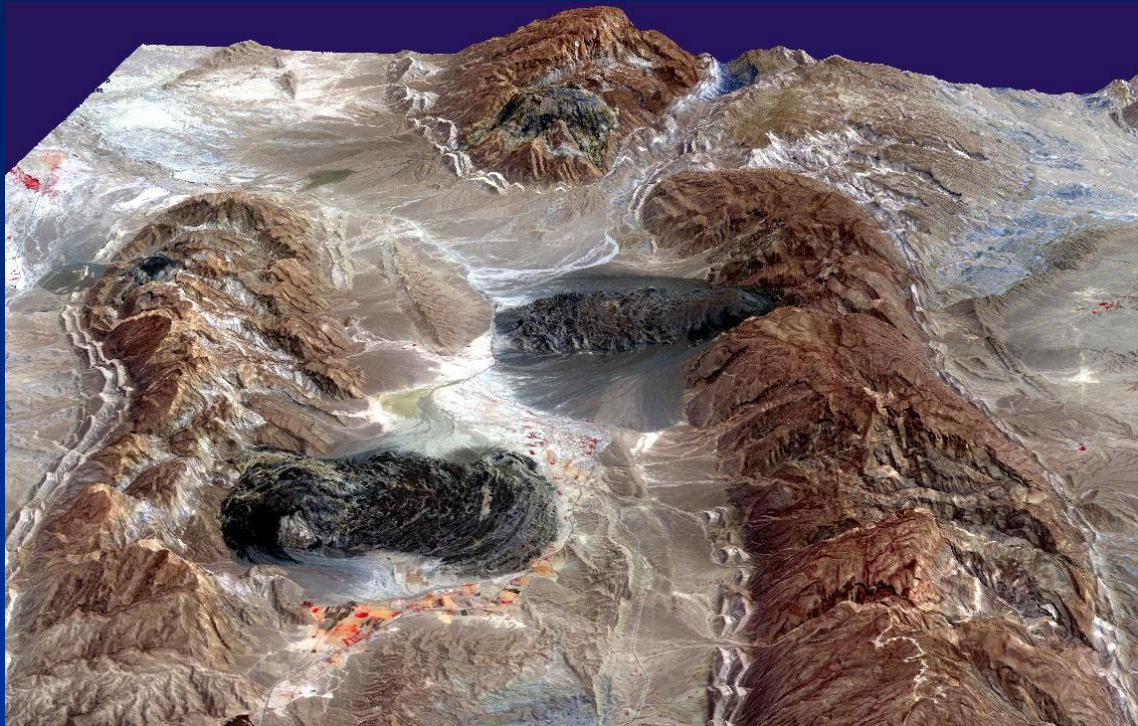

Salt glacier da diapiri salini

Da Earth observatory NASA

Immagine da NASA/GSFC/MITI/ERSDAC/JAROS, and U.S./Japan  
ASTER Science Team

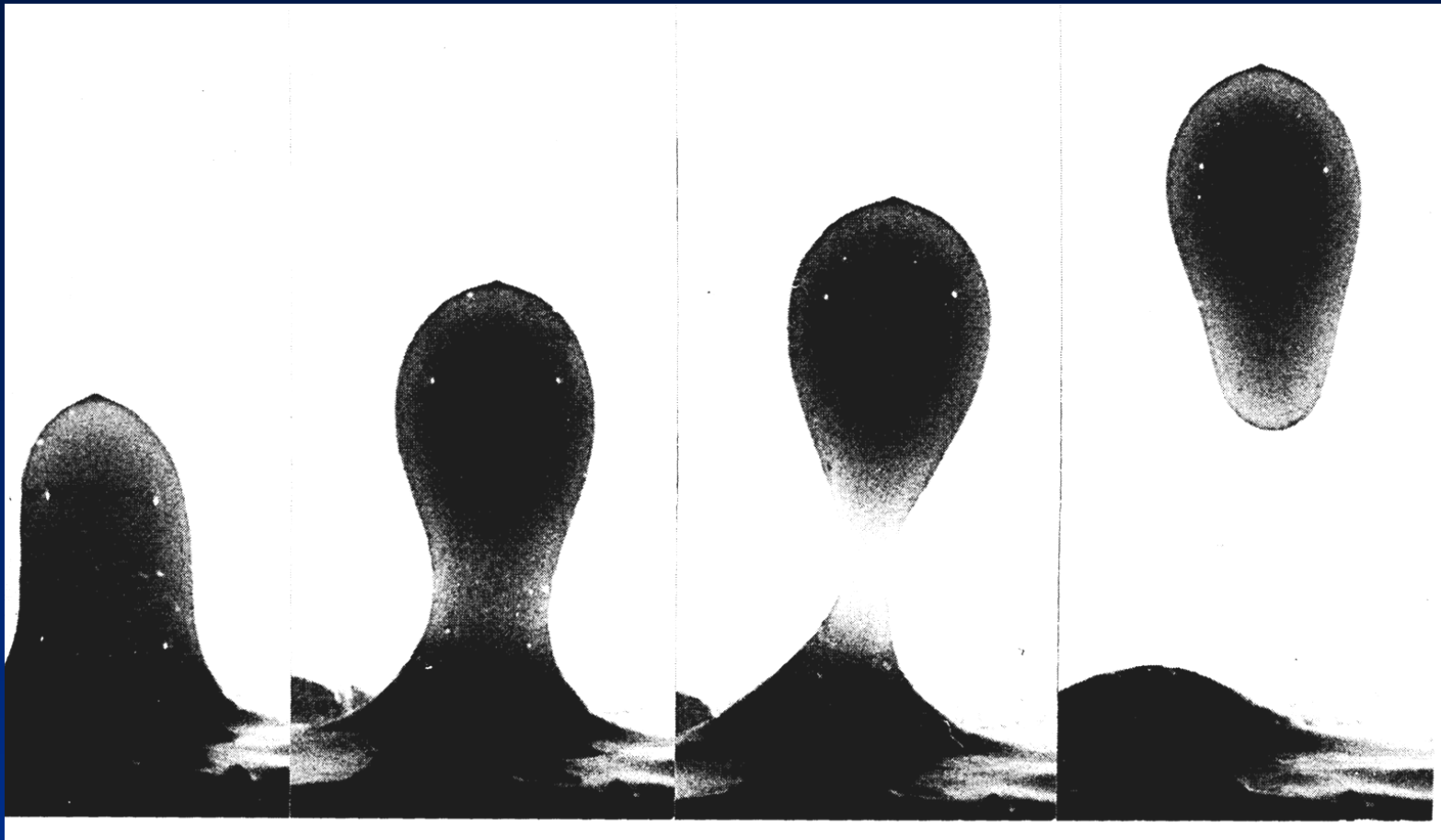

Da Price & Cosgrove, 1990

Si innesca per differenziale di carico quando si attua inversione di densità in profondità. Esempio di risalita di gocce meno dense del liquido chiaro.

# Tettonica diapirica

Salgemma = diapirismo o halocinesi, legata alla densità e alla mobilità del salgemma.

Gesso = diapirismo reale?, legato alla densità, ma mobilità del gesso è limitata (roccia fragile, sino a quando non si trasforma in anidrite), con sensibile influenza della sovrappressione dei fluidi interstiziali.

Fango = “pseudodiapirismo” governato da sovrappressione dei fluidi interstiziali.



Image © 2011 GeoEye  
Image © 2011 DigitalGlobe  
Data SIO, NOAA, U.S. Navy, NGA, GEBCO  
© 2011 Cnes/Spot Image  
27°17'24.43" N 54°38'29.65" E elev 1661 ft

© 2010 Google

Eye alt 154.27 mi



Image © 2011 GeoEye  
Image © 2011 DigitalGlobe

© 2010 Google

Imagery Dates: Mar 13, 2006 - Sep 6, 2009

© 2011 Cnes/Spot Image  
27°56'19.95" N 64°54'22.65" E elev 2309 ft

Eye alt 26.96 mi

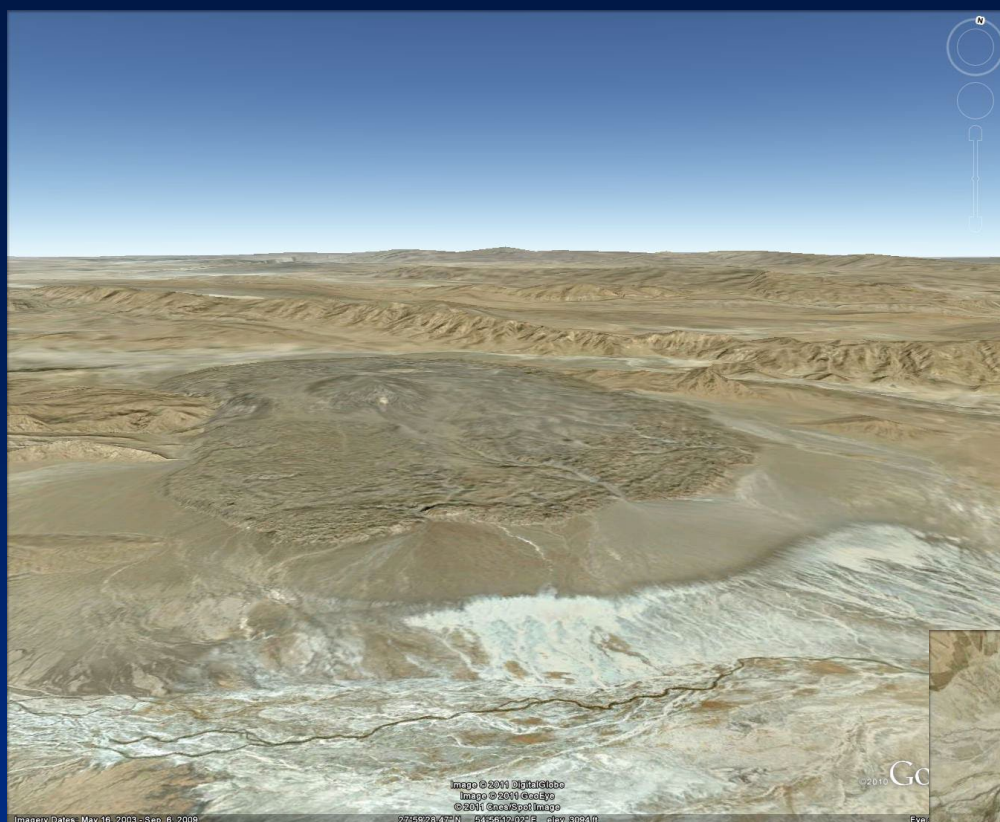

Image © 2011 DigitalGlobe  
Image © 2009 GeoEye  
© 2011 CoreSpot Image

Google

Imagery Dates: May 16, 2003 - Sep 6, 2009

57°49'28.47"N 64°56'12.02"E elev 8392m

Eye alt: 10684m



Image © 2011 DigitalGlobe  
Image © 2009 GeoEye  
© 2011 CoreSpot Image

Google

Imagery Dates: Mar 13, 2006 - Sep 6, 2009

28°00'00.95"N 94°54'39.91"E elev 4281m

Eye alt: 10684m

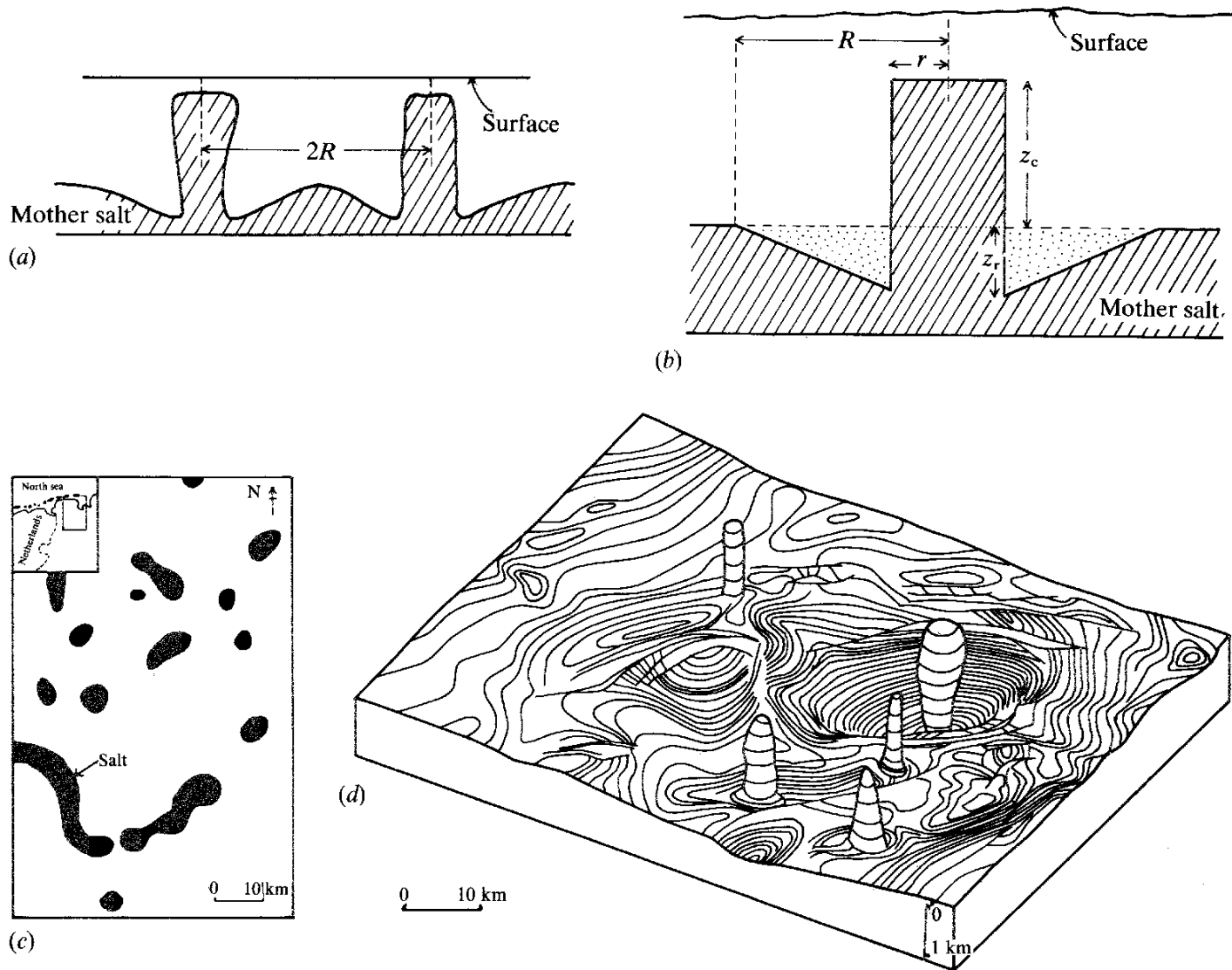
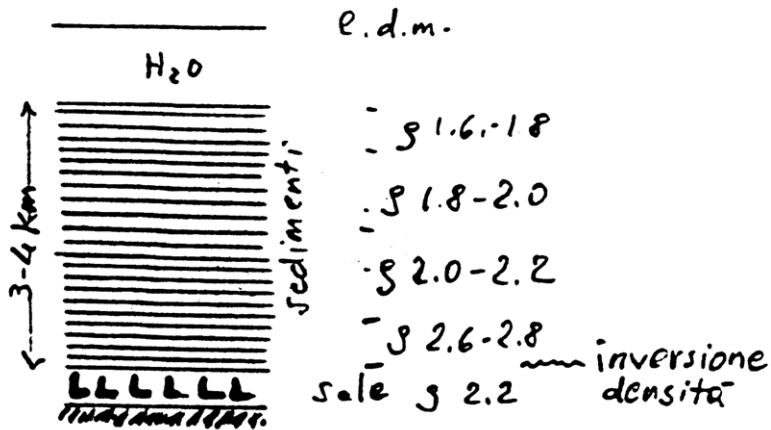
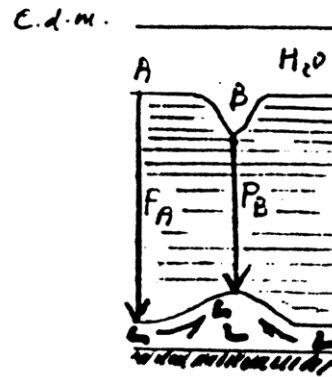

Fig. 4.13. (a) Schematic representation of section through two adjacent, bollard-type plugs. (b) Simplified geometry of salt layer and plug. (c) Distribution of Salt Domes in a small area of N. Germany. (After Turcotte & Schubert, 1982.) (d) Block diagram of salt plugs piercing the top of the Woodbine whose structure contours are shown. (After Jackson & Seni, 1983.)





② CONDIZIONI DI HALOCINESI POTENZIALE



③ CONDIZIONI DI HALOCINESI EFFETTIVA (differenza di carico litostatico  $P_B < P_A$  ad es. per formazione di canyon erosivo)

Fig. 190 - ①, ②, ③. Condizioni meccaniche per la formazione di diapirī

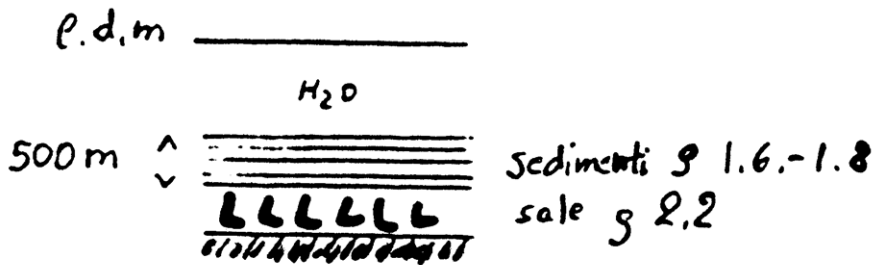

① NO HALOCINESI

Da Selli L., appunti dalle lezioni di Geologia Strutturale

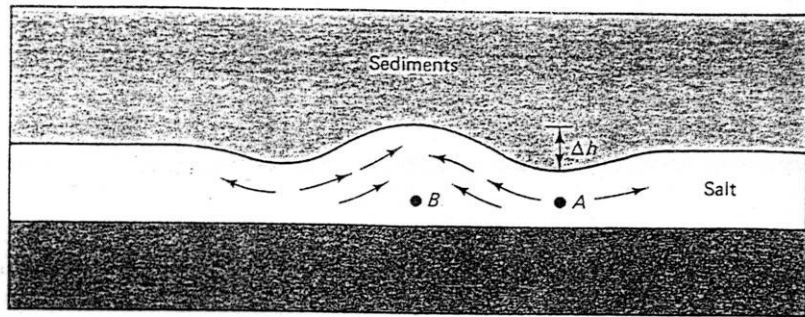

(a)

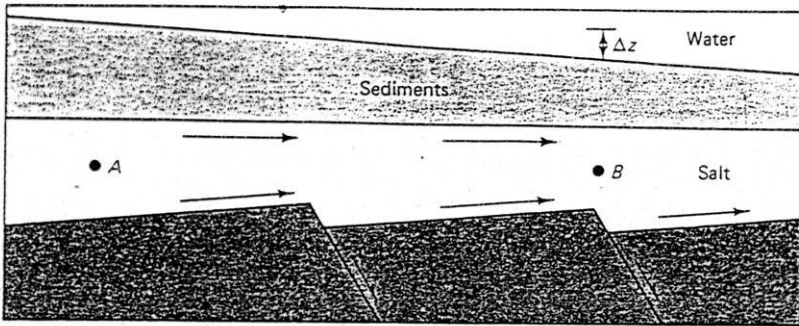

Migrazione del sale  
verso le zone con meno  
carico litostatico

Da Suppe, 1985

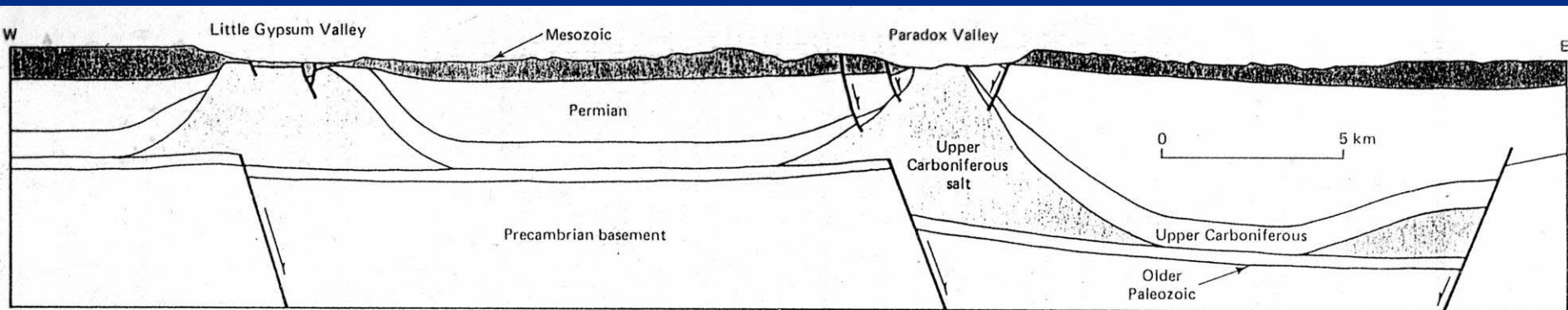

Da Suppe, 1985

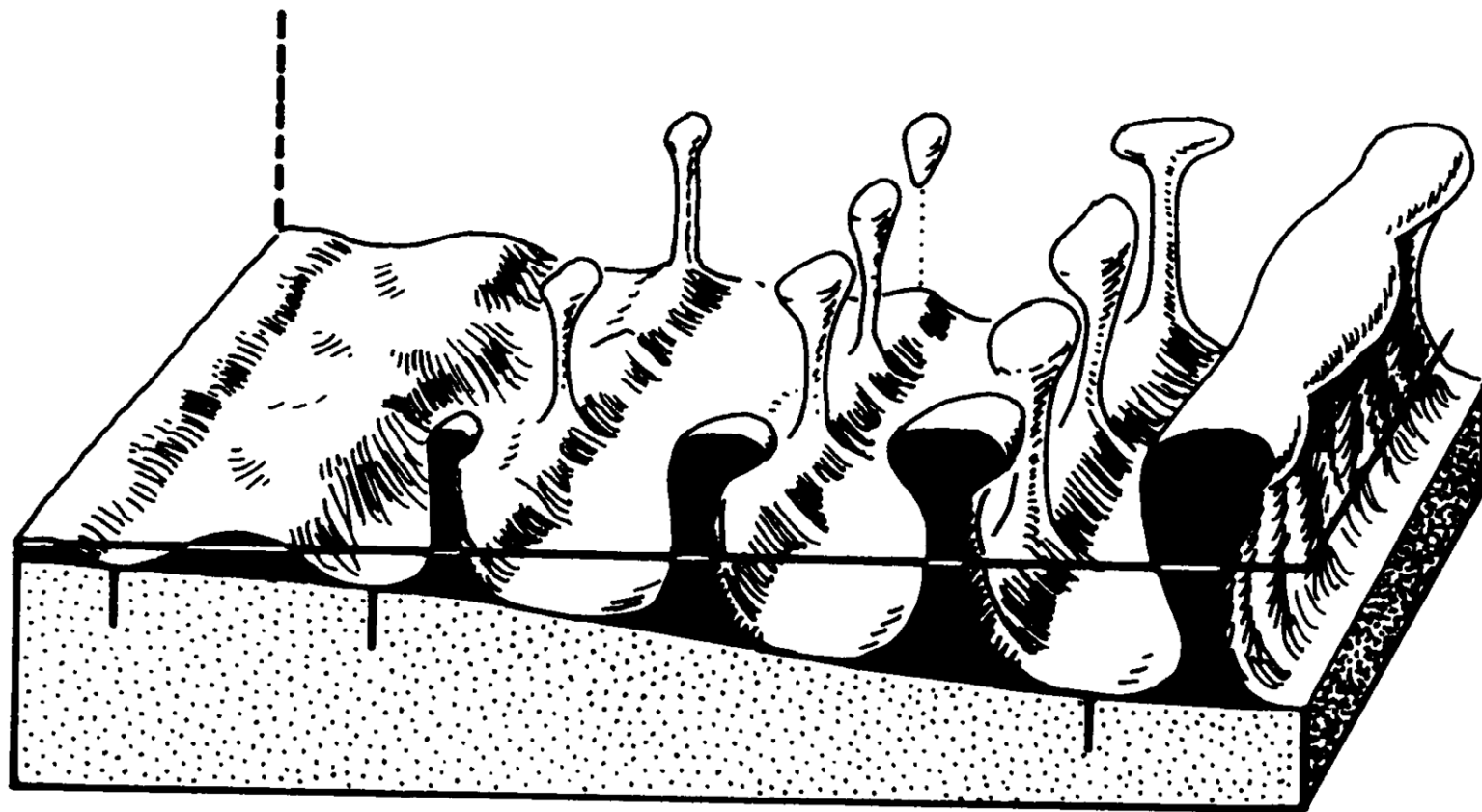
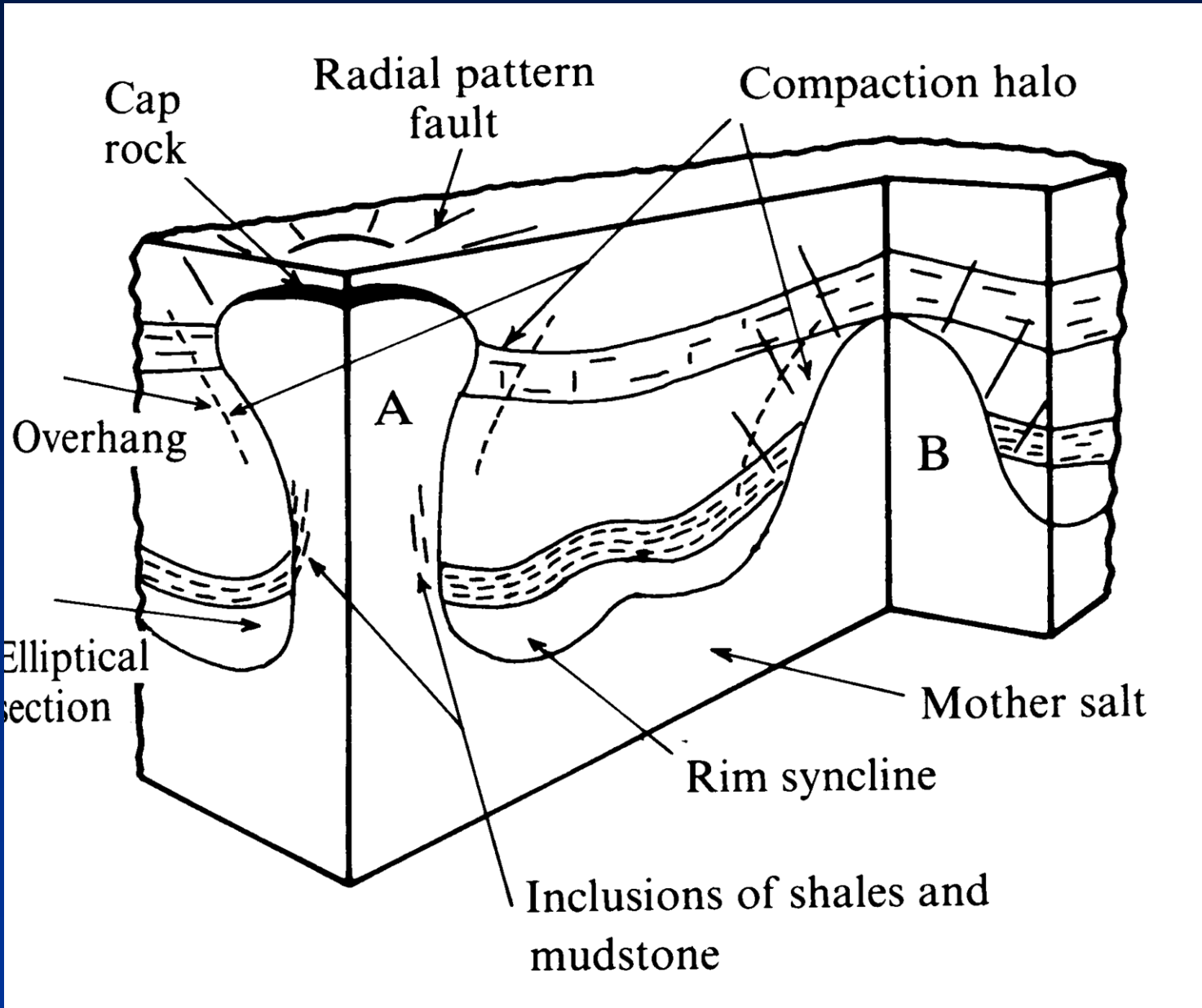

Fig. 4.7. General morphology of salt pillows, walls and domes.  
(After Trusheim, 1960.)

Da Price & Cosgrove, 1990

Densità del salgemma 2,16  
gesso 2,3



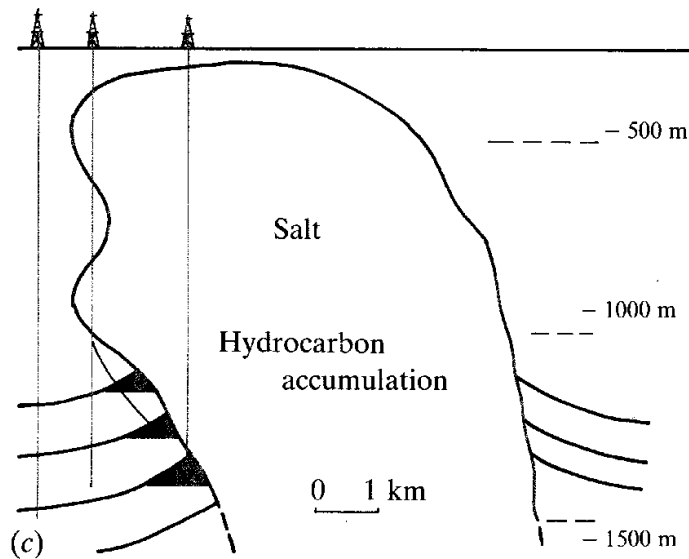
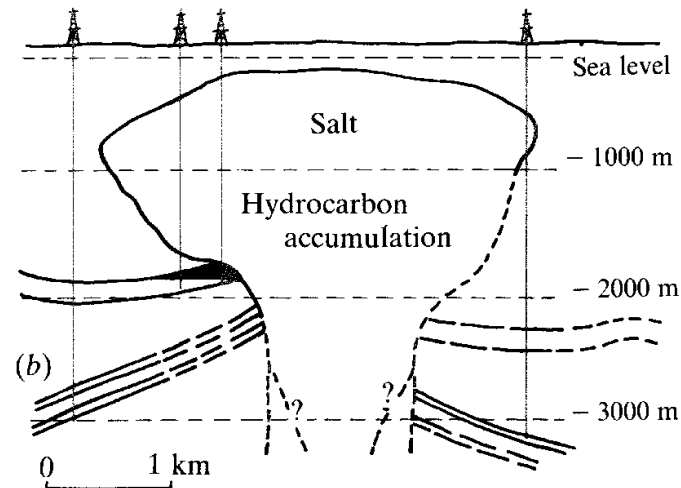
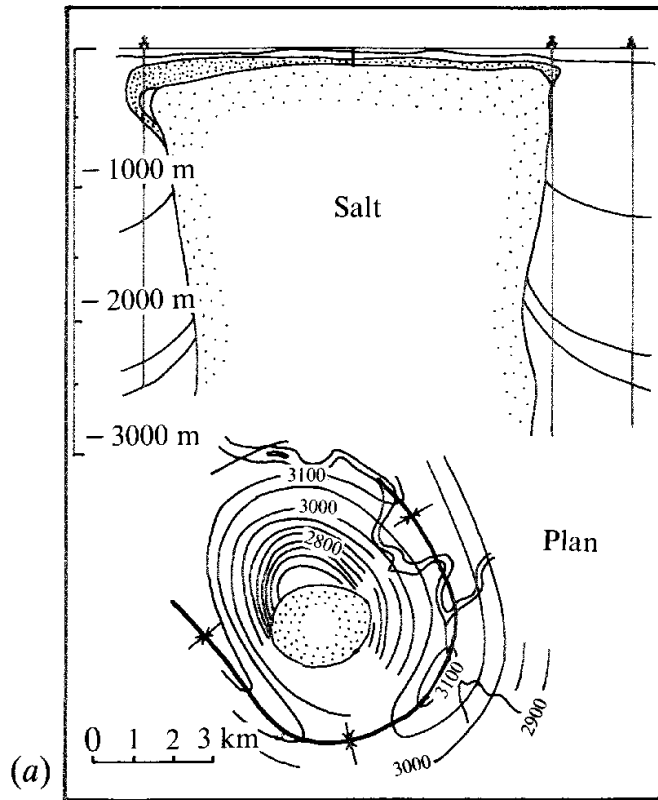

Fig. 4.8. Profiles indicating morphology of a variety of real salt domes or plugs (a) Zanapa Dome, Mexico. (b) Bethel Dome, Texas, U.S.A. (c) Cote-blanche Dome, Louisiana, U.S.A. ((b) and (c) after Halbouty, 1967).

Trappole per  
idrocarburi

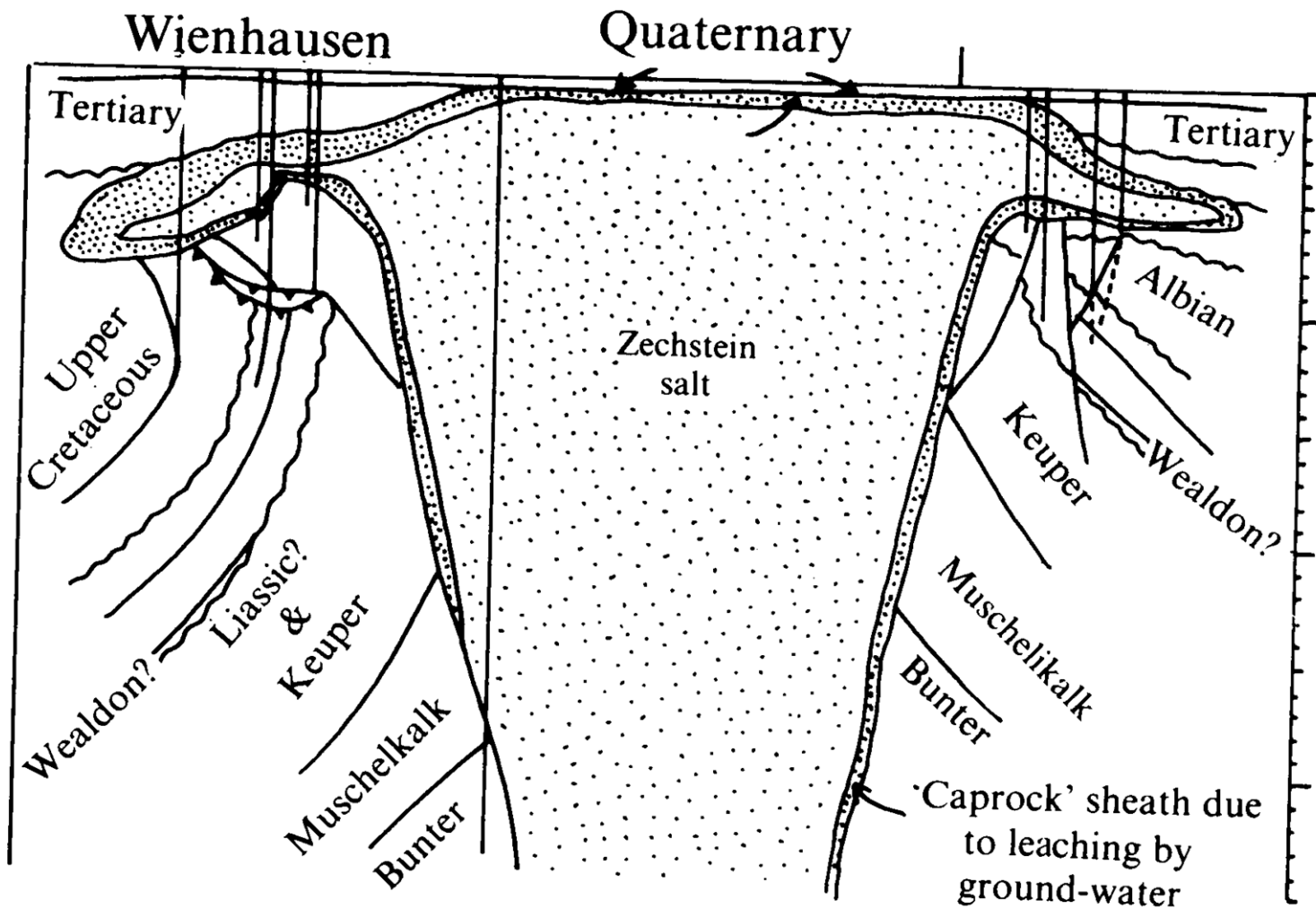

Fig. 4.25. Section through the Wienhausen Salt Plug, N.W. Germany. (From Gussow, 1968; after Schott, 1956.)



. 4.10. Sketch of vertically plunging folds revealed in the galleries of a salt mine. (After Balk, 1953.)

Da Price & Cosgrove, 1990



N

Image © 2011 DigitalGlobe  
Image © 2011 GeoEye  
© 2011 Cnes/Spot Image

© 2010 Google

Imagery Dates: Mar 13, 2006 - Sep 6, 2009

28°00'00.95" N 54°54'35.91" E elev 4281 ft

Eye alt 10.84 mi



# Vulcani e diapiri di fango, grifoni, salse





Toragai mud volcano, Azerbaijan  
(500 m high)



Da Phil Hardy, BBC, 2001



Google Earth  
© 2011 Google

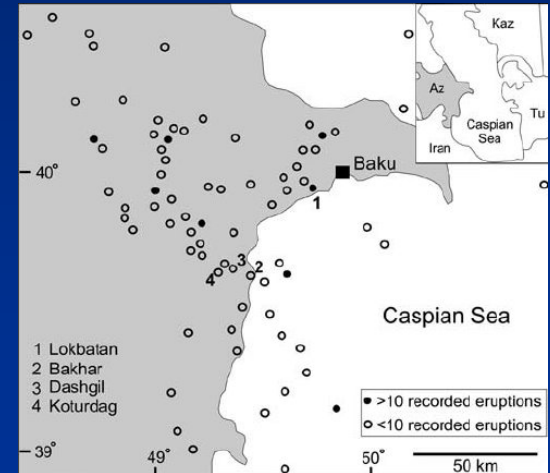

Qobustan National  
Park, Azerbaijan

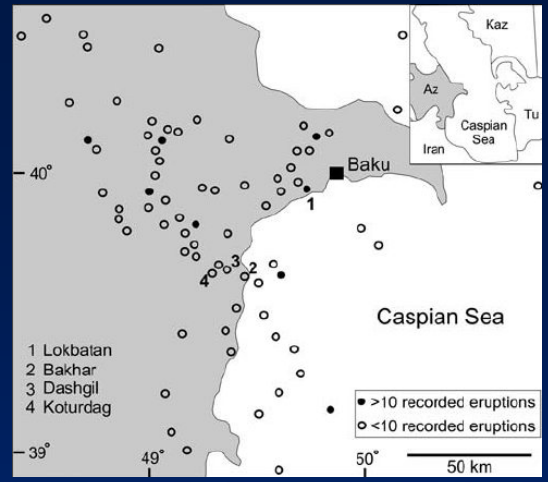
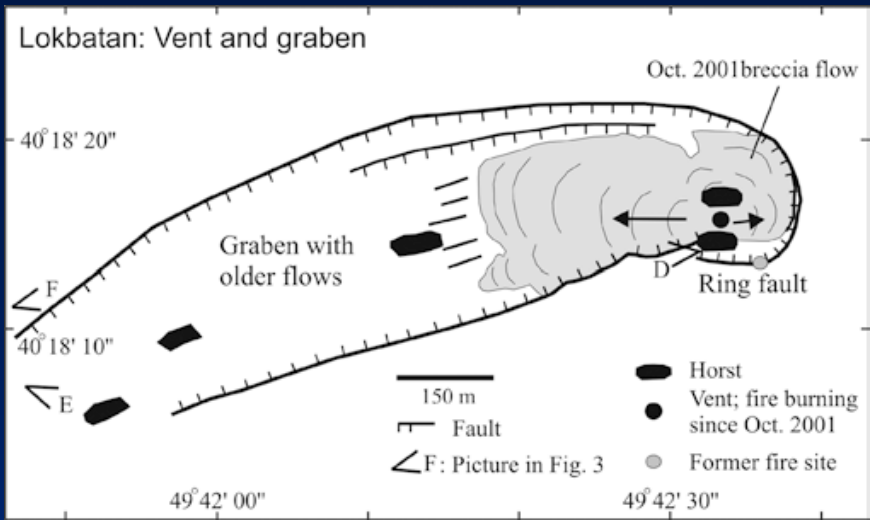

Da Planke et al., 2003

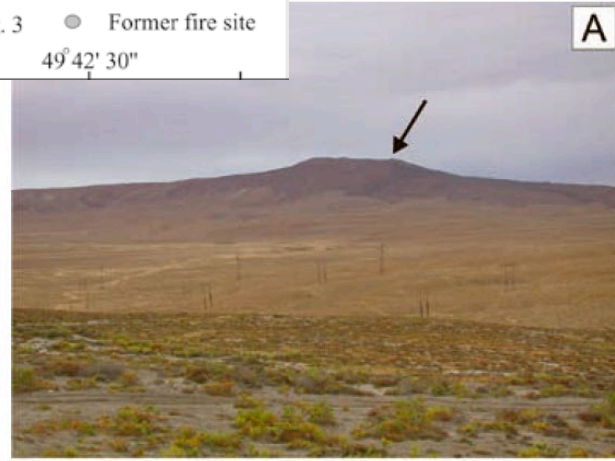

Qobustan National Park, Azerbaijan

# Vulcani di fango nel prisma di accrezione, Barbados

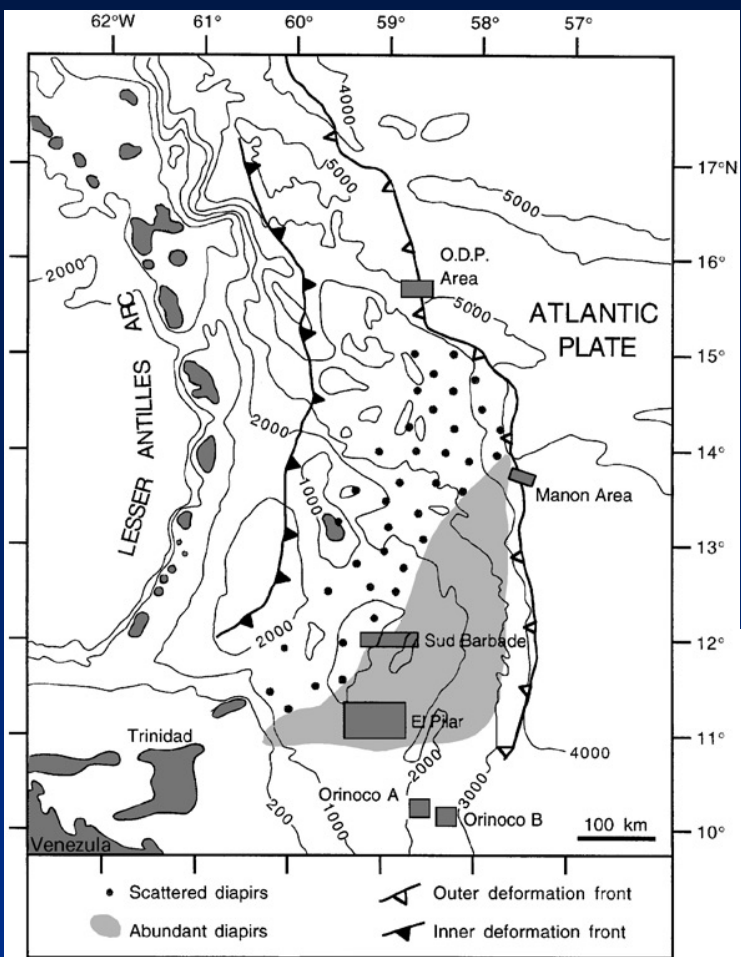

Da Aloisi et al., 2002

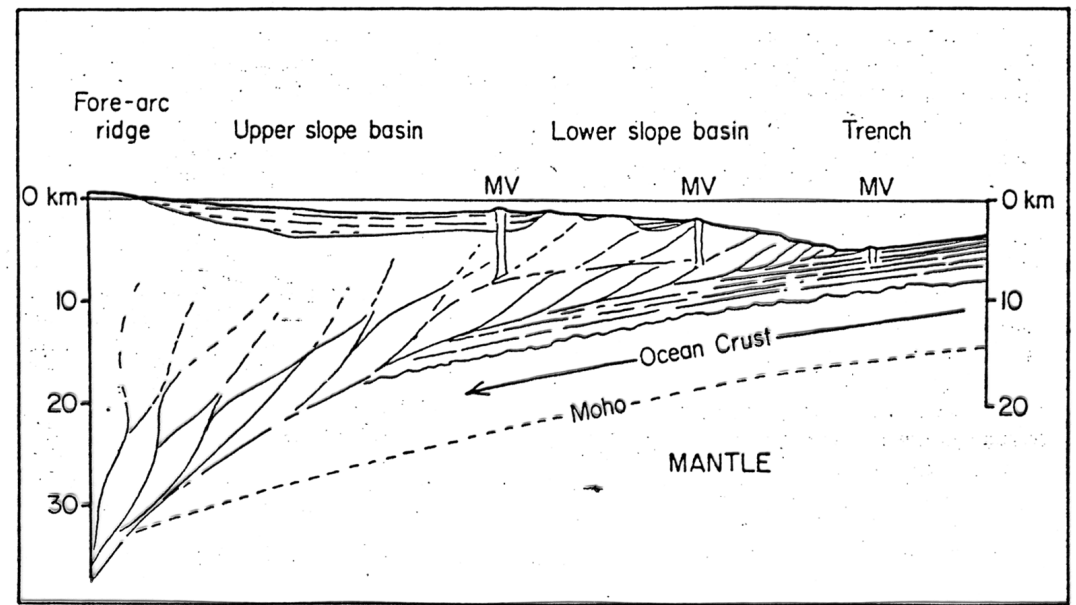

Da Barber & Brown, 1988

# Vulcani di fango nel prisma di accrezione, Barbados

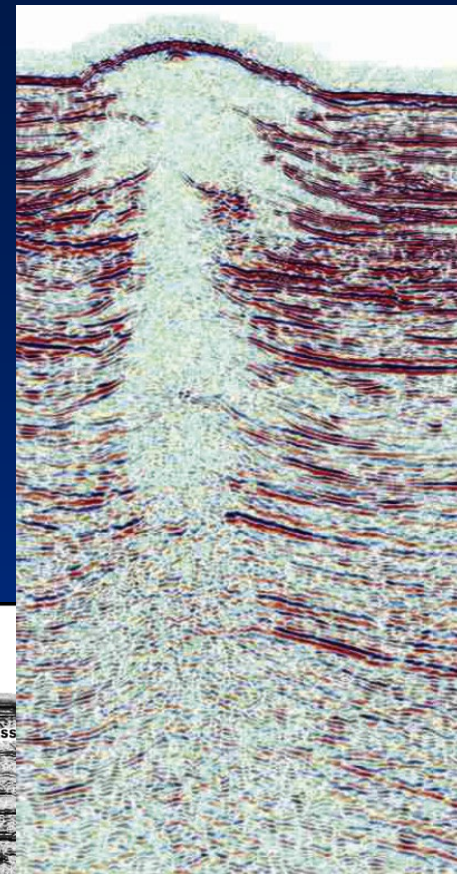
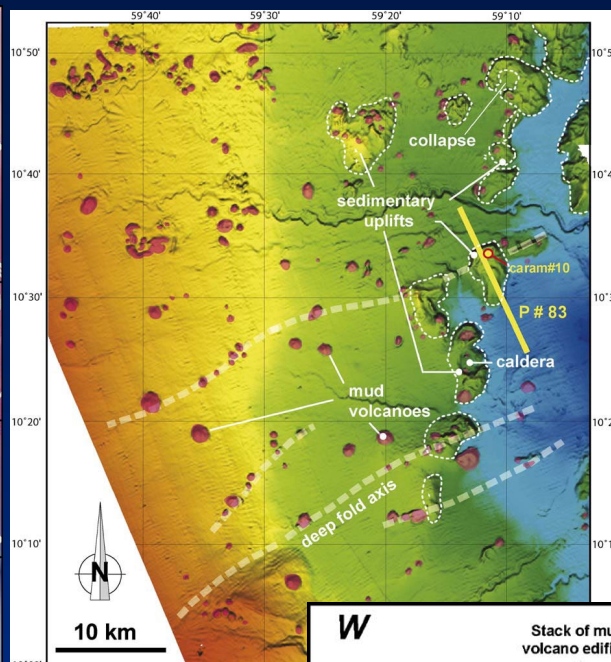
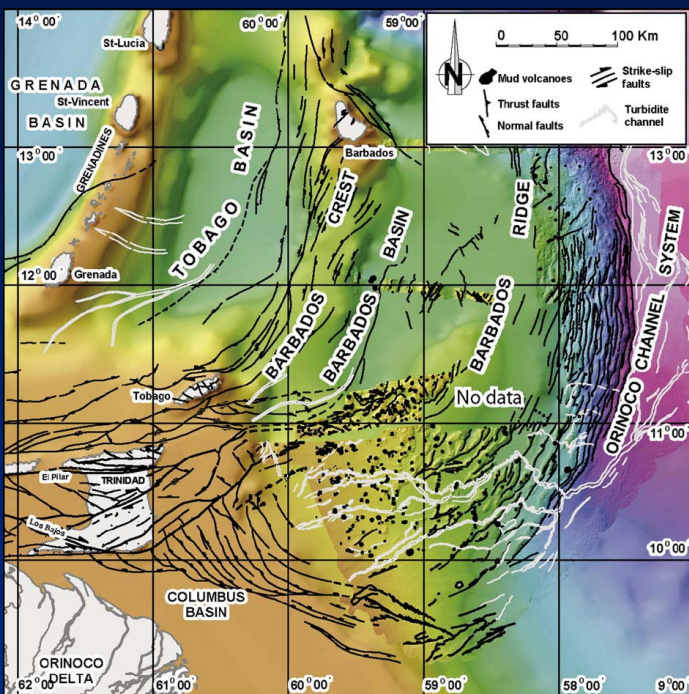

Da Deville, 2009

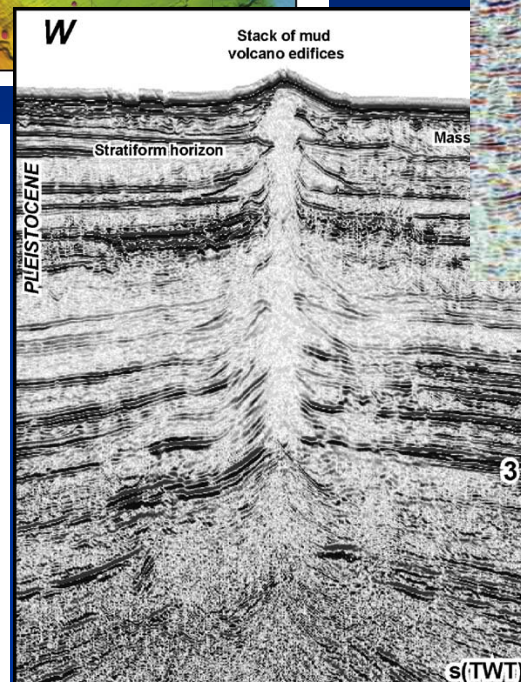
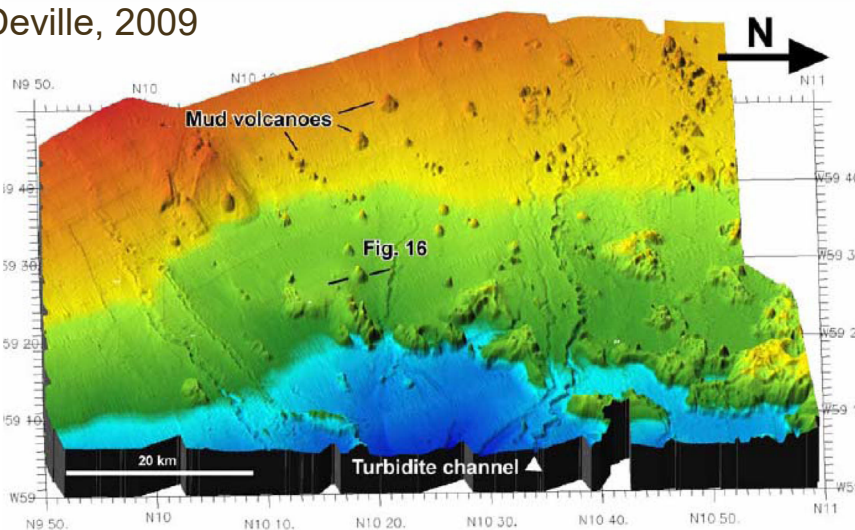

Da Wood, 2012

Da Deville et al. 2007

Figure 2. Field of mud volcanoes in the eastern continental slope of the offshore of Trinidad.

# Diapiri di fango in avanfossa, Barbados

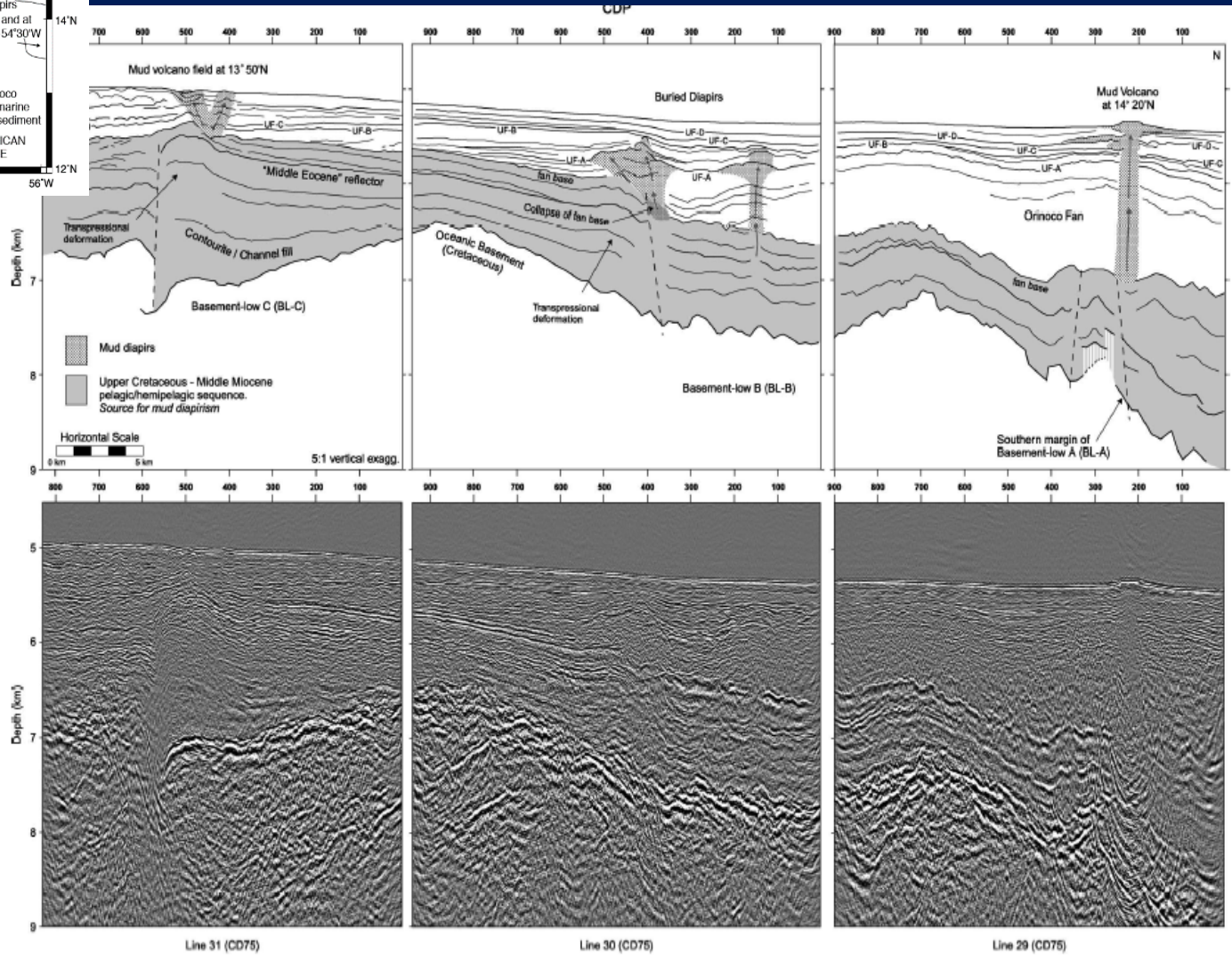
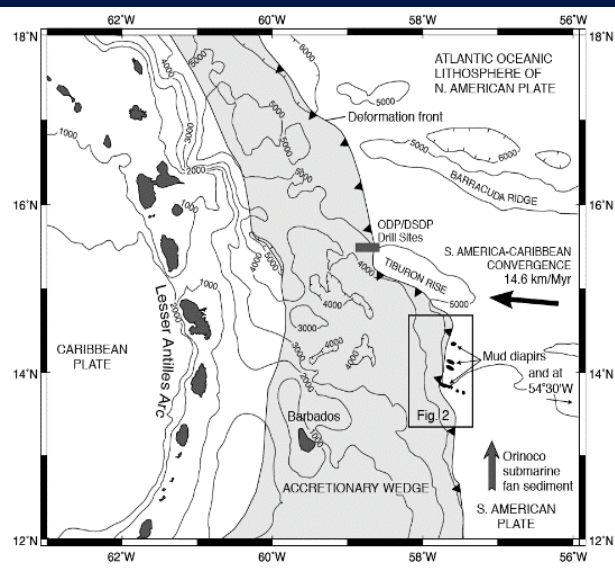

Sumner & Westbrook, 2001. *Marine and Petroleum Geology*, 18, 591-613.

# Diapiri e vulcani di fango

## MUD VOLCANOES IN THE MEDITERRANEAN REGION

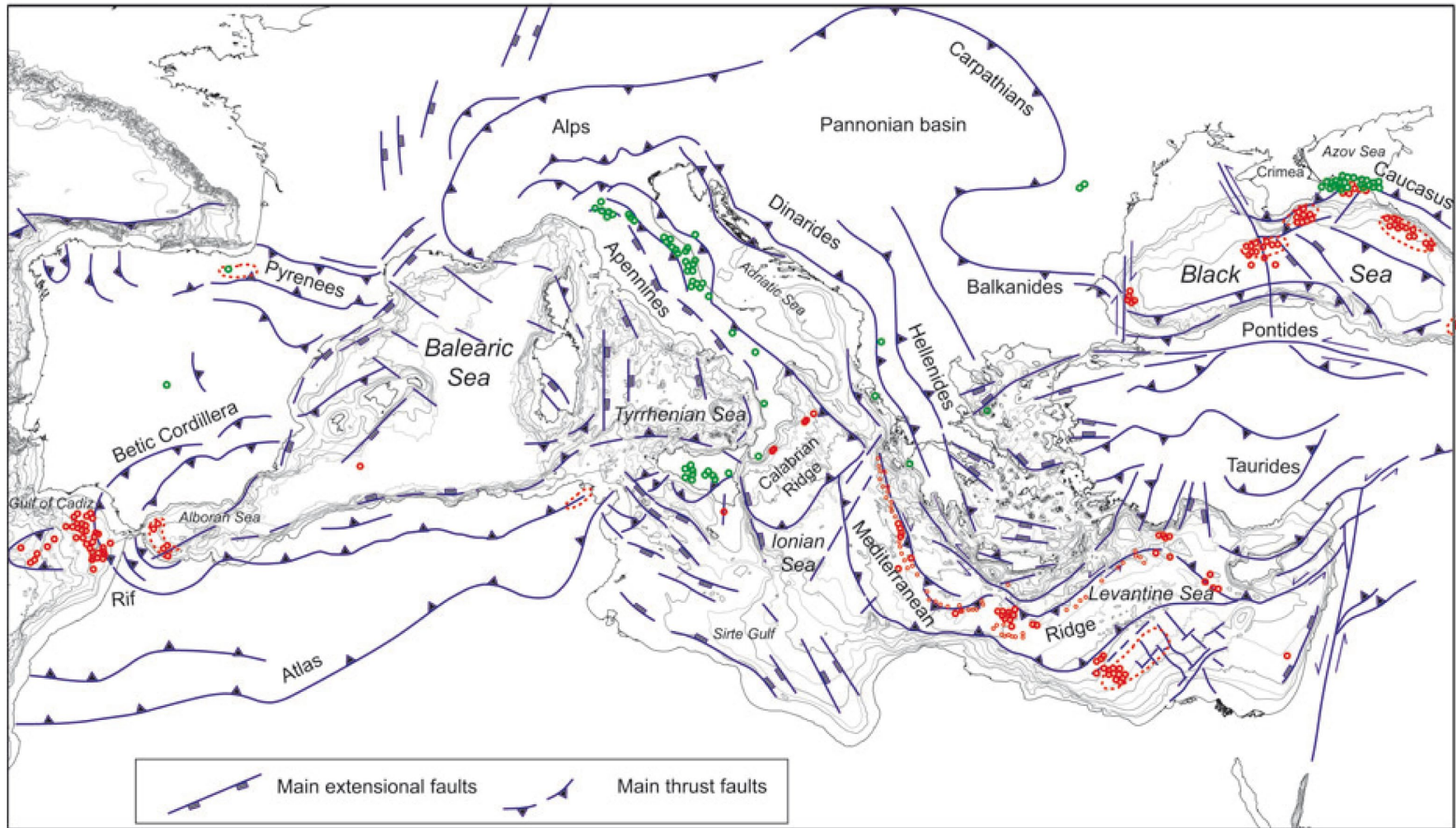

### KEY TO SYMBOLS AND COLOURS

- Active mud volcanoes on land
- Known submarine mud volcanoes
- Inferred submarine mud volcanoes (Fusi & Kenyon, 1996)
- Mud diapirism

Da Camerlenghi & Pini, 2009

# BLACK SEA MUD VOLCANOES

Da Krastel et al., 2003

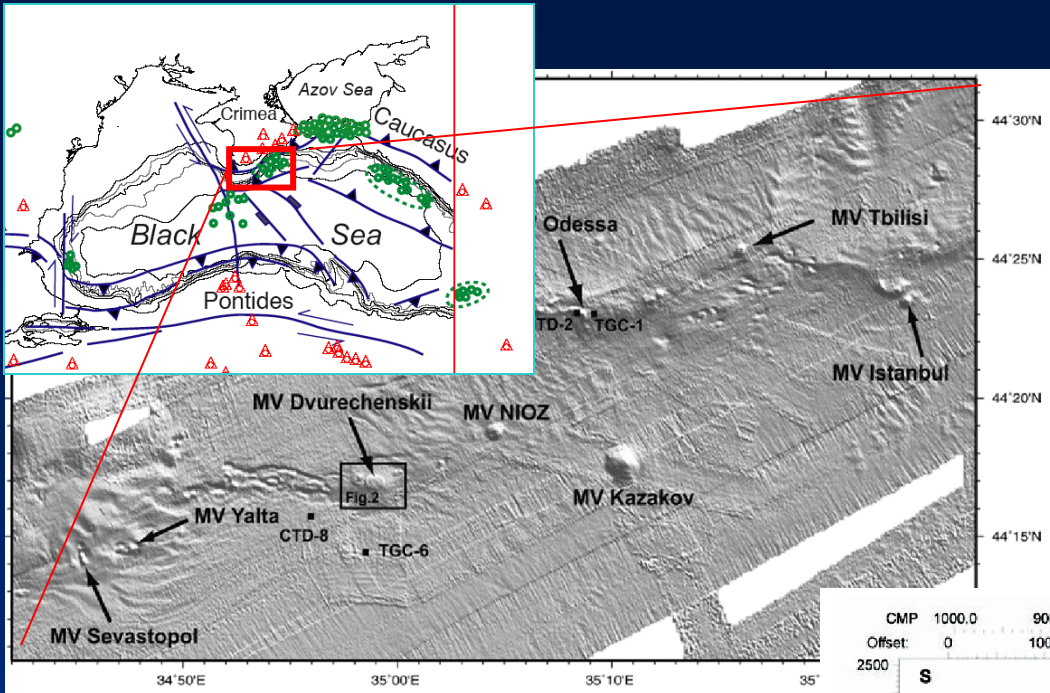

Da Bohrmann et al., 2003

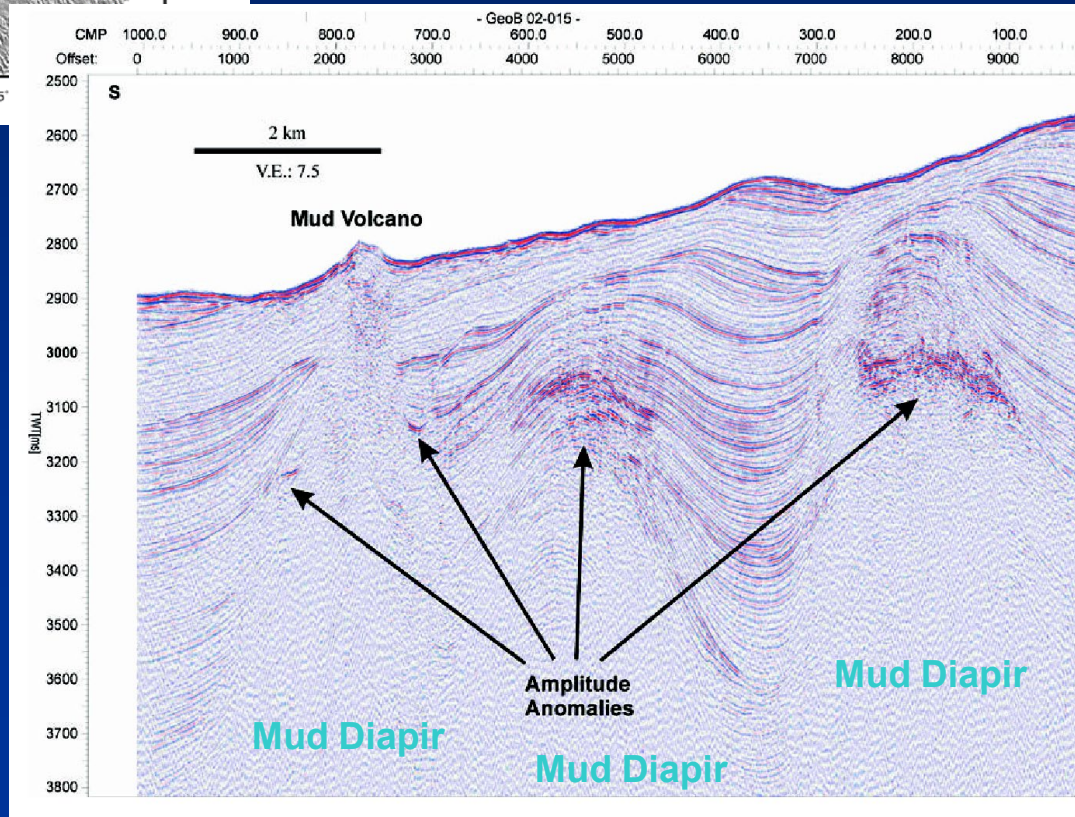

Courtesy of A. Camerlenghi



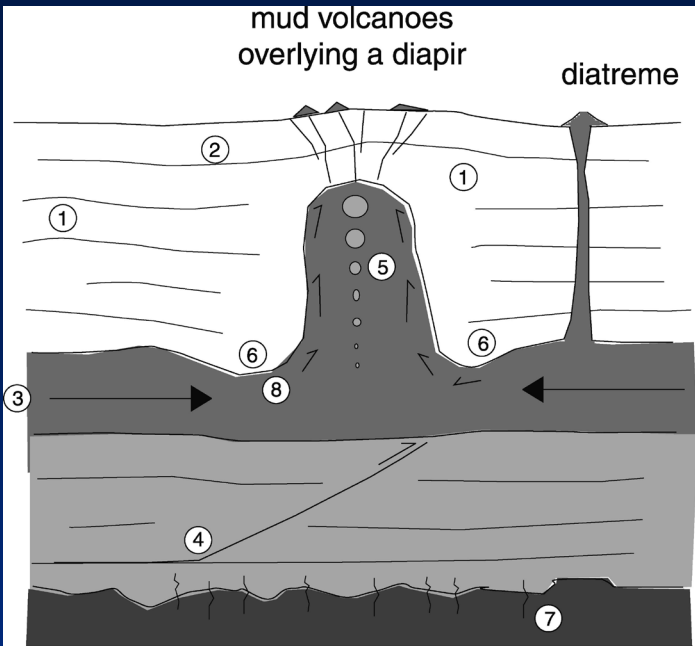

### fluid sources for overpressuring and mud extrusion:

- (1) pore fluid expulsion from compaction
- (2) biogenic methane from degradation of organic matter
- (3) lateral fluid flux through stratigraphic horizons or fault zones
- (4) fluid migration along deep seated thrusts
- (5) thermogenic methane and higher hydrocarbons
- (6) fluids from mineral dehydration (opal, smectite)
- (7) hydrothermal fluids, alteration of crustal rock
- (8) fluid expulsion from internal deformation within the diapiric intrusion

Da Kopf, 2002

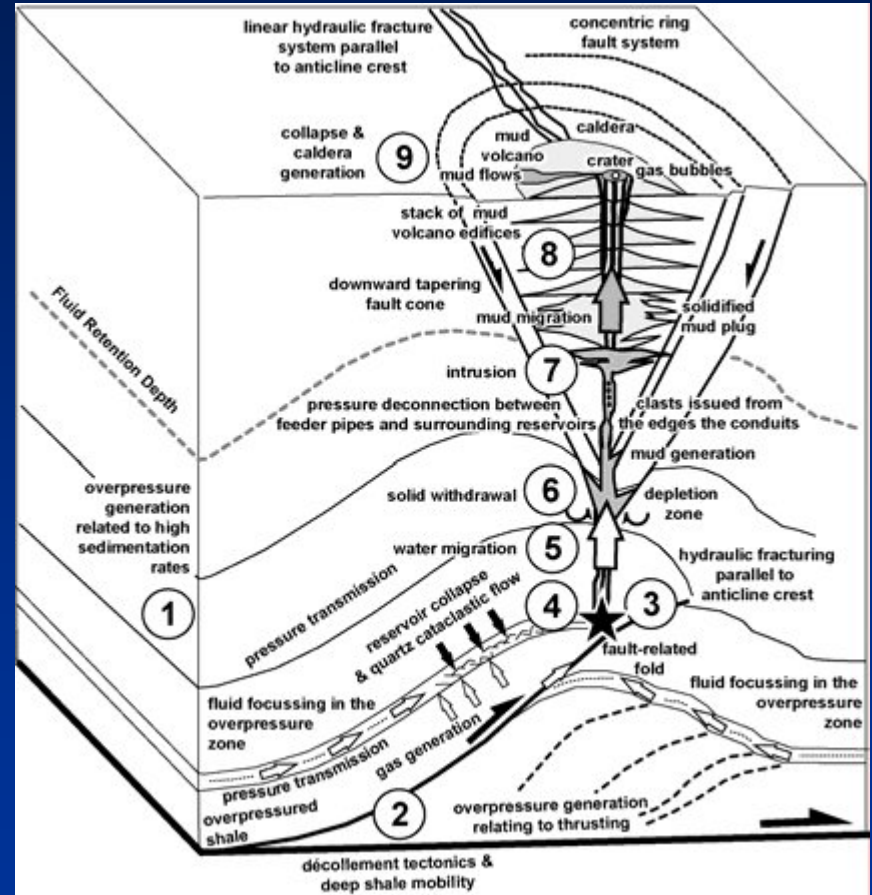

Da Deville, 2009

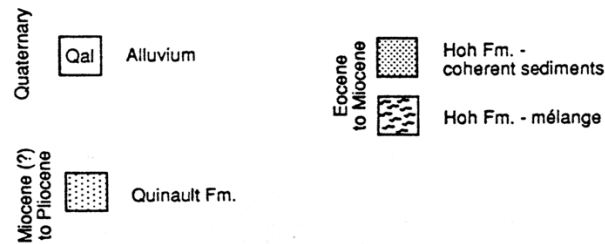
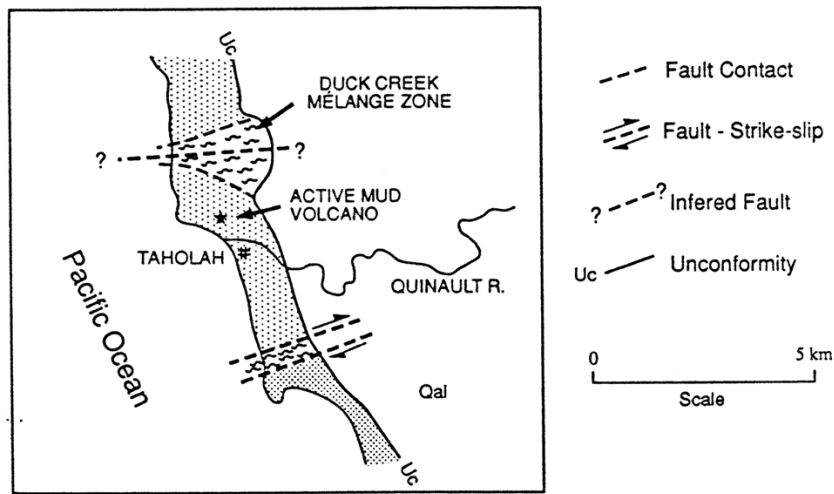
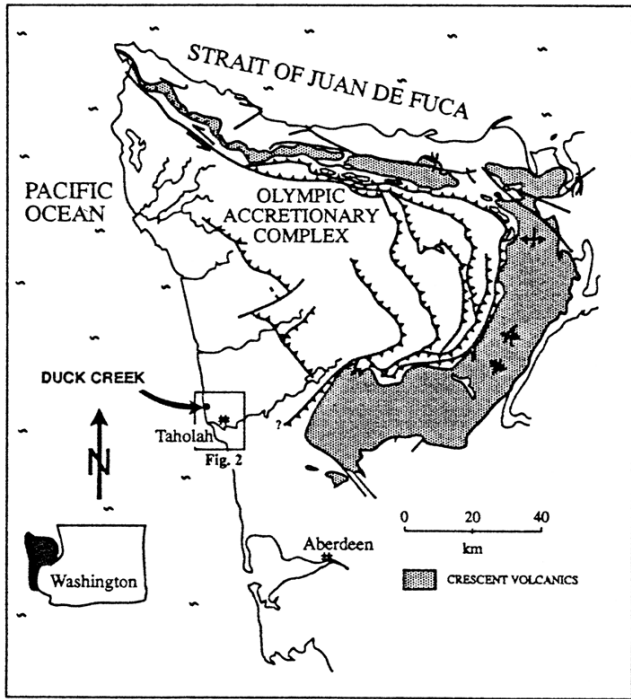

Brown & Orange, 1993

Fig. 1. Location of the Olympic Peninsula, Washington, U.S.A. The Duck Creek mélangé is located on the coast of the Peninsula approximately 10 km north of Taholah, near the southern limit of the exposed Olympic accretionary complex (after Tabor & Cady 1978, Snavley & Kvenvolden 1988).

## Duck Creek mélangé: un diapiri di fango

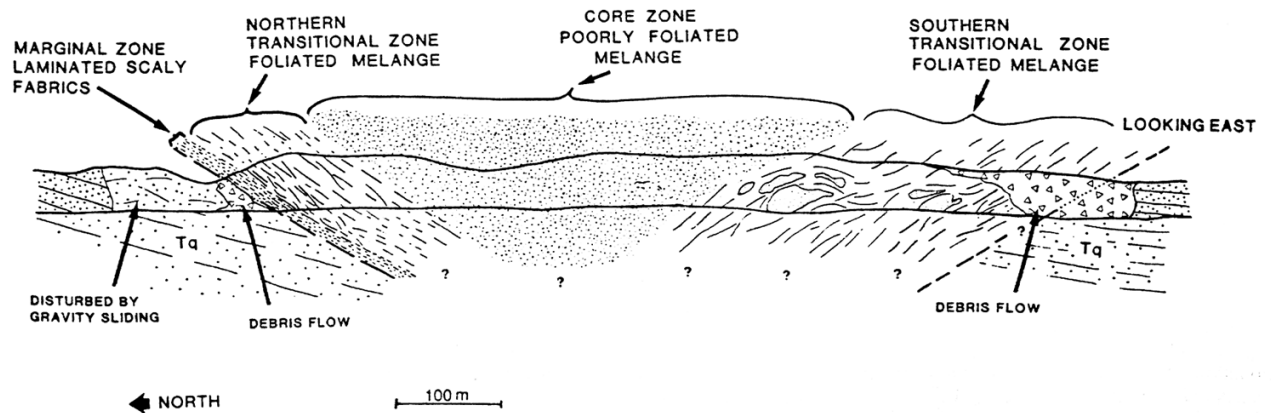

Fig. 4. Cross-section through the Duck Creek mélangé, view is to the east. With the exception of the slumped contacts, the mélangé has near 100% exposure along the steep 20 m sea cliffs. These steep exposures have the advantage of corresponding to a cross-section of the mélangé.

GAPini



GAPini



GAPint



GAPini



GAPini

