

272SM: Introduction to Artificial Intelligence

Constraint Satisfaction Problems



Instructor: Tatjana Petrov

University of Trieste, Italy

What is Search For?

- Assumptions about the world: a single agent, deterministic actions, fully observed state, discrete state space
- Planning: sequences of actions
 - The path to the goal is the important thing
 - Paths have various costs, depths
 - Heuristics give problem-specific guidance
- Identification: assignments to variables
 - The goal itself is important, not the path
 - All paths at the same depth (for some formulations)
 - CSPs are a specialized class of identification problems

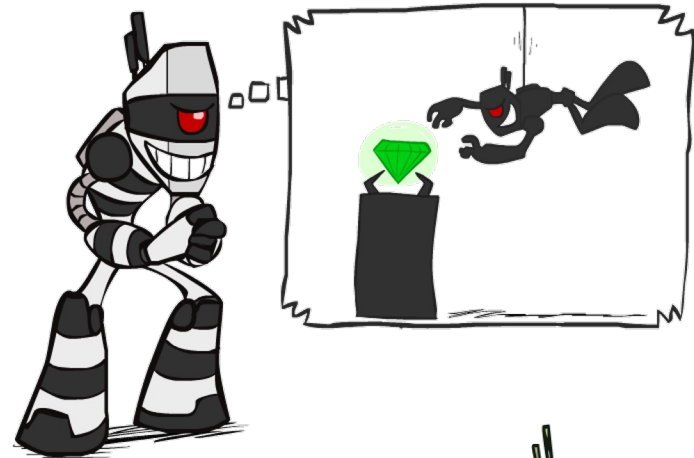

Constraint Satisfaction Problems

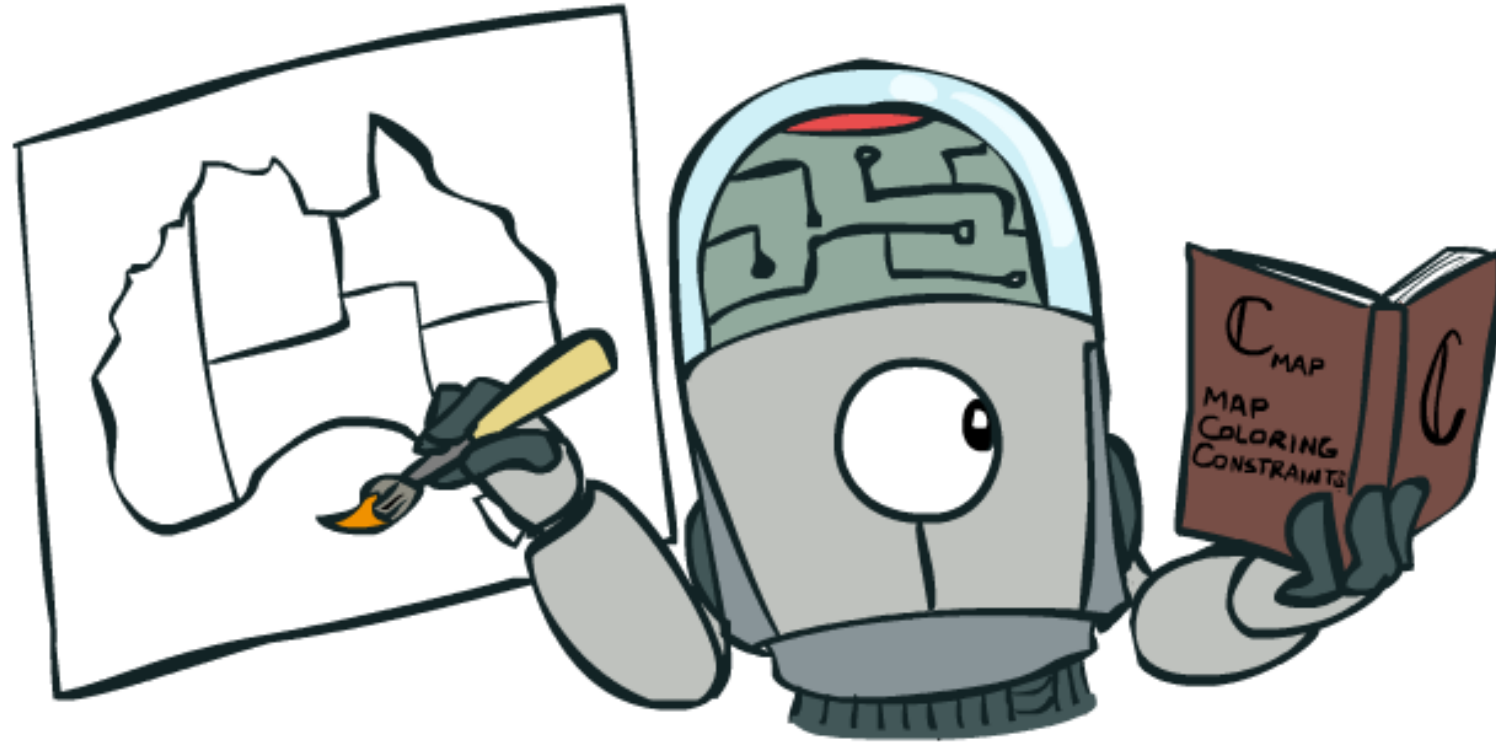

Constraint Satisfaction Problems

- Standard search problems:
 - State is a “black box”: arbitrary data structure
 - Goal test can be any function over states
 - Successor function can also be anything
- Constraint satisfaction problems (CSPs):
 - A special subset of search problems
 - State is defined by **variables X_i** with values from a **domain D** (sometimes D depends on i)
 - Goal test is a **set of constraints** specifying allowable combinations of values for subsets of variables
- Simple example of a *formal representation language*
- Allows useful general-purpose algorithms with more power than standard search algorithms

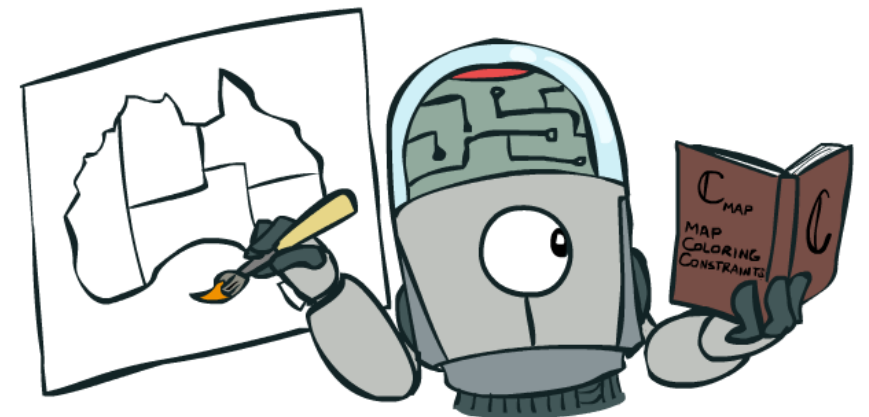
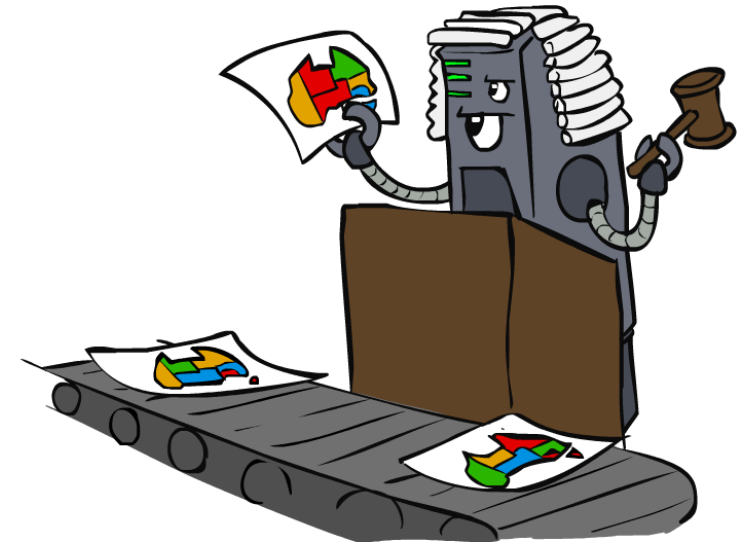

CSP Examples

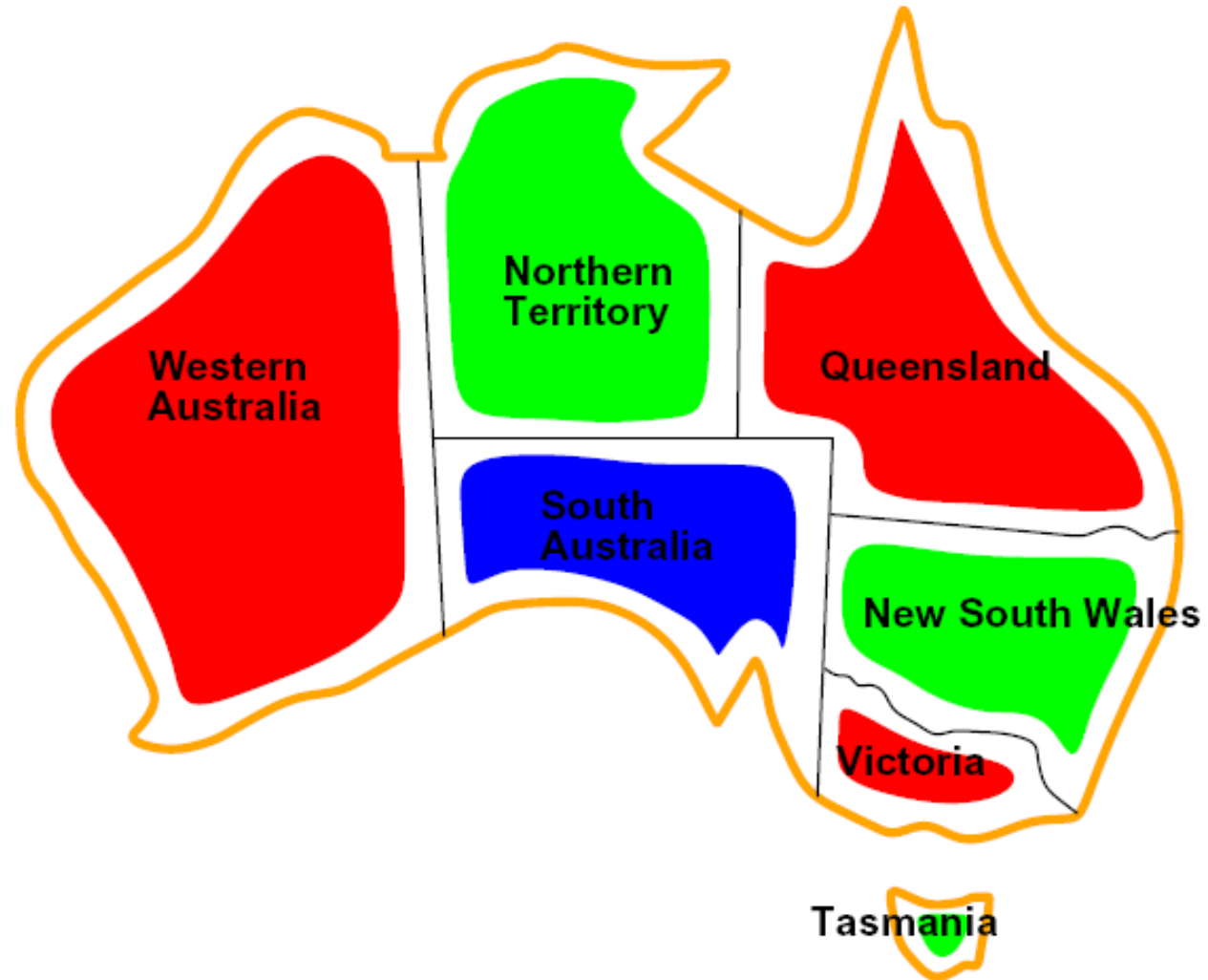

Example: Map Coloring

- Variables: WA, NT, Q, NSW, V, SA, T
- Domains: $D = \{\text{red, green, blue}\}$
- Constraints: adjacent regions must have different colors

Implicit: $WA \neq NT$

Explicit: $(WA, NT) \in \{(\text{red, green}), (\text{red, blue}), \dots\}$

- Solutions are assignments satisfying all constraints, e.g.:

$\{WA=\text{red}, NT=\text{green}, Q=\text{red}, NSW=\text{green}, V=\text{red}, SA=\text{blue}, T=\text{green}\}$

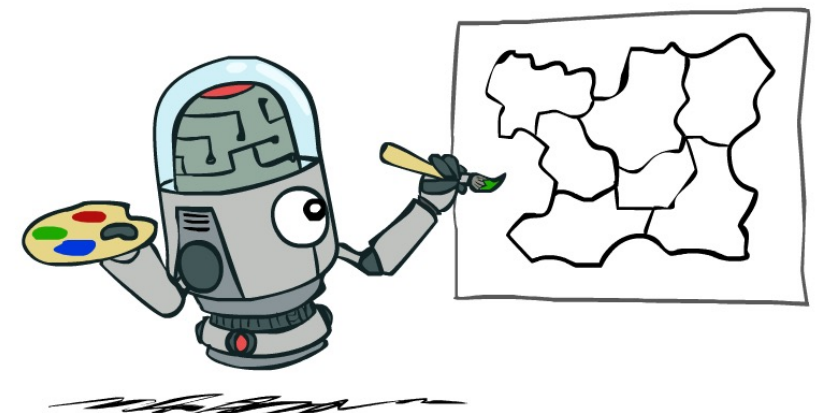
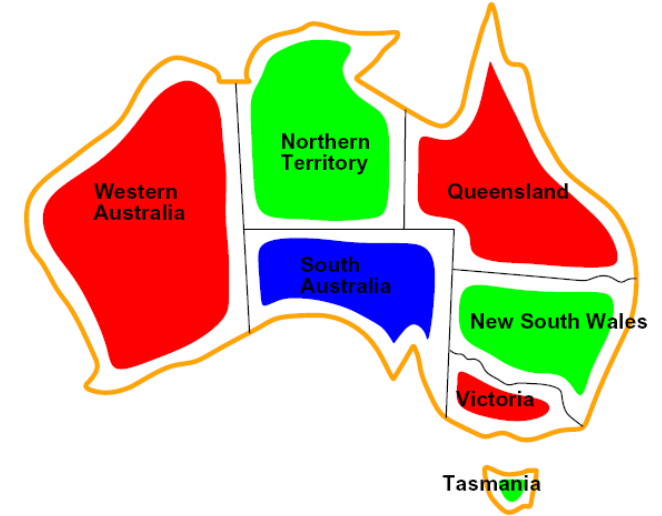

Example: Map Coloring

- Variables: WA, NT, Q, NSW, V, SA, T
- Domains: $D = \{\text{red, green, blue}\}$
- Constraints: adjacent regions must have different colors

Implicit: $WA \neq NT$

Explicit: $(WA, NT) \in \{(\text{red, green}), (\text{red, blue}), \dots\}$

- Solutions are assignments satisfying all constraints, e.g.:

$\{WA=\text{red}, NT=\text{green}, Q=\text{red}, NSW=\text{green}, V=\text{red}, SA=\text{blue}, T=\text{green}\}$

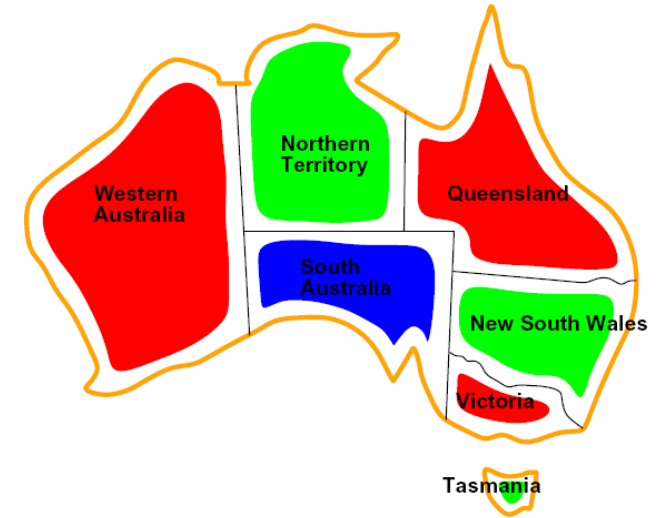

How many solutions with 3 colors?

Example: N-Queens

- Formulation 1:

- Variables: X_{ij}
- Domains: $\{0, 1\}$
- Constraints

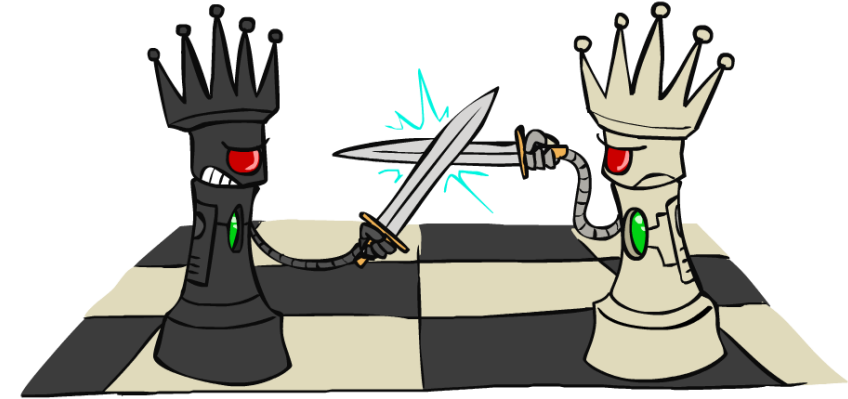
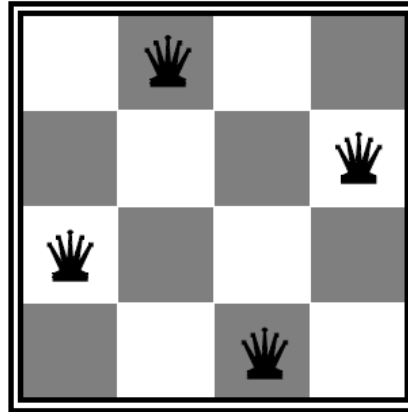

$$\forall i, j, k \quad (X_{ij}, X_{ik}) \in \{(0, 0), (0, 1), (1, 0)\}$$

$$\forall i, j, k \quad (X_{ij}, X_{kj}) \in \{(0, 0), (0, 1), (1, 0)\}$$

$$\forall i, j, k \quad (X_{ij}, X_{i+k, j+k}) \in \{(0, 0), (0, 1), (1, 0)\}$$

$$\forall i, j, k \quad (X_{ij}, X_{i+k, j-k}) \in \{(0, 0), (0, 1), (1, 0)\}$$

$$\sum_{i,j} X_{ij} = N$$

Example: N-Queens

- Formulation 2:

- Variables: Q_k

- Domains: $\{1, 2, 3, \dots, N\}$

- Constraints:

Implicit: $\forall i, j$ non-threatening(Q_i, Q_j)

Explicit: $(Q_1, Q_2) \in \{(1, 3), (1, 4), \dots\}$

...

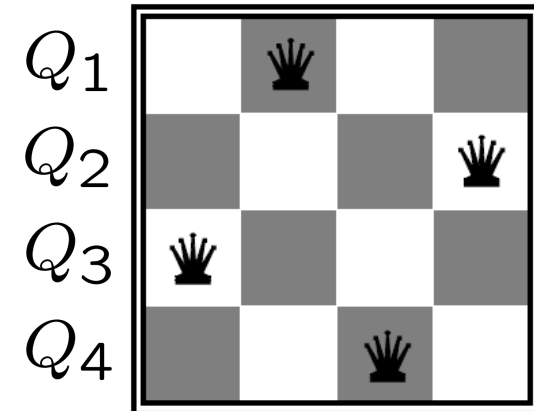

Constraint Graphs

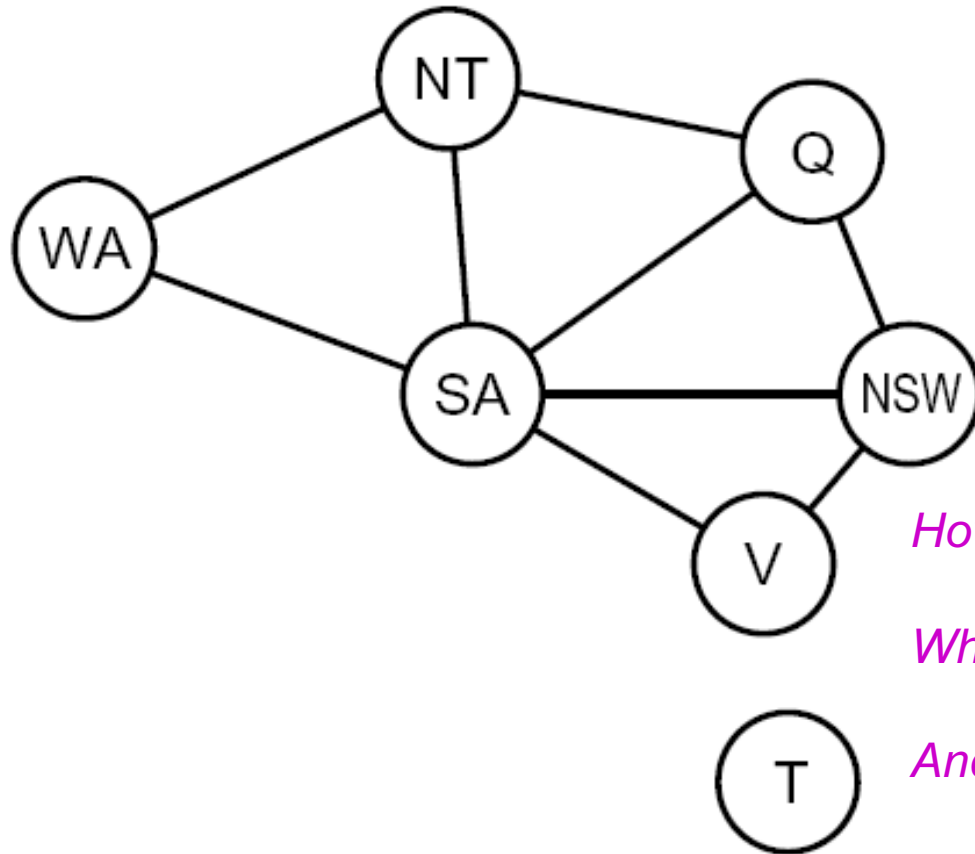

How many solutions with 3 colors?

What about 2 colors?

And 4 colors? (HW)

Constraint Graphs

- Binary CSP: each constraint relates (at most) two variables
- Binary constraint graph: nodes are variables, arcs show constraints
- General-purpose CSP algorithms use the graph structure to speed up search. E.g., Tasmania is an independent subproblem!

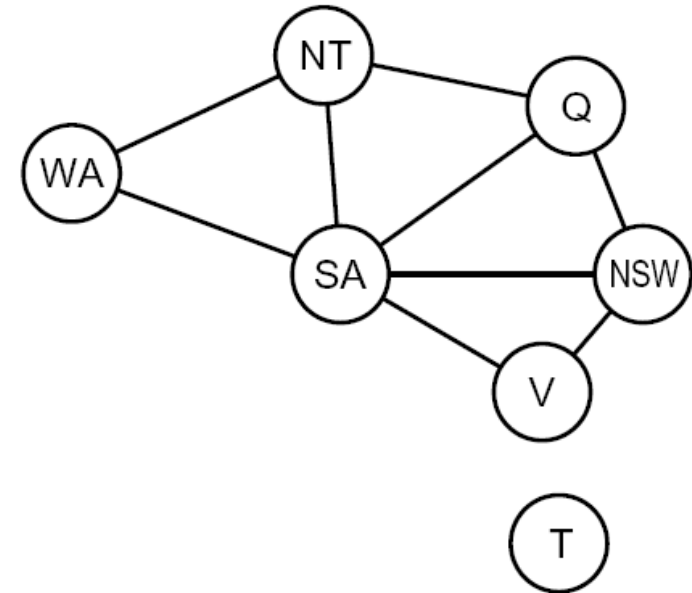

Example: Cryptarithmic

- Variables:

$F T U W R O X_1 X_2 X_3$

- Domains:

$\{0, 1, 2, 3, 4, 5, 6, 7, 8, 9\}$

- Constraints:

$\text{alldiff}(F, T, U, W, R, O)$

$O + O = R + 10 \cdot X_1$

...

$$\begin{array}{r} T W O \\ + T W O \\ \hline F O U R \end{array}$$

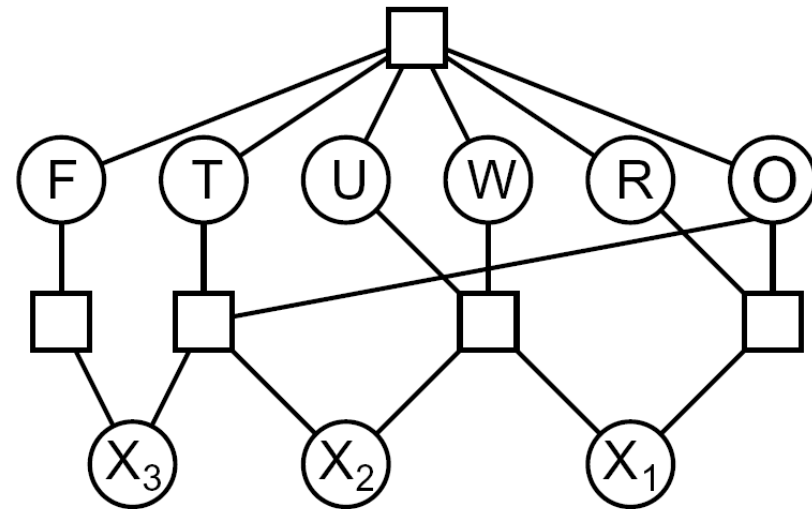

Example: Sudoku

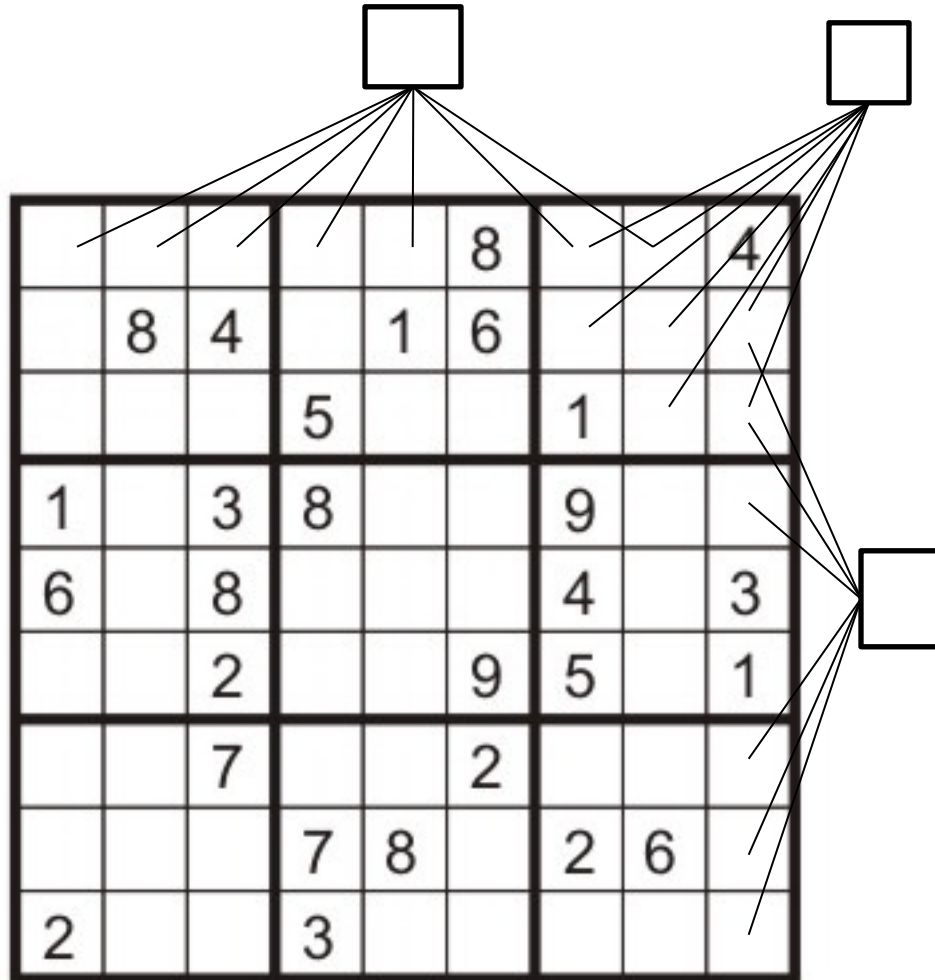

- Variables:
 - Each (open) square
- Domains:
 - $\{1,2,\dots,9\}$
- Constraints:
 - 9-way alldiff for each column
 - 9-way alldiff for each row
 - 9-way alldiff for each region
 - (or can have a bunch of pairwise inequality constraints)

Example: The Waltz Algorithm

- The Waltz algorithm is for interpreting line drawings of solid polyhedra as 3D objects
- An early example of an AI computation posed as a CSP

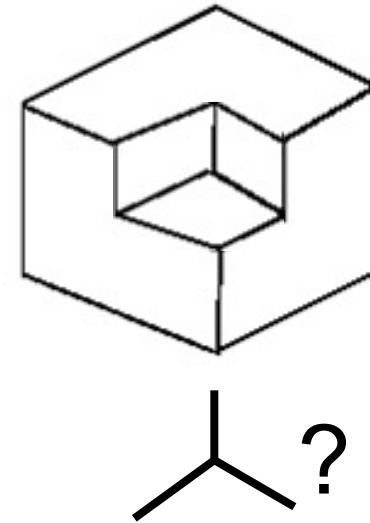
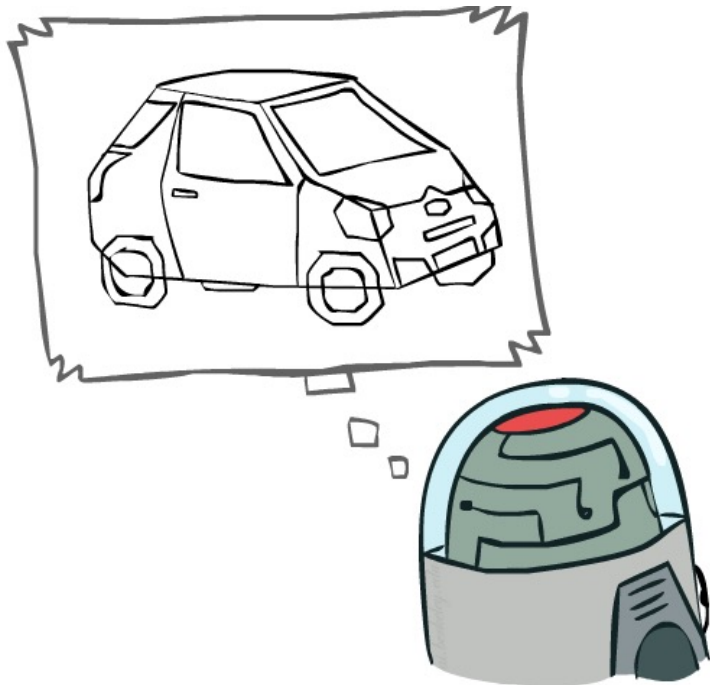

- Approach:
 - Each intersection is a variable
 - Adjacent intersections impose constraints on each other
 - Solutions are physically realizable 3D interpretations

Varieties of CSPs and Constraints

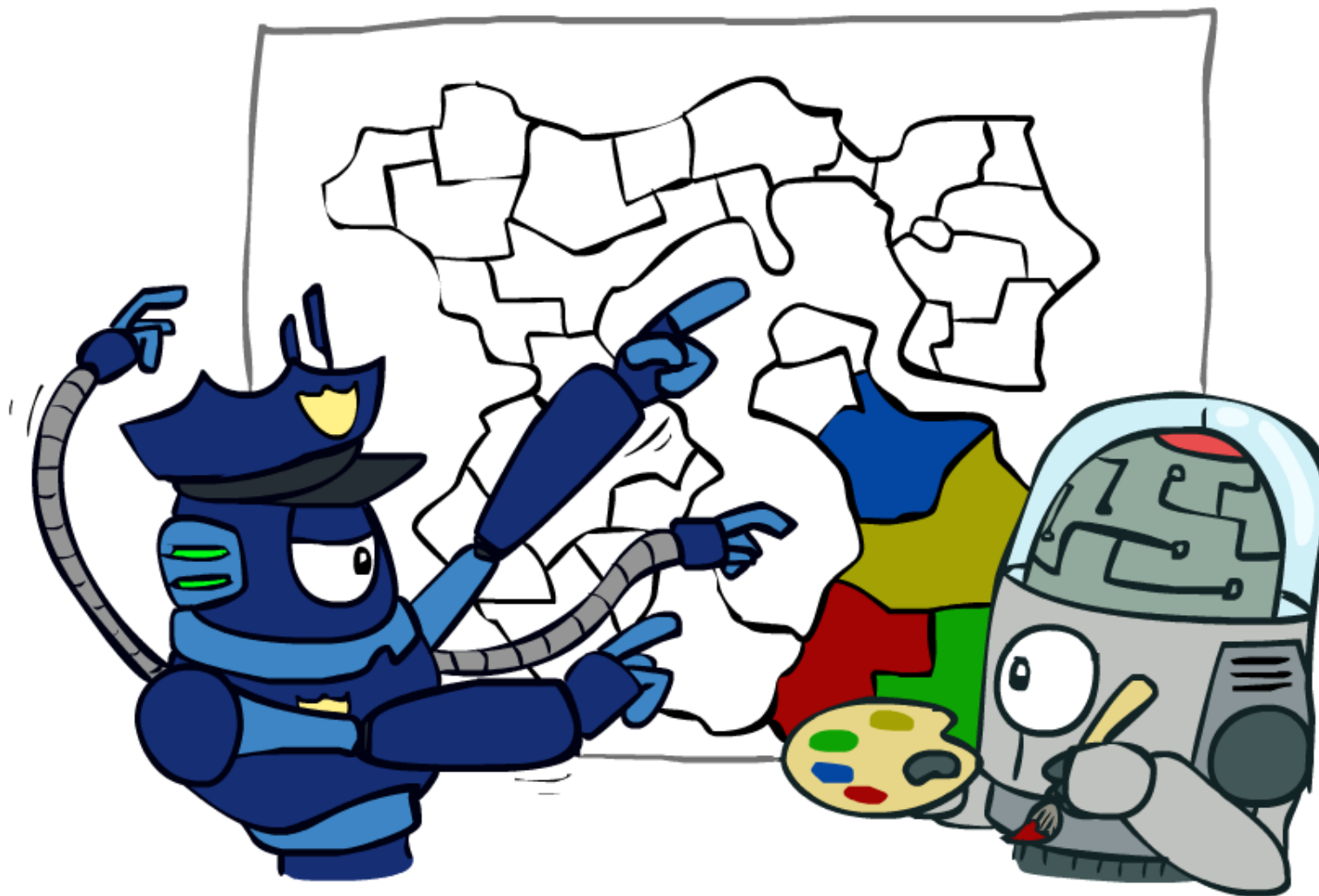

Varieties of CSPs

- Discrete Variables

- Finite domains
 - Size d means $O(d^n)$ complete assignments
 - E.g., Boolean CSPs, including Boolean satisfiability (NP-complete)
- Infinite domains (integers, strings, etc.)
 - E.g., job scheduling, variables are start/end times for each job
 - Linear constraints solvable, nonlinear undecidable

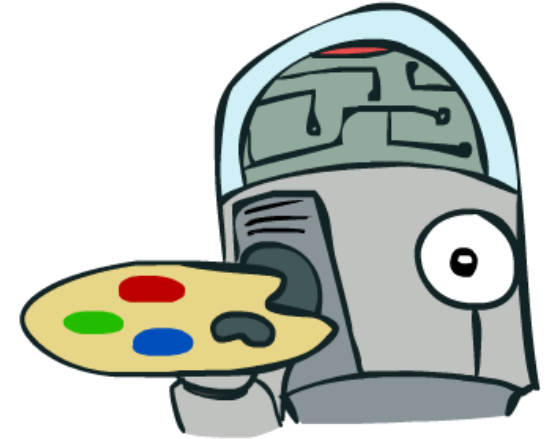

- Continuous variables

- E.g., start/end times for Hubble Telescope observations
- Linear constraints solvable in polynomial time by LP methods (a whole other course to take)



Varieties of Constraints

- Varieties of Constraints

- Unary constraints involve a single variable (equivalent to reducing domains), e.g.:

$$SA \neq \text{green}$$

- Binary constraints involve pairs of variables, e.g.:

$$SA \neq WA$$

- Higher-order constraints involve 3 or more variables:
e.g., cryptarithmic column constraints

- Preferences (soft constraints):

- E.g., red is better than green
- Often representable by a cost for each variable assignment
- Gives constrained optimization problems
- (also relevant in Bayes' nets)

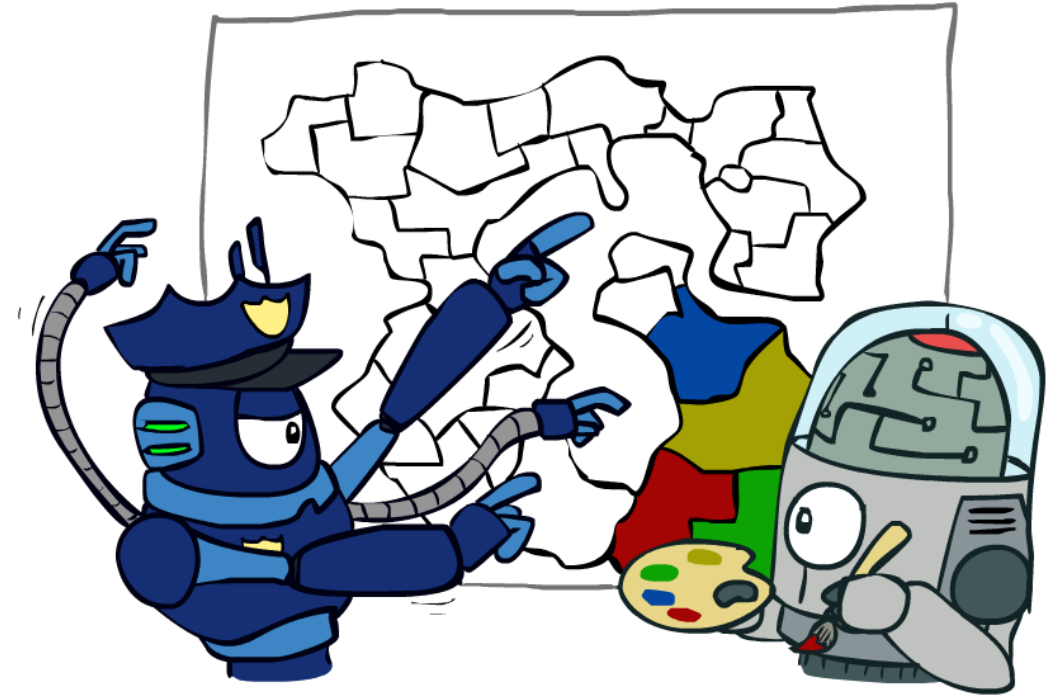

Real-World CSPs

- Scheduling problems: e.g., when can we go hiking on Sunday?
- Timetabling problems: e.g., which class is offered when and where?
- Assignment problems: e.g., who teaches what class
- Hardware configuration
- Transportation scheduling
- Factory scheduling
- Circuit layout
- Fault diagnosis
- ... lots more!

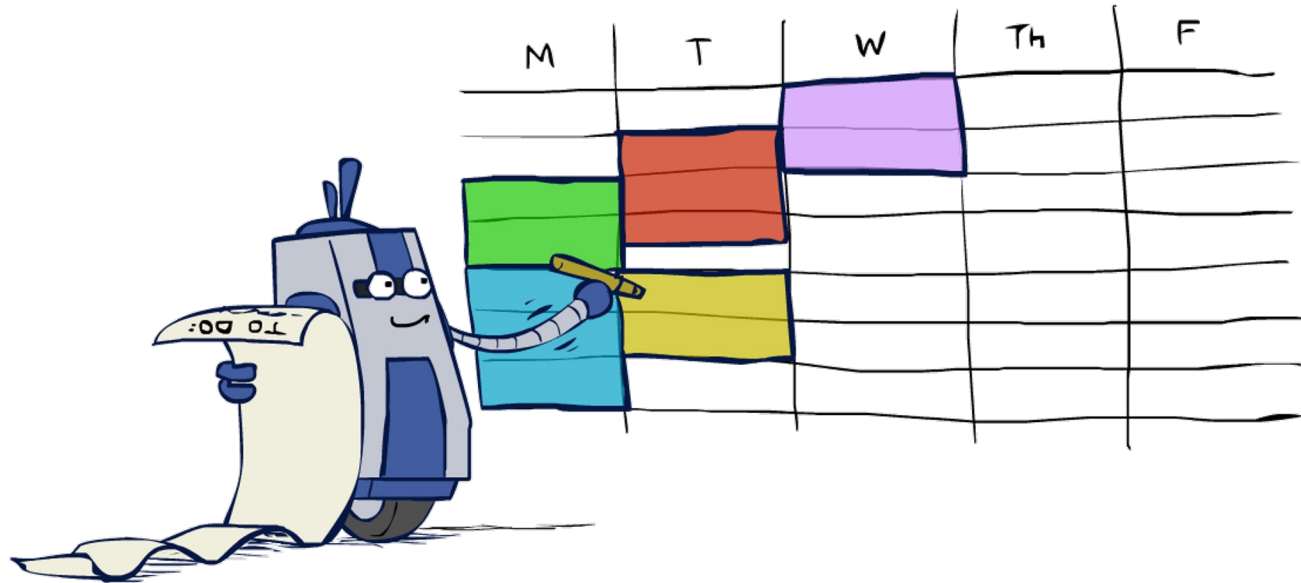

- Many real-world problems involve real-valued variables...

Solving CSPs



Standard Search Formulation

- Standard search formulation of CSPs
- States defined by the values assigned so far (partial assignments)
 - Initial state: the empty assignment, $\{\}$
 - Successor function: assign a value to an unassigned variable
 - Goal test: the current assignment is complete and satisfies all constraints
- We'll start with the straightforward, naïve approach, then improve it

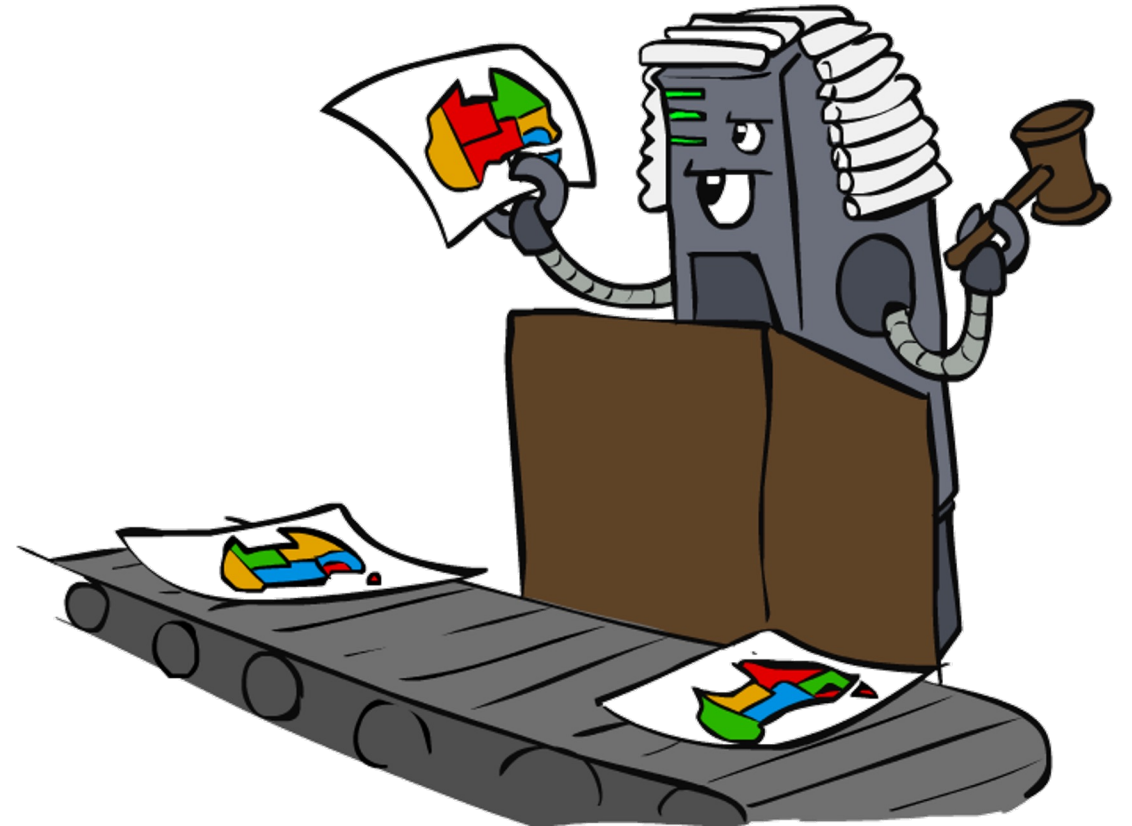

Search Methods

- What would BFS do?
- What would DFS do?
- What problems does naïve search have?

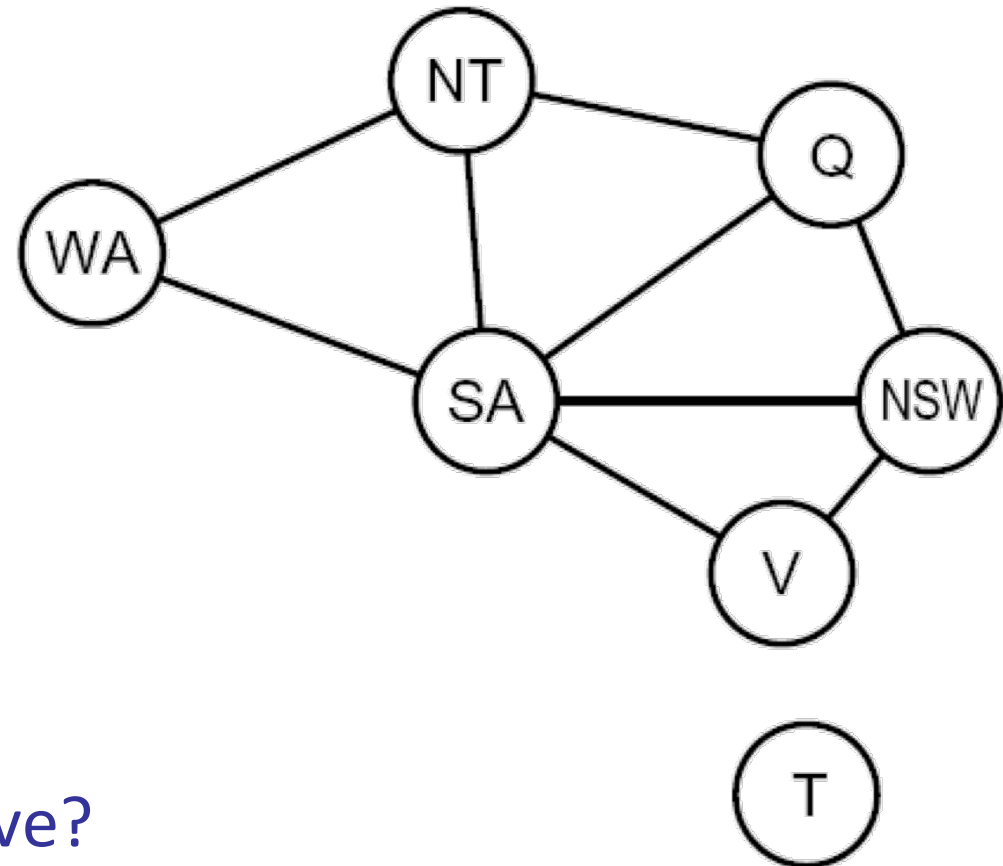

[Demo: coloring -- dfs]

Backtracking Search

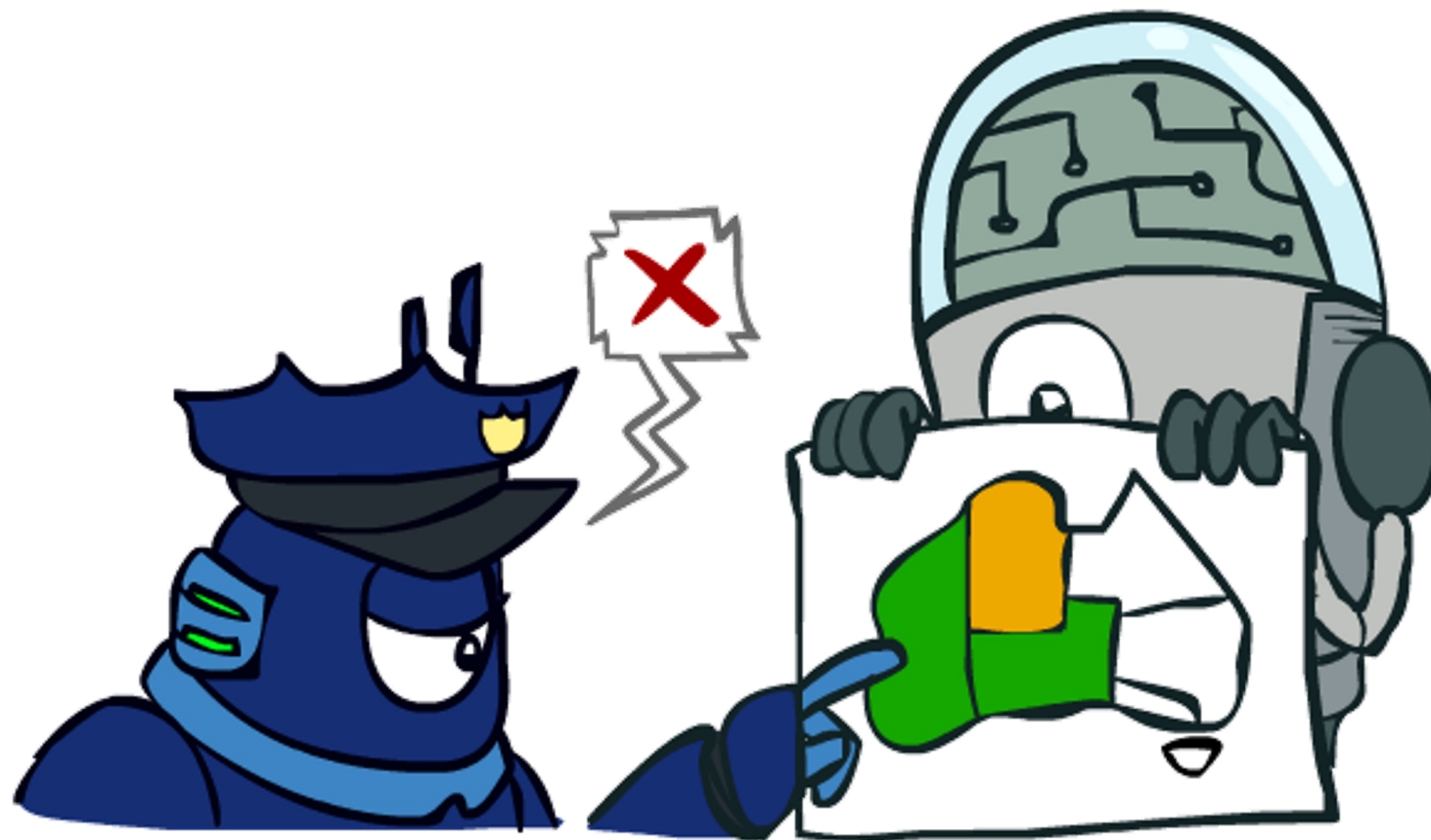

Backtracking Search

- Backtracking search is the basic uninformed algorithm for solving CSPs
- Idea 1: One variable at a time
 - Variable assignments are commutative, so fix ordering
 - I.e., [WA = red then NT = green] same as [NT = green then WA = red]
 - Only need to consider assignments to a single variable at each step
- Idea 2: Check constraints as you go
 - I.e. consider only values which do not conflict with previous assignments
 - Might have to do some computation to check the constraints
 - “Incremental goal test”
- Depth-first search with these two improvements is called *backtracking search* (not the best name)
- Can solve n-queens for $n \approx 25$

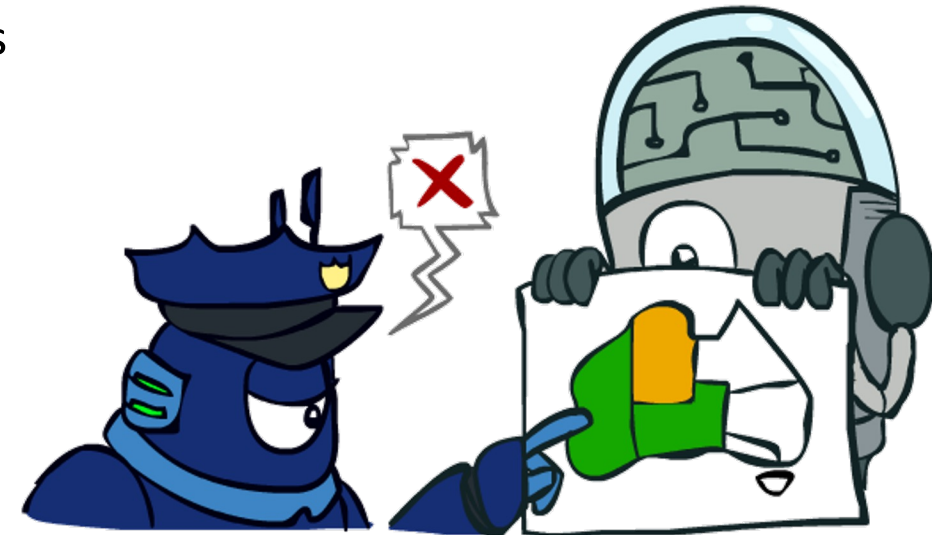

Backtracking Example

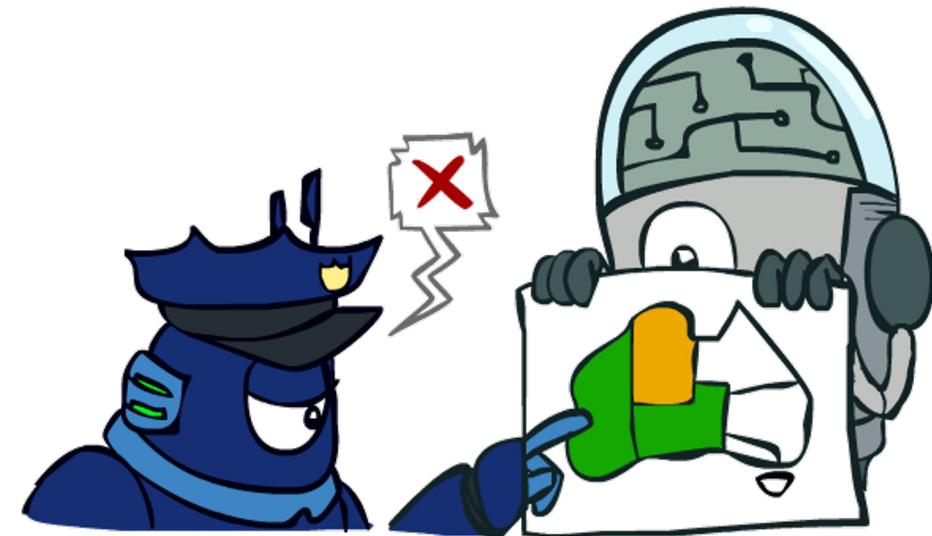
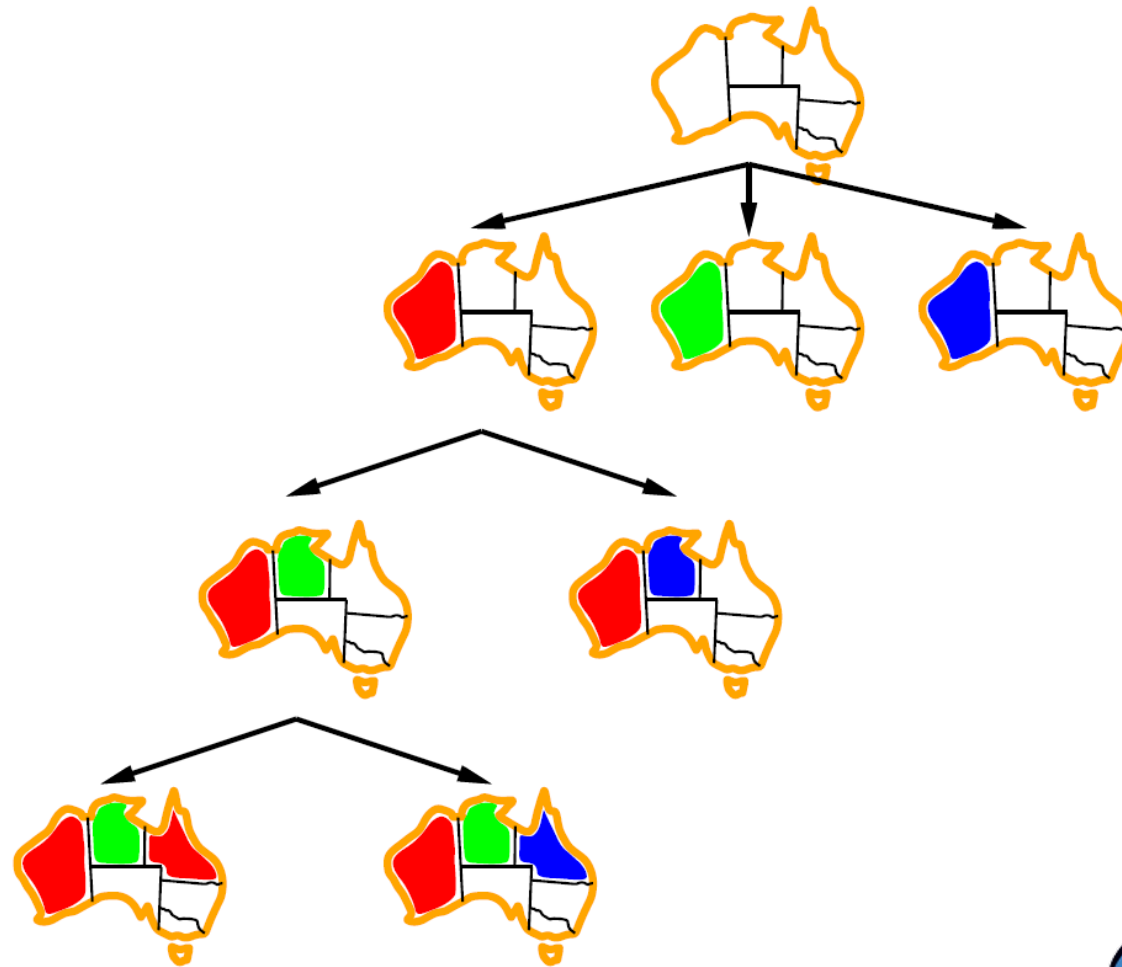

Backtracking Search

```
function BACKTRACKING-SEARCH(csp) returns solution/failure
  return RECURSIVE-BACKTRACKING({ }, csp)

function RECURSIVE-BACKTRACKING(assignment, csp) returns soln/failure
  if assignment is complete then return assignment
  var ← SELECT-UNASSIGNED-VARIABLE(VARIABLES[csp], assignment, csp)
  for each value in ORDER-DOMAIN-VALUES(var, assignment, csp) do
    if value is consistent with assignment given CONSTRAINTS[csp] then
      add {var = value} to assignment
      result ← RECURSIVE-BACKTRACKING(assignment, csp)
      if result ≠ failure then return result
      remove {var = value} from assignment
  return failure
```

- Backtracking = DFS + variable-ordering + fail-on-violation
- What are the choice points?

[Demo: coloring -- backtracking]

Exercise: Backtracking

In a general constraint satisfaction problem with N binary-valued variables, what is the minimum, and the maximum number of times that backtracking search will backtrack, expressed in $O()$ notation (i.e. $O(1)$, $O(n^2)$, etc.).

Improving Backtracking

- General-purpose ideas give huge gains in speed
- Ordering:
 - Which variable should be assigned next?
 - In what order should its values be tried?
- Filtering: Can we detect inevitable failure early?
- Structure: Can we exploit the problem structure?

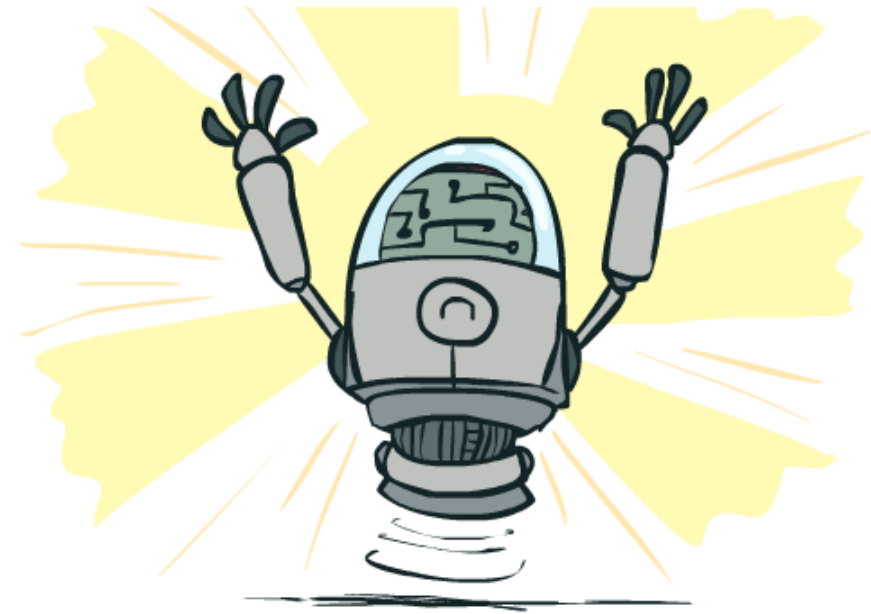

Filtering



Filtering: Forward Checking

- Filtering: Keep track of domains for unassigned variables and cross off bad options
- Forward checking: Cross off values that violate a constraint when added to the existing assignment

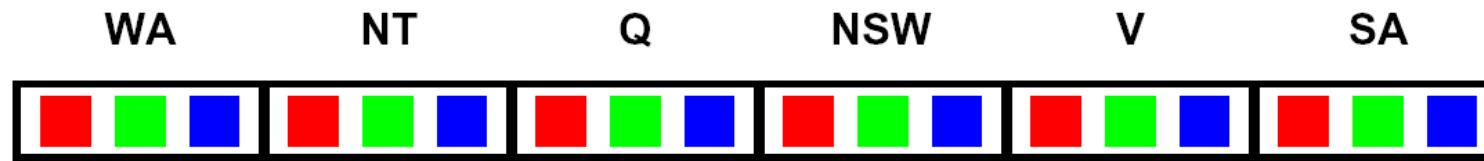

[Demo: coloring -- forward checking]

Filtering: Constraint Propagation

- Forward checking propagates information from assigned to unassigned variables, but doesn't provide early detection for all failures:

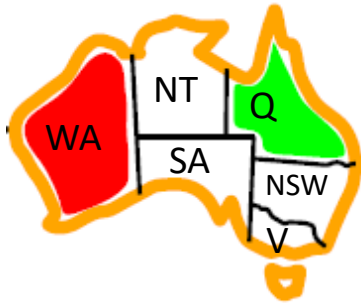

WA	NT	Q	NSW	V	SA
Red Green Blue	Red Green Blue	Red Green Blue	Red Green Blue	Red Green Blue	Red Green Blue
Red	Green Blue	Red Green Blue	Red Green Blue	Red Green Blue	Green Blue
Red	Blue	Green	Red Blue	Red Green Blue	Blue

- NT and SA cannot both be blue!
- Why didn't we detect this yet?
- Constraint propagation*: reason from constraint to constraint

Consistency of A Single Arc

- An arc $X \rightarrow Y$ is **consistent** iff for *every* x in the tail there is *some* y in the head which could be assigned without violating a constraint

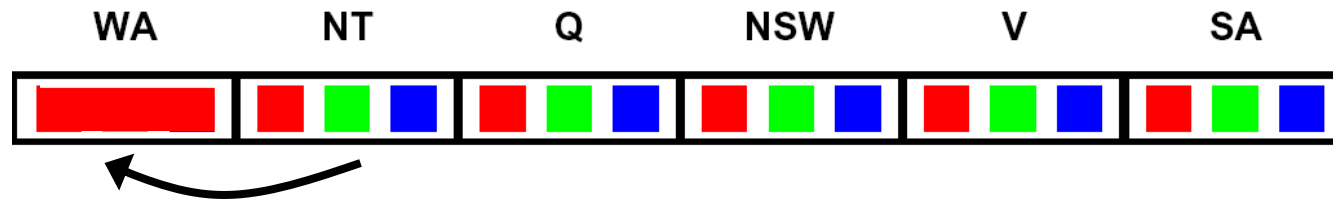
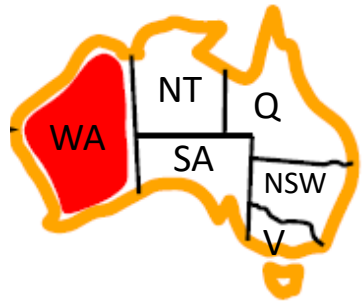

- Tail = NT, head = WA
 - If NT = blue: we could assign WA = red
 - If NT = green: we could assign WA = red
 - If NT = red: there is no remaining assignment to WA that we can use
 - Deleting NT = red from the tail makes this arc consistent
- Forward checking: Enforcing consistency of arcs pointing to each new assignment

Arc Consistency of an Entire CSP (1/6)

- A simple form of propagation makes sure **all** arcs are consistent:

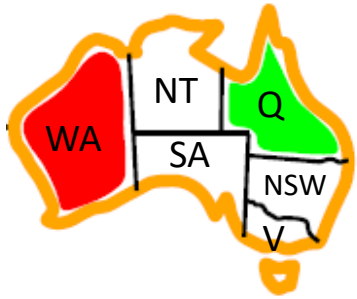

- Arc V to NSW is consistent: for *every* x in the tail there is *some* y in the head which could be assigned without violating a constraint

Arc Consistency of an Entire CSP (2/6)

- A simple form of propagation makes sure **all** arcs are consistent:

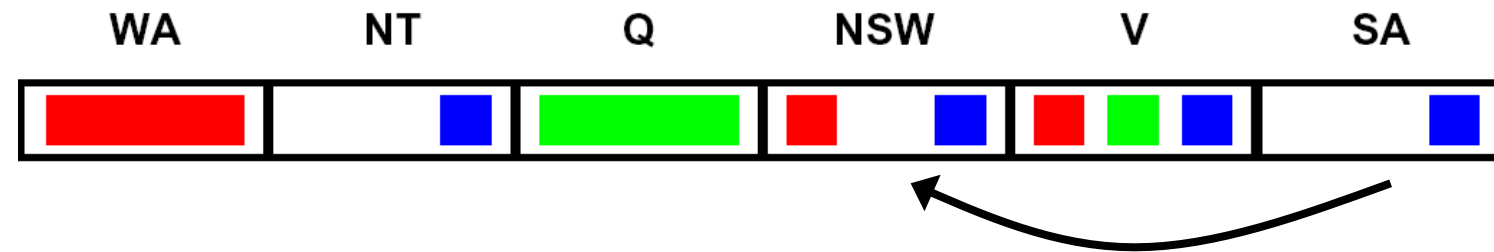
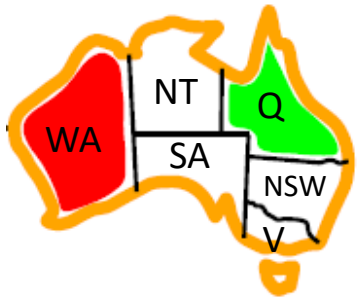

- Arc SA to NSW is consistent: for *every* x in the tail there is *some* y in the head which could be assigned without violating a constraint

Arc Consistency of an Entire CSP (3/6)

- A simple form of propagation makes sure **all** arcs are consistent:

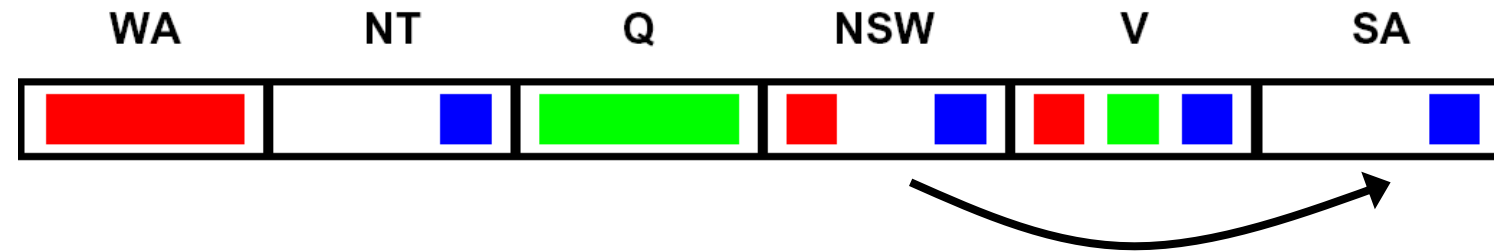
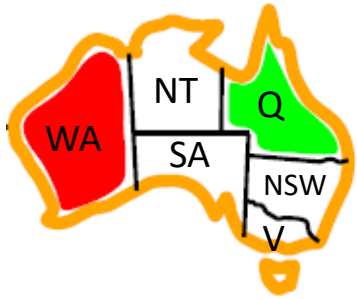

- Arc NSW to SA is not consistent: if we assign NSW = blue, there is no valid assignment left for SA
- To make this arc consistent, we delete NSW = blue from the tail

Arc Consistency of an Entire CSP (4/6)

- A simple form of propagation makes sure **all** arcs are consistent:

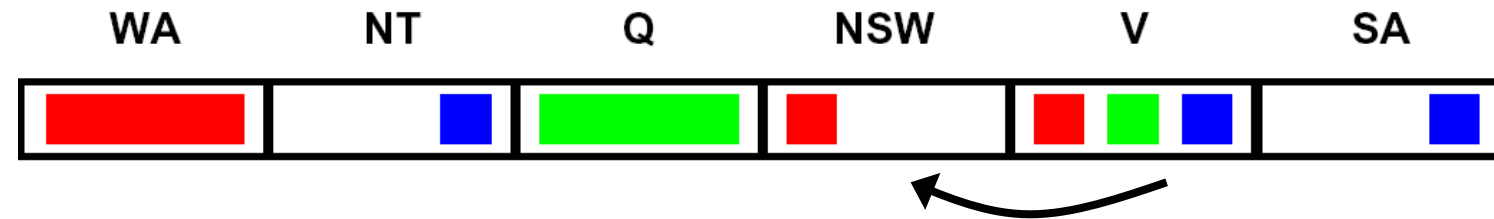
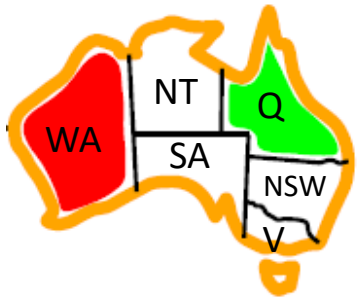

- Remember that arc V to NSW was consistent, when NSW had red and blue in its domain
- After removing blue from NSW, this arc might not be consistent anymore! We need to recheck this arc.
- Important: If X loses a value, neighbors of X need to be rechecked!

Arc Consistency of an Entire CSP (5/6)

- A simple form of propagation makes sure **all** arcs are consistent:

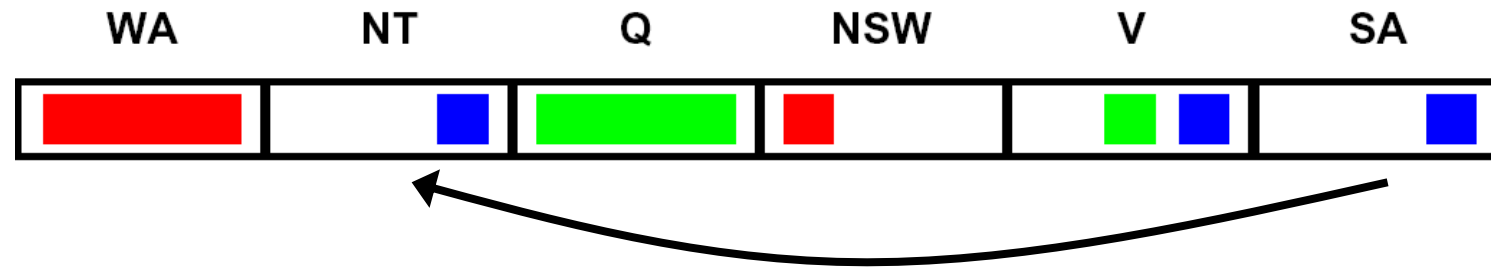
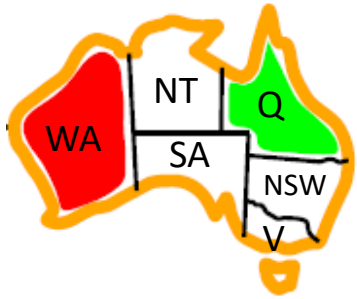

- Arc SA to NT is inconsistent. We make it consistent by deleting from the tail (SA = blue).

Arc Consistency of an Entire CSP (6/6)

- A simple form of propagation makes sure **all** arcs are consistent:

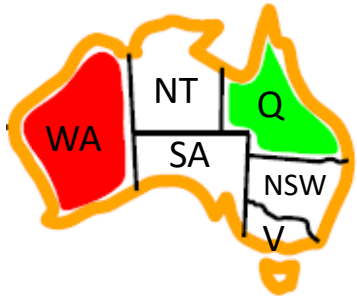

- SA has an empty domain, so we detect failure. There is no way to solve this CSP with WA = red and Q = green, so we backtrack.
- Arc consistency detects failure earlier than forward checking
- Can be run as a preprocessor or after each assignment

Enforcing Arc Consistency in a CSP

```
function AC-3(csp) returns the CSP, possibly with reduced domains
inputs: csp, a binary CSP with variables  $\{X_1, X_2, \dots, X_n\}$ 
local variables: queue, a queue of arcs, initially all the arcs in csp

while queue is not empty do
     $(X_i, X_j) \leftarrow \text{REMOVE-FIRST}(\textit{queue})$ 
    if REMOVE-INCONSISTENT-VALUES( $X_i, X_j$ ) then
        for each  $X_k$  in NEIGHBORS[ $X_i$ ] do
            add  $(X_k, X_i)$  to queue

```

```
function REMOVE-INCONSISTENT-VALUES( $X_i, X_j$ ) returns true iff succeeds
    removed  $\leftarrow$  false
    for each  $x$  in DOMAIN[ $X_i$ ] do
        if no value  $y$  in DOMAIN[ $X_j$ ] allows  $(x, y)$  to satisfy the constraint  $X_i \leftrightarrow X_j$ 
            then delete  $x$  from DOMAIN[ $X_i$ ]; removed  $\leftarrow$  true
    return removed

```

- Runtime: $O(n^2d^3)$, can be reduced to $O(n^2d^2)$
- ... but detecting all possible future problems is NP-hard – why?

Limitations of Arc Consistency

- After enforcing arc consistency:
 - Can have one solution left
 - Can have multiple solutions left
 - Can have no solutions left (and not know it)
- Arc consistency still runs inside a backtracking search!

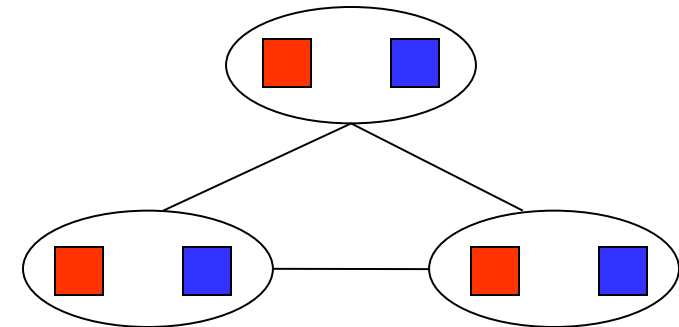
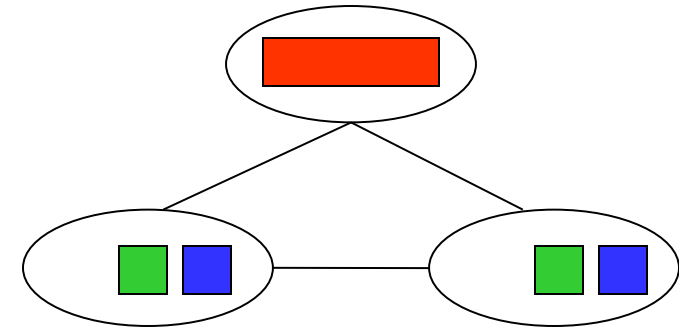

What went wrong here?

[Demo: coloring -- forward checking]

[Demo: coloring -- arc consistency]

Exercise: Arc consistency

Consider a CSP with three variables: A, B, and C. Each of the three variables can take on one of two values: either 1 or 2. There are three constraints: $A \neq B$, $B \neq C$, and $A \neq C$. What values for what variables would be eliminated by enforcing arc-consistency?

Exercise: Arc consistency

Consider a CSP with variables X, Y with domains $\{1, 2, 3, 4, 5, 6\}$ for X and $\{2, 4, 6\}$ for Y , and constraints $X < Y$ and $X + Y > 8$. List the values that will remain in the domain of X after enforcing arc consistency for the arc $X \neq Y$ (which prunes the domain of X , not Y).

HW: Formulating a CSP

Suppose you have a state-space search problem defined by the usual stuff:

- a set of states s ;*
- an initial state s_0 ;*
- a set of actions A including the NoOp action that has no effect;*
- a transition model $\text{Result}(s, a)$;*
- a set of goal states G .*

Unfortunately, you have no search algorithms! All you have is a CSP solver. How could you reformulate this as a CSP? You may assume that you are given the maximum number of steps, T that any plan can have. Make sure that your formulation makes it easy to see what the plan is.