

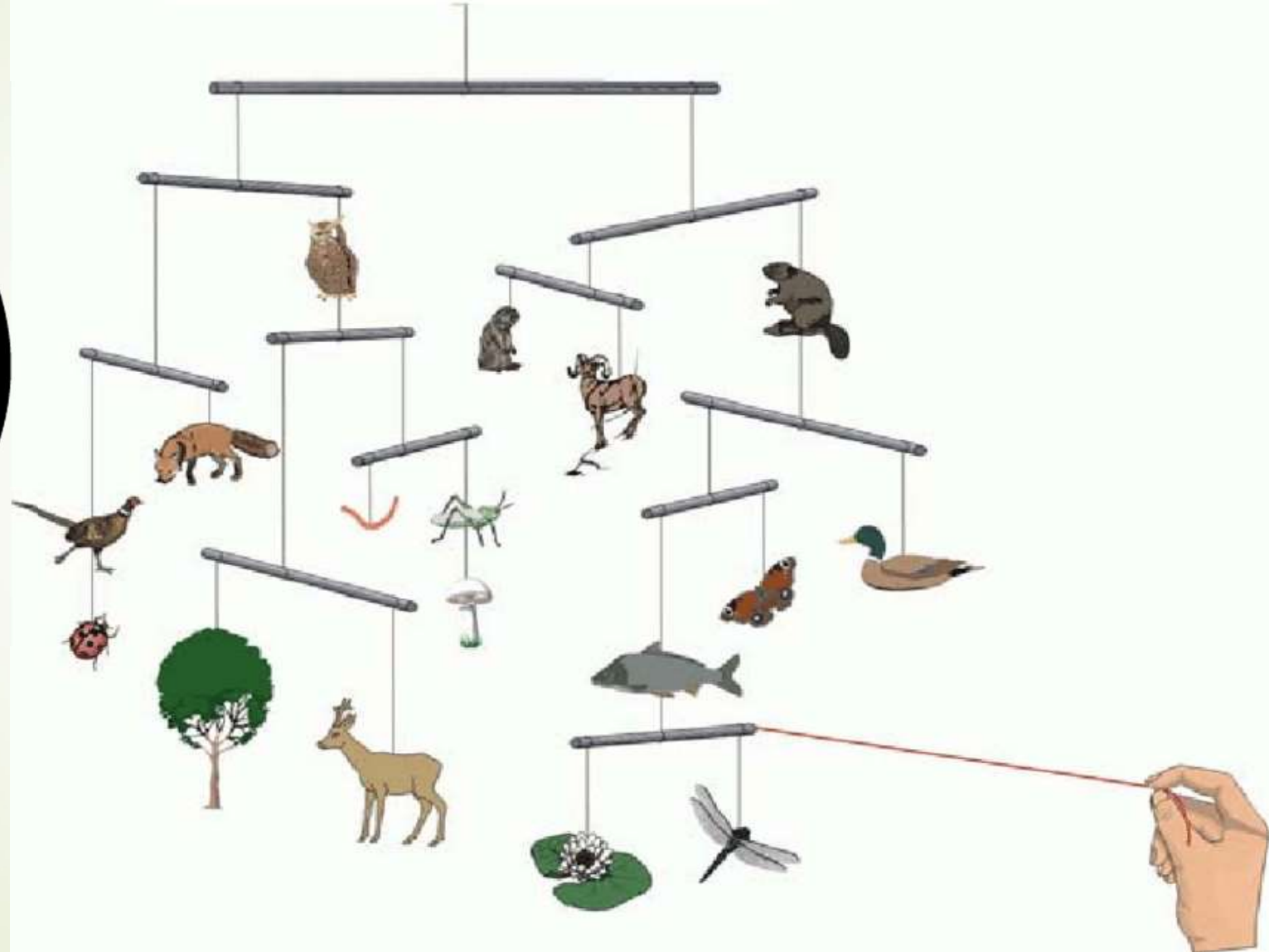

Zoogeography

Lesson 18

Ecosystem

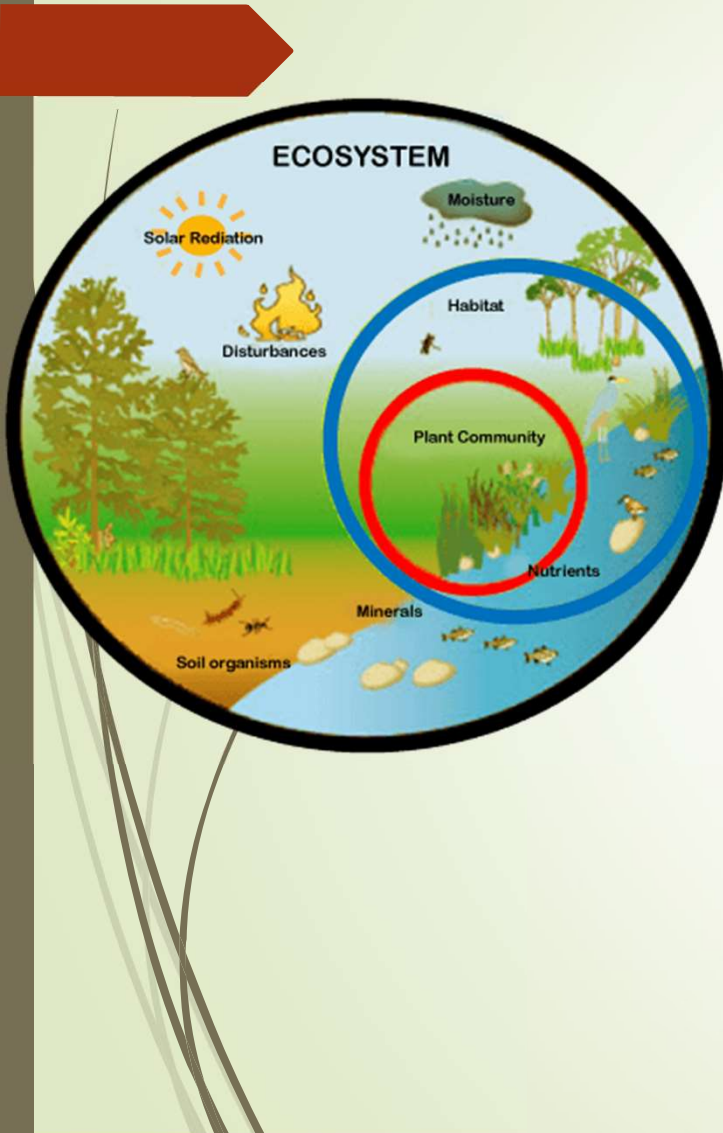

Wildlife



«Direct» monitoring of wildlife



Electroshock



Observation



Catches



Thermal imaging cameras



«Indirect» monitoring of wildlife

stomach contents



What is the eDNA?

- ▶ All the living organisms have DNA
- ▶ The eDNA is released in the environment by an organism
- ▶ It comes from cells arising from:
 - Skin, hair, scales, etc.
 - Gut tract
 - Egg and sperms
 - Organic matter (carcasses)

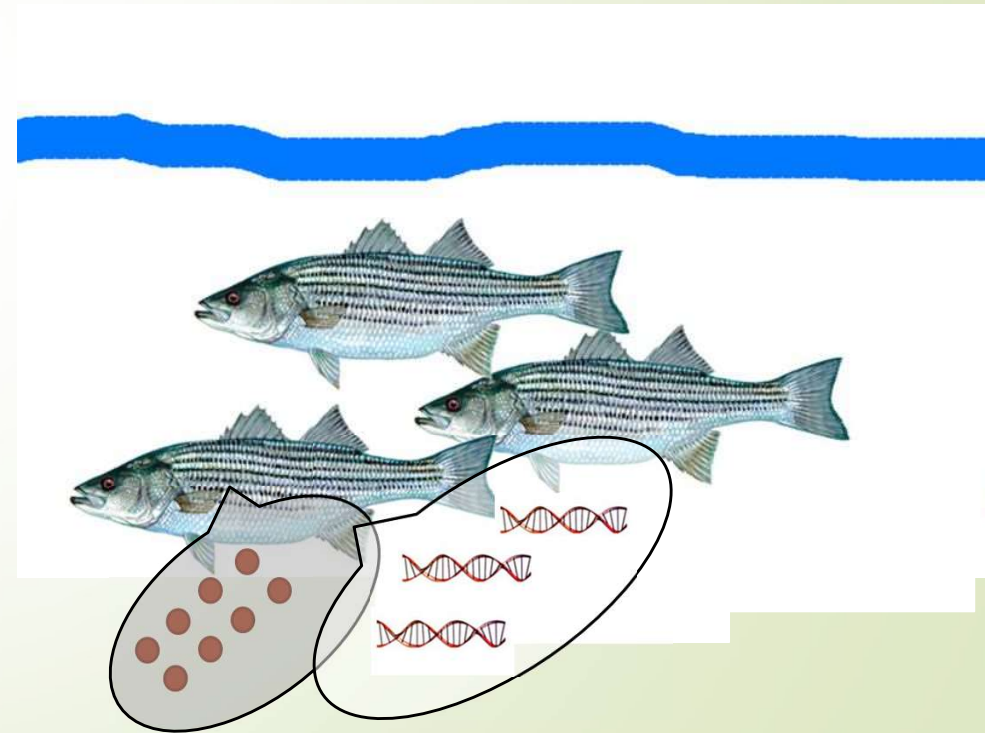

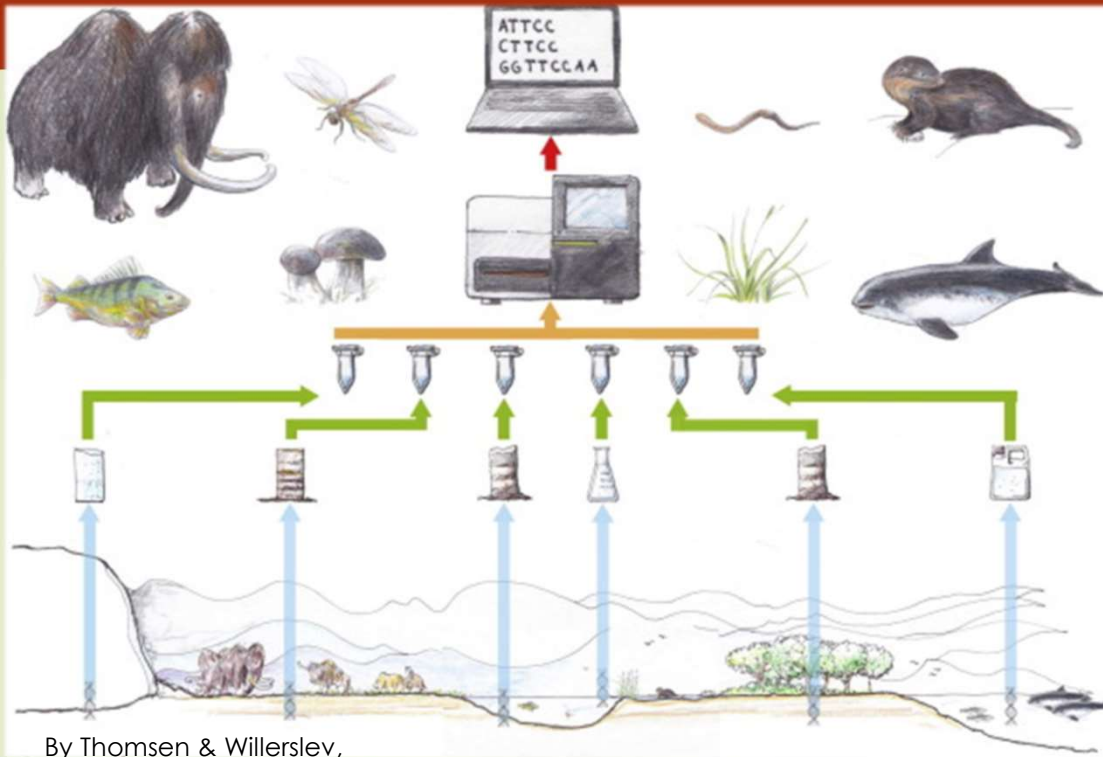

By Thomsen & Willerslev, 2015

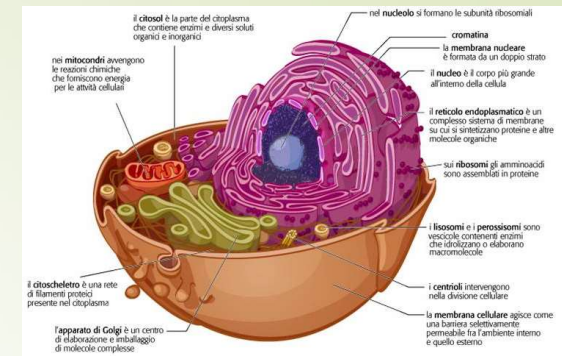
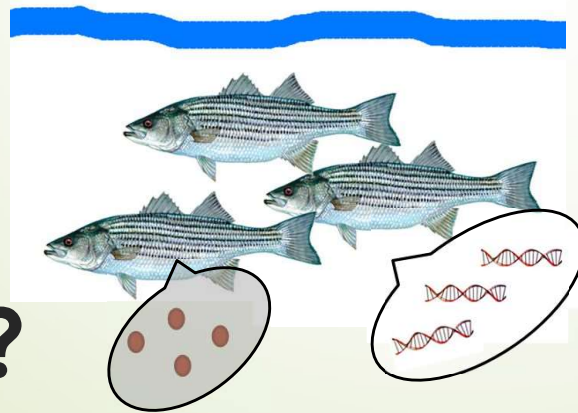

Defined as: genetic material obtained directly from environmental samples (soil, sediment, water, etc.) without any obvious signs of biological source material

What's eDNA?

What is the eDNA?

- Potentially uses nuclear DNA or RNA, but more frequently mitochondrial DNA (mtDNA)
- In every cell there are many copies of it
- mitochondrial DNA is more stable in the environment
- The mitochondrial genome is short (average 16,000 bp), so mitochondrial sequences are available in many species

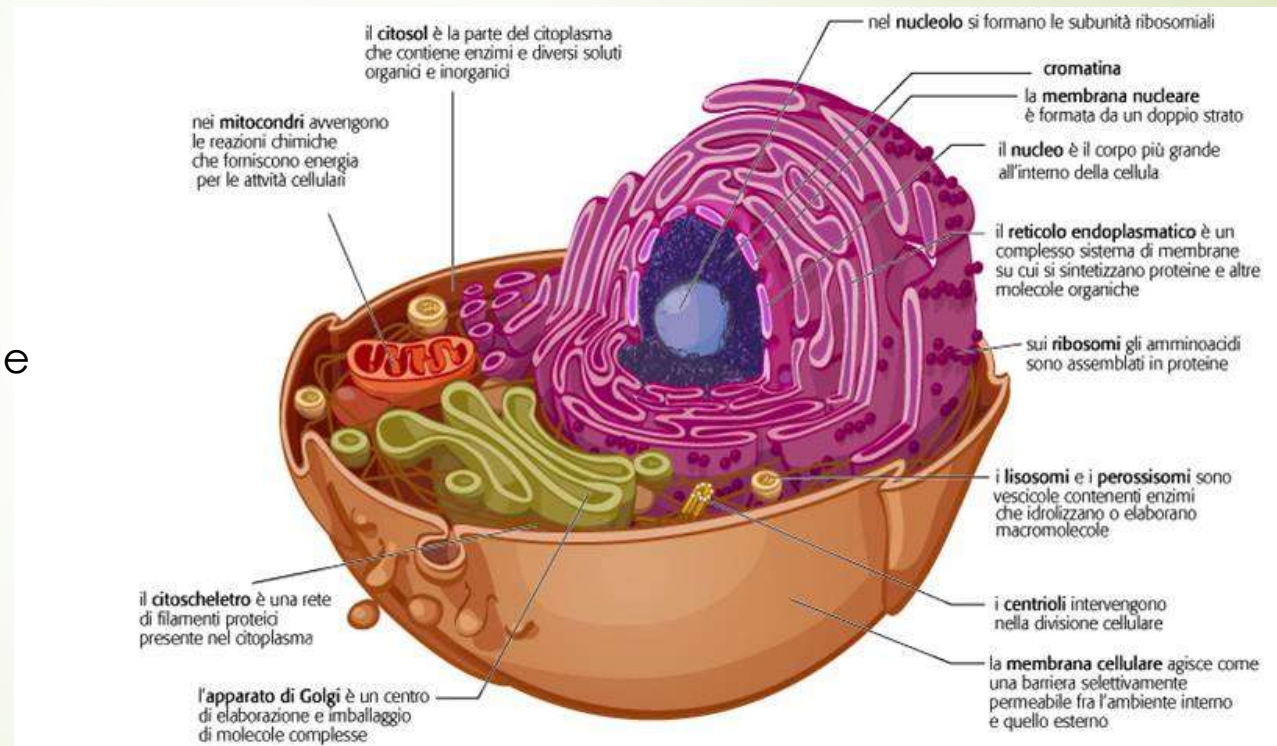

The eDNA analysis

- Collection
- Concentration
- Extraction
- Amplification
- Detection

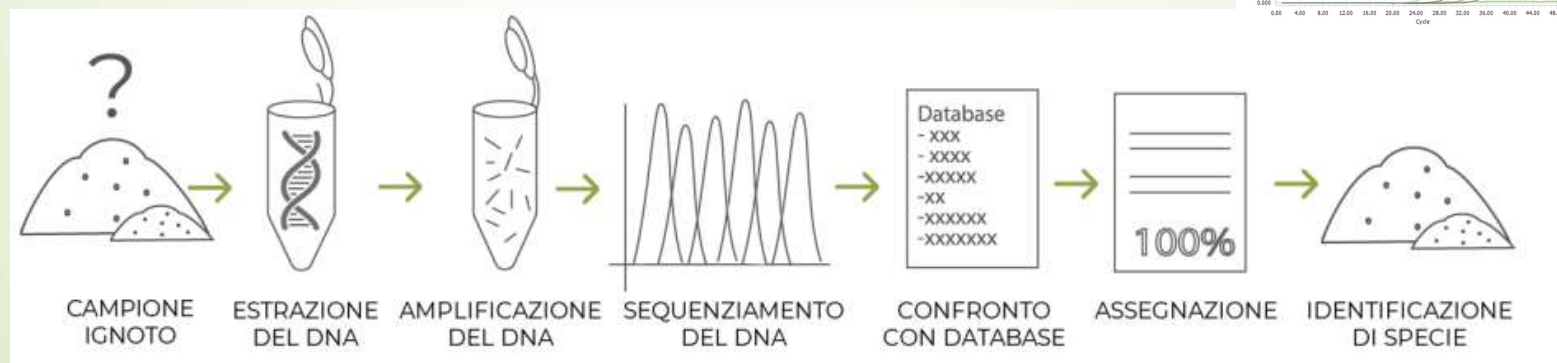
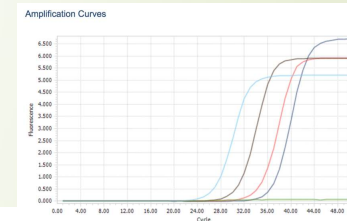

How to detect target species and not the others?

Quantitative Polymerase Chain Reaction (qPCR)

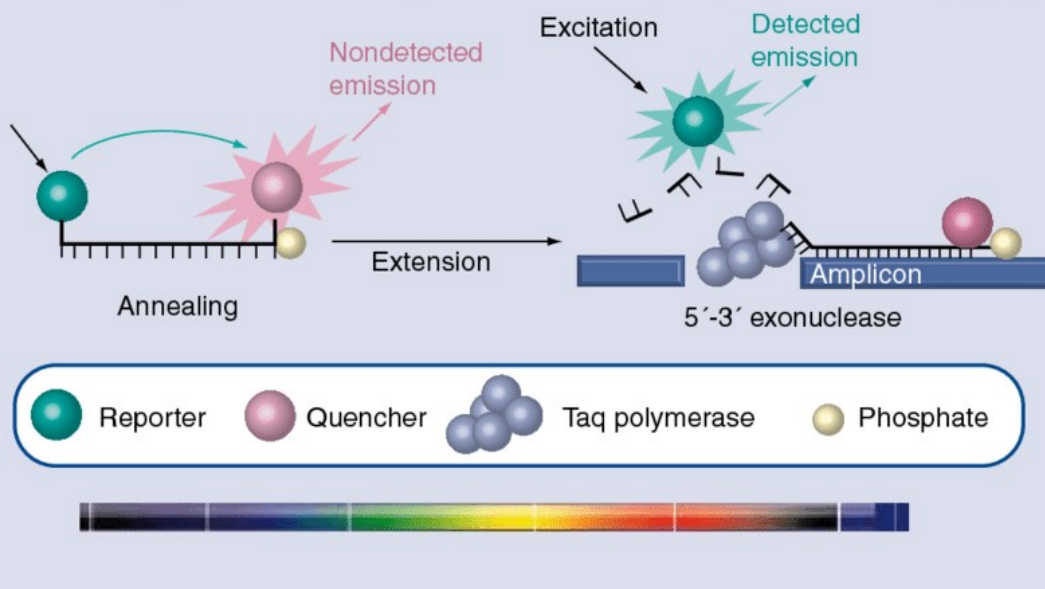
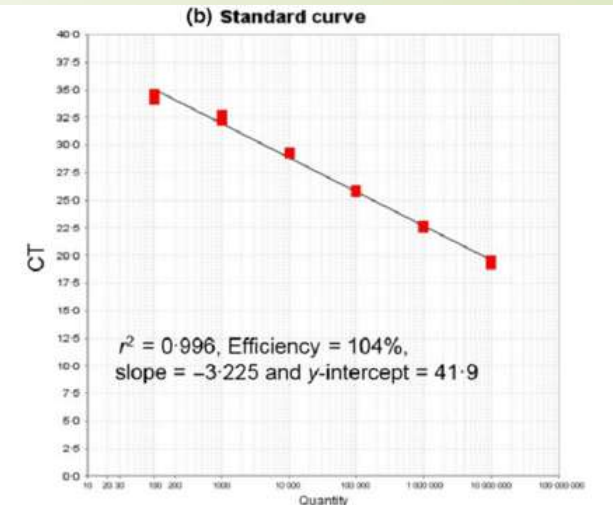
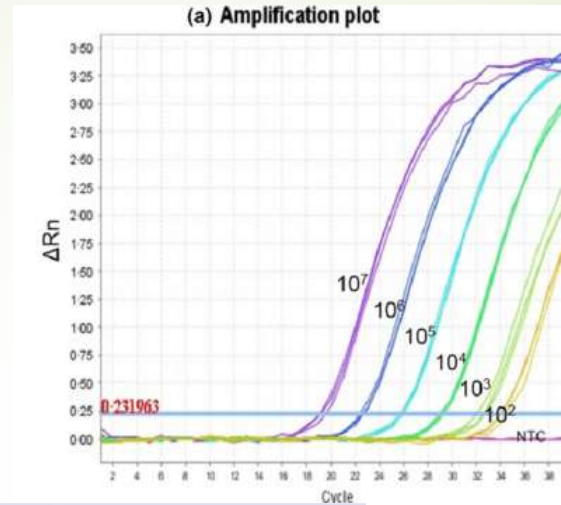



In the 1990s, microbiologists were the first to use the eDNA technique to identify microbes in soil and water in order to:

- Identify toxic algae during algal bloom
(Neilan et al., 1995; Oldach et al., 2000, ecc.)
- Detect faecal contaminations in the water network
(Sinton et al., 1998; Meier et al., 1997, ecc.)
- Identify environmental pathogens
(Barker et al., 1994; Baudart et al., 2000; Truyen et al., 1998)
- Microbiome characterisation
(Koops et al., 1991; Troesch et al., 1999, ecc.)

SHORT COMMUNICATION

Genetic marker investigation of the source and impact of predation on a highly endangered species

SAM C. BANKS,* ALAN HORSUP,† ALAN N. WILTON‡ and ANDREA C. TAYLOR*

*School of Biological Sciences, PO Box 18, Monash University, Clayton, Victoria, 3800, Australia, †Queensland Parks and Wildlife Service, PO Box 3130, Rockhampton, Queensland, 4701, Australia, ‡School of Biotechnology and Biomolecular Sciences, University of New South Wales, Sydney, NSW 2052 Australia

MOLECULAR ECOLOGY

Full Access

Population size estimation in Yellowstone wolves with error-prone noninvasive microsatellite genotypes

Scott Creel✉, Goran Spong, Jennifer L. Sands, Jay Rotella, Janet Zeigle, Lawrence Joe, Kerry M. Murphy, Douglas Smith

BMC Genetics



Research article

Open Access

Genetic characterisation of farmed rainbow trout in Norway: intra- and inter-strain variation reveals potential for identification of escapees

Kevin A Glover

MOLECULAR ECOLOGY RESOURCES

Full Access

Optimizing the use of shed feathers for genetic analysis

FIONA E. HOGAN, RAYLENE COOKE, CHRISTOPHER P. BURRIDGE, JANETTE A. NORMAN

First published: 28 June 2008 | <https://doi.org/10.1111/j.1471-8286.2007.02044.x> | Citations: 51

✉ Fiona Hogan, Fax: +61 39251 7626; E-mail: fiona.hogan@deakin.edu.au

MOLECULAR ECOLOGY RESOURCES

Resource Article | Full Access

Quantifying sequence proportions in a DNA-based diet study using Ion Torrent amplicon sequencing: which counts count?

Bruce E. Deagle✉, Austen C. Thomas, Amanda K. Shaffer, Andrew W. Trites, Simon N. Jarman

First published: 17 April 2013 | <https://doi.org/10.1111/1755-0998.12103> | Citations: 118

Species detection using environmental DNA from water samples

Gentile Francesco Ficetola^{1,2,*}, Claude Miaud², François Pompanon¹ and Pierre Taberlet¹

¹Laboratoire d'Ecologie Alpine, CNRS-UMR 5553, Université Joseph Fourier, BP 53, 38041 Grenoble Cedex 09, France

²Laboratoire d'Ecologie Alpine, CNRS-UMR 5553, Université de Savoie, 73376 Le Bourget du Lac Cedex, France

*Author and address for correspondence: Dipartimento di Scienze dell'Ambiente e del Territorio, Università Milano Bicocca, Piazza della Scienza 1, 20126 Milano, Italy (francesco.ficetola@unimi.it).

LETTER

“Sight-unseen” detection of rare aquatic species using environmental DNA

Christopher L. Jerde¹, Andrew R. Mahon¹, W. Lindsay Chadderton², & David M. Lodge¹

¹Center for Aquatic Conservation, Department of Biological Sciences, University of Notre Dame

²Great Lakes Project, The Nature Conservancy

Freshwater Science, 2013, 32(3):792–800
© 2013 by The Society for Freshwater Science
DOI: 10.1899/13-046.1
Published online: 18 June 2013

Environmental DNA as a new method for early detection of New Zealand mudsnails (*Potamopyrgus antipodarum*)

Caren S. Goldberg^{1,3}, Adam Sepulveda^{2,4}, Andrew Ray^{2,5},
Jeremy Baumgardt^{1,6}, AND Lisette P. Waits^{1,7}

¹Fish and Wildlife Sciences, University of Idaho, Moscow, Idaho 83844-1136 USA

²US Geological Survey Northern Rocky Mountain Science Center, Bozeman, Montana 59715 USA

Scientific papers' trend on the eDNA

Documents by year

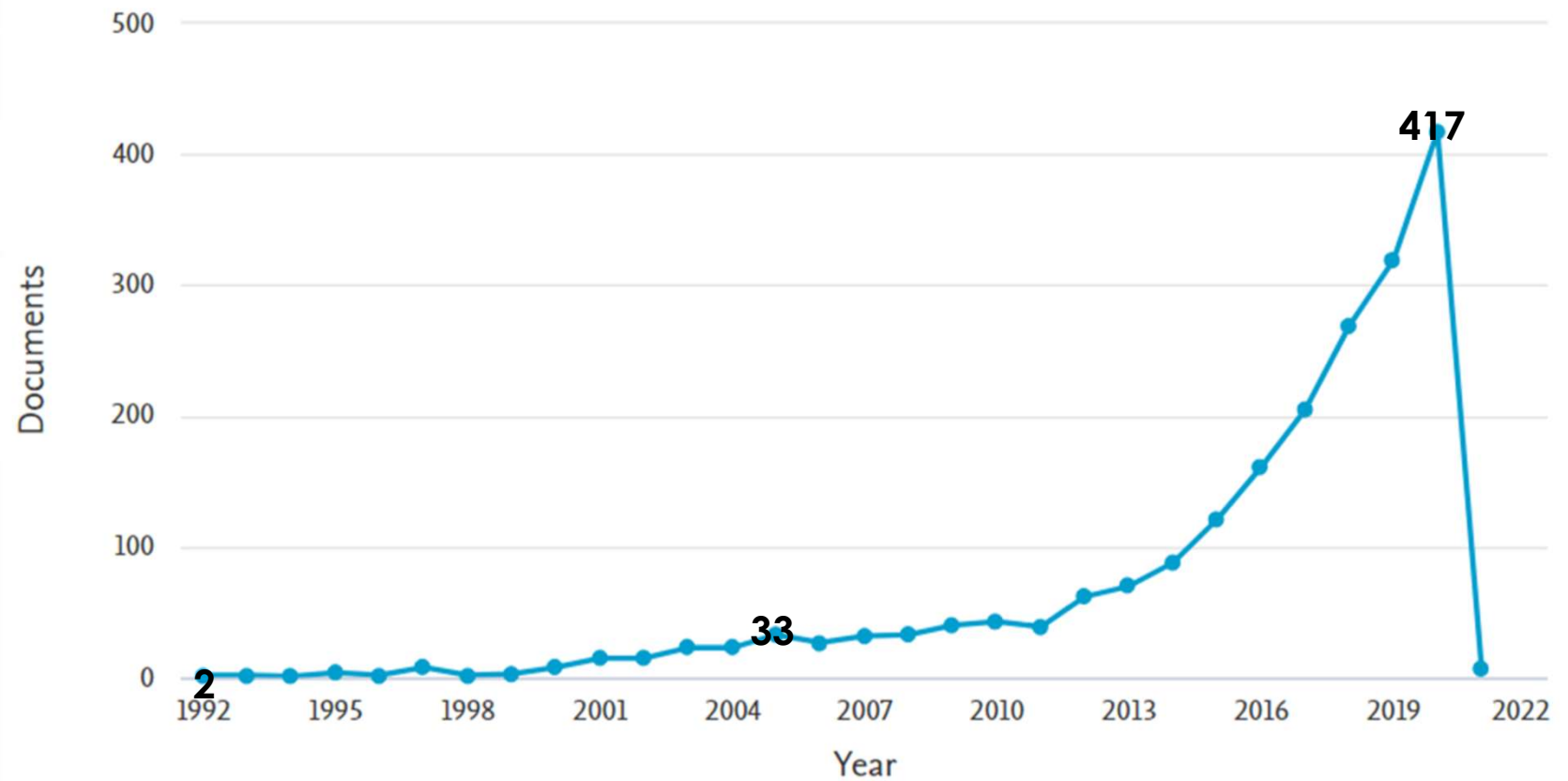

Applications of eDNA analyses

- Detection of cryptic, rare or elusive species
- Detect migrations or reproductive behaviors
- Monitor species abundance changes over time
- Determine species assemblages
- Evaluate monitoring actions
- Create databases

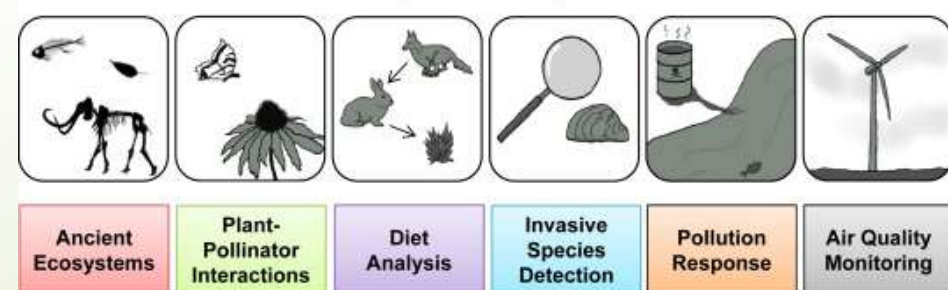

Detection of cryptic, rare or elusive species

- Monitor invasions as a quick detection method
- Studying threatened species (conservation)
- DNA evidence cannot flee or hide

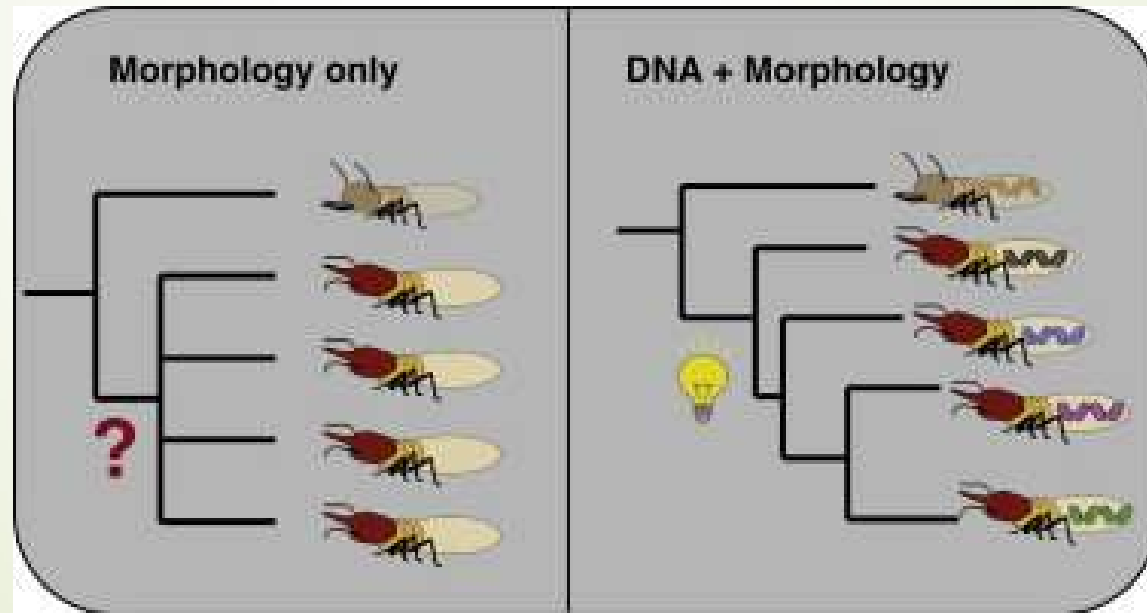

Detection of cryptic, rare or elusive species

Partial list of the animal species studied through eDNA analyses:



Rhône streber
Zingel asper



European pond turtle
Emys orbicularis



Louisiana crayfish
Procambarus clarkii



American bullfrog
Lithobates catesbeianus



Weather loach
Misgurnus fossilis



Common spadefoot
Pelobates fuscus



Great crested newt
Triturus cristatus



Marbled newt
Triturus marmoratus



African clawed toad
Xenopus laevis

...even the more cryptic and elusive species

LOCH TEST MONSTER Scientists to test water of Loch Ness for DNA to find out once and for all if Nessie is real

Professor Neil Gemmell will gather water samples and analyse them using the same techniques as police forensic teams

Sun Reporter

3 Apr 2017, 0:18 | Updated: 4 Apr 2017, 4:50



...even the more cryptic and elusive species

Loch Ness Monster may be a giant eel, say scientists

5 September 2019



GETTY IMAGES

The modern myth of the monster gathered pace in the 1930s but this famous 1934 photo was later revealed to be a fake

The creatures behind repeated sightings of the fabled Loch Ness Monster may be giant eels, according to scientists.

Researchers from New Zealand have tried to catalogue all living species in the loch by extracting DNA from water samples.

Following analysis, the scientists have ruled out the presence of large animals said to be behind reports of a monster.

No evidence of a prehistoric marine reptile called a plesiosaur or a large fish such as a sturgeon were found.

Catfish and suggestions that a wandering Greenland shark were behind the sightings were also discounted.



UNIVERSITY OF OTAGO

Prof Neil Gemmill and his team collected water samples from Loch Ness

...but some clarifications on the eDNA technique are needed:

OPEN ACCESS Freely available online



Persistence of Environmental DNA in Freshwater Ecosystems

Tony Dejean^{1,2,3}, Alice Valentini^{1,2}, Antoine Duparc², Stéphanie Pellier-Cuit⁴, François Pompanon⁴, Pierre Taberlet⁴, Claude Miaud^{2*}

1 SPYGEN, Savoie Technolac - BP 274, Le Bourget-du-Lac, France, **2** Laboratoire d'Ecologie Alpine, UMR CNRS 5553, Université de Savoie, Le Bourget-du-Lac, France, **3** Parc Naturel Régional Périgord-Limousin, La Coquille, France, **4** Laboratoire d'Ecologie Alpine, UMR CNRS 5553, Université Grenoble I, Grenoble, France

OPEN ACCESS Freely available online



Persistence of DNA in Carcasses, Slime and Avian Feces May Affect Interpretation of Environmental DNA Data

Christopher M. Merkes^{1,2*}, S. Grace McCalla², Nathan R. Jensen², Mark P. Gaikowski², Jon J. Amberg²

1 IAP Worldwide Services Inc., Upper Midwest Environmental Sciences Center, La Crosse, Wisconsin, United States of America, **2** United States Geological Survey, Upper Midwest Environmental Sciences Center, La Crosse, Wisconsin, United States of America



eDNA analysis of *A. torrentium* in Italy

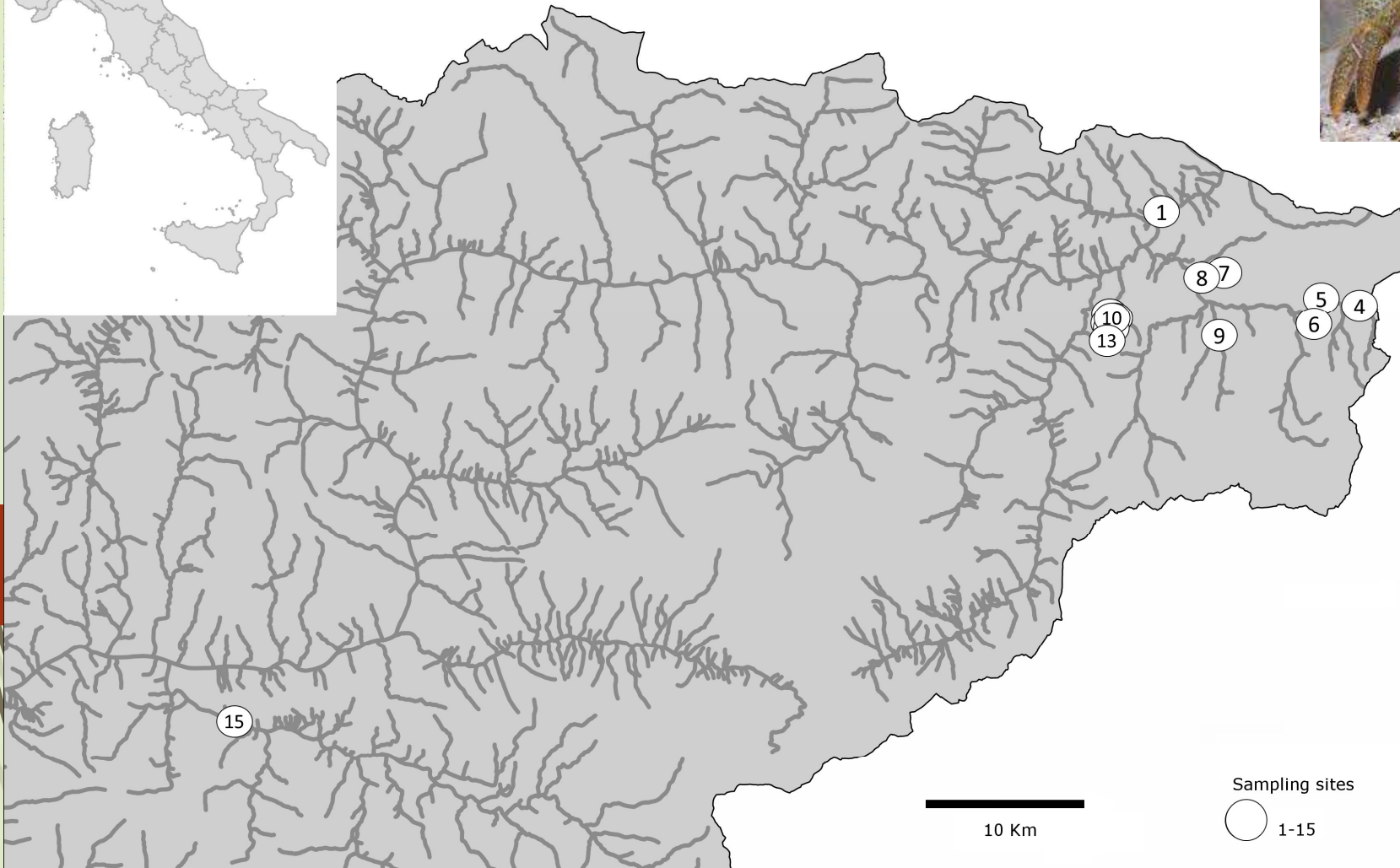

Early detection of invasive species



ISSUES BRIEF

Invasive alien species and climate change

- Invasive alien species (IAS) are animals, plants or other organisms that are introduced into places outside their natural range, negatively impacting native biodiversity, ecosystem services or human well-being.
- IAS are one of the biggest causes of biodiversity loss and species extinctions, and are also a global threat to food security and livelihoods.
- IAS are compounded by climate change. Climate change facilitates the spread and establishment of many alien species and creates new opportunities for them to become invasive.
- IAS can reduce the resilience of natural habitats, agricultural systems and urban areas to climate change. Conversely, climate change reduces the resilience of habitats to biological invasions.
- It is essential that IAS be incorporated into climate change policies. This includes **biosecurity measures to prevent the introduction of IAS** to new regions as a result of climate change, and **rapid response measures to monitor and eradicate alien species** that may become invasive due to climate change.

Early detection of invasive species

Early Detection

While invasive species. **Early potential invasion** EDRR span t needs of our EDRR efforts where

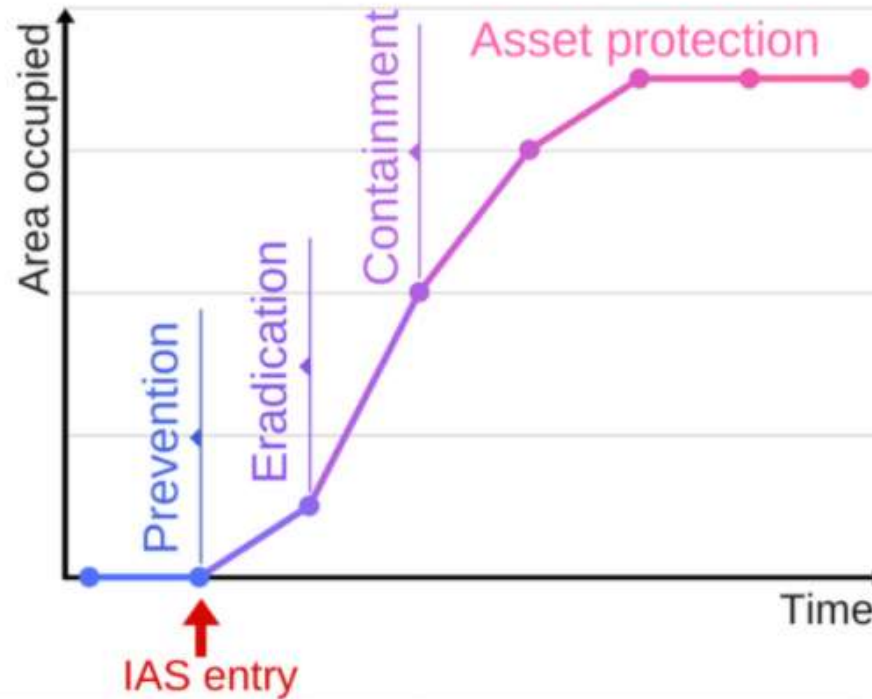

to stop all invasive **find and eradicate** that support to address the implementation of rapid response

www.usgs.gov

Genetic analyses – *A. pallipes* e *P. clarkii* in FVG (Italy)

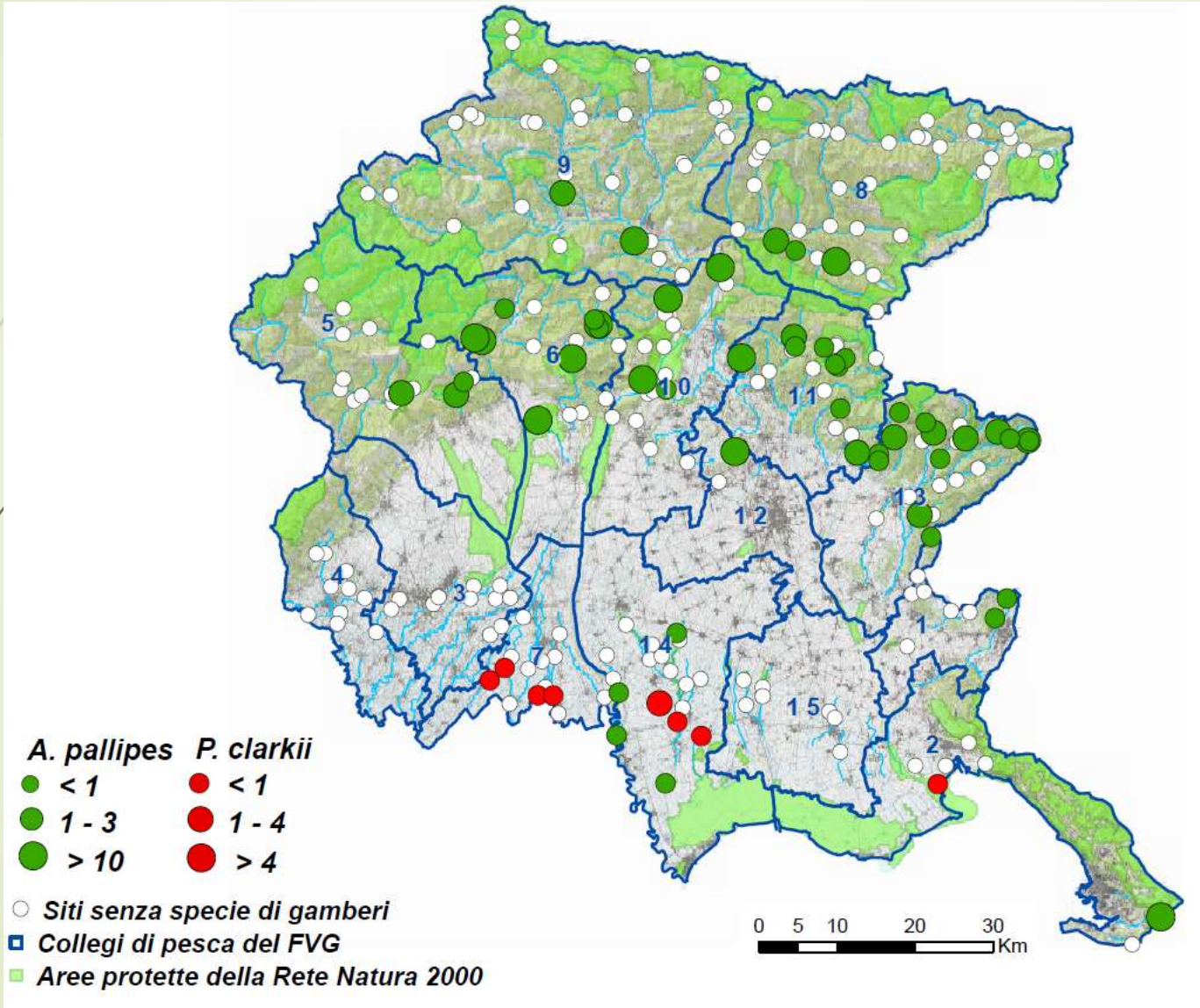

Genetic analyses – *A. pallipes* and *P. clarkii* in FVG

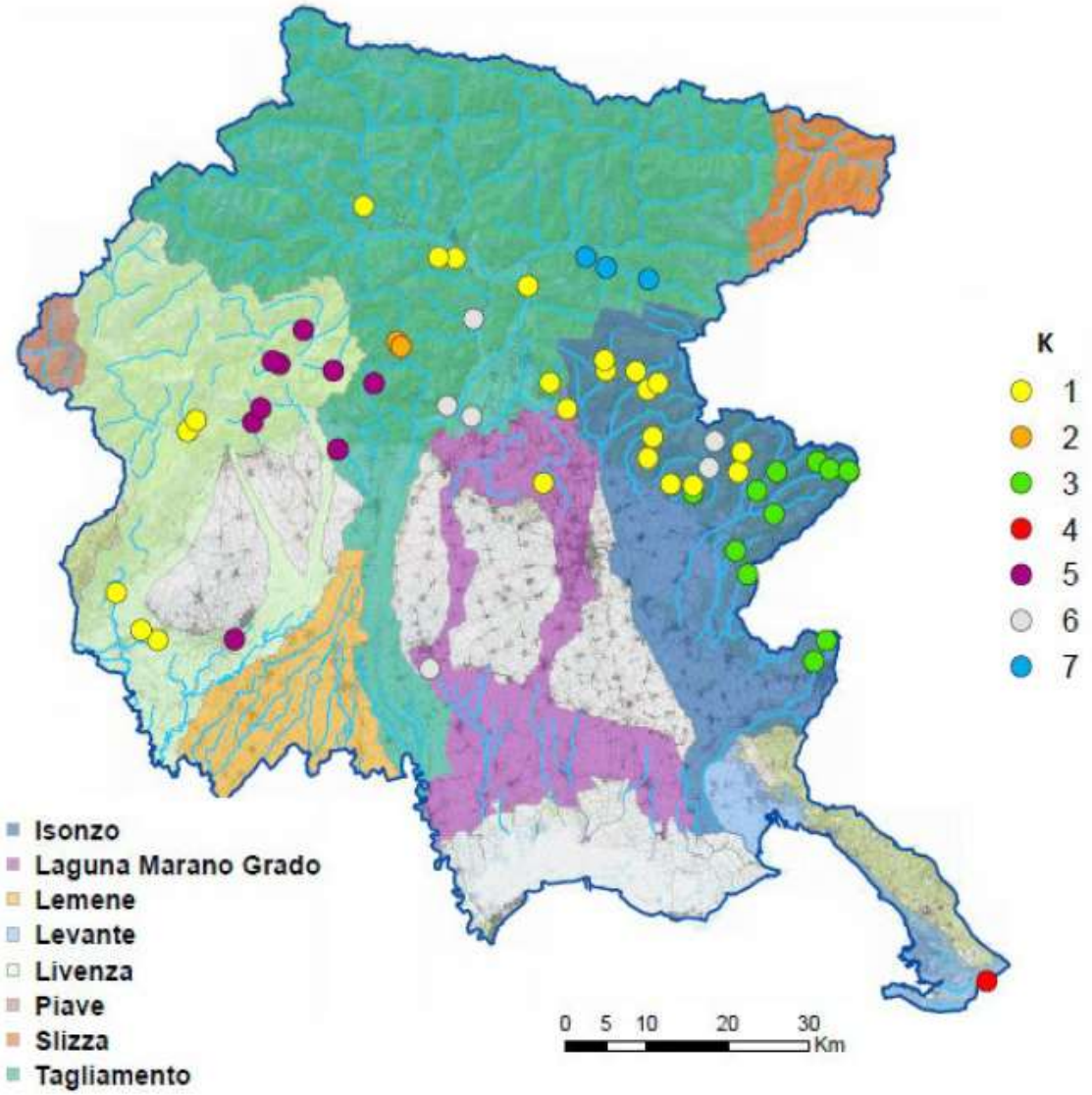



eDNA detection to monitor P. clarkii in Slovenia

