

Modern

MODULARITA'
SECTIONAL DESIGN

Moduli a terra
Self standing units

Larghezze e altezze / Widths and heights

	H.200	L.400	L.600	L.800	L.1200	L.1600
H.300						
H.400						
H.600						
H.800						
H.1200						
H.1600						
P.445						
P.580						

Moduli pensili
Hanging units

Larghezze e altezze / Widths and heights

	H.200	L.400	L.800	L.1200	L.1600
H.300					
H.400					
H.600					
H.1200					
H.1600					
P.340					
P.445					
P.580					

Modern

MODULARITA'
SECTIONAL DESIGN

Moduli pensili in cristallo
Profondità 300
Glass hanging elements
Depth 300



Pedane
Profondità 600/800
Boards
Depth 600/800

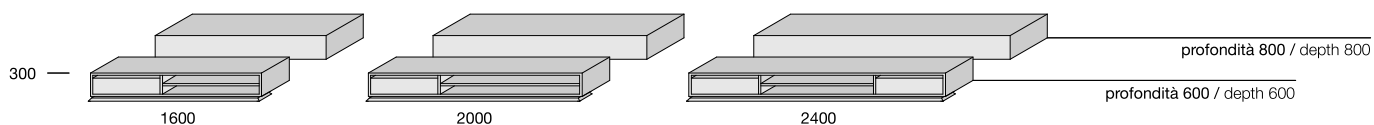
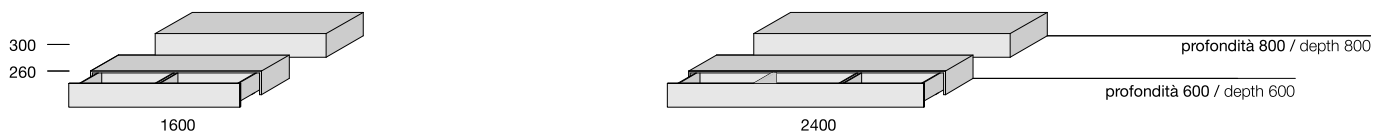
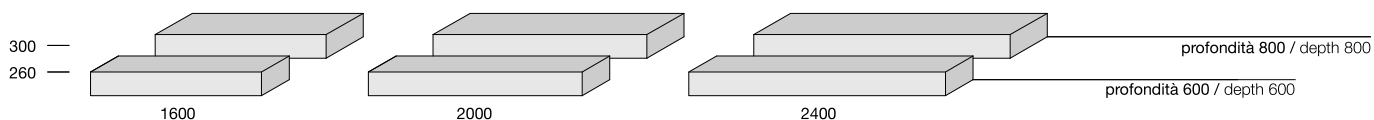

Piano sospeso
Suspended shelf

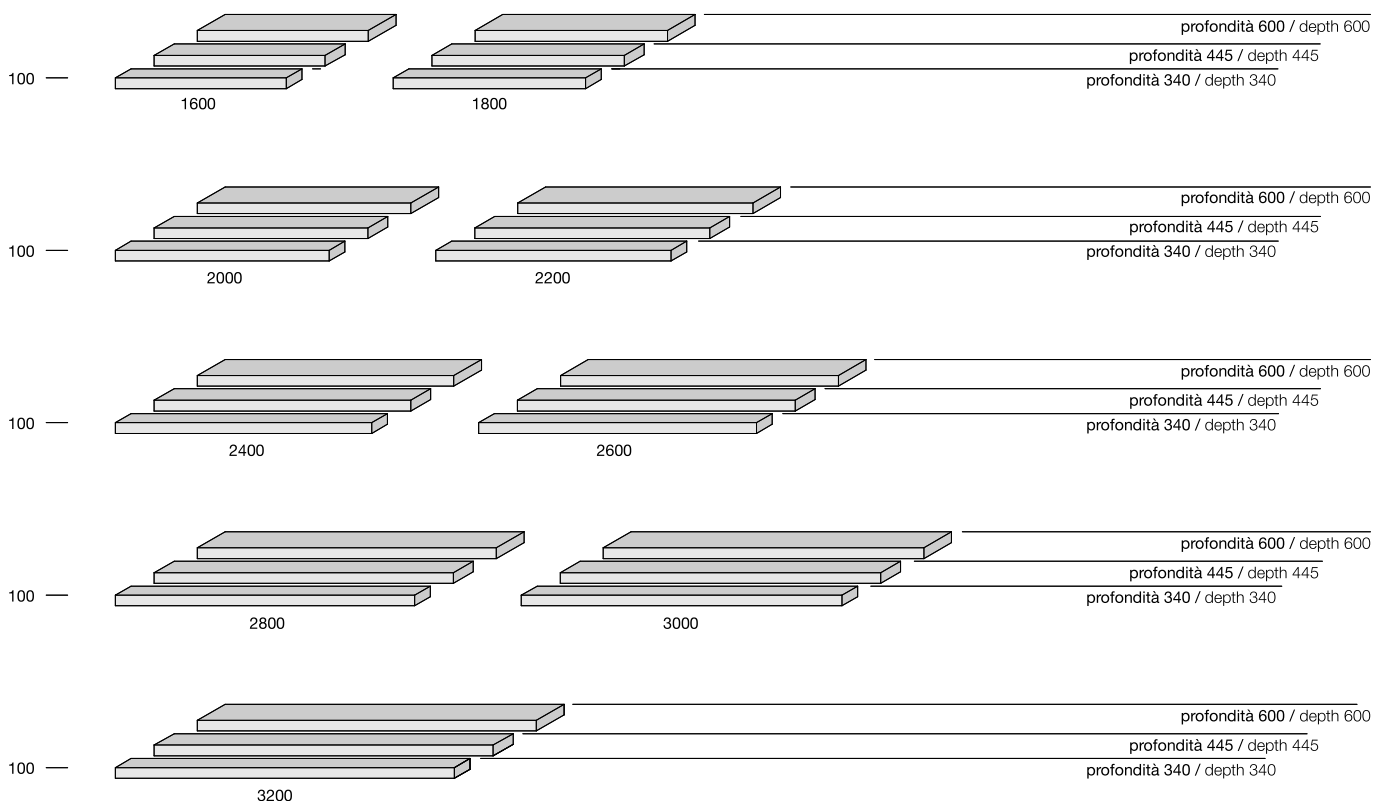

Pannello
Panel

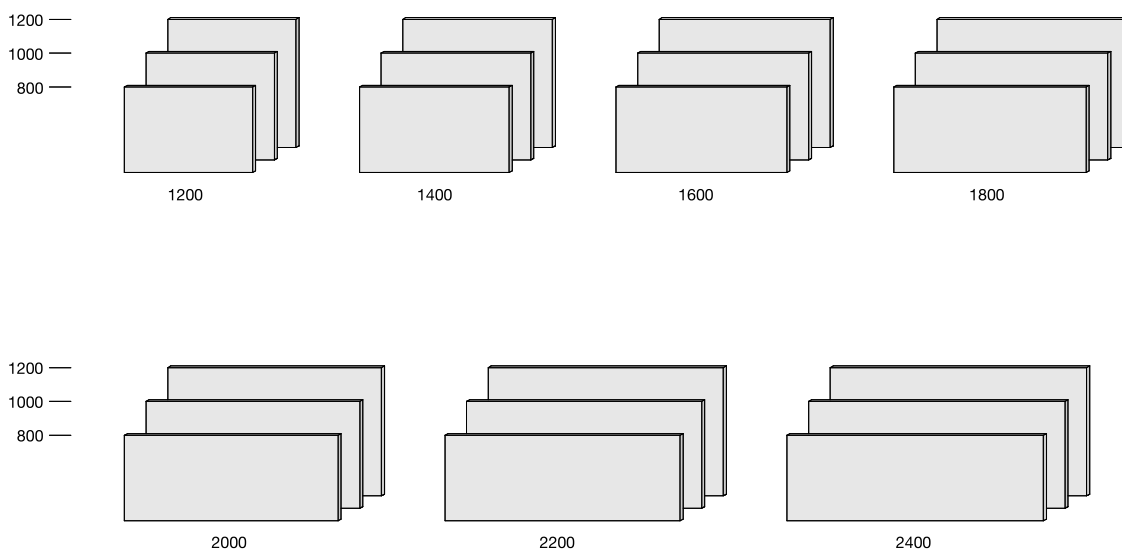

Modern

MODULARITA'
SECTIONAL DESIGN

Moduli sovrapposti Stackable elements

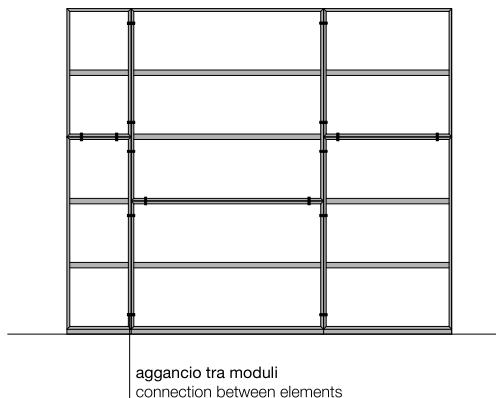
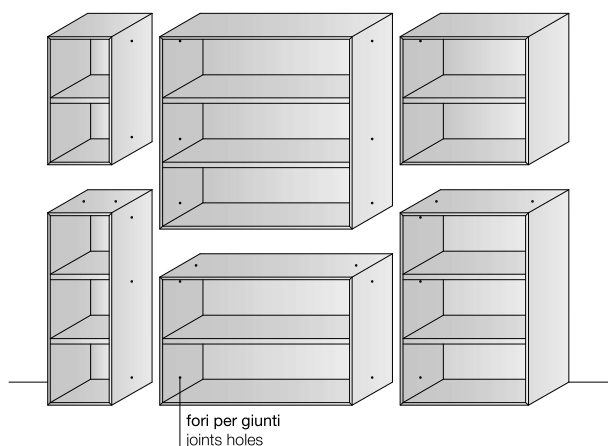

Moduli sospesi Hanging elements

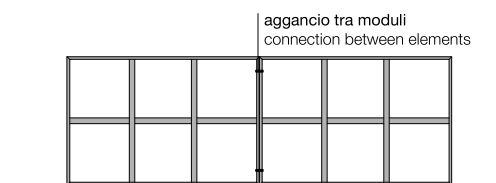
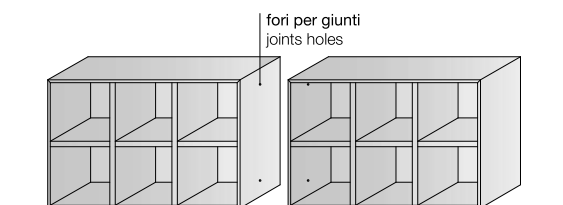
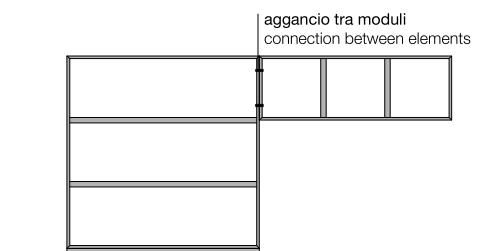
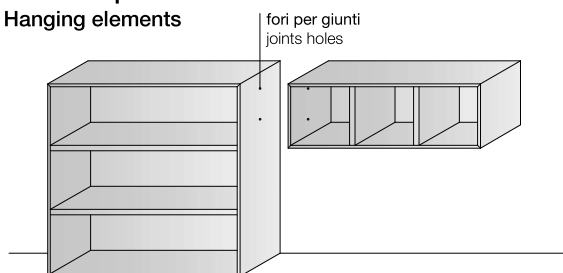

Aggancio tra moduli Connection between elements

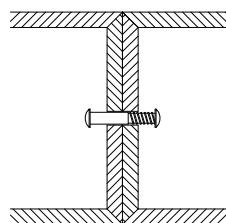
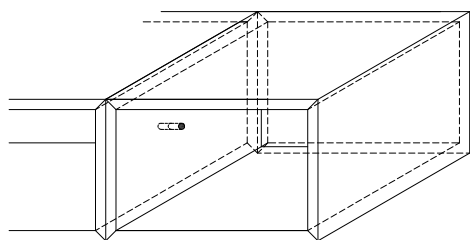

NOTE

I moduli affiancati o sovrapposti sono forati e fissati tra loro. Specificare al momento dell'ordine la posizione dei moduli.

NOTE

The connected or stackable elements are drilled and fixed among each others. Please specify the elements position at order.

Componibilità dei moduli Elements modularity

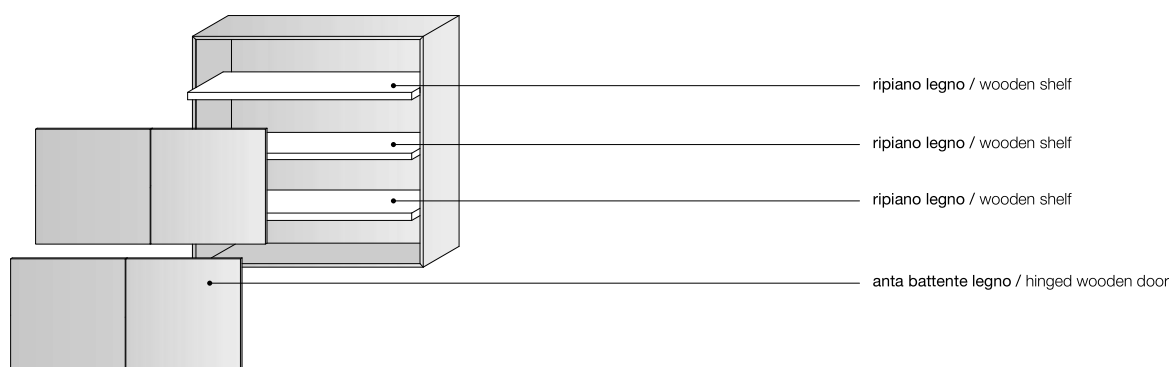
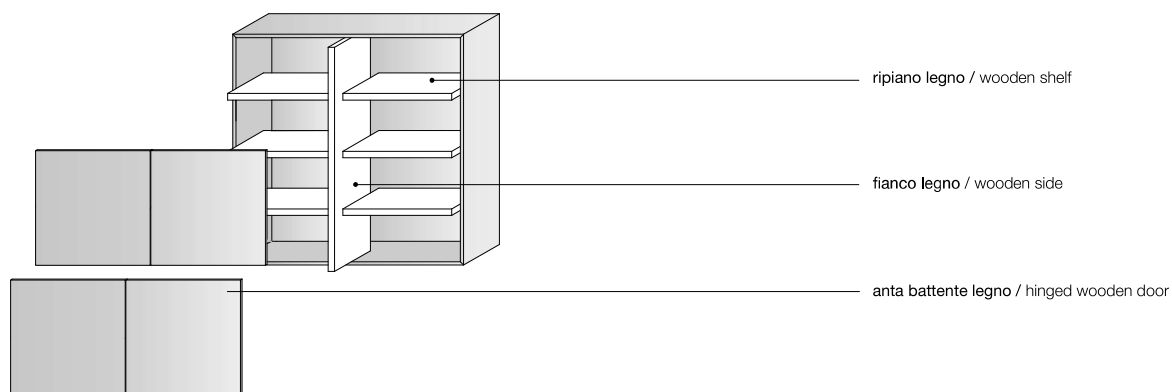
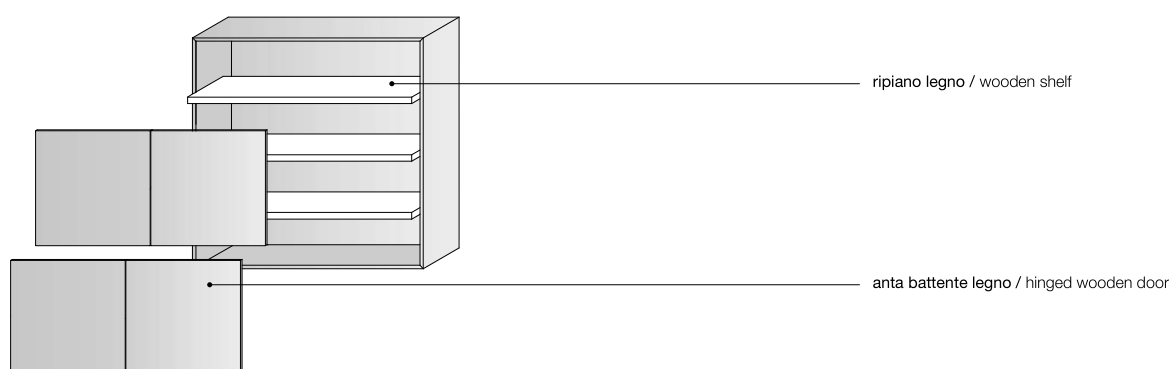
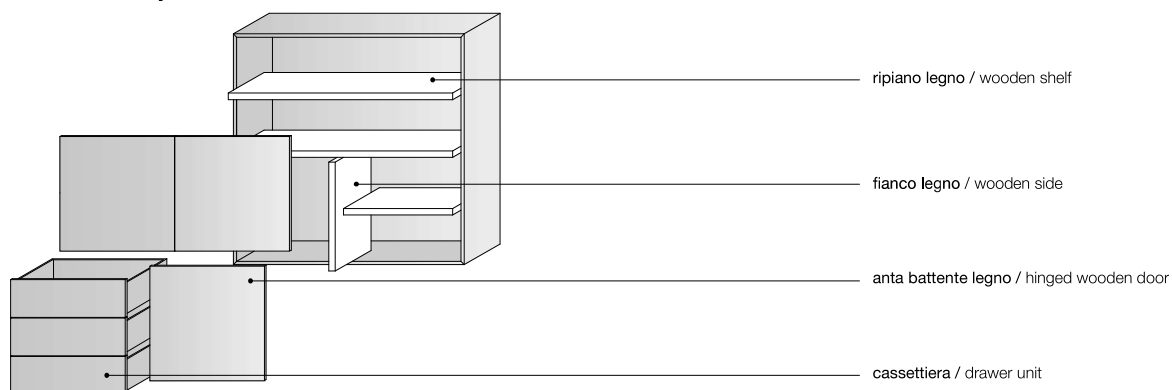

NOTE

Modern è un sistema di grande versatilità. Le numerose componenti permettono molteplici combinazioni che consentono di organizzare gli spazi sia all'interno che all'esterno del modulo.

NOTE

Modern has a great flexibility. The large range of elements allows various combination that allow the organization of the space inside and outside the module.

Modern

MODULI ATTREZZATI EQUIPPED ELEMENTS

Modern

MODULI ATTREZZATI EQUIPPED ELEMENTS

Legenda tipo frontali Fronts range

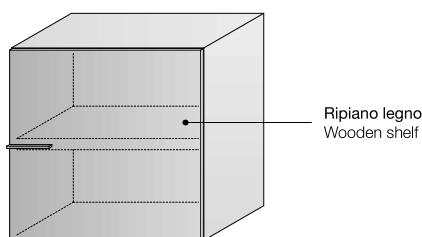

Modulo con anta battente legno
Element with hinged wooden door

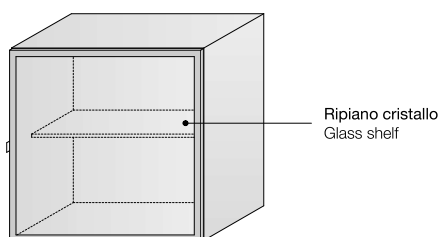

Modulo con anta battente cristallo trasparente
Element with hinged transparent glass door

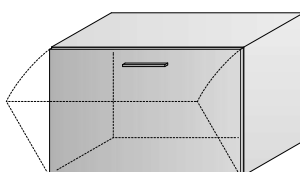

Modulo con anta ribalta
Element with drop-leaf door

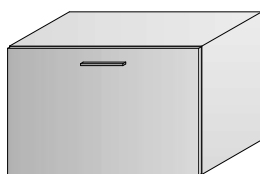

Modulo con cassetto
Element with drawer

NOTE

Dietro le ante in legno sono stati calcolati fianchi e ripiani in legno. Dietro le ante in cristallo sono stati calcolati ripiani in cristallo.

I moduli attrezzati riportati non comprendono zoccoli / piedi (vedi pag. 128-129) ed eventuali piani di copertura (vedi pag. 148), specificare al momento dell'ordine. Nel caso di moduli attrezzati con anta battente o a ribalta, indicare il senso di apertura.

I prezzi dei moduli attrezzati sono da considerarsi a puro titolo indicativo.

NOTE

Behind wooden doors, sides and shelves have been considered. Behind cristal doors, glass shelves have been considered.

The indicated equipped elements don't include baseboards / feet (see pages 128-129) and possible cover panels (see pages 148) to be specified at order. For equipped elements with hinged doors or drop-leaf doors, please indicate the opening direction.

The price of the equipped elements is only indicative.