

# Storage

FINITURA SU FIANCO  
SIDE FINISH

FINITURA SU FIANCO E SORMONTO ANTA  
SIDE FINISH AND DOOR OVERLAP

1. FIANCO TERMINALE SENZA FINITURA CON SORMONTO PARZIALE DELL'ANTA - DEFAULT  
END SIDE PANEL WITHOUT FINISHING WITH PARTIAL DOOR OVERLAP - DEFAULT



HDS bianco  
melamminico ciliegio white  
melamminico hemlock cenere  
melamminico mongoi  
melamminico eucalipto  
melamminico black sugi

white HDS  
ciliegio white melamine  
"cenere" hemlock melamine  
mongoi melamine  
eucalyptus melamine  
black sugi melamine

2. FINITURA SU FIANCO CON SORMONTO PARZIALE DELL'ANTA (BORDO ANTERIORE FINITO)  
SIDE FINISH WITH PARTIAL DOOR OVERLAP (FINISHED FRONT EDGE)



laccato opaco colori  
laccato lucido colori  
legni  
cuoio

matt lacquered colours  
glossy lacquered colours  
wood  
saddle leather

FINITURA SU FIANCO E SORMONTO ANTA  
SIDE FINISH AND DOOR OVERLAP

3. FIANCO TERMINALE SENZA FINITURA CON SORMONTO TOTALE DELL'ANTA  
END SIDE WITHOUT FINISHING WITH TOTAL DOOR OVERLAP



HDS bianco  
melamminico ciliegio white  
melamminico hemlock cenere  
melamminico mongoi  
melamminico eucalipto  
melamminico black sugi

white HDS  
ciliegio white melamine  
"cenere" hemlock melamine  
mongoi melamine  
eucalyptus melamine  
black sugi melamine

4. FINITURA SU FIANCO CON SORMONTO TOTALE DELL'ANTA (BORDO ANTERIORE DEL FIANCO FINITO)  
SIDE FINISH WITH TOTAL DOOR OVERLAP (FRONT EDGE OF THE FINISHED SIDE)



laccato opaco colori  
laccato lucido colori  
legni  
cuoio

matt lacquered colours  
glossy lacquered colours  
wood  
saddle leather

# Storage

CARATTERISTICHE DELL'ARMADIO  
WARDROBE FEATURES

ARMADIO CON FIANCO LEGNO  
WARDROBE WITH WOODEN SIDE

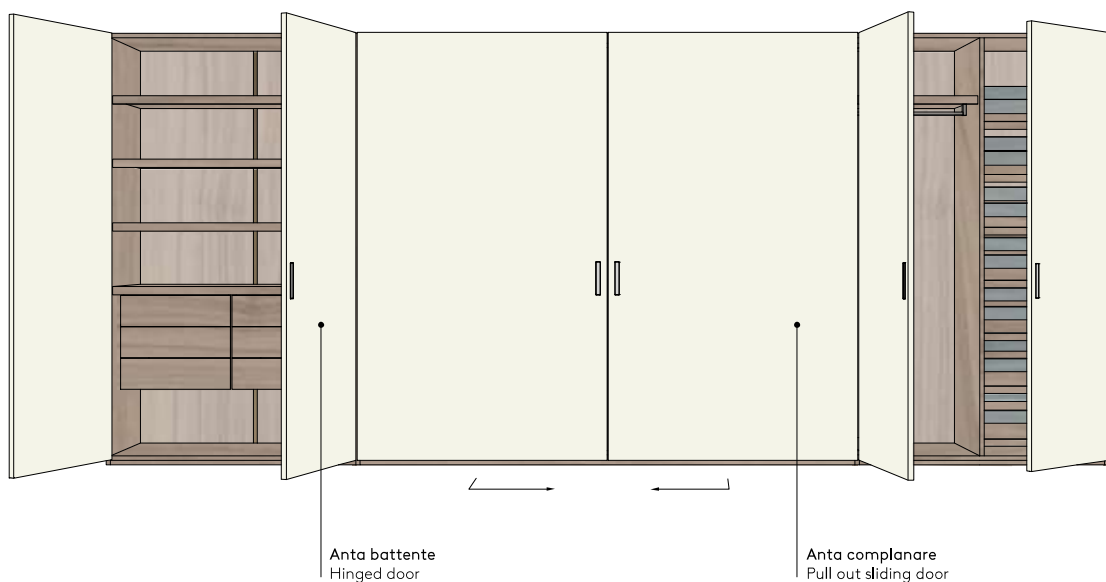
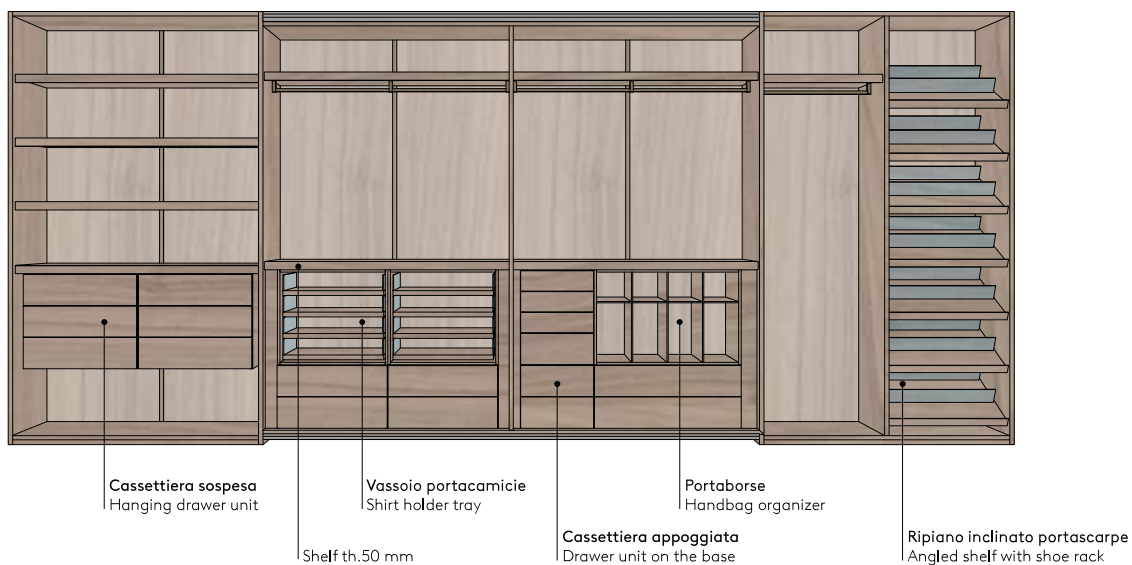
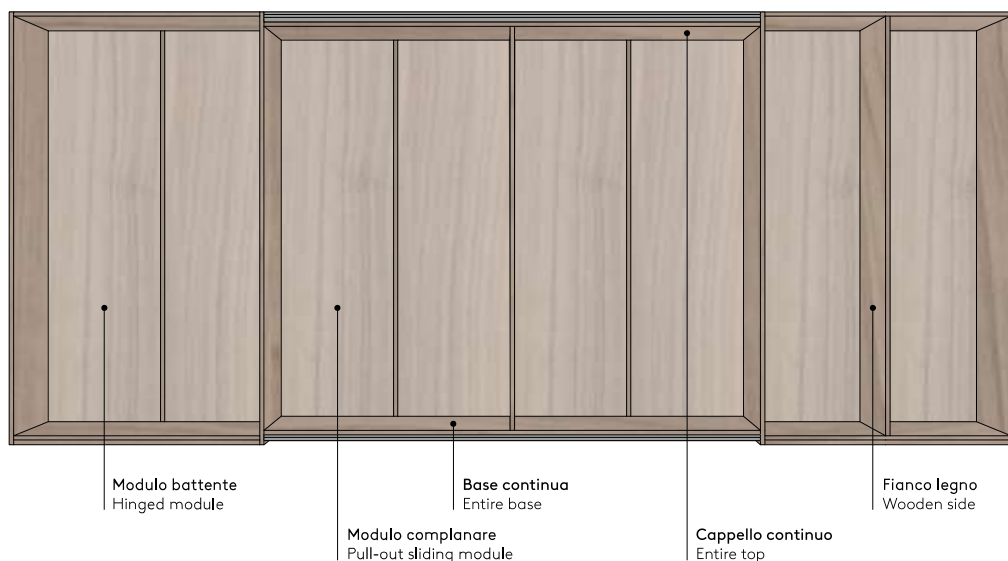

ARMADIO CON MONTANTE VERNICIATO INTERNO  
WARDROBE WITH INTERNAL VARNISHED UPRIGHT

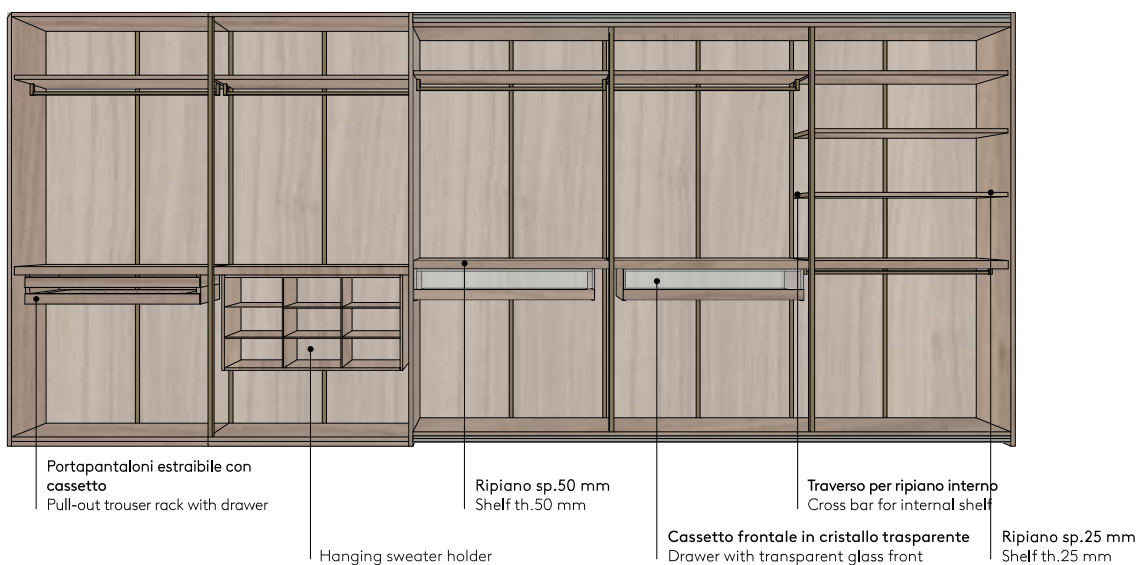
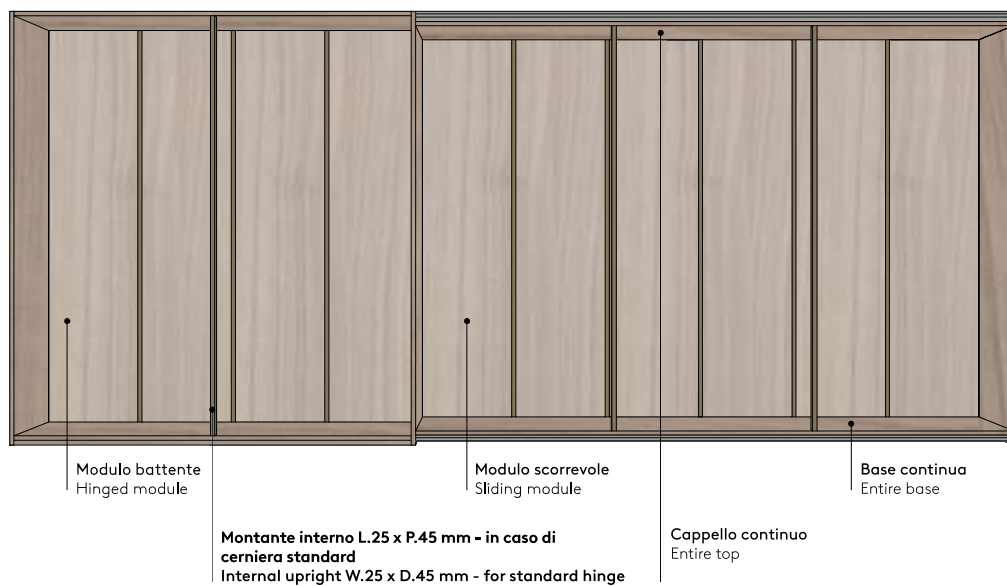

# Storage

CARATTERISTICHE DELL'ARMADIO  
WARDROBE FEATURES

ARMADIO APERTO TRASPARENTE  
TRANSPARENT OPEN WARDROBE

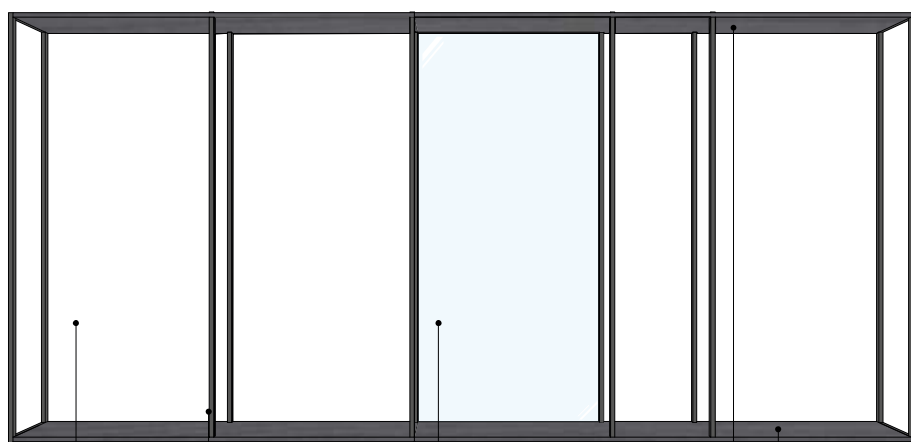

Modulo a giorno  
Open module

Fondale obbligatorio  
Compulsory back panel

Base continua  
Entire base

Montante interno L.25 x P.25 mm - in caso di moduli a giorno  
Internal upright W.25 x D.25 mm - for open modules

Cappello continuo  
Entire top

Montante esterno L.25 x P.25 mm - in caso di modulo a giorno  
External upright - W.25 x D.25 mm - for open modules



Hanging drawer unit

Shelf th.25 mm

Traverso per ripiano interno  
Cross bar for internal shelf

Cassettiera appoggiata  
Drawer unit on the base

## NOTE TECNICHE

Su ogni composizione è obbligatorio l'inserimento di un fondale strutturale.  
Per composizioni molto lunghe, ogni 3 metri deve essere previsto un fondale strutturale.  
In caso di composizioni con angoli, il fondale strutturale deve essere previsto su ogni lato.

## TECHNICAL NOTES

A compulsory back panel must be placed on each composition.  
For long composition, each 3 meters must be placed a compulsory back panel.  
In case of corner compositions, the compulsory back panel must be placed on each side.

ARMADIO CHIUSO TRASPARENTE  
TRANSPARENT CLOSED WARDROBE

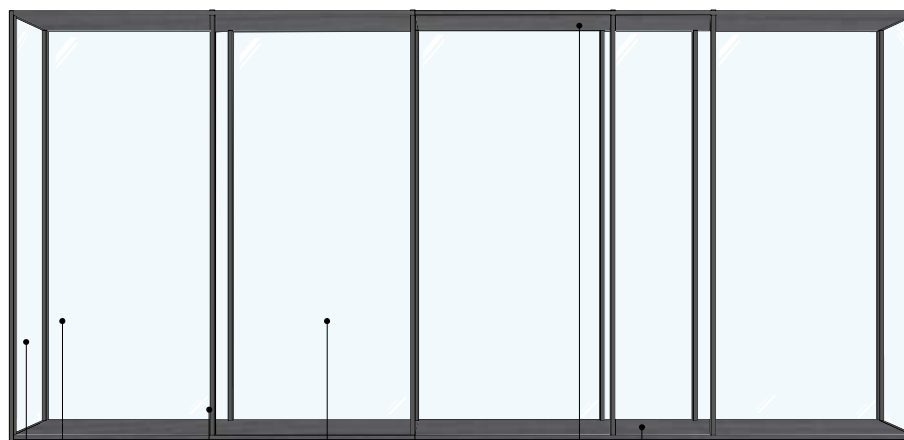

Modulo battente  
Hinged module

Fondale in cristallo  
Glass back panel

Base continua  
Entire base

Fianco in cristallo  
Glass side panel

Montante interno L.25 x P.25 mm - in caso di  
cerniera cardine  
Internal upright W.25 x D.25 mm - for pivo

Entire top

Montante esterno  
L.25 x P.25 mm - in caso di  
cerniera cardine  
External upright W.25 X D.25  
mm - for pivot hinge



Vassoi portacamicie  
Shirts holder trays

Ripiano sp.50 mm  
Shelf th.50 mm

Portaborse  
Bags holder

Portamaglioni  
Sweater holder

Cross bar for internal shelf

Ripiano luminoso in cristallo trasparente  
Lighted transparent glass shelf

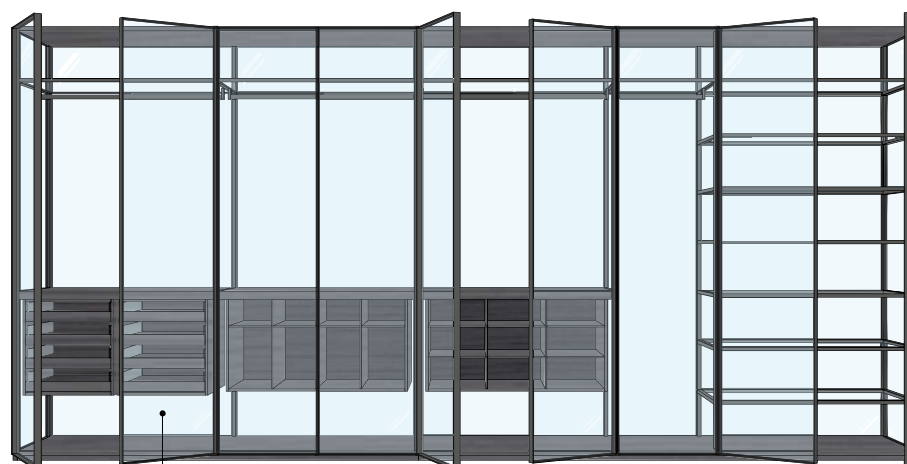

Anta battente Iron  
Iron hinged door

# Storage

## CARATTERISTICHE DELL'ARMADIO WARDROBE FEATURES

### ARMADIO BATTENTE E APERTO HINGED AND OPEN WARDROBE

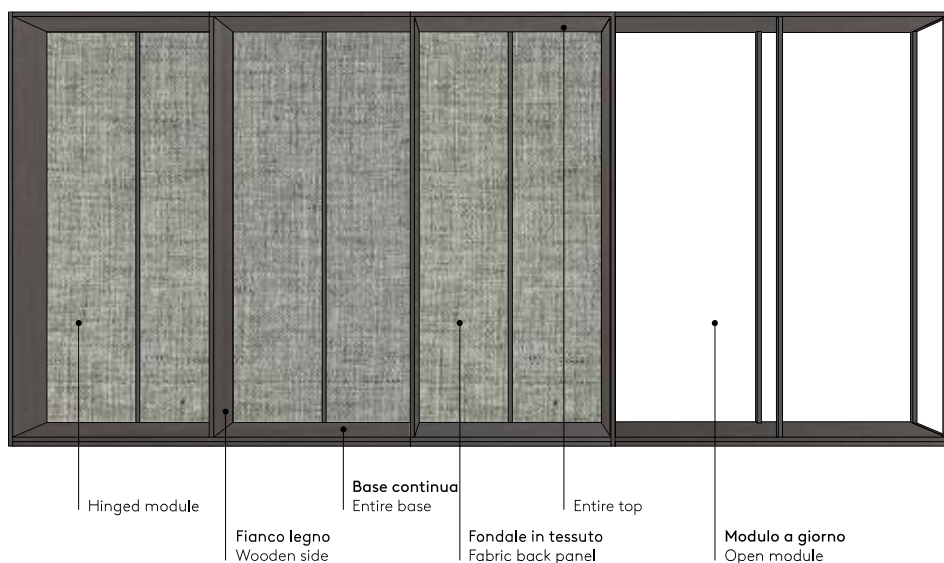

## ARMADIO BATTENTE E APERTO HINGED AND OPEN WARDROBE

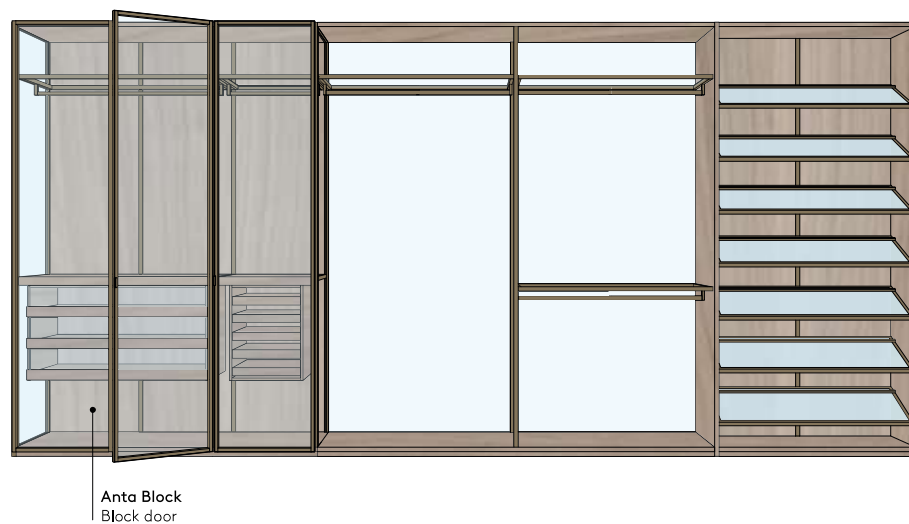
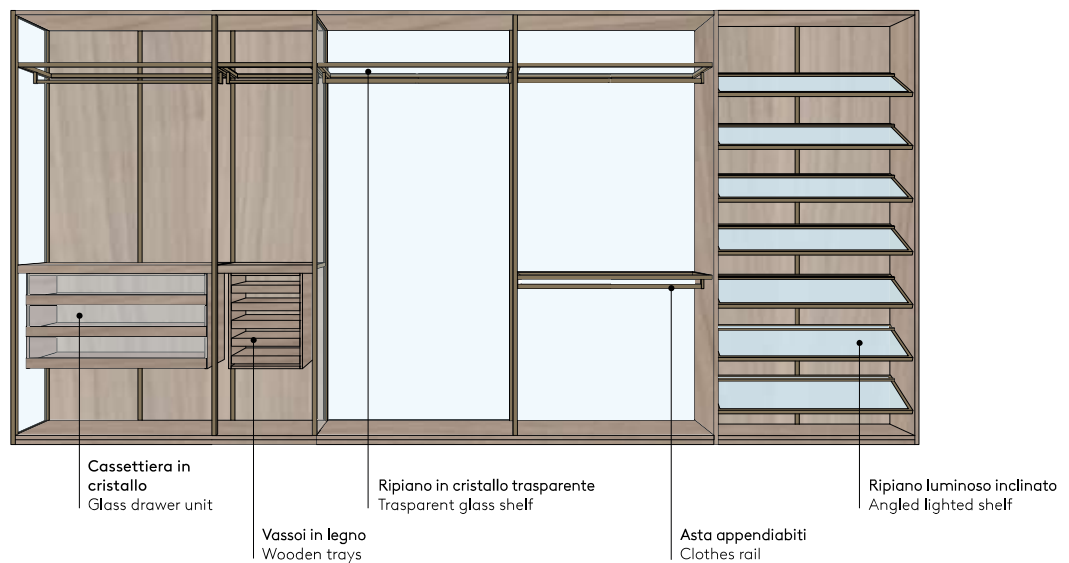
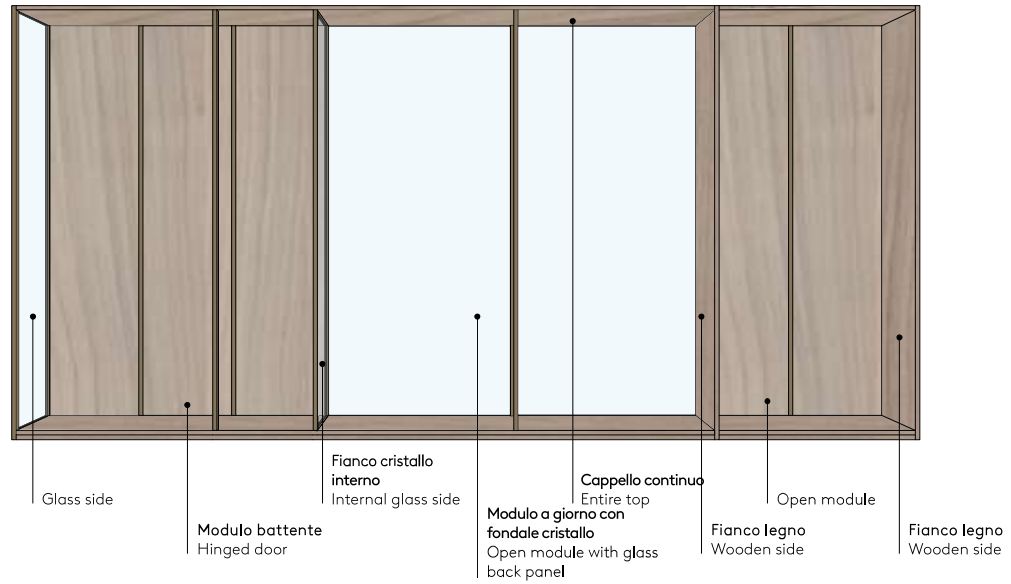



# Storage

CARATTERISTICHE DELL'ARMADIO  
WARDROBE FEATURES

## CABINA ARMADIO CON MONTANTE ESTERNO VERNICIATO WALK-IN-CLOSET WITH EXTERNAL VARNISHED UPRIGHT

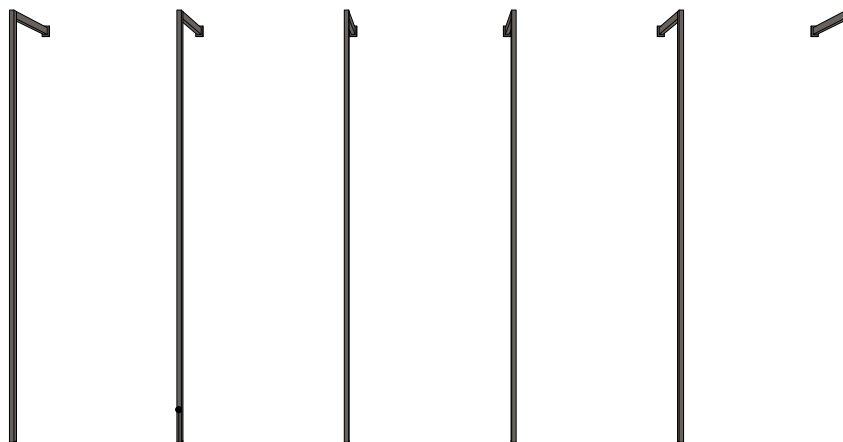

Montante esterno L.25 x P.45 mm - in caso di cabina armadio  
External upright W.25 x D.45 mm - for walk-in-closet

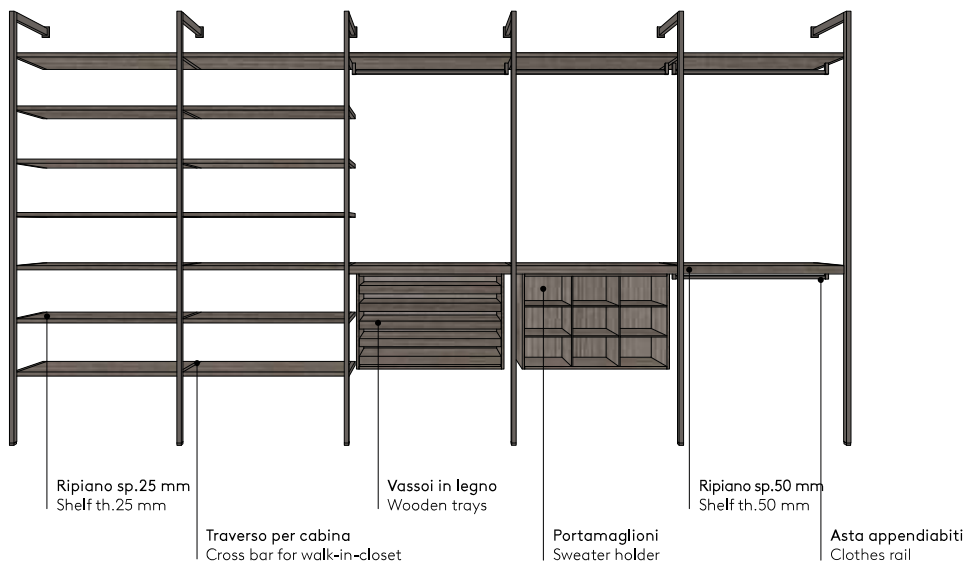

BOISERIE  
BOISERIE

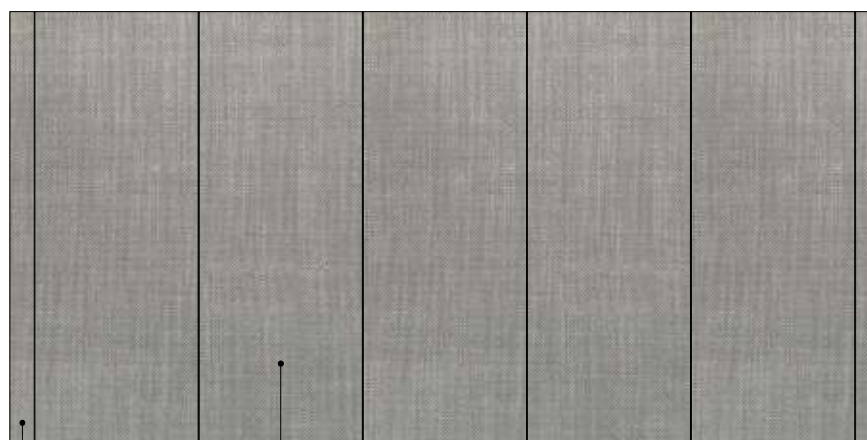

Fascia di chiusura  
Closure side filler

Pannello  
Panel



Mensola sp.50 mm  
Shelf th.50 mm

Ripiano inclinato portascarpe  
Angled shelf with shoe rack

Pedana  
Board

Cassettiera su pedana  
Drawer unit on board

Ripiano luminoso in cristallo trasparente  
Lighted transparent glass shelf

# Storage

## SEZIONI SECTIONS

### ARMADIO A GIORNO OPEN WARDROBE

Tolleranze per il montaggio : +30 mm in altezza / +30 mm in larghezza  
 Assembly tolerances: +30 mm in height / +30 mm in width

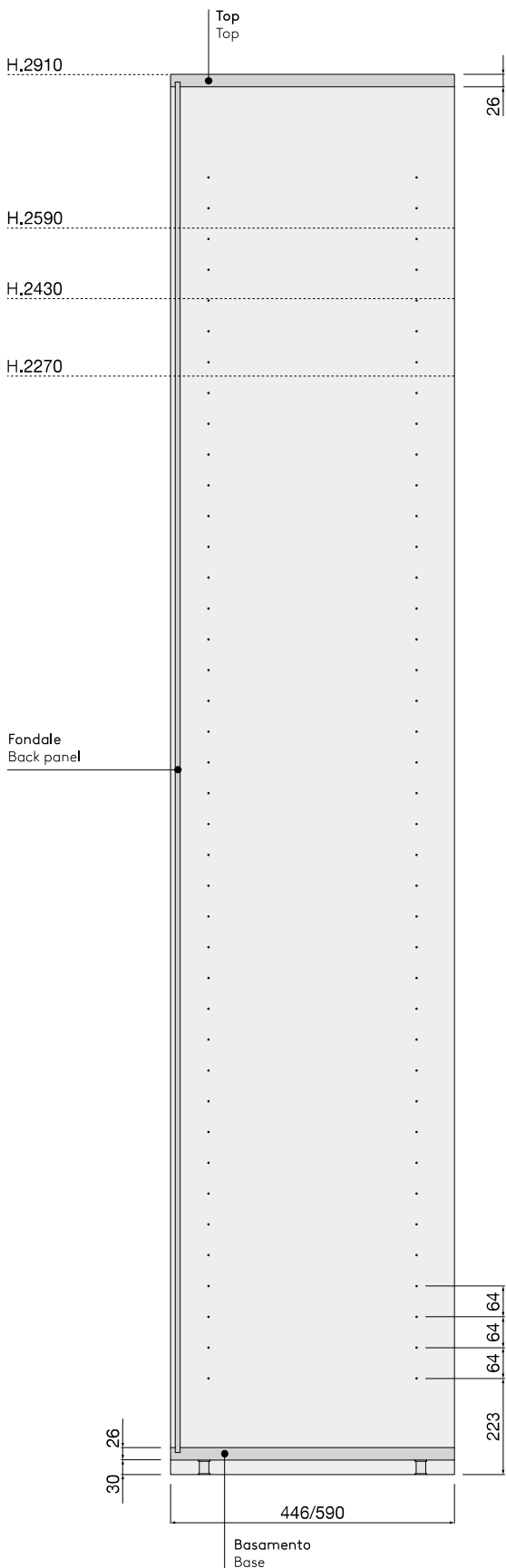

### ARMADIO CON ANTA BATTENTE HINGED DOOR WARDROBE

Tolleranze per il montaggio : +30 mm in altezza / +30 mm in larghezza  
 Assembly tolerances: +30 mm in height / +30 mm in width

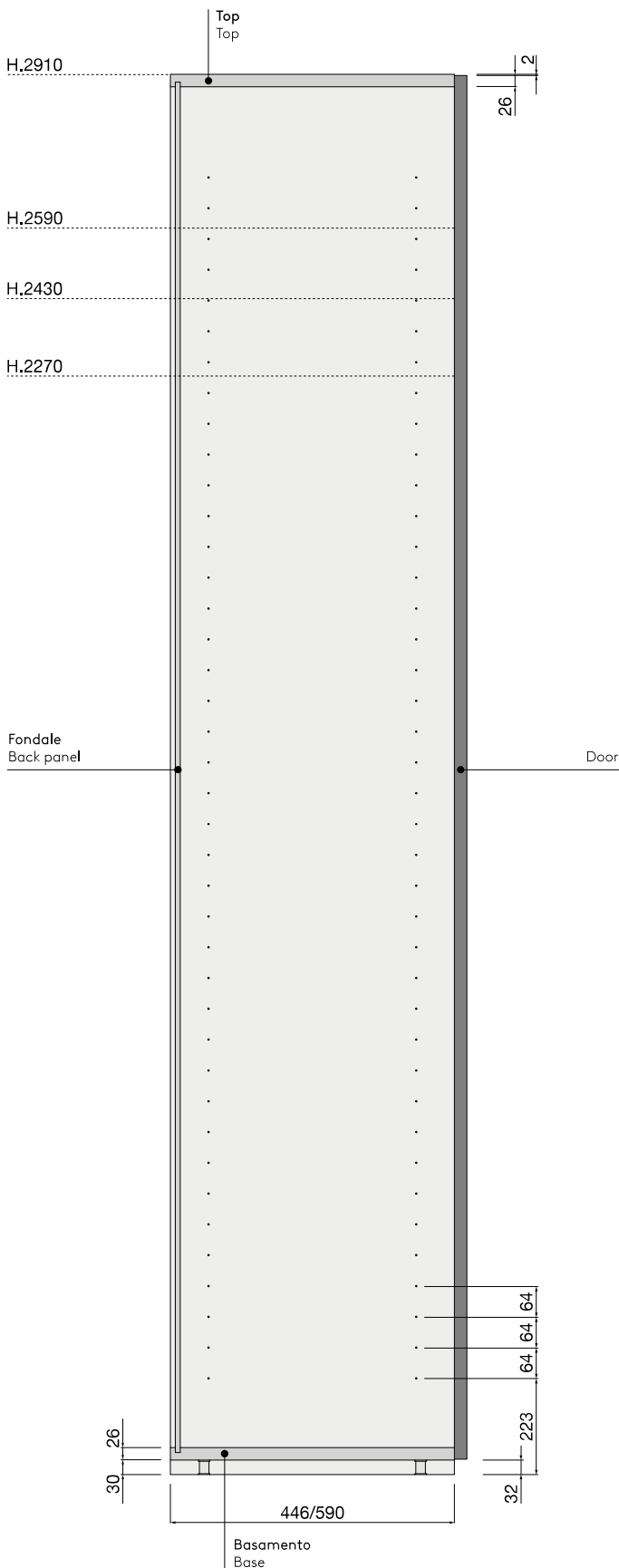

**ARMADIO CON ANTA COMPLANARE**  
**PULL-OUT SLIDING DOOR WARDROBE**

**Tolleranze per il montaggio : +70 mm in altezza / +30 mm in larghezza**  
**Assembly tolerances: +70 mm in height / +30 mm in width**

**ARMADIO CON ANTA SCORREVOLE**  
**SLIDING DOOR WARDROBE**

**Tolleranze per il montaggio : +70 mm in altezza / +30 mm in larghezza**  
**Assembly tolerances: +70 mm in height / +30 mm in width**

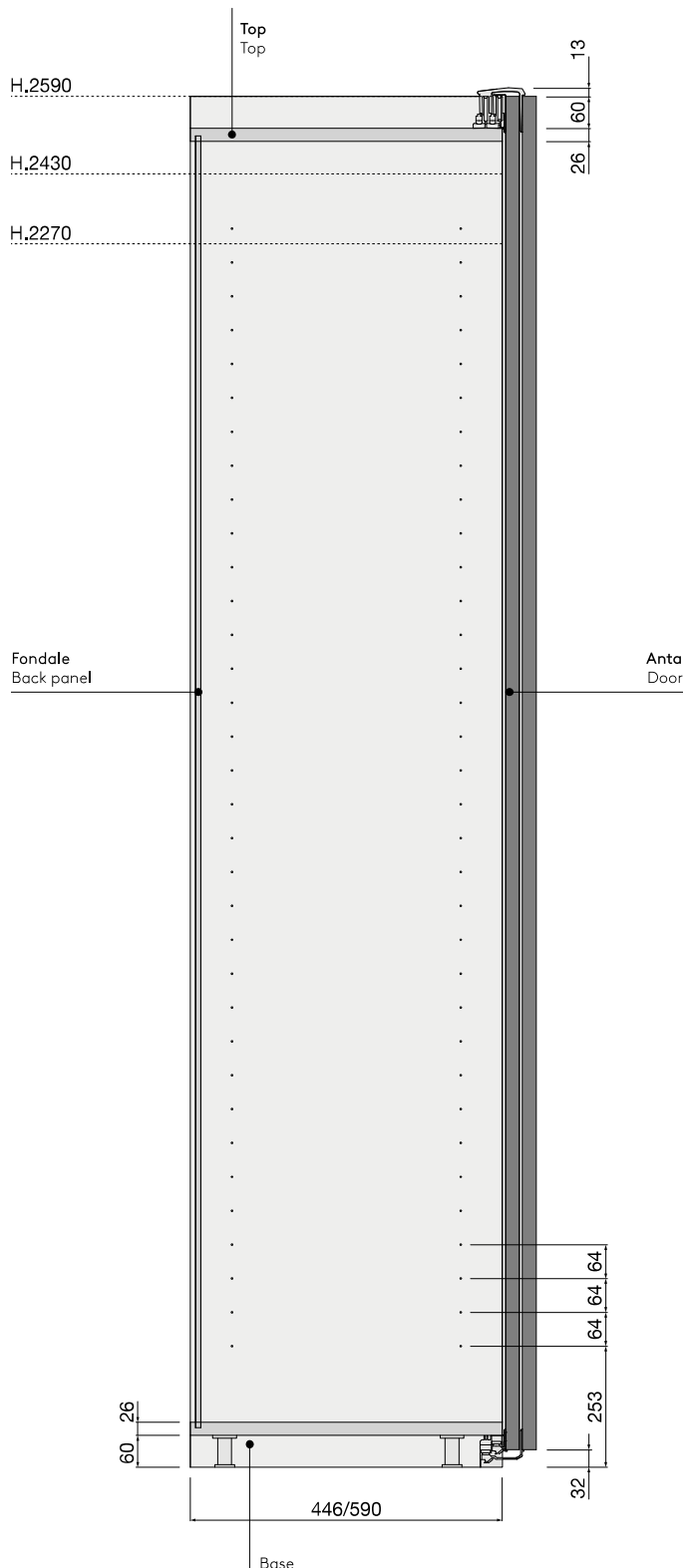
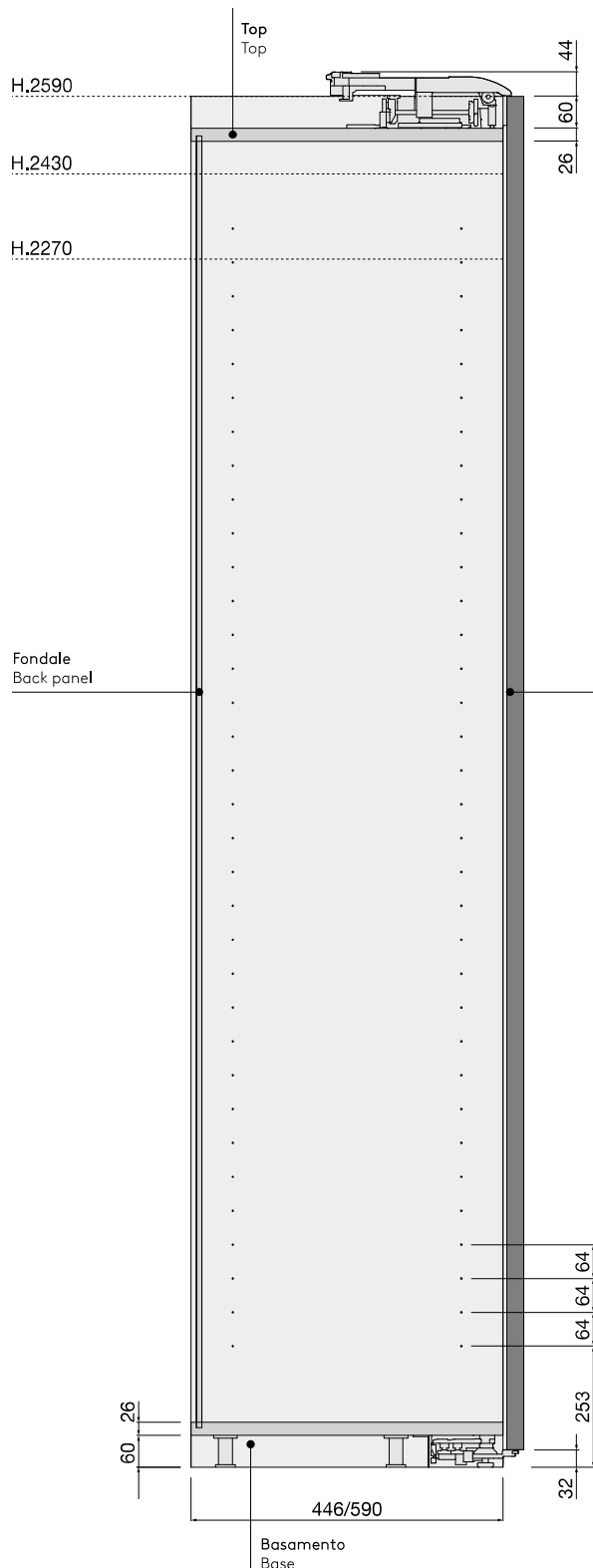

# Storage

FORATURA  
DRILLING

GRAPPOLO - FIANCO (DEFAULT)  
GROUP OF 3 HOLES - SIDE (DEFAULT)

## Elettrificazione con CAVO

Foro da  $\varnothing 16$  mm su fondale in caso di luce LED o ripiano luminoso  
Ripiani legno : spostabilità di +/- 64 mm verso l'alto o il basso  
Ripiani con luce/luminosi: NON spostabili

## Electrification with CABLE

$\varnothing 16$  mm hole on back panel in case of LED light or lighted shelf  
Wooden shelves: can be moved up or down by +/- 64 mm  
Shelves with light/lighted shelves: NOT movable

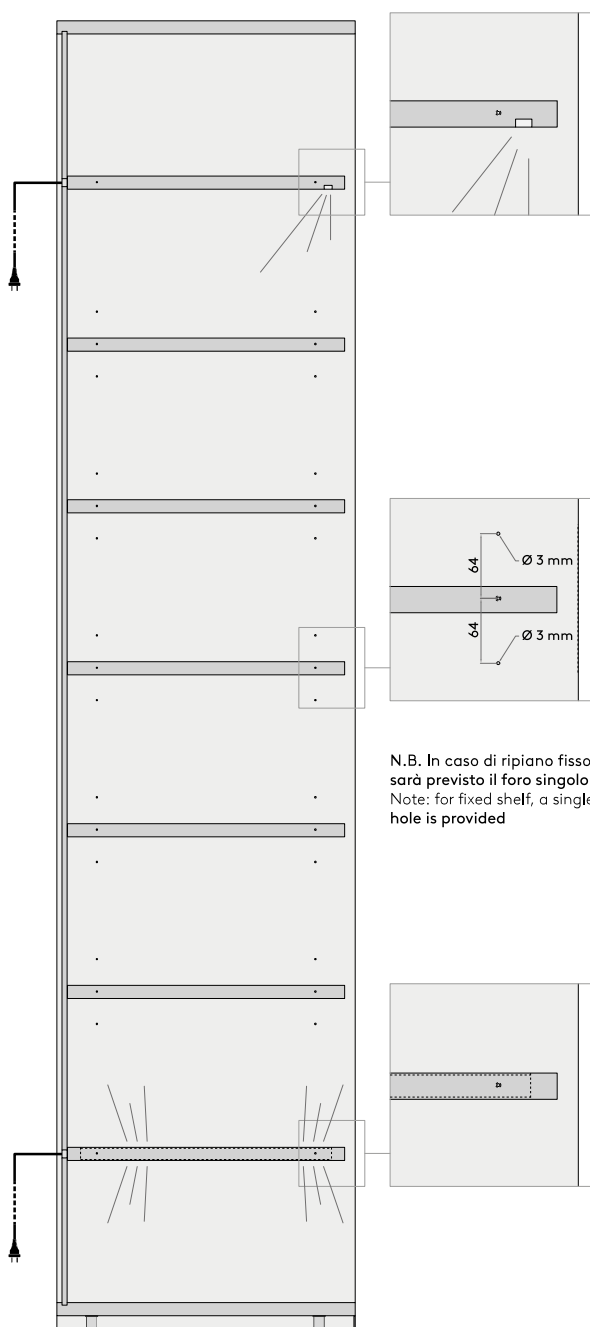

GRAPPOLO - MONTANTE (DEFAULT)  
GROUP OF 3 HOLES - UPRIGHT (DEFAULT)

## Elettrificazione con CAVO

Foro da  $\varnothing 16$  mm su fondale in caso di luce LED o ripiano luminoso  
Ripiani legno : spostabilità di +/- 64 mm verso l'alto o il basso  
Ripiani con luce/luminosi: NON spostabili

## Electrification with CABLE

$\varnothing 16$  mm hole on back panel in case of LED light or lighted shelf  
Wooden shelves: can be moved up or down by +/- 64 mm  
Shelves with light/lighted shelves: NOT movable

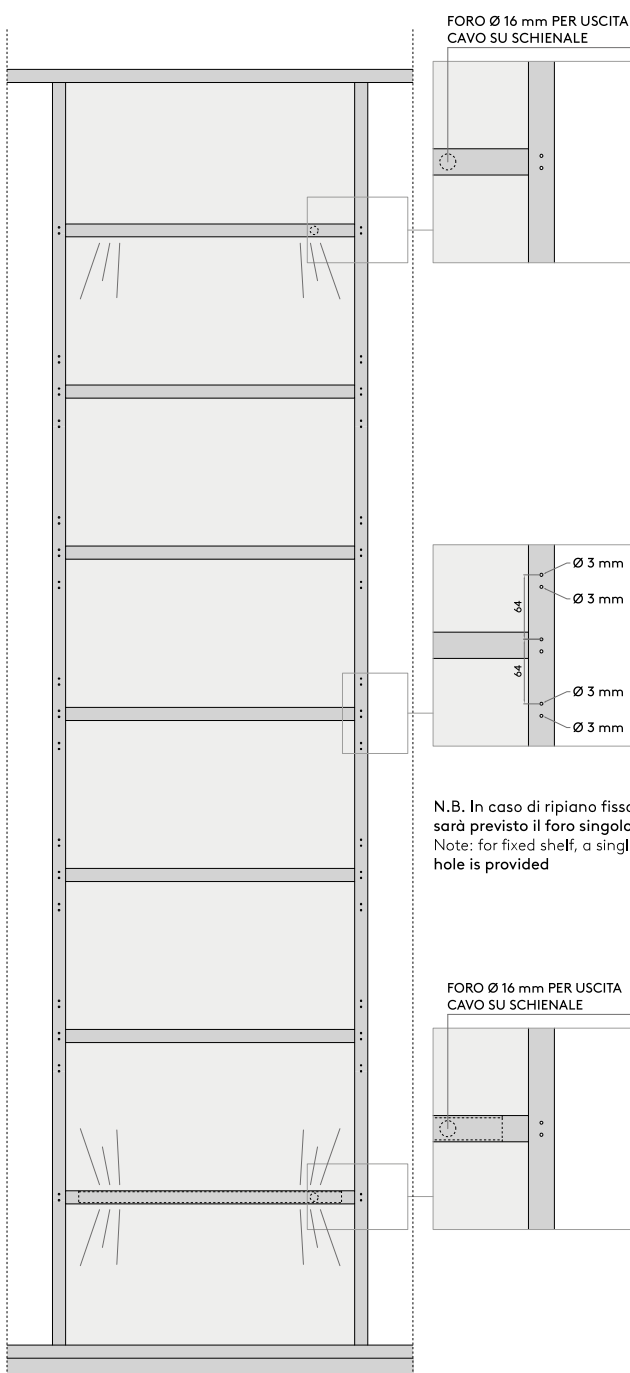

Sezione laterale  
Section view

Sezione frontale  
Section view

GRAPPOLO - FIANCO (DEFAULT)  
GROUP OF 3 HOLES - SIDE (DEFAULT)

**Elettificazione con CANALINA**

Ripiani legno : spostabilità di +/- 64 mm verso l'alto o il basso  
Ripiani con luce/luminosi: spostabilità di +/- 64 mm verso l'alto o il basso

**Electrification with CABLE DUCT**

Wooden shelves: can be moved up or down by +/- 64 mm  
Shelves with light/lighted shelves: can be moved up or down by +/- 64 mm

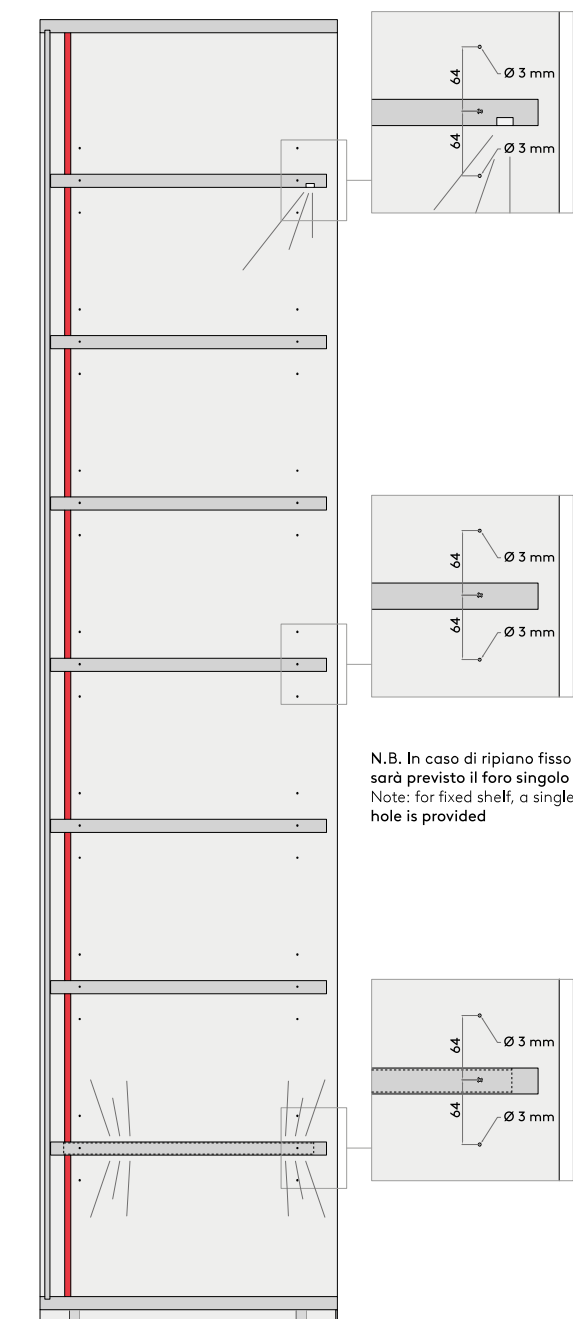

Sezione laterale  
Section view

GRAPPOLO - MONTANTE (DEFAULT)  
GROUP OF 3 HOLES - UPRIGHT (DEFAULT)

**Elettificazione con CANALINA**

Ripiani legno : spostabilità di +/- 64 mm verso l'alto o il basso  
Ripiani con luce/luminosi: spostabilità di +/- 64 mm verso l'alto o il basso

**Electrification with CABLE DUCT**

Wooden shelves: can be moved up or down by +/- 64 mm  
Shelves with light/lighted shelves: can be moved up or down by +/- 64 mm

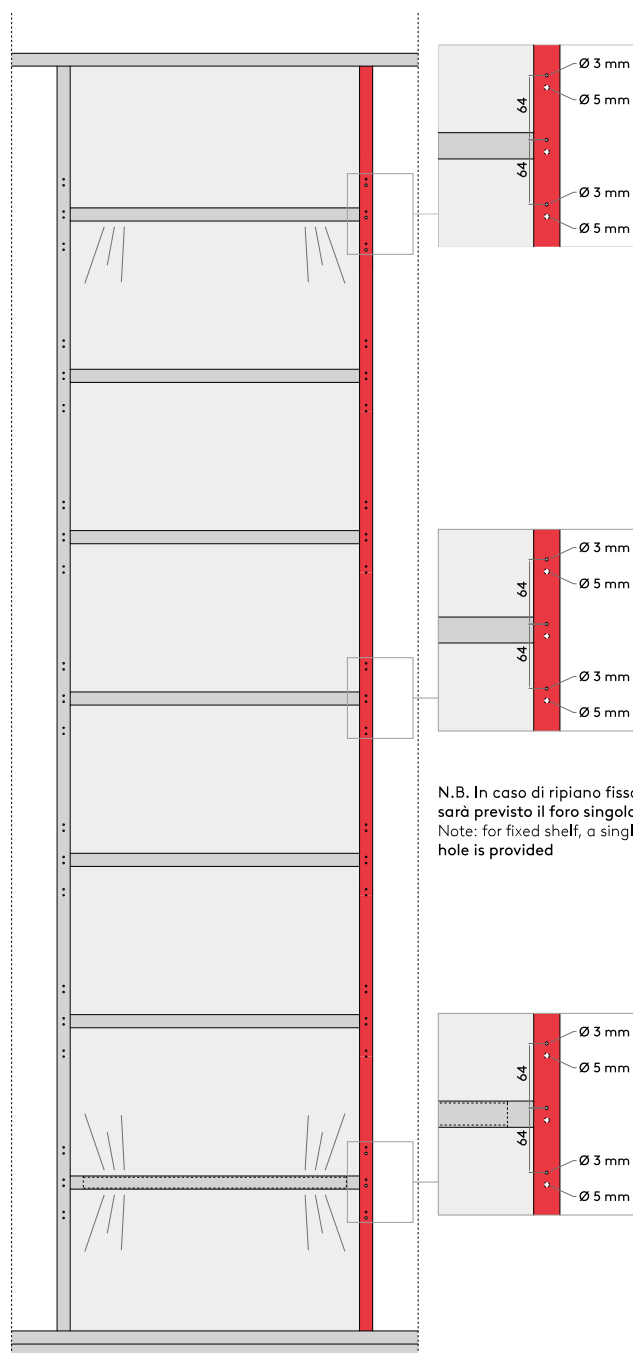

Sezione frontale  
Section view

# Storage

FORATURA  
DRILLING

FORO SINGOLO - FIANCO  
SINGLE HOLE - SIDE

## Elettrificazione con CAVO

Foro da  $\varnothing$  16 mm su fondale in caso di luce LED o ripiano luminoso

Ripiani legno : NON spostabili

Ripiani con luce/luminosi: NON spostabili

## Electrification with CABLE

$\varnothing$  16 mm hole on back panel in case of LED light or lighted shelf

Wooden shelves: NOT movable

Shelves with light/lighted shelves: NOT movable

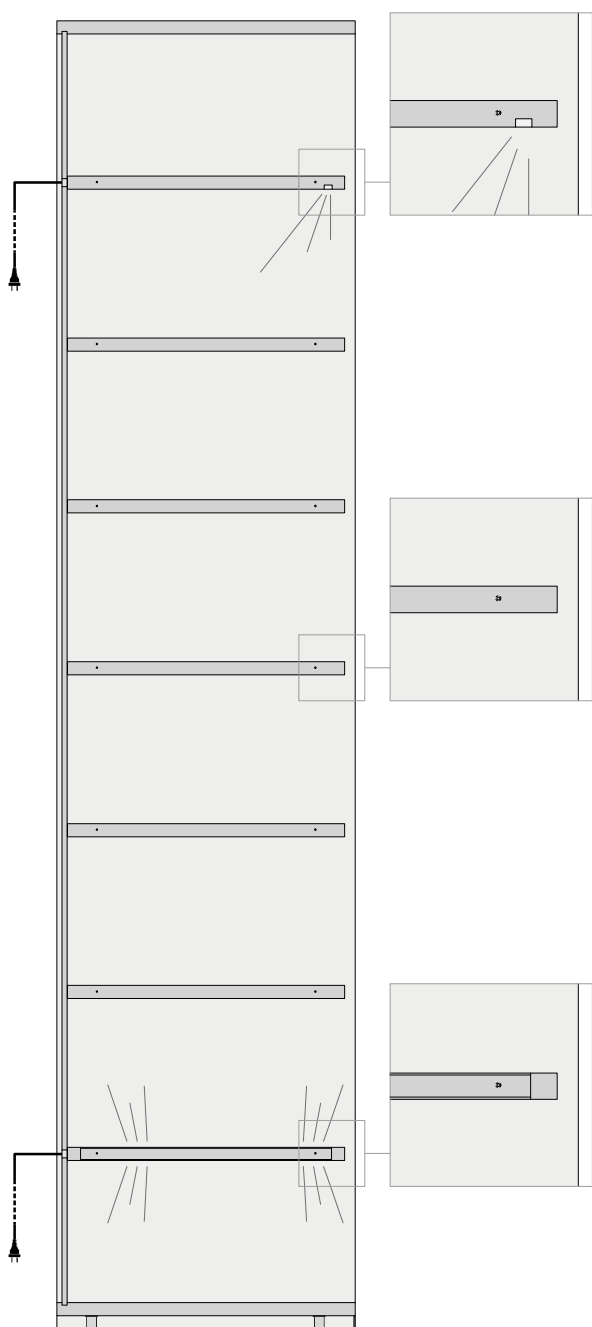

Sezione laterale  
Section view

FORO SINGOLO - MONTANTE  
SINGLE HOLE - UPRIGHT

## Elettrificazione con CAVO

Foro da  $\varnothing$  16 mm su fondale in caso di luce LED o ripiano luminoso

Ripiani legno : NON spostabili

Ripiani con luce/luminosi: NON spostabili

## Electrification with CABLE

$\varnothing$  16 mm hole on back panel in case of LED light or lighted shelf

Wooden shelves: NOT movable

Shelves with light/lighted shelves: NOT movable

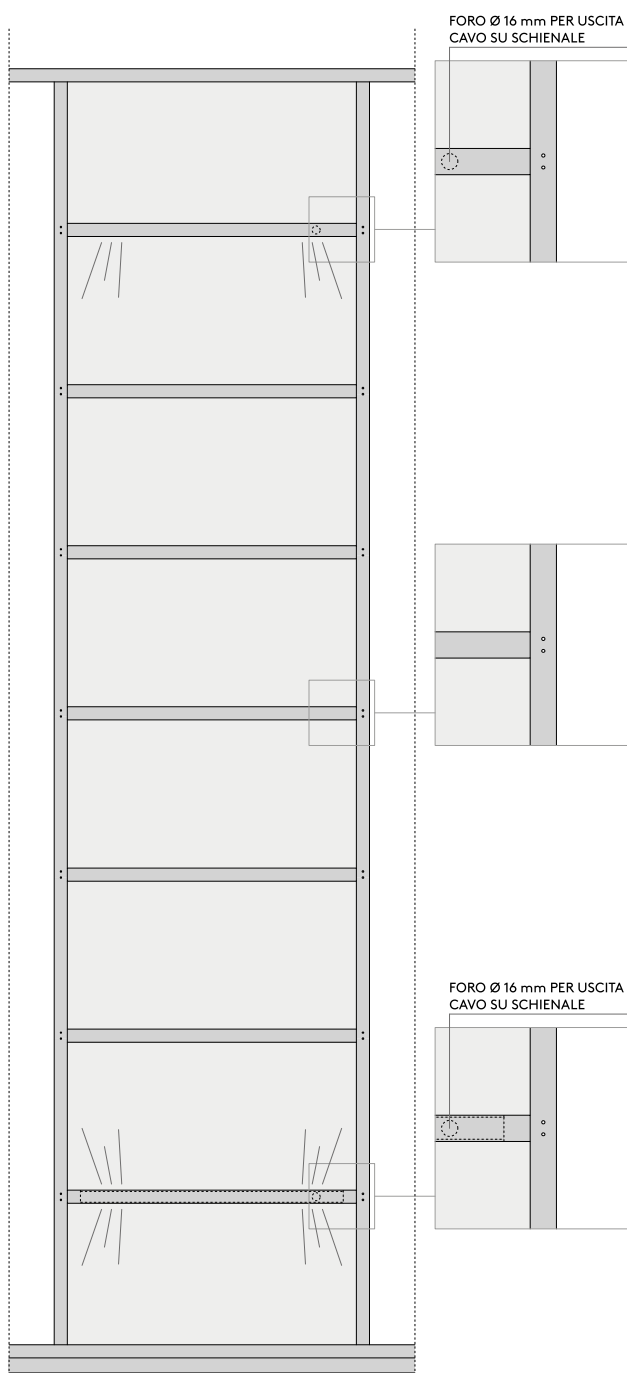

Sezione frontale  
Section view

FORO SINGOLO - FIANCO  
SINGLE HOLE - SIDE

**Elettrificazione con CANALINA**  
Ripiani legno : **NON spostabili**  
Ripiani con luce/luminosi: **NON spostabili**

Electrification with **CABLE DUCT**  
Wooden shelves: **NOT movable**  
Shelves with light/lighted shelves: **NOT movable**

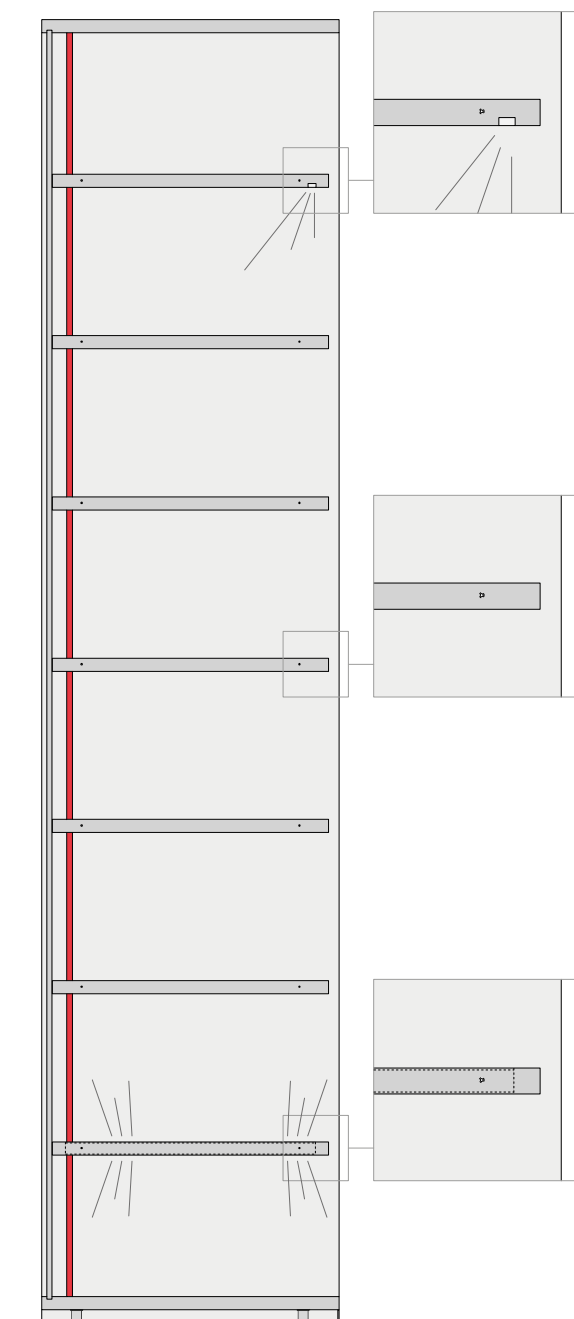

Section view

FORO SINGOLO - MONTANTE  
SINGLE HOLE - UPRIGHT

**Elettrificazione con CANALINA**  
Ripiani legno : **NON spostabili**  
Ripiani con luce/luminosi: **NON spostabili**

Electrification with **CABLE DUCT**  
Wooden shelves: **NOT movable**  
Shelves with light/lighted shelves: **NOT movable**

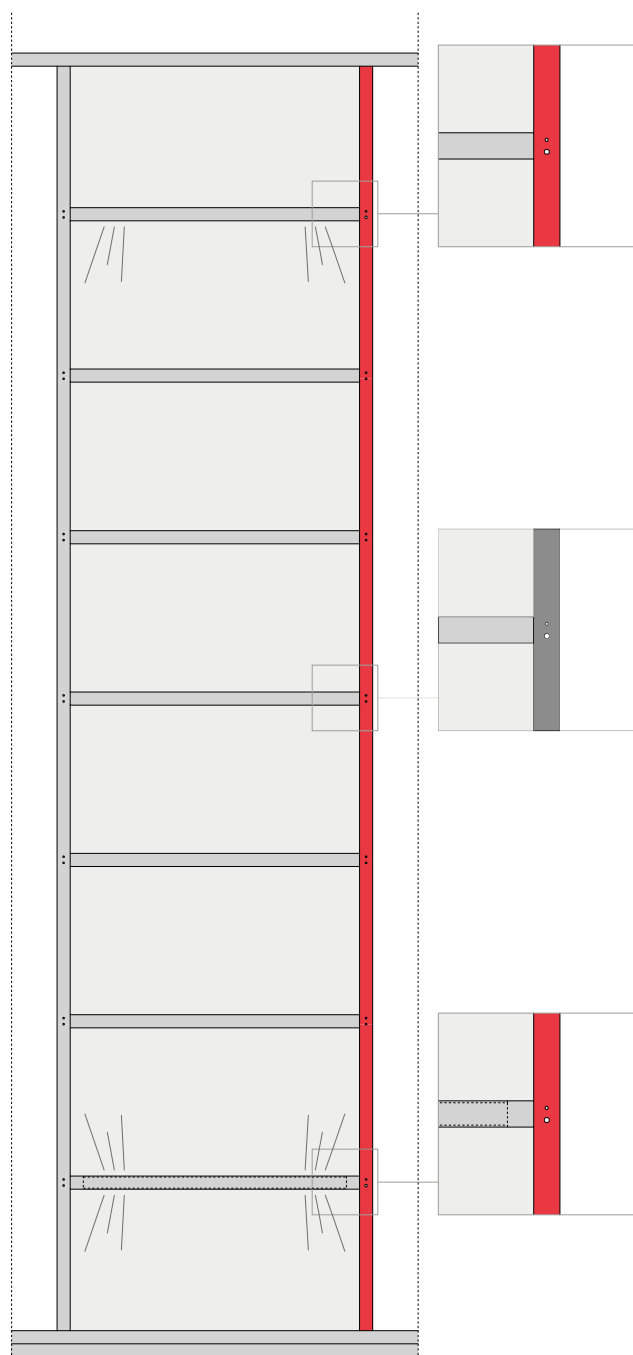

Sezione frontale  
Section view



# Storage

FORATURA  
DRILLING

CONTINUA - FIANCO  
CONTINUOUS - SIDE

## Elettrificazione con CAVO

Foro da  $\varnothing 16$  mm su fondale in caso di luce LED o ripiano luminoso  
Ripiani legno : spostabili su tutta l' altezza del modulo  
Ripiani con luce/luminosi: NON spostabili

## Electrification with CABLE

$\varnothing 16$  mm hole on back panel in case of LED light or lighted shelf  
Wooden shelves: can be moved along the entire height of the module  
Shelves with light/lighted shelves: NOT movable

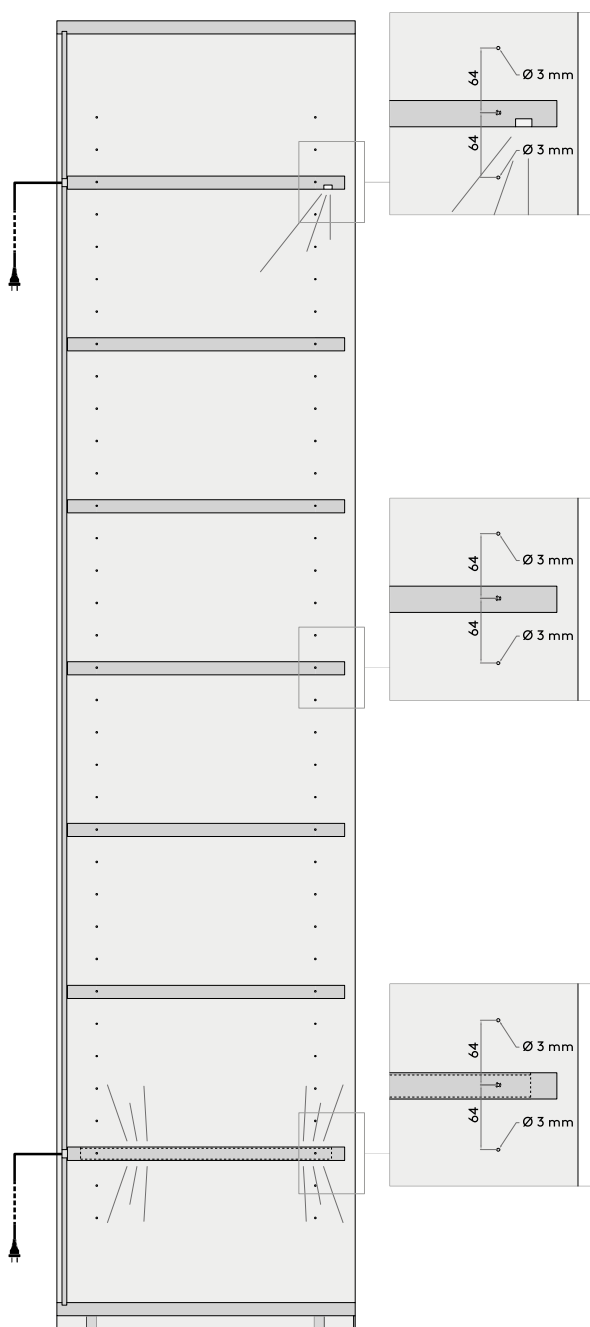

Sezione laterale  
Section view

CONTINUA - MONTANTE  
CONTINUOUS - UPRIGHT

## Elettrificazione con CAVO

Foro da  $\varnothing 16$  mm su fondale in caso di luce LED o ripiano luminoso  
Ripiani legno : spostabili su tutta l' altezza del modulo  
Ripiani con luce/luminosi: NON spostabili

## Electrification with CABLE

$\varnothing 16$  mm hole on back panel in case of LED light or lighted shelf  
Wooden shelves: can be moved along the entire height of the module  
Shelves with light/lighted shelves: NOT movable

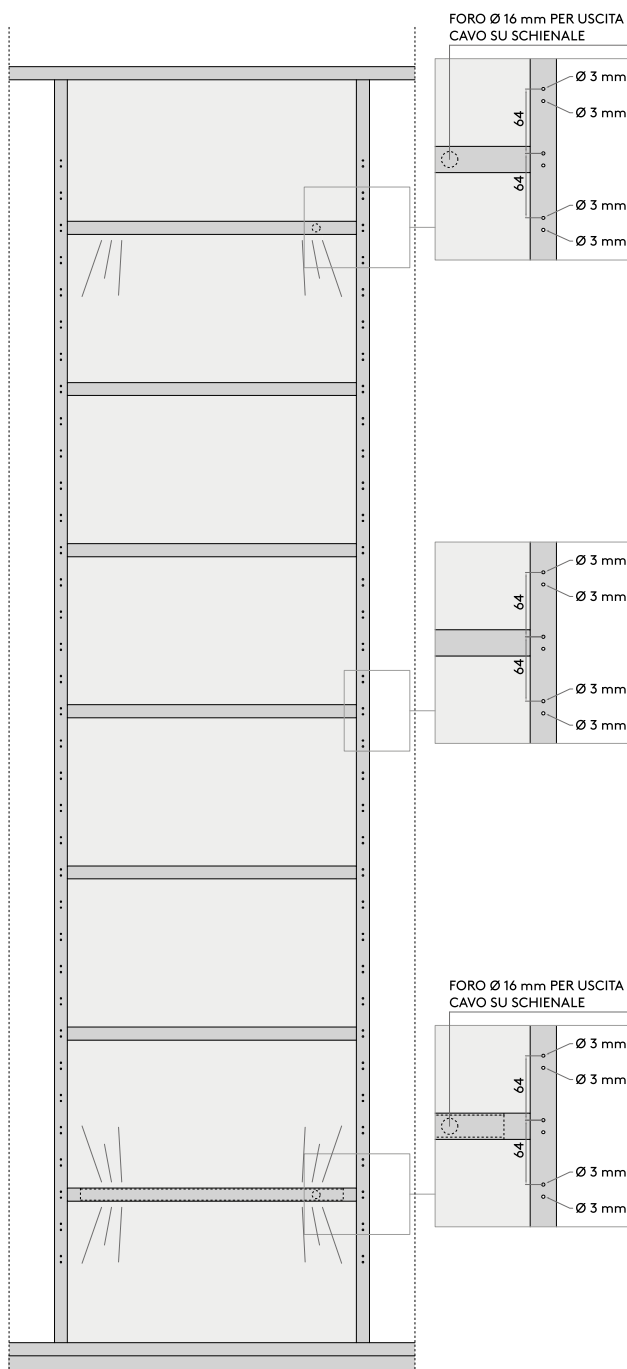

Sezione frontale  
Section view

CONTINUA - FIANCO  
CONTINUOUS - SIDE

**Elettrificazione con CANALINA**  
Ripiani legno : spostabili su tutta l' altezza del modulo  
Ripiani con luce/luminosi: spostabili su tutta l'altezza del modulo

Electrification with CABLE DUCT  
Wooden shelves: can be moved along the entire height of the module  
Shelves with light/lighted shelves: can be moved along the entire height of the module

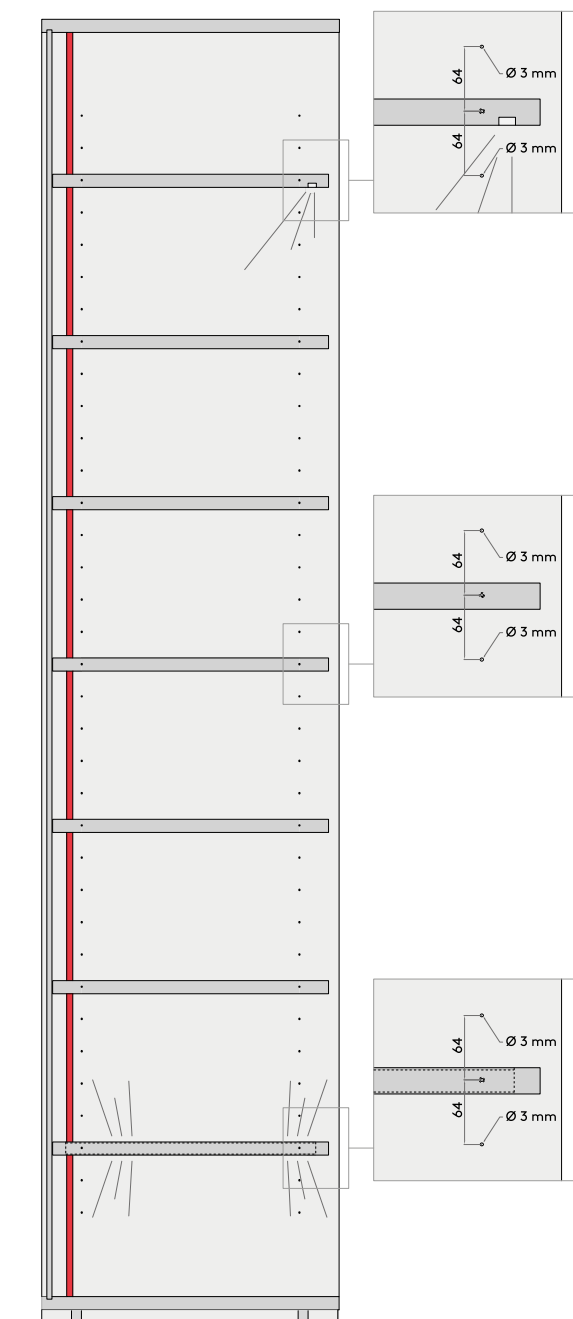

Section view

CONTINUA - MONTANTE  
CONTINUOUS - UPRIGHT

**Elettrificazione con CANALINA**  
Ripiani legno : spostabili su tutta l' altezza del modulo  
Ripiani con luce/luminosi: spostabili su tutta l'altezza del modulo

Electrification with CABLE DUCT  
Wooden shelves: can be moved along the entire height of the module  
Shelves with light/lighted shelves: can be moved along the entire height of the module

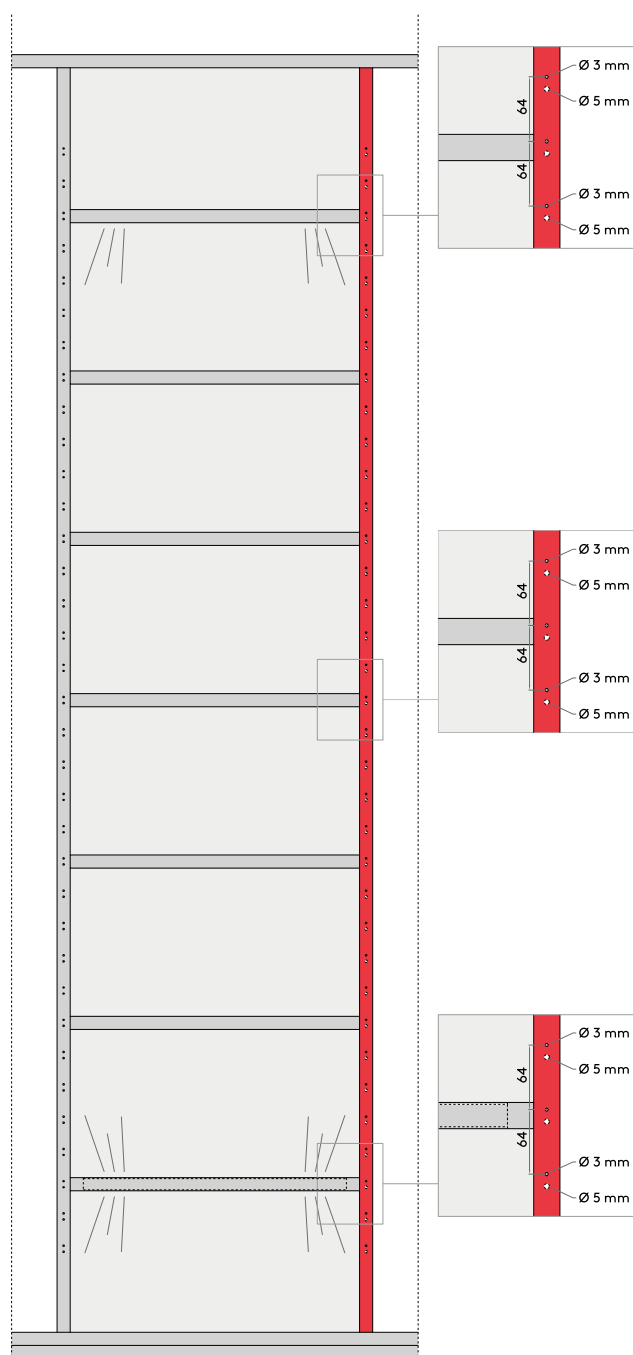

Sezione frontale  
Section view

# Storage

MODULARITA'  
SECTIONAL DESIGN

DIMENSIONI E MODULI ARMADIO BATTENTE ANTA PIANA - TECNO - SCOOP - IRON - BLOCK  
DIMENSIONS AND MODULAR STRUCTURES FOR HINGED DOORS PIANA - TECNO - SCOOP - IRON - BLOCK

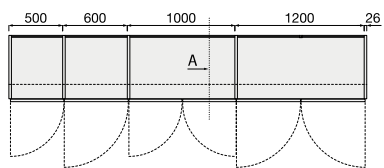

**Larghezze moduli fianco legno**  
Widths of wooden side modules

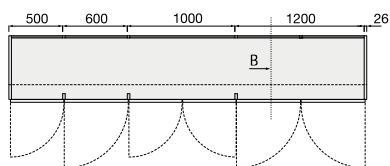

**Larghezze moduli con montante interno e anta Piana, Tecno e Scoop**  
Widths of internal upright modules with Piana, Tecno and Scoop door

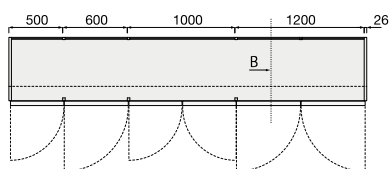

**Larghezze moduli con montante interno e anta Iron e Block**  
Widths of internal upright modules with Iron and Block door

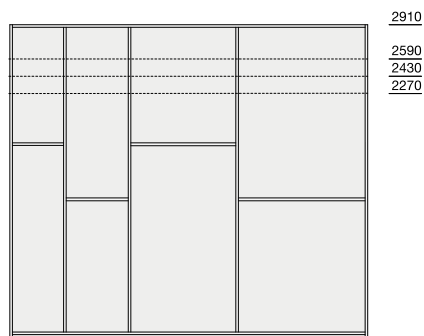

**Altezze e prospetti moduli senza ante**  
Modules without doors - height and front view

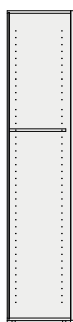

**Sezione A**  
Section A

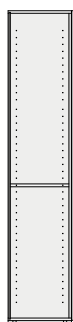

**Sezione B**  
Section B

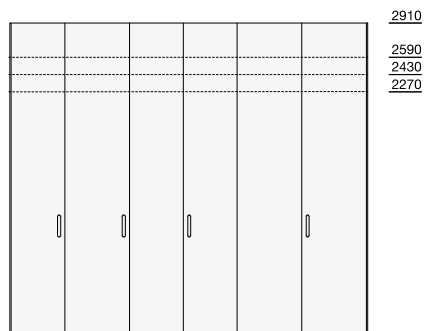

**Altezze e prospetti moduli con ante**  
Modules with doors - height and front view



## DIMENSIONI E MODULI ARMADIO BATTENTE 32S DIMENSIONS AND MODULAR STRUCTURES FOR HINGED DOORS 32S

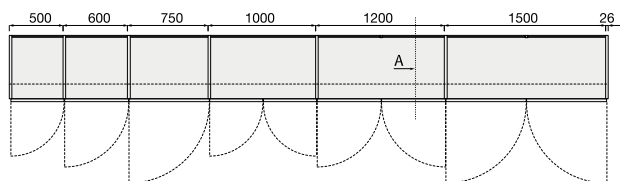

Larghezze moduli fianco legno  
Widths of wooden side modules

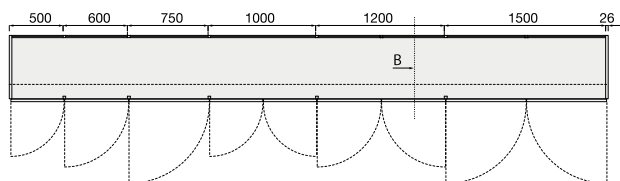

Larghezze moduli con montante interno  
Widths of internal upright modules

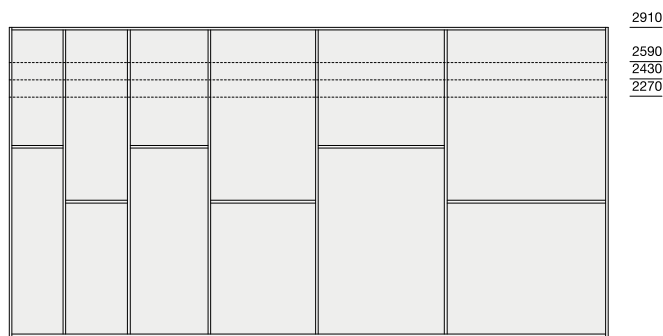

Altezze e prospetti moduli senza ante  
Modules without doors - height and front view

2910  
2590  
2430  
2270

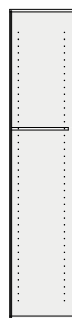

Sezione A  
Section A

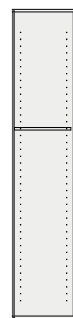

Sezione B  
Section B



Altezze e prospetti moduli con ante  
Modules with doors - height and front view

2910  
2590  
2430  
2270



# Storage

MODULARITA'  
SECTIONAL DESIGN

## DIMENSIONI ARMADIO BATTENTE HINGED DOOR WARDROBE DIMENSIONS

### Dimensioni in larghezza con ante a sormonto parziale

Width sizes with partially overlapping doors

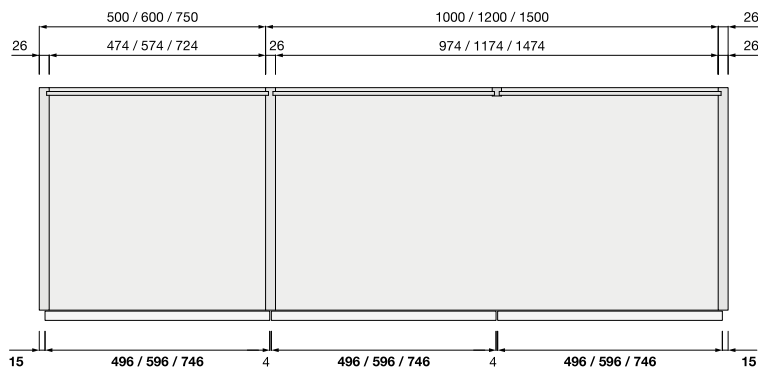

### Dimensioni in larghezza con ante con sormonto totale dei fianchi

Width sizes with doors totally overlapping the sides

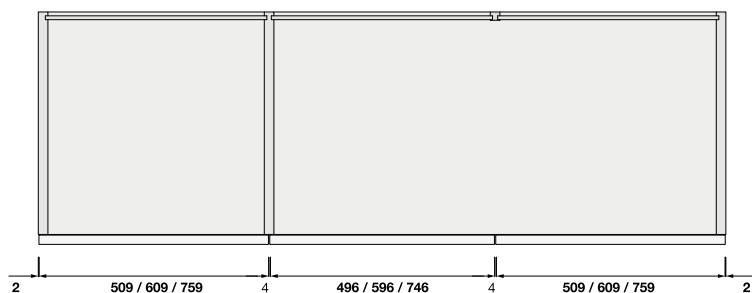

### NOTE TECNICHE TECHNICAL NOTES

Il sormonto totale non è possibile su ante Iron, Block, 32S e Cuoio con cerniera cardine.

Total overlap not possible for Iron, Block, 32S and Cuoio doors with pivot hinge.

### Dimensioni in profondità

Depth sizes

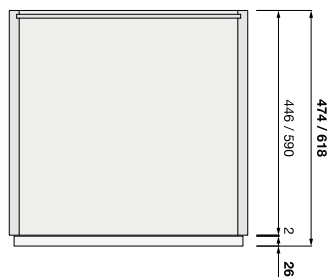

Ante PIANA - TECNO - SCOOP - RIFF  
PIANA - TECNO - SCOOP - RIFF doors

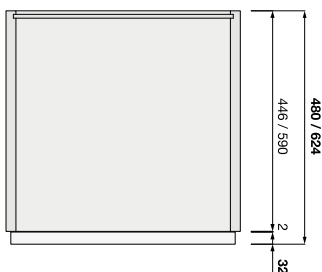

Ante 32S - CUOIO - BLOCK  
32S - CUOIO - BLOCK doors

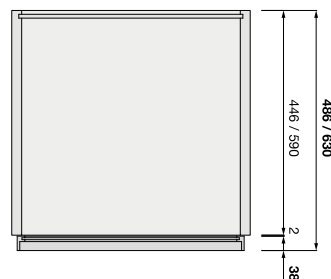

Ante IRON  
IRON doors

## SCHEMA COMPONENTABILITA' ORIZZONTALE ARMADI CON ANTE BATTENTI HORIZONTAL SETTING PLAN FOR WARDROBES WITH HINGED DOORS

526	500	26	3126	1000	1000	600	500	26	
626	600	26	3226	1200	1000	1000	26		
776	750	26	3326	1200	1000	600	500	26	
1026	1000	26	3426	1200	1200	1000	26		
1226	1200	26	3526	1000	1000	1000	500	26	
1526	1500	26	3626	1200	1200	1200	26		
1526	1000	500	3726	1200	1000	1000	500	26	
1626	1000	600	3776	1500	1500	750	26		
1726	1200	500	3826	1200	1000	1000	600	26	
1826	1200	600	3926	1200	1200	1000	500	26	
2026	1000	1000	4026	1000	1000	1000	1000	26	
2126	1000	600	4126	1200	1200	1200	500	26	
2226	1200	1000	4226	1200	1200	1200	600	26	
2276	1500	750	4326	1200	1000	1000	600	500	26
2326	1200	600	4426	1200	1200	1000	1000	26	
2426	1200	1200	4526	1000	1000	1000	1000	500	26
2526	1000	1000	4526	1500	1500	1500	26		
2626	1000	1000	4626	1000	1000	1000	1000	600	26
2726	1200	1000	4726	1200	1000	1000	1000	500	26
2826	1200	1000	4826	1200	1200	1200	1200	26	
2926	1200	1200	4926	1200	1200	1000	1000	500	26
3026	1000	1000	5026	1000	1000	1000	1000	1000	26
3026	1200	1200	5126	1200	1200	1200	1000	500	26
3026	1500	1500	5226	1200	1200	1200	1000	600	26

# Storage

MODULARITA'  
SECTIONAL DESIGN

## DIMENSIONI E MODULI ARMADIO A GIORNO DIMENSIONS AND MODULAR STRUCTURES FOR OPEN MODULES

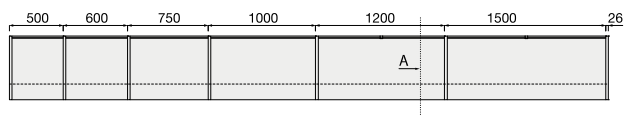

Larghezze moduli fianco legno  
Widths of wooden side modules

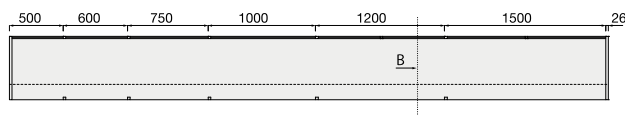

Larghezze moduli con montante interno  
Widths of internal upright modules

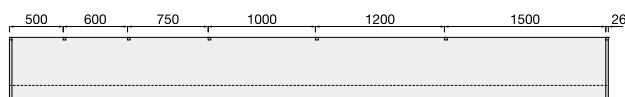

Larghezze moduli senza fondali  
Widths of modules without back panels

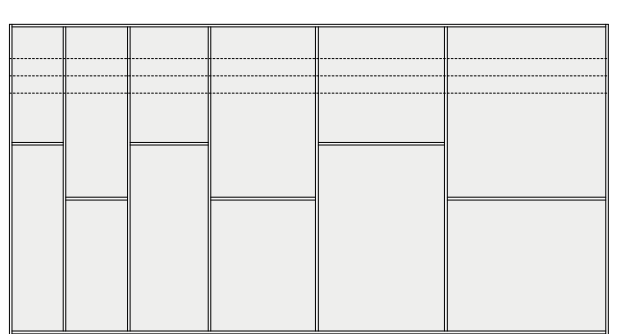

2910  
2590  
2430  
2270

Sezione A  
Section A

Sezione B  
Section B

Altezze e prospetti moduli a giorno  
Open modules - height and front view

## DIMENSIONI ARMADIO A GIORNO OPEN MODULE DIMENSIONS

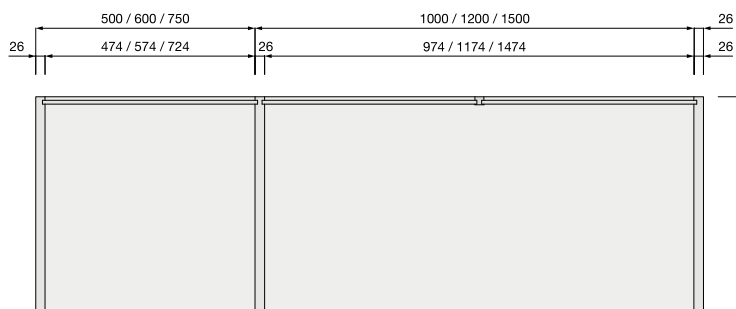

## SCHEMA COMPONENTABILITA' ORIZZONTALE ARMADI A GIORNO HORIZONTAL SETTING PLAN FOR WARDROBES WITH OPEN MODULES

526	500	26	3126	1000	1000	600	500	26	
626	600	26	3226	1200	1000	1000	26		
776	750	26	3326	1200	1000	600	500	26	
1026	1000	26	3426	1200	1200	1000	26		
1226	1200	26	3526	1000	1000	1000	500	26	
1526	1500	26	3626	1200	1200	1200	26		
1526	1000	500	3726	1200	1000	1000	500	26	
1626	1000	600	3776	1500	1500	750	26		
1726	1200	500	3826	1200	1000	1000	600	26	
1826	1200	600	3926	1200	1200	1000	500	26	
2026	1000	1000	4026	1000	1000	1000	1000	26	
2126	1000	600	4126	1200	1200	1200	500	26	
2226	1200	1000	4226	1200	1200	1200	600	26	
2276	1500	750	4326	1200	1000	1000	600	500	26
2326	1200	600	4426	1200	1200	1000	1000	26	
2426	1200	1200	4526	1000	1000	1000	1000	500	26
2526	1000	1000	4526	1500	1500	1500	26		
2626	1000	1000	4626	1000	1000	1000	1000	600	26
2726	1200	1000	4726	1200	1000	1000	1000	500	26
2826	1200	1000	4826	1200	1200	1200	1200	26	
2926	1200	1200	4926	1200	1200	1000	1000	500	26
3026	1000	1000	5026	1000	1000	1000	1000	1000	26
3026	1200	1200	5126	1200	1200	1200	1000	500	26
3026	1500	1500	5226	1200	1200	1200	1000	600	26



# Storage

MODULARITA'  
SECTIONAL DESIGN

## DIMENSIONI E MODULI ARMADIO COMPLANARE 2 ANTE DIMENSIONS AND MODULAR STRUCTURES FOR 2 DOOR PULL-OUT SLIDING WARDROBE

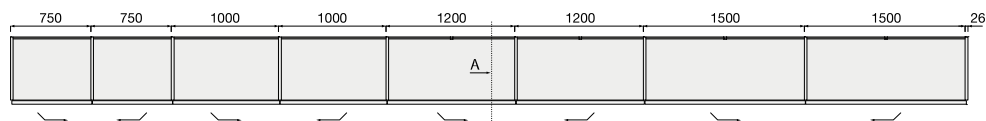

Larghezze moduli fianco legno  
Widths of wooden side modules

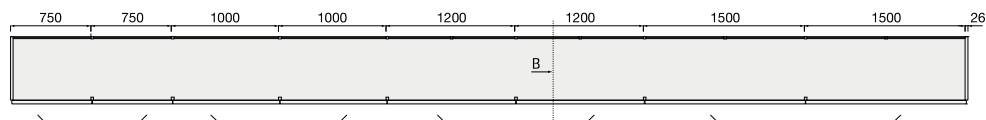

Larghezze moduli con montante interno  
Widths of internal upright modules

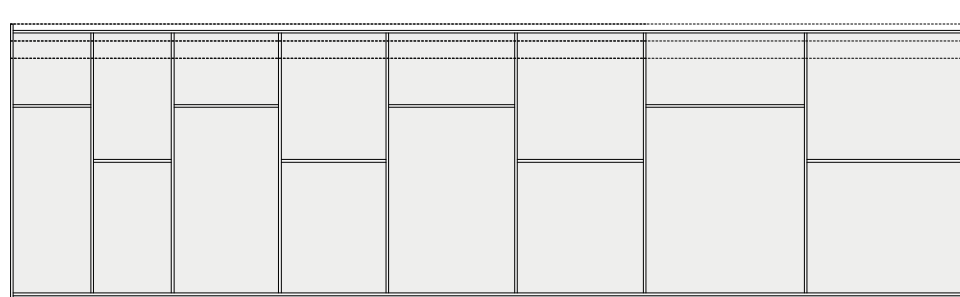

Altezze e prospetti moduli senza ante  
Modules without doors - height and front view

Sezione A  
Section A

Sezione B  
Section B

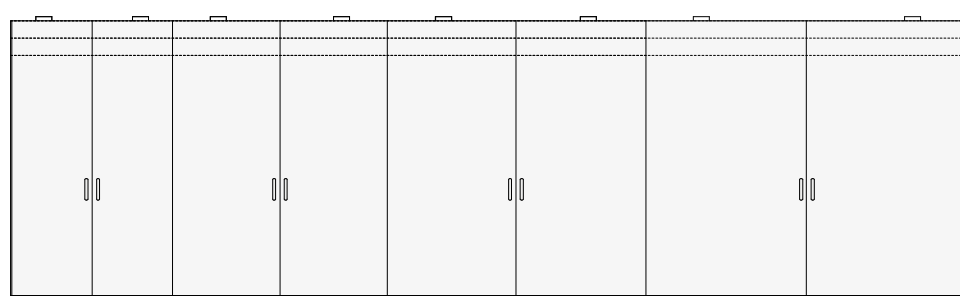

Altezze e prospetti moduli con ante  
Modules with doors - height and front view

## DIMENSIONI ARMADIO COMPLANARE 2 ANTE DIMENSIONS FOR 2 DOOR PULL-OUT SLIDING WARDROBE

Armadio chiuso  
Closed wardrobe

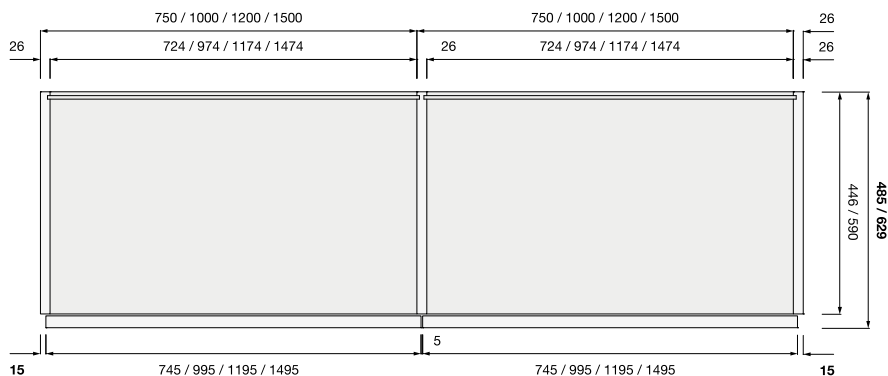

Armadio con apertura parziale sui moduli L.750  
Wardrobe with partial opening on W.750 modules

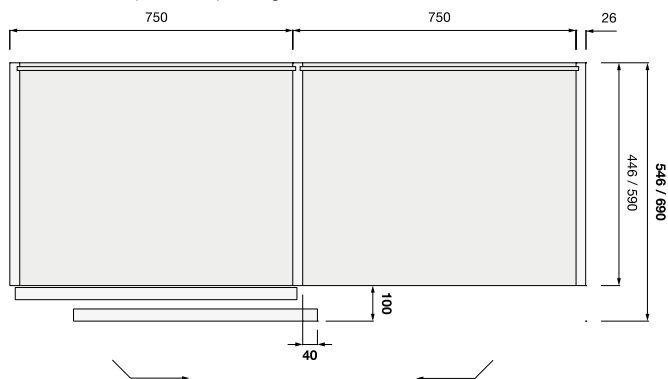

Armadio con apertura totale dell'anta  
Wardrobe with total opening of the door

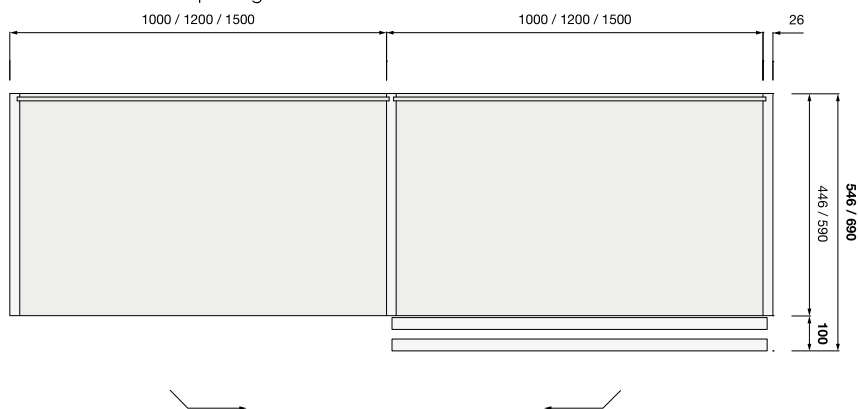

Dimensioni in larghezza con ante con sormonto totale dei fianchi  
Width sizes with doors totally overlapping the sides

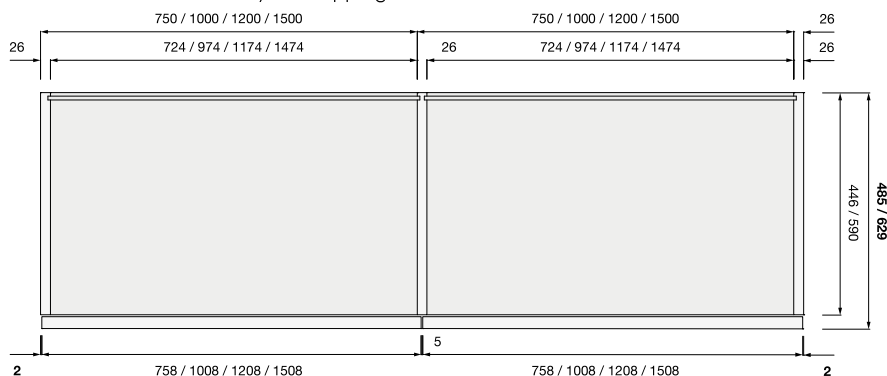

# Storage

MODULARITA'  
SECTIONAL DESIGN

## DIMENSIONI E MODULI ARMADIO COMPLANARE 3 ANTE DIMENSIONS AND MODULAR STRUCTURES FOR 3 DOOR PULL-OUT SLIDING WARDROBE

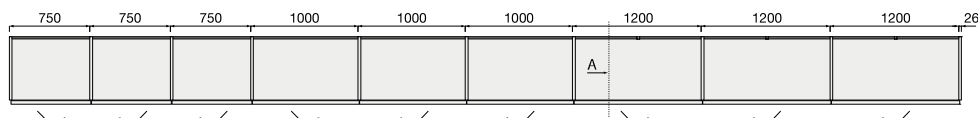

Larghezze moduli fianco legno  
Widths of wooden side modules

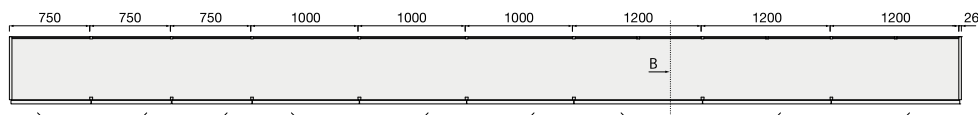

Larghezze moduli con montante interno  
Widths of internal upright modules

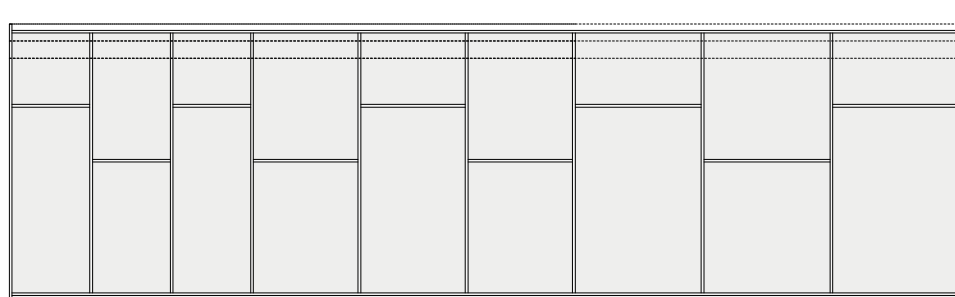

2590  
2430  
2270

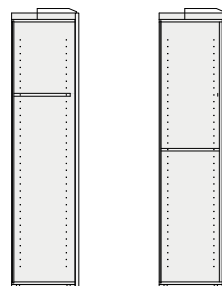

Altezze e prospetti moduli senza ante  
Modules without doors - height and front view

Sezione A  
Section A

Sezione B  
Section B

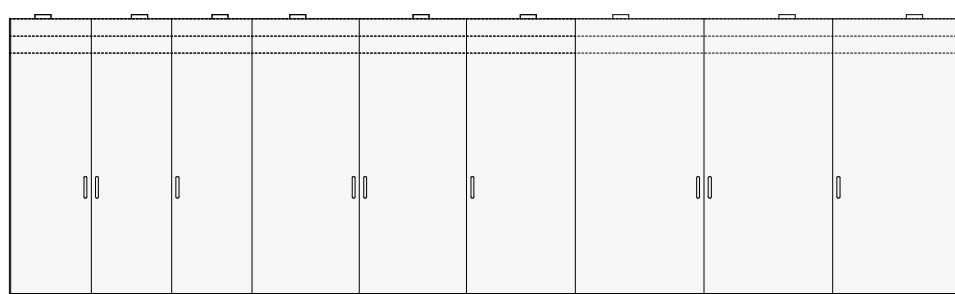

2590  
2430  
2270



Altezze e prospetti moduli con ante  
Modules with doors - height and front view

**DIMENSIONI ARMADIO COMPLANARE 3 ANTE - CON ANTE A SORMONTO PARZIALE DEI FIANCHI**  
**DIMENSIONS FOR 3 DOOR PULL-OUT SLIDING WARDROBE - WITH DOORS PARTIALLY OVERLAPPING THE SIDES**

**Armadio chiuso**

Closed wardrobe



**Armadio con anta destra aperta**

Wardrobe with right door open

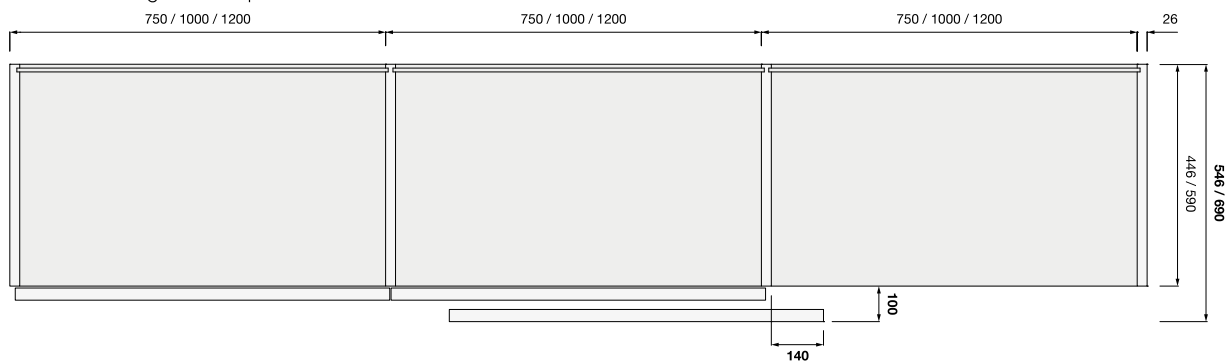

**Armadio con anta centrale aperta**

Wardrobe with central door open

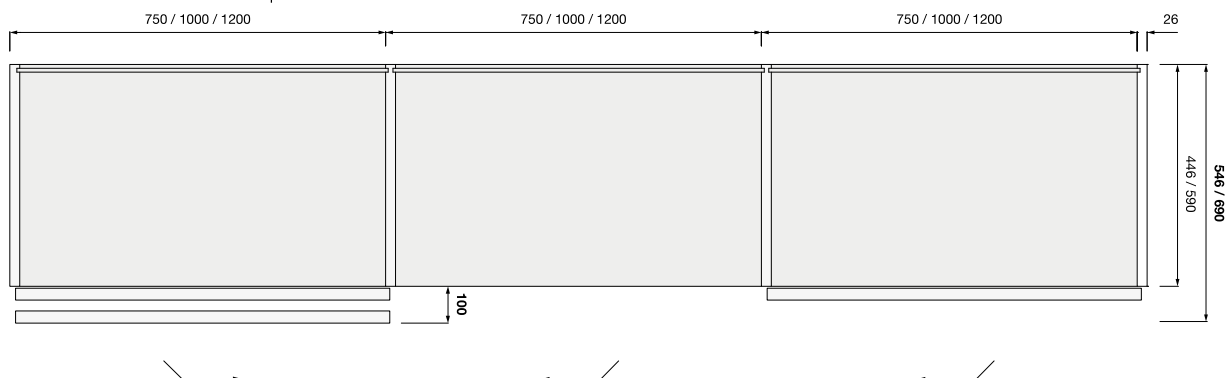

**Armadio con anta in apertura**

Wardrobe with door being opened

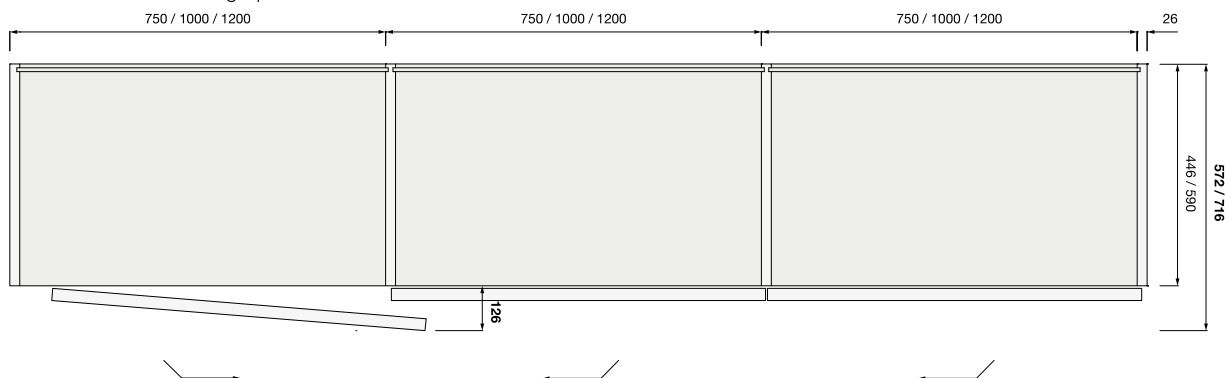

# Storage

MODULARITA'  
SECTIONAL DESIGN

DIMENSIONI ARMADIO COMPLANARE 3 ANTE - CON ANTE A SORMONTO TOTALE DEI FIANCHI  
DIMENSIONS FOR 3 DOOR PULL-OUT SLIDING WARDROBE - WITH DOORS TOTALLY OVERLAPPING THE SIDES

## Armadio chiuso

Closed wardrobe

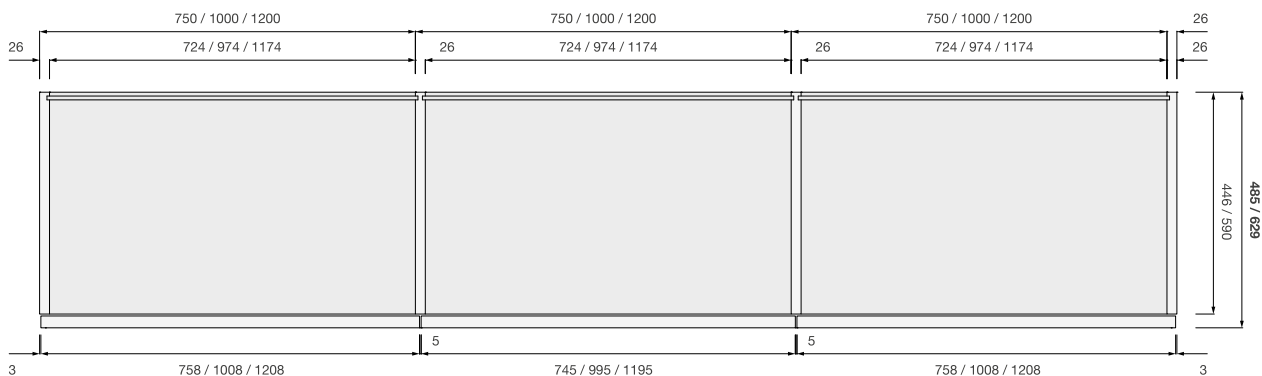

## Armadio con ante destra aperta

Wardrobe with right door open

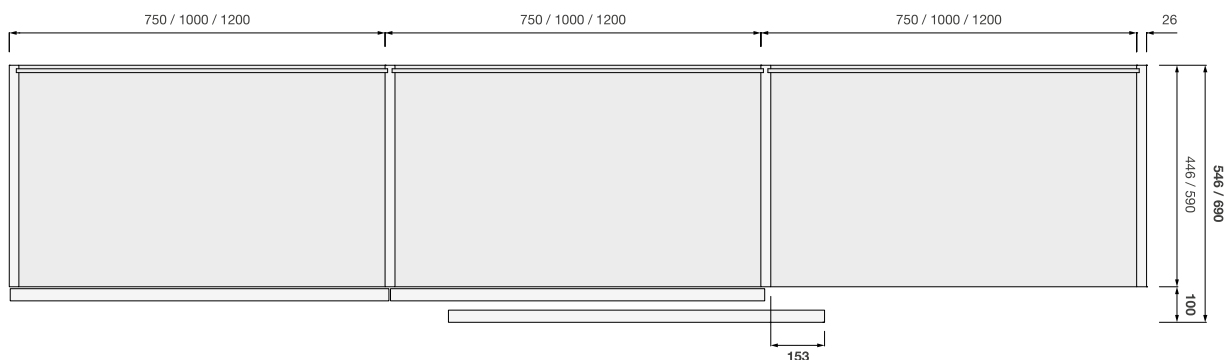

## Armadio con ante centrale aperta sui moduli L.750

Wardrobe with central door open on W.750 modules

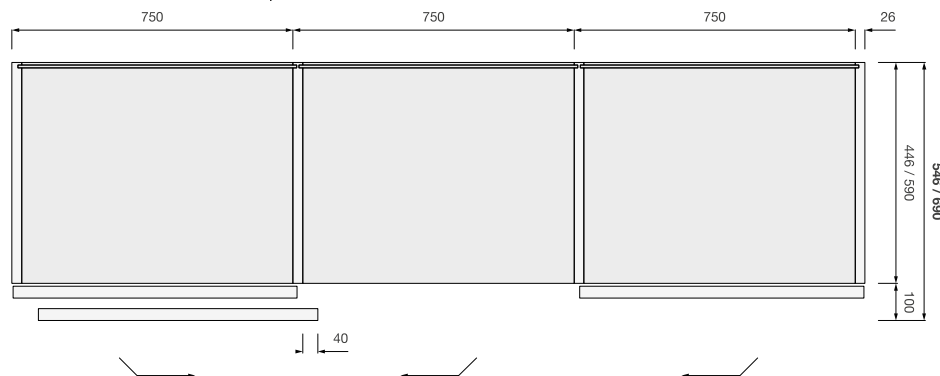

## Armadio con ante centrale aperta sui moduli L.1000 - L.1200

Wardrobe with central door open on W.1000 - W.1200 modules

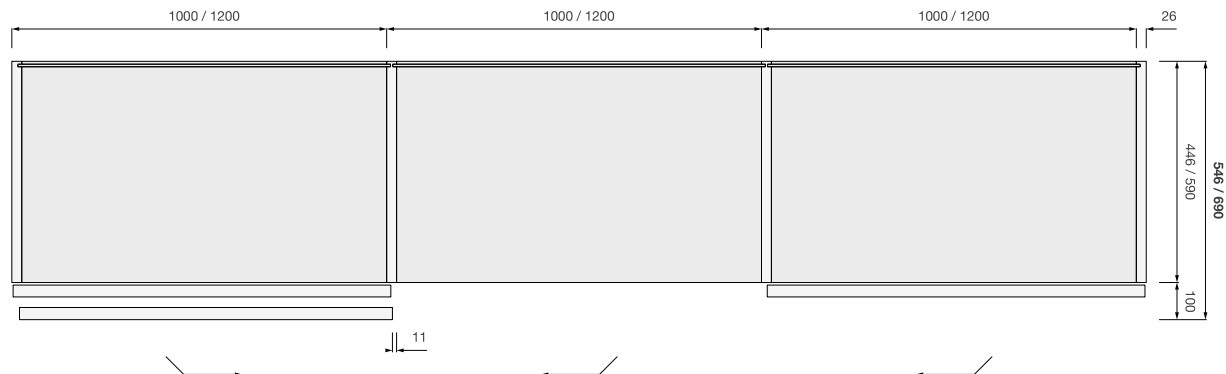

## SCHEMA COMPLEMENTI ORIZZONTALE ARMADIO COMPLANARE HORIZONTAL SETTING PLAN FOR PULL-OUT SLIDING WARDROBE

1526	750	750	26				
2026	1000	1000	26				
2276	750	750	750	26			
2426	1200	1200	26				
3026	1000	1000	1000	26			
3026	750	750	750	750	26		
3026	1500	1500	26				
3526	1000	1000	750	750	26		
3626	1200	1200	1200	26			
3776	750	750	750	750	750	26	
2026	1200	1200	750	750	26		
4026	1000	1000	1000	1000	26		
4276	1000	1000	750	750	750	26	
4426	1200	1200	1000	1000	26		
4526	750	750	750	750	750	750	26
4526	1000	1000	1000	750	750	26	
4526	1200	1200	750	750	750	26	
4526	1200	1200	1200	1200	26		
5026	1000	1000	1000	1000	1000	26	
6026	1200	1200	1200	1200	1200	26	
6026	1500	1500	1500	1500	26		

# Storage

MODULARITA'  
SECTIONAL DESIGN

## DIMENSIONI E MODULI ARMADIO SCORREVOLE 2 ANTE DIMENSIONS AND MODULAR STRUCTURES FOR 2 DOOR SLIDING WARDROBE

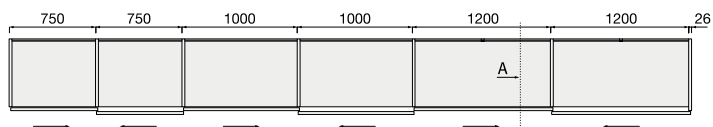

Larghezze moduli fianco legno  
Widths of wooden side modules

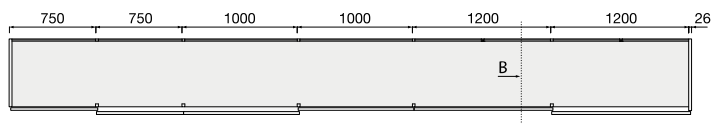

Larghezze moduli con montante interno  
Widths of internal upright modules

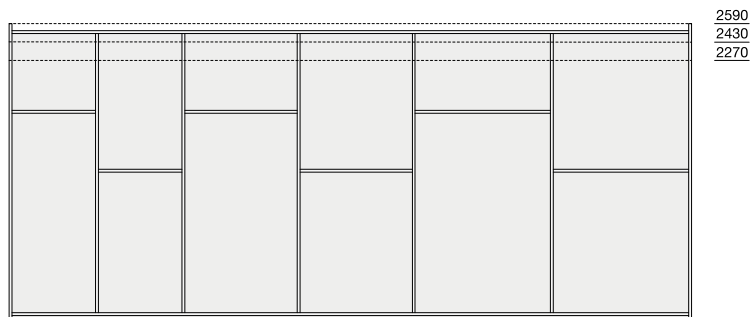

Altezze e prospetti moduli senza ante  
Modules without doors - height and front view

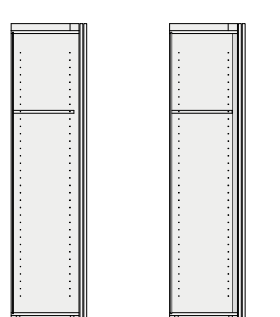

Sezione A  
Section A

Section B

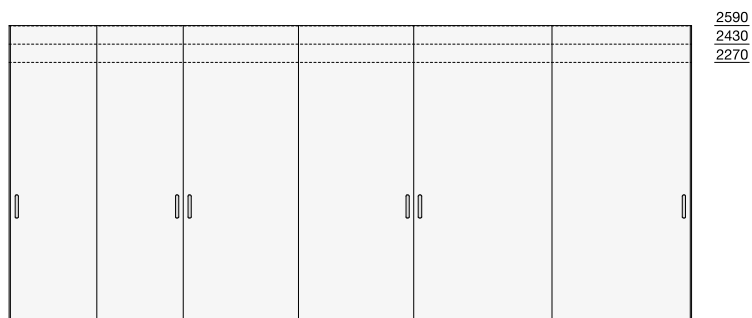

Altezze e prospetti moduli con ante  
Modules with doors - height and front view

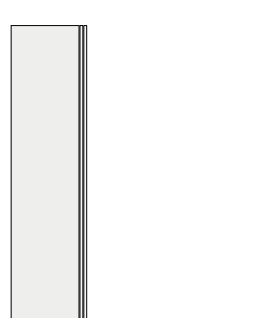

## DIMENSIONI ARMADIO SCORREVOLE 2 ANTE DIMENSIONS FOR 2 DOOR SLIDING WARDROBE

**Armadio chiuso con ante a sormonto parziale dei fianchi**  
Closed wardrobe with doors partially overlapping the sides

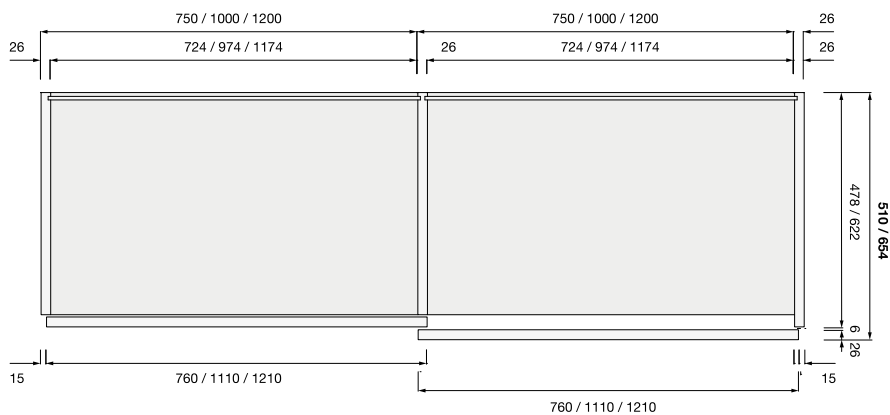

**Armadio chiuso con ante a sormonto totale dei fianchi**  
Closed wardrobe with doors totally overlapping the sides

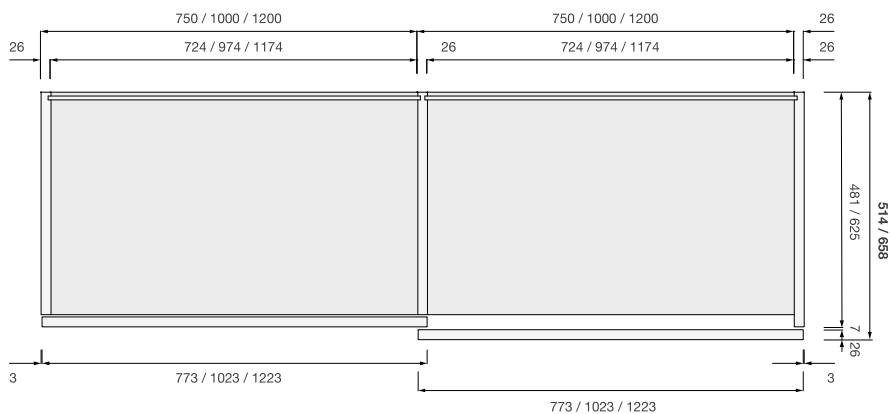

**Apertura anta scorrevole per tutte le larghezze di modulo**  
Sliding door opening for all module widths

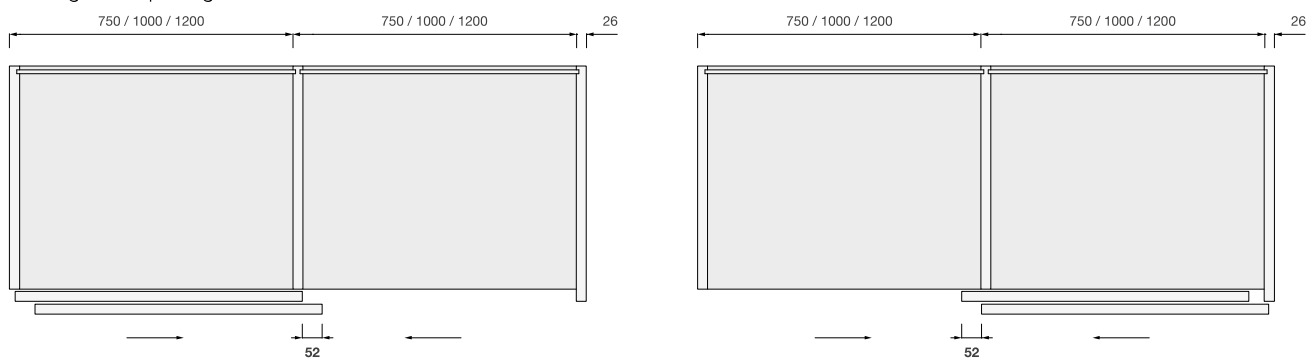



# Storage

MODULARITA'  
SECTIONAL DESIGN

## DIMENSIONI E MODULI ARMADIO SCORREVOLE 3 ANTE DIMENSIONS AND MODULAR STRUCTURES FOR 3 DOOR SLIDING WARDROBE

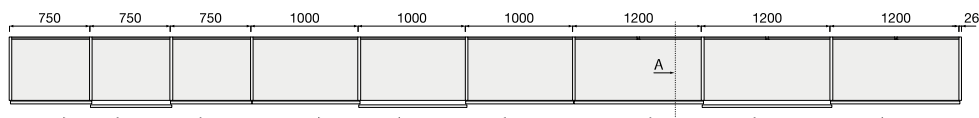

Larghezze moduli fianco legno  
Widths of wooden side modules

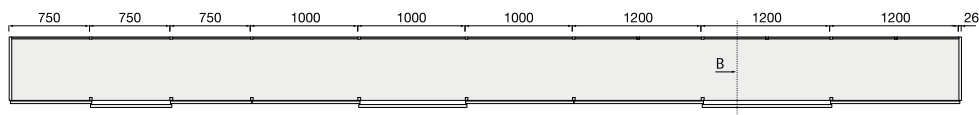

Larghezze moduli con montante interno  
Widths of internal upright modules

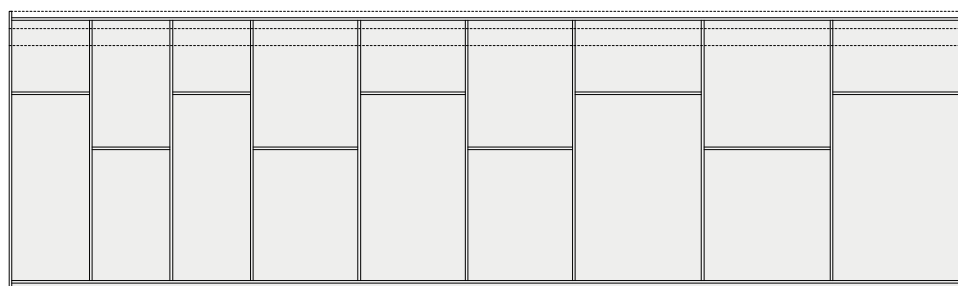

2590  
2430  
2270



Altezze e prospetti moduli senza ante  
Modules without doors - height and front view

Sezione A  
Section A

Sezione B  
Section B

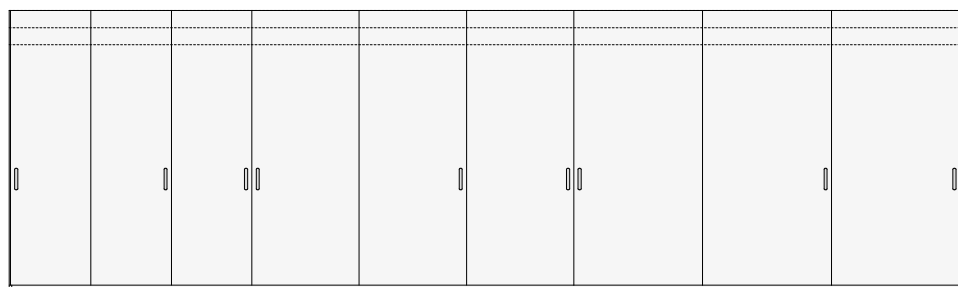

2590  
2430  
2270



Altezze e prospetti moduli con ante  
Modules with doors - height and front view

## DIMENSIONI ARMADIO SCORREVOLE 3 ANTE DIMENSIONS FOR 3 DOOR SLIDING WARDROBE

**Armadio chiuso con ante a sormonto parziale dei fianchi**  
Closed wardrobe with doors partially overlapping the sides

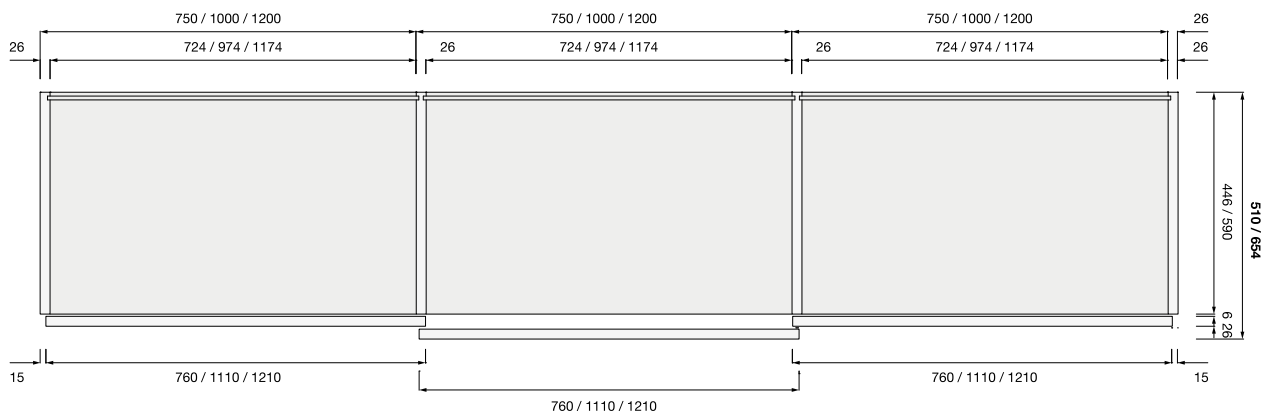

**Armadio chiuso con ante a sormonto totale dei fianchi**  
Closed wardrobe with doors totally overlapping the sides

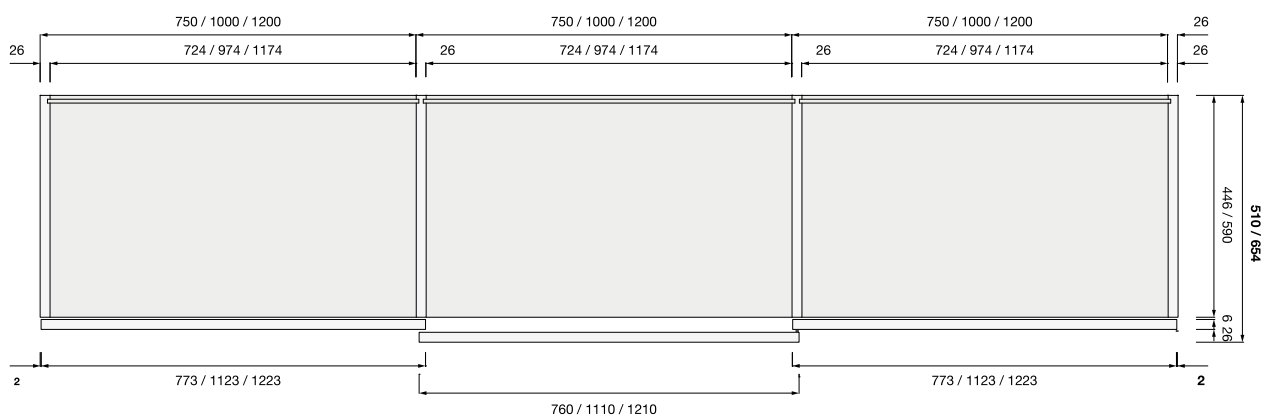

**Sormonto ante**  
Overlap doors

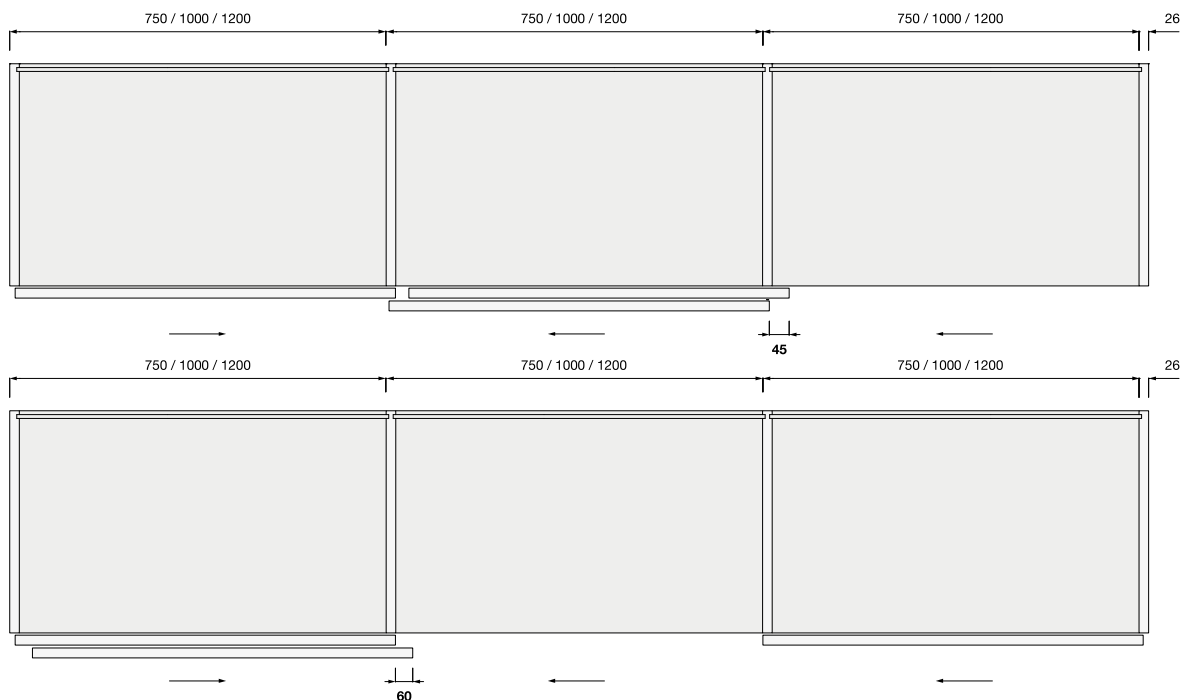

# Storage

MODULARITA'  
SECTIONAL DESIGN

## SCHEMA COMPONIBILITA' ORIZZONTALE ARMADIO SCORREVOLE HORIZONTAL SETTING PLAN FOR SLIDING WARDROBE

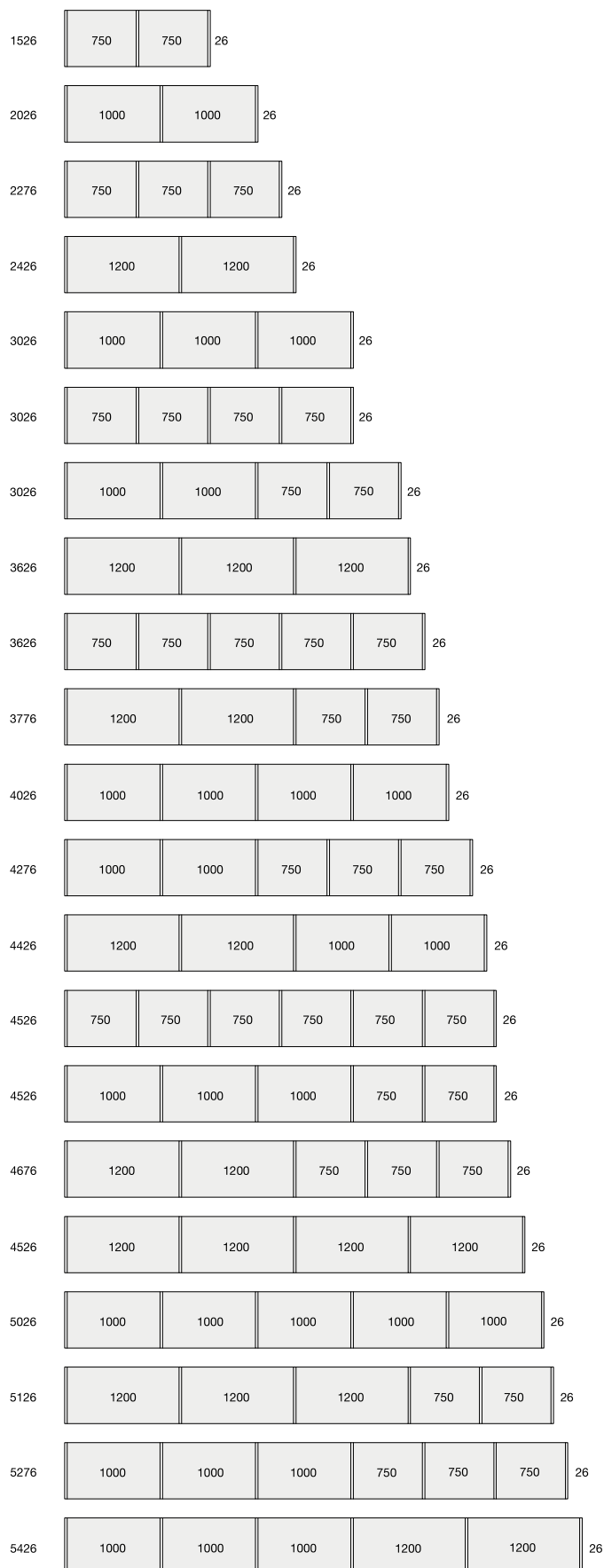



# Storage

MODULARITA'  
SECTIONAL DESIGN

DIMENSIONI MODULO ANGOLO BATTENTE - PER ANTE L.496  
HINGED CORNER MODULE DIMENSIONS - FOR DOORS W.496

Modulo angolo battente **LATO LUNGO DESTRO**  
Hinged corner module with **RIGHT** WIDER SIDE

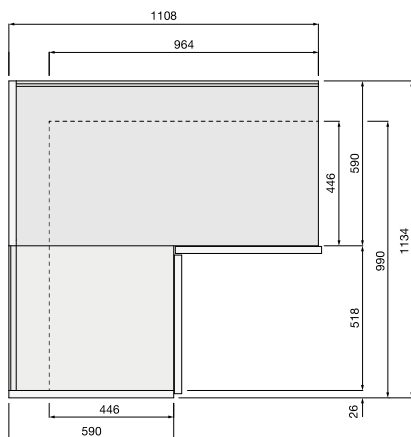

Con fianco e fondali legno  
With side and wooden back panels

Modulo angolo battente **LATO LUNGO SINISTRO**  
Hinged corner module with **LEFT** WIDER SIDE

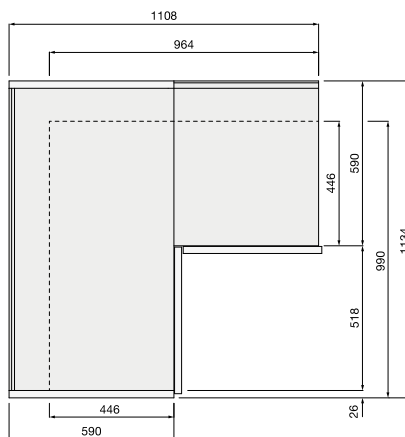

Con fianco e fondali legno  
With side and wooden back panels

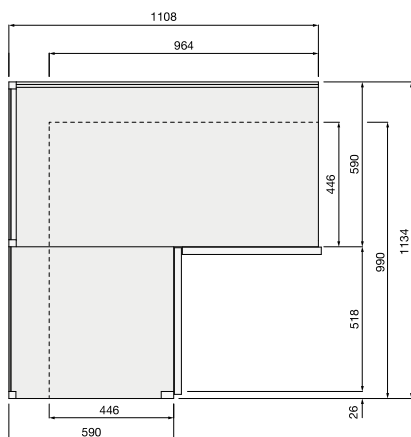

Con montante e fondali legno  
With upright and wooden back panels

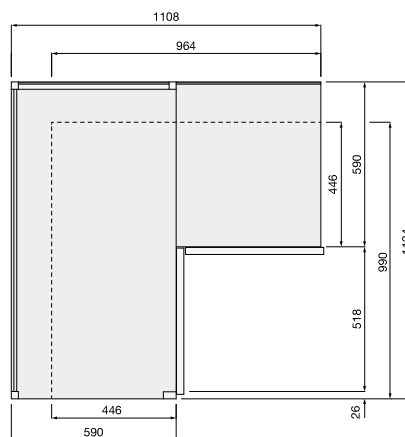

Con montante e fondali legno  
With upright and wooden back panels

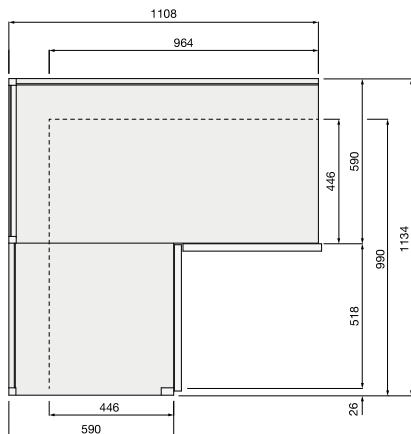

Con montante e fondali cristallo  
With upright and glass back panels

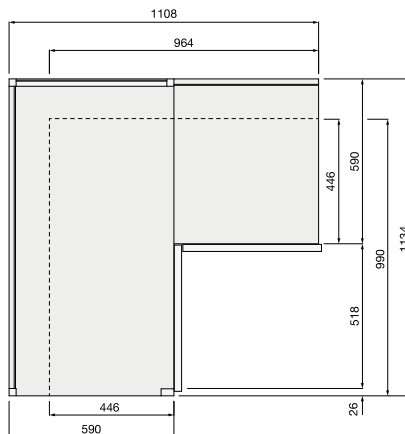

Con montante e fondali cristallo  
With upright and glass back panels

## DIMENSIONI MODULO ANGOLO BATTENTE - PER ANTE L.596 HINGED CORNER MODULE DIMENSIONS - FOR DOORS W.596

**Modulo angolo battente LATO LUNGO DESTRO**  
Hinged corner module with RIGHT WIDER SIDE

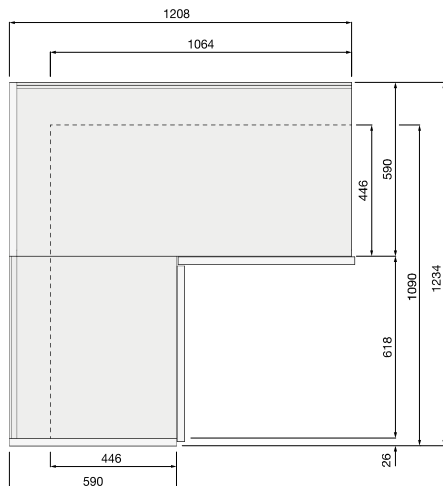

**Con fianco e fondali legno**  
With side and wooden back panels

ante L.600

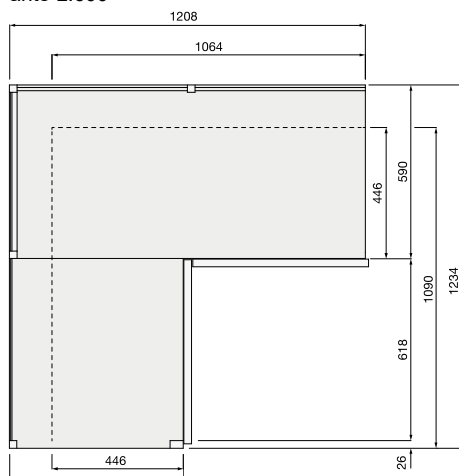

**Con montante e fondali legno**  
With upright and wooden back panels

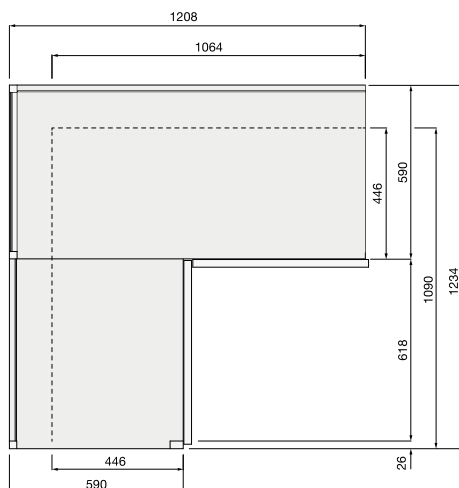

**Con montante e fondali cristallo**  
With upright and glass back panels

**Modulo angolo battente LATO LUNGO SINISTRO**  
Hinged corner module with LEFT WIDER SIDE

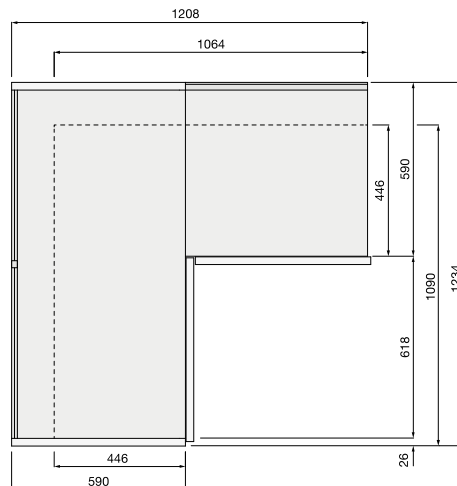

**Con fianco e fondali legno**  
With side and wooden back panels

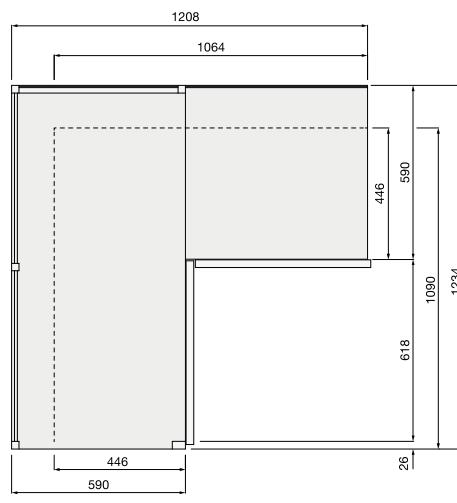

**Con montante e fondali legno**  
With upright and wooden back panels

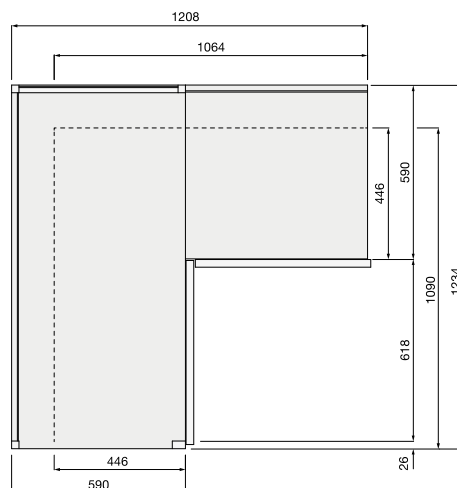

**Con montante e fondali cristallo**  
With upright and glass back panels

# Storage

MODULARITA'  
SECTIONAL DESIGN

## DIMENSIONI MODULO ANGOLO A GIORNO OPEN CORNER MODULE DIMENSIONS

Utilizzo modulo angolo a giorno **SINISTRO**  
**LEFT** open corner module use

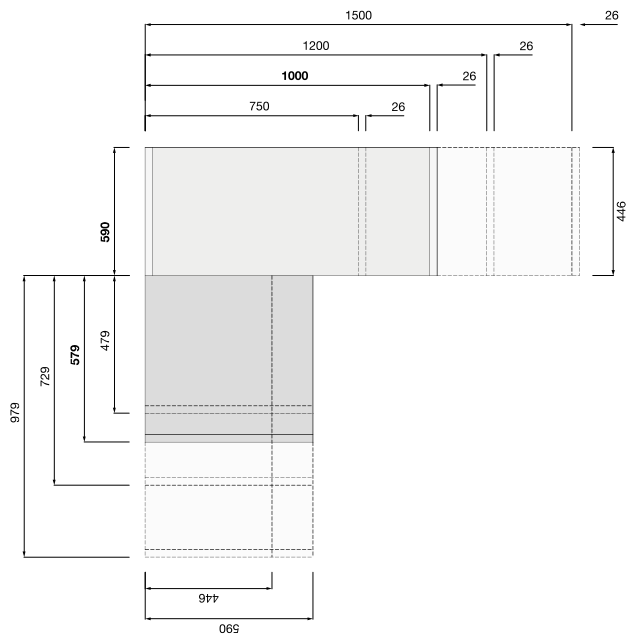

Profondità 446 mm  
Depth 446 mm

Utilizzo modulo angolo a giorno **DESTRO**  
**RIGHT** open corner module use

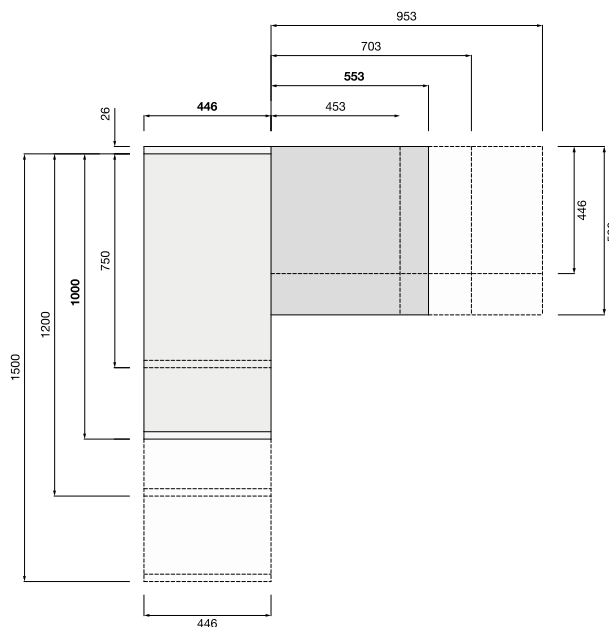

Profondità 446 mm  
Depth 446 mm

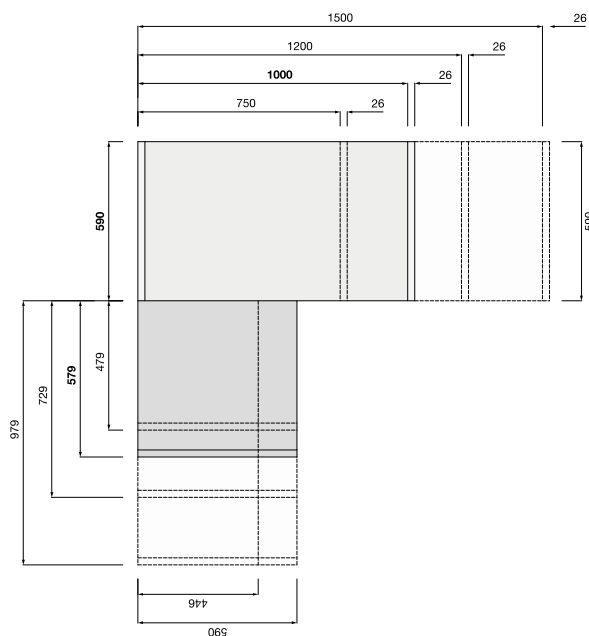

Profondità 590 mm  
Depth 590 mm

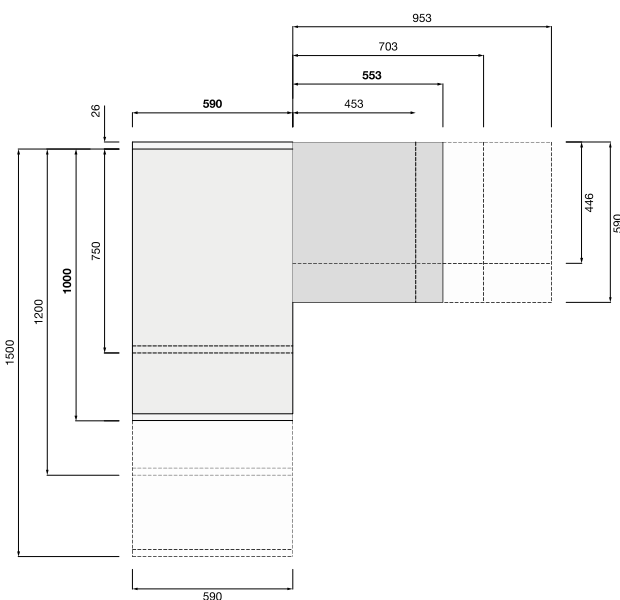

Profondità 590 mm  
Depth 590 mm

## DIMENSIONI MODULO ANGOLO CABINA ARMADIO WALK-IN-CLOSET CORNER MODULE DIMENSIONS

**Modulo angolo LATO LUNGO DESTRO**  
Corner module with RIGHT WIDER SIDE

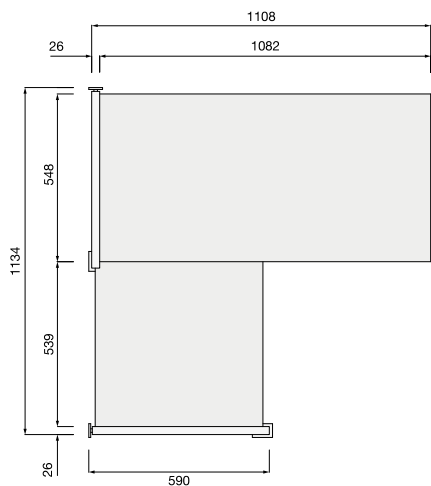

**Modulo angolo LATO LUNGO SINISTRO**  
Corner module with LEFT WIDER SIDE

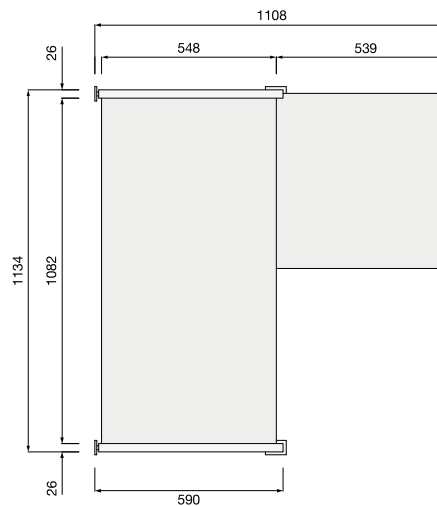



# Storage

MODULARITA'  
SECTIONAL DESIGN

COSTRUZIONE DI UNA COMPOSIZIONE CON MODULO ANGOLO A GIORNO - OPZIONE A  
DESIGN OF A COMPOSITION WITH OPEN CORNEN MODULE - OPTION A

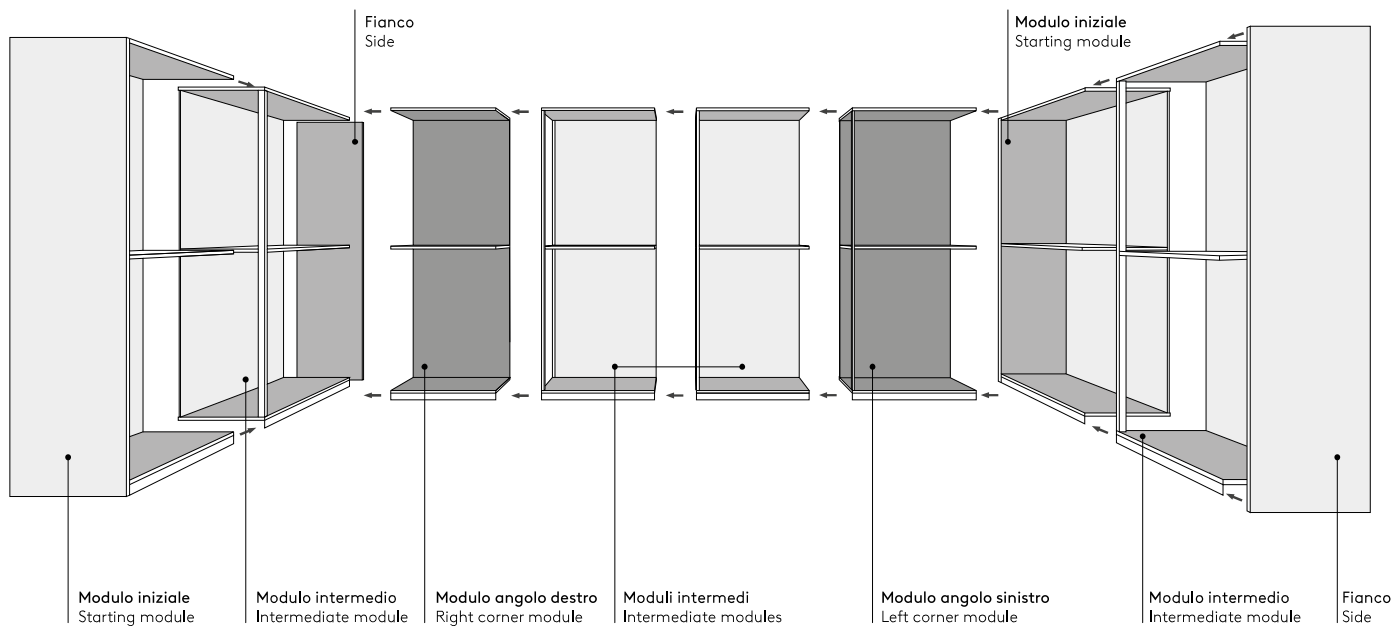

Vista esplosa  
Exploded view

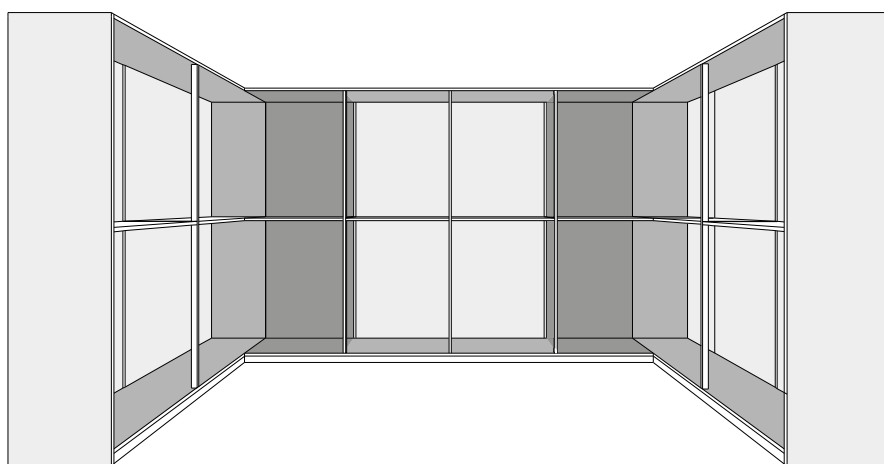

Vista armadio composto  
Complete wardrobe view

COSTRUZIONE DI UNA COMPOSIZIONE CON MODULO ANGOLO A GIORNO - OPZIONE B  
DESIGN OF A COMPOSITION WITH OPEN CORNEN MODULE - OPTION B

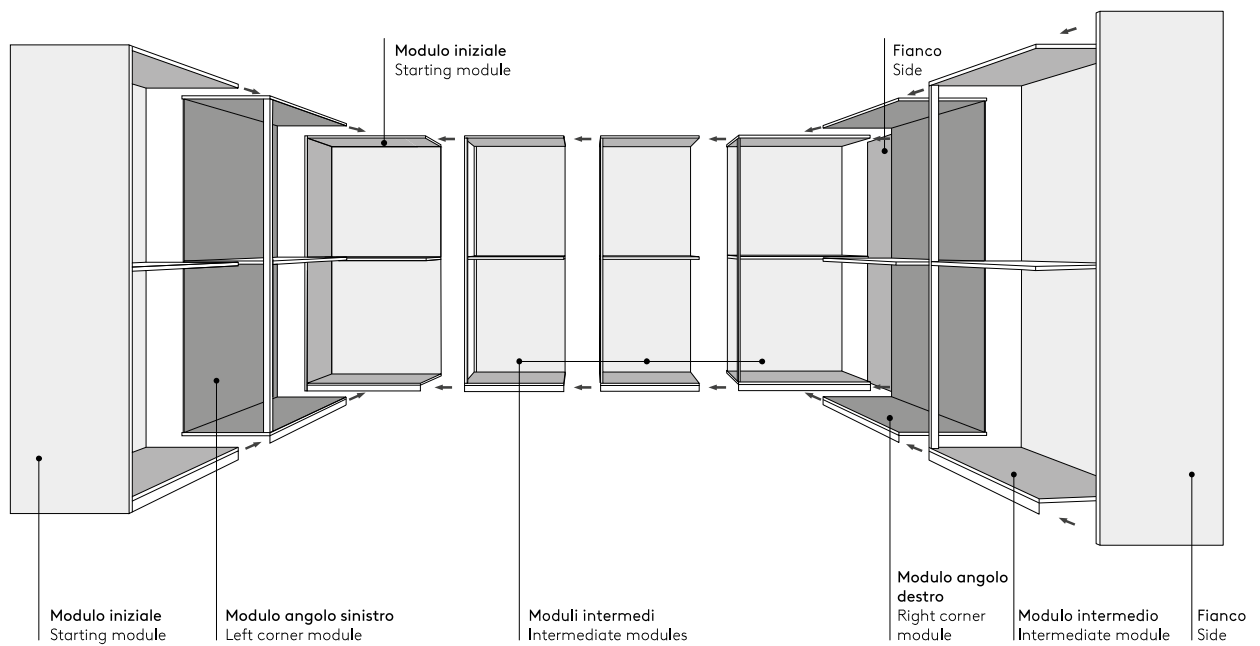

Vista esplosa  
Exploded view

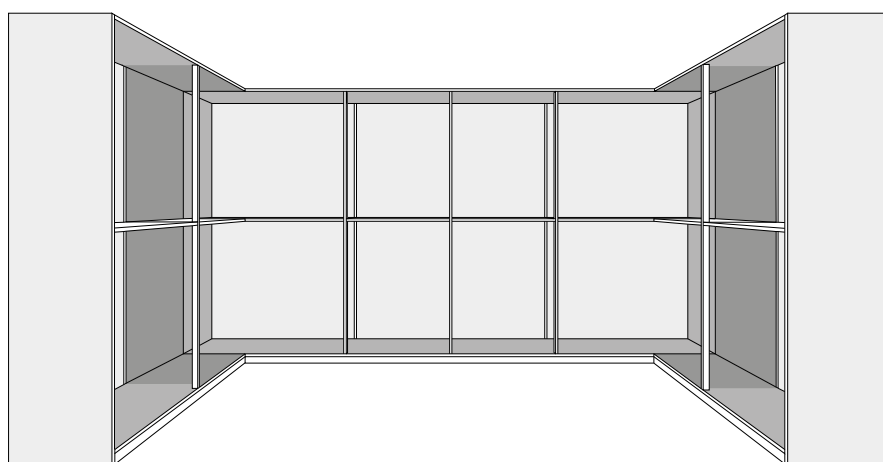

Vista armadio composto  
Complete wardrobe view

# Storage

AGGIUSTAGGI  
FITTINGS

## CHIUSURA LATERALE FISSA FIXED LATERAL CLOSURE

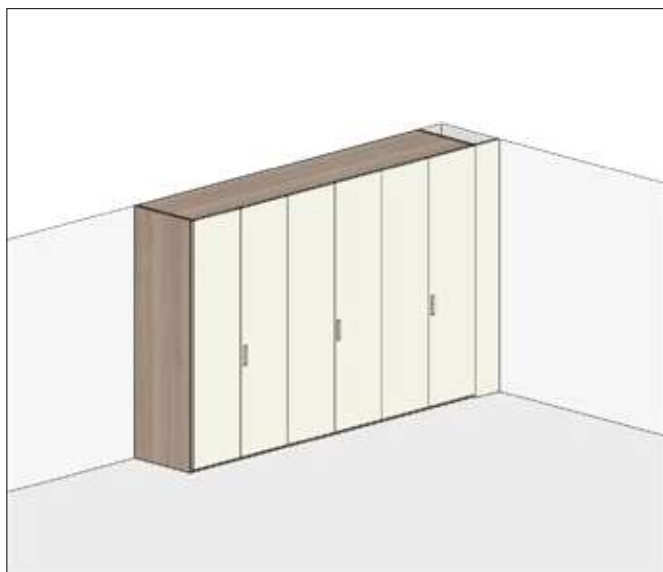

Allineata all'anta  
Flush with the door

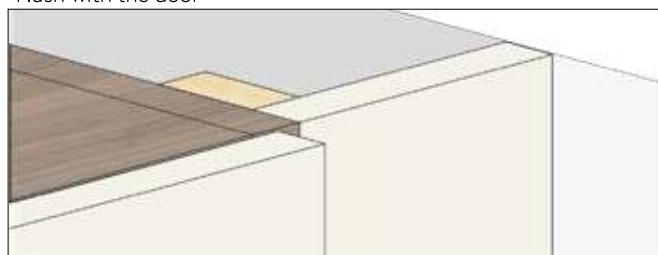

Allineata alla struttura  
Flush with the structure

Larghezza su misura (fino a 300 mm).  
Specificare al momento dell'ordine se la chiusura deve essere allineata all'anta o alla struttura.  
Customized width (up to 300 mm).  
Please specify in the order if the closure must be flush with the door or with the structure.

## CHIUSURA LATERALE APRIBILE OPENING VERTICAL CLOSURE

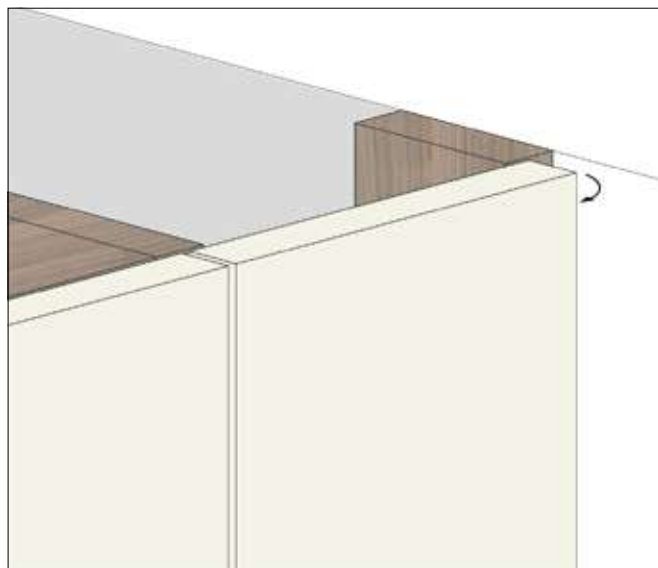
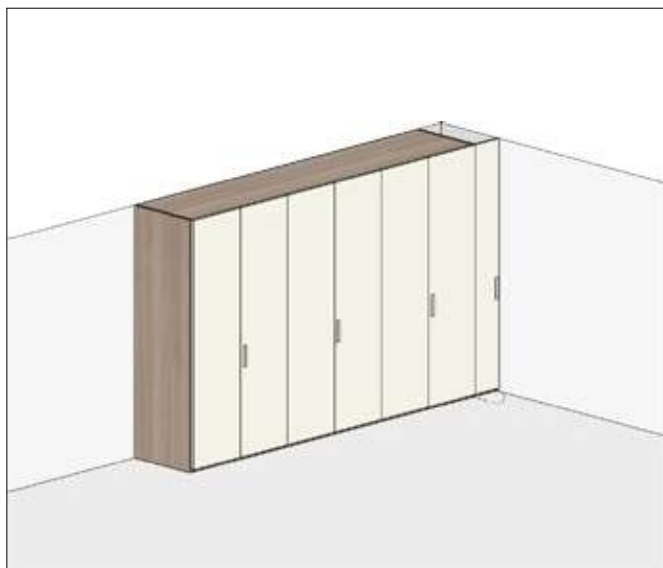

Larghezza su misura (fino a 300 mm).  
Le chiusure apribili devono essere incernierate sul fianco terminale dell'armadio. Il loro prezzo comprende le cerniere 155°, lo zoccolo e il listello per la battuta da fissare a muro.  
Customized width (up to 300 mm).  
Opening closures must be hinged on the end side of the wardrobe. Their price includes the 155° hinges, the baseboard and the wooden strip to be fixed to the wall.

**CHIUSURA SUPERIORE FRONTALE (con ante battenti)**  
**HORIZONTAL CLOSURE (with hinged doors)**

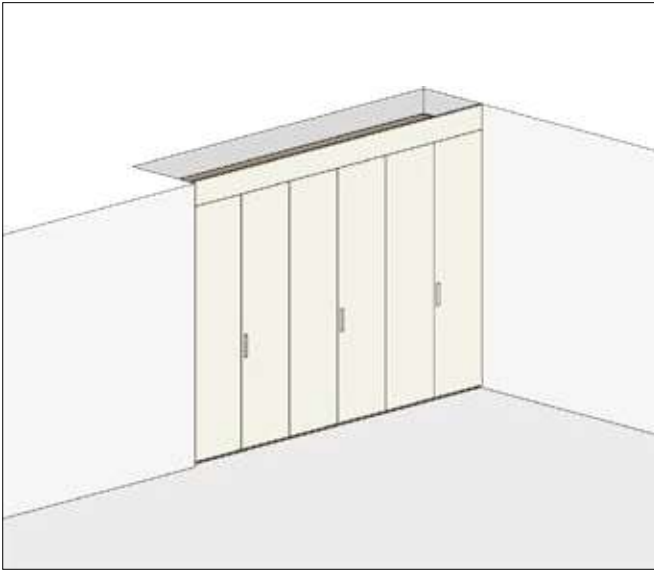

Armadio con ante battenti.  
Altezza su misura (fino a 300 mm).  
La lunghezza massima disponibile è di 3000 mm.  
Hinged-door wardrobe.  
Customized height (up to 300 mm).  
The maximum available length is 3000 mm.

**CHIUSURA SUPERIORE FRONTALE (con ante scorrevoli)**  
**HORIZONTAL CLOSURE (with sliding doors)**

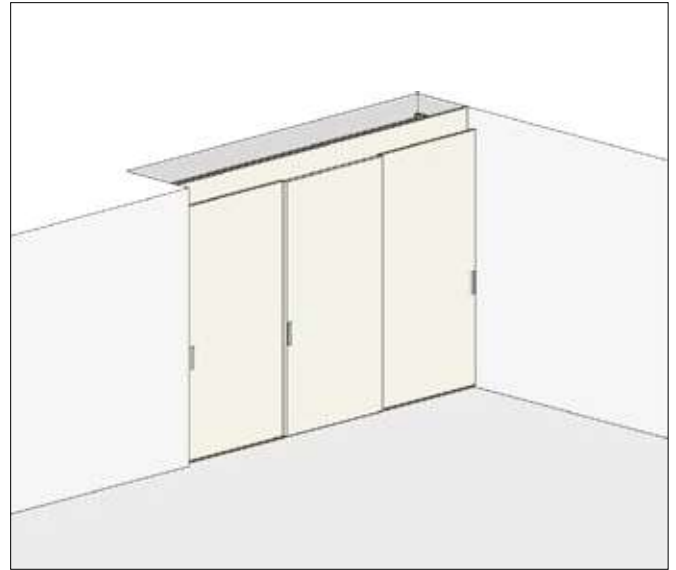

Armadio con ante scorrevoli. Altezza su misura (fino a 300 mm).  
La lunghezza massima disponibile è di 3000 mm.  
Negli armadi con movimento scorrevole la chiusura superiore frontale viene posizionata arretrata di 60 mm rispetto alle ante.  
Sliding-door wardrobe. Customized height (up to 300 mm).  
The maximum available length is 3000 mm.  
In wardrobes with a sliding mechanism, the horizontal closure is placed 60 mm backwards compared to the doors.

**ANTE PIU' ALTE RISPETTO ALLA STRUTTURA**  
**DOORS HIGHER THAN THE STRUCTURE**

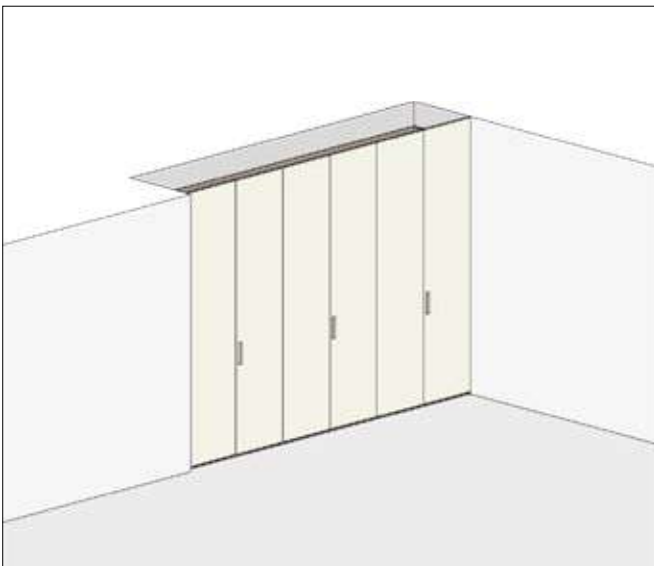

Possibile solo su ante battenti.  
Possible only on hinged doors.

**ANTE E FIANCO PIU' ALTI RISPETTO ALLA STRUTTURA**  
**DOORS AND SIDE HIGHER THAN THE STRUCTURE**

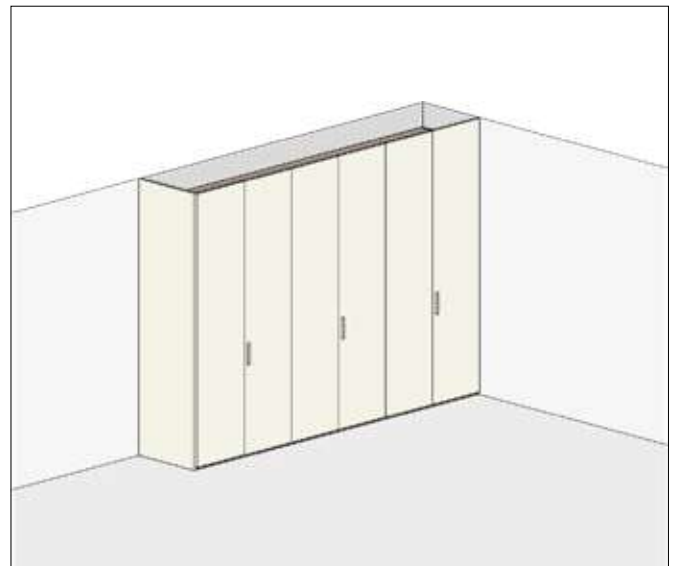

Possibile solo su ante battenti.  
Possible only on hinged doors.

# Storage

AGGIUSTAGGI  
FITTINGS

SALTO IN ALTEZZA  
HEIGHT DIFFERENCE

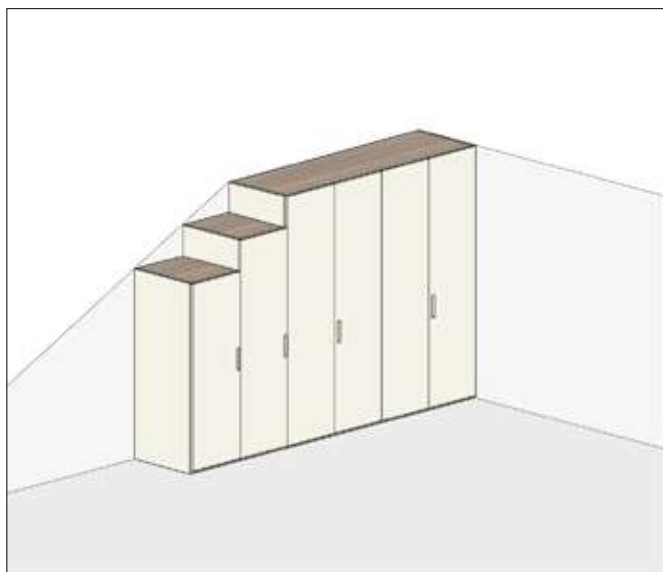

Possibile su moduli con anta battente.  
Possible on hinged modules.

SALTO IN ALTEZZA CON TAGLIO INCLINATO SU ANTA  
HEIGHT DIFFERENCE WITH SLANTED CUT ON DOOR

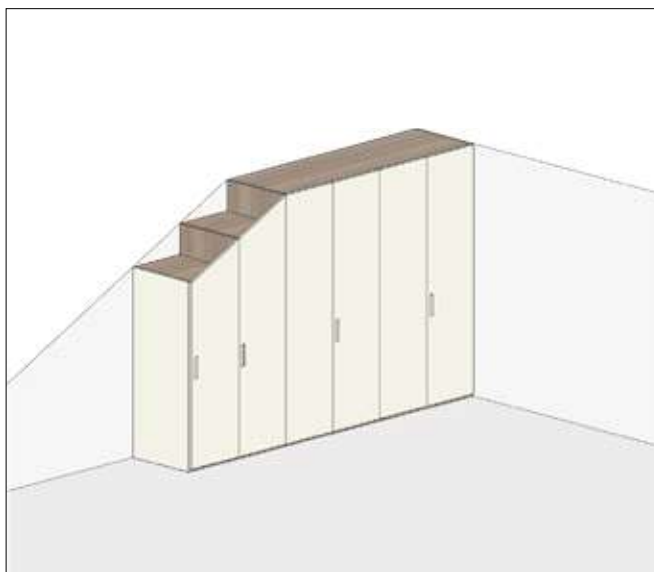

Possibile su moduli con anta battente Piana.  
Possible on hinged modules with Piana door.

RIDUZIONE IN PROFONDITA'  
DEPTH REDUCTION

