

SEISMOLOGY

Master Degree Programme in Physics - UNITS
Physics of the Earth and of the Environment

SEISMIC FORCES 2: BODY FORCES

FABIO ROMANELLI

Department of Mathematics & Geosciences

University of Trieste

romanel@units.it

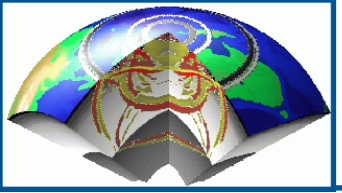

Seismic sources - 2

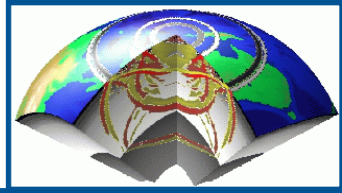

Elastodynamic theorems

- unicity
- reciprocity (Betti)
- Elastodynamic Green Function
- representation

Equivalent body forces

- shear dislocation
- density of moment tensor
- moment tensor for point sources
- double couple
- scalar moment

Kinematic model - Tohoku

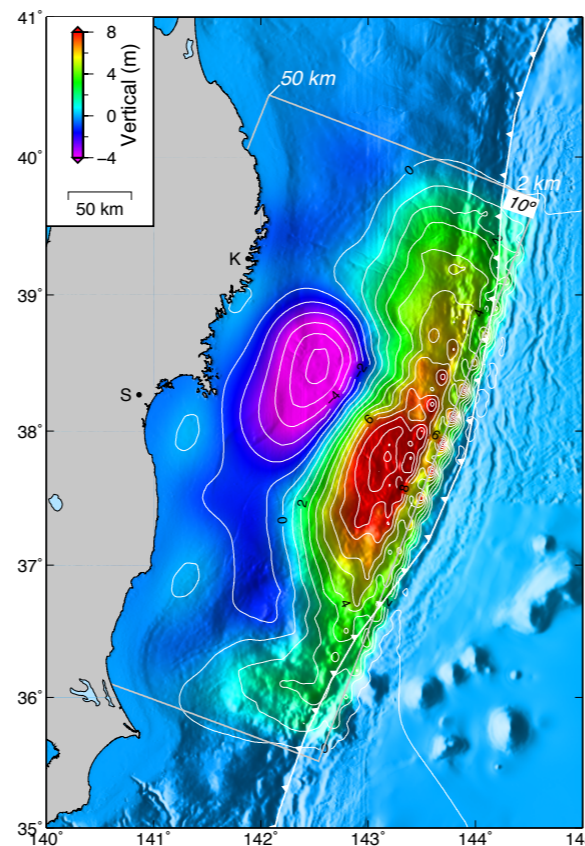
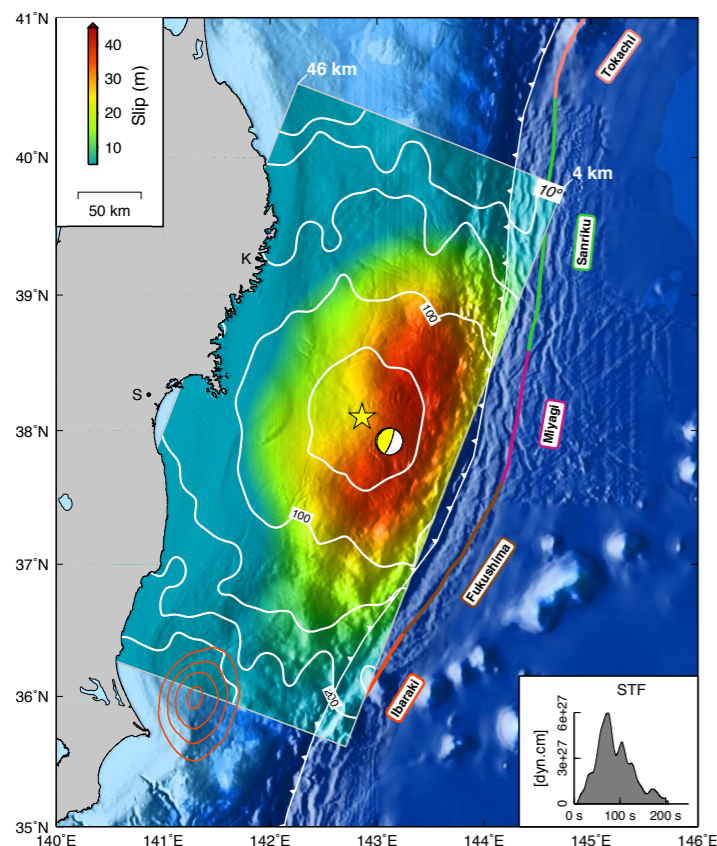
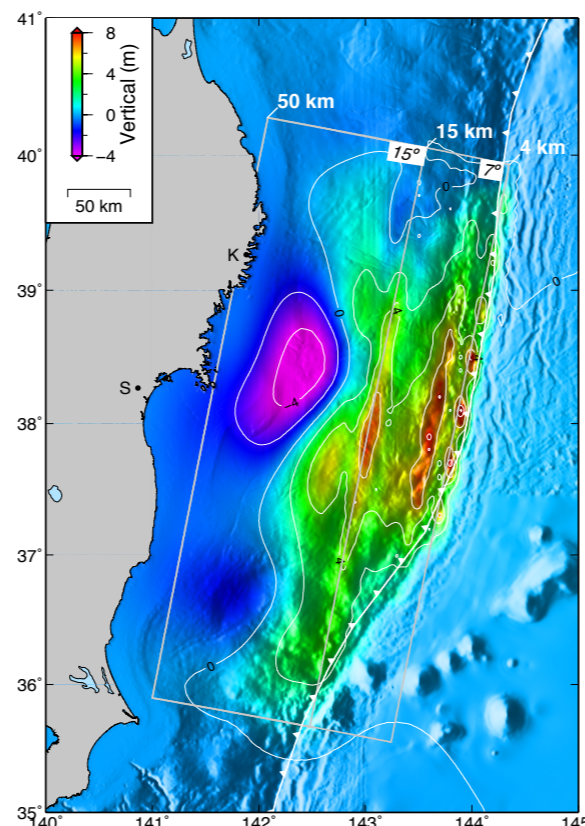
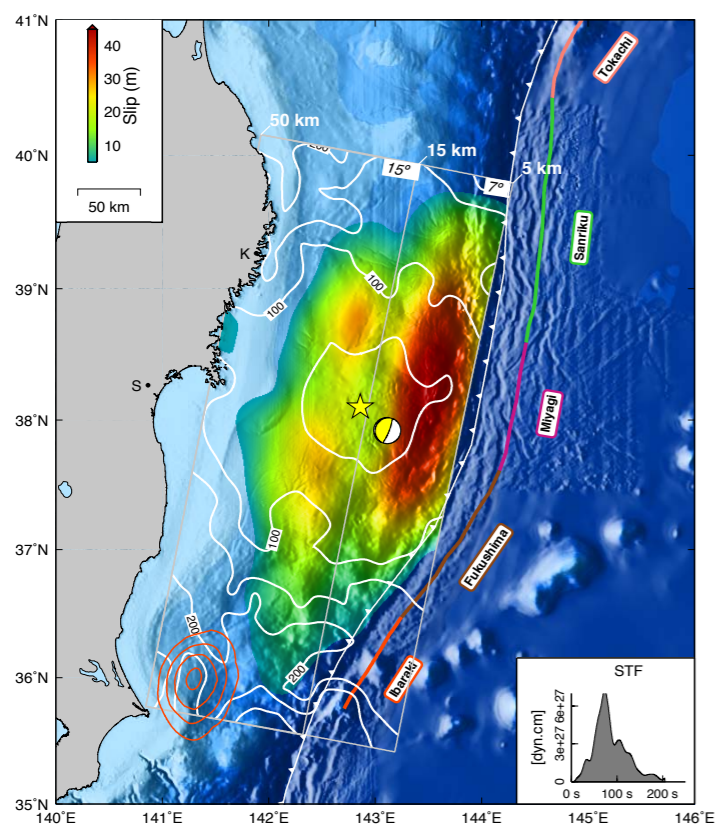
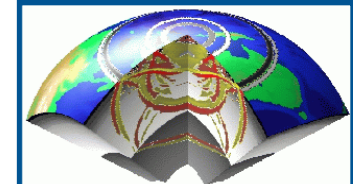
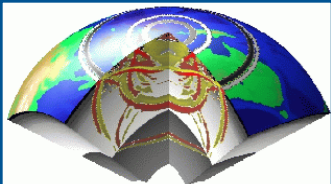

Kinematic fault slip models constrained by GPS measurements and teleseismic P-waveforms.

Estimated fault slip (left) and predicted vertical seafloor displacements (right) are shown for the two-plane (top) and one-plane (bottom) kinematic models. Dip angles and depth are given in the northeast corner of each fault plane. White contours indicate temporal evolution of the rupture front, with time in seconds. The yellow star shows the epicenter used for each inversion. The respective moment rate functions are plotted in the insets.

Simons et al., 2011. Science, vol. 332 no. 6036 pp. 1421-1425

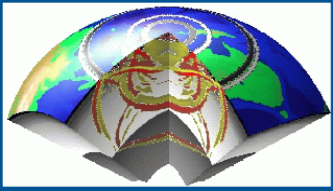

Equivalent Forces: concepts

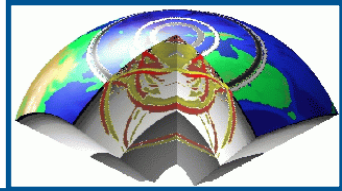

The observable seismic radiation is through energy release as the fault surface moves: formation and propagation of a crack. This complex dynamical problem can be studied by kinematical equivalent approaches.

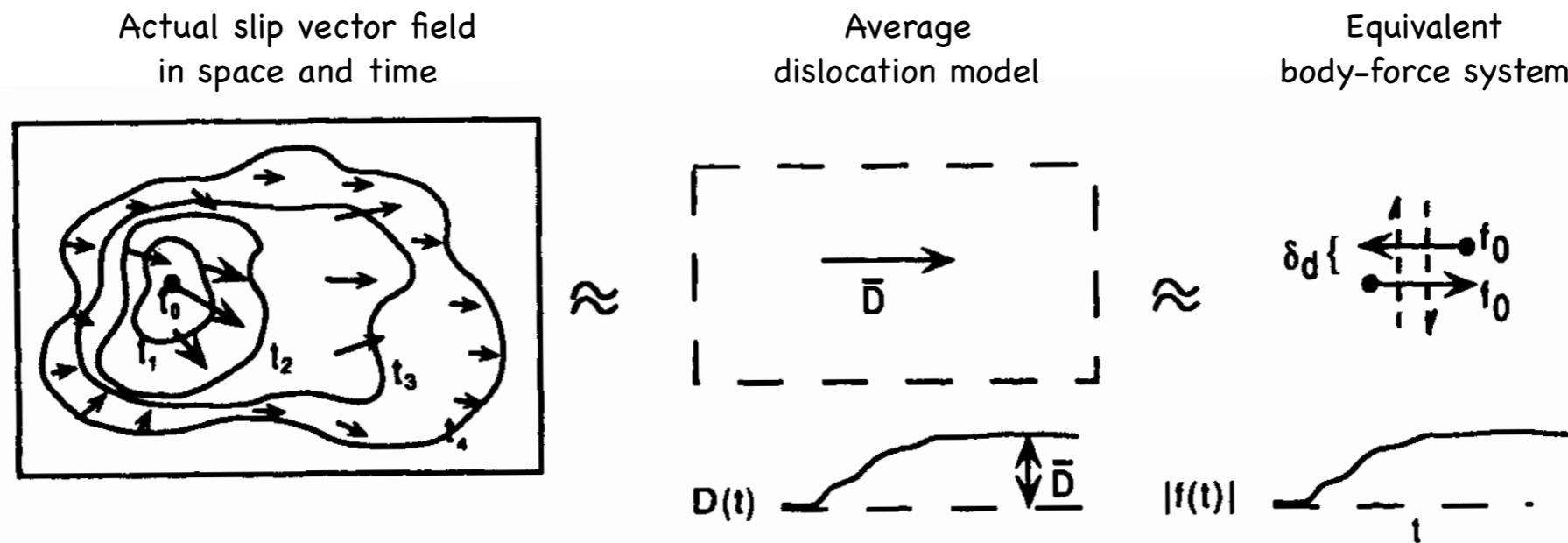

The scope is to develop a representation of the displacement generated in an elastic body in terms of the quantities that originated it: body forces and applied tractions and displacements over the surface of the body.

The actual slip process will be described by superposition of equivalent body forces acting in space (over a fault) and time (rise time).

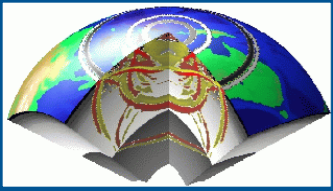

Fundamental papers

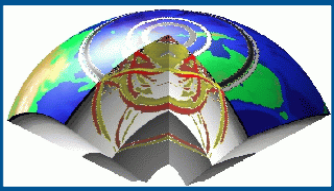

- Maruyama T. (1963). On the force equivalents of dynamical elastic dislocations with reference to the earthquake mechanism. Bulletin of the Earthquake Research Institute 41: 467–486.
- Burridge R. and Knopoff L. (1964). Body force equivalents for seismic dislocations. Bulletin of the Seismological Society of America 54: 1875–1878.

“An explicit expression is derived for the body force to be applied in the absence of a dislocation, which produces radiation identical to that of the dislocation. This equivalent force depends only upon the source and the elastic properties of the medium in the immediate vicinity of the source and not upon the proximity of any reflecting surfaces. The theory is developed for dislocations in an anisotropic inhomogeneous medium; in the examples isotropy is assumed. For displacement dislocation faults, the double couple is an exact equivalent body force.”



Leon Knopoff

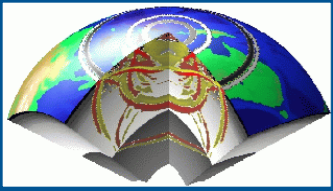

Fundamental papers

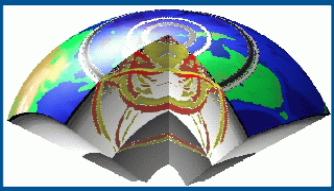

Pujol J. (2003): **The body force equivalent to an earthquake: a tutorial.**
Seism. Res. Lett. 74, 163–168.

“During the 1950’s another theoretical tool was brought to bear, namely dislocation theory. This theory originated in the work of a number of Italian mathematicians, particularly Volterra, who used the word “**distorsione**”. “**Dislocation**” is Love’s translation (Love, 1927). A dislocation can be visualized through the following thought experiment, based on Steketee (1958). Consider a cut made over a surface Σ within an elastic body. After the cut has been made there are two surfaces, indicated with Σ_+ and Σ_- , which will be deformed differently by application of some force distribution. If the combined system of forces is in static equilibrium, then the body will remain in the original equilibrium state. The result of this operation is a discontinuity in the displacement across Σ , known as a dislocation, which is accommodated by deformation within the body. This description should be compared to our model for a tectonic earthquake, which is represented by slip on a fault plane. When an earthquake occurs, the two sides of the fault suffer a sudden relative displacement with respect to each other, and this discontinuity in the displacement across the fault is the source of the displacement elsewhere in the medium.

The debate ended when Maruyama (1963), Haskell (1964) and Burridge and Knopoff (1964) demonstrated that the body force equivalent was a double couple. In the three cases the derivations were based on a number of results derived in the context of theoretical elasticity and wave propagation. However, while the first two authors addressed the case of homogeneous isotropic media, what distinguishes Burridge and Knopoff’s paper is its generality, as their results apply to heterogeneous anisotropic media”.

Love, A., 1927. A treatise on the mathematical theory of elasticity, Cambridge University Press (Reprinted by Dover, New York, 1944.)

Stauder, W., 1962, The focal mechanism of earthquakes, in H. Landsberg and J. Van Miegheem, Eds., Advances in Geophysics 9, Academic Press, 1-76.

Steketee, J., 1958. Some geophysical applications of the elasticity theory of dislocations, Can. J. Phys. 36, 1168-1198.

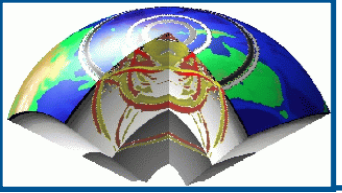

Elastodynamic basic theorems

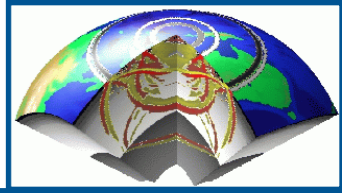

Considering an elastic body of volume V and surface S , the application of a system of body forces (f_i), as well as the application of tractions, will generate a displacement field that is constrained to satisfy the equations of motion:

$$\rho \ddot{u}_i = f_i + \frac{\partial \sigma_{ij}}{\partial x_j} = f_i + \sigma_{ij,j}$$

The equation can be written also, using the vector differential operator

$$\left(L(\mathbf{u}) \right)_i = \rho \ddot{u}_i - \sigma_{ij,j} = \rho \ddot{u}_i - \left(c_{ijkl} u_{k,l} \right)_{,j}$$

as:

$$L(\mathbf{u}) = \mathbf{f}$$

that is the inhomogeneous version respect to $L(\mathbf{u})=0$

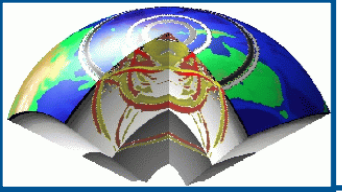

Uniqueness theorem

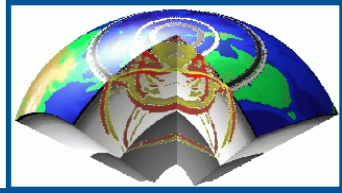

Uniqueness theorem: the displacement field, $\mathbf{u}=\mathbf{u}(\mathbf{x},t)$, is uniquely determined, after time t_0 , by:

- a) initial values of displacement and velocities (at t_0) in all V ;
- b) body forces and heat in V , after t_0 ;
- c) tractions over any part S_1 of S , after t_0 ;
- d) displacement over S_2 of S , with $S_1+S_2=S$, after t_0 .

Proof: Suppose there are two (u_1 and u_2) and consider the difference: it will be 0...

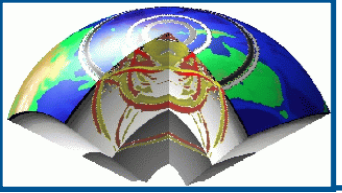

Reciprocity theorem - 1

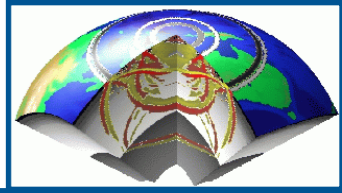

Consider a pair of solutions for the displacement through an elastic body V and look for relationships between them...

\mathbf{u} is due to body forces \mathbf{f} , boundary conditions on S and initial conditions at $t=0$; \mathbf{v} is due to body forces \mathbf{g} and other boundary and initial conditions; the two tractions on surfaces normal to \mathbf{n} being respectively $\mathbf{T}(\mathbf{u}, \mathbf{n})$ and $\mathbf{T}(\mathbf{v}, \mathbf{n})$. Using the equations of motion and the divergence theorem one has the first form of reciprocity theorem (**Betti theorem**):

$$\begin{aligned} \iiint_V (\mathbf{f} - \rho \ddot{\mathbf{u}}) \cdot \mathbf{v} dV + \iint_S \mathbf{T}(\mathbf{u}, \mathbf{n}) \cdot \mathbf{v} dS &= \\ = \iiint_V (\mathbf{g} - \rho \ddot{\mathbf{v}}) \cdot \mathbf{u} dV + \iint_S \mathbf{T}(\mathbf{v}, \mathbf{n}) \cdot \mathbf{u} dS \end{aligned}$$

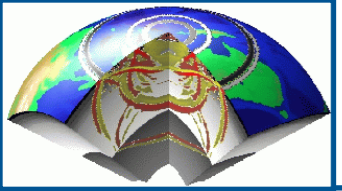

Reciprocity theorem - 2

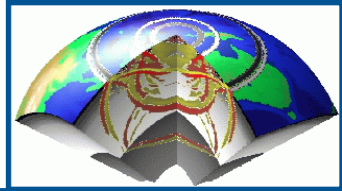

Note that Betti's theorem does not involve initial conditions for \mathbf{u} or \mathbf{v} , and it is true even if the quantities $(\mathbf{u}, d\mathbf{u}/dt, \mathbf{T}(\mathbf{u}, \mathbf{n}))$ and $(\mathbf{v}, d\mathbf{v}/dt, \mathbf{T}(\mathbf{v}, \mathbf{n}))$ are evaluated at different times, e.g. at t and $\tau - t$. Integrating over $(0, \tau)$ and assuming a quiescent past (i.e. $\mathbf{u} = d\mathbf{u}/dt = \mathbf{v} = d\mathbf{v}/dt = 0$ for $t < 0$), one obtains:

$$\int_{-\infty}^{+\infty} dt \iiint_V \left\{ \mathbf{u}(\mathbf{x}, t) \cdot \mathbf{g}(\mathbf{x}, \tau - t) - \mathbf{v}(\mathbf{x}, \tau - t) \cdot \mathbf{f}(\mathbf{x}, t) \right\} dV =$$
$$= \int_{-\infty}^{+\infty} dt \iint_S \left\{ \mathbf{v}(\mathbf{x}, \tau - t) \cdot \mathbf{T}(\mathbf{u}(\mathbf{x}, t), \mathbf{n}) - \mathbf{u}(\mathbf{x}, t) \cdot \mathbf{T}(\mathbf{v}(\mathbf{x}, \tau - t), \mathbf{n}) \right\} dS$$

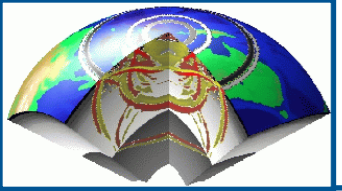

Green's function

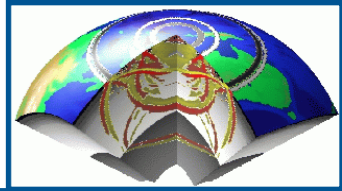

Green's function (GF) is a basic solution to a linear differential equation, a building block that can be used to construct many useful solutions.

If one considers a linear differential equation written as:

$$L(x)u(x)=f(x)$$

where $L(x)$ is a linear, self-adjoint differential operator, $u(x)$ is the unknown function, and $f(x)$ is a known non-homogeneous term, the GF is a solution of:

$$L(x)u(x,s)=\delta(x-s)$$

$$G(x,s)$$

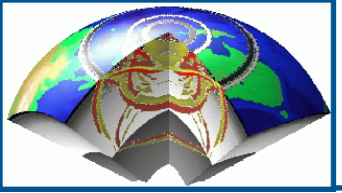

Why GF is important?

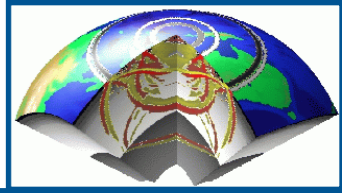

If such a function G can be found for the operator L , then if we multiply the second equation for the Green's function by $f(s)$, and then perform an integration in the s variable, we obtain:

$$\int L(x)G(x, s)f(s)ds = \int \delta(x - s)f(s)ds = f(x) = Lu(x)$$
$$L \int G(x, s)f(s)ds = Lu(x)$$

$$u(x) = \int G(x, s)f(s)ds$$

Thus, **we can obtain the function $u(x)$ through the knowledge of the Green's function and the source term.** This process has resulted from the linearity of the operator L . See Linear System Theory (i.e. impulse response)

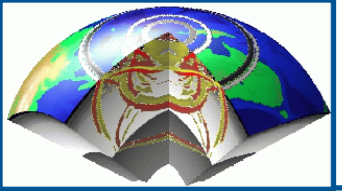

Elastodynamic GF

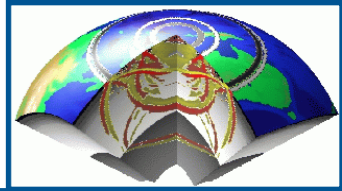

The displacement from the simplest source, unidirectional unit impulse, is the **Elastodynamic Green's function**.

If the unit impulse is applied at $\mathbf{x}=\zeta$ and $t=\tau$ and in the n -direction, the i -th component of displacement at (\mathbf{x},t) is $G_{in}(\mathbf{x},t;\zeta,\tau)$.

This tensor depends on both receiver and source coordinates and satisfies, throughout V , the equations:

$$\rho \frac{\partial^2 \mathbf{G}_{in}}{\partial t^2} = \delta_{in} \delta(\mathbf{x} - \zeta) \delta(t - \tau) + \frac{\partial}{\partial x_j} \left(\mathbf{c}_{ijkl} \frac{\partial \mathbf{G}_{kn}}{\partial x_l} \right)$$

The initial conditions for $G_{in}(\mathbf{x},t;\zeta,\tau)$, and its time derivative, are that they are 0 for $t \leq \tau$ and $\mathbf{x} \neq \zeta$, and, to be uniquely specified, it remains to state the boundary conditions on S (for example if it is rigid or free).

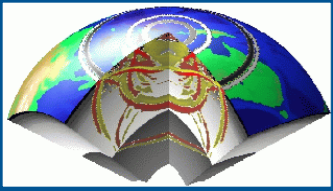

Green's function

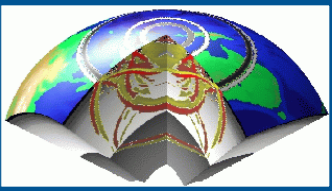

If the boundary conditions are independent of time, then \mathbf{G} will depend on time only via the combination $t-\tau$.

If \mathbf{G} satisfies homogeneous boundary conditions on S , reciprocity theorem can be used to obtain relations for source and receiver positions.

Considering $G_{im}(\mathbf{x}, t; \xi_1, \tau_1)$ and $G_{in}(\mathbf{x}, t; \xi_2, -\tau_2)$ one has:

$$G_{nm}(\xi_2, \tau + \tau_2; \xi_1, \tau_1) = G_{mn}(\xi_1, \tau - \tau_1; \xi_2, -\tau_2), \text{ and if } \tau_1 = \tau_2 = 0$$

$$G_{nm}(\xi_2, \tau; \xi_1, 0) = G_{mn}(\xi_1, \tau; \xi_2, 0), \text{ thus a spatial reciprocity, and if } \tau = 0$$

$$G_{nm}(\xi_2, \tau_2; \xi_1, \tau_1) = G_{mn}(\xi_1, -\tau_1; \xi_2, -\tau_2) \text{ thus a space-time reciprocity.}$$

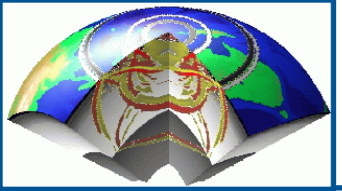

Representation theorem - 1st

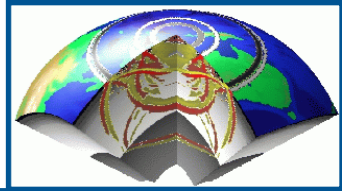

Using Betti's theorem with a Green function for the displacement field, i.e. due to $g_i(\mathbf{x}, t) = \delta_{in} \delta(\mathbf{x} - \xi) \delta(t)$, we obtain a representation for the other :

$$\begin{aligned} u_n(\mathbf{x}, t) = & \int_{-\infty}^{+\infty} d\tau \iiint_V f_i(\xi, \tau) G_{in}(\xi, t - \tau; \mathbf{x}, 0) dV(\xi) + \\ & + \int_{-\infty}^{+\infty} d\tau \iint_S \left\{ G_{in}(\xi, t - \tau; \mathbf{x}, 0) T_i(u(\xi, \tau), \mathbf{v}) + \right. \\ & \left. - u_i(\xi, \tau) c_{ijkl} v_j G_{kn,l}(\xi, t - \tau; \mathbf{x}, 0) \right\} dS(\xi) \end{aligned}$$

That states how the displacement \mathbf{u} at a certain point is given by contributions due to force \mathbf{f} throughout V , traction \mathbf{T} and \mathbf{u} itself on S .

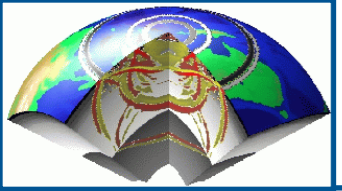

Representation theorem - 1st

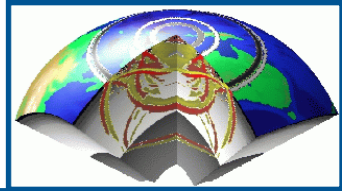

$$u_n(\mathbf{x}, t) = \iiint_V \mathbf{f}_p * \mathbf{G}_{np} dV + \iint_S \left(\mathbf{T}_p * \mathbf{G}_{np} - u_i c_{ijpq} v_j * \mathbf{G}_{np,q} \right) dS$$

schematically, the displacement field at a point of the volume V with surface S is given by:

- a volume integral over the body forces \mathbf{f} convolved with the **EGF**;
- a surface integral over the tractions \mathbf{T} convolved with the **EGF**;
- a surface integral over a quantity convolved with the spatial derivative of the **EGF**.

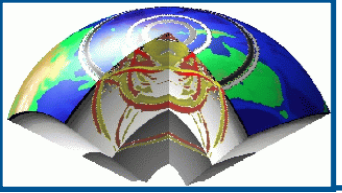

Internal sources & faults

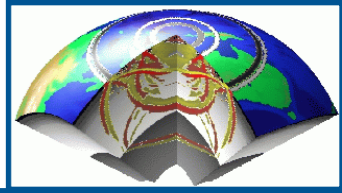

- External sources (e.g. atmospheric storms, ocean waves, meteorite impacts) can be described by time-dependent stress perturbations of the surface of the Earth.
- For **internal sources**, like earthquakes or underground explosions, the analytical framework is difficult to develop since the equation of elastic motion are no more valid throughout the whole Earth, since discontinuities are present.
- A volume source is an event associated with an internal volume, such as a sudden expansion throughout a volumetric source. A **faulting source** is an event associated with an internal surface, such as slip across a fracture plane.
- A unified treatment of both kind of sources is possible, the common link being the **concept of an internal surface across which discontinuities can occur in displacement** or in stress.
- The surface is usually considered as external to V , but it is useful to include two adjacent internal surfaces, being the opposite faces of a buried fault $S+\Sigma'+\Sigma''$. The fault plane (Σ) is described by its normal $\mathbf{v}(\xi)$ over Σ .

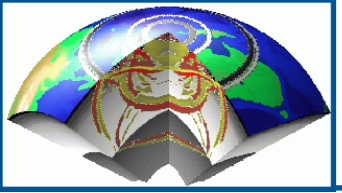

Fault

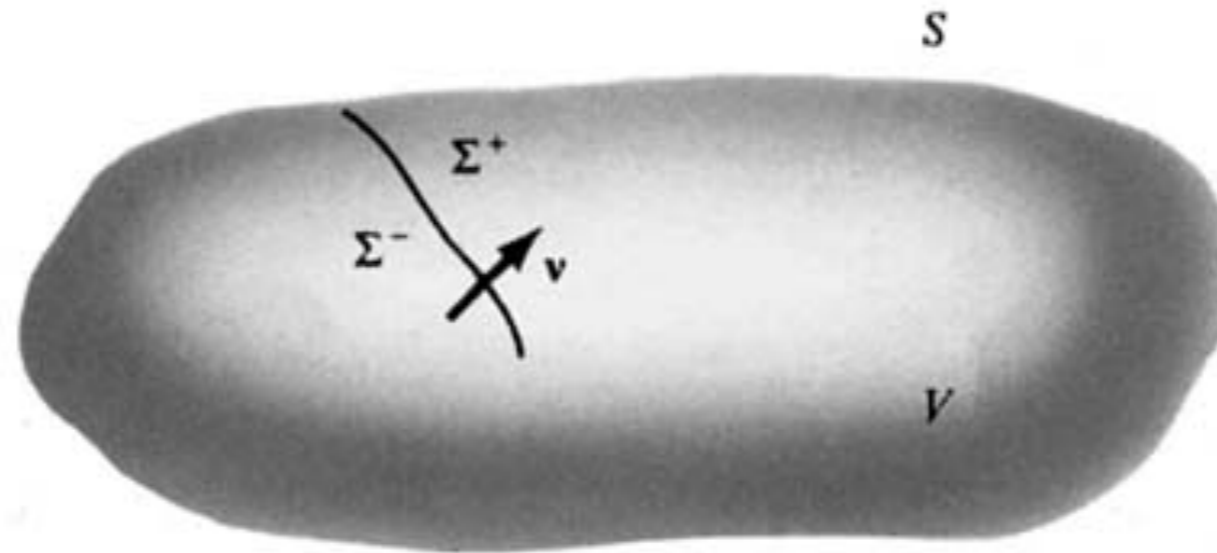
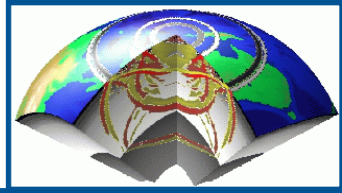
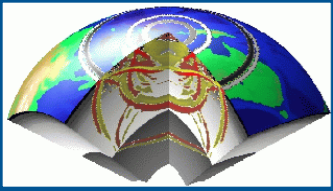

FIGURE 3.1

A finite elastic body, with volume V and external surface S , and an internal surface Σ (modeling a buried fault) across which discontinuities may arise. That is, displacements on the Σ^- side of Σ may differ from displacements on the Σ^+ side of Σ . The normal to Σ is ν (pointing from Σ^- to Σ^+), and the displacement discontinuity is denoted by $[\mathbf{u}(\xi, \tau)]$ for ξ on Σ , with square brackets referring to the difference $\mathbf{u}(\xi, \tau)|_{\Sigma^+} - \mathbf{u}(\xi, \tau)|_{\Sigma^-}$. In general, a similar difference may be formed for the tractions (due to external applied forces on Σ), but for spontaneous rupture the tractions must be continuous, and then $[\mathbf{T}(\mathbf{u}, \nu)] = \mathbf{0}$.

From Chapter 3 of Quantitative Seismology by Aki & Richards, (2002)
https://www.ldeo.columbia.edu/~richards/Aki_Richards.html



Representation theorem - 2nd

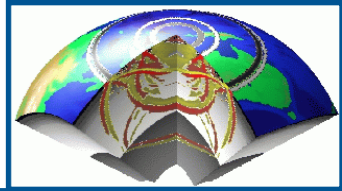

If slip occurs across Σ the displacement field is discontinuous there, but equations of motion are satisfied throughout the interior of the surface $S+\Sigma'+\Sigma''$. Assuming that u and G satisfy homogeneous conditions on S (that is no more of direct interest):

$$\begin{aligned} u_n(\mathbf{x}, t) = & \int_{-\infty}^{+\infty} d\tau \iiint_V f_p(\boldsymbol{\eta}, \tau) G_{np}(\mathbf{x}, t - \tau; \boldsymbol{\eta}, 0) dV(\boldsymbol{\eta}) + \\ & + \int_{-\infty}^{+\infty} d\tau \iint_{\Sigma} \left\{ -G_{np}(\mathbf{x}, t - \tau; \boldsymbol{\xi}, 0) \left[T_p(\mathbf{u}(\boldsymbol{\xi}, \tau), \mathbf{v}) \right] + \right. \\ & \left. + \left[u_i(\boldsymbol{\xi}, t) \right] c_{ijpq} v_j \partial G_{np}(\mathbf{x}, t - \tau; \boldsymbol{\xi}, 0) / \partial \xi_q \right\} d\Sigma(\boldsymbol{\xi}) \end{aligned}$$

Where square brackets are used for the difference between values on Σ^+ and Σ^- ; $\boldsymbol{\eta}$ is a general position within V and $\boldsymbol{\xi}$ a general position on Σ .

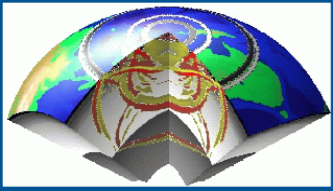

Representation theorem - 3rd

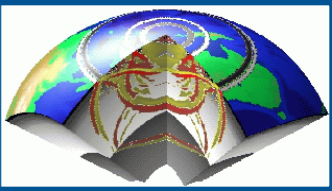

In the case of a **shear dislocation**, tractions across Σ are continuous and, neglecting body forces, one has that only the third right term remains; thus displacement on the fault determines the displacement everywhere. Using the delta function derivative one can write:

$$\frac{\partial G_{np}(\mathbf{x}, t - \tau; \xi, 0)}{\partial \xi_q} = - \iiint_V \frac{\partial}{\partial \eta_q} \delta(\eta - \xi) G_{np}(\mathbf{x}, t - \tau; \eta, 0) dV(\eta)$$

obtaining the **body-force equivalent** to a displacement discontinuity:

$$u_n(\mathbf{x}, t) = \int_{-\infty}^{+\infty} d\tau \iiint_V f_p^{[u]}(\eta, \tau) G_{np}(\mathbf{x}, t - \tau; \eta, 0) dV$$

$$f_p^{[u]}(\eta, \tau) = - \iint_{\Sigma} [u_i(\xi, \tau)] c_{ijpq} v_j \frac{\partial \delta(\eta - \xi)}{\partial \eta_q} d\Sigma$$

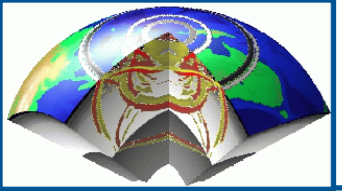

Representation theorem

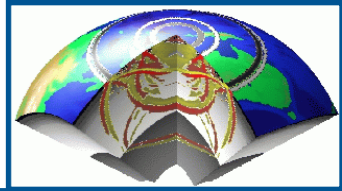

$$u_n(\mathbf{x}, t) = \iiint_V \mathbf{f}_p * \mathbf{G}_{np} dV + \iint_{\Sigma} \left(-\left[\mathbf{T}_p \right] * \mathbf{G}_{np} + \left[\mathbf{u}_i \right] c_{ijpq} v_j * \mathbf{G}_{np,q} \right) d\Sigma$$

the displacement field at a point of the volume V with surface S is given by:

- a volume integral over the body forces \mathbf{f} convolved with the **EGF**;
- a surface integral over the **discontinuity** of tractions \mathbf{T} across a surface convolved with the **EGF**;
- a surface integral over a quantity, depending on the **discontinuity of displacements**, convolved with the spatial derivative of the **EGF**.

Neglecting the physical body forces (e.g. gravity), and considering a pure shear dislocation, the remaining term can be represented as the result of an **equivalent body force**:

$$u_n(\mathbf{x}, t) = \iiint_V \mathbf{f}_p^{[u]} * \mathbf{G}_{np} dV$$

$$\mathbf{f}_p^{[u]} = - \iint_{\Sigma} \left[\mathbf{u}_i \right] c_{ijpq} v_j \frac{\partial \delta}{\partial \eta_q} d\Sigma$$

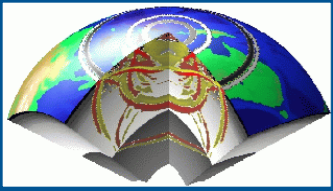

Moment density tensor

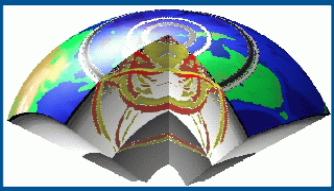

Using the **convolution** symbol, the representation theorem for a shear dislocation becomes:

$$u_n(\mathbf{x}, t) = \iint_{\Sigma} [u_i] c_{ijpq} v_j * \frac{\partial G_{np}}{\partial \xi_q} d\Sigma$$

Where the derivative can be thought as the equivalent of having a single couple (for example (p,q) , with arm in the ξ_q direction) on Σ at ξ with strength $[u_i]c_{ijpq}v_j$; the integral represents the effect of a sum of couples distributed over Σ . For 3 components of force and 3 possible arm directions there are 9 generalized couples.

Defining the **moment density tensor**, one has:

$$m_{pq} = [u_i] c_{ijpq} v_j \quad u_n(\mathbf{x}, t) = \iint_{\Sigma} m_{pq} * \frac{\partial G_{np}}{\partial \xi_q} d\Sigma$$

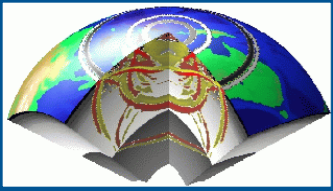

Moment tensor

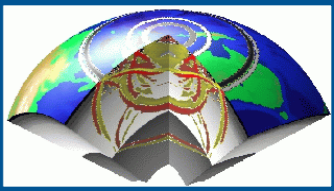

For an isotropic solid, and for **slip parallel** to Σ at ξ , one has respectively:

$$m_{pq} = \lambda v_k [u_k] \delta_{pq} + \mu \left(v_p [u_q] + v_q [u_p] \right) \quad m_{pq} = \mu \left(v_p [u_q] + v_q [u_p] \right)$$

And if the source can be considered a point-source (for wavelengths greater than fault dimensions), the contributions from different surface elements can be considered in phase. Thus for an effective **point source**, one can define the **moment tensor**:

$$M_{pq} = \iint_{\Sigma} m_{pq} d\Sigma$$
$$u_n(\mathbf{x}, t) = M_{pq} * G_{np,q}$$

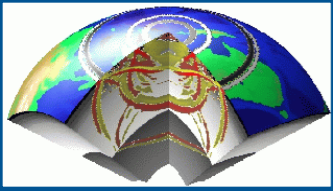

Moment tensor decomposition

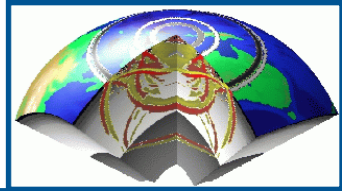

The moment tensor is symmetric (thus the roles of \mathbf{u} and \mathbf{v} can be interchanged without affecting the displacement field, leading to the **fault plane-auxiliary plane ambiguity**), and it can be diagonalized and decomposed in an isotropic and deviatoric part:

$$M_{pq} = \begin{pmatrix} M_1 & 0 & 0 \\ 0 & M_2 & 0 \\ 0 & 0 & M_3 \end{pmatrix} = \frac{1}{3} \begin{pmatrix} \text{tr}(M) & 0 & 0 \\ 0 & \text{tr}(M) & 0 \\ 0 & 0 & \text{tr}(M) \end{pmatrix} + \begin{pmatrix} M'_1 & 0 & 0 \\ 0 & M'_2 & 0 \\ 0 & 0 & M'_3 \end{pmatrix}$$

For a shear dislocation, the equivalent point force is a **double-couple**, since internal faulting implies that the total force $\mathbf{f}^{[u]}$ and its total moment are null. The seismic moment has a **null trace** and **one of the eigenvalues is 0**.

$$M_{pq}(\text{doublecouple}) = \begin{pmatrix} M_0 & 0 & 0 \\ 0 & 0 & 0 \\ 0 & 0 & -M_0 \end{pmatrix} \quad \text{with } M_0 = \mu A[\bar{u}]$$

M_0 is called **seismic moment**, a scalar quantity related to the area of the fault and to the slip, averaged over the fault plane.

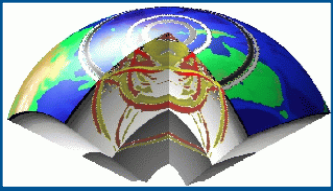

Moment tensor components

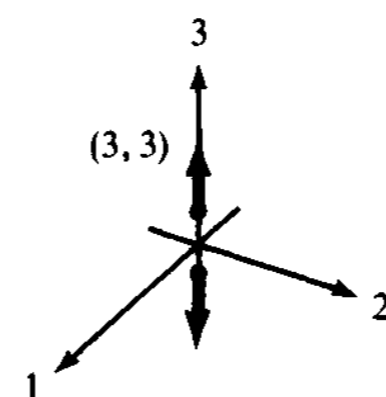
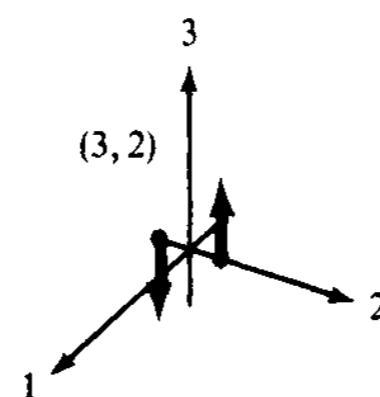
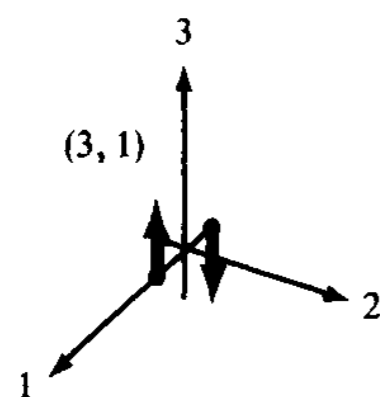
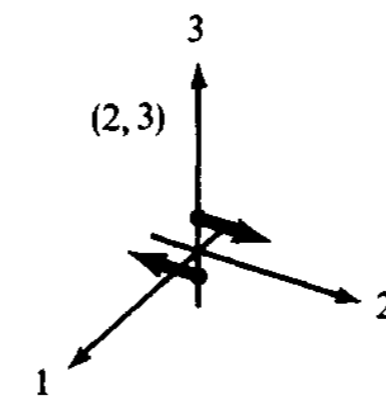
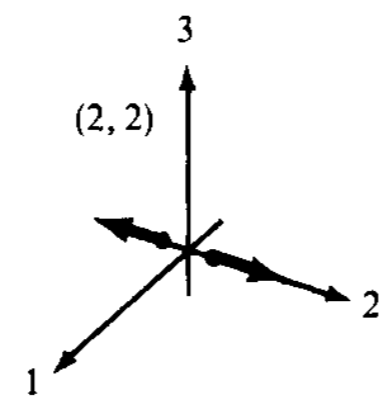
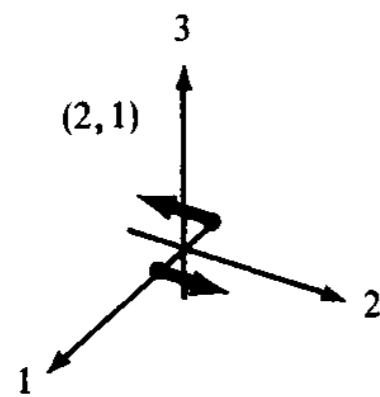
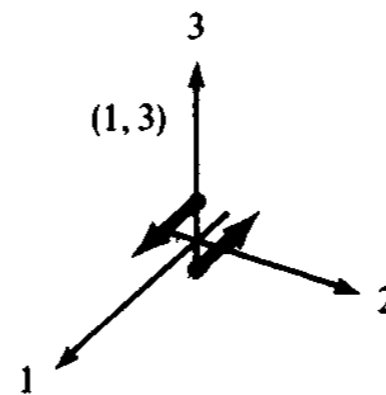
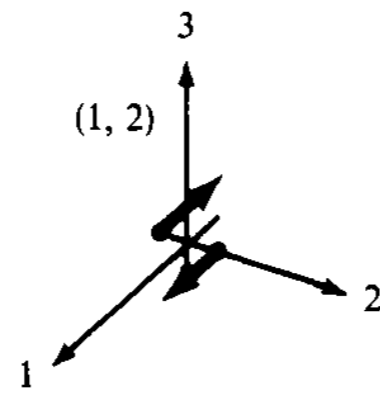
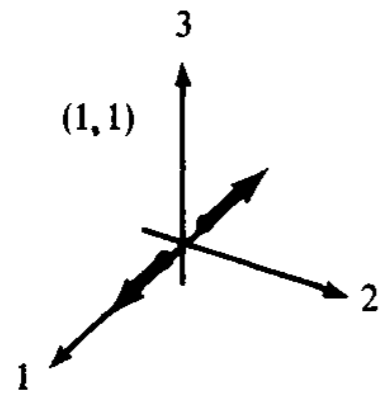
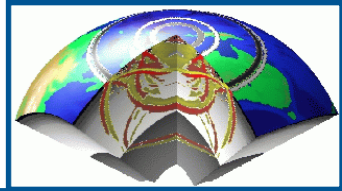

Point sources can be described by the seismic moment tensor M_{pq} , whose elements have clear physical meaning of **forces acting on particular planes.**

The nine possible couples that are required to obtain equivalent forces for a generally oriented displacement discontinuity in anisotropic media.

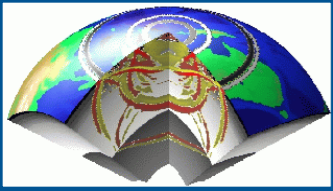

Moment tensor and fault vectors

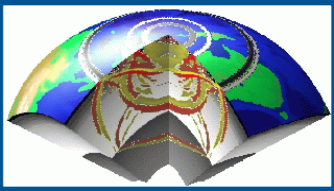

The orthogonal eigenvectors to the above eigenvalues give the directions of the principal axes: \mathbf{b} , corresponding to eigenvalue 0, gives the **null-axis**, \mathbf{t} , corresponding to the positive eigenvalue, gives the **tension axis** (T) and \mathbf{p} gives the **pressure axis** (P) of the tensor.

They are related to the \mathbf{u} and \mathbf{v} vector, defining respectively the slip vector and the fault plane:

$$\left\{ \begin{array}{l} \mathbf{t} = \frac{1}{\sqrt{2}} (\mathbf{v} + \mathbf{u}) \\ \mathbf{b} = (\mathbf{v} \times \mathbf{u}) \\ \mathbf{p} = \frac{1}{\sqrt{2}} (\mathbf{v} - \mathbf{u}) \end{array} \right. \quad \left\{ \begin{array}{l} \mathbf{u} = \frac{1}{\sqrt{2}} (\mathbf{t} + \mathbf{p}); \frac{1}{\sqrt{2}} (\mathbf{t} - \mathbf{p}) \\ \mathbf{v} = \frac{1}{\sqrt{2}} (\mathbf{t} - \mathbf{p}); \frac{1}{\sqrt{2}} (\mathbf{t} + \mathbf{p}) \end{array} \right.$$

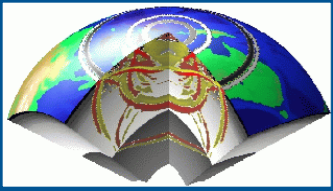

Moment tensor and fault plane solution

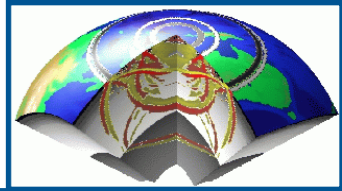

$$\mathbf{u} = \begin{cases} [\bar{u}] (\cos \lambda \cos \phi + \cos \delta \sin \lambda \sin \phi) \hat{\mathbf{e}}_x \\ [\bar{u}] (\cos \lambda \sin \phi - \cos \delta \sin \lambda \cos \phi) \hat{\mathbf{e}}_y \\ [\bar{u}] (-\sin \delta \sin \lambda) \hat{\mathbf{e}}_z \end{cases} \quad \mathbf{v} = \begin{cases} (-\sin \delta \sin \phi) \hat{\mathbf{e}}_x \\ (-\sin \delta \cos \phi) \hat{\mathbf{e}}_y \\ (-\cos \delta) \hat{\mathbf{e}}_z \end{cases}$$

Figure 4.2-2: Fault geometry used in earthquake studies.

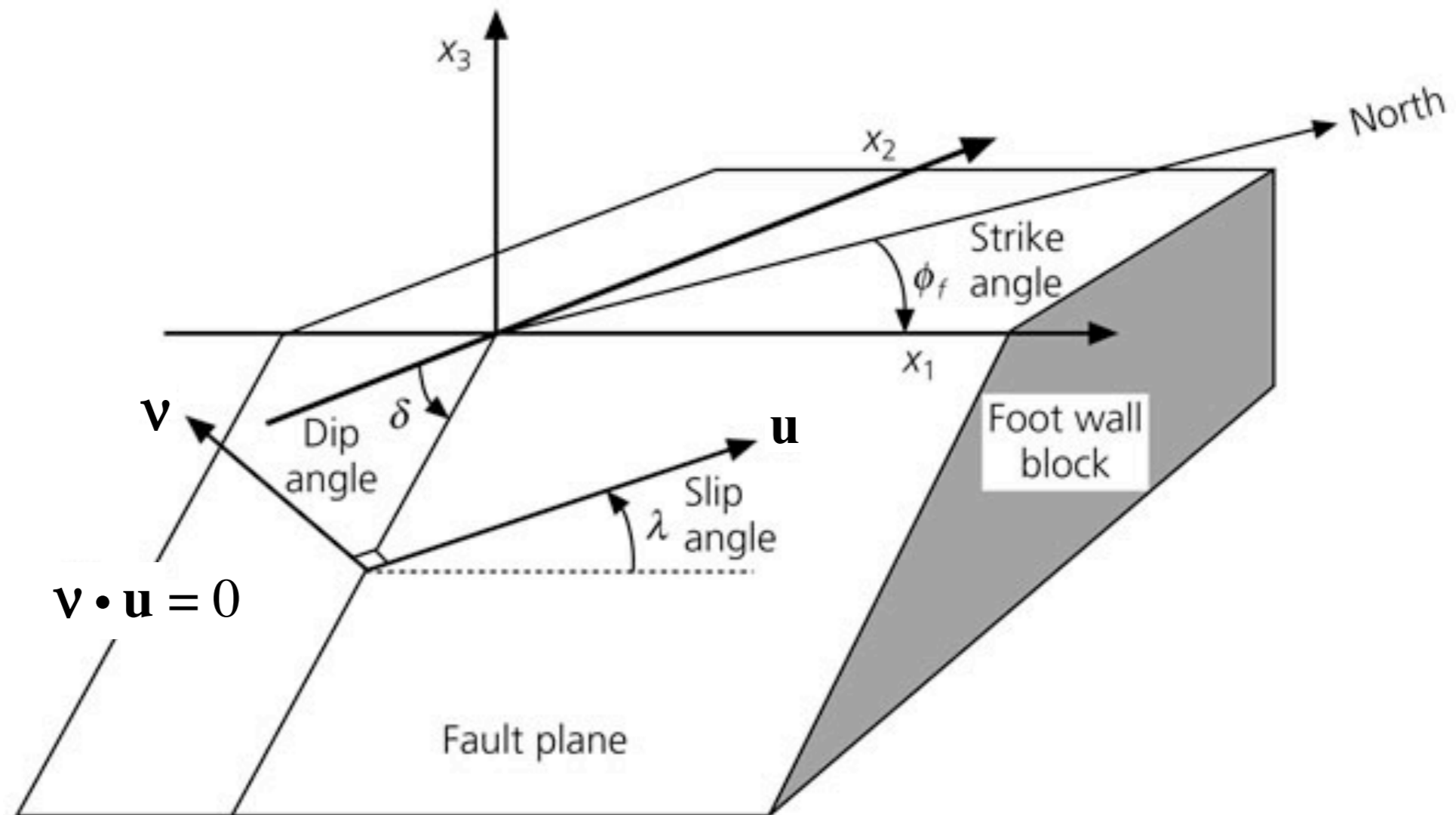

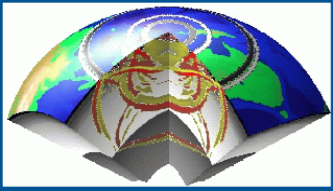

Moment tensor and fault plane solution

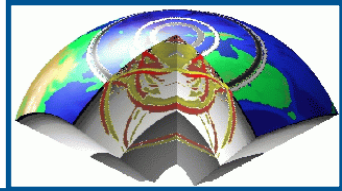

The slip vector and the fault normal can be expressed in terms of strike (ϕ), dip (δ) and rake (λ):

$$\mathbf{u} = \begin{cases} [\bar{u}] (\cos \lambda \cos \phi + \cos \delta \sin \lambda \sin \phi) \hat{\mathbf{e}}_x \\ [\bar{u}] (\cos \lambda \sin \phi - \cos \delta \sin \lambda \cos \phi) \hat{\mathbf{e}}_y \\ [\bar{u}] (-\sin \delta \sin \lambda) \hat{\mathbf{e}}_z \end{cases} \quad \mathbf{v} = \begin{cases} (-\sin \delta \sin \phi) \hat{\mathbf{e}}_x \\ (-\sin \delta \cos \phi) \hat{\mathbf{e}}_y \\ (-\cos \delta) \hat{\mathbf{e}}_z \end{cases}$$

Then the Cartesian components of the symmetric moment tensor can be written as:

$$\begin{aligned} M_{xx} &= -M_o (\sin \delta \cos \lambda \sin 2\phi + \sin 2\delta \sin \lambda \sin^2 \phi) & M_{xy} &= M_o (\sin \delta \cos \lambda \sin 2\phi + 0.5 \sin 2\delta \sin \lambda \sin 2\phi) \\ M_{yy} &= M_o (\sin \delta \cos \lambda \sin 2\phi - \sin 2\delta \sin \lambda \cos^2 \phi) & M_{xz} &= -M_o (\cos \delta \cos \lambda \cos \phi + \cos 2\delta \sin \lambda \sin \phi) \\ M_{zz} &= M_o (\sin 2\delta \sin \lambda) & M_{yz} &= -M_o (\cos \delta \cos \lambda \sin \phi - \cos 2\delta \sin \lambda \cos \phi) \end{aligned}$$

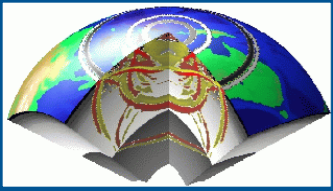

Angle and axis conventions

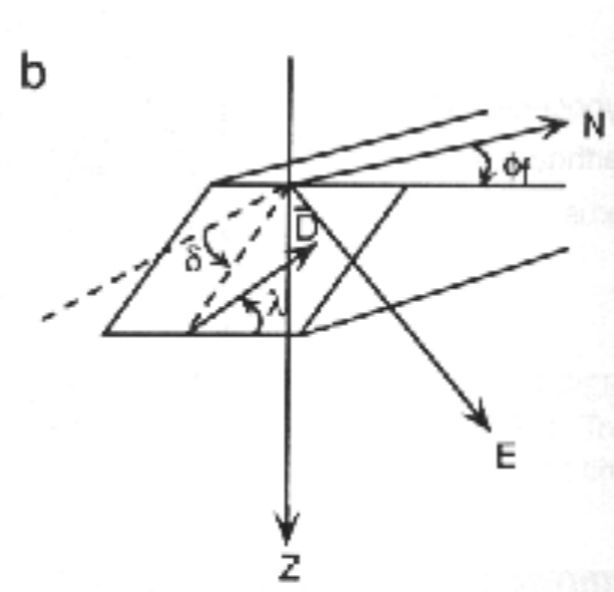
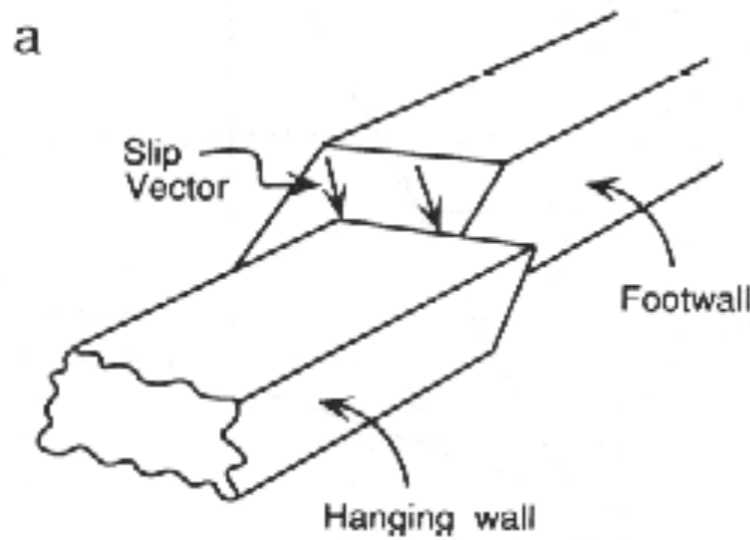
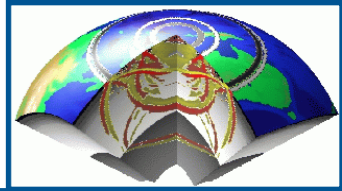

Convention for naming blocks, fault plane, and slip vector, i.e. strike, dip and rake

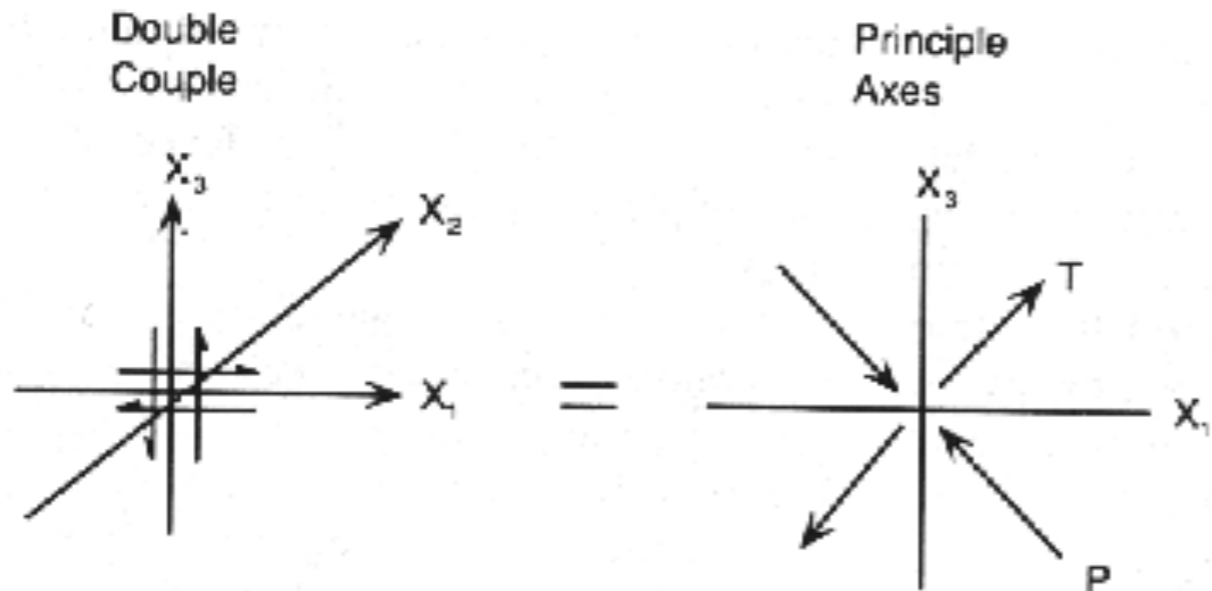

Force system or a double couple in the xz-plane

T and P axes are the directions of maximum positive or negative first break.

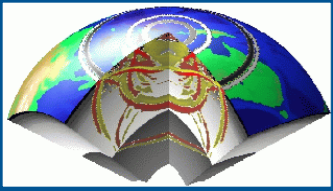

Moment tensor components

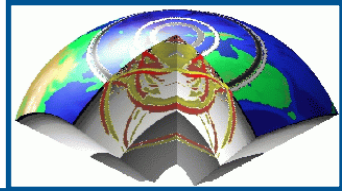
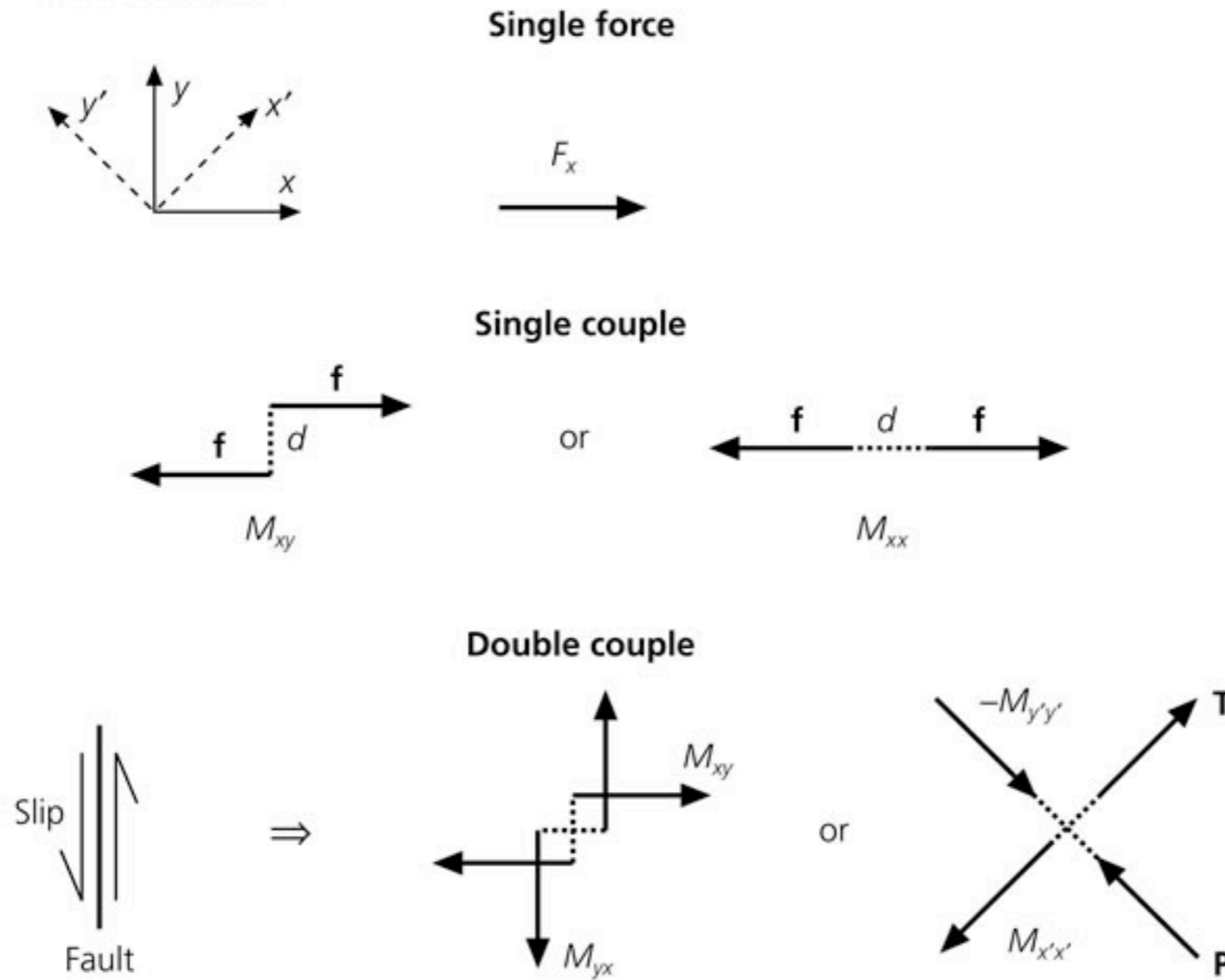
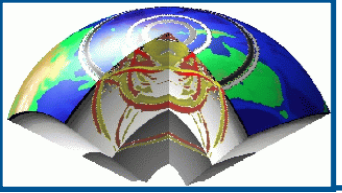

Figure 4.4-1: Equivalent body forces for a single force, single couple, and double couple.



Point sources can be described by the seismic moment tensor M_{pq} , whose elements have clear physical meaning of **forces acting on particular planes.**



A particular case

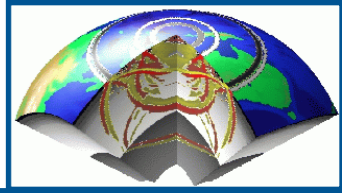

The fault Σ lies in the plane $\zeta_3=0$, and then $v_3=1$, $v_1=v_2=0$; for a pure shear dislocation mechanism in the ζ_1 direction, one has: $[u_2]=[u_3]=0$.

The body force equivalent in general is:

$$f_p^{[u]}(\eta, \tau) = - \iint_{\Sigma} [u_i(\xi, \tau)] c_{ijpq} v_j \frac{\partial \delta(\eta - \xi)}{\partial \eta_q} d\Sigma$$

and becomes:

$$f_p^{[u]}(\eta, \tau) = - \iint_{\Sigma} [u_1(\xi, \tau)] c_{13pq} \frac{\partial \delta(\eta - \xi)}{\partial \eta_q} d\xi_1 d\xi_2$$

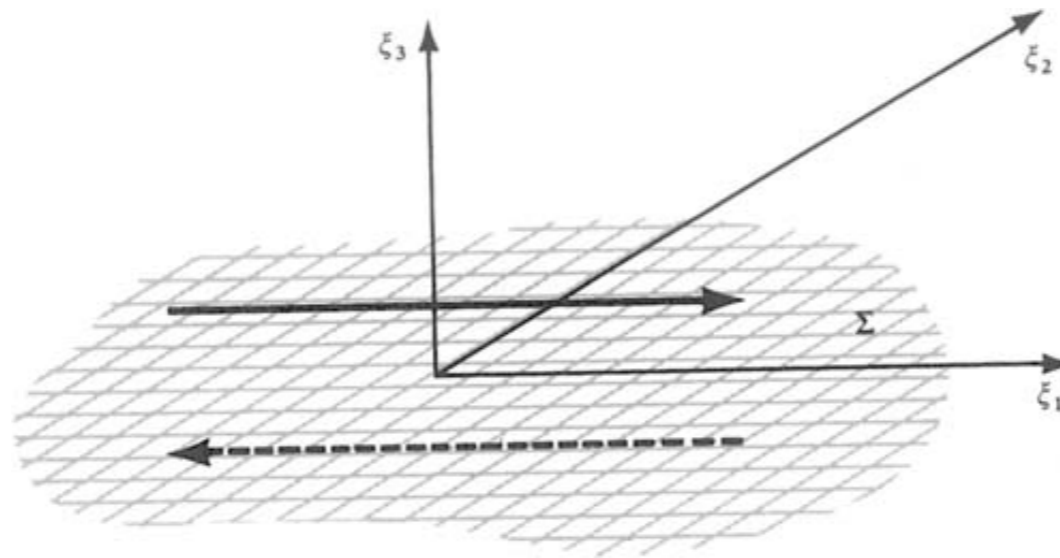
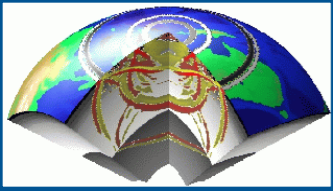
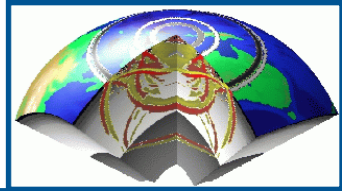

FIGURE 3.2

A fault surface Σ within an isotropic medium is shown lying in the $\xi_3 = 0$ plane. Slip is presumed to take place in the ξ_1 -direction across Σ , as shown by the heavy arrows. Motion on the side Σ^+ (i.e., $\xi_3 = 0^+$) is along the direction of ξ_1 increasing, and on the side Σ^- is along ξ_1 decreasing.



A particular case: body force equivalent



In isotropic media, the constitutive relation establishes that all c_{13pq} vanish except $c_{1313}=c_{1331}=\mu$

$$f_1^{[u]}(\eta, \tau) = -\iint_{\Sigma} [u_1(\xi, \tau)] \mu \delta(\eta_1 - \xi_1) \delta(\eta_2 - \xi_2) \frac{\partial \delta(\eta_3)}{\partial \eta_3} d\xi_1 d\xi_2$$

$$f_2^{[u]}(\eta, \tau) = 0$$

$$f_3^{[u]}(\eta, \tau) = -\iint_{\Sigma} [u_1(\xi, \tau)] \mu \frac{\partial \delta(\eta_1 - \xi_1)}{\partial \eta_1} \delta(\eta_2 - \xi_2) \delta(\eta_3) d\xi_1 d\xi_2$$

and after integration:

$$f_1^{[u]}(\eta, \tau) = -[u_1(\eta, \tau)] \mu \frac{\partial \delta(\eta_3)}{\partial \eta_3}$$

$$f_2^{[u]}(\eta, \tau) = 0$$

$$f_3^{[u]}(\eta, \tau) = -\frac{\partial [u_1(\eta, \tau)]}{\partial \eta_1} \mu \delta(\eta_3)$$

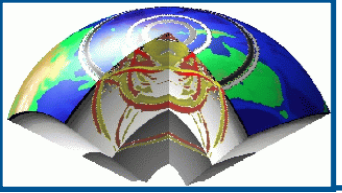

A particular case - 1st bf

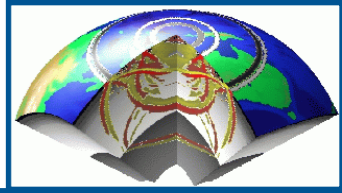

The first one represents a system of single couples distributed over the fault plane: forces in the $\pm\eta_1$ direction, arm along η_3 direction and moment along η_2 direction:

$$f_1^{[u]}(\eta, \tau) = -\iint_{\Sigma} [u_1(\xi, \tau)] \mu \delta(\eta_1 - \xi_1) \delta(\eta_2 - \xi_2) \frac{\partial \delta(\eta_3)}{\partial \eta_3} d\xi_1 d\xi_2$$

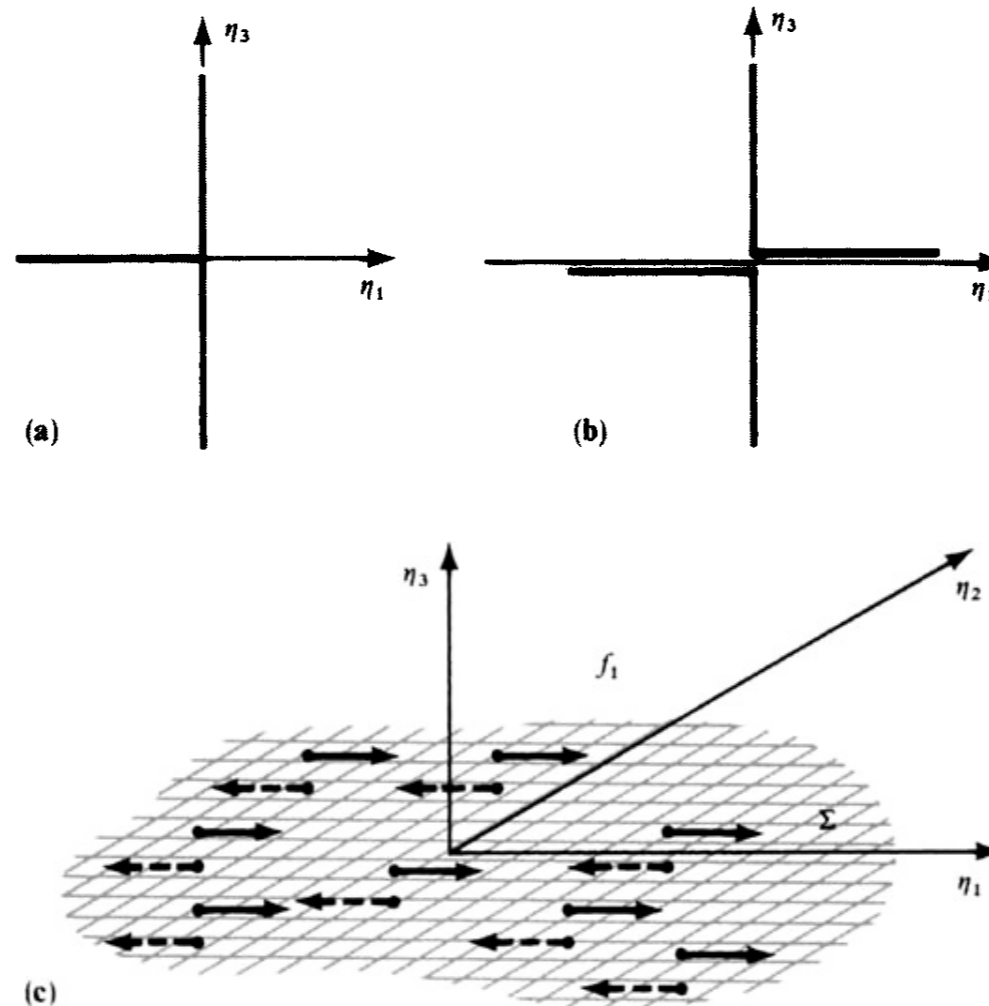
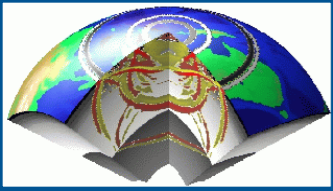
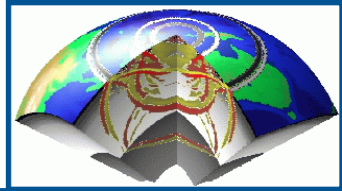

FIGURE 3.3

Interpretive diagrams for the first component, f_1 , of the body-force equivalent to fault slip of the type shown in Figure 3.2. (a) The spike $(-\delta(\eta_3), 0, 0)$ is plotted against η_3 . (That is, a spike in the $-\eta_1$ -direction, acting at $\eta_3 = 0$.) (b) The derivative $((-\partial/\partial\eta_3)\delta(\eta_3), 0, 0)$ is plotted against η_3 . The body force $(f_1, 0, 0)$ is proportional to this quantity (see equation (3.11)). (c) Heavy arrows show the distribution of f_1 over the Σ^+ side of Σ and over the Σ^- side (broken arrows). This is the body-force component that would intuitively be expected in any body-force model of the motions shown in Figure 3.2.



A particular case - 1st bf moment



Since faulting, within V , is an internal process, the total force due to any $\mathbf{f}^{[u]}$ and the total moment about any fixed point must be 0:

$$\iiint_V \mathbf{f}^{[u]}(\boldsymbol{\eta}, \tau) dV(\boldsymbol{\eta}) \propto \iint_S \delta(\boldsymbol{\eta} - \boldsymbol{\xi}) dS(\boldsymbol{\eta}) = 0$$

The total moment of this force component alone does not vanish, actually the moment about the η_2 axis is:

$$\iiint_V \eta_3 f_1 dV = - \iiint_V \eta_3 \mu[u_1] \frac{\partial \delta(\eta_3)}{\partial \eta_3} d\eta_1 d\eta_2 d\eta_3 = \iint_{\Sigma} \mu[u_1] d\Sigma$$

that averaged over the fault plane gives

$$\mu \langle u \rangle A$$

along the direction of η_2 increasing

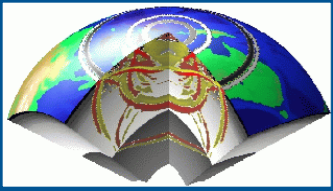

A particular case - 2nd bf moment

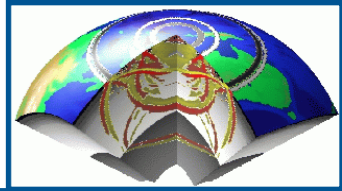

$$f_3^{[u]}(\eta, \tau) = -\iint_{\Sigma} [u_1(\xi, \tau)] \mu \frac{\partial \delta(\eta_1 - \xi_1)}{\partial \eta_1} \delta(\eta_2 - \xi_2) \delta(\eta_3) d\xi_1 d\xi_2$$

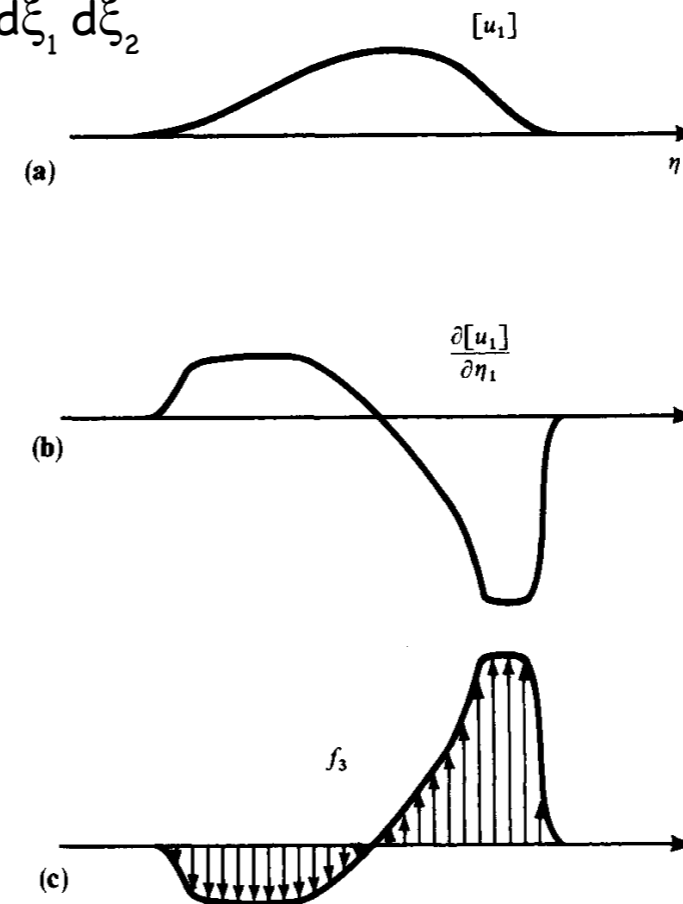
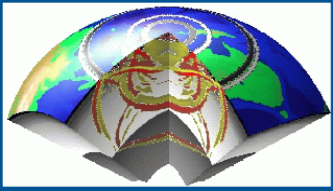

FIGURE 3.4
Interpretive diagrams for the third component, f_3 , of the body-force equivalent to fault slip $[u_1]$. (a) An assumed variation of slip $[u_1]$ with η_1 , at fixed η_2 and τ . (b) The corresponding derivative $\partial [u_1] / \partial \eta_1$. (c) The distribution of single forces f_3 with varying η_1 (see equation (3.12)). This distribution will clearly yield a net couple, with moment in the $-\eta_2$ -direction.

The total moment of this force component about the η_2 axis is:

$$\iiint_V \eta_1 \frac{\partial \mu [u_1]}{\partial \eta_1} \delta(\eta_3) d\eta_1 d\eta_2 d\eta_3 = -\iint_{\Sigma} \mu [u_1] d\Sigma$$

that averaged over the fault plane gives again $\mu \langle u \rangle A$ along the direction of η_2 decreasing. Thus the total moment is null!



A particular case - double couple

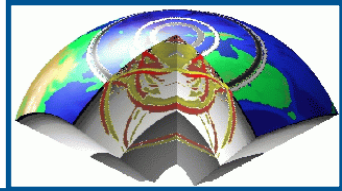

The force equivalents to a given fault slip are not unique:

$$u_n(\mathbf{x}, t) = \iint_{\Sigma} [u_i] c_{ijpq} v_j * \frac{\partial G_{np}}{\partial \xi_q} d\Sigma = \iint_{\Sigma} \mu [u_1] * \left(\frac{\partial G_{n1}}{\partial \xi_3} + \frac{\partial G_{n3}}{\partial \xi_1} \right) d\Sigma$$

$$\frac{\partial G_{n1}}{\partial \xi_3} = \frac{G_{n1}(\mathbf{x}, t - \tau, \xi + \varepsilon \xi_3, 0) - G_{n1}(\mathbf{x}, t - \tau, \xi - \varepsilon \xi_3, 0)}{2\varepsilon}, \varepsilon \rightarrow 0$$

$$\frac{\partial G_{n3}}{\partial \xi_1} = \frac{G_{n3}(\mathbf{x}, t - \tau, \xi + \varepsilon \xi_1, 0) - G_{n3}(\mathbf{x}, t - \tau, \xi - \varepsilon \xi_1, 0)}{2\varepsilon}, \varepsilon \rightarrow 0$$

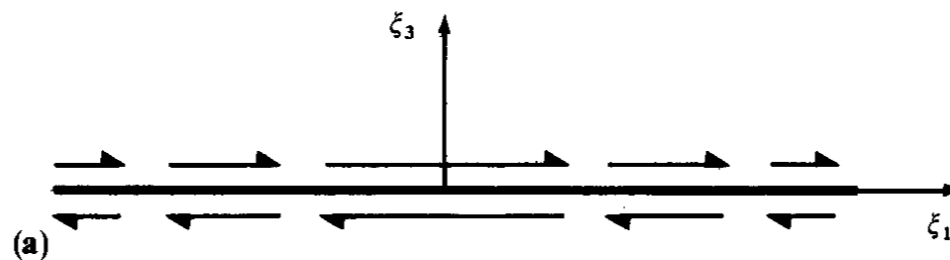
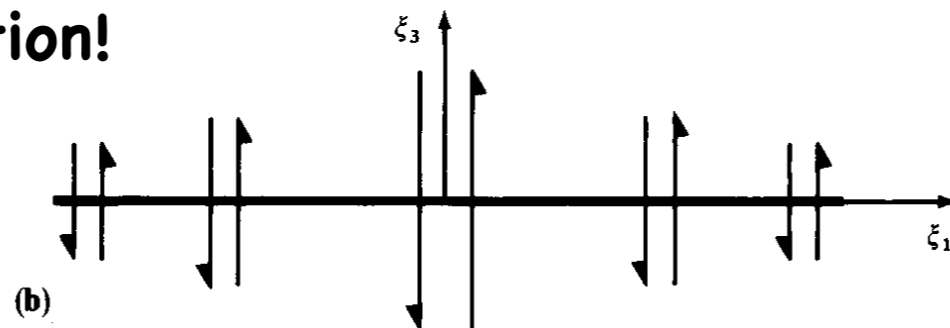
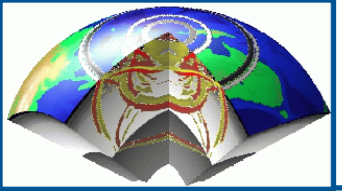

FIGURE 3.5

The radiation from these two distributions is the same as the radiation from slip on a fault. In this sense, these two single-couple distributions, taken together, are equivalent to fault slip. Note that there is no net couple, and no net force, acting on any element of area in the fault plane ($\xi_3 = 0$).

Double couple distribution!





A particular case - other system

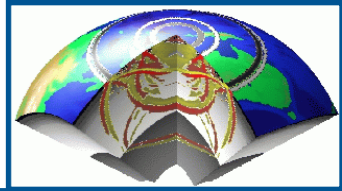

The force equivalents to a given fault slip are not unique:

$$u_n(\mathbf{x}, t) = \iint_{\Sigma} [u_i] c_{ijpq} v_j * \frac{\partial G_{np}}{\partial \xi_q} d\Sigma = \iint_{\Sigma} \mu \left([u_1] * \frac{\partial G_{n1}}{\partial \xi_3} + \frac{\partial [u_1]}{\partial \xi_1} G_{n3} \right) d\Sigma$$

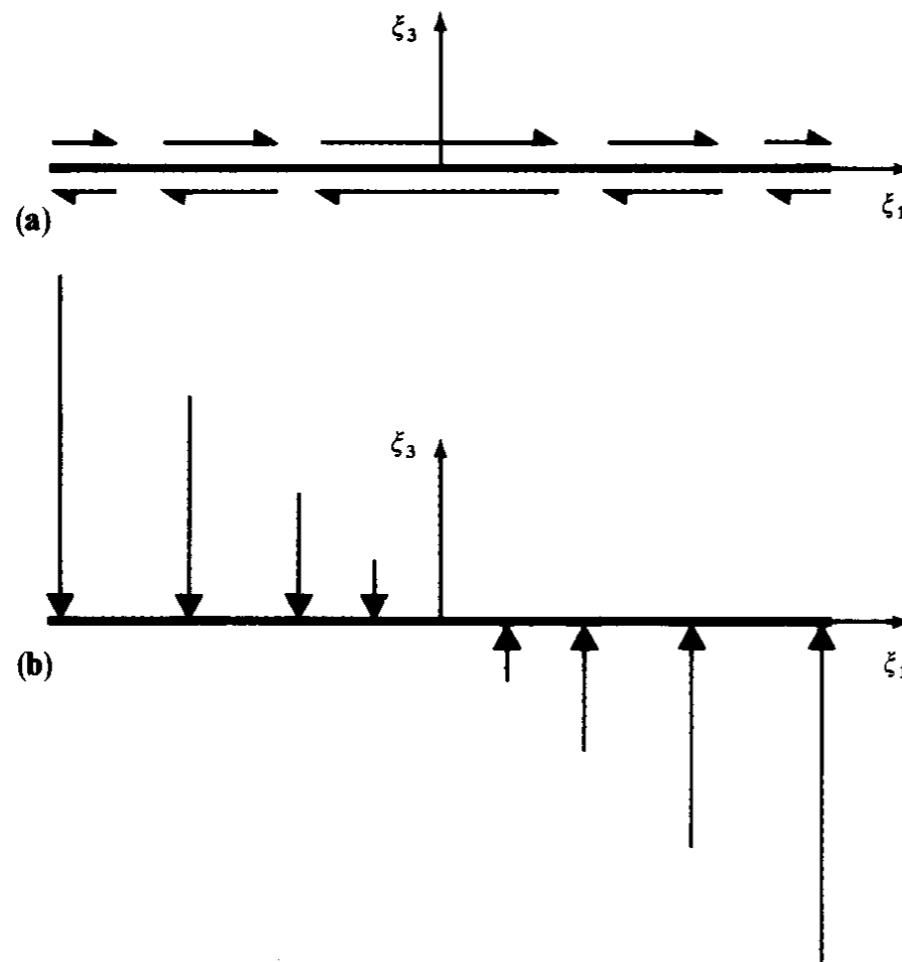
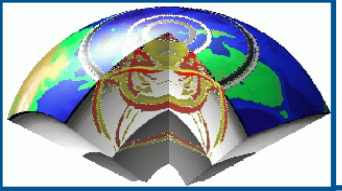

FIGURE 3.6

Another force system that is equivalent to fault slip (compare with Fig. 3.5). (a) and (b) here constitute a single-couple plus single-force system, which has zero total couple and zero total force for the whole fault surface. But individual elements of area are acted on by a couple and a force.

The body force equivalent is unique, but force/(unit area) on a finite fault is not: the dynamic process cannot be studied with the radiation by individual elements!



A particular case - Far Source

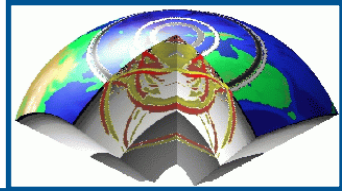

If we are in the **FAR SOURCE** condition (at distances greater than the fault dimension), and for periods longer than the slip duration:

$$f_1^{[u]}(\eta, \tau) = -\left[u_1(\eta, \tau)\right] \mu(\eta) \frac{\partial \delta(\eta_3)}{\partial \eta_3} = -M_0 \delta(\eta_1) \delta(\eta_2) \frac{\partial \delta(\eta_3)}{\partial \eta_3} H(\tau)$$

$$f_2^{[u]}(\eta, \tau) = 0$$

$$f_3^{[u]}(\eta, \tau) = -\frac{\partial \left[u_1(\eta, \tau)\right] \mu(\eta)}{\partial \eta_1} \delta(\eta_3) = -M_0 \frac{\partial \delta(\eta_1)}{\partial \eta_1} \delta(\eta_2) \delta(\eta_3) H(\tau)$$

obtaining the **double-couple point source** equivalent to fault slip!

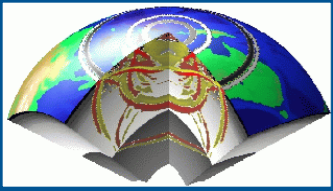

A particular case - moment tensor

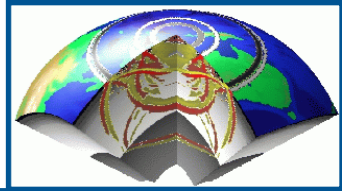

$$\mathbf{m} = \begin{pmatrix} 0 & 0 & \mu[u_1(\xi, \tau)] \\ 0 & 0 & 0 \\ \mu[u_1(\xi, \tau)] & 0 & 0 \end{pmatrix}$$

$$\mathbf{M} = \begin{pmatrix} 0 & 0 & M_0 \\ 0 & 0 & 0 \\ M_0 & 0 & 0 \end{pmatrix}$$

$$\phi=0^\circ, \delta=0^\circ, \lambda=0^\circ$$

$$\mathbf{u} = \begin{cases} [\bar{u}]\hat{\mathbf{e}}_x \\ 0 \\ 0 \end{cases}$$

$$\mathbf{v} = \begin{cases} 0 \\ 0 \\ \hat{\mathbf{e}}_z \end{cases}$$

$$\mathbf{t} = \frac{1}{\sqrt{2}} (\hat{\mathbf{e}}_z + [\bar{u}]\hat{\mathbf{e}}_x)$$

$$\mathbf{b} = (\hat{\mathbf{e}}_z \times [\bar{u}]\hat{\mathbf{e}}_x) = [\bar{u}]\hat{\mathbf{e}}_y$$

$$\mathbf{p} = \frac{1}{\sqrt{2}} (\hat{\mathbf{e}}_z - [\bar{u}]\hat{\mathbf{e}}_x)$$

Double Couple

Principle Axes

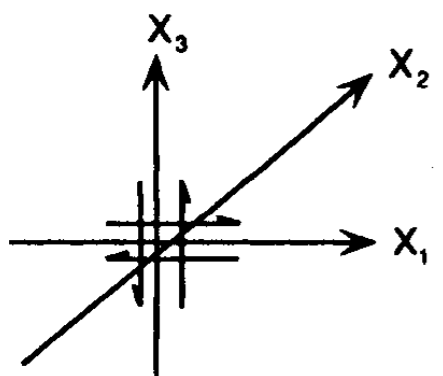

=

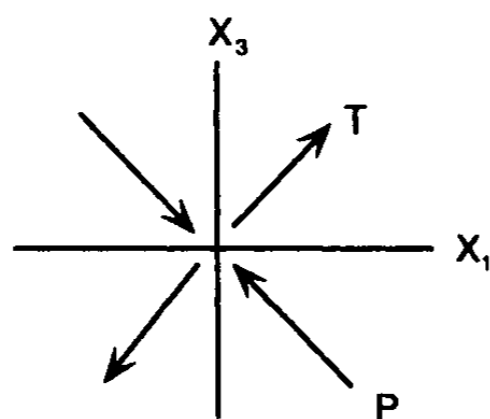

referred to principal axes

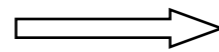

$$\mathbf{M} = \begin{pmatrix} M_0 & 0 & 0 \\ 0 & 0 & 0 \\ 0 & 0 & -M_0 \end{pmatrix}$$