

SEISMOLOGY

Master Degree Programme in Physics - UNITS
Physics of the Earth and of the Environment

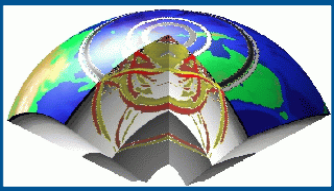
SEISMOMETRY

FABIO ROMANELLI

Department of Mathematics & Geosciences

University of Trieste

romanel@units.it



Principles of seismometers:

- inertial pendulum
- astatic pendulum

Classical instruments:

- mechanical
- electromagnetic
- response curves

Digital and broad-band instruments

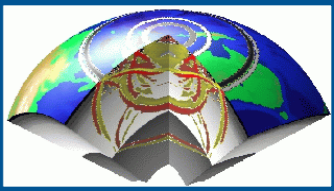
- dynamic range
- force-balance
- frequency range

Seismic noise

World-wide networks



Seismoscope



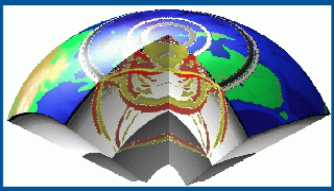
Chang Heng's quaint device can technically be called a **seismoscope**, an instrument that primarily measures the direction of ground motion, without necessarily noting time or amplitude.

The first known example of a seismic instrument was created by Chang Heng in China during the 2nd Century A.D. It consisted of an urn-like vessel containing a vertical pendulum of some sort, ringed with eight dragons, each holding a metal ball securely in its mouth. Below each dragon, with its mouth open and facing upward, was a metal frog.

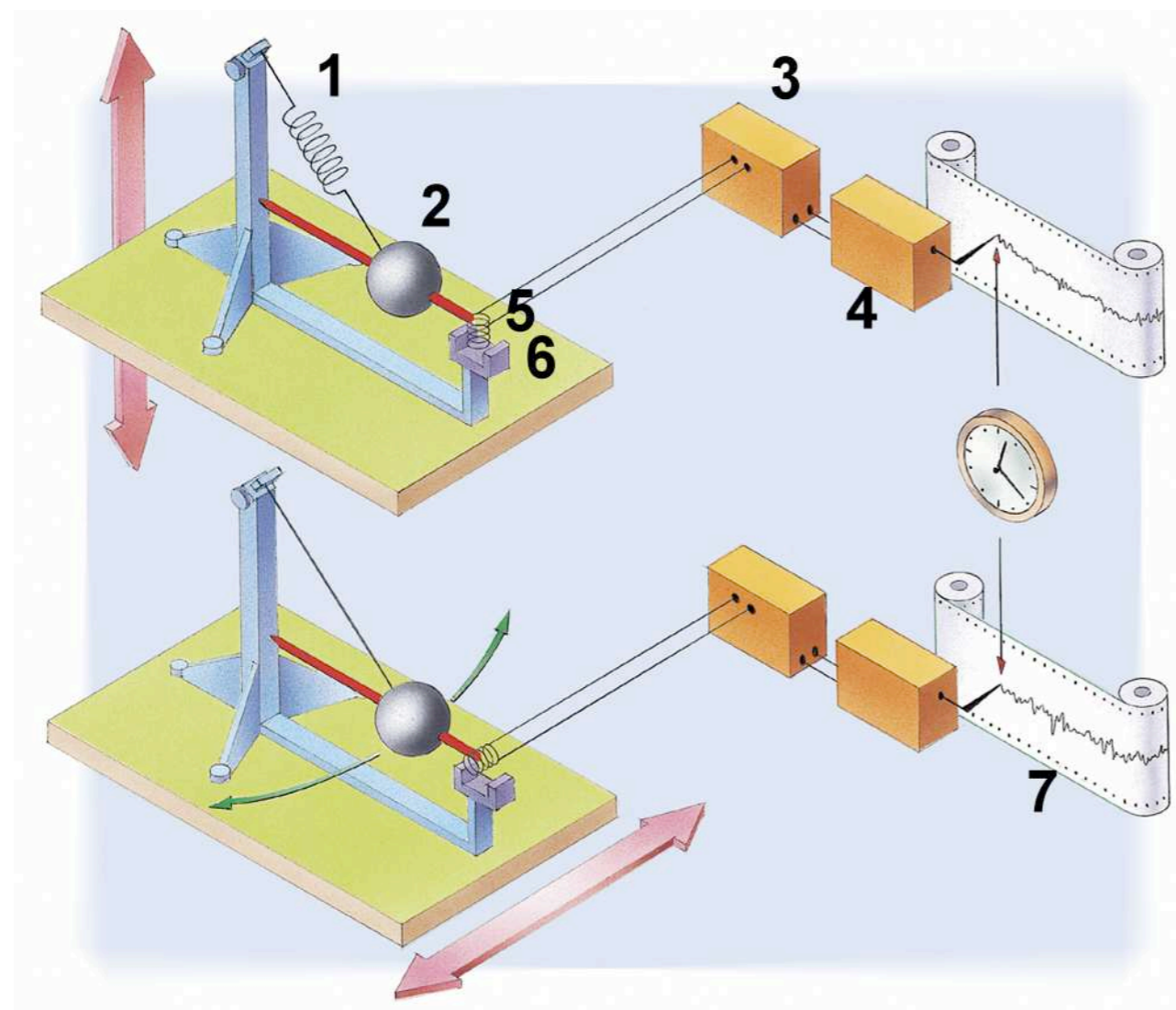
When the instrument was shaken by an earthquake, the pendulum inside triggered one of the dragon's mouths to open, dropping its ball into the frog below, which created an easily audible noise. Chang Heng discovered that the earthquake generally was located in the direction exactly opposite that of the first dropped ball. Using this knowledge, he was able to advise Chinese leaders where to send aid. His instrument reportedly was sensitive enough to detect earthquakes that people in the same room would have failed to notice, were it not for the loud drop of a metal ball.



Seismographs



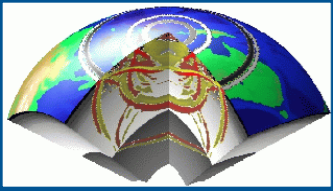
Seismographs generally consist of two parts: a sensor of ground motion, which we call a **seismometer**, and a **seismic recording system**.



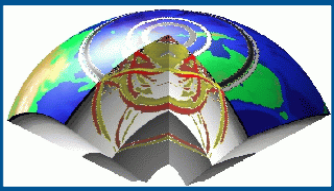
The first seismographs were built in the late 19th Century. They were a mechanical synthesis of sorts - a seismometer rigged up to transfer its motions to some kind of timekeeping and recording device.

Records, which became known as seismograms, were made continuously, by a pen tracing ink lines on paper, or a stylus etching smoked paper, with time "ticks" marked periodically to provide temporal reference points.

Inertial pendulum for **vertical** and **horizontal** motion. Relative motion of the pendulum will be recorded.



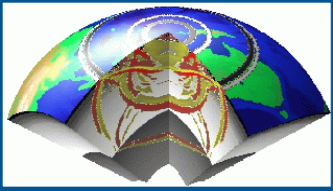
Inertia & strain



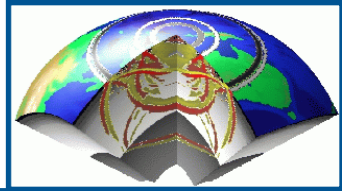
There are two basic types of seismic sensors: **inertial** seismometers which measure ground motion relative to an inertial reference (a suspended mass), and **strainmeters** or extensometers which measure the motion of one point of the ground relative to another.

The wavelength of seismic waves is so large that the differential motion of the ground within a vault is normally much smaller than the motion relative to an inertial reference; strainmeters are therefore generally less sensitive to earthquake signals. However, at very low frequencies it becomes increasingly difficult to maintain an inertial reference, and for the observation of low-order free oscillations of the earth and tidal signals, strainmeters may outperform inertial seismometers.

In contrast to most other sensors, **inertial seismometers** have an inherently **frequency-dependent response** (**transfer function of a forced pendulum**) that must be taken into account when the ground motion is restored from the recorded signal. This is because a suspended mass does not represent a perfect inertial reference. When the ground motion is slow, the mass will begin to follow it, and the output signal for a given ground displacement will therefore diminish. The mechanical system forms a high-pass filter for the ground displacement. Recorders, on the other hand, normally have a constant gain up to some upper cutoff frequency, and contribute only a scale factor to the overall response.

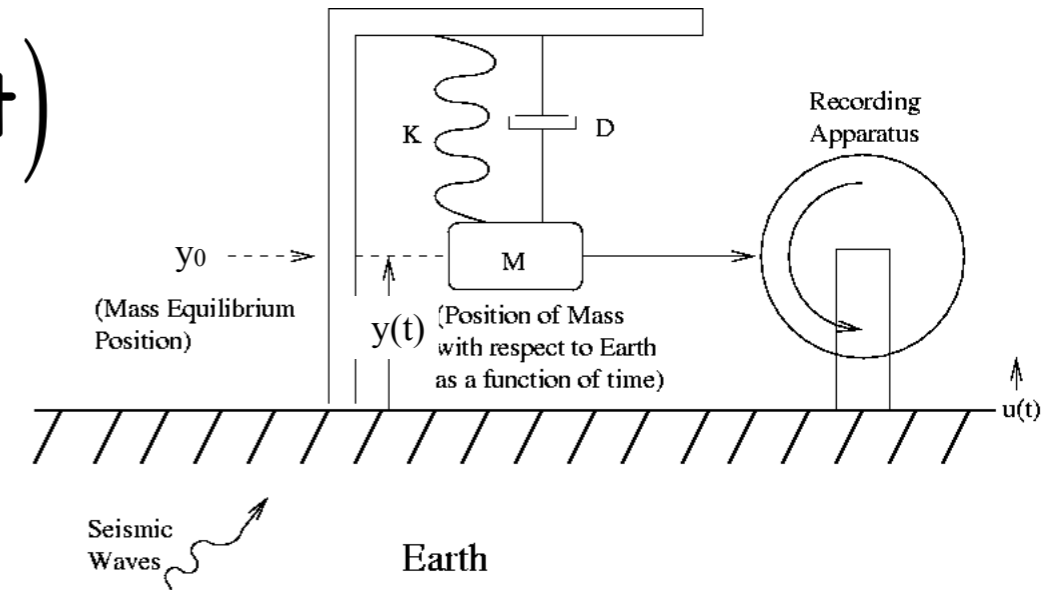


Indicator equation



$$M \left[\ddot{y}(t) + \ddot{u}(t) \right] = -K \left[y(t) - y_0 \right] - D \dot{y}(t)$$

y is the deviation from equilibrium of the mass, which has an equilibrium position in the Earth's gravity field of y_0 , and u is the ground motion; defining $x=(y-y_0)$ we obtain the



Indicator equation

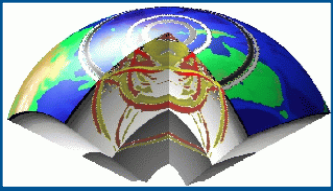
$$\ddot{x}(t) + 2\gamma \dot{x}(t) + \omega_0^2 x(t) = -G \ddot{u}(t)$$

$$\omega_0 = (K/M)^{1/2} \text{ and } 2\gamma \text{ is the damping factor } = D/M$$

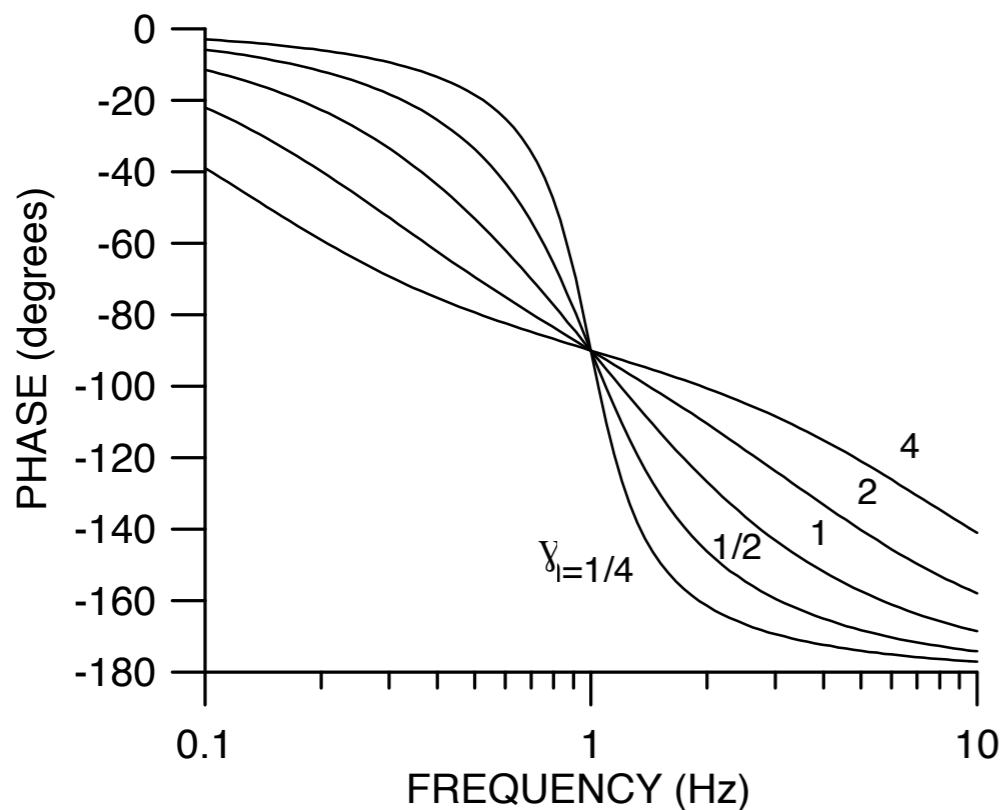
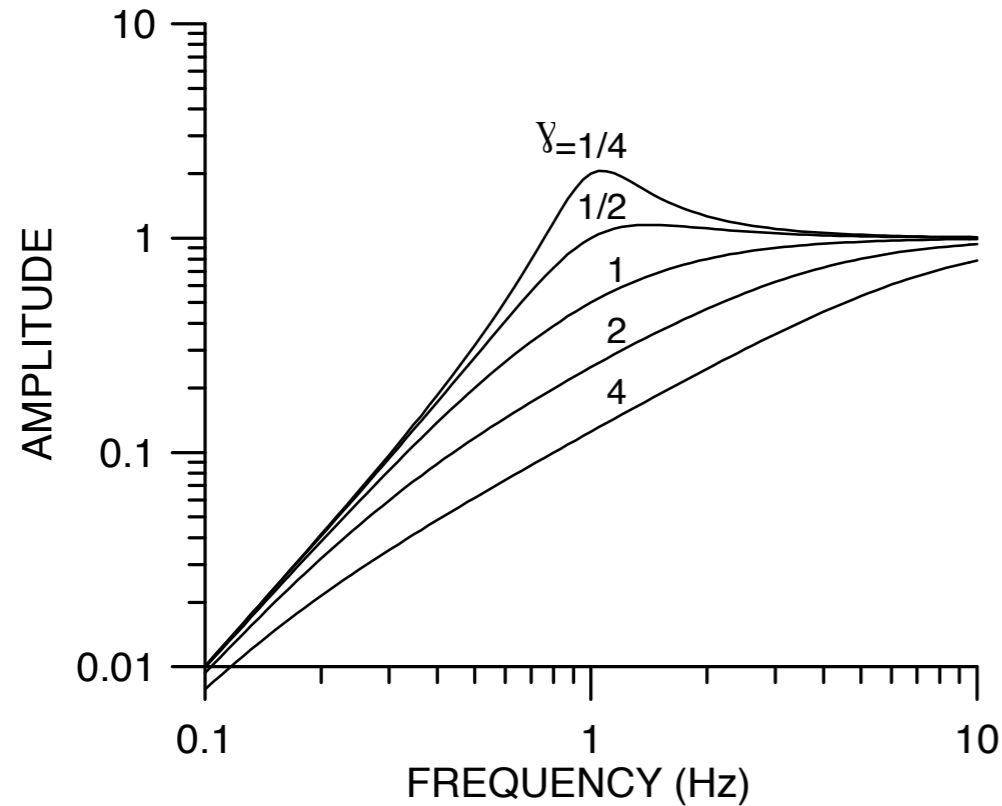
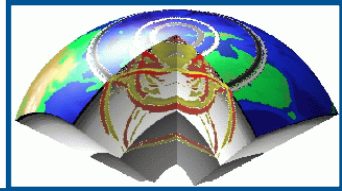
Transfer function

$$|A(\omega)| = \frac{G\omega^2}{\sqrt{(\omega_0^2 - \omega^2)^2 + 4\omega^2\gamma^2}}$$

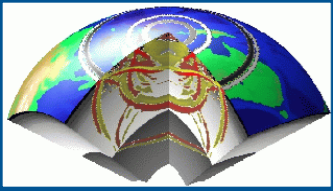
$$\phi(\omega) = \pi - \arctan\left(-\frac{2\gamma\omega}{\omega^2 - \omega_0^2}\right)$$



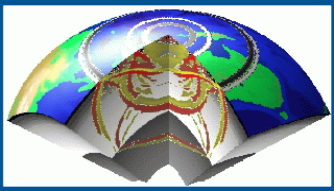
TF of a inertial seismometer



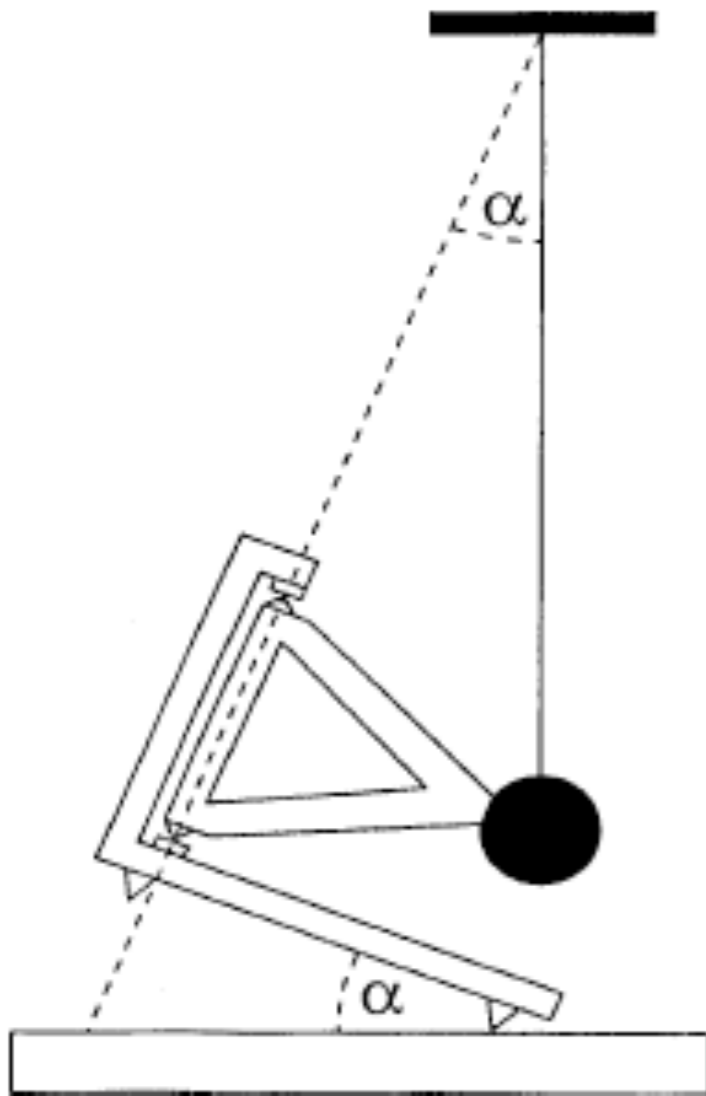
- At very high frequencies ($\omega \gg \omega_0$), $|A(\omega)| \approx 1$, and $\theta \approx \pi$, so the seismometer displacement from equilibrium is the negative of the Earth displacement, $x \approx -u$. In this case, the Earth moves so rapidly that the mass cannot follow the motion at all, and the position of the mass relative to the frame is indeed just $-u$.
- At very low frequencies ($\omega \ll \omega_0$) we have $|A(\omega)| \approx \omega^2 / \omega_0^2$, so that the amplitude of the response falls off quadratically with frequency. From the time domain representation, we see that this response is proportional to the negative of the Earth's acceleration, $x \propto -(d^2u/dt^2)$.
- The seismometer, if coupled to a recording displacement sensor, thus acts like a displacement sensor at short periods and as an accelerometer at long periods.



Astatic pendulums - 1



In order to obtain **high sensitivity** to low frequency seismic waves, we need a low natural frequency. With a standard mass spring sensor, a large mass combined with a soft spring will give a low frequency, but this arrangement is limited by the mechanical properties (e.g. to get a period of 20 s, a length of 100 m is needed!). For both the pendulum and the spring system, if the restoring force is small, the natural frequency will be small. The solution is to use **astatic** suspensions where the restoring force (gravity) is very small and, theoretically, any natural frequency can be obtained.



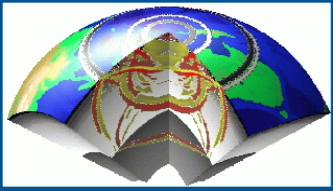
In the "garden-gate" pendulum the mass moves in a nearly horizontal plane around a nearly vertical axis. The restoring force is now $g(\sin\alpha)$ where α is the angle between the vertical and the rotation axis.

To obtain a natural frequency of 0.05 Hz with a pendulum length of 20 cm will require a tilt of 0.1 degree. Making the angle smaller makes the instrument very sensitive to small tilt changes.

The "garden-gate" was one of the earliest designs for long period horizontal seismometers, is still in use but no longer produced.

Principle of the garden gate pendulum: the tilt angle is exaggerated.

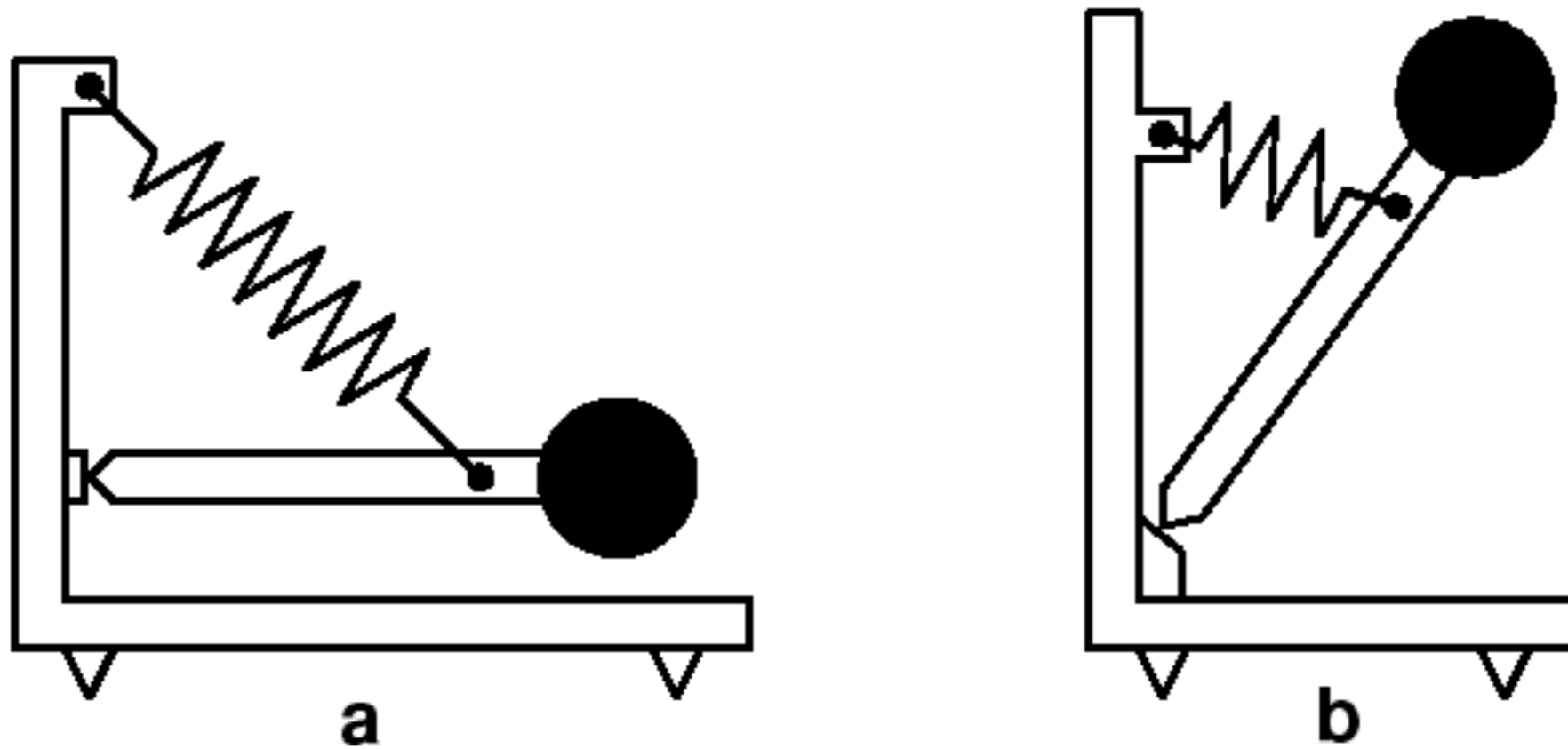
The figure also shows how long a string pendulum must be to have the same natural frequency.



Astatic pendulums - 2



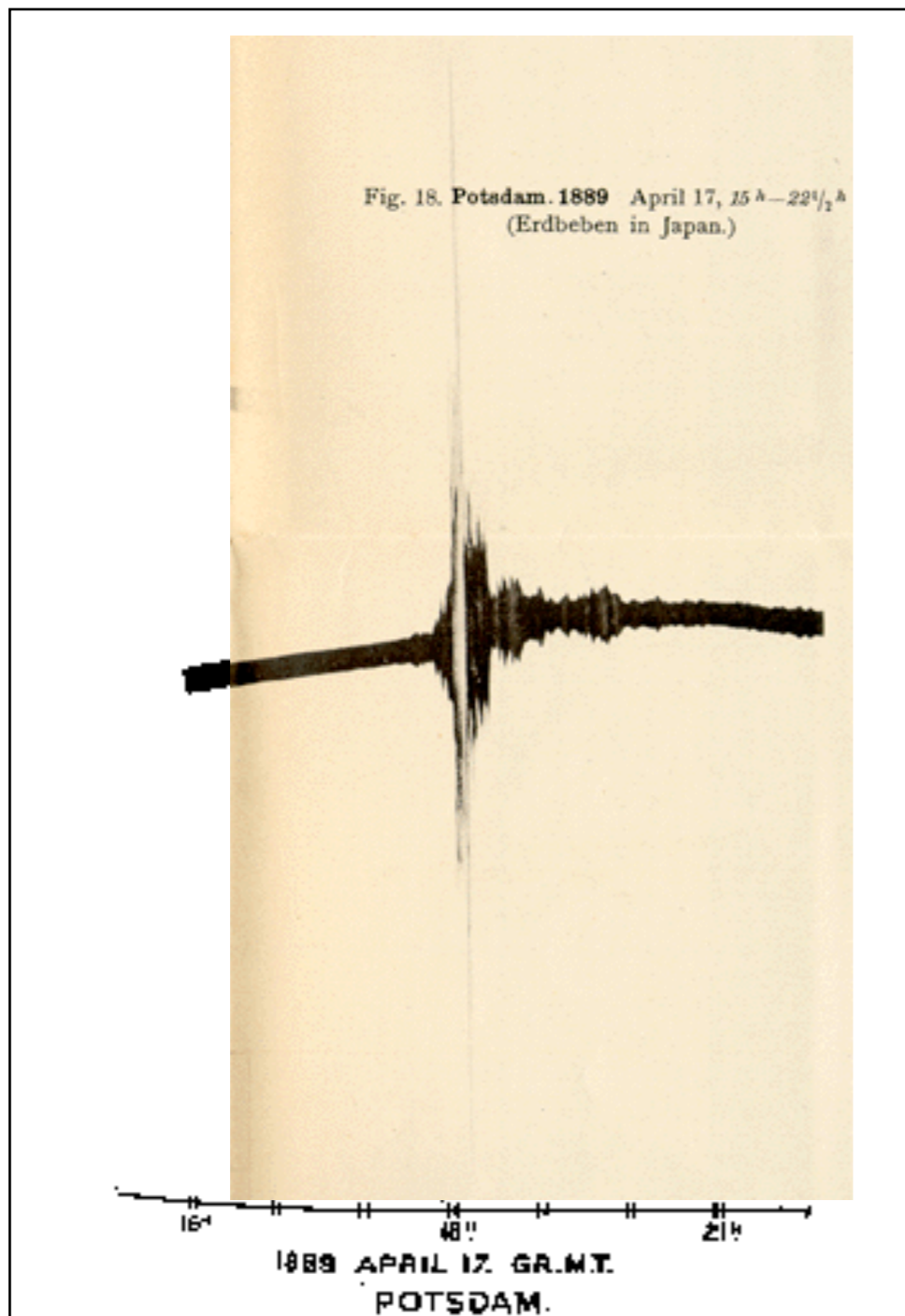
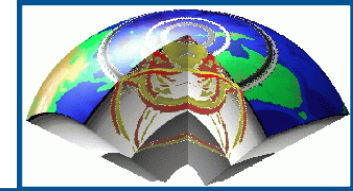
An astatic spring geometry for vertical seismometers was invented by LaCoste (1934). The mass is in neutral equilibrium when three conditions are met: the spring is prestressed to zero length (i.e. the spring force is proportional to the total length of the spring), its end points are seen under a right angle from the hinge, and the mass is balanced in the horizontal position of the boom (a). A finite free period is obtained by making the angle slightly smaller, or by tilting the frame accordingly. By simply rotating the pendulum, astatic suspensions with a vertical or oblique axis of sensitivity can as well be constructed (b).



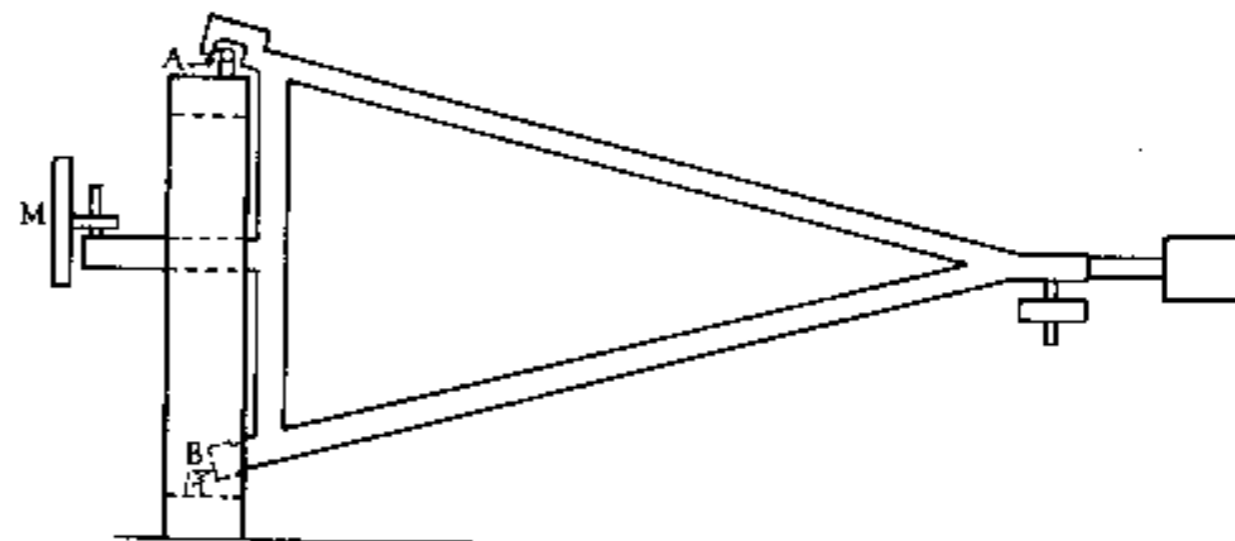
Lacoste suspensions



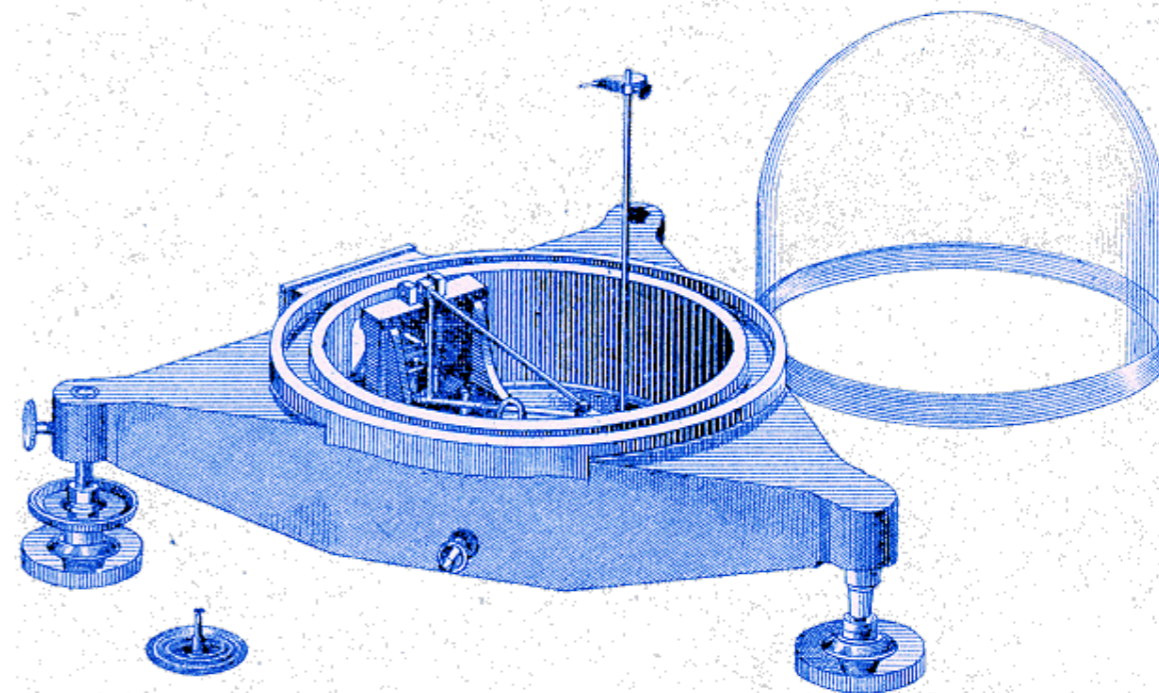
1889 - The first teleseismic record



This seismogram was recorded in Potsdam in 1889, for a Japanese earthquake, with von Rebeur's horizontal pendulum.

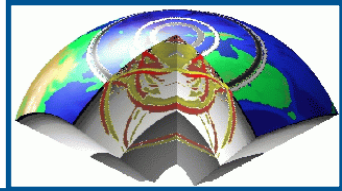


The horizontal pendulum of von Rebeur Paschwitz

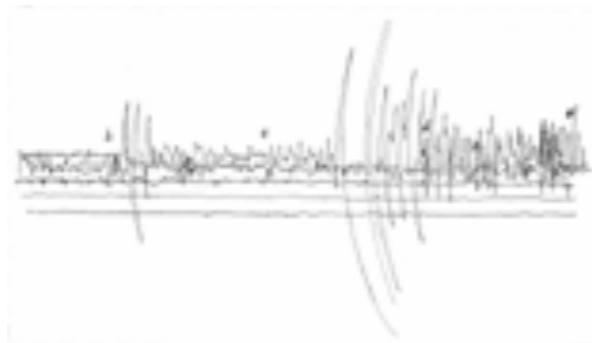
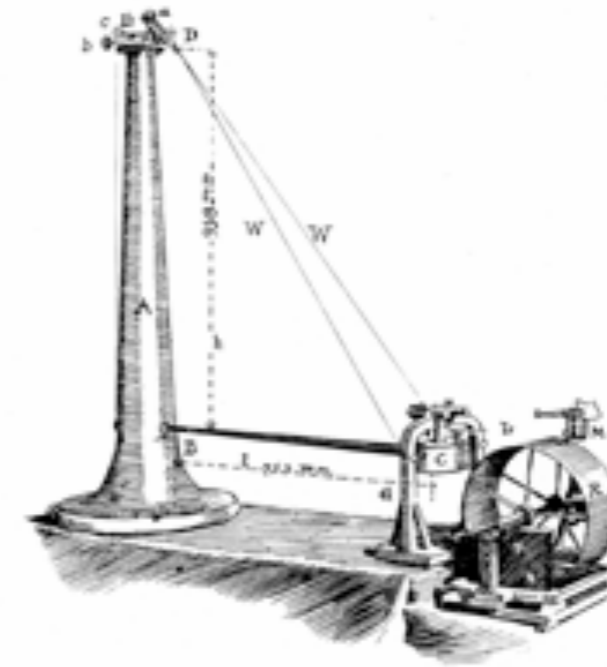




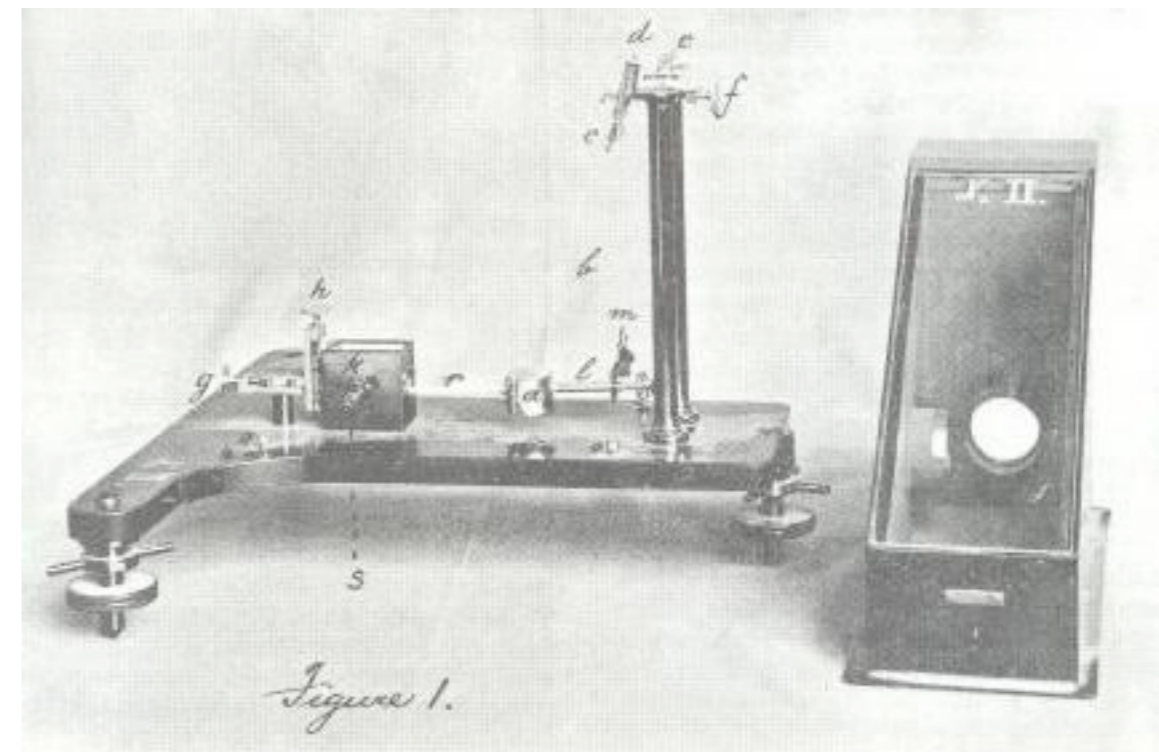
Bosch-Omori seismometer



Early mechanical instrument: the 1905 Bosch-Omori 60s horizontal pendulum. The stylus attached to the mass etched a record directly onto a rotating drum covered with smoked paper. The only damping was due to stylus friction and mechanical friction, and the restoring force acting on the mass was simply gravity.



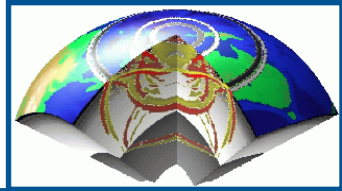
Recording in Tokyo for the 1906 San Francisco earthquake.



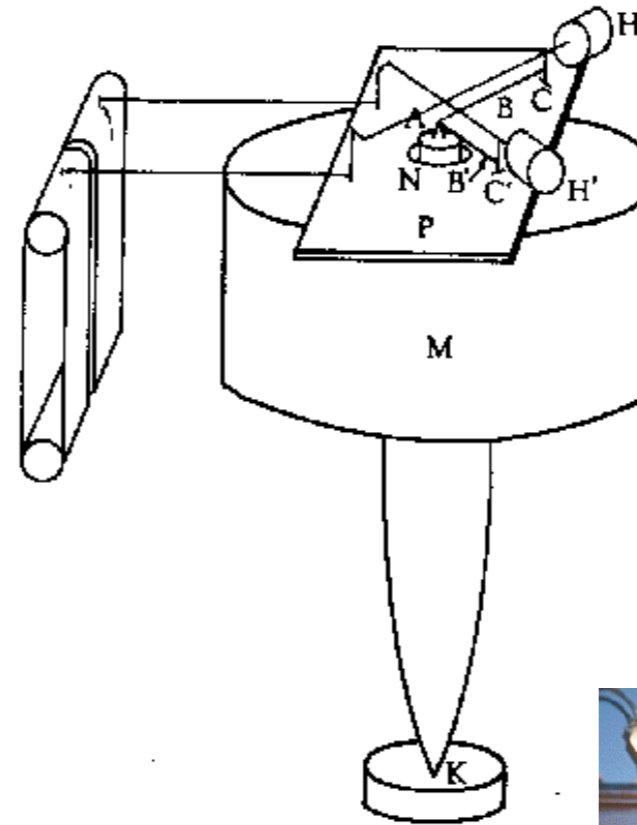
The Bosch horizontal seismograph.

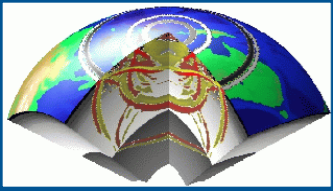


Wiechert Pendulum seismometer

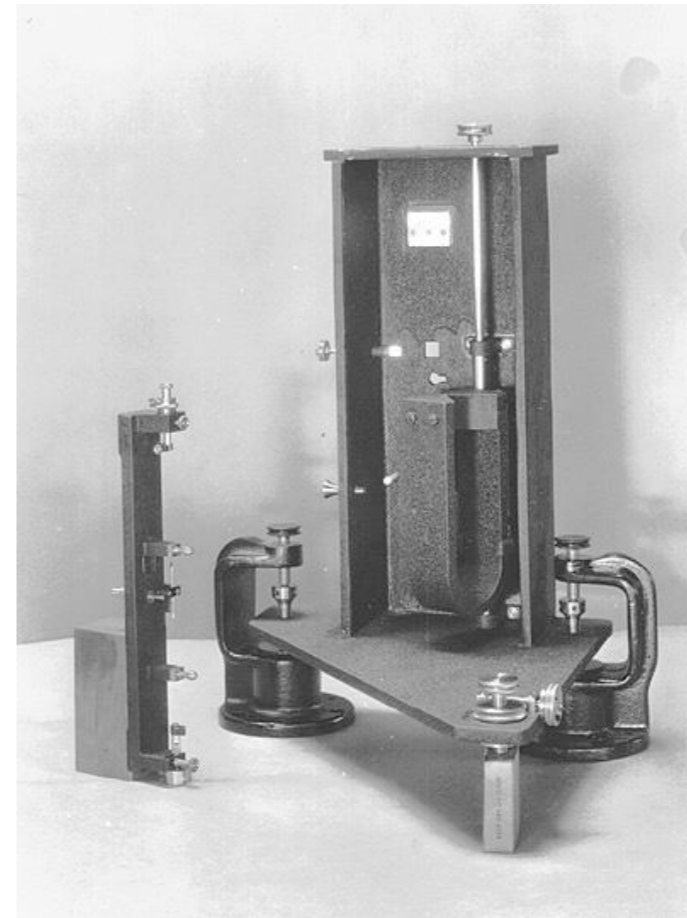
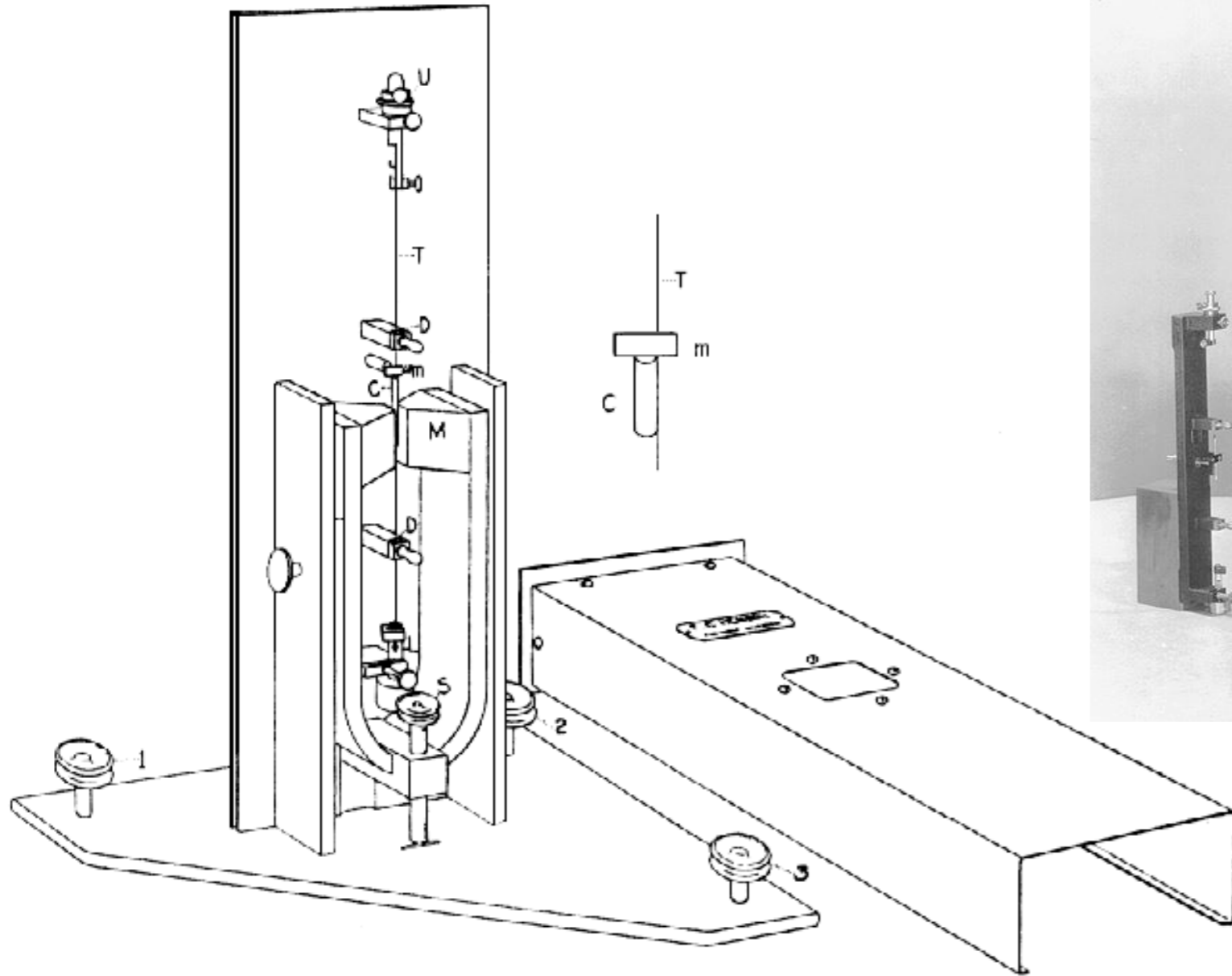
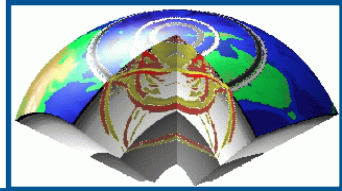


The 1000 kg Wiechert inverted pendulum seismograph (1904). The plate P is attached to the frame of the instrument. N is attached to the pendulum mass. The motion of the mass relative to the frame is resolved at A into perpendicular components. Restoring force is applied to the mass M from springs at C, C' , by means of the rods B, B' . H, H' are the damping cylinders. The whole inverted pendulum is pivoted at K . In the actual seismometer, the rotation of the pendulum about K takes place in flat springs, which are arranged in a cardan hinge to permit the pendulum to move in any horizontal direction.



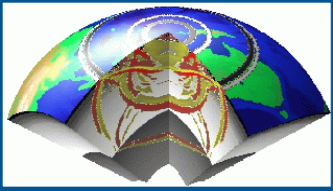


Wood-Anderson seismometer

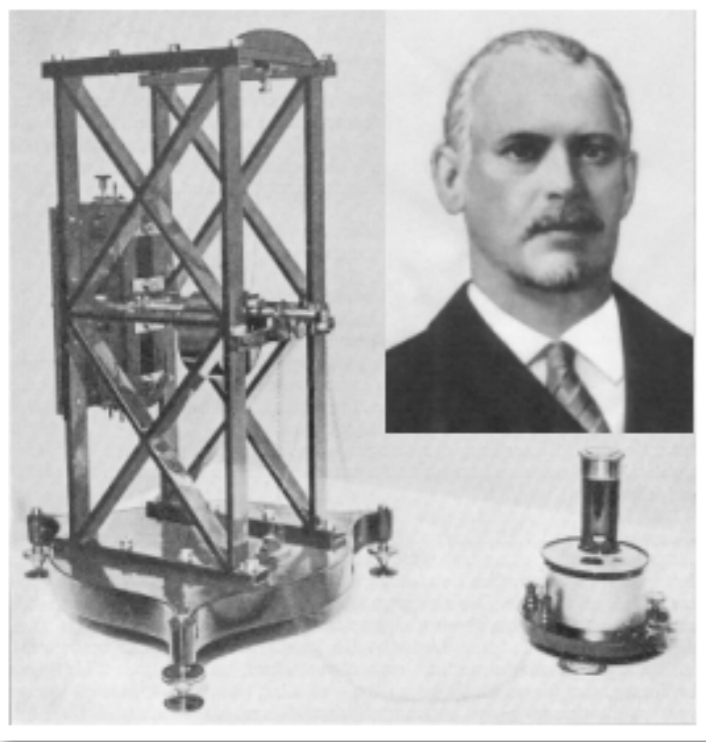
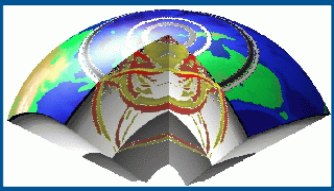


One clever variation on this basic seismometer design was developed in southern California by Harry O. Wood and J.A. Anderson, who invented the "torsion seismometer" in 1922. The motion generated when this instrument was shaken by an earthquake came not from a suspended pendulum, but from the torsional (rotational) motion of a small inertial mass affixed to a thin wire under high tension.

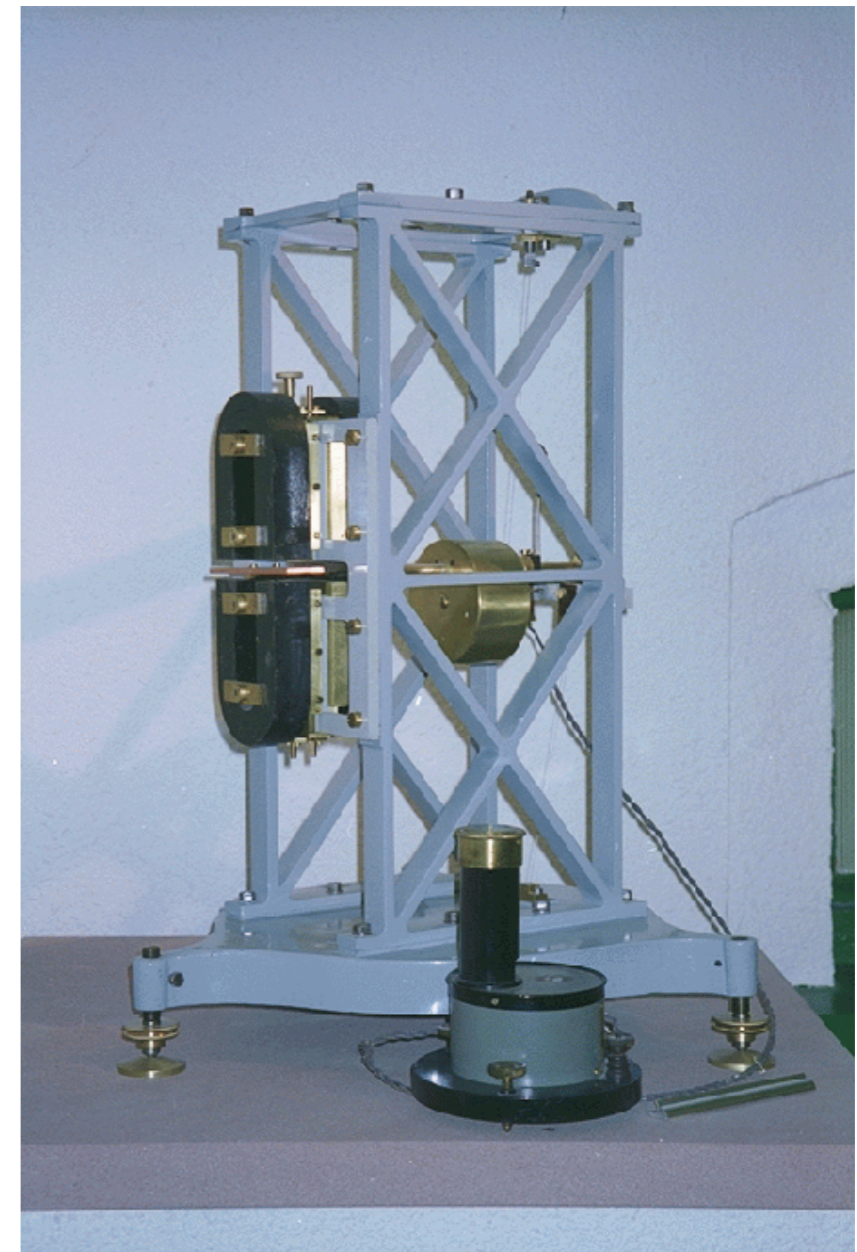
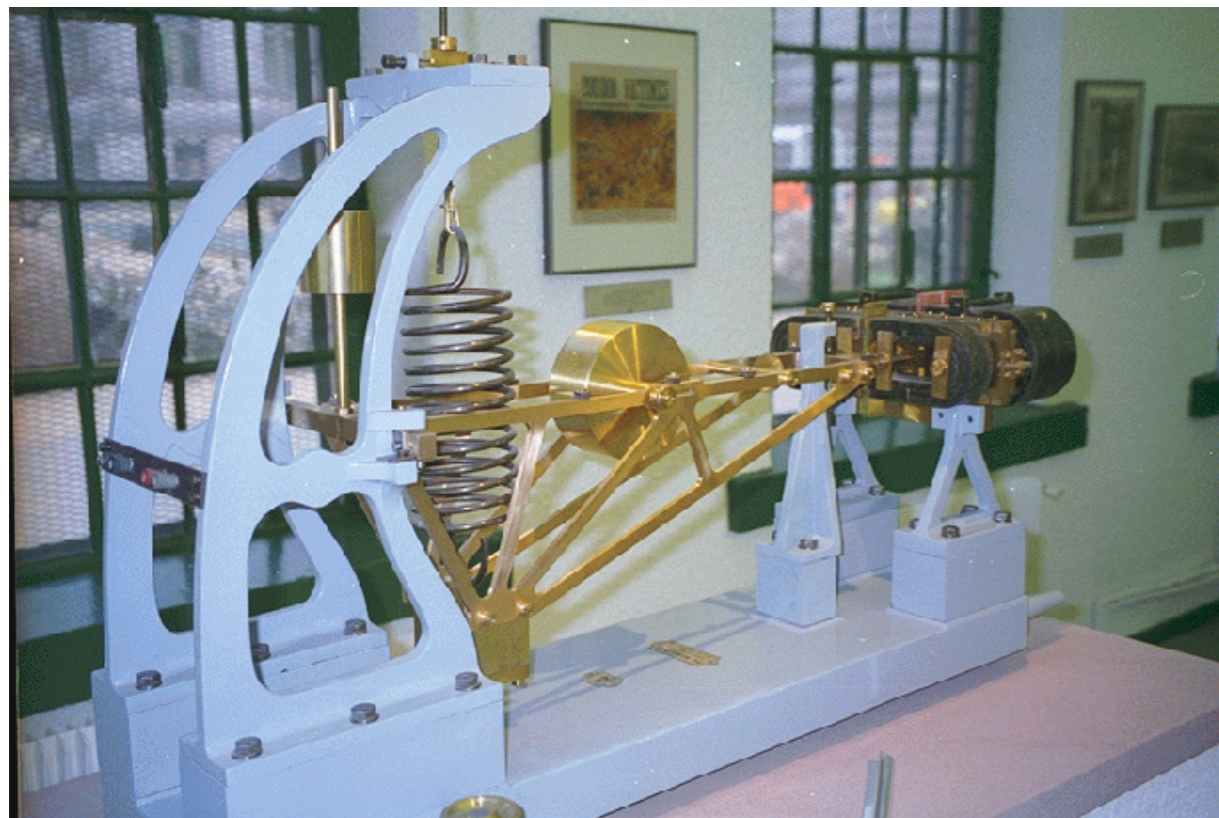
The **Wood-Anderson torsion seismometer** was designed to be as sensitive and as nearly frictionless as possible. Damping of the torsional motion was accomplished using magnets. Seismograms were "drawn" not with a stylus or needle, but with a beam of light reflected onto photosensitive paper from off of a mirror on the inertial mass.

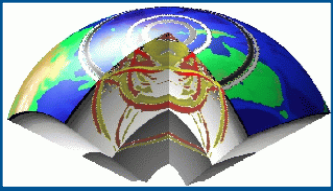


Galitzin seismometers

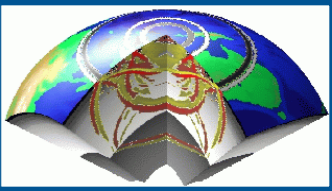


In 1906 Boris Galitzin designed a seismograph that made the need for mechanical linkage between the pendulum and the recorder obsolete. Instead he mounted a coil of wire on the pendulum and suspended both between the poles of a magnet that was fixed to the earth. During an earthquake, the magnetic field was moved around a coil generating electrical current. Because of this the recorder could now be separated from the seismograph by use of a wire.

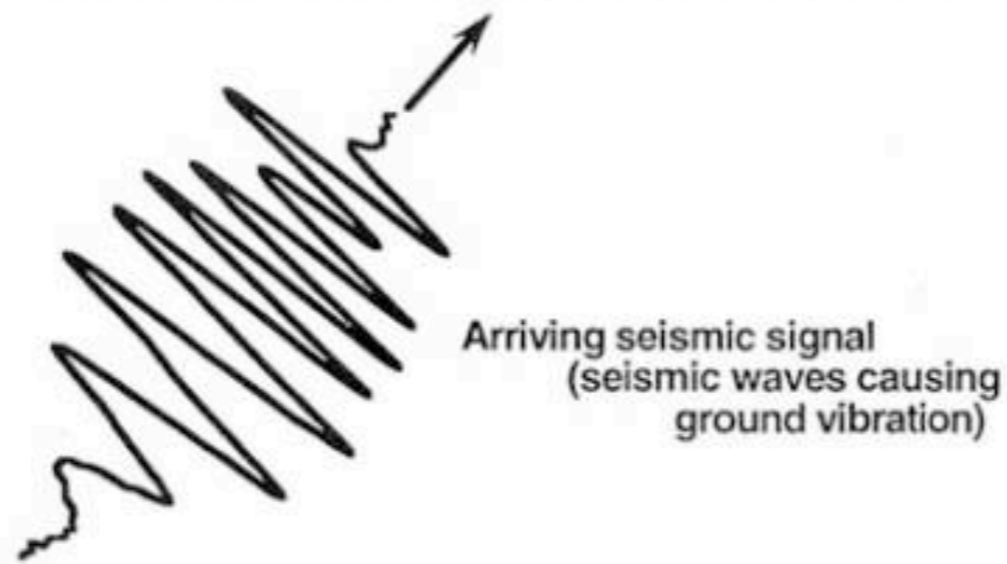
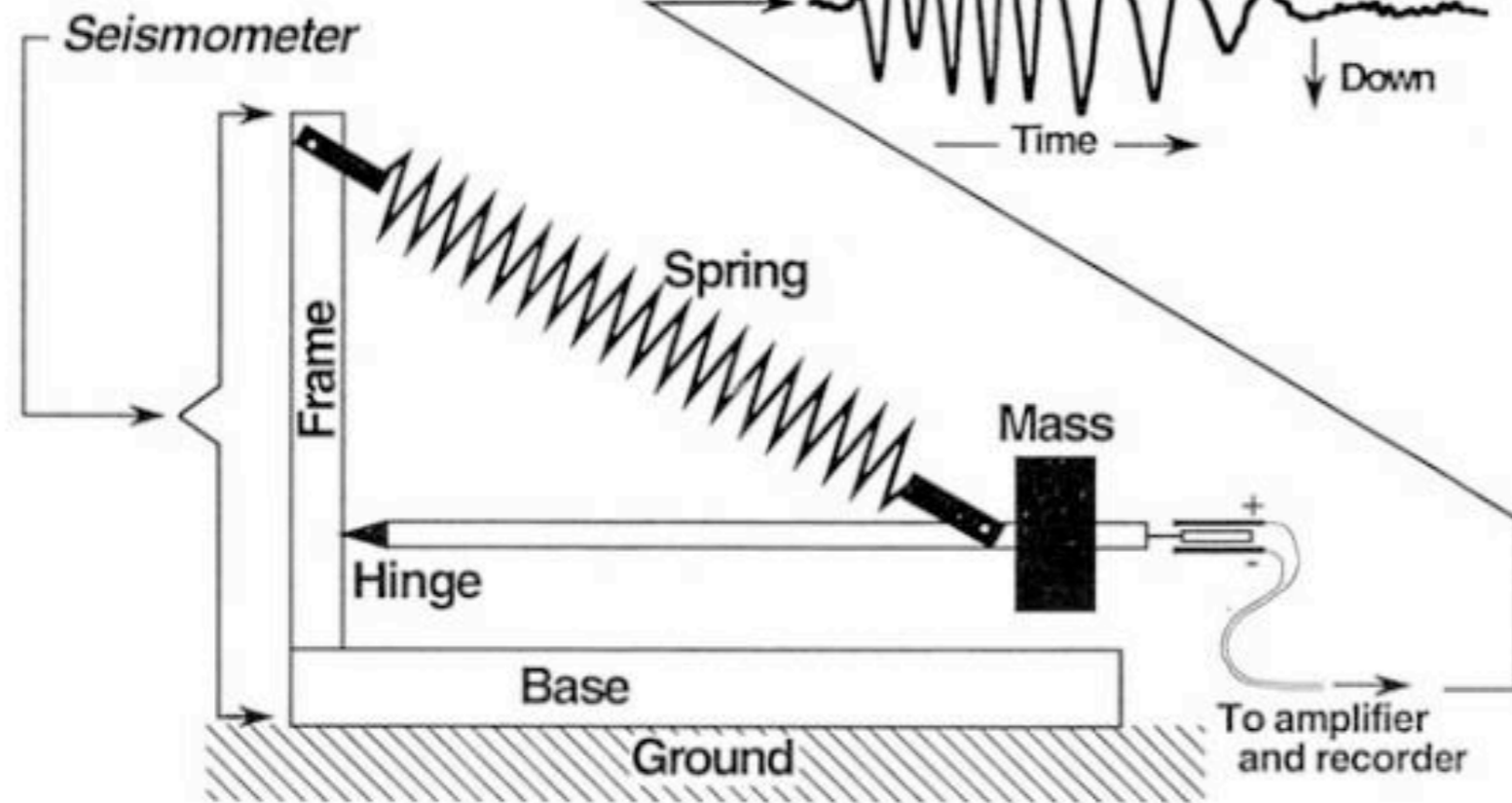
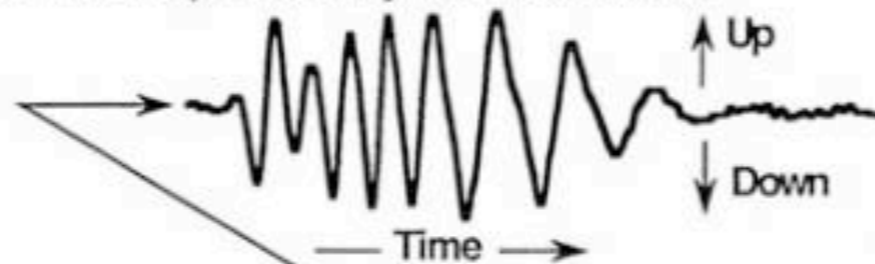




Electromagnetic seismometers

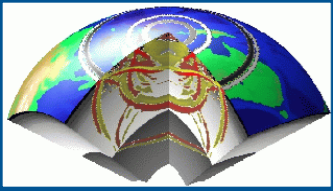


Seismogram – Output of seismograph from input signal (ground vibration) sensed by the seismometer

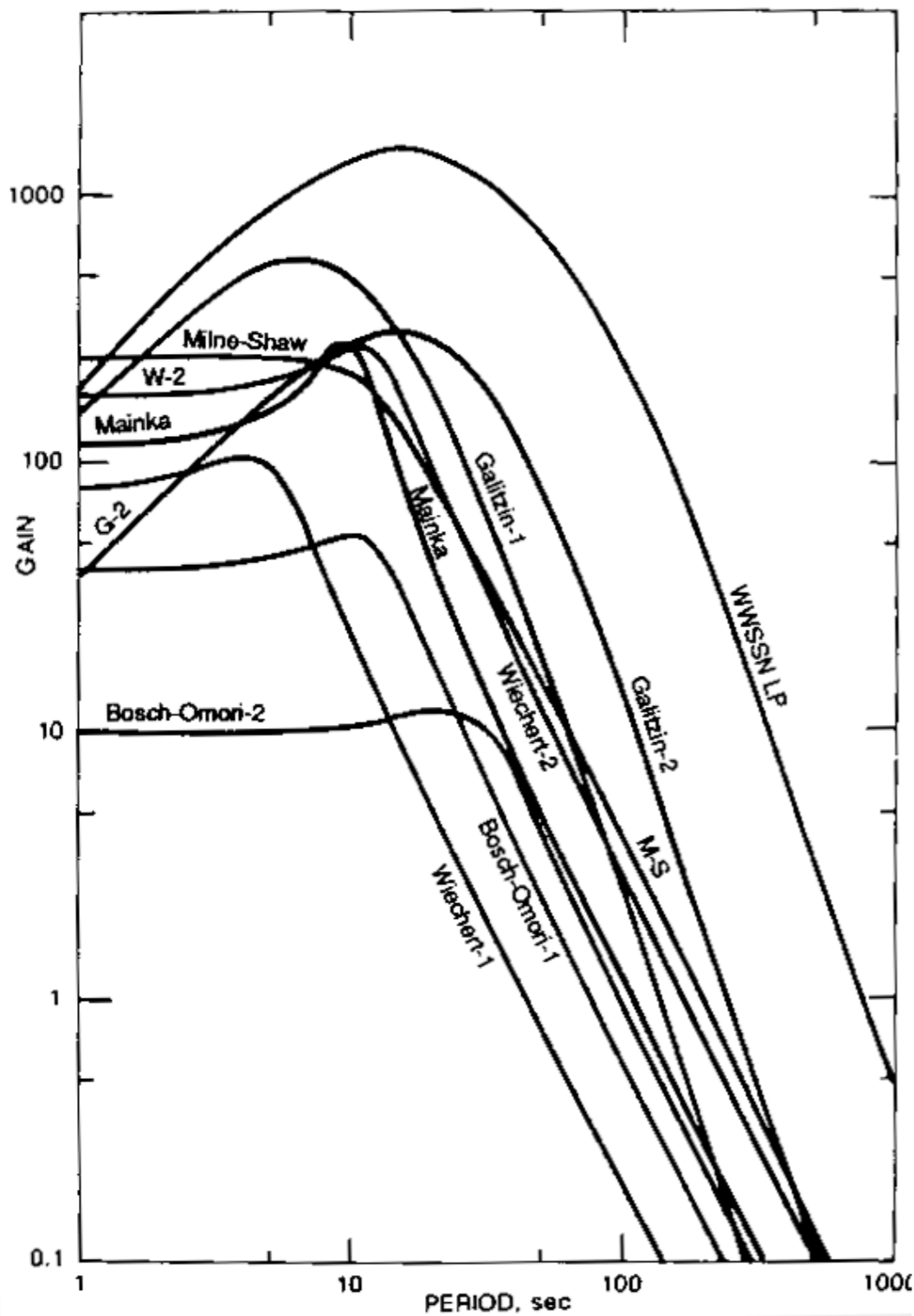
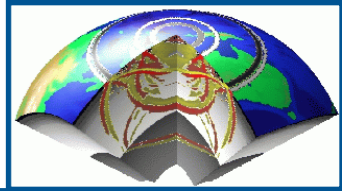


In 1906 Boris Galitzin designed a seismograph that made the need for mechanical linkage between the pendulum and the recorder obsolete. Instead he mounted a coil of wire on the pendulum and suspended both between the poles of a magnet that was fixed to the earth. During an earthquake, the magnetic field was moved around a coil generating electrical current. Because of this the recorder could now be separated from the seismograph by use of a wire.

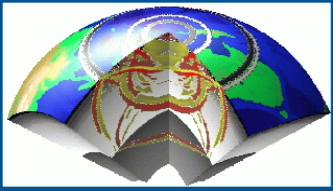
Modern seismometers are **sensitive electromechanical** devices but the basic idea behind measuring ground movement can be illustrated using a simpler physical system that is actually quite similar to some of the earliest seismograph systems.



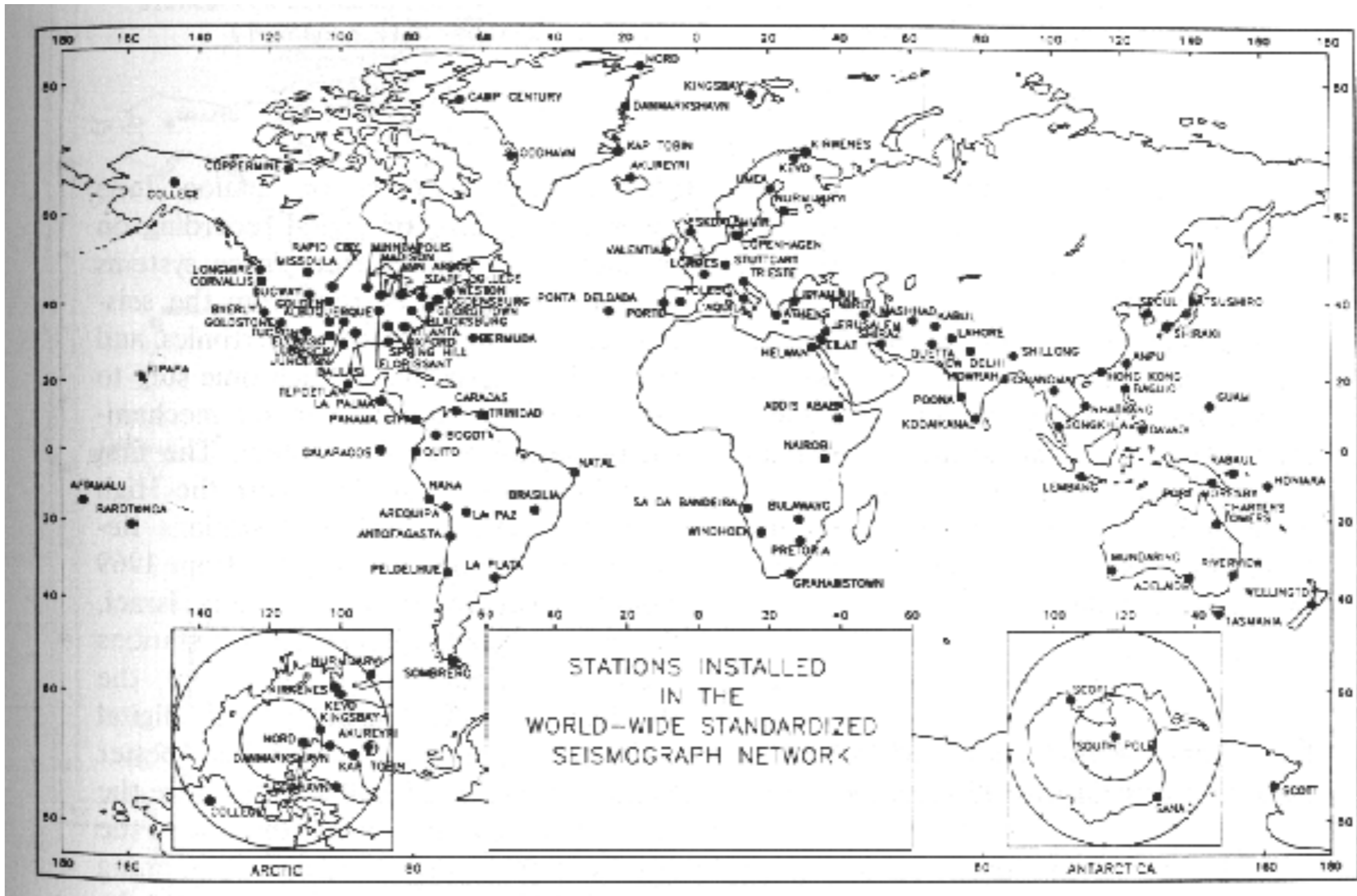
Classic seismometers response curves



Instrument response curves for a suite of classic seismometers, indicating their magnification as a function of period. For very long periods (low frequencies) all of the curves fall as $1/T^2$, being sensitive to ground acceleration; for shorter periods the pendulum-type behaviour is sensitive to displacement.



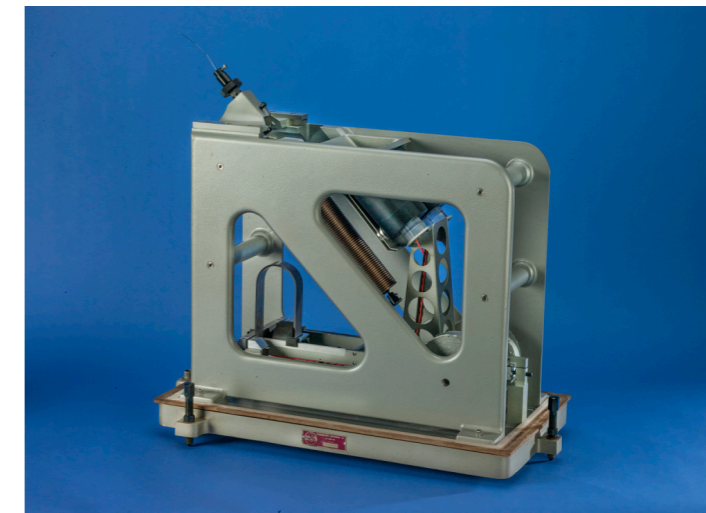
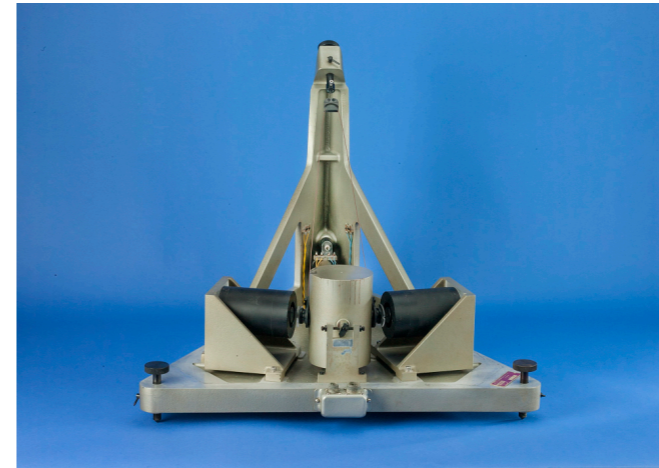
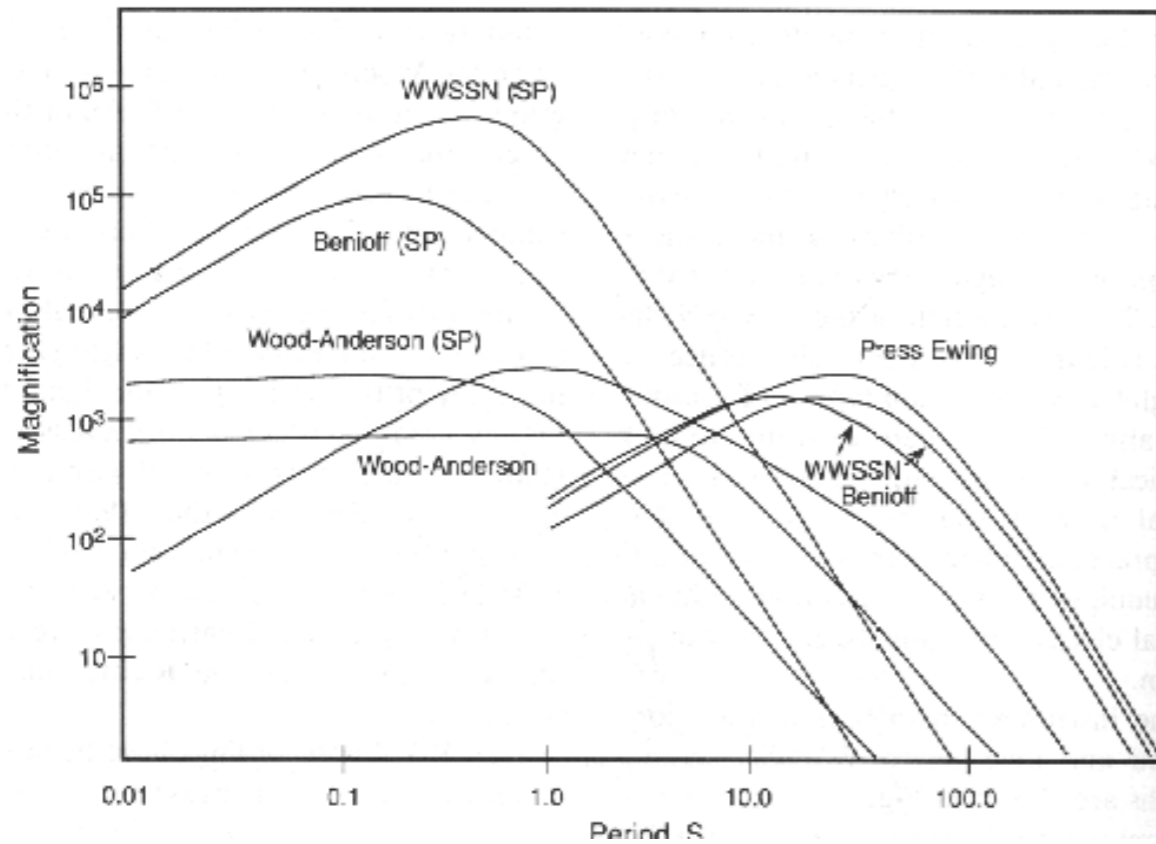
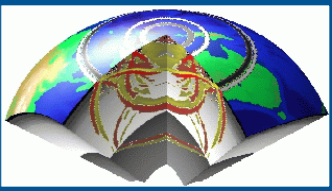
WWSSN



World Wide Standardized Seismic Network: was deployed by the US Government in the 1960's to monitor nuclear explosions and help verify nuclear test treaties.



WWSSN Seismometers



3 short period, 1s pendulum and 0.7s galvanometer periods, and 3 long-period, 15s pendulum and 100s galvanometer periods, instruments were deployed, starting from the 1960s, as a global array to record horizontal and vertical motion. The recordings, with accurate timing and standard response, have been extensively utilized because the original photographic records were filmed and distributed to data centers .



Ex Soviet Union station - Kishinev (KIS)

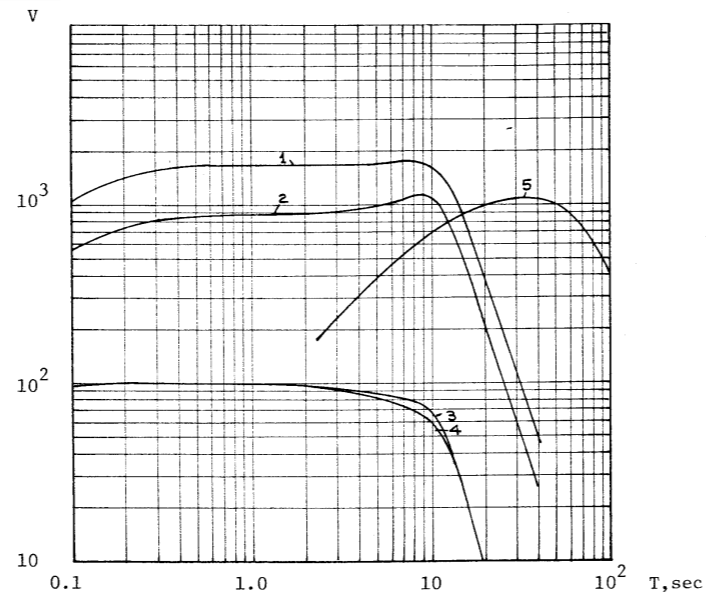
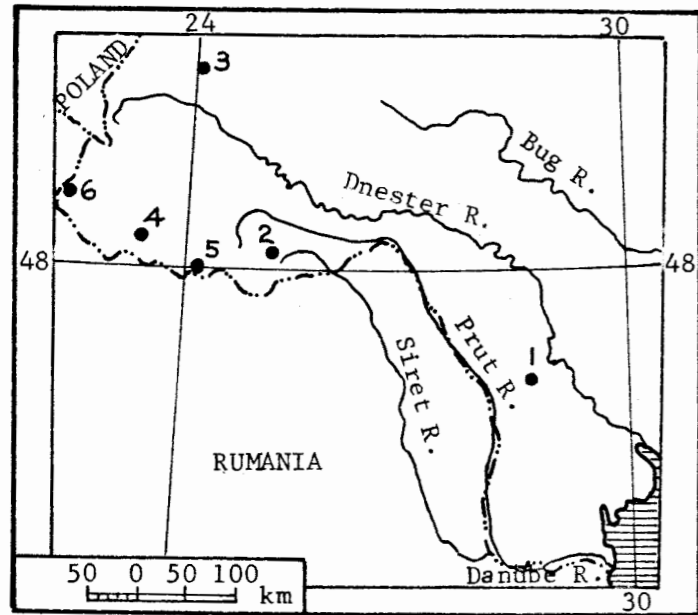
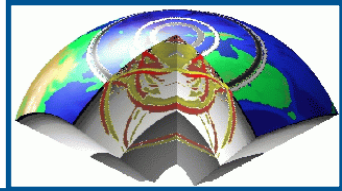


Fig. 5 -- Seismographic stations in Carpathi

1. Kishinev (60)
2. Kosov (64)
3. L'vov (79)
4. Mezghor'ye (85)
5. Rakhov (117)
6. Uzhgorod (156)

Fig. 68 -- Magnification curves of seismographs at the Kishinev station in 1970 [3]

- 1 -- SK (N-S,E-W)
- 2 -- SK (Z)
- 3 -- SK-KPCh (Z)
- 4 -- SK-KPCh (N-S,E-W)
- 5 -- SD-1 (Z)

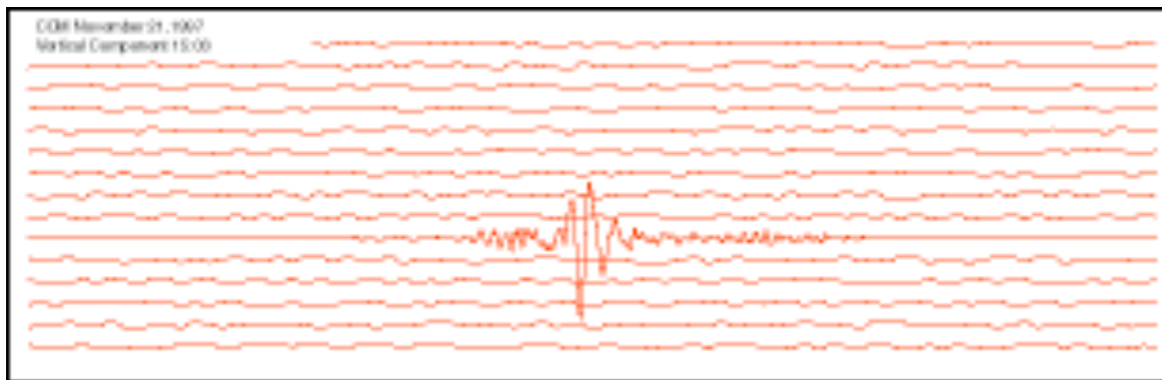
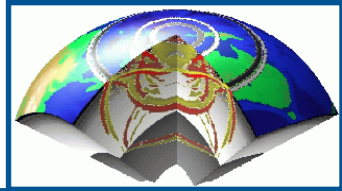
TABLE 1 Data on Seismic Motion Recording Instruments in Moldova (Main Channels)

Name of station	Type	Component	Frequency-amplitude Characteristics		Speed of film mm/min
			V _{max}	T _{max}	
Kishinev	SKM-3	NS, EW, Z	3000	0.6-1.9	60
	SKD	NS, EW, Z	1000	0.2-19	30
	SKD esr	NS, EW, Z	100	0.2-15	30
	SD-2	Z	1200	17-52	15
	SD-2 esr	Z	33	26-67	15

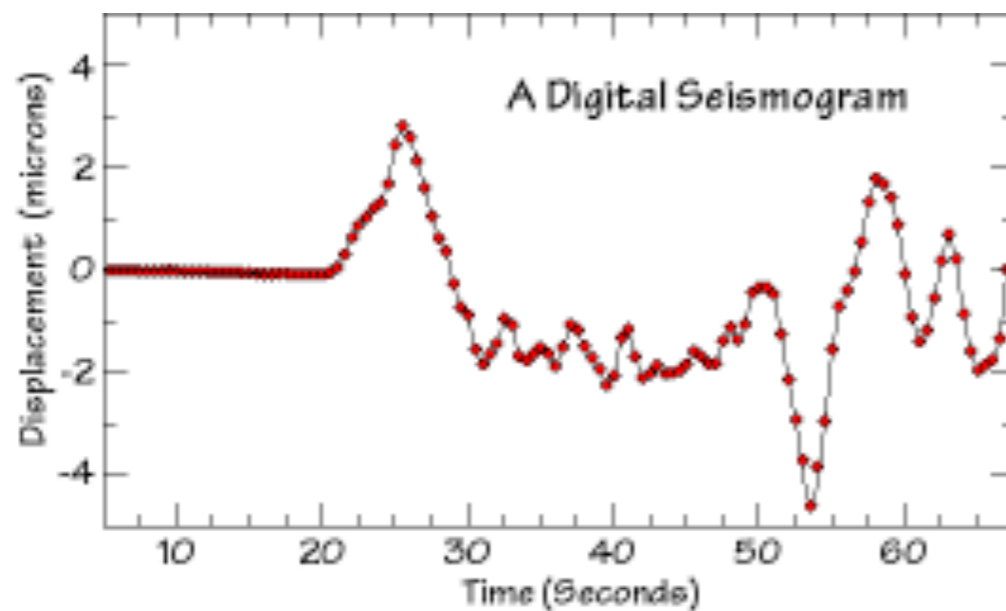




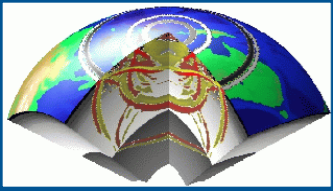
Seismograms



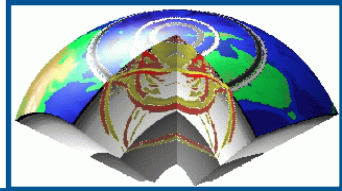
For most of the last century, seismograms were recorded on sheet of paper, either with ink or photographically. We call such records "analog" records to distinguish them from digital recordings. These records are read just like a book - from top-to-bottom and left-to-right.



Today, most seismic data are recorded digitally, which facilitates quick interpretations of the signals using computers. Digital seismograms are "sampled" at an even time interval, that depends on the type of seismic instrument and the interest of the people who deploy the seismometer (connected with **Nyquist** frequency), for a range of times (connected with spectral resolution).



Decibels and Dynamic Range



A **decibel** (abbreviated dB) is defined as one tenth of a bel.

The **bel** is an **amplitude unit** defined originally for sound as the log (base 10) of the energy (or intensity or power, i.e. the energy per time unit) relative to some reference energy, i.e.:

$$\text{Amplitude}_{\text{bel}} = \log_{10}(\text{Energy}/\text{Energy}_{\text{ref}}) = 2\log_{10}(\text{Amplitude}/\text{Amplitude}_{\text{ref}})$$

$$\text{Amplitude}_{\text{dB}} = 10\log_{10}(\text{Energy}/\text{Energy}_{\text{ref}}) = 20\log_{10}(\text{Amplitude}/\text{Amplitude}_{\text{ref}})$$

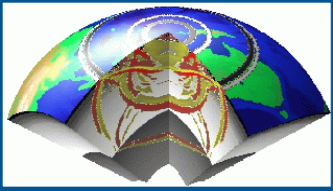
The dynamic range of a signal processing system can be defined as the maximum dB level sustainable without overflow (or other distortion) minus the dB level of the “noise”.

Similarly, the dynamic range of a signal can be defined as its maximum decibel level minus its average “noise level” in dB.

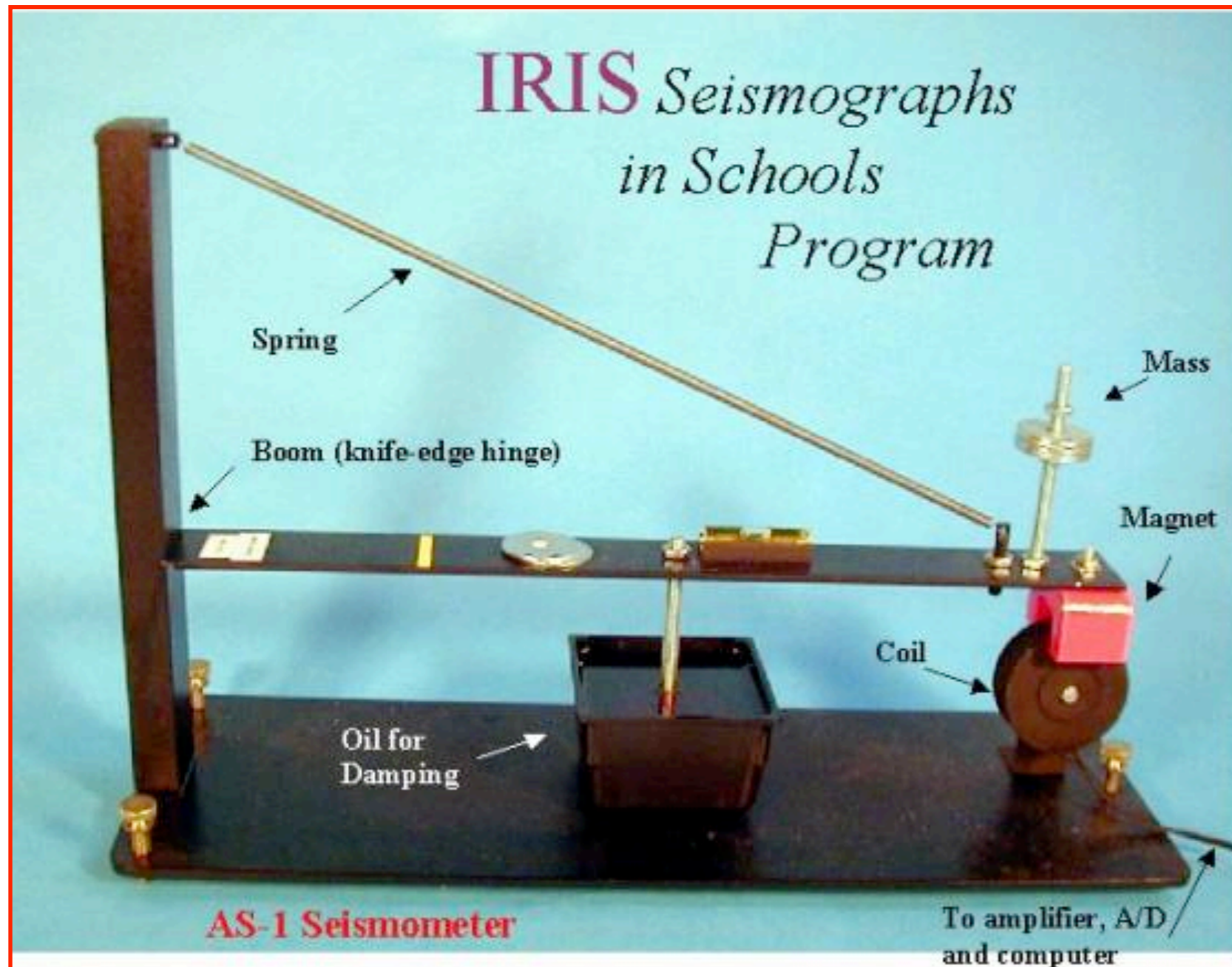
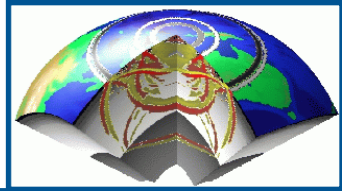
$$1 \text{ dB} = 20 \log_{10} \frac{A}{A_{\text{ref}}}$$

Dynamic Range and Gain Ranging

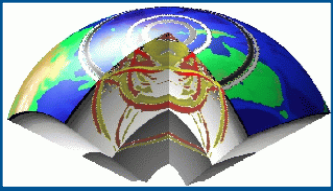
Bits	Ratio	dB
2	$2^2 = 4$	12
4	$2^4 = 16$	24
8	$2^8 = 256$	48
12	$2^{12} = 4,096$	72
16	$2^{16} = 65,536$	96
24	$2^{24} = 16,777,216$	144



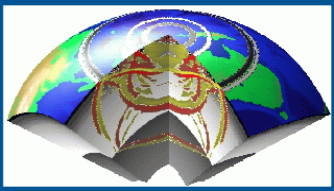
Practical example



Vertical component seismometer: ground motion cause the coil to move relative to the magnet that is suspended by the spring and boom assembly. The mass of the seismometer, consisting primarily of the magnet and the washers, tends to remain steady because of inertia when the base moves. The motion of the coil relative to the magnet generates a small current in the coil. The current is amplified and digitized by an amplifier unit and connected to the computer for recording and display. The damping reduces the tendency for the mass and spring system to oscillate for long duration from a single source of ground motion.



Passive seismometer



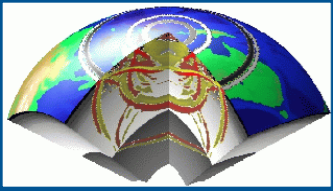
The precision of a conventional, **passive** seismometer depends on its two functional subunits:

the **mechanical suspension** and the displacement or velocity **transducer**.

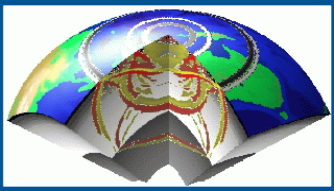
An inertial seismometer basically measures the inertial force acting on the seismic mass in an accelerated local frame of reference. The suspension converts the inertial force into a displacements of the mass, and the transducer converts this into an electric signal.

Neither one of these conversions is inherently precise. A sensitive seismometer must have a suspension with a small restoring force so that small accelerations produce noticeable displacements of the seismic mass. Then, of course, larger seismic signals or environmental disturbances produce large displacements that change the geometry of the spring and destroy the linear relationship between displacement and force. When the restoring force is diminished, undesired effects such as hysteresis and viscous behaviour retain their absolute magnitudes and thus become relatively larger. Finally, it is difficult to build linear transducers with a large range.

A passive seismic sensor therefore cannot be optimized for sensitivity and precision at the same time.



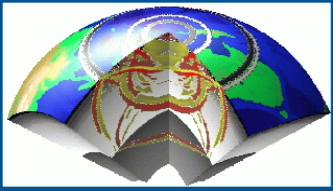
Broad-Band instruments



The frequency content of the seismic waves varies from many tens of hertz to free oscillations of the Earth caused by great earthquakes which have frequencies on the order of 10^{-4} hertz. From an instrumentation standpoint, it is difficult to cover the dynamic range (orders of magnitude difference in ground shaking) and spectral bandwidth (range in frequency content) with a single instrument. Only a limited range of these signals can be visibly displayed at a time and any seismograph recording on paper or film has to act as a filter and suppress most of the available information. Quite a number of analog seismographs with different characteristics had to be operated in parallel in order to preserve a reasonable choice of signals.

Digital technology now permits the recording of all useful seismic signals on the same medium in a single data stream. Such a system is called a **very-broad-band (VBB)** seismograph and guarantees:

1. The system has a sensitivity sufficient to resolve signals at the level of minimum ground noise at all frequencies of interest.
2. Its operating range must be large enough to record the largest earthquakes from regional to teleseismic distances.
3. The largest ground noise, natural or artificial, that is likely to occur in any part of the spectrum must not interfere with the resolution of small signals at other frequencies.

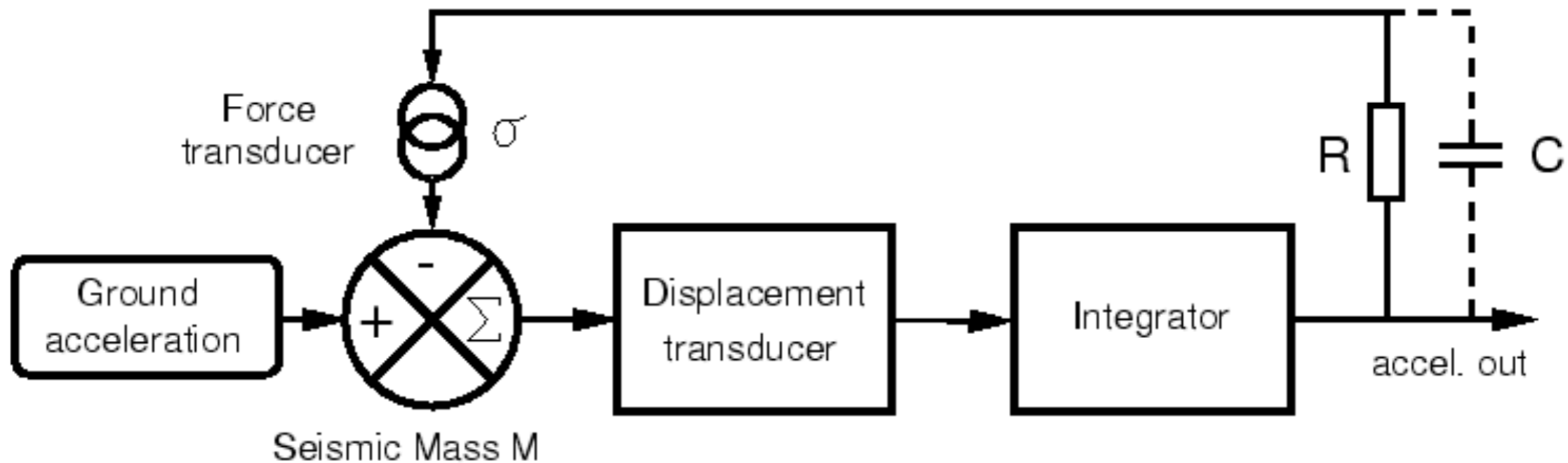


Force-balance (retroaction) principle



These problems are solved by compensating the unknown force with a known force, rather than determining it indirectly from the elongation of a spring. The compensating force is generated in an **electromagnetic transducer** and is controlled by a **servo circuit** that senses the position of the seismic mass and adjusts the force so that the mass returns to its center position.

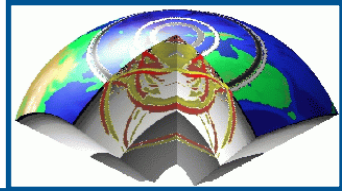
Due to unavoidable delays in the feedback loop, servo systems have a limited bandwidth; however at frequencies where they are effective, they force the mass to move with the ground by generating a feedback force strictly proportional to ground acceleration. When the force is proportional to the current in the transducer, then the current, the voltage across the feedback resistor R , and the output voltage are all proportional to ground acceleration. We have thus converted the acceleration into an electric signal without relying on the mechanical precision of the spring. The suspension still serves as a detector but not as a converter, and may now be optimized for sensitivity without giving up precision.



circuit of a force-balance accelerometer (FBA), widely used for earthquake **strong-motion** recording



Feedback

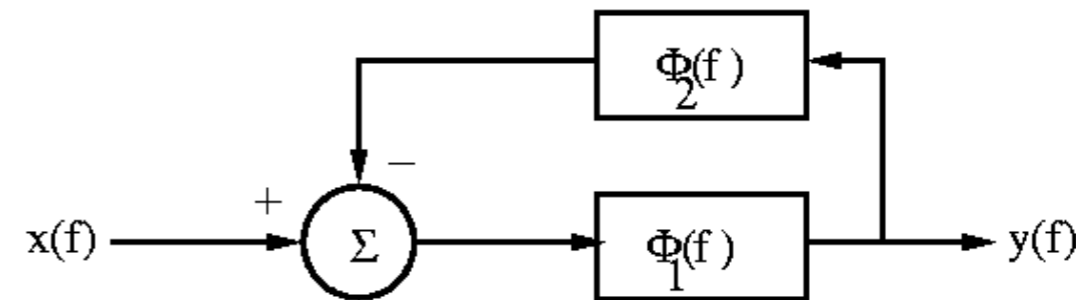


An important phenomenon to understand is the effect of feedback on the transfer function of a system. A filtered portion of an output signal is modified by the feedback transfer function Φ_2 is subtracted from the input signal (negative feedback). The effect of feedback can alter the response significantly and, in the case of engineering applications, in several highly desirable ways.

Consider the net transfer function for the system:

$$y(\omega) = [x(\omega) - \Phi_2(\omega)y(\omega)]\Phi_1(\omega)$$

$$\Phi(\omega) = \frac{\Phi_1(\omega)}{1 + \Phi_1(\omega)\Phi_2(\omega)}$$



and for a seismometer with a constant feedback transfer function (k) one has:

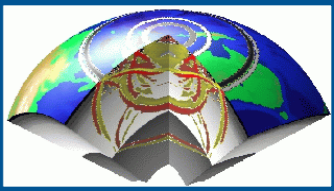
$$\Phi(\omega) = \frac{\frac{-\omega^2}{\omega^2 - 2i\gamma\omega - \omega_0^2}}{1 - \frac{k\omega^2}{\omega^2 - 2i\gamma\omega - \omega_0^2}} = \frac{-\omega^2}{(1 - k)\omega^2 - 2i\gamma\omega - \omega_0^2}$$

$$\omega_{0fb}^2 = \omega_0^2(0.5 - k)$$

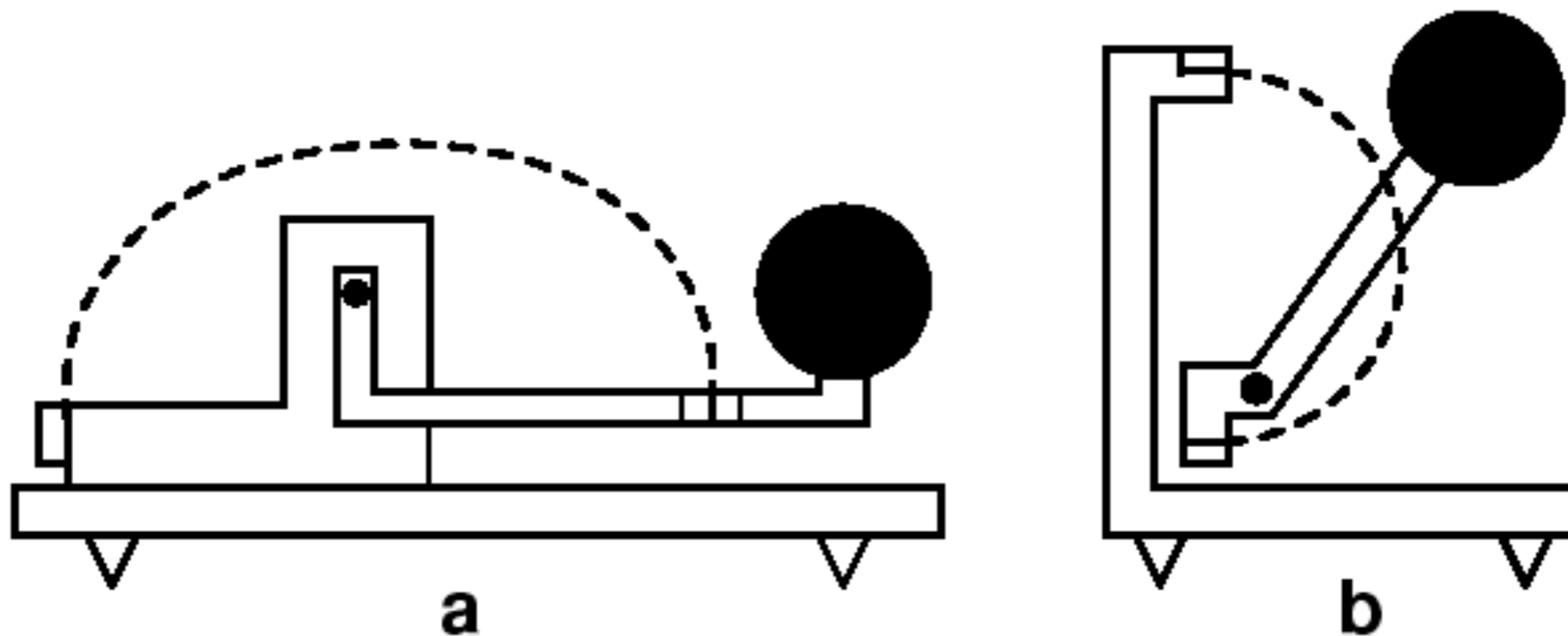
Choosing $1/2 > k > 0$, the resonant period can be substantially reduced, and hence the long-period response can be much improved



Astatic pendulums - 3



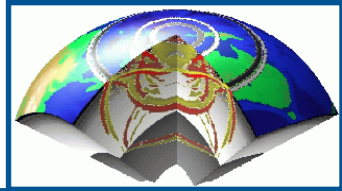
The astatic leaf-spring suspension (a) used in the STS1 seismometer (Wielandt 1975, Wielandt & Streckeisen 1982) is in a limited range around its equilibrium position comparable to a LaCoste suspension but it is much simpler to manufacture. A similar spring geometry is also used in the triaxial seismometer STS2 (b). The delicate equilibrium of forces in astatic suspensions makes them susceptible to external disturbances such as changes in temperature; they are difficult to operate without a stabilizing feedback system (**active sensor**).



Leaf spring astatic suspensions

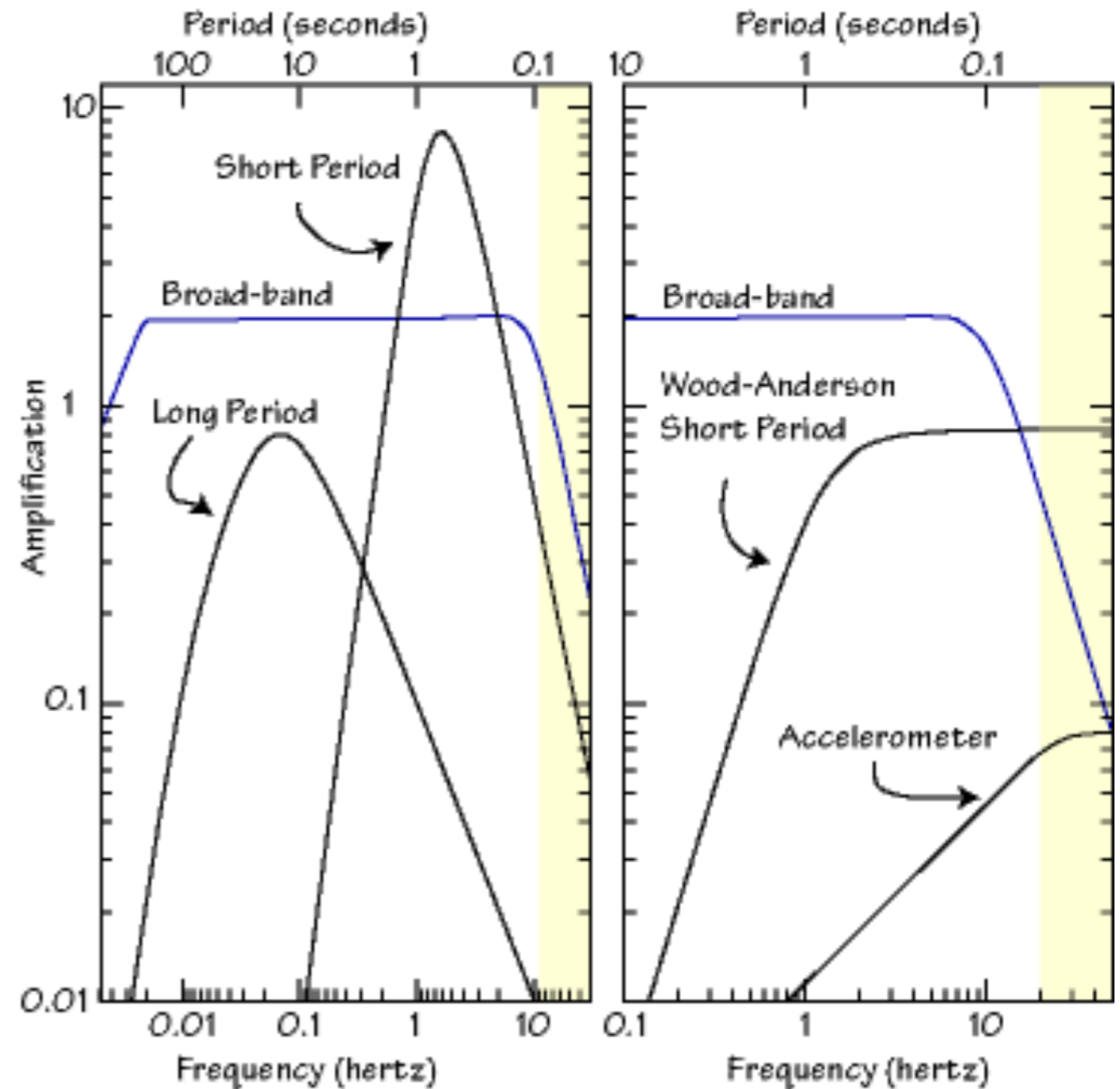


Example of Response Curves



The left panel is a comparison of a modern broadband seismometer response and the classic WWSSN long- and short-period instruments. The same broad-band response is shown in the right panel, to compare the response with a special short-period instrument, the Wood-Anderson, and an accelerometer.

The Wood-Anderson short-period instrument was the one that Charles Richter used to develop his magnitude scale for southern California. The accelerometer is an instrument designed to record large amplitude and high-frequency shaking near large earthquakes. Those are the vibrations that are important in building, highway, etc. design.



The broad band instrument senses most frequencies equally well; the long-period and short period instruments are called "narrow" band, because they preferentially sense frequencies near 1/(15 s) and 1 hertz respectively. The yellow region is the low end of the frequency range audible to most humans (we can hear waves around 20 hertz to 20,000 hertz).

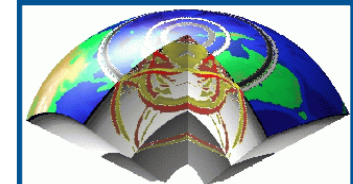
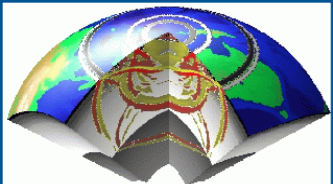


Figure 6.3-1: Definition of a linear system.

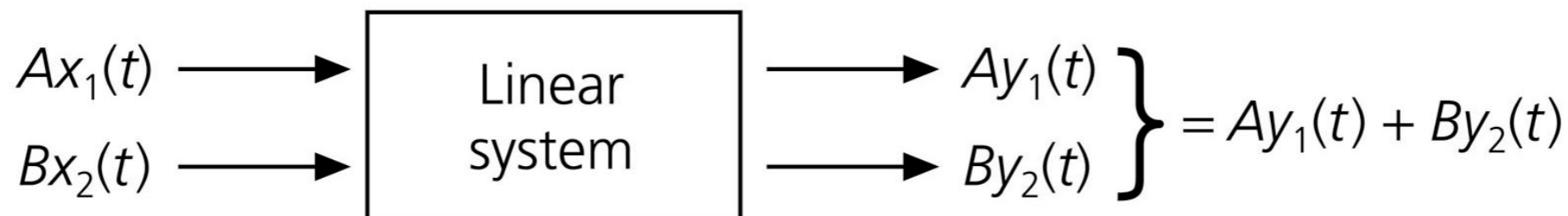
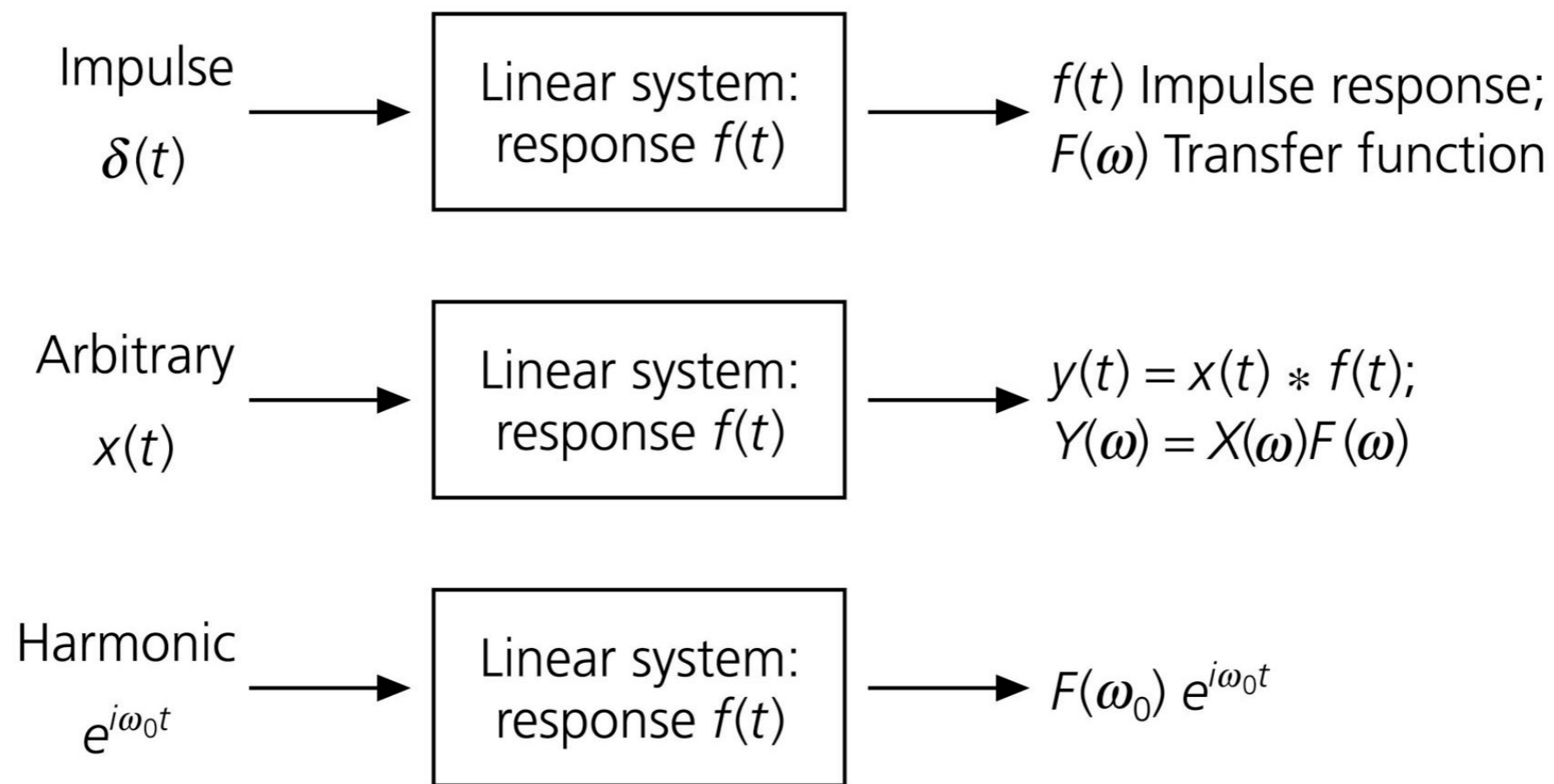
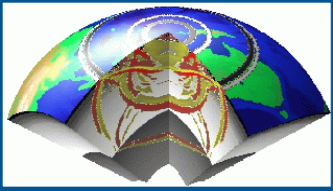


Figure 3.3-29: Seismic section before and after deconvolution.





Convolution theorem

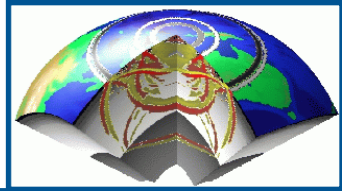
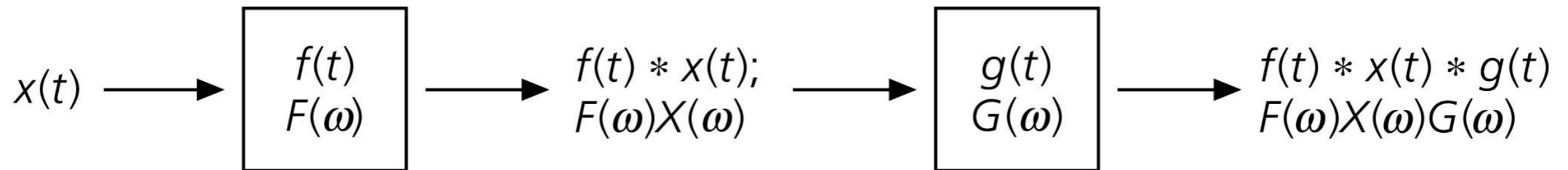
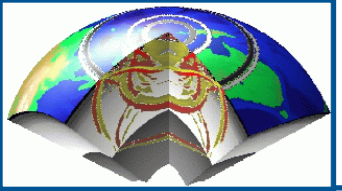


Figure 6.3-4: Two linear systems in succession.



The output of a linear system is the convolution of the input and the impulse response (Green's function)



Example: Seismograms

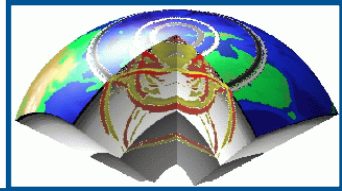
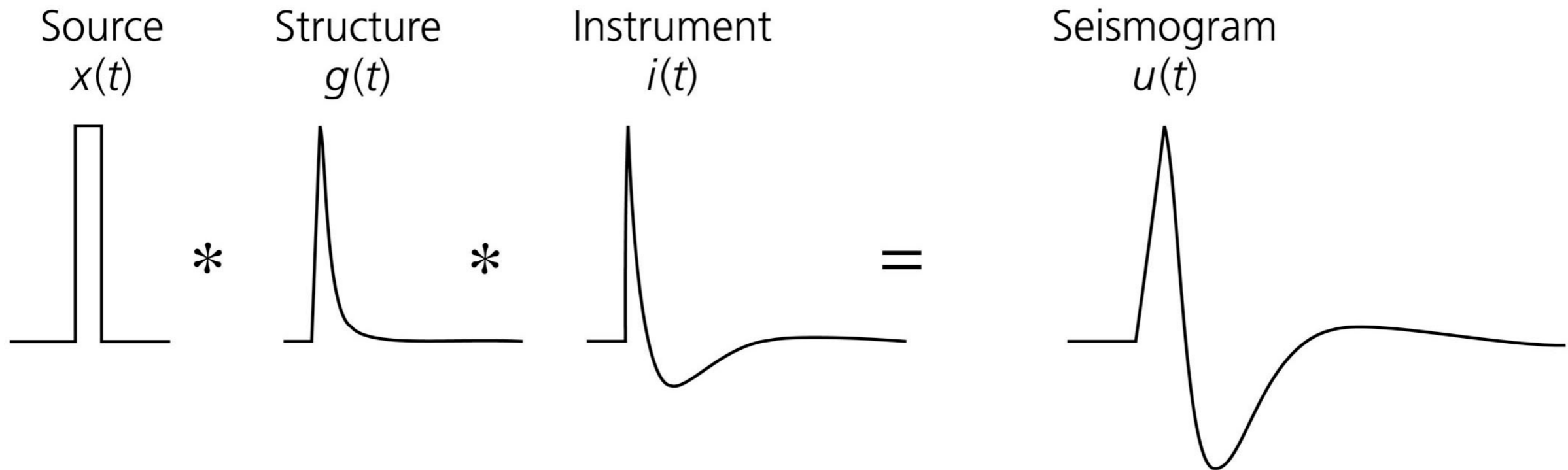
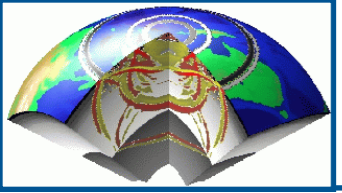


Figure 6.3-5: Seismogram as the convolution of the source, structure, and instrument signals.





A-D conversion

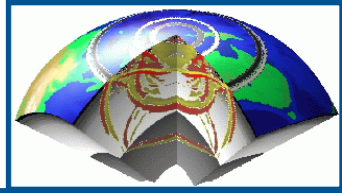
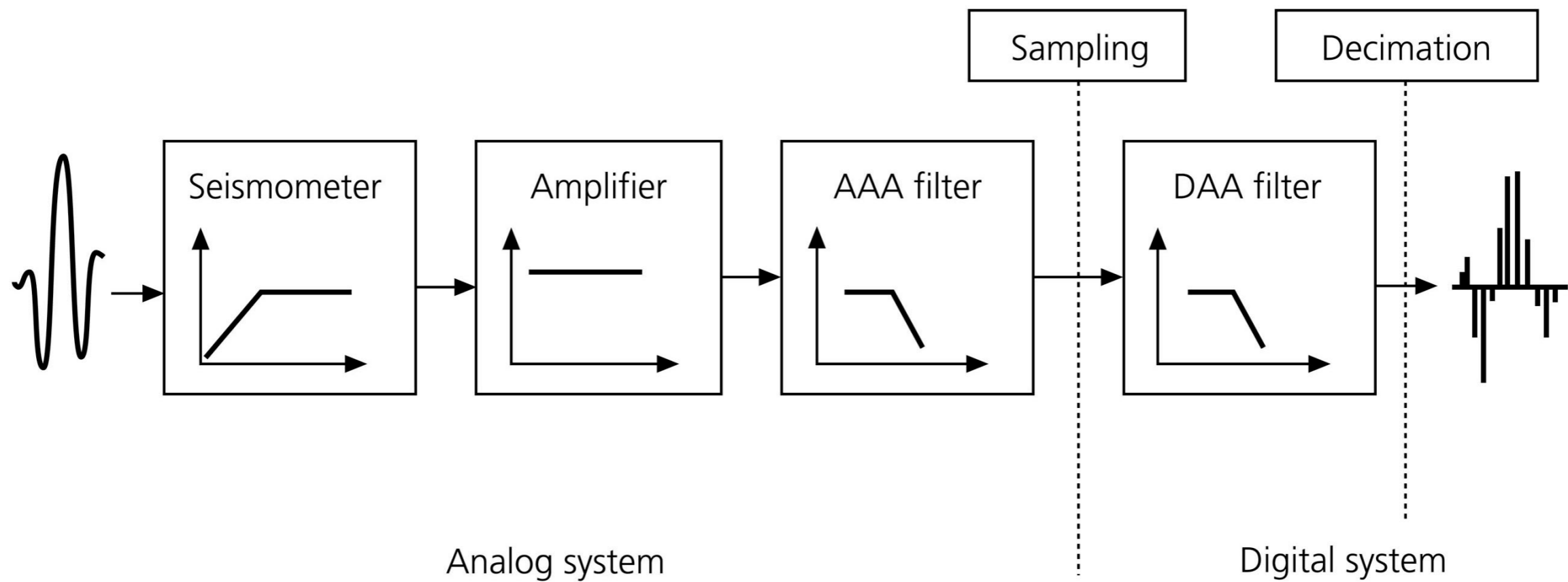
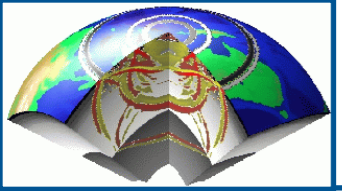


Figure 6.6-12: Diagram showing the analog-to-digital (ADC) process.

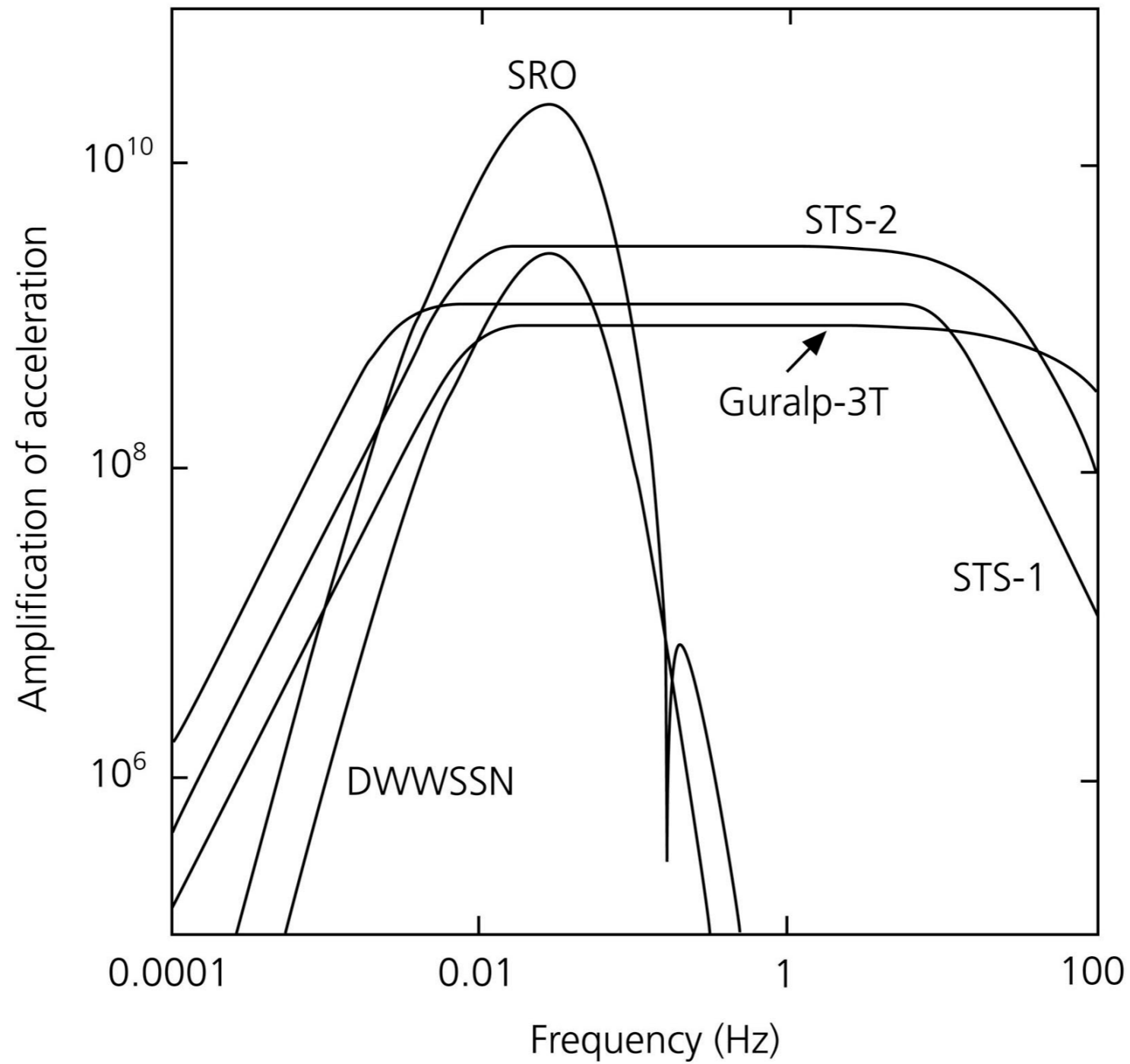




Response functions to correct ...

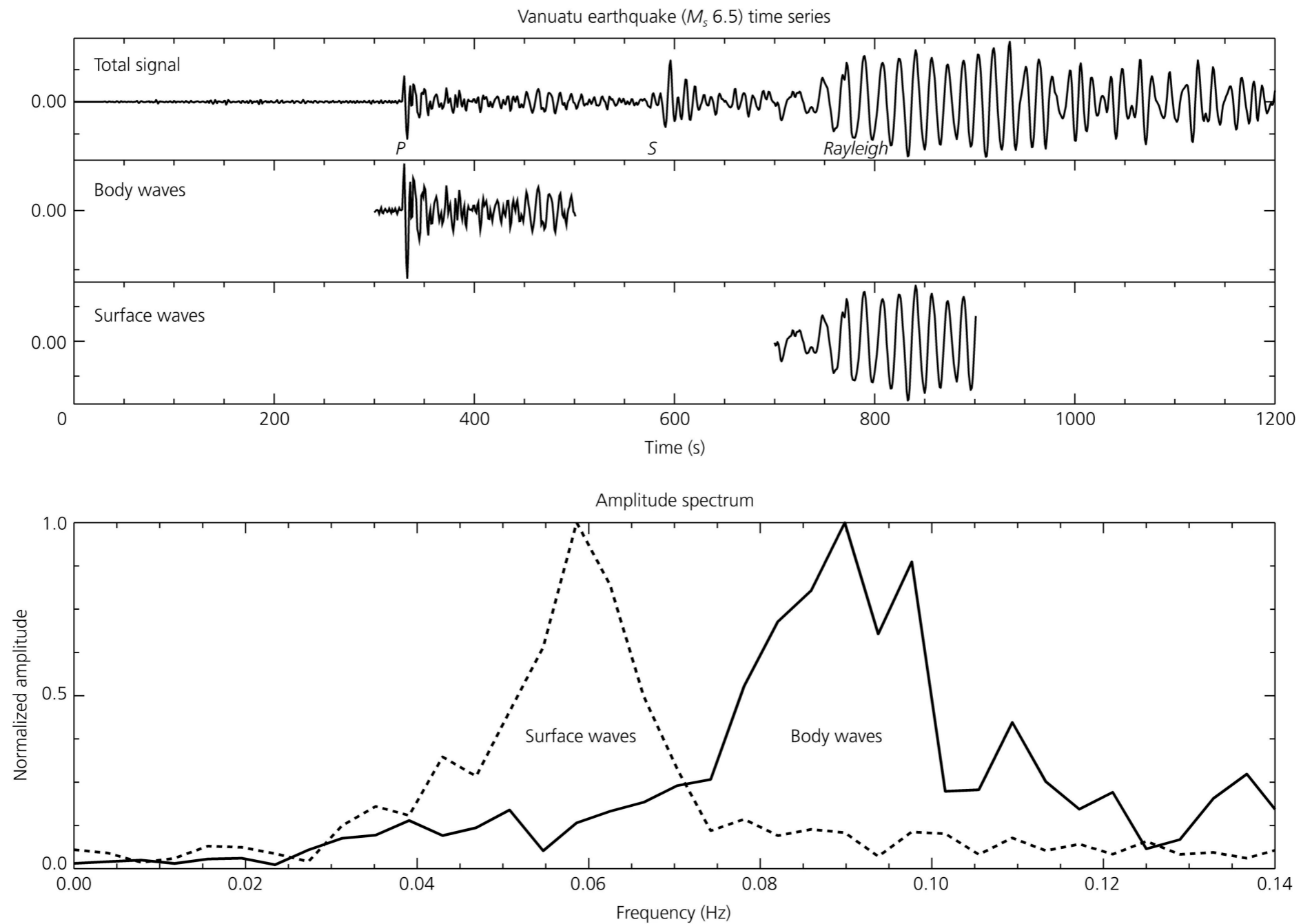


Figure 6.6-8: Instrument responses for several types of seismometers.



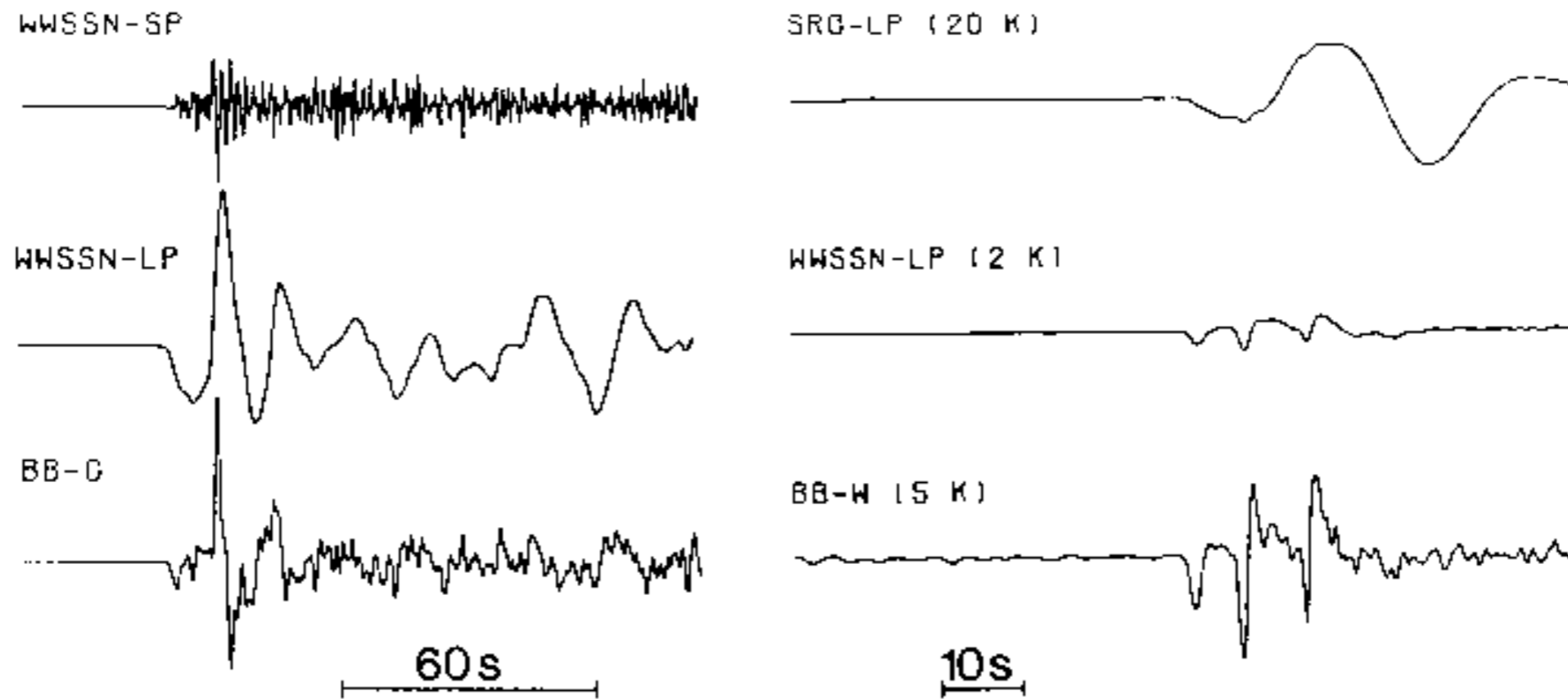
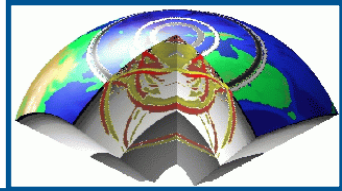
Frequencies in seismograms

Figure 6.2-3: Amplitude spectra for the body and surface wave segments from a large earthquake.





Example of Recordings - 1



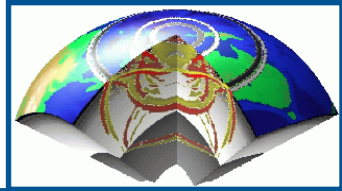
Comparison of seismograms obtained with different instrument responses

Left column: telesesimic P-wave from 1977 Bucharest event at Grafenberg station in Germany (BB=Broad Band).

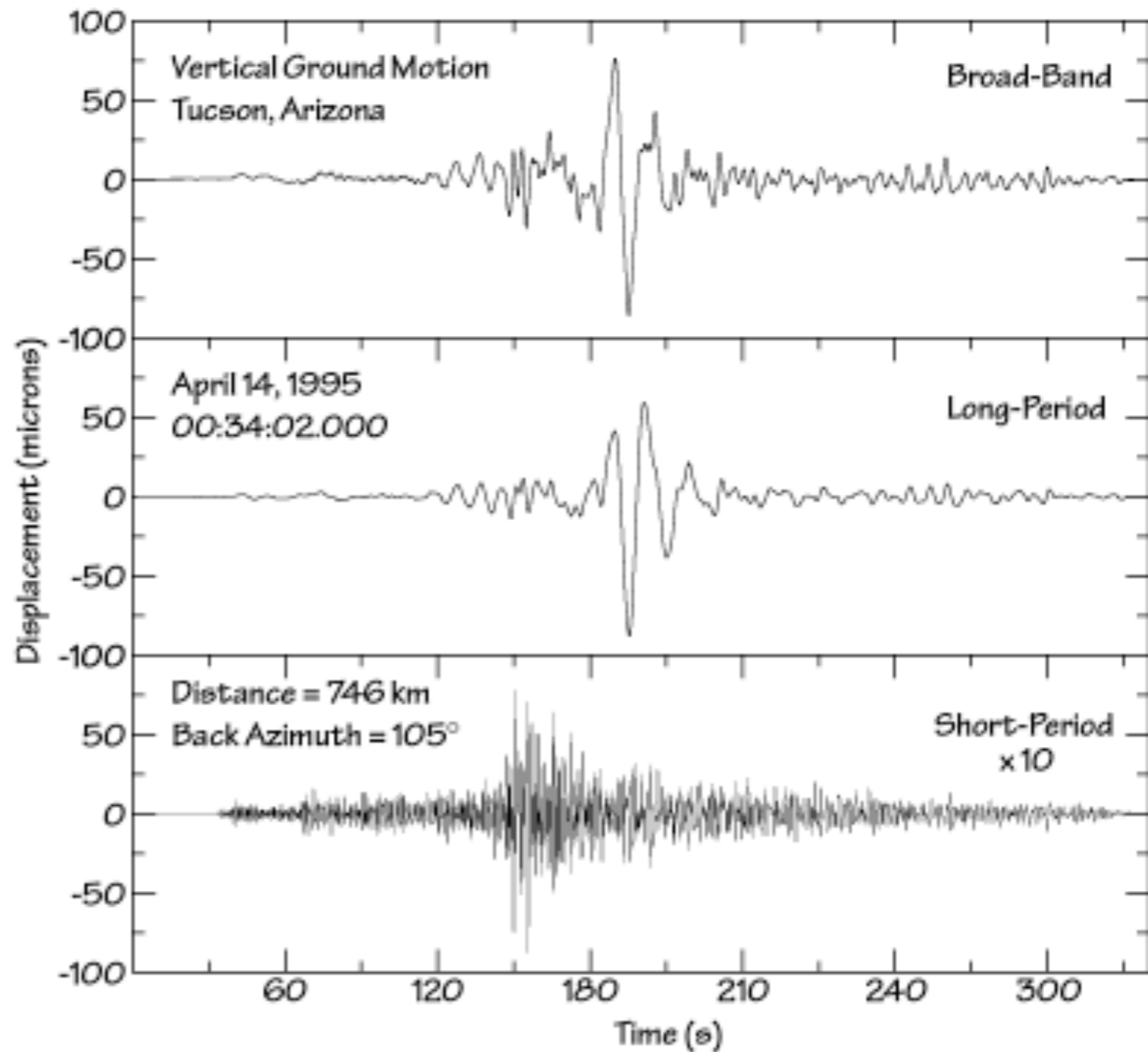
Right column: telesesimic P-wave from 1979 Fiji event at Grafenberg station in Germany.



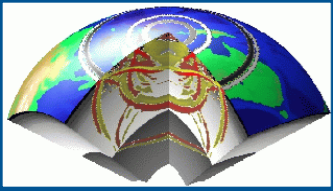
Example of Recordings - 2



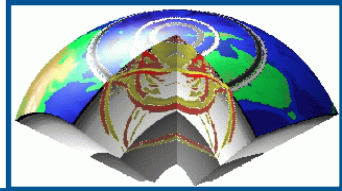
GROUND DISPLACEMENT
observed near Tucson,
Arizona, caused by an
earthquake in southwestern
Texas.



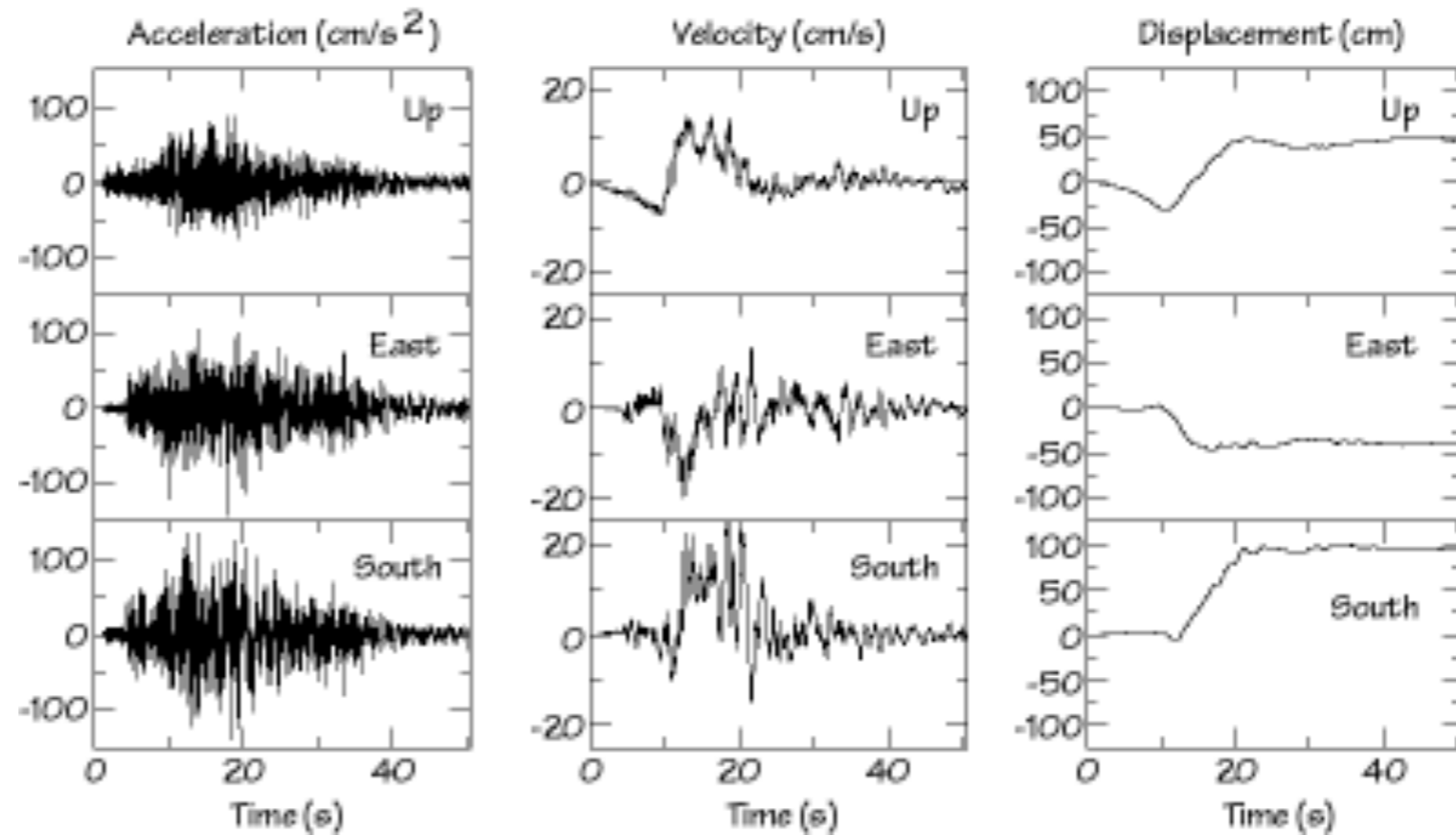
Top panel shows the vibrations measured using a **broad-band** seismometer, the middle panel shows the vibrations as they would be detected by the long-period sensor, and the bottom panel the vibrations that would be sensed by a **short-period** sensor (scaled by a factor of 10). The displacements are shown in microns, which are 1×10^{-6} m.



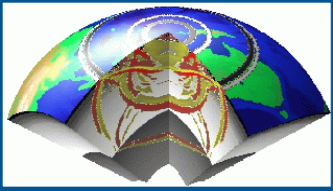
Example of Recordings - 3



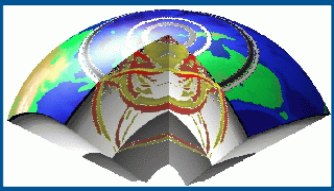
Ground acceleration, velocity and displacement, recorded at a strong-motion seismometer that was located directly above the part of a fault that ruptured during the 1985 Mw = 8.1, Michoacan, Mexico earthquake.



Strong-motion instruments were designed to record the high accelerations that are particularly important for designing buildings and other structures. The left panel is a plot of the three components of acceleration: strong, high-frequency shaking lasted almost a minute and the peak acceleration was about 150 cm/s^2 (or about $0.15g$). The middle panel shows the velocity of ground movement: the peak velocity for this site during that earthquake was about $20\text{--}25 \text{ cm/sec}$. Integrating the velocity, we can compute the displacement, which is shown in the right-most panel: the permanent offsets near the seismometer were up, west, and south, for a total distance of about 125 centimeters .

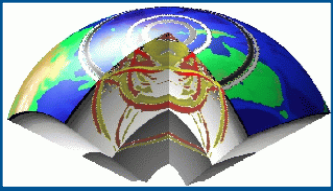


Strong motion seismology

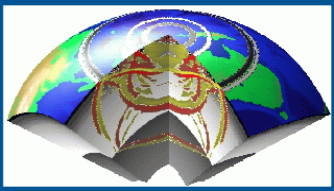


- Strong ground motion is an event in which an earthquake cause the ground to shake at least strongly enough for people to feel the motion or to damage or destroy man-made structures.
- The goal of strong motion seismology is to be able to understand and predict seismic motions sufficiently well that the predictions can be used for engineering applications
- The field of strong-motion seismology could initially be identified with a type of instrument, designed to remain on-scale and record the ground motion with fidelity under the conditions of the strongest ground motions experienced in earthquakes.

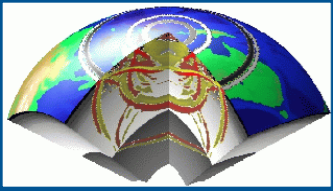
Anderson J.G Physical Processes That Control Strong Ground Motion. In: Gerald Schubert (editor-in-chief) Treatise on Geophysics, 2nd edition, Vol 4. Oxford: Elsevier; 2015. p. 505-557.



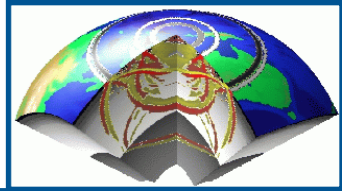
Strong motion seismology



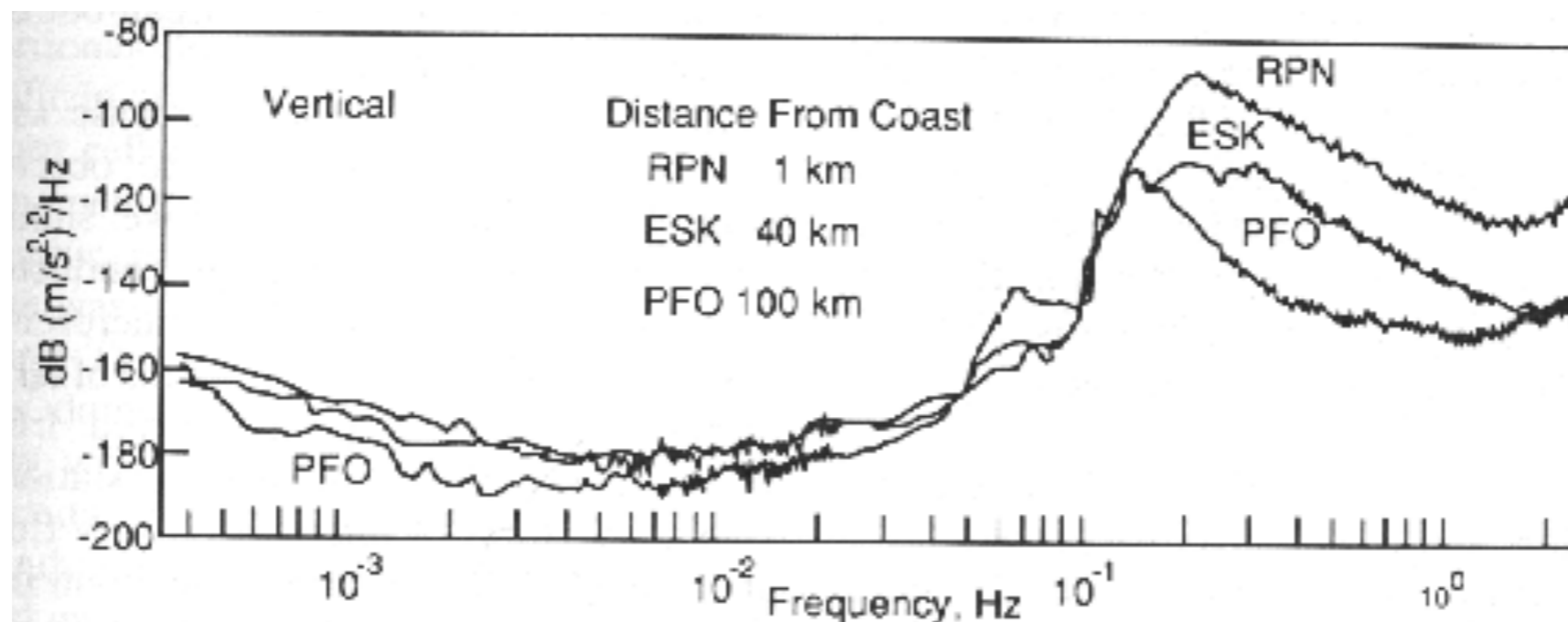
- Early instruments were typically designed so that ground motions up to the acceleration of gravity (**1g**) would be on-scale.
- The lower limit of ground motion considered by the early strong motion seismology studies was roughly defined by the thickness of the light beam read until the edge of a recorded film. The minimum acceleration resolved is somewhat less than **0.01g**, that approximately coincided with minimum ground motions that humans are able to feel.
- Since much smaller ground motions can be recorded on modern instruments, the distinction between strong-motion seismology and traditional seismology is blurred.



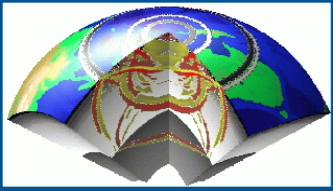
Seismic Noise



Seismic noise has many different causes. **Short-period** noise is at most sites predominantly manmade and somewhat larger in the horizontal components than in the vertical. At **intermediate periods** (2 to 20 s), marine microseisms dominate with similar amplitudes in the horizontal and vertical directions. At **long periods**, horizontal noise may be larger than vertical noise by a factor up to 300, the factor increasing with period. This is mainly due to tilt which couples gravity into the horizontal components but not into the vertical. Tilt may be caused by traffic, wind, or the barometric pressure.



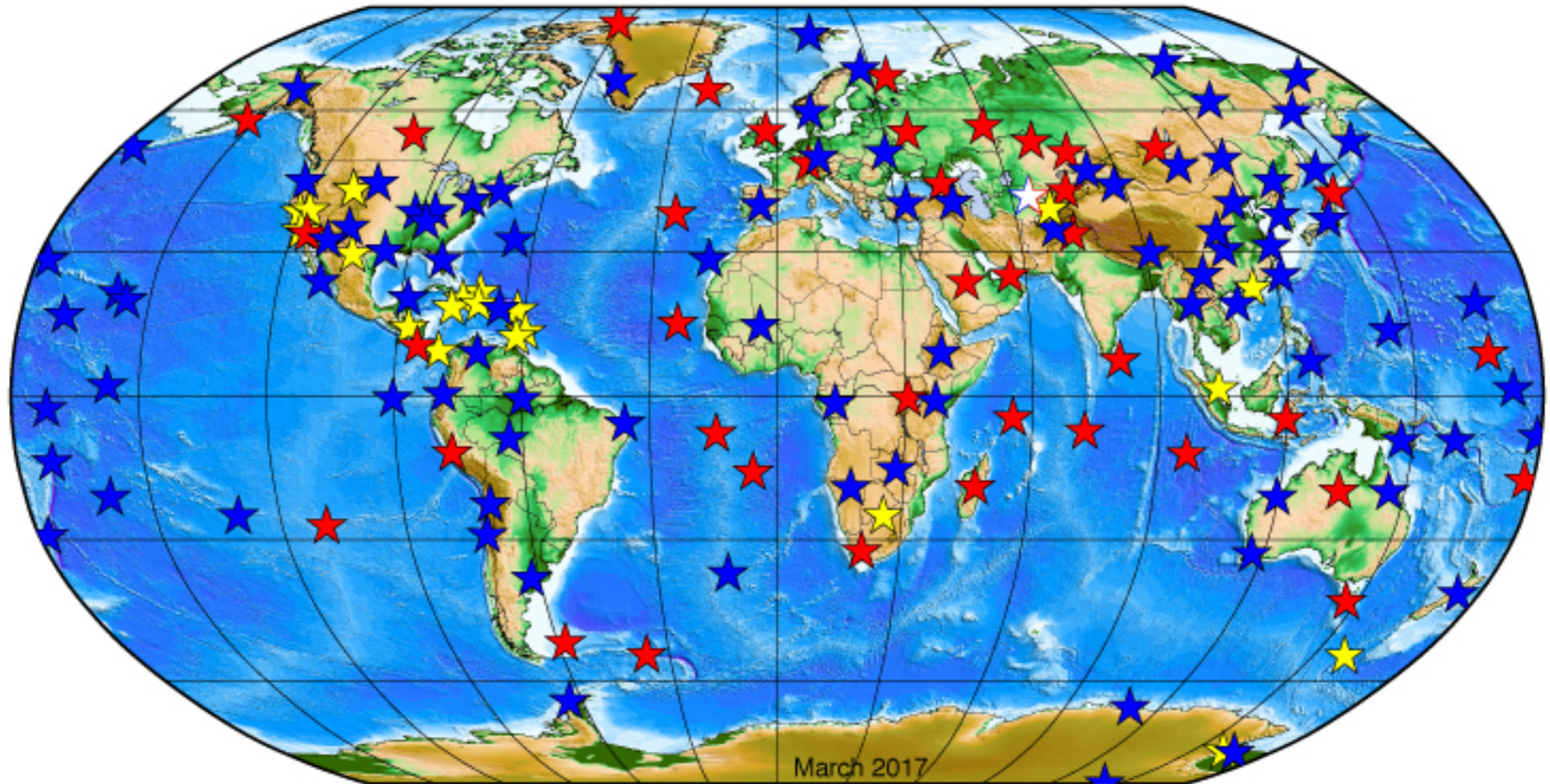
Observed seismic noise as a function of frequency (power spectrum). Note the peak at 0.2 Hz and decrease with distance from the coast.



Digital era



Beginning from the 1970's the analog recording systems (ink, photographic, tape) were substituted by digital recordings on magnetic tapes. These systems sample the output current from seismometer and amplifying circuit. SRO (Seismic Research Observatories) and digitally upgraded WWSSN made up the **GDSN** (Global Digital Seismic Network).

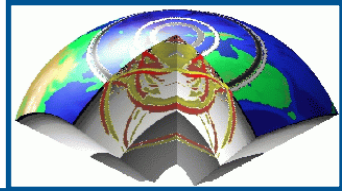


- ★ IRIS/IDA Stations
- ★ IRIS/USGS Stations
- ★ Affiliate Stations
- ★ Planned Stations

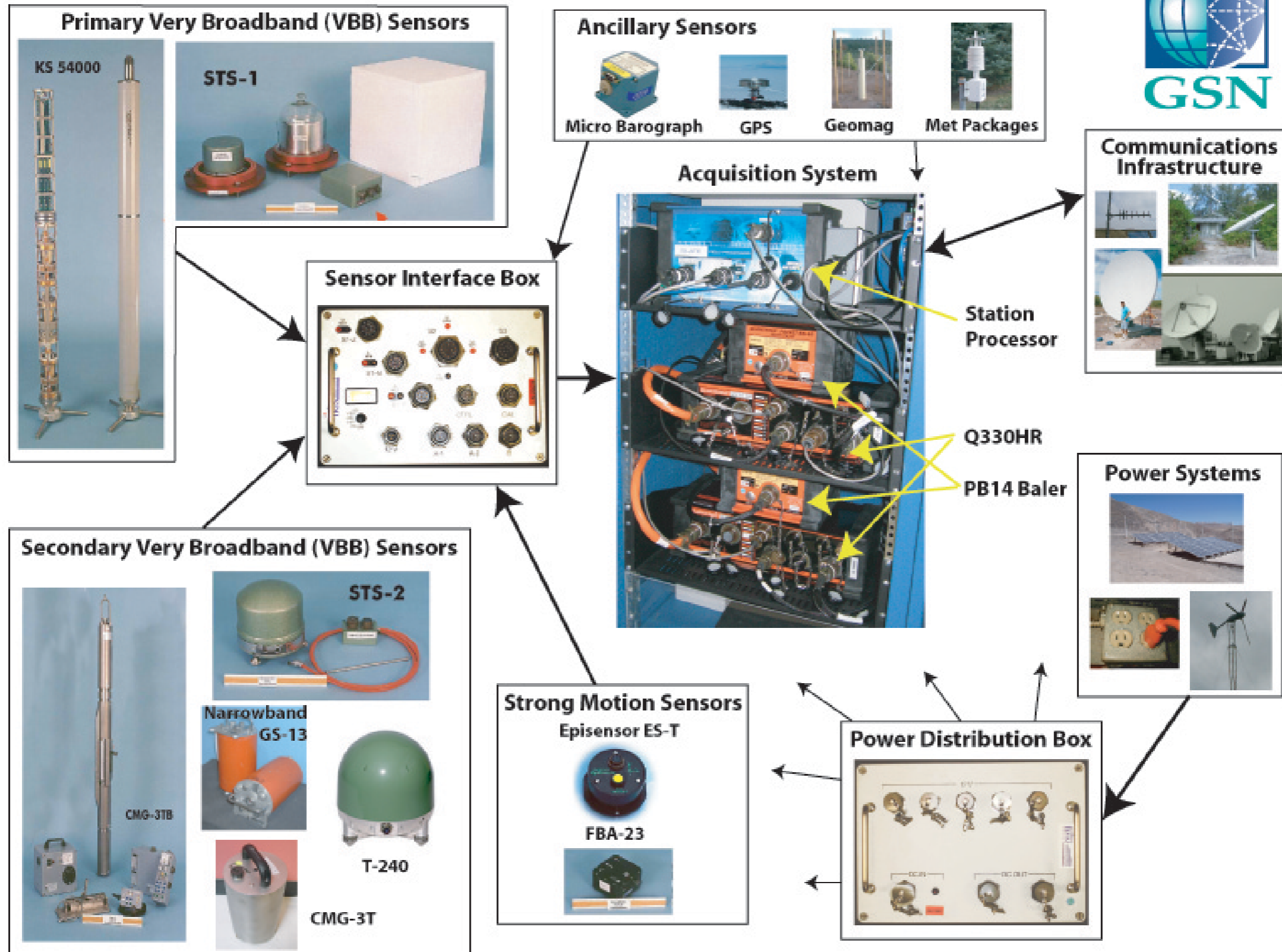
<http://www.iris.edu/hq/programs/gsn>



Modern seismic station

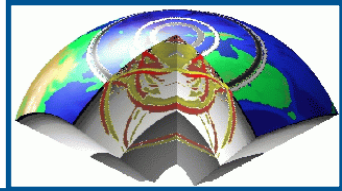


Components of the Next Generation GSN System





Array seismology

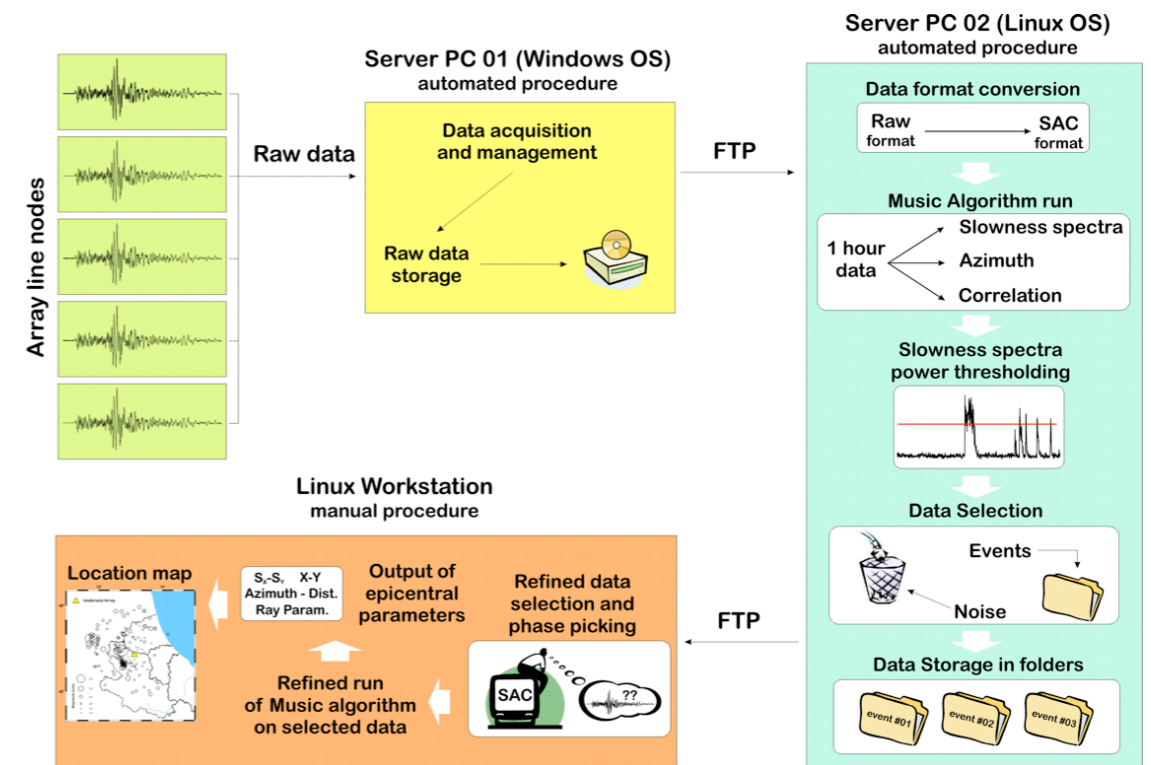
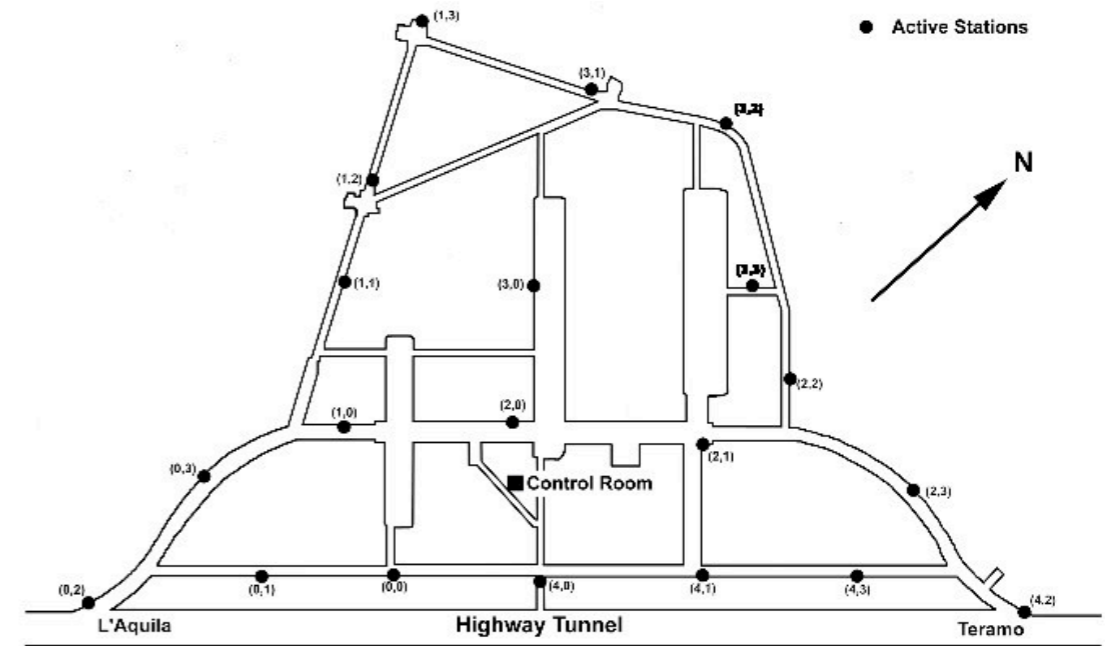


Animation of Wenchuan China Earthquake

Robert Woodward
IRIS

earth scope
www.earthscope.org
Cylindrical Projections and Evolutions of the North American Cordillera

www.earthscope.org

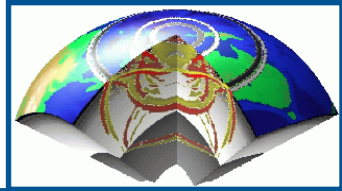


Project UNDERSEIS

http://www.iris.edu/hq/programs/education_and_outreach/visualizations/tutorial

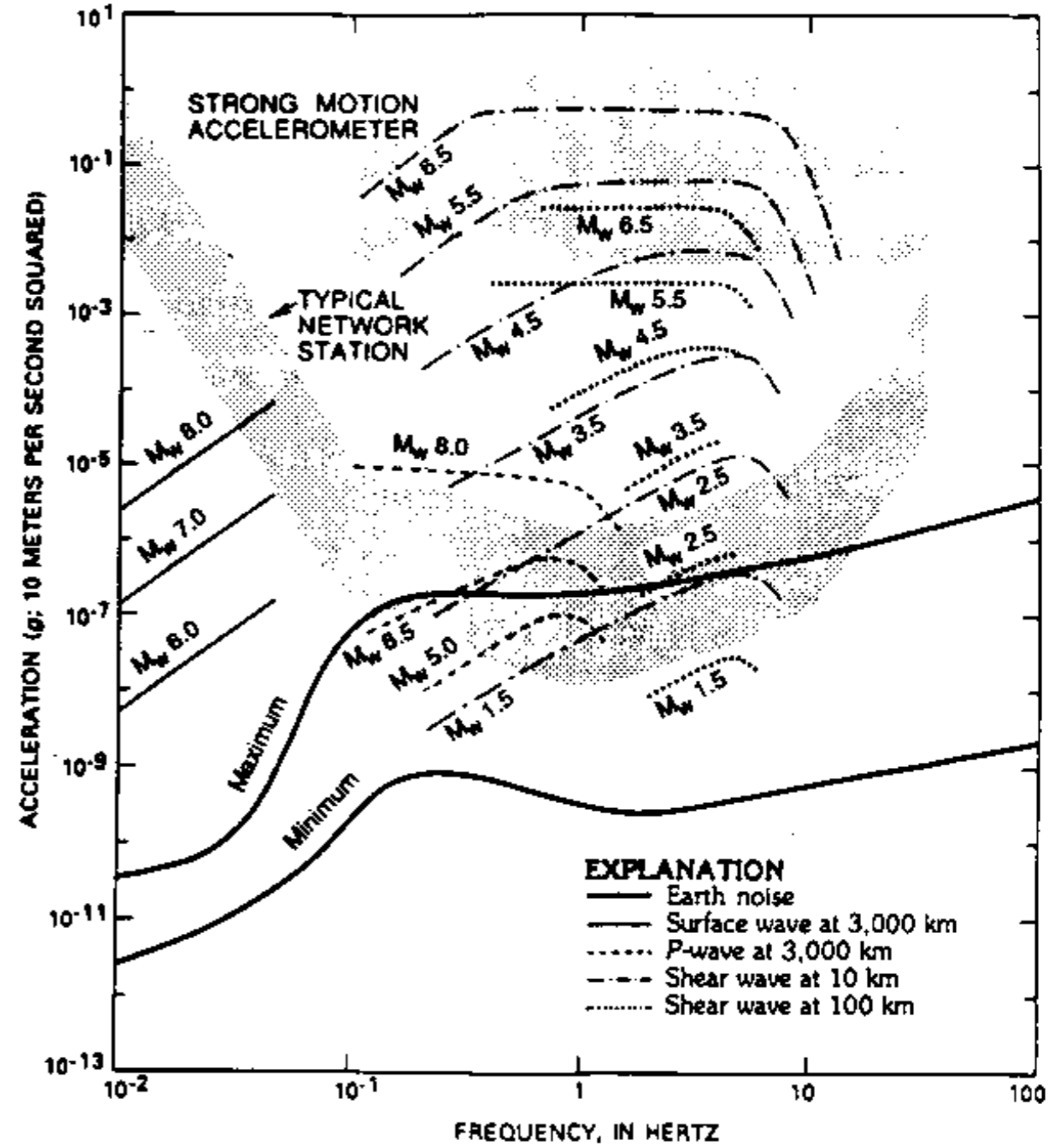
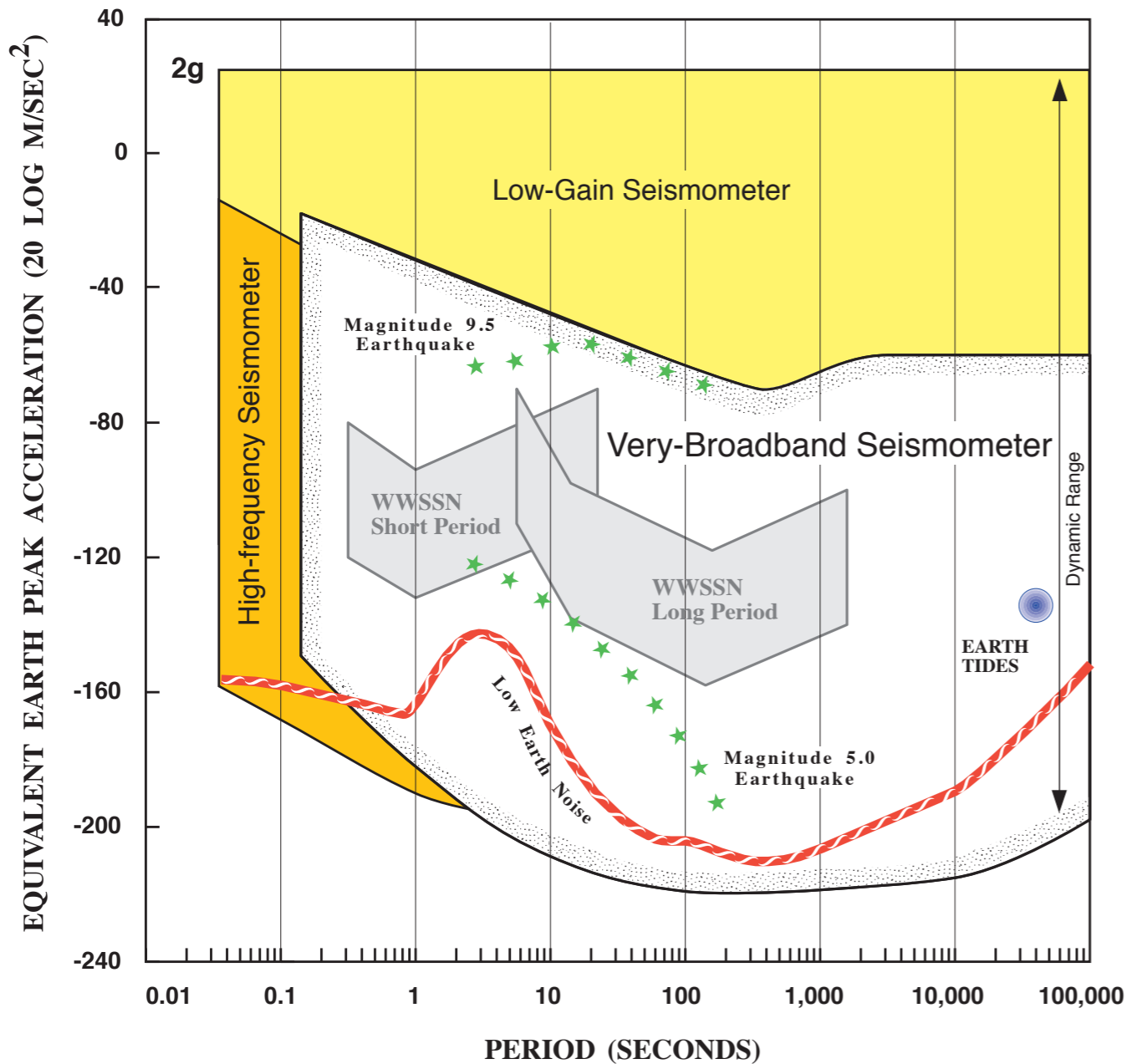


Acceleration Dynamic Range

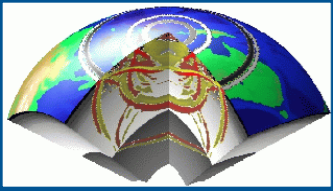


Idealized recording range of the GSN system. The approximate recording ranges of the WWSSN LP and SP channels are shown for comparison. Earthquake spectra from sources at 30 degrees distance were provided by H. Kanamori, California Institute of Technology. The lowest and highest acceleration levels shown are for an ideal combination of Very Broad Band (STS-1), High Frequency Broad Band, Low Gain Seismometers, and 24-bit digitizers.

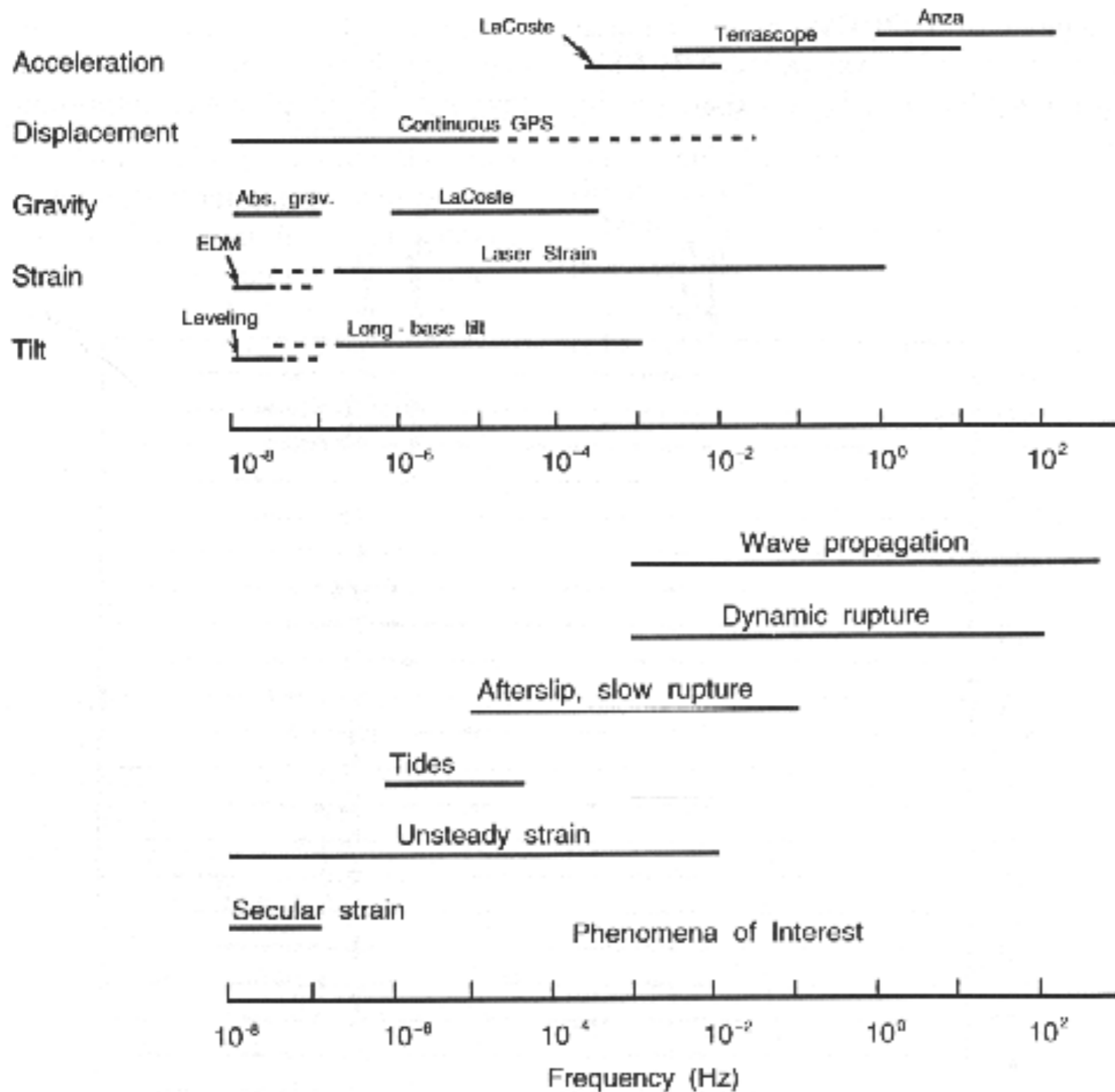
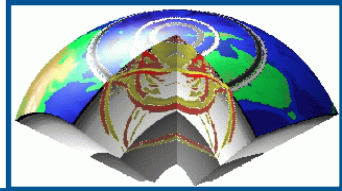
IRIS GSN SYSTEM



Comparison of accelerometer and regional-network recording capabilities relative to average noise level and ground accelerations caused by various size events at different distances.



Complete ground motion



Other, than transient, important ground motions have to be analyzed to understand dynamic Earth processes.

Specialized instruments are used to address displacement associated to **longer term processes** (e.g. gravitational changes associated with mass redistribution or gradual displacement along faults)

Various ground motion measurements and corresponding phenomena that can be studied with different instruments.