

1

FUNDAMENTALS OF RADIATIVE TRANSFER

1.1 THE ELECTROMAGNETIC SPECTRUM; ELEMENTARY PROPERTIES OF RADIATION

Electromagnetic radiation can be decomposed into a *spectrum* of constituent components by a prism, grating, or other devices, as was discovered quite early (Newton, 1672, with visible light). The spectrum corresponds to waves of various wavelengths and frequencies, related by $\lambda\nu = c$, where ν is the frequency of the wave, λ is its wavelength, and $c = 3.00 \times 10^{10}$ cm s⁻¹ is the free space velocity of light. (For waves not traveling in a vacuum, c is replaced by the appropriate velocity of the wave in the medium.) We can divide the spectrum up into various regions, as is done in Figure 1.1. For convenience we have given the energy $E = h\nu$ and temperature $T = E/k$ associated with each wavelength. Here h is Planck's constant = 6.625×10^{-27} erg s, and k is Boltzmann's constant = 1.38×10^{-16} erg K⁻¹. This chart will prove to be quite useful in converting units or in getting a quick view of the relevant magnitude of quantities in a given portion of the spectrum. The boundaries between different regions are somewhat arbitrary, but conform to accepted usage.

2 Fundamentals of Radiative Transfer

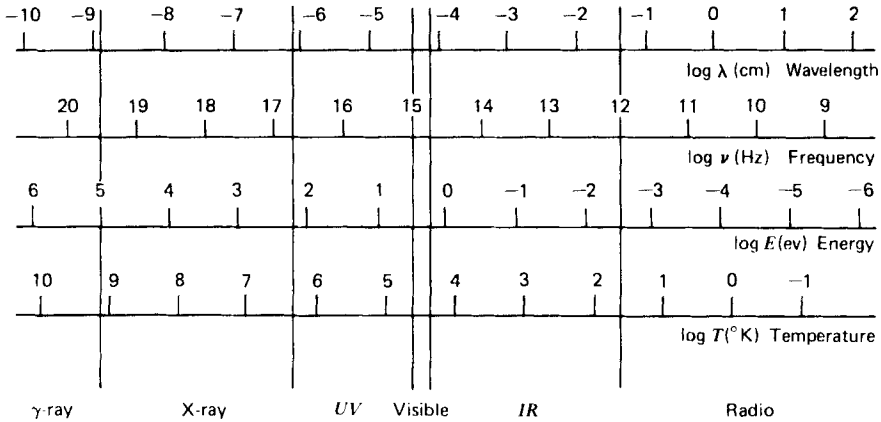

Figure 1.1 The electromagnetic spectrum.

1.2 RADIATIVE FLUX

Macroscopic Description of the Propagation of Radiation

When the scale of a system greatly exceeds the wavelength of radiation (e.g., light shining through a keyhole), we can consider radiation to travel in straight lines (called rays) in free space or homogeneous media—from this fact a substantial theory (transfer theory) can be erected. The detailed justification of this assumption is considered at the end of Chapter 2. One of the most primitive concepts is that of *energy flux*: consider an element of area dA exposed to radiation for a time dt . The amount of energy passing through the element should be proportional to $dA dt$, and we write it as $F dA dt$. The energy flux F is usually measured in $\text{erg s}^{-1} \text{cm}^{-2}$. Note that F can depend on the orientation of the element.

Flux from an Isotropic Source—the Inverse Square Law

A source of radiation is called *isotropic* if it emits energy equally in all directions. An example would be a spherically symmetric, isolated star. If we put imaginary spherical surfaces S_1 and S at radii r_1 and r , respectively, about the source, we know by conservation of energy that the total energy passing through S_1 must be the same as that passing through S . (We assume no energy losses or gains between S_1 and S .) Thus

$$F(r_1) \cdot 4\pi r_1^2 = F(r) \cdot 4\pi r^2,$$

or

$$F(r) = \frac{F(r_1)r_1^2}{r^2}.$$

If we regard the sphere S_1 as fixed, then

$$F = \frac{\text{constant}}{r^2}. \tag{1.1}$$

This is merely a statement of conservation of energy.

1.3 THE SPECIFIC INTENSITY AND ITS MOMENTS

Definition of Specific Intensity or Brightness

The flux is a measure of the energy carried by *all rays* passing through a given area. A considerably more detailed description of radiation is to give the energy carried along by *individual rays*. The first point to realize, however, is that a single ray carries essentially no energy, so that we need to consider the energy carried by sets of rays, which differ infinitesimally from the given ray. The appropriate definition is the following: Construct an area dA normal to the direction of the given ray and consider all rays passing through dA whose direction is within a solid angle $d\Omega$ of the given ray (see Fig. 1.2). The energy crossing dA in time dt and in frequency range $d\nu$ is then defined by the relation

$$dE = I_\nu dA dt d\Omega d\nu, \tag{1.2}$$

where I_ν is the *specific intensity* or *brightness*. The specific intensity has the

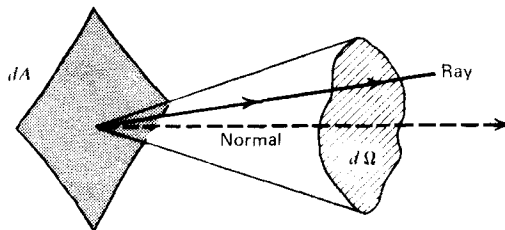

Figure 1.2 Geometry for normally incident rays.

4 Fundamentals of Radiative Transfer

dimensions

$$I_\nu(\nu, \Omega) = \text{energy (time)}^{-1} (\text{area})^{-1} (\text{solid angle})^{-1} (\text{frequency})^{-1} \\ = \text{ergs s}^{-1} \text{ cm}^{-2} \text{ ster}^{-1} \text{ Hz}^{-1}.$$

Note that I_ν depends on location in space, on direction, and on frequency.

Net Flux and Momentum Flux

Suppose now that we have a radiation field (rays in all directions) and construct a small element of area dA at some arbitrary orientation \mathbf{n} (see Fig. 1.3). Then the differential amount of flux from the solid angle $d\Omega$ is (reduced by the lowered effective area $\cos\theta dA$)

$$dF_\nu(\text{erg s}^{-1} \text{ cm}^{-2} \text{ Hz}^{-1}) = I_\nu \cos\theta d\Omega. \quad (1.3a)$$

The *net flux* in the direction \mathbf{n} , $F_\nu(\mathbf{n})$ is obtained by integrating dF over all solid angles:

$$F_\nu = \int I_\nu \cos\theta d\Omega. \quad (1.3b)$$

Note that if I_ν is an isotropic radiation field (not a function of angle), then the net flux is *zero*, since $\int \cos\theta d\Omega = 0$. That is, there is just as much energy crossing dA in the \mathbf{n} direction as the $-\mathbf{n}$ direction.

To get the flux of momentum normal to dA (momentum per unit time per unit area = pressure), remember that the momentum of a photon is E/c . Then the momentum flux along the ray at angle θ is dF_ν/c . To get

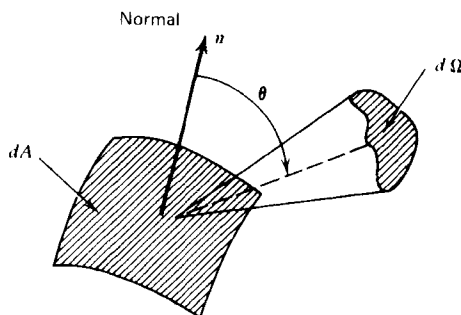

Figure 1.3 Geometry for obliquely incident rays.

the component of momentum flux normal to dA , we multiply by another factor of $\cos\theta$. Integrating, we then obtain

$$p_\nu(\text{dynes cm}^{-2} \text{ Hz}^{-1}) = \frac{1}{c} \int I_\nu \cos^2\theta d\Omega. \quad (1.4)$$

Note that F_ν and p_ν are *moments* (multiplications by powers of $\cos\theta$ and integration over $d\Omega$) of the intensity I_ν . Of course, we can always integrate over frequency to obtain the total (integrated) flux and the like.

$$F(\text{erg s}^{-1} \text{ cm}^{-2}) = \int F_\nu d\nu \quad (1.5a)$$

$$p(\text{dynes cm}^{-2}) = \int p_\nu d\nu \quad (1.5b)$$

$$I(\text{erg s}^{-1} \text{ cm}^{-2} \text{ ster}^{-1}) = \int I_\nu d\nu \quad (1.5c)$$

Radiative Energy Density

The specific energy density u_ν is defined as the energy per unit volume per unit frequency range. To determine this it is convenient to consider first the energy density per unit solid angle $u_\nu(\Omega)$ by $dE = u_\nu(\Omega) dV d\Omega d\nu$ where dV is a volume element. Consider a cylinder about a ray of length ct (Fig. 1.4). Since the volume of the cylinder is $dAc dt$,

$$dE = u_\nu(\Omega) dAc dt d\Omega d\nu.$$

Radiation travels at velocity c , so that in time dt all the radiation in the cylinder will pass out of it:

$$dE = I_\nu dA d\Omega dt d\nu.$$

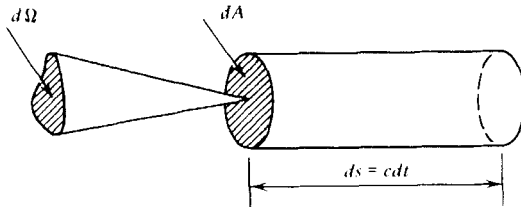

Figure 1.4 Electromagnetic energy in a cylinder.

6 Fundamentals of Radiative Transfer

Equating the above two expressions yields

$$u_\nu(\Omega) = \frac{I_\nu}{c}. \quad (1.6)$$

Integrating over all solid angles we have

$$u_\nu = \int u_\nu(\Omega) d\Omega = \frac{1}{c} \int I_\nu d\Omega,$$

or

$$u_\nu = \frac{4\pi}{c} J_\nu, \quad (1.7)$$

where we have defined the *mean intensity* J_ν :

$$J_\nu = \frac{1}{4\pi} \int I_\nu d\Omega. \quad (1.8)$$

The total radiation density (erg cm⁻³) is simply obtained by integrating u_ν over all frequencies

$$u = \int u_\nu d\nu = \frac{4\pi}{c} \int J_\nu d\nu. \quad (1.9)$$

Radiation Pressure in an Enclosure Containing an Isotropic Radiation Field

Consider a reflecting enclosure containing an isotropic radiation field. Each photon transfers *twice* its normal component of momentum on reflection. Thus we have the relation

$$p_\nu = \frac{2}{c} \int I_\nu \cos^2 \theta d\Omega.$$

This agrees with our previous formula, Eq. (1.4), since here we integrate only over 2π steradians. Now, by isotropy, $I_\nu = J_\nu$, so

$$p = \frac{2}{c} \int J_\nu d\nu \int \cos^2 \theta d\Omega.$$

The angular integration yields

$$p = \frac{1}{3} u. \quad (1.10)$$

The radiation pressure of an isotropic radiation field is one-third the energy density. This result will be useful in discussing the thermodynamics of blackbody radiation.

Constancy of Specific Intensity Along Rays in Free Space

Consider any ray L and any two points along the ray. Construct areas dA_1 and dA_2 normal to the ray at these points. We now make use of the fact that energy is conserved. Consider the energy carried by that set of rays passing through both dA_1 and dA_2 (see Fig. 1.5). This can be expressed in two ways:

$$dE_1 = I_{\nu_1} dA_1 dt d\Omega_1 dv_1 = dE_2 = I_{\nu_2} dA_2 dt d\Omega_2 dv_2.$$

Here $d\Omega_1$ is the solid angle subtended by dA_2 at dA_1 and so forth. Since $d\Omega_1 = dA_2/R^2$, $d\Omega_2 = dA_1/R^2$ and $dv_1 = dv_2$, we have

$$I_{\nu_1} = I_{\nu_2}.$$

Thus the intensity is constant along a ray:

$$I_\nu = \text{constant.} \tag{1.11}$$

Another way of stating the above result is by the differential relation

$$\frac{dI_\nu}{ds} = 0, \tag{1.12}$$

where ds is a differential element of length along the ray.

Proof of the Inverse Square Law for a Uniformly Bright Sphere

To show that there is no conflict between the constancy of specific intensity and the inverse square law, let us calculate the flux at an arbitrary

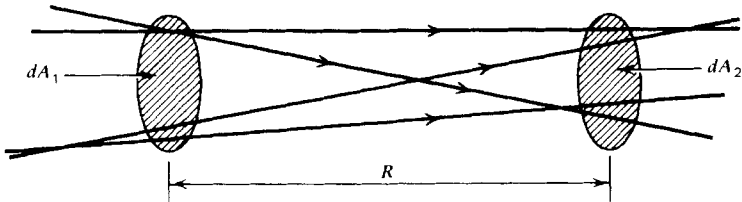

Figure 1.5 Constancy of intensity along rays.

8 Fundamentals of Radiative Transfer

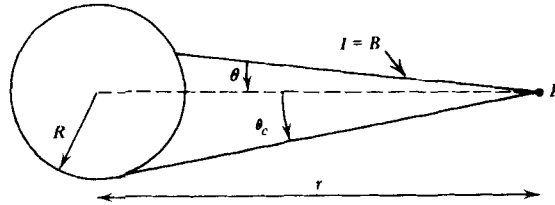

Figure 1.6 Flux from a uniformly bright sphere.

distance from a sphere of uniform brightness B (that is, all rays leaving the sphere have the same brightness). Such a sphere is clearly an isotropic source. At P , the specific intensity is B if the ray intersects the sphere and zero otherwise (see Fig. 1.6). Then,

$$F = \int I \cos \theta \, d\Omega = B \int_0^{2\pi} d\phi \int_0^{\theta_c} \sin \theta \cos \theta \, d\theta,$$

where $\theta_c = \sin^{-1} R/r$ is the angle at which a ray from P is tangent to the sphere. It follows that

$$F = \pi B (1 - \cos^2 \theta_c) = \pi B \sin^2 \theta_c$$

or

$$F = \pi B \left(\frac{R}{r} \right)^2. \quad (1.13)$$

Thus the specific intensity is constant, but the solid angle subtended by the given object decreases in such a way that the inverse square law is recovered.

A useful result is obtained by setting $r = R$:

$$F = \pi B. \quad (1.14)$$

That is, the flux at a surface of uniform brightness B is simply πB .

1.4 RADIATIVE TRANSFER

If a ray passes through matter, energy may be added or subtracted from it by emission or absorption, and the specific intensity will not in general remain constant. "Scattering" of photons into and out of the beam can also affect the intensity, and is treated later in §1.7 and 1.8.

Emission

The spontaneous *emission coefficient* j is defined as the energy emitted per unit time per unit solid angle and per unit volume:

$$dE = j dV d\Omega dt.$$

A monochromatic emission coefficient can be similarly defined so that

$$dE = j_\nu dV d\Omega dt d\nu, \quad (1.15)$$

where j_ν has units of $\text{erg cm}^{-3} \text{s}^{-1} \text{ster}^{-1} \text{Hz}^{-1}$.

In general, the emission coefficient depends on the direction into which emission takes place. For an *isotropic* emitter, or for a distribution of randomly oriented emitters, we can write

$$j_\nu = \frac{1}{4\pi} P_\nu, \quad (1.16)$$

where P_ν is the radiated power per unit volume per unit frequency. Sometimes the spontaneous emission is defined by the (angle integrated) *emissivity* ϵ_ν , defined as the energy emitted spontaneously per unit frequency per unit time per unit mass, with units of $\text{erg gm}^{-1} \text{s}^{-1} \text{Hz}^{-1}$. If the emission is isotropic, then

$$dE = \epsilon_\nu \rho dV dt d\nu \frac{d\Omega}{4\pi}, \quad (1.17)$$

where ρ is the mass density of the emitting medium and the last factor takes into account the *fraction* of energy radiated into $d\Omega$. Comparing the above two expressions for dE , we have the relation between ϵ_ν and j_ν :

$$j_\nu = \frac{\epsilon_\nu \rho}{4\pi}, \quad (1.18)$$

holding for isotropic emission. In going a distance ds , a beam of cross section dA travels through a volume $dV = dA ds$. Thus the intensity added to the beam by spontaneous emission is:

$$dI_\nu = j_\nu ds. \quad (1.19)$$

Absorption

We define the *absorption coefficient*, $\alpha_\nu (\text{cm}^{-1})$ by the following equation, representing the loss of intensity in a beam as it travels a distance ds (by

10 Fundamentals of Radiative Transfer

convention, α_ν positive for energy taken out of beam):

$$dI_\nu = -\alpha_\nu I_\nu ds. \quad (1.20)$$

This phenomenological law can be understood in terms of a microscopic model in which particles with density n (number per unit volume) each present an effective absorbing area, or *cross section*, of magnitude σ_ν (cm^2). These absorbers are assumed to be distributed at random. Let us consider the effect of these absorbers on radiation through dA within solid angle $d\Omega$ (see Fig. 1.7). The number of absorbers in the element equals $n dA ds$. The total absorbing area presented by absorbers equals $n\sigma_\nu dA ds$. The energy absorbed out of the beam is

$$-dI_\nu dA d\Omega dt dv = I_\nu (n\sigma_\nu dA ds) d\Omega dt dv;$$

thus

$$dI_\nu = -n\sigma_\nu I_\nu ds,$$

which is precisely the above phenomenological law (1.20), where

$$\alpha_\nu = n\sigma_\nu. \quad (1.21)$$

Often α_ν is written as

$$\alpha_\nu = \rho\kappa_\nu, \quad (1.22)$$

where ρ is the mass density and κ_ν ($\text{cm}^2 \text{g}^{-1}$) is called the *mass absorption coefficient*; κ_ν is also sometimes called the *opacity coefficient*.

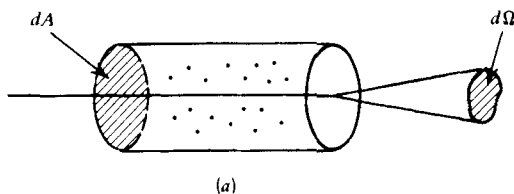

Figure 1.7a Ray passing through a medium of absorbers.

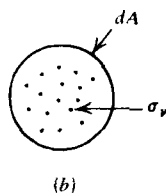

Figure 1.7b Cross sectional view of 7a.

There are some conditions of validity for this microscopic picture: The most important are that (1) the linear scale of the cross section must be small in comparison to the mean interparticle distance d . Thus $\sigma_v^{1/2} \ll d \sim n^{-1/3}$, from which follows $\alpha_v d \ll 1$ and (2) the absorbers are independent and randomly distributed. Fortunately, these conditions are almost always met for astrophysical problems.

As is shown in §1.6, we consider “absorption” to include both “true absorption” and stimulated emission, because both are proportional to the intensity of the incoming beam (unlike spontaneous emission). Thus the *net absorption* may be positive or negative, depending on whether “true absorption” or stimulated emission dominates. Although this combination may seem artificial, it will prove convenient and obviate the need for a quantum mechanical addition to our classical formulas later on.

The Radiative Transfer Equation

We can now incorporate the effects of emission and absorption into a single equation giving the variation of specific intensity along a ray. From the above expressions for emission and absorption, we have the combined expression

$$\frac{dI_\nu}{ds} = -\alpha_\nu I_\nu + j_\nu. \quad (1.23)$$

The transfer equation provides a useful formalism within which to solve for the intensity in an emitting and absorbing medium. It incorporates most of the macroscopic aspects of radiation into one equation, relating them to two coefficients α_ν and j_ν . A primary task in later chapters of this book is to find forms for these coefficients corresponding to particular physical processes.

Once α_ν and j_ν are known it is relatively easy to solve the transfer equation for the specific intensity. When scattering is present, solution of the radiative transfer equation is more difficult, because emission into $d\Omega$ depends on I_ν in solid angles $d\Omega'$, integrated over the latter (scattering from $d\Omega'$ into $d\Omega$). The transfer equation then becomes an integrodifferential equation, which generally must be solved partly by numerical techniques. (See §1.7 and 1.8.)

A formal solution to the complete radiative transfer equation will be given shortly. Here, we can give solutions to two simple limiting cases:

1—Emission Only: $\alpha_\nu = 0$. In this case, we have

$$\frac{dI_\nu}{ds} = j_\nu,$$

12 Fundamentals of Radiative Transfer

which has the solution

$$I_\nu(s) = I_\nu(s_0) + \int_{s_0}^s j_\nu(s') ds'. \quad (1.24)$$

The increase in brightness is equal to the emission coefficient integrated along the line of sight.

2—Absorption Only: $j_\nu = 0$. In this case, we have

$$\frac{dI_\nu}{ds} = -\alpha_\nu I_\nu,$$

which has the solution

$$I_\nu(s) = I_\nu(s_0) \exp\left[-\int_{s_0}^s \alpha_\nu(s') ds'\right]. \quad (1.25)$$

The brightness decreases along the ray by the exponential of the absorption coefficient integrated along the line of sight.

Optical Depth and Source Function

The transfer equation takes a particularly simple form if, instead of s , we use another variable τ_ν , called the *optical depth*, defined by

$$d\tau_\nu = \alpha_\nu ds,$$

or

$$\tau_\nu(s) = \int_{s_0}^s \alpha_\nu(s') ds'. \quad (1.26)$$

The optical depth defined above is measured along the path of a traveling ray; occasionally, τ_ν is measured backward along the ray and a minus sign appears in Eq. (1.26). In plane-parallel media, a standard optical depth is sometimes used to measure distance normal to the surface, so that ds is replaced by dz and $\tau_\nu = \tau_\nu(z)$. We shall distinguish between these two definitions, where appropriate. The point s_0 is arbitrary; it sets the zero point for the optical depth scale.

A medium is said to be *optically thick* or *opaque* when τ_ν , integrated along a typical path through the medium, satisfies $\tau_\nu > 1$. When $\tau_\nu < 1$, the medium is said to be *optically thin* or *transparent*. Essentially, an optically

thin medium is one in which the typical photon of frequency ν can traverse the medium without being absorbed, whereas an optically thick medium is one in which the average photon of frequency ν cannot traverse the entire medium without being absorbed.

The transfer equation can now be written, after dividing by α_ν ,

$$\frac{dI_\nu}{d\tau_\nu} = -I_\nu + S_\nu, \quad (1.27)$$

where the *source function* S_ν is defined as the ratio of the emission coefficient to the absorption coefficient:

$$S_\nu \equiv \frac{j_\nu}{\alpha_\nu}. \quad (1.28)$$

The source function S_ν is often a simpler physical quantity than the emission coefficient. Also, the optical depth scale reveals more clearly the important intervals along a ray as far as radiation is concerned. For these reasons the variables τ_ν and S_ν are often used instead of α_ν and j_ν .

We can now formally solve the equation of radiative transfer, by regarding all quantities as functions of the optical depth τ_ν instead of s . Multiply the equation by the integrating factor e^{τ_ν} and define the quantities $\mathcal{G} \equiv I_\nu e^{\tau_\nu}$, $\mathcal{S} \equiv S_\nu e^{\tau_\nu}$. Then the equation becomes

$$\frac{d\mathcal{G}}{d\tau_\nu} = \mathcal{S},$$

with the solution

$$\mathcal{G}(\tau_\nu) = \mathcal{G}(0) + \int_0^{\tau_\nu} \mathcal{S}(\tau'_\nu) d\tau'_\nu.$$

Rewriting the solution in terms of I_ν and S_ν , we have the *formal solution of the transfer equation*:

$$I_\nu(\tau_\nu) = I_\nu(0)e^{-\tau_\nu} + \int_0^{\tau_\nu} e^{-(\tau_\nu - \tau'_\nu)} S_\nu(\tau'_\nu) d\tau'_\nu. \quad (1.29)$$

Since τ_ν is just the dimensionless *e*-folding factor for absorption, the above equation is easily interpreted as the sum of two terms: the initial intensity diminished by absorption plus the integrated source diminished by absorption. As an example consider a *constant* source function S_ν . Then Eq. (1.29)

14 Fundamentals of Radiative Transfer

gives the solution

$$\begin{aligned} I_\nu(\tau_\nu) &= I_\nu(0)e^{-\tau_\nu} + S_\nu(1 - e^{-\tau_\nu}) \\ &= S_\nu + e^{-\tau_\nu}(I_\nu(0) - S_\nu). \end{aligned} \quad (1.30)$$

As $\tau_\nu \rightarrow \infty$, Eq. (1.30) shows that $I_\nu \rightarrow S_\nu$. We remind the reader that when scattering is present, S_ν contains a contribution from I_ν , so that it is not possible to specify S_ν a priori. This case is treated in detail in §1.7 and 1.8.

We conclude this section with a result of use later, which provides a simple physical interpretation of the source function and the transfer equation. From the transfer equation we see that if $I_\nu > S_\nu$, then $dI_\nu/d\tau_\nu < 0$ and I_ν tends to decrease along the ray. If $I_\nu < S_\nu$, then I_ν tends to increase along the ray. Thus the source function is the quantity that the specific intensity tries to approach, and does approach if given sufficient optical depth. In this respect the transfer equation describes a “relaxation” process.

Mean Free Path

A useful concept, which describes absorption in an equivalent way, is that of the *mean free path* of radiation (or photons). This is defined as the average distance a photon can travel through an absorbing material without being absorbed. It may be easily related to the absorption coefficient of a homogeneous material. From the exponential absorption law (1.25), the probability of a photon traveling at least an optical depth τ_ν is simply $e^{-\tau_\nu}$. The *mean* optical depth traveled is thus equal to unity:

$$\langle \tau_\nu \rangle \equiv \int_0^\infty \tau_\nu e^{-\tau_\nu} d\tau_\nu = 1.$$

The mean physical distance traveled in a homogeneous medium is defined as the *mean free path* l_ν , and is determined by $\langle \tau_\nu \rangle = \alpha_\nu l_\nu = 1$ or

$$l_\nu = \frac{1}{\alpha_\nu} = \frac{1}{n\sigma_\nu}. \quad (1.31)$$

Thus the mean free path l_ν is simply the reciprocal of the absorption coefficient for homogenous material.

We can define a *local mean path* at a point in an inhomogeneous material as the mean free path that would result if the photon traveled through a large homogenous region of the same properties. Thus at any point we have $l_\nu = 1/\alpha_\nu$.

Radiation Force

If a medium absorbs radiation, then the radiation exerts a force on the medium, because radiation carries momentum. We can first define a *radiation flux vector*

$$\mathbf{F}_\nu = \int I_\nu \mathbf{n} d\Omega, \tag{1.32}$$

where \mathbf{n} is a unit vector along the direction of the ray. Remember that a photon has momentum E/c , so that the vector momentum per unit area per unit time per unit path length absorbed by the medium is

$$\mathfrak{F} = \frac{1}{c} \int \alpha_\nu \mathbf{F}_\nu d\nu. \tag{1.33}$$

Since $dA ds = dV$, \mathfrak{F} is the force per unit volume imparted onto the medium by the radiation field. We note that the force per unit mass of material is given by $\mathbf{f} = \mathfrak{F}/\rho$ or

$$\mathbf{f} = \frac{1}{c} \int \kappa_\nu \mathbf{F}_\nu d\nu. \tag{1.34}$$

Equations (1.33) and (1.34) assume that the absorption coefficient is isotropic. They also assume that no momentum is imparted by the emission of radiation, as is true for isotropic emission.

1.5 THERMAL RADIATION

Thermal radiation is radiation emitted by matter in thermal equilibrium.

Blackbody Radiation

To investigate thermal radiation, it is necessary to consider first of all *blackbody radiation*, radiation which is itself in thermal equilibrium.

To obtain such radiation we keep an enclosure at temperature T and do not let radiation in or out until equilibrium has been achieved. If we are careful, we can open a small hole in the side of the container and measure the radiation inside without disturbing equilibrium. Now, using some general thermodynamic arguments plus the fact that photons are massless, we can derive several important properties of blackbody radiation.

Since photons are massless, they can be created and destroyed in arbitrary numbers by the walls of the container (for practical purposes,

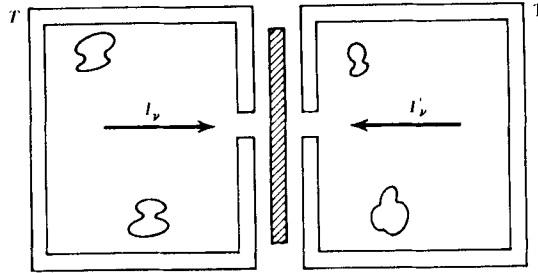

Figure 1.8 Two containers at temperature T , separated by a filter.

there is negligible *self-interaction* between photons). Thus there is no conservation law of photon number (unlike particle number for baryons), and we expect that the number of photons will adjust itself in equilibrium at temperature T .

An important property of I_ν is that it is independent of the properties of the enclosure and depends only on the temperature. To prove this, consider joining the container to another container of arbitrary shape and placing a filter between the two, which passes a single frequency ν but no others (Fig. 1.8). If $I_\nu \neq I'_\nu$, energy will flow spontaneously between the two enclosures. Since these are at the same temperature, this violates the second law of thermodynamics. Therefore, we have the relations

$$I_\nu = \text{universal function of } T \text{ and } \nu \equiv B_\nu(T). \tag{1.35}$$

I_ν thus must be independent of the shape of the container. A corollary is that it is also isotropic; $I_\nu \neq I_\nu(\Omega)$. The function $B_\nu(T)$ is called the Planck function. Its form is discussed presently.

Kirchhoff's Law for Thermal Emission

Now consider an element of some thermally emitting material at temperature T , so that its emission depends solely on its temperature and internal properties. Put this into the opening of a blackbody enclosure at the same temperature T (Fig. 1.9). Let the source function of the material be S_ν . If $S_\nu > B_\nu$, then $I_\nu > B_\nu$, and if $S_\nu < B_\nu$, then $I_\nu < B_\nu$, by the discussion after Eq. (1.30). But the presence of the material cannot alter the radiation, since the new configuration is also a blackbody enclosure at temperature T . Thus we have the relations

$$S_\nu = B_\nu(T), \tag{1.36}$$

$$j_\nu = \alpha_\nu B_\nu(T). \tag{1.37}$$

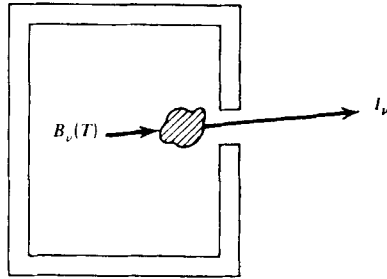

Figure 1.9 Thermal emitter placed in the opening of a blackbody enclosure.

Relation (1.37), called *Kirchhoff's law*, is an expression between α_ν and j_ν and the temperature of the matter T . The transfer equation for thermal radiation is, then, [cf. Eq. (1.23)],

$$\frac{dI_\nu}{ds} = -\alpha_\nu I_\nu + \alpha_\nu B_\nu(T),$$

or

$$\frac{dI_\nu}{d\tau_\nu} = -I_\nu + B_\nu(T). \quad (1.38)$$

Since $S_\nu = B_\nu$ throughout a blackbody enclosure, we have that $I_\nu = B_\nu$ throughout. Blackbody radiation is homogeneous and isotropic, so that $p = \frac{1}{3}u$.

At this point it is well to draw the distinction between *blackbody radiation*, where $I_\nu = B_\nu$, and *thermal radiation*, where $S_\nu = B_\nu$. Thermal radiation becomes blackbody radiation only for optically thick media.

Thermodynamics of Blackbody Radiation

Blackbody radiation, like any system in the thermodynamic equilibrium, can be treated by thermodynamic methods. Let us make a blackbody enclosure with a piston, so that work may be done on or extracted from the radiation (Fig. 1.10). Now by the first law of thermodynamics, we have

$$dQ = dU + p dV, \quad (1.39)$$

where Q is heat and U is total energy. By the second law of thermodynamics,

$$dS = \frac{dQ}{T},$$

18 Fundamentals of Radiative Transfer

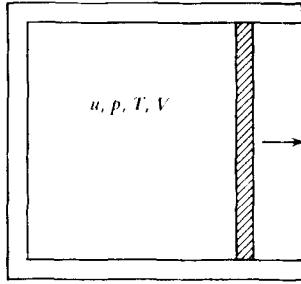

Figure 1.10 Blackbody enclosure with a piston on one side.

where $S \equiv$ entropy. But $U = uV$, and $p = u/3$, and u depends only on T since $u = (4\pi/c) \int J_\nu d\nu$ and $J_\nu = B_\nu(T)$. Thus we have

$$\begin{aligned} dS &= \frac{V}{T} \frac{du}{dT} dT + \frac{u}{T} dV + \frac{1}{3} \frac{u}{T} dV, \\ &= \frac{V}{T} \frac{du}{dT} dT + \frac{4u}{3T} dV \end{aligned}$$

Since dS is a perfect differential,

$$\left(\frac{\partial S}{\partial T} \right)_V = \frac{V}{T} \frac{du}{dT} \quad \left(\frac{\partial S}{\partial V} \right)_T = \frac{4u}{3T}. \quad (1.40)$$

Thus we obtain

$$\frac{\partial^2 S}{\partial T \partial V} = \frac{1}{T} \frac{du}{dT} = -\frac{4u}{3T^2} + \frac{4}{3T} \frac{du}{dT},$$

so that

$$\begin{aligned} \frac{du}{dT} &= \frac{4u}{T}, \quad \frac{du}{u} = 4 \frac{dT}{T}, \\ \log u &= 4 \log T + \log a, \end{aligned}$$

where $\log a$ is a constant of integration. Thus we obtain the *Stefan-Boltzmann* law

$$u(T) = aT^4. \quad (1.41)$$

This may be related to the Planck function, since $I_\nu = J_\nu$ for isotropic

radiation [cf. Eqs. (1.7)],

$$u = \frac{4\pi}{c} \int B_\nu(T) d\nu = \frac{4\pi}{c} B(T),$$

where the integrated Planck function is defined by

$$B(T) = \int B_\nu(T) d\nu = \frac{ac}{4\pi} T^4. \quad (1.42)$$

The emergent flux from an isotropically emitting surface (such as a blackbody) is $\pi \times$ brightness [see Eq. (1.14)], so that

$$F = \int F_\nu d\nu = \pi \int B_\nu d\nu = \pi B(T).$$

This leads to another form of the *Stefan–Boltzmann* law,

$$F = \sigma T^4, \quad (1.43)$$

where

$$\sigma \equiv \frac{ac}{4} = 5.67 \times 10^{-5} \text{ erg cm}^{-2} \text{ deg}^{-4} \text{ s}^{-1}, \quad (1.44a)$$

$$a = \frac{4\sigma}{c} = 7.56 \times 10^{-15} \text{ erg cm}^{-3} \text{ deg}^{-4}. \quad (1.44b)$$

The constants a and σ cannot be determined by macroscopic thermodynamic arguments, but they are derived below. It is easily shown (Problem 1.6) that the entropy of blackbody radiation, S , is given by

$$S = \frac{4}{3} a T^3 V, \quad (1.45)$$

so that the law of adiabatic expansion for blackbody radiation is

$$TV^{1/3} = \text{constant, or} \quad (1.46a)$$

$$pV^{4/3} = \text{constant.} \quad (1.46b)$$

Equations (1.46) are the familiar adiabatic laws $pV^\gamma = \text{constant}$, with $\gamma = 4/3$.

The Planck Spectrum

We now give a derivation of the Planck function. This derivation falls into two main parts: first, we derive the density of photon states in a blackbody enclosure; second the average energy per photon state is evaluated.

Consider a photon of frequency ν propagating in direction \mathbf{n} inside a box. The wave vector of the photon is $\mathbf{k} = (2\pi/\lambda)\mathbf{n} = (2\pi\nu/c)\mathbf{n}$. If each dimension of the box L_x , L_y , and L_z is much longer than a wavelength, then the photon can be represented by some sort of standing wave in the box. The number of nodes in the wave in each direction x, y, z is, for example, $n_x = k_x L_x / 2\pi$, since there is one node for each integral number of wavelengths in given orthogonal directions. Now, the wave can be said to have changed states in a distinguishable manner when the number of nodes in a given direction changes by one or more. If $n_i \gg 1$, we can thus write the number of node changes in a wave number interval as, for example,

$$\Delta n_x = \frac{L_x \Delta k_x}{2\pi}.$$

Thus the number of states in the three-dimensional wave vector element $\Delta k_x \Delta k_y \Delta k_z \equiv d^3k$ is

$$\Delta N = \Delta n_x \Delta n_y \Delta n_z = \frac{L_x L_y L_z d^3k}{(2\pi)^3}.$$

Now, using the fact that $L_x L_y L_z = V$ (the volume of the container) and using the fact that photons have two independent polarizations (two states per wave vector \mathbf{k}), we can see that the number of states per unit volume per unit three-dimensional wave number is $2/(2\pi)^3$.

Now, since

$$d^3k = k^2 dk d\Omega = \frac{(2\pi)^3 \nu^2 d\nu d\Omega}{c^3},$$

we find the density of states (the number of states per solid angle per volume per frequency) to be

$$\rho_s = \frac{2\nu^2}{c^3}. \quad (1.47)$$

Next we ask what is the average energy of each state. We know from quantum theory that each photon of frequency ν has energy $h\nu$, so we

focus on a single frequency ν and ask what is the average energy of the state having frequency ν . Each state may contain n photons of energy $h\nu$, where $n=0, 1, 2, \dots$. Thus the energy may be $E_n = nh\nu$. According to statistical mechanics, the probability of a state of energy E_n is proportional to $e^{-\beta E_n}$ where $\beta = (kT)^{-1}$ and $k = \text{Boltzmann's constant} = 1.38 \times 10^{-16} \text{ erg deg}^{-1}$. Therefore, the average energy is:

$$\bar{E} = \frac{\sum_{n=0}^{\infty} E_n e^{-\beta E_n}}{\sum_{n=0}^{\infty} e^{-\beta E_n}} = -\frac{\partial}{\partial \beta} \ln \left(\sum_{n=0}^{\infty} e^{-\beta E_n} \right).$$

By the formula for the sum of a geometric series,

$$\sum_{n=0}^{\infty} e^{-\beta E_n} = \sum_{n=0}^{\infty} e^{-nh\nu\beta} = (1 - e^{-\beta h\nu})^{-1}.$$

Thus we have the result:

$$\bar{E} = \frac{h\nu e^{-\beta h\nu}}{1 - e^{-\beta h\nu}} = \frac{h\nu}{\exp(h\nu/kT) - 1}. \quad (1.48)$$

Since $h\nu$ is the energy of one photon of frequency ν , Eq. (1.48) says that the average number of photons of frequency ν , n_ν , the "occupation number", is

$$n_\nu = \left[\exp\left(\frac{h\nu}{kT}\right) - 1 \right]^{-1}. \quad (1.49)$$

Equation (1.48) is the standard expression for Bose–Einstein statistics with a limitless number of particles (chemical potential = 0). The energy per solid angle per volume per frequency is the product of \bar{E} and the density of states, Eq. (1.47). However, this can also be written in terms of $u_\nu(\Omega)$, introduced in §1.3. Thus we have:

$$u_\nu(\Omega) dV dv d\Omega = \left(\frac{2\nu^2}{c^3} \right) \frac{h\nu}{\exp(h\nu/kT) - 1} dV dv d\Omega,$$

$$u_\nu(\Omega) = \frac{2h\nu^3/c^3}{\exp(h\nu/kT) - 1}. \quad (1.50)$$

Equation (1.6) gives the relation between $u_\nu(\Omega)$ and I_ν ; here we have $I_\nu = B_\nu$,

22 Fundamentals of Radiative Transfer

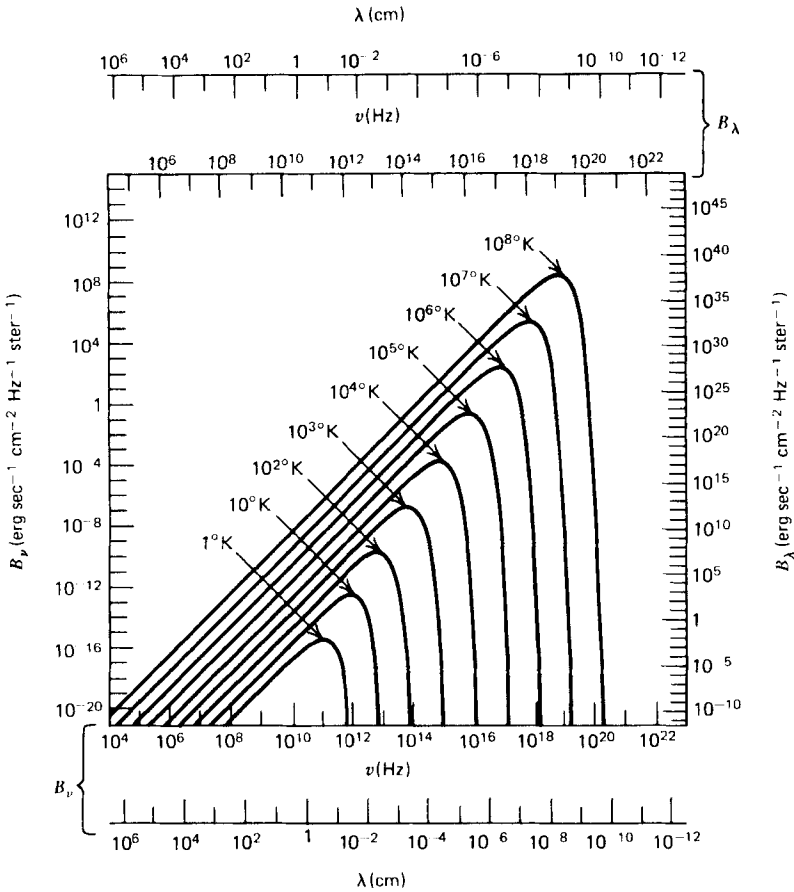

Figure 1.11 Spectrum of blackbody radiation at various temperatures (taken from Kraus, J. D. 1966, *Radio Astronomy*, McGraw-Hill Book Company)

so that

$$B_{\nu}(T) = \frac{2h\nu^3/c^2}{\exp(h\nu/kT) - 1}. \quad (1.51)$$

Equation (1.51) expresses the *Planck law*.

If we express the Planck law per unit wavelength interval instead of per unit frequency we have

$$B_{\lambda}(T) = \frac{2hc^2/\lambda^5}{\exp(hc/\lambda kT) - 1}. \quad (1.52)$$

A plot of B_ν and B_λ versus ν and λ for a range of values of T ($1K \leq T \leq 10^8K$) is given in Fig. 1.11.

Properties of the Planck Law

The form of $B_\nu(T)$ just derived [Eq. (1.51)] is one of the most important results for radiation processes. We now give a number of properties and consequences of this law:

a— $h\nu \ll kT$: The Rayleigh–Jeans Law. In this case the exponential can be expanded

$$\exp\left(\frac{h\nu}{kT}\right) - 1 = \frac{h\nu}{kT} + \dots$$

so that for $h\nu \ll kT$, we have the *Rayleigh–Jeans law*:

$$I_\nu^{RJ}(T) = \frac{2\nu^2}{c^2} kT. \tag{1.53}$$

Notice that this result does not contain Planck’s constant. It was originally derived by assuming that $\bar{E} = kT$, the classical equipartition value for the energy of an electromagnetic wave.

The Rayleigh–Jeans law applies at low frequencies (in the radio region it almost always applies). It shows up as the straight-line part of the $\log B_\nu - \log \nu$ plot in Fig. 1.11.

Note that if Eq. (1.53) applied to all frequencies, the total amount of energy $\propto \int \nu^2 d\nu$ would diverge. This is known as the *ultraviolet catastrophe*. For $h\nu \gg kT$, the discrete quantum nature of photons must be taken into account.

b— $h\nu \gg kT$: Wien Law. In this limit the term unity in the denominator can be dropped in comparison with $\exp(h\nu/kT)$, so we have the *Wien law*:

$$I_\nu^W(T) = \frac{2h\nu^3}{c^2} \exp\left(\frac{-h\nu}{kT}\right). \tag{1.54}$$

This form was first proposed by Wien on the basis of rather ad hoc arguments. The brightness of a blackbody decreases very rapidly with frequency once the maximum is reached. Note the steep portions of the curves in Fig. 1.11 associated with the Wien law.

24 Fundamentals of Radiative Transfer

c—Monotonicity with Temperature. Of two blackbody curves, the one with higher temperature lies entirely above the other. To prove this we note

$$\frac{\partial B_\nu(T)}{\partial T} = \frac{2h^2\nu^4}{c^2kT^2} \frac{\exp(h\nu/kT)}{[\exp(h\nu/kT) - 1]^2} \quad (1.55)$$

is positive. At any frequency the effect of increasing temperature is to increase $B_\nu(T)$. Also note $B_\nu \rightarrow 0$ as $T \rightarrow 0$ and $B_\nu \rightarrow \infty$ as $T \rightarrow \infty$.

d—Wien Displacement Law. The frequency ν_{\max} at which the peak of $B_\nu(T)$ occurs can be found by solving

$$\left. \frac{\partial B_\nu}{\partial \nu} \right|_{\nu = \nu_{\max}} = 0.$$

Letting $x \equiv h\nu_{\max}/kT$, this is equivalent to solving $x = 3(1 - e^{-x})$, which has the approximate root $x = 2.82$, so that

$$h\nu_{\max} = 2.82 kT, \quad (1.56a)$$

or

$$\frac{\nu_{\max}}{T} = 5.88 \times 10^{10} \text{ Hz deg}^{-1}. \quad (1.56b)$$

Thus the peak frequency of the blackbody law shifts linearly with temperature; this is known as the *Wien displacement law*.

Similarly, a wavelength λ_{\max} at which the maximum of $B_\lambda(T)$ occurs can be found by solving

$$\left. \frac{\partial B_\lambda}{\partial \lambda} \right|_{\lambda = \lambda_{\max}} = 0.$$

Letting $y = hc/(\lambda_{\max}kT)$, this is equivalent to solving $y = 5(1 - e^{-y})$, which has the approximate root $y = 4.97$, so that

$$\lambda_{\max} T = 0.290 \text{ cm deg}. \quad (1.57)$$

This is also known as the Wien displacement law.

Equations (1.56) and (1.57) are very reasonable. By dimensional analysis, one could have argued that the blackbody radiation spectrum should peak at energy $\sim kT$, since kT is the only quantity with dimensions of energy one can form from k, T, h, c .

One should be careful to note that the peaks of B_ν and B_λ do not occur at the same places in wavelength or frequency; that is, $\lambda_{\max}\nu_{\max} \neq c$. As an example, if $T=7300$ K the peak of B_ν is at $\lambda=.7$ microns (red), while the peak of B_λ is at $\lambda=.4$ microns (blue). The Wien displacement law gives a convenient way of characterizing the frequency range for which the Rayleigh–Jeans law is valid, namely, $\nu \ll \nu_{\max}$. Similarly for the Wien law $\nu \gg \nu_{\max}$.

e—Relation of Radiation Constants to Fundamental Constants. By putting in the explicit form for $B_\nu(T)$ into equation (1.42) we can obtain expressions for a and σ in terms of fundamental constants:

$$\int_0^\infty B_\nu(T) d\nu = (2h/c^2)(kT/h)^4 \int_0^\infty \frac{x^3 dx}{e^x - 1}.$$

The integral can be found in standard integral tables and has a value $\pi^4/15$. Therefore, we have the results

$$\int_0^\infty B_\nu(T) d\nu = \frac{2\pi^4 k^4}{15c^2 h^3} T^4, \quad (1.58a)$$

$$\sigma = \frac{2\pi^5 k^4}{15c^2 h^3}, \quad a = \frac{8\pi^5 k^4}{15c^3 h^3}. \quad (1.58b)$$

Characteristic Temperatures Related to Planck Spectrum

a—Brightness Temperature. One way of characterizing brightness (specific intensity) at a certain frequency is to give the temperature of the blackbody having the same brightness at that frequency. That is, for any value I_ν we define $T_b(\nu)$ by the relation

$$I_\nu = B_\nu(T_b). \quad (1.59)$$

T_b is called the *brightness temperature*. This way of specifying brightness has the advantage of being closely connected with the physical properties of the emitter, and has the simple unit (K) instead of ($\text{erg cm}^{-2} \text{s}^{-1} \text{Hz}^{-1} \text{ster}^{-1}$). This procedure is used especially in radio astronomy, where the Rayleigh–Jeans law is usually applicable, so that

$$I_\nu = \frac{2\nu^2}{c^2} kT_b \quad (1.60a)$$

26 Fundamentals of Radiative Transfer

or

$$T_b = \frac{c^2}{2\nu^2 k} I_\nu \quad (1.60b)$$

for $h\nu \ll kT$.

The transfer equation for thermal emission takes a particularly simple form in terms of brightness temperature in the Rayleigh–Jeans limit [cf. Eq. (1.38)],

$$\frac{dT_b}{d\tau_\nu} = -T_b + T, \quad (1.61)$$

where T is the temperature of the material. When T is constant we have

$$T_b = T_b(0)e^{-\tau_\nu} + T(1 - e^{-\tau_\nu}), \quad h\nu \ll kT. \quad (1.62)$$

If the optical depth is large, the brightness temperature of the radiation approaches the temperature of the material. We note that the uniqueness property of the definition of brightness temperature relies on the monotonicity property of Planck's law. We also note that, in general, the brightness temperature is a function of ν . Only if the source is blackbody is the brightness temperature the same at all frequencies.

In the Wien region of the Planck law the concept of brightness temperature is not so useful because of the rapid decrease of B_ν with ν , and because it is not possible to formulate a transfer equation linear in the brightness temperature.

b—Color Temperature. Often a spectrum is measured to have a shape more or less of blackbody form, but not necessarily of the proper absolute value. For example, by measuring F_ν from an unresolved source we cannot find I_ν unless we know the distance to the source and its physical size. By fitting the data to a blackbody curve without regard to vertical scale, a *color temperature* T_c is obtained. Often the “fitting” procedure is nothing more than estimating the peak of the spectrum and applying Wien's displacement law to find a temperature.

The color temperature T_c will correctly give the temperature of a blackbody source of unknown absolute scale. Also, T_c will give the temperature of a thermal emitter that is optically thin, providing that the optical thickness is fairly constant for frequencies near the peak. In this case the brightness temperature will be less than the temperature of the emitter, since the blackbody spectrum gives the maximum attainable

intensity of a thermal emitter at temperature T , by general thermodynamic arguments. (See Problem 1.8).

c—Effective Temperature. The effective temperature of a source T_{eff} is derived from the total amount of flux, integrated over all frequencies, radiated at the source. We obtain T_{eff} by equating the actual flux F to the flux of a blackbody at temperature T_{eff} :

$$F = \int \cos \theta I_\nu d\nu d\Omega \equiv \sigma T_{\text{eff}}^4. \quad (1.63)$$

Note that both T_{eff} and T_b depend on the magnitude of the source intensity, but T_c depends only on the shape of the observed spectrum.

1.6 THE EINSTEIN COEFFICIENTS

Definition of Coefficients

Kirchhoff's law, $j_\nu = \alpha_\nu B_\nu$, relating emission to absorption for a thermal emitter, clearly must imply some relationship between emission and absorption at a microscopic level. This relationship was first discovered by Einstein in a beautifully simple analysis of the interaction of radiation with an atomic system. He considered the simple case of two discrete energy levels: the first of energy E with statistical weight g_1 , the second of energy $E + h\nu_0$ with statistical weight g_2 (see Fig. 1.12). The system makes a transition from 1 to 2 by absorption of a photon of energy $h\nu_0$. Similarly, a transition from 2 to 1 occurs when a photon is emitted. Einstein identified three processes:

1—Spontaneous Emission: This occurs when the system is in level 2 and drops to level 1 by emitting a photon, and it occurs even in the absence of a radiation field. We define the *Einstein A-coefficient* by

$$A_{21} = \text{transition probability per unit time} \\ \text{for spontaneous emission (sec}^{-1}\text{)}. \quad (1.64)$$

2—Absorption: This occurs in the presence of photons of energy $h\nu_0$. The system makes a transition from level 1 to level 2 by absorbing a photon. Since there is no self-interaction of the radiation field, we expect

28 Fundamentals of Radiative Transfer

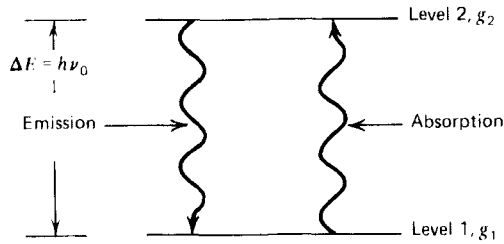

Figure 1.12a Emission and absorption from a two level atom.

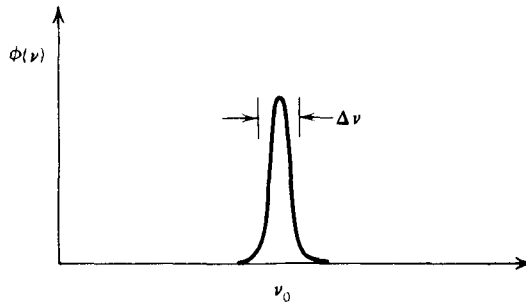

Figure 1.12b Line profile for 12a.

that the probability per unit time for this process will be proportional to the density of photons (or to the mean intensity) at frequency ν_0 . To be precise, we must recognize that the energy difference between the two levels is not infinitely sharp but is described by a *line profile function* $\phi(\nu)$, which is sharply peaked at $\nu = \nu_0$ and which is conveniently taken to be normalized:

$$\int_0^{\infty} \phi(\nu) d\nu = 1. \quad (1.65)$$

This line profile function describes the relative effectiveness of frequencies in the neighborhood of ν_0 for causing transitions. The physical mechanisms that determine $\phi(\nu)$ are discussed later in Chapter 10.

These arguments lead us to write

$$B_{12}\bar{J} = \text{transition probability per unit time for absorption}, \quad (1.66)$$

where

$$\bar{J} \equiv \int_0^{\infty} J_{\nu} \phi(\nu) d\nu. \quad (1.67)$$

The proportionality constant B_{12} is the *Einstein B-coefficient*.

3—Stimulated Emission: Einstein found that to derive Planck's law another process was required that was proportional to \bar{J} and caused *emission* of a photon. As before, we define:

$$B_{21}\bar{J} = \text{transition probability per unit time for stimulated emission.} \quad (1.68)$$

B_{21} is another *Einstein B-coefficient*.

Note that when J_ν changes slowly over the width $\Delta\nu$ of the line, $\phi(\nu)$ behaves like a δ -function, and the probabilities per unit time for absorption and stimulated emission become simply $B_{12}J_{\nu_0}$ and $B_{21}J_{\nu_0}$, respectively. In some discussions of the Einstein coefficients, including Einstein's original one, this assumption is made implicitly. Also be aware that the energy density u_ν is often used instead of J_ν to define the Einstein B-coefficients, which leads to definitions differing by $c/4\pi$, [cf. Eq. (1.7)].

Relations between Einstein Coefficients

In thermodynamic equilibrium we have that the number of transitions per unit time per unit volume out of state 1 = the number of transitions per unit time per unit volume into state 1. If we let n_1 and n_2 be the number densities of atoms in levels 1 and 2, respectively, this reduces to

$$n_1 B_{12} \bar{J} = n_2 A_{21} + n_2 B_{21} \bar{J}. \quad (1.69)$$

Now, solving for \bar{J} from Eq. (1.69):

$$\bar{J} = \frac{A_{21}/B_{21}}{(n_1/n_2)(B_{12}/B_{21}) - 1}.$$

In thermodynamic equilibrium the ratio of n_1 to n_2 is

$$\frac{n_1}{n_2} = \frac{g_1 \exp(-E/kT)}{g_2 \exp[-(E + h\nu_0)/kT]} = \frac{g_1}{g_2} \exp(h\nu_0/kT), \quad (1.70)$$

so that

$$\bar{J} = \frac{A_{21}/B_{21}}{(g_1 B_{12}/g_2 B_{21}) \exp(h\nu_0/kT) - 1}. \quad (1.71)$$

But in thermodynamic equilibrium we also know $J_\nu = B_\nu$ [cf. Eq. (1.51)], and the fact that B_ν varies slowly on the scale of $\Delta\nu$ implies that $\bar{J} = B_\nu$.

30 Fundamentals of Radiative Transfer

For the expression in Eq. (1.71) to equal the Planck function for all temperatures we must have the following *Einstein relations*:

$$g_1 B_{12} = g_2 B_{21}, \quad (1.72a)$$

$$A_{21} = \frac{2h\nu^3}{c^2} B_{21}. \quad (1.72b)$$

These connect *atomic properties* A_{21} , B_{21} , and B_{12} and have no reference to the temperature T [unlike Kirchhoff's Law, Eq. (1.37)]. Thus Eq. (1.72) must hold whether or not the atoms are in thermodynamic equilibrium. Equations (1.72) are examples of what are generally known as *detailed balance relations* that connect any microscopic process and its inverse process, here absorption and emission. These Einstein relations are the extensions of Kirchhoff's law to include the nonthermal emission that occurs when the matter is not thermodynamic equilibrium. If we can determine any one of the coefficients A_{21} , B_{21} , or B_{12} these relations allow us to determine the other two; this will be of considerable value to us later on.

Einstein was led to include the process of stimulated emission by the fact that without it he could not get Planck's law, but only Wien's law, which was known to be incorrect. Why does one obtain the Wien law when stimulated emission is neglected? Remember that the Wien law is the expression of the Planck spectrum when $h\nu \gg kT$ [cf. Eq. (1.54)]. But when $h\nu \gg kT$, level 2 is very sparsely populated relative to level 1, $n_2 \ll n_1$. Then, stimulated emission is unimportant compared to absorption, since these are proportional to n_2 and n_1 , respectively [cf. Eq. (1.69)]. See Problem 1.7.

A property of stimulated emission that is not clear from the preceding discussion is that it takes place into precisely the same direction and frequency (in fact, into the same photon state). The emitted photon is precisely coherent with the photon that stimulated the emission.

Absorption and Emission Coefficients in Terms of Einstein Coefficients

To obtain the emission coefficient j , we must make some assumption about the frequency distribution of the emitted radiation during a spontaneous transition from level 2 to level 1. The simplest assumption is that this emission is distributed in accordance with the same line profile function $\phi(\nu)$ that describes absorption. (This assumption is very often a good one in astrophysics). The amount of energy emitted in volume dV , solid angle $d\Omega$, frequency range $d\nu$, and time dt is, by definition,

$j_\nu dV d\Omega d\nu dt$. Since each atom contributes an energy $h\nu_0$ distributed over 4π solid angle for each transition, this may also be expressed as $(h\nu_0/4\pi)\phi(\nu)n_2A_{21}dV d\Omega d\nu dt$, so that the emission coefficient is

$$j_\nu = \frac{h\nu_0}{4\pi} n_2 A_{21} \phi(\nu). \quad (1.73)$$

To obtain the absorption coefficient we first note from Eqs. (1.66) and (1.67) that the total energy absorbed in time dt and volume dV is

$$dV dt h\nu_0 n_1 B_{12} (4\pi)^{-1} \int d\Omega \int d\nu \phi(\nu) I_\nu.$$

Therefore, the energy absorbed out of a beam in frequency range $d\nu$ solid angle $d\Omega$ time dt and volume dV is

$$dV dt d\Omega d\nu \frac{h\nu_0}{4\pi} n_1 B_{12} \phi(\nu) I_\nu.$$

Taking the volume element to be that of Fig. 1.4, so that $dV = dA ds$, and noting Eqs. (1.2) and (1.20), we have the absorption coefficient (uncorrected for stimulated emission):

$$\alpha_\nu = \frac{h\nu}{4\pi} n_1 B_{12} \phi(\nu). \quad (1.74)$$

What about the stimulated emission? At first sight one might be tempted to add this as a contribution to the emission coefficient; but notice that it is proportional to the intensity and only affects the photons along the given beam, in close analogy to the process of absorption. Thus it is much more convenient to treat stimulated emission as *negative absorption* and include its effect through the absorption coefficient. In operational terms these two processes always occur together and cannot be disentangled by experiments based on Eq. (1.20). By reasoning entirely analogous to that leading to Eq. (1.74) we can find the contribution of stimulated emission to the absorption coefficient. The result for the absorption coefficient, corrected for stimulated emission, is

$$\alpha_\nu = \frac{h\nu}{4\pi} \phi(\nu) (n_1 B_{12} - n_2 B_{21}). \quad (1.75)$$

It is this quantity that will always be meant when we speak simply of the *absorption coefficient*. The form given in Eq. (1.74) will be called the *absorption coefficient uncorrected for stimulated emission*.

32 Fundamentals of Radiative Transfer

It is now possible to write the transfer equation in terms of the Einstein coefficients:

$$\frac{dI_\nu}{ds} = -\frac{h\nu}{4\pi}(n_1B_{12} - n_2B_{21})\phi(\nu)I_\nu + \frac{h\nu}{4\pi}n_2A_{21}\phi(\nu). \quad (1.76)$$

The source function can be obtained by dividing Eq. (1.73) by Eq. (1.75):

$$S_\nu = \frac{n_2A_{21}}{n_1B_{12} - n_2B_{21}}. \quad (1.77)$$

Using the Einstein relations, (1.72), the absorption coefficient and source function can be written

$$\alpha_\nu = \frac{h\nu}{4\pi}n_1B_{12}(1 - g_1n_2/g_2n_1)\phi(\nu), \quad (1.78)$$

$$S_\nu = \frac{2h\nu^3}{c^2} \left(\frac{g_2n_1}{g_1n_2} - 1 \right)^{-1}. \quad (1.79)$$

Equation (1.79) is a generalized Kirchhoff's law. Three interesting cases of these equations can be identified.

1—Thermal Emission (LTE): If the matter is in thermal equilibrium with itself (but not necessarily with the radiation) we have

$$\frac{n_1}{n_2} = \frac{g_1}{g_2} \exp\left(\frac{h\nu}{kT}\right).$$

The matter is said to be in *local thermodynamic equilibrium (LTE)*. In this case,

$$\alpha_\nu = \frac{h\nu}{4\pi}n_1B_{12} \left[1 - \exp\left(\frac{-h\nu}{kT}\right) \right] \phi(\nu), \quad (1.80)$$

$$S_\nu = B_\nu(T). \quad (1.81)$$

This thermal value for the source function is, of course, just a statement of Kirchhoff's law. A new result is the correction factor $1 - \exp(-h\nu/kT)$ in the absorption coefficient, which is due to stimulated emission.

2—Nonthermal Emission: This term covers all other cases in which

$$\frac{n_1}{n_2} \neq \frac{g_1}{g_2} \exp\left(\frac{h\nu}{kT}\right).$$

For a plasma, for example, this would occur if the radiating particles did not have a Maxwellian velocity distribution or if the atomic populations did not obey the Maxwell-Boltzmann distribution law. The term can also be applied to cases in which scattering is present.

3—Inverted Populations; Masers: For a system in thermal equilibrium we have

$$\frac{n_2 g_1}{n_1 g_2} = \exp\left(\frac{-h\nu}{kT}\right) < 1,$$

so that

$$\frac{n_1}{g_1} > \frac{n_2}{g_2}. \quad (1.82)$$

Even when the material is out of thermal equilibrium, this relation is usually satisfied. In that case we say that there are *normal populations*. However, it is possible to put enough atoms in the upper state so that we have *inverted populations*:

$$\frac{n_1}{g_1} < \frac{n_2}{g_2}. \quad (1.83)$$

In this case the absorption coefficient is *negative*: $\alpha_\nu < 0$, as can be seen from Eq. (1.78). Rather than decrease along a ray, the intensity actually increases. Such a system is said to be a *maser* (*microwave amplification by stimulated emission of radiation*; also *laser* for *light*...).

The amplification involved here can be very large. A negative optical depth of -100 , for example, leads to an amplification by a factor of 10^{43} , [cf. equation (1.25)]. The detailed understanding of masers is a specialized field and is not dealt with here. Maser action in molecular lines has been observed in many astrophysical sources.

1.7 SCATTERING EFFECTS; RANDOM WALKS

Pure Scattering

For pure thermal emission the amount of radiation emitted by an element of material is not dependent on the radiation field incident on it—the source function is always $B_\nu(T)$ and depends only on the local temperature. Such an element would emit the same whether it was isolated in free space or imbedded deeply within a star where the ambient radiation field

34 Fundamentals of Radiative Transfer

was substantial. This characteristic of thermal radiation makes it particularly easy to treat.

However, another common emission process is *scattering*, which depends completely on the amount of radiation falling on the element. Perhaps the most important mechanism of this type is *electron scattering*, which is treated in detail in Chapter 7. For the present discussion we assume *isotropic scattering*, which means that the scattered radiation is emitted equally into equal solid angles, so that the emission coefficient is independent of direction. We also assume that the total amount of radiation emitted per unit frequency range is just equal to the total amount absorbed in that same frequency range. This is called *coherent scattering*; other terms are *elastic* or *monochromatic scattering*. Scattering from nonrelativistic electrons is very nearly coherent (note, however, that repeated scatterings can build up substantial effects; see Chapter 7):

The emission coefficient for coherent, isotropic scattering can be found simply by equating the power absorbed per unit volume and frequency ranges to the corresponding power emitted. This yields

$$j_\nu = \sigma_\nu J_\nu, \quad (1.84)$$

where σ_ν is the absorption coefficient of the scattering process, also called the *scattering coefficient*. Dividing by the scattering coefficient, we find that the source function for scattering is simply equal to the mean intensity within the emitting material:

$$S_\nu = J_\nu = \frac{1}{4\pi} \int I_\nu d\Omega. \quad (1.85)$$

The transfer equation for pure scattering is therefore

$$\frac{dI_\nu}{ds} = -\sigma_\nu(I_\nu - J_\nu). \quad (1.86)$$

This equation cannot simply be solved by the formal solution (1.29), since the source function is not known a priori and depends on the solution I_ν at all directions through a given point. It is now an *integro-differential equation*, which poses a difficult mathematical problem. An approximate method of treating scattering problems, the Eddington approximation, is discussed in §1.8.

A particularly useful way of looking at scattering, which leads to important order-of-magnitude estimates, is by means of *random walks*. It is possible to view the processes of absorption, emission, and propagation in probabilistic terms for a single photon rather than the average behavior of

large numbers of photons, as we have been doing so far. For example, the exponential decay of a beam of photons has the interpretation that the probability of a photon traveling an optical depth τ , before absorption is just $e^{-\tau}$. Similarly, when radiation is scattered isotropically we can say that a single photon has equal probabilities of scattering into equal solid angles. In this way we can speak of a typical or sample path of a photon, and the measured intensities can be interpreted as statistical averages over photons moving in such paths.

Now consider a photon emitted in an infinite, homogeneous scattering region. It travels a displacement \mathbf{r}_1 before being scattered, then travels in a new direction over a displacement \mathbf{r}_2 before being scattered, and so on. The net displacement of the photon after N free paths is

$$\mathbf{R} = \mathbf{r}_1 + \mathbf{r}_2 + \mathbf{r}_3 + \cdots + \mathbf{r}_N. \tag{1.87}$$

We would like to find a rough estimate of the distance $|\mathbf{R}|$ traveled by a typical photon. Simple averaging of Eq. (1.87) over all sample paths will not work, because the average displacement, being a vector, must be zero. Therefore, we first square Eq. (1.87) and then average. This yields the mean square displacement traveled by the photon:

$$\begin{aligned} l_*^2 \equiv \langle \mathbf{R}^2 \rangle &= \langle \mathbf{r}_1^2 \rangle + \langle \mathbf{r}_2^2 \rangle + \cdots + \langle \mathbf{r}_N^2 \rangle \\ &+ 2\langle \mathbf{r}_1 \cdot \mathbf{r}_2 \rangle + 2\langle \mathbf{r}_1 \cdot \mathbf{r}_3 \rangle + \cdots \\ &+ \cdots . \end{aligned} \tag{1.88}$$

Each term involving the square of a displacement averages to the mean square of the free path of a photon, which is denoted l^2 . To within a factor of order unity, l is simply the mean free path of a photon. The cross terms in Eq. (1.88) involve averaging the cosine of the angle between the directions before and after scattering, and this vanishes for isotropic scattering. (It also vanishes for any scattering with front-back symmetry, as in Thomson or Rayleigh scattering.) Therefore,

$$\begin{aligned} l_*^2 &= Nl^2, \\ l_* &= \sqrt{N} l. \end{aligned} \tag{1.89}$$

The quantity l_* is the root mean square *net* displacement of the photon, and it increases as the square root of the number of scatterings.

This result can be used to estimate the mean number of scatterings in a finite medium. Suppose a photon is generated somewhere within the

36 Fundamentals of Radiative Transfer

medium; then the photon will scatter until it escapes completely. For regions of large optical depth the number of scatterings required to do this is roughly determined by setting $l_s \sim L$, the typical size of the medium. From Eq. (1.89) we find $N \approx L^2/l^2$. Since l is of the order of the mean free path, L/l is approximately the optical thickness of the medium τ . Therefore, we have

$$N \approx \tau^2, \quad (\tau \gg 1). \quad (1.90a)$$

For regions of small optical thickness the mean number of scatterings is small, of order $1 - e^{-\tau} \approx \tau$; that is,

$$N \approx \tau, \quad (\tau \ll 1). \quad (1.90b)$$

For most order-of-magnitude estimates it is sufficient to use $N \approx \tau^2 + \tau$ or $N \approx \max(\tau, \tau^2)$ for any optical thickness.

Combined Scattering and Absorption

The emission and absorption of radiation may be governed by more than one process. As an example, let us treat the case of material with an absorption coefficient α_ν , describing thermal emission and a scattering coefficient σ_ν , describing coherent isotropic scattering. The transfer equation then has two terms on the right-hand side:

$$\begin{aligned} \frac{dI_\nu}{ds} &= -\alpha_\nu(I_\nu - B_\nu) - \sigma_\nu(I_\nu - J_\nu) \\ &= -(\alpha_\nu + \sigma_\nu)(I_\nu - S_\nu). \end{aligned} \quad (1.91)$$

The source function is [cf. (1.28)],

$$S_\nu = \frac{\alpha_\nu B_\nu + \sigma_\nu J_\nu}{\alpha_\nu + \sigma_\nu} \quad (1.92)$$

and is an average of the two separate source functions, weighted by their respective absorption coefficients.

The net absorption coefficient is $\alpha_\nu + \sigma_\nu$, which can be used to define the optical depth by $d\tau_\nu = (\alpha_\nu + \sigma_\nu)ds$. This net absorption coefficient is often called the *extinction coefficient* to distinguish it from the "true" absorption coefficient α_ν .

If a matter element is deep inside a medium at some constant temperature, we expect that the radiation field will be near to its thermodynamic value $J_\nu = B_\nu(\tau)$. It follows from Eq. (1.92) that $S_\nu = B_\nu(\tau)$ also, as it must in

thermal equilibrium. On the other hand, if the element is isolated in free space, where $J_\nu = 0$, then the source function is only a fraction of the Planck function: $S_\nu = \alpha_\nu B_\nu / (\alpha_\nu + \sigma_\nu)$. In general, the source function will not be known a priori but must be calculated as part of a self-consistent solution of the entire radiation field. (See §1.8.)

The random walk arguments can be extended to the case of combined scattering and absorption. The free path of a photon is now determined by the total extinction coefficient $\alpha_\nu + \sigma_\nu$; the mean free path of a photon before scattering or absorption is

$$l_\nu = (\alpha_\nu + \sigma_\nu)^{-1}. \tag{1.93}$$

During the random walk the probability that a free path will end with a true absorption event is

$$\epsilon_\nu = \frac{\alpha_\nu}{\alpha_\nu + \sigma_\nu}, \tag{1.94a}$$

the corresponding probability for scattering being

$$1 - \epsilon_\nu = \frac{\sigma_\nu}{\alpha_\nu + \sigma_\nu}. \tag{1.94b}$$

The quantity $1 - \epsilon_\nu$ is called the *single-scattering albedo*. The source function (1.92) can be written

$$S_\nu = (1 - \epsilon_\nu)J_\nu + \epsilon_\nu B_\nu. \tag{1.95}$$

Let us consider first an infinite homogeneous medium. A random walk starts with the thermal emission of a photon (creation) and ends, possibly after a number of scatterings, with a true absorption (destruction). Since the walk can be terminated with probability ϵ at the end of each free path, the mean number of free paths is $N = \epsilon^{-1}$. From Eq. (1.89) we then have

$$l_*^2 = \frac{l^2}{\epsilon},$$

$$l_* = \frac{l}{\sqrt{\epsilon}}. \tag{1.96}$$

Using Eqs. (1.93) and (1.94a) we have

$$l_* \approx [\alpha_\nu (\alpha_\nu + \sigma_\nu)]^{-1/2}. \tag{1.97}$$

38 Fundamentals of Radiative Transfer

The length l_* represents a measure of the net displacement between the points of creation and destruction of a typical photon; it is variously called the *diffusion length*, *thermalization length*, or *effective mean path*. Note also that l_* is generally frequency dependent.

The behavior of a finite medium also can be discussed in terms of random walks. This behavior depends strongly on whether its size L is larger or smaller than the effective free path l_* . It is convenient to make this distinction in terms of the ratio $\tau_* = L/l_*$, called the *effective optical thickness* of the medium. Using Eq. (1.97) we have the result

$$\tau_* \approx \sqrt{\tau_a(\tau_a + \tau_s)}, \quad (1.98)$$

where the absorption and scattering optical thickness are defined by

$$\tau_a = \alpha_\nu L; \quad \tau_s = \sigma_\nu L. \quad (1.99)$$

When the effective free path is large compared with the size of the medium we have

$$\tau_* \ll 1, \quad (1.100)$$

and the medium is said to be *effectively thin* or *translucent*. Most photons will then escape by random walking out of the medium before being destroyed by a true absorption. The monochromatic luminosity will just be equal to the total radiation created by thermal emission in the medium:

$$\mathcal{L}_\nu = 4\pi\alpha_\nu B_\nu V, \quad (\tau_* \ll 1) \quad (1.101)$$

where \mathcal{L}_ν is the emitted power per unit frequency and V is the volume of the medium.

When the effective free path is small compared with the size of the medium we have

$$\tau_* \gg 1, \quad (1.102)$$

and the medium is said to be *effectively thick*. Most photons thermally emitted at depths larger than the effective path length will be destroyed by absorption before they get out. Therefore the physical conditions at large, effective depths approach the conditions for the radiation to come into thermal equilibrium with the matter, and we expect $I_\nu \rightarrow B_\nu$ and $S_\nu \rightarrow B_\nu$. Because of this property the effective path length l_* is sometimes called the *thermalization length*, since it describes the distance over which thermal equilibrium of the radiation is established.

The monochromatic luminosity of an effectively thick medium can be estimated to within factors of order unity by considering the effective emitting volume to be the surface area of the medium times the effective path length. This is because it is only those photons emitted within an effective path length of the boundary that have a reasonable chance of escaping before being absorbed. Thus we have

$$\mathcal{L}_\nu \approx 4\pi\alpha_\nu B_\nu A l_* \approx 4\pi\sqrt{\epsilon_\nu} B_\nu A, \quad (\tau_* \gg 1) \quad (1.103)$$

using Eqs. (1.94a) and (1.97). In the limiting case of no scattering, $\epsilon_\nu \rightarrow 1$, we know that the emission will be that of a blackbody, where $\mathcal{L}_\nu = \pi B_\nu A$, which suggests that the factor 4π in Eq. (1.103) should be replaced by π ; however, the form of the exact equation actually depends on ϵ_ν and on geometry in a more complex way, and the equation should be taken only as an estimate. (For a more complete treatment see Problem 1.10).

1.8 RADIATIVE DIFFUSION

The Rosseland Approximation

We have used random walk arguments to show that S_ν approaches B_ν at large effective optical depths in a homogeneous medium. Real media are seldom homogeneous, but often, as in the interiors of stars, there is a high degree of local homogeneity. In such cases it is possible to derive a simple expression for the energy flux, relating it to the local temperature gradient. This result, first derived by Rosseland, is called the *Rosseland approximation*.

First let us assume that the material properties (temperature, absorption coefficient, etc.) depend only on depth in the medium. This is called the *plane-parallel* assumption. Then, by symmetry, the intensity can depend only on a single angle θ , which measures the direction of the ray with respect to the direction normal to the planes of constant properties. (See Fig. 1.13.)

It is convenient to use $\mu = \cos\theta$ as the variable rather than θ itself. We note that

$$ds = \frac{dz}{\cos\theta} = \frac{dz}{\mu}$$

Therefore we have the transfer equation

$$\mu \frac{\partial I_\nu(z, \mu)}{\partial z} = -(\alpha_\nu + \sigma_\nu)(I_\nu - S_\nu). \quad (1.104a)$$

40 Fundamentals of Radiative Transfer

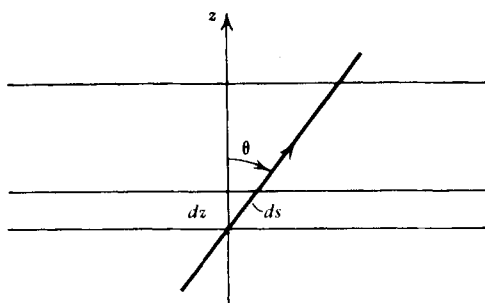

Figure 1.13 Geometry for plane-parallel media.

Let us rewrite this as

$$I_\nu(z, \mu) = S_\nu - \frac{\mu}{\alpha_\nu + \sigma_\nu} \frac{\partial I_\nu}{\partial z}. \quad (1.104b)$$

Now we use the fact that when the point in question is deep in the material the intensity changes rather slowly on the scale of a mean free path. Therefore the derivative term above is small and we write as a “zeroth” approximation,

$$I_\nu^{(0)}(z, \mu) \approx S_\nu^{(0)}(T). \quad (1.105)$$

Since this is independent of the angle μ , the zeroth-order mean intensity is given by $J_\nu^{(0)} = S_\nu^{(0)}$. From Eq. (1.92) this implies $I_\nu^{(0)} = S_\nu^{(0)} = B_\nu$, as we expect from the random walk arguments. We now get a better, “first” approximation by using the value $I_\nu^{(0)} = B_\nu$ in the derivative term:

$$I_\nu^{(1)}(z, \mu) \approx B_\nu(T) - \frac{\mu}{\alpha_\nu + \sigma_\nu} \frac{\partial B_\nu}{\partial z}. \quad (1.106)$$

This is justified, because the derivative term is already small, and any approximation there is not so critical. Note that the angular dependence of the intensity to this order of approximation is linear in $\mu = \cos \theta$.

Let us now compute the flux $F_\nu(z)$ using the above form for the intensity:

$$\begin{aligned} F_\nu(z) &= \int I_\nu^{(1)}(z, \mu) \cos \theta \, d\Omega \\ &= 2\pi \int_{-1}^{+1} I_\nu^{(1)}(z, \mu) \mu \, d\mu. \end{aligned} \quad (1.107)$$

The angle-independent part of $I_\nu^{(1)}$ (i.e., B_ν) does not contribute to the flux. Thus we have the result

$$\begin{aligned} F_\nu(z) &= -\frac{2\pi}{\alpha_\nu + \sigma_\nu} \frac{\partial B_\nu}{\partial z} \int_{-1}^{+1} \mu^2 d\mu \\ &= -\frac{4\pi}{3(\alpha_\nu + \sigma_\nu)} \frac{\partial B_\nu(T)}{\partial z} \\ &= -\frac{4\pi}{3(\alpha_\nu + \sigma_\nu)} \frac{\partial B_\nu(T)}{\partial T} \frac{\partial T}{\partial z}, \end{aligned} \quad (1.108)$$

using the chain rule for differentiation. This is the result for the monochromatic flux.

To obtain the total flux we integrate over all frequencies:

$$\begin{aligned} F(z) &= \int_0^\infty F_\nu(z) d\nu \\ &= -\frac{4\pi}{3} \frac{\partial T}{\partial z} \int_0^\infty (\alpha_\nu + \sigma_\nu)^{-1} \frac{\partial B_\nu}{\partial T} d\nu. \end{aligned}$$

This can be put into a more convenient form using the result:

$$\int_0^\infty \frac{\partial B_\nu}{\partial T} d\nu = \frac{\partial}{\partial T} \int_0^\infty B_\nu d\nu = \frac{\partial B(T)}{\partial T} = \frac{4\sigma T^3}{\pi} \quad (1.109)$$

which follows from Eqs. (1.42) and (1.43). Here σ is the Stefan–Boltzmann constant, not to be confused with σ_ν . We then define the *Rosseland mean absorption coefficient* α_R by the relation:

$$\frac{1}{\alpha_R} \equiv \frac{\int_0^\infty (\alpha_\nu + \sigma_\nu)^{-1} \frac{\partial B_\nu}{\partial T} d\nu}{\int_0^\infty \frac{\partial B_\nu}{\partial T} d\nu}. \quad (1.110)$$

Then we have

$$F(z) = -\frac{16\sigma T^3}{3\alpha_R} \frac{\partial T}{\partial z}. \quad (1.111)$$

This relation is called the *Rosseland approximation* for the energy flux. This equation is often called the *equation of radiative diffusion* [although this

42 Fundamentals of Radiative Transfer

term is also used for equations such as (1.119) below]. It shows that radiative energy transport deep in a star is of the same nature as a heat conduction, with an “effective heat conductivity” = $16\sigma T^3/3\alpha_R$. It also shows that the energy flux depends on only one property of the absorption coefficient, namely, its Rosseland mean. This mean involves a weighted average of $(\alpha_\nu + \sigma_\nu)^{-1}$ so that frequencies at which the extinction coefficient is small (the transparent regions) tend to dominate the averaging process. The weighting function $\partial B_\nu/\partial T$ [see Eq. (1.55)] has a general shape similar to that of the Planck function, but it now peaks at values of $h\nu/kT$ of order 3.8 instead of 2.8.

Although we have assumed a plane-parallel medium to prove the Rosseland formula, the result is quite general: the vector flux is in the direction opposite to the temperature gradient and has the magnitude given above. The only necessary assumption is that all quantities change slowly on the scale of any radiation mean free path.

The Eddington Approximation; Two-Stream Approximation

The basic idea behind the Rosseland approximation was that the intensities approach the Planck function at large effective depths in the medium. In the Eddington approximation, to be considered here, it is only assumed that the intensities approach *isotropy*, and not necessarily their thermal values. Because thermal emission and scattering are isotropic, one expects isotropy of the intensities to occur at depths of order of an ordinary mean free path; thus the region of applicability of the Eddington approximation is potentially much larger than the Rosseland approximation, the latter requiring depths of the order of the effective free path. With the use of appropriate boundary conditions (here introduced through the two-stream approximation) one can obtain solutions to scattering problems of reasonable accuracy at all depths.

The assumption of near isotropy is introduced by considering that the intensity is a power series in μ , with terms only up to linear:

$$I_\nu(\tau, \mu) = a_\nu(\tau) + b_\nu(\tau)\mu. \quad (1.112)$$

We now suppress the frequency variable ν for convenience in the following. Let us take the first three moments of this intensity:

$$J \equiv \frac{1}{2} \int_{-1}^{+1} I d\mu = a, \quad (1.113a)$$

$$H \equiv \frac{1}{2} \int_{-1}^{+1} \mu I d\mu = \frac{b}{3}, \quad (1.113b)$$

$$K \equiv \frac{1}{2} \int_{-1}^{+1} \mu^2 I d\mu = \frac{a}{3}. \quad (1.113c)$$

J is the mean intensity, and H and K are proportional to the flux and radiation pressure, respectively. Therefore, we have the result, known as the *Eddington approximation*:

$$K = \frac{1}{3}J. \quad (1.114)$$

Note the equivalence of this result to Eq. (1.10). The difference is that we have shown Eq. (1.114) to be valid even for slightly nonisotropic fields, containing terms linear in $\cos\theta$. Now defining the normal optical depth

$$d\tau(z) = -(\alpha_\nu + \sigma_\nu)dz, \quad (1.115)$$

we can write Eq. (1.104) as

$$\mu \frac{\partial I}{\partial \tau} = I - S. \quad (1.116)$$

The source function is given by Eq. (1.92) or (1.95) and is isotropic (independent of μ). If we multiply Eq. (1.116) by $\frac{1}{2}$ and integrate over μ from -1 to $+1$ we obtain

$$\frac{\partial H}{\partial \tau} = J - S \quad (1.117)$$

Similarly, multiplying by an extra factor μ before integrating, we obtain

$$\frac{\partial K}{\partial \tau} = H = \frac{1}{3} \frac{\partial J}{\partial \tau}, \quad (1.118)$$

using the Eddington approximation (1.114). These last two equations can be combined to yield

$$\frac{1}{3} \frac{\partial^2 J}{\partial \tau^2} = J - S. \quad (1.119a)$$

Use of Eq. (1.95) then gives a single second-order equation for J :

$$\frac{1}{3} \frac{\partial^2 J}{\partial \tau^2} = \epsilon(J - B). \quad (1.119b)$$

This equation is also sometimes called the *radiative diffusion equation*. Given the temperature structure of the medium, that is, $B(\tau)$, one can solve this equation for J and thus also determine S from Eq. (1.95). Then the problem is essentially solved, because the full intensity field $I(\tau, \mu)$ can be found by formal solution of Eq. (1.116).

44 Fundamentals of Radiative Transfer

An interesting form of Eq. (1.119b) can be derived in the case when ϵ does not depend on depth. Let us define the new optical depth scale

$$\tau_* \equiv \sqrt{3\epsilon} \tau = \sqrt{3\tau_a(\tau_a + \tau_s)}, \quad (1.120)$$

[cf. Eq. (1.98)]. The transfer equation is then

$$\frac{\partial^2 J}{\partial \tau_*^2} = J - B. \quad (1.121)$$

This equation can be used to demonstrate the properties of τ_* as an effective optical depth (see Problem 1.10).

To solve Eq. (1.119b), boundary conditions must be provided. This can be done in several ways, but here we use the *two-stream approximation*: It is assumed that the entire radiation field can be represented by radiation traveling at just *two* angles, $\mu = \pm 1/\sqrt{3}$. Let us denote the outward and inward intensities by $I^+(\tau) \equiv I(\tau, +1/\sqrt{3})$ and $I^-(\tau) \equiv I(\tau, -1/\sqrt{3})$. In terms of I^+ and I^- the moments J , H , and K have the representations

$$J = \frac{1}{2}(I^+ + I^-), \quad (1.122a)$$

$$H = \frac{1}{2\sqrt{3}}(I^+ - I^-), \quad (1.122b)$$

$$K = \frac{1}{6}(I^+ + I^-) = \frac{1}{3}J. \quad (1.122c)$$

This last equation is simply the Eddington approximation; in fact, the choice of the angles $\mu = \pm 1/\sqrt{3}$ is really motivated by the requirement that this relation be valid.

We now solve Eqs. (1.122a) and (1.122b) for I^+ and I^- , using Eq. (1.118):

$$I^+ = J + \frac{1}{\sqrt{3}} \frac{\partial J}{\partial \tau}, \quad (1.123a)$$

$$I^- = J - \frac{1}{\sqrt{3}} \frac{\partial J}{\partial \tau}. \quad (1.123b)$$

These equations can provide the necessary boundary conditions for the differential Eq. (1.119b). For example, suppose the medium extends from

$\tau=0$ to $\tau=\tau_0$, and there is no incident radiation. Then $I^-(0)=0$ and $I^+(\tau_0)=0$, so that the boundary conditions are

$$\frac{1}{\sqrt{3}} \frac{\partial J}{\partial \tau} = J \quad \text{at } \tau=0, \tag{1.124a}$$

$$\frac{1}{\sqrt{3}} \frac{\partial J}{\partial \tau} = -J \quad \text{at } \tau=\tau_0. \tag{1.124b}$$

These two conditions are sufficient to determine the solution of the second-order differential Eq. (1.119b).

Different methods for obtaining boundary conditions have been proposed; they all give equations of the form (1.124), but with constants slightly different than $1/\sqrt{3}$. For our purposes, it is not worth discussing these alternatives in detail. Examples of the use of the Eddington approximation to solve problems involving scattering are given in Problem 1.10.

PROBLEMS

1.1—A “pinhole camera” consists of a small circular hole of diameter d , a distance L from the “film-plane” (see Fig. 1.14). Show that the flux F_ν at the film plane depends on the brightness field $I_\nu(\theta, \phi)$ by

$$F_\nu = \frac{\pi \cos^4 \theta}{4f^2} I_\nu(\theta, \phi),$$

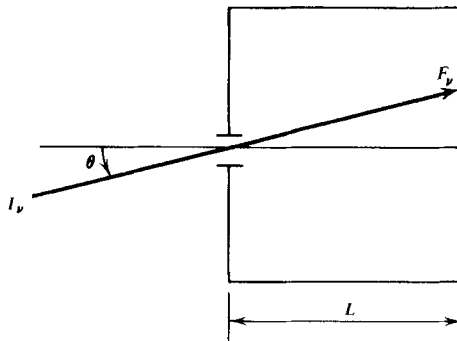

Figure 1.14 Geometry for a pinhole camera.

46 *Fundamentals of Radiative Transfer*

where the “focal ratio” is $f = L/d$. This is a simple, if crude, method for measuring I_ν .

1.2—Photoionization is a process in which a photon is absorbed by an atom (or molecule) and an electron is ejected. An energy at least equal to the ionization potential is required. Let this energy be $h\nu_0$ and let σ_ν be the cross section for photoionization. Show that the number of photoionizations per unit volume and per unit time is

$$4\pi n_a \int_{\nu_0}^{\infty} \frac{\sigma_\nu J_\nu}{h\nu} d\nu = cn_a \int_{\nu_0}^{\infty} \frac{\sigma_\nu u_\nu}{h\nu} d\nu,$$

where n_a = number density of atoms.

1.3—X-Ray photons are produced in a cloud of radius R at the uniform rate Γ (photons per unit volume per unit time). The cloud is a distance d away. Neglect absorption of these photons (optically thin medium). A detector at earth has an angular acceptance beam of half-angle $\Delta\theta$ and it has an effective area of ΔA .

- a. Assume that the source is completely resolved. What is the observed intensity (photons per unit time per unit area per steradian) toward the center of the cloud.
- b. Assume that the source is completely unresolved. What is the observed average intensity when the source is in the beam of the detector?

1.4

- a. Show that the condition that an optically thin cloud of material can be ejected by radiation pressure from a nearby luminous object is that the mass to luminosity ratio (M/L) for the object be less than $\kappa/(4\pi Gc)$, where G = gravitational constant, c = speed of light, κ = mass absorption coefficient of the cloud material (assumed independent of frequency).
- b. Calculate the terminal velocity v attained by such a cloud under radiation and gravitational forces alone, if it starts from rest a distance R from the object. Show that

$$v^2 = \frac{2GM}{R} \left(\frac{\kappa L}{4\pi GMc} - 1 \right).$$

- c. A minimum value for κ may be estimated for pure hydrogen as that due to Thomson scattering off free electrons, when the hydrogen is

completely ionized. The Thomson cross section is $\sigma_T = 6.65 \times 10^{-25} \text{ cm}^2$. The mass scattering coefficient is therefore $> \sigma_T / m_H$, where m_H = mass of hydrogen atom. Show that the maximum luminosity that a central mass M can have and still not spontaneously eject hydrogen by radiation pressure is

$$\begin{aligned} L_{\text{EDD}} &= 4\pi GMcm_H / \sigma_T \\ &= 1.25 \times 10^{38} \text{ erg s}^{-1} (M/M_\odot), \end{aligned}$$

where

$$M_\odot \equiv \text{mass of sun} = 2 \times 10^{33} \text{ g.}$$

This is called the *Eddington limit*.

1.5—A supernova remnant has an angular diameter $\theta = 4.3$ arc minutes and a flux at 100 MHz of $F_{100} = 1.6 \times 10^{-19} \text{ erg cm}^{-2} \text{ s}^{-1} \text{ Hz}^{-1}$. Assume that the emission is thermal.

- a. What is the brightness temperature T_b ? What energy regime of the blackbody curve does this correspond to?
- b. The emitting region is actually more compact than indicated by the observed angular diameter. What effect does this have on the value of T_b ?
- c. At what frequency will this object's radiation be maximum, if the emission is blackbody?
- d. What can you say about the temperature of the material from the above results?

1.6—Prove that the entropy of blackbody radiation S is related to temperature T and volume V by

$$S = \frac{4}{3} aT^3V.$$

1.7

- a. Show that if stimulated emission is neglected, leaving only two Einstein coefficients, an appropriate relation between the coefficients will be consistent with thermal equilibrium between the atom and a radiation field of a Wien spectrum, but not of a Planck spectrum.

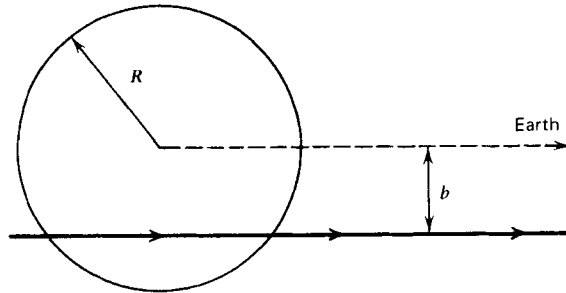

Figure 1.15 *Detection of rays from a spherical emitting cloud of radius R .*

- b. Rederive the relation between the Einstein coefficients by imagining the atom to be in thermal equilibrium with a neutrino field (spin $1/2$) rather than a photon field (spin 1).

Hint: Neutrinos are Fermi–Dirac particles and obey the exclusion principle. In addition, their equilibrium intensity is given by

$$I_\nu = \frac{2h\nu^3/c^2}{\exp(h\nu/kT) + 1}.$$

1.8—A certain gas emits thermally at the rate $P(\nu)$ (power per unit volume and frequency range). A spherical cloud of this gas has radius R , temperature T and is a distance d from earth ($d \gg R$).

- Assume that the cloud is optically *thin*. What is the brightness of the cloud as measured on earth? Give your answer as a function of the distance b away from the cloud center, assuming the cloud may be viewed along parallel rays as shown in Fig. 1.15.
- What is the effective temperature of the cloud?
- What is the flux F_ν measured at earth coming from the entire cloud?
- How do the measured brightness temperatures compare with the cloud's temperature?
- Answer parts (a)–(d) for an optically *thick* cloud.

1.9—A spherical, opaque object emits as a blackbody at temperature T_c . Surrounding this central object is a spherical shell of material, thermally emitting at a temperature T_s ($T_s < T_c$). This shell absorbs in a narrow spectral line; that is, its absorption coefficient becomes large at the frequency ν_0 and is negligibly small at other frequencies, such as ν_1 :

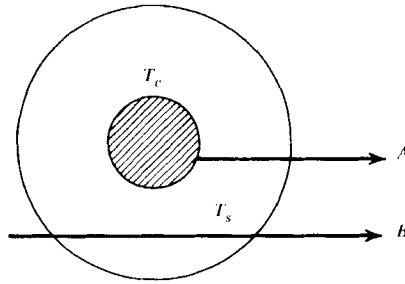

(b)

Figure 1.16a Blackbody emitter at temperature T_c surrounded by an absorbing shell at temperature T_s , viewed along rays A and B .

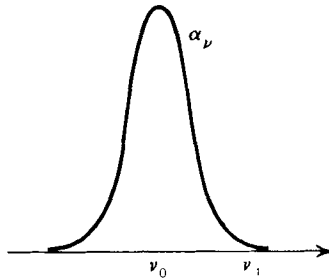

(a)

Figure 1.16b Absorption coefficient of the material in the shell.

$\alpha_{\nu_0} \gg \alpha_{\nu_1}$ (see Fig. 1.16). The object is observed at frequencies ν_0 and ν_1 and along two rays A and B shown above. Assume that the Planck function does not vary appreciably from ν_0 to ν_1 .

- a. At which frequency will the observed brightness be larger when observed along ray A ? Along ray B ?
- b. Answer the preceding questions if $T_s > T_c$.

1.10—Consider a semi-infinite half space in which both scattering (σ) and absorption and emission (α_ν) occur. Idealize the medium as homogeneous and isothermal, so that the coefficients σ and α_ν do not vary with depth. Further assume the scattering is isotropic (which is a good approximation to the forward-backward symmetric Thomson differential

50 *Fundamentals of Radiative Transfer*

cross section).

- a. Using the radiative diffusion equation with two-stream boundary conditions, find expressions for the mean intensity $J_\nu(\tau)$ in the medium and the emergent flux $F_\nu(0)$.
- b. Show that $J_\nu(\tau)$ approaches the blackbody intensity at an effective optical depth of order $\tau_* = \sqrt{3\tau_a(\tau_a + \tau_s)}$.

REFERENCES

- Mihalas, D., 1978, *Stellar Atmospheres*. (Freeman, San Francisco).
Reif, F., 1965, *Fundamentals of Statistical and Thermal Physics* (McGraw-Hill, New York).