

# Astrofisica Nucleare e Subnucleare

## Gamma ray Bursts – III

# BeppoSAX (1995 - 2002 )

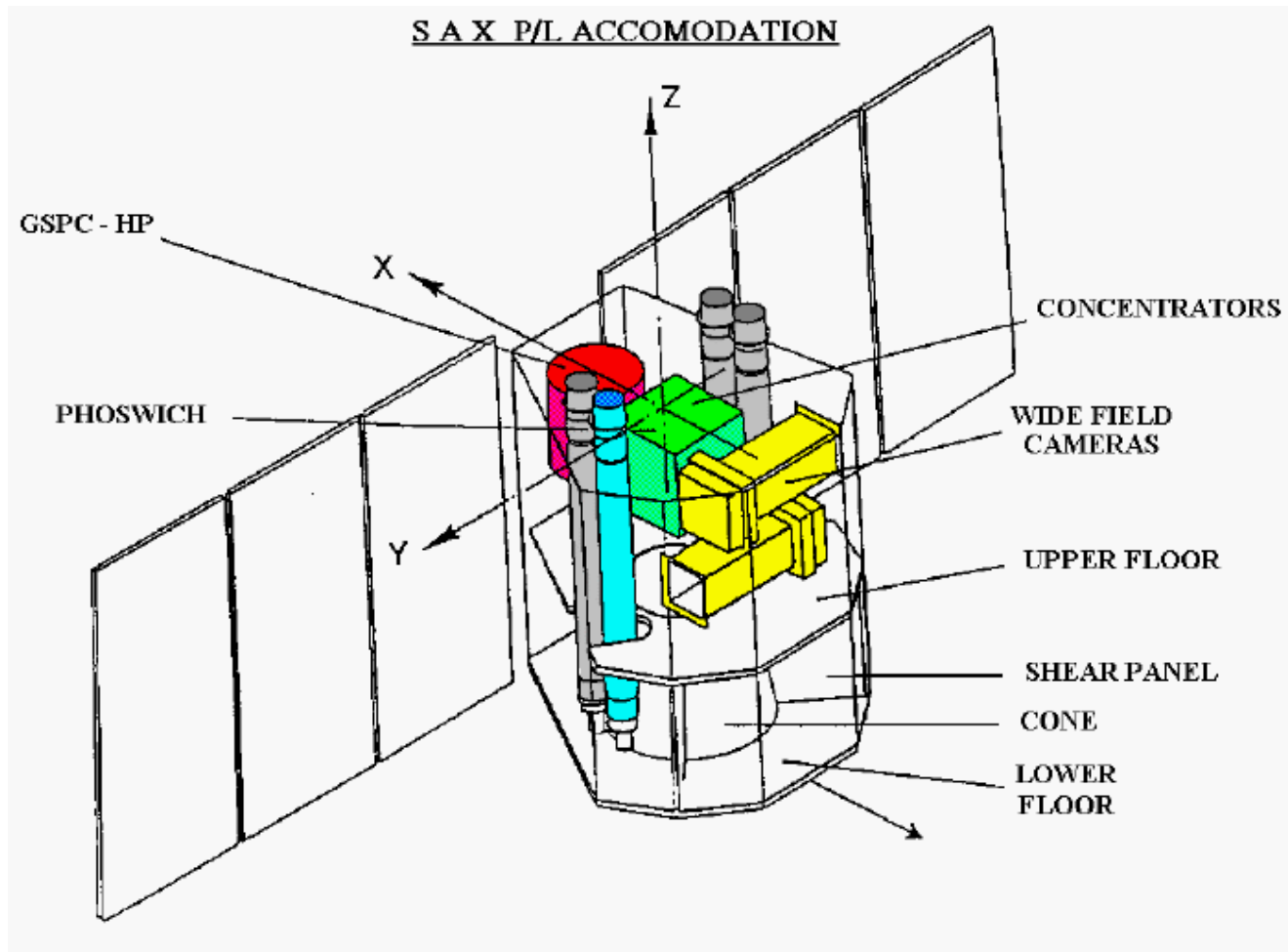



# Coded Mask Imaging

The principle of the camera is straightforward: photons from a certain direction in the sky project the mask on the detector; this projection has the same coding as the mask pattern, but is shifted relative to the central position over a distance uniquely correspondent to the direction of the photons. The detector accumulates the sum of a number of shifted mask patterns. Each shift encodes the position and its strength encodes the intensity of the sky at that position.

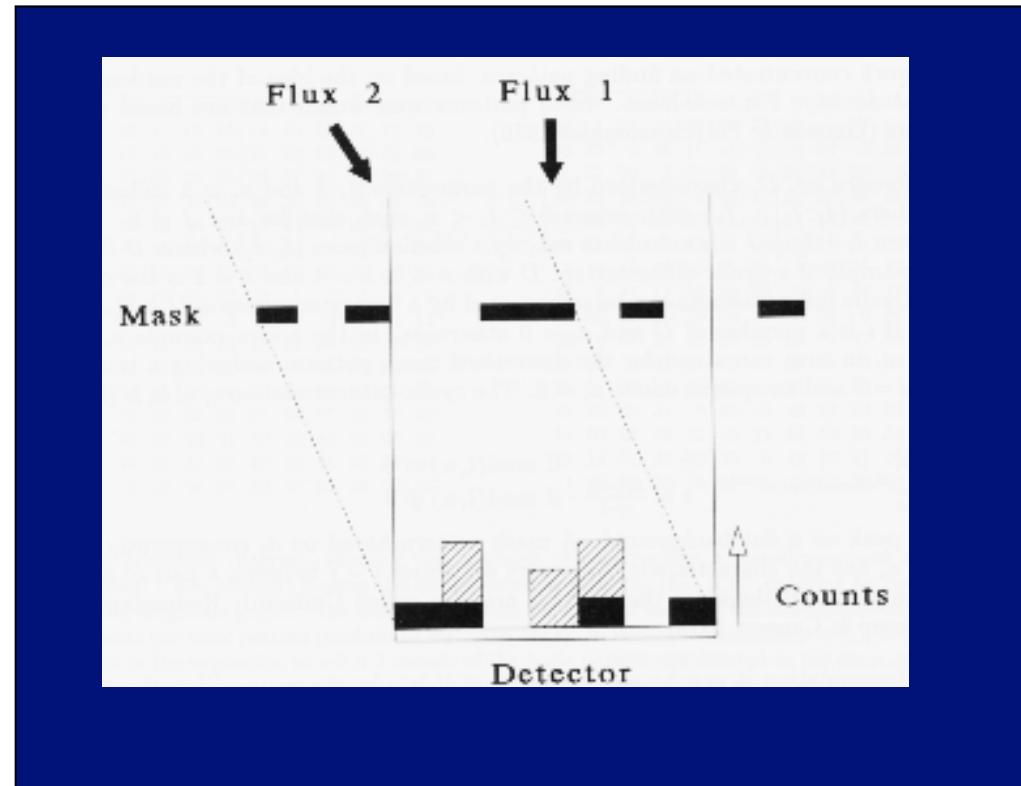

[http://asd.gsfc.nasa.gov/archive/cai/coded\\_intr.html](http://asd.gsfc.nasa.gov/archive/cai/coded_intr.html)

# Coded Mask Imaging

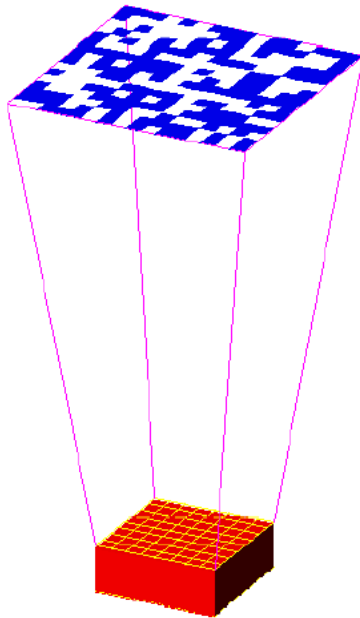

## How to recover an image

Basic method :

' Correlation with the Mask Pattern '

Recorded pattern is Convolution of source distribution and the mask pattern, plus some background B

$$D = S \otimes M + B$$

Suppose we form an image as<sup>†</sup>

$$I = M \otimes D = M \otimes S \otimes M + M \otimes B$$

$$= M \otimes M \otimes S + M \otimes B$$

$$= ACF(M) \otimes S + M \otimes B$$

where ACF indicated the Autocorrelation function.

If ACF(M) were a Delta function and if  $M \otimes B$  were zero we would have recovered S.

<sup>†</sup> coordinate reversals are ignored here

- in 1997, thanks to BeppoSAX observations, discovery of fading X-ray, optical, radio emission following the GRB
- photons received during the classical GRB phenomenon are then called “**prompt emission**” and the subsequent fading emission is called “**afterglow emission**”

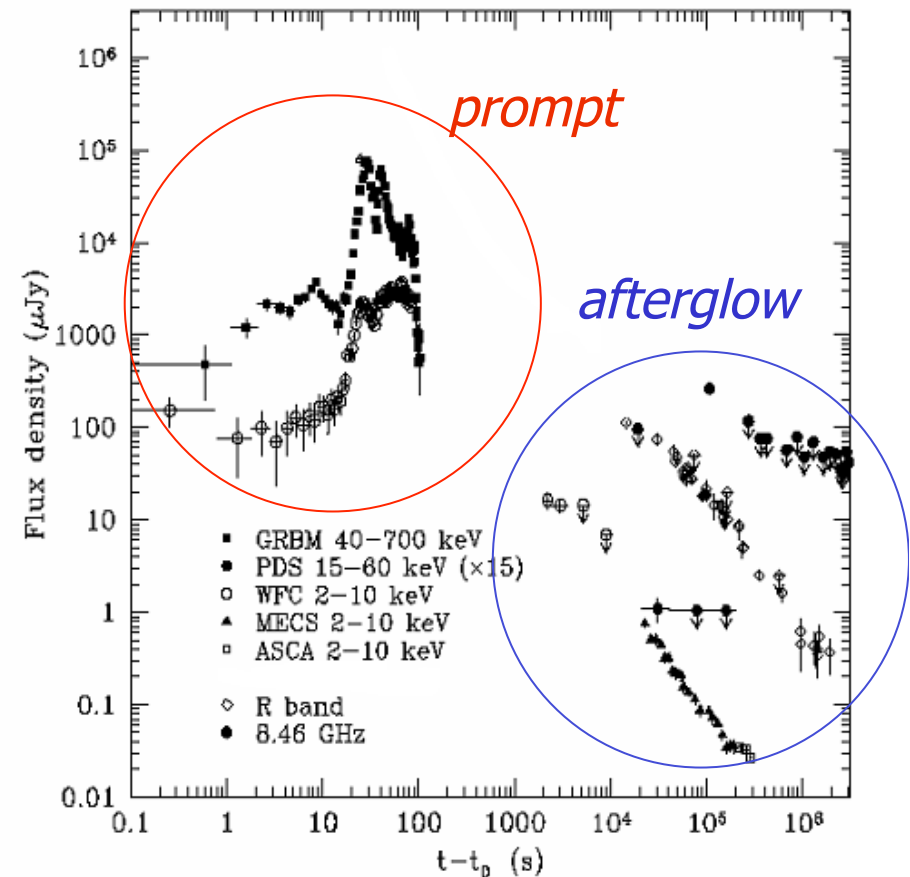

Adapted from Maiorano et al.,  
A&A, 2005

# The compactness problem

Light curve variability  $\sim 1$  ms

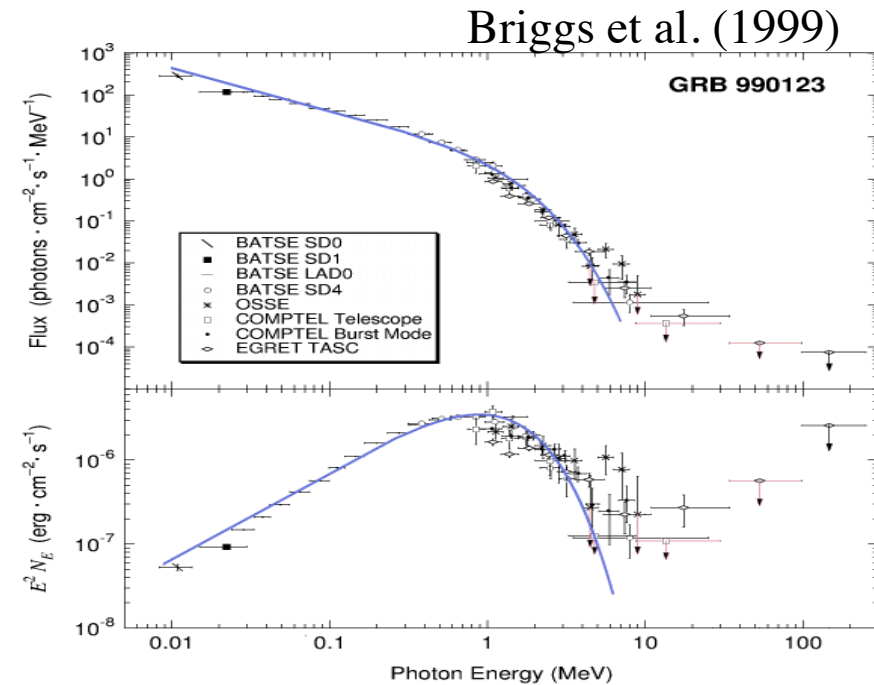
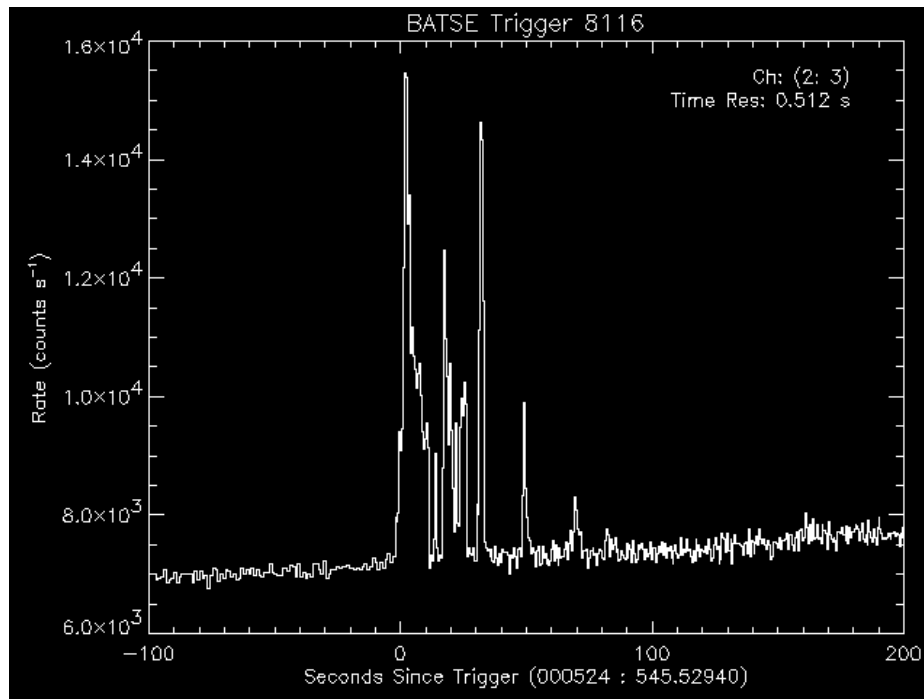

Non thermal spectra

- Fluence ( $\gamma$ ):  $(0.1-10) \times 10^{-6}$  erg/cm $^2$  ( $\Omega/4\pi$ )
- Total Energy:  $E \sim 10^{51} \div 10^{52}$  erg

# The compactness problem

$$R_i < c\delta t \quad \gamma\gamma \rightarrow e^+e^-$$

$$\tau_{\gamma\gamma} = \frac{f_p \sigma_T F D_L^2}{R_i^2 m_e c^2} \approx 10^{17} f_p \left( \frac{F}{10^{-6} \text{ erg/cm}^2} \right) \left( \frac{D_L}{3 \text{ Gpc}} \right)^2 \left( \frac{\delta t}{1 \text{ ms}} \right)$$

$$\tau_{\gamma\gamma} \gg 1$$

Very High Optical Depth to pair production

$$\Gamma = \frac{1}{\sqrt{1 - \beta^2}}$$

$$R_i < \Gamma^2 c\delta t \quad f_p \rightarrow f_p \Gamma^{-2\alpha}$$

Size

Pair fraction

$$\tau_{\gamma\gamma} = \frac{f_p \sigma_T F D_L^2}{R_i^2 m_e c^2} \approx \frac{10^{17}}{\Gamma^{4+2\alpha}} f_p \left( \frac{F}{10^{-6} \text{ erg/cm}^2} \right) \left( \frac{D_L}{3 \text{ Gpc}} \right)^2 \left( \frac{\delta t}{1 \text{ ms}} \right)$$

$$\Gamma \approx 10^2 \div 10^3$$

Piran (1999)

Relativistic motion of the emitting region

# The Fireball model

- Relativistic motion of the emitting region
- Shock mechanism converts the kinetic energy of the shells into radiation.
- Baryon Loading problem

## External Shock

- Synchrotron & SSC
- High conversion efficiency
- Not easy to justify the rapid variability

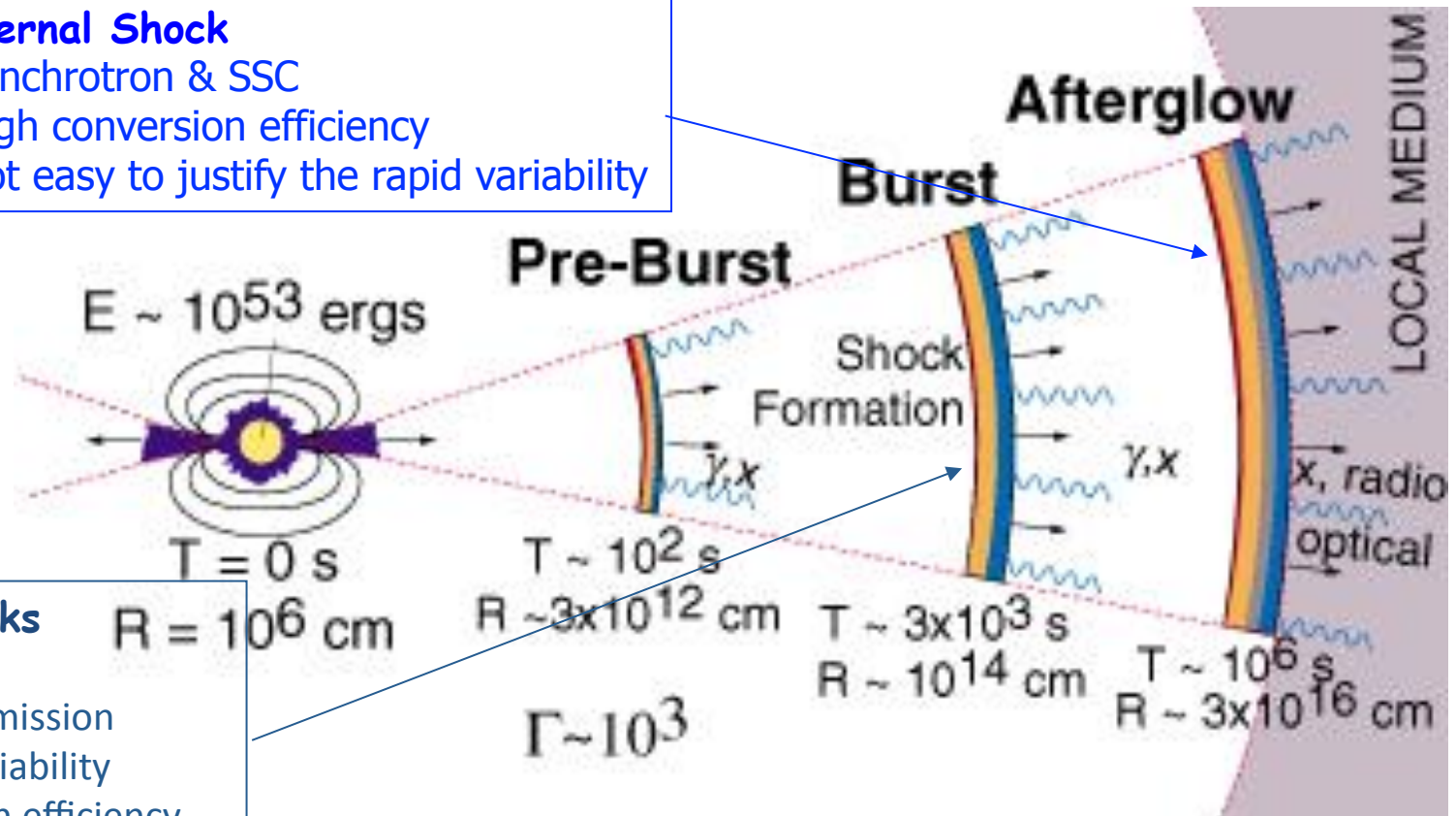

## Internal Shocks

- Source activity
- Synchrotron Emission
- Rapid time Variability
- Low conversion efficiency



# Afterglow Observations

Harrison et al (1999)

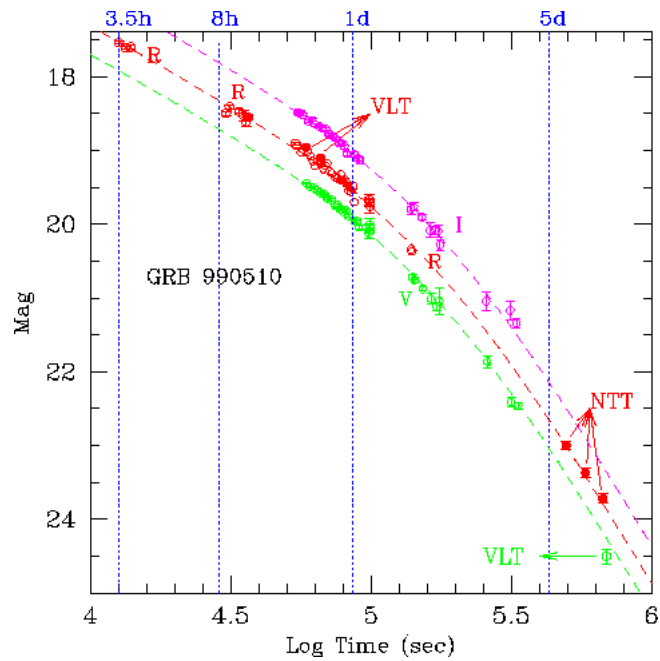

Achromatic Break

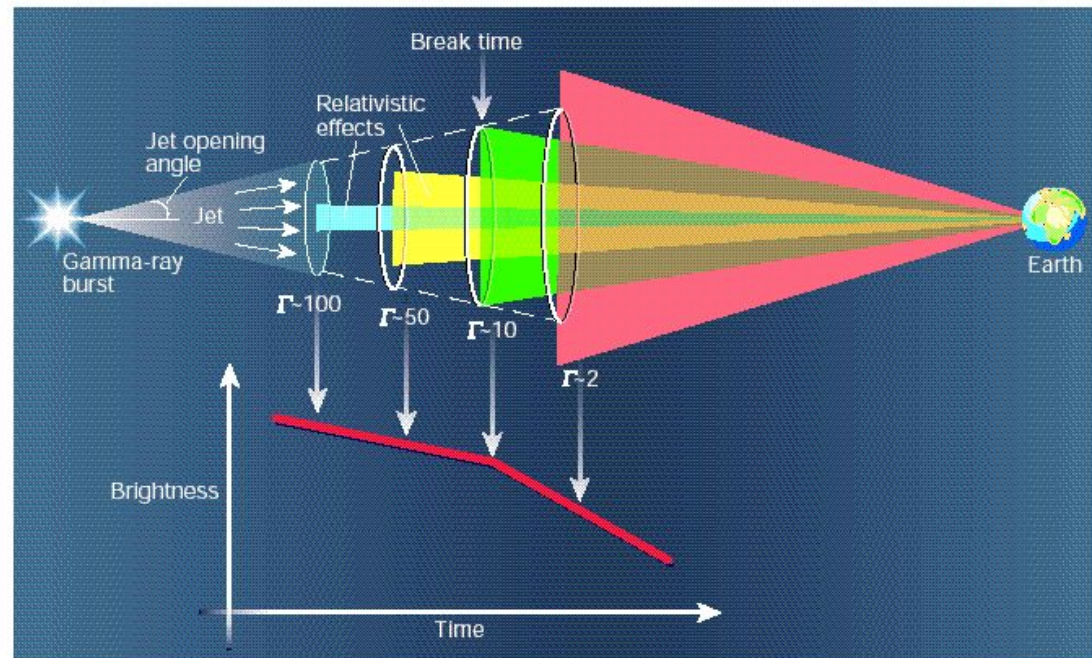

Woosley (2001)

# Jet breaks

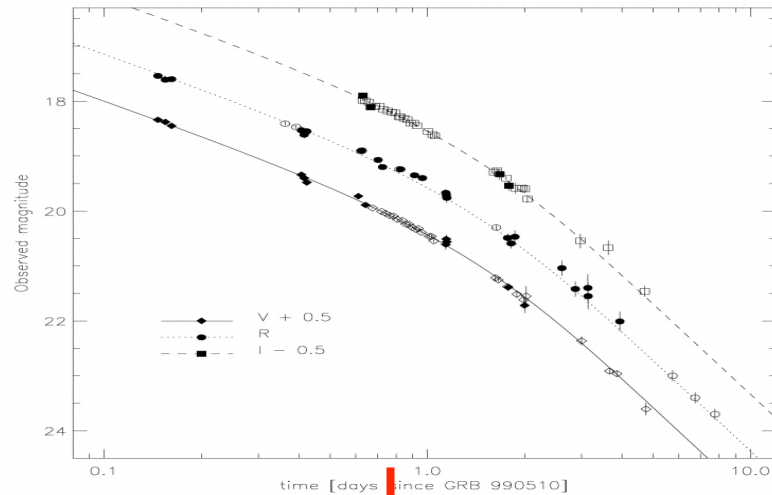

➤ breaks in the afterglow decay light curves -> collimation ?

$$\theta = 0.09 \left( \frac{t_{jet,d}}{1+z} \right)^{3/8} \left( \frac{n\eta_\gamma}{E_{\gamma,iso,52}} \right)^{1/8}$$

$$E_\gamma = (1 - \cos \theta) E_{\gamma,iso}$$

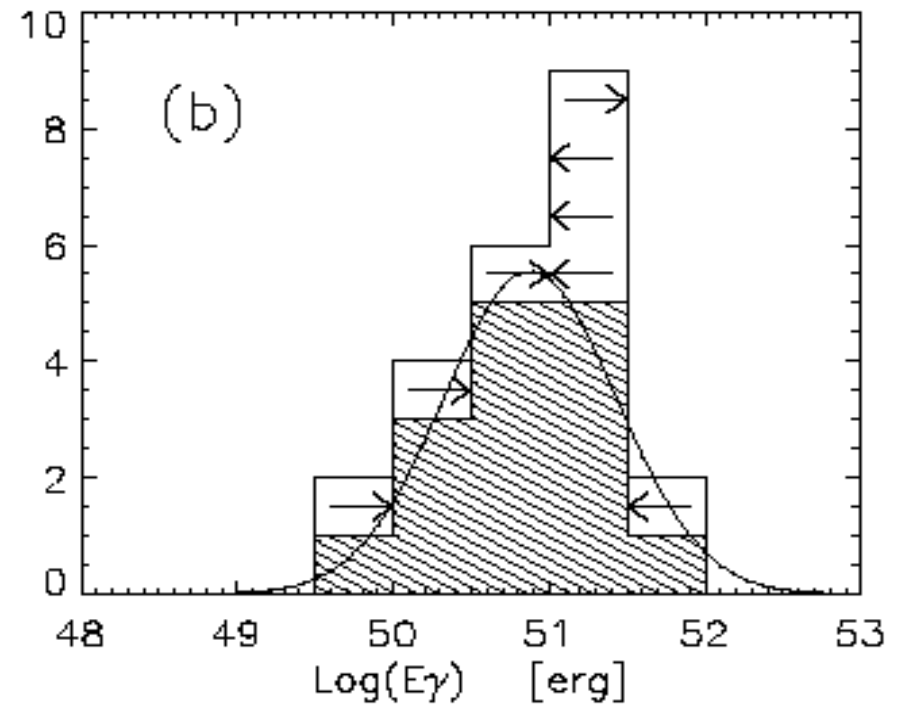



# GRB for Cosmology

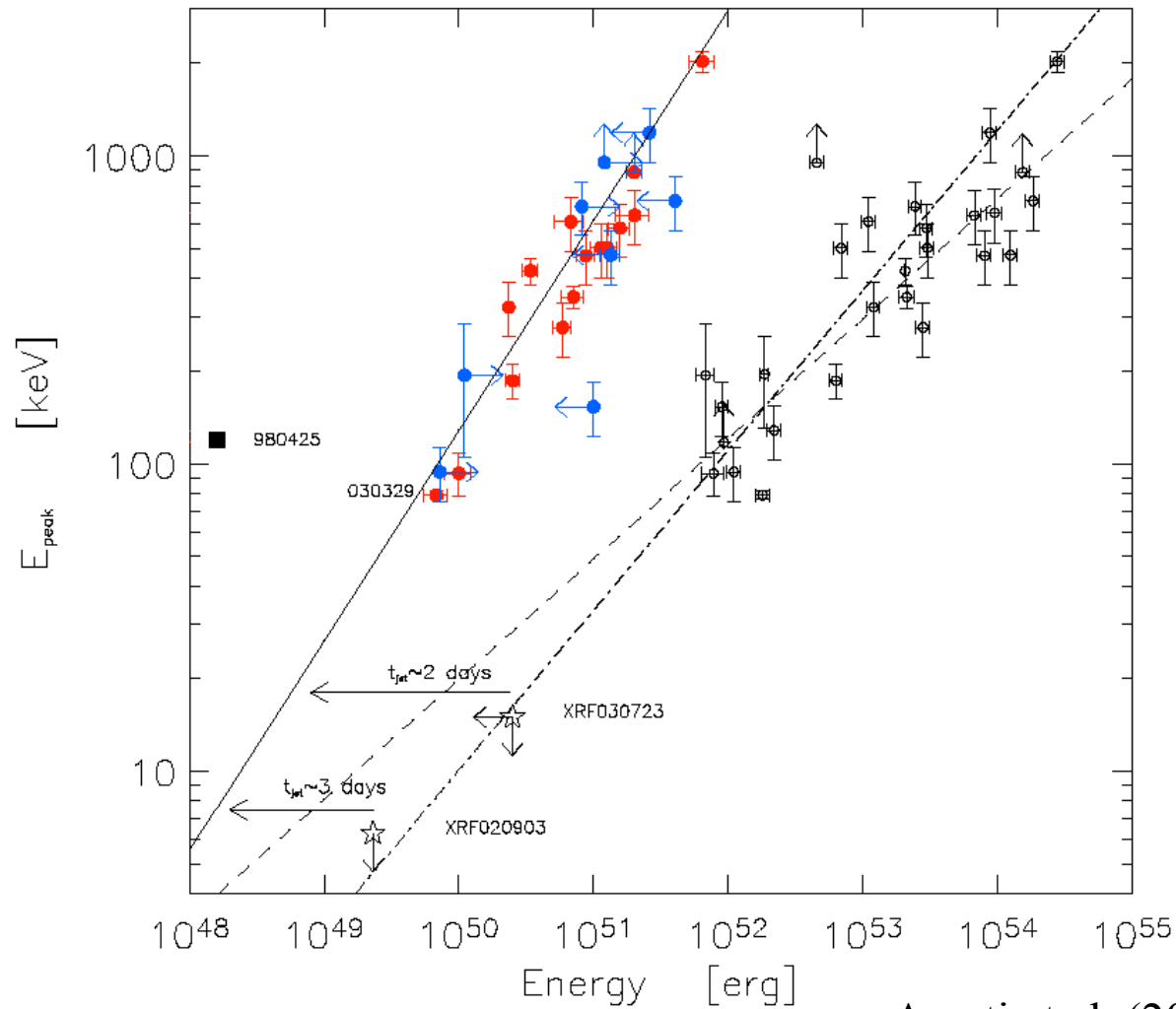

Amati et al. (2002)  
Ghirlanda et al. (2004)

# The “Relationships”

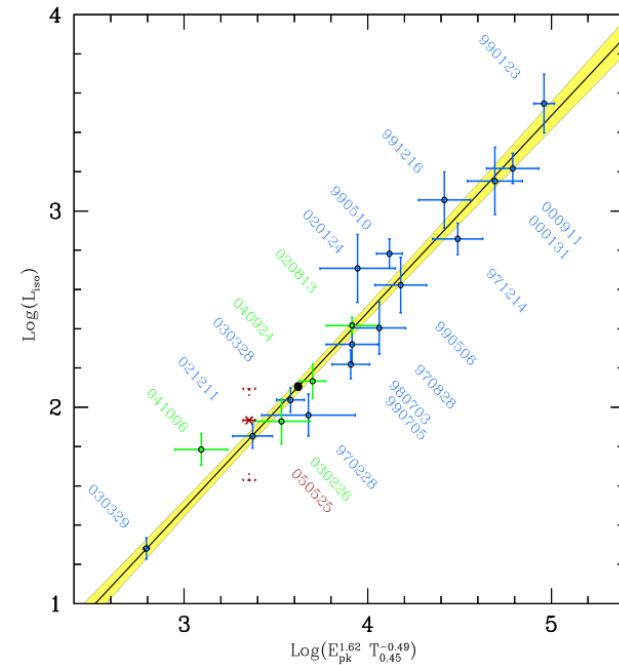
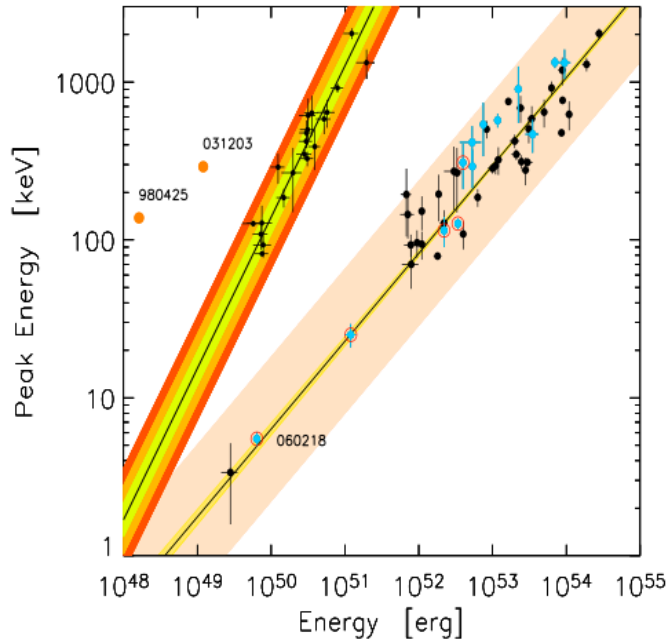

- Amati ( et al. 2002):  $E_{\text{peak}}-E_{\text{iso}}$  ( $E_{\text{peak}}$ , redshift)
- Ghirlanda (et al. 2004):  $E_{\text{peak}}-E_{\text{gamma}}$  ( $E_{\text{peak}}$ , redshift,  $T_{\text{break}}$ )
- Firmani (et al. 2006): bring  $T_{45}$  into  $E_{\text{peak}}$  and  $E_{\text{iso}}$ .
- Fenimore & Ramirez-Ruiz (2000):  $E_{\text{iso}}$  - variability in Gamma-rays
- Norris (et al. 2000): lag-luminosity relation. Short lag = luminous.
  - (Lags measured in observer frame i.e. not z-corrected)
- Use these relationships to infer a pseudo-redshift from a measurement of spectral parameters or lags and luminosities in observer frame.... many more bursts without measured z than with.
  - =>GRB as cosmological probe

# SN Ia Cosmology

## SNe Ia as a “standard candle”

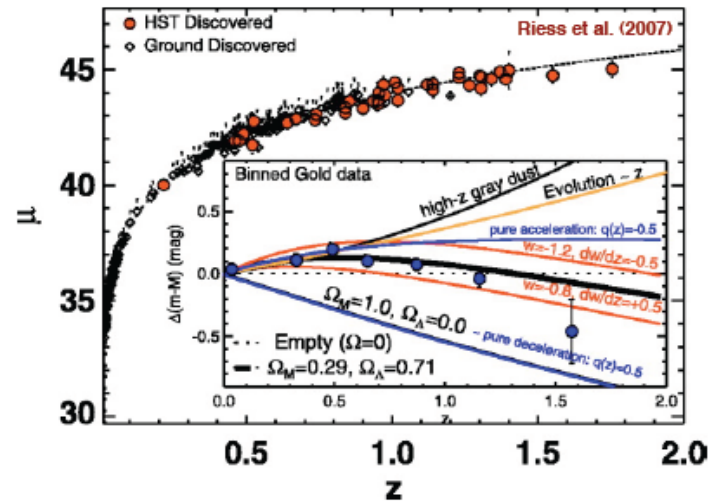
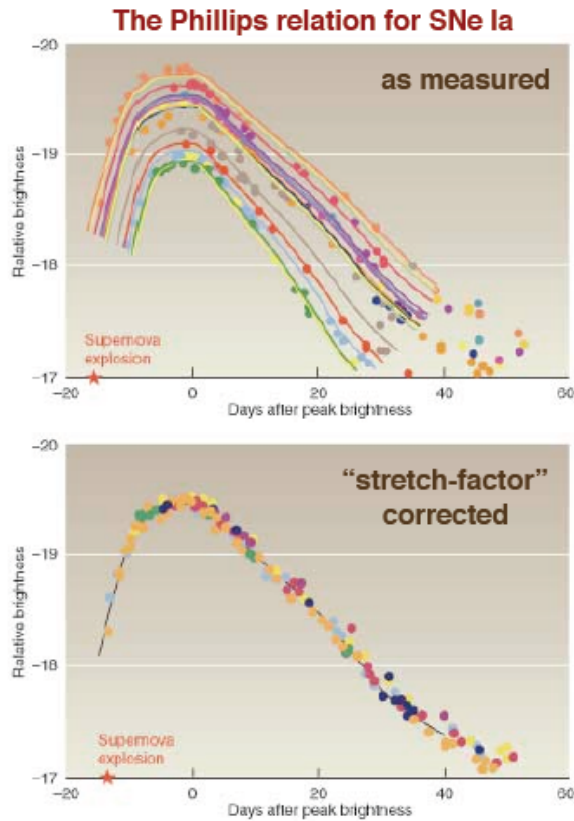

Can we apply GRBs as a standardized candle?

# GRB for Cosmology

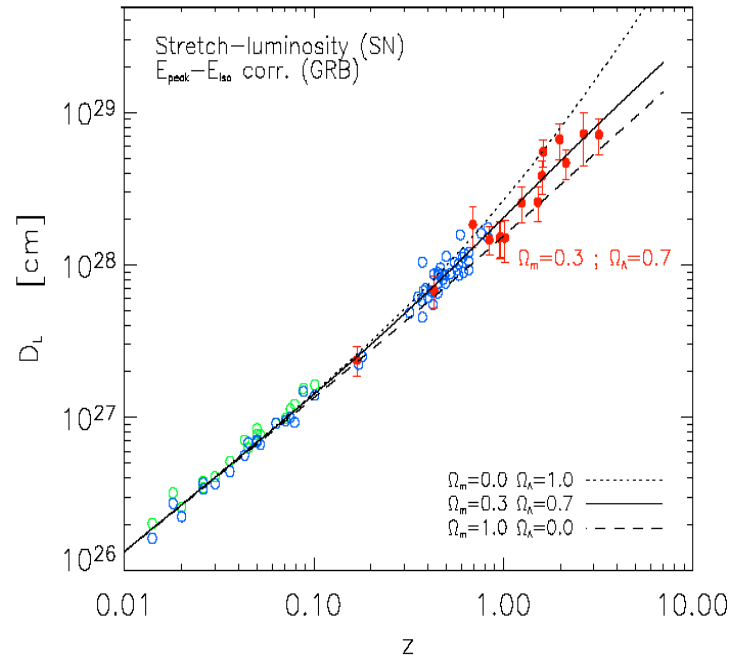

Ghirlanda et al. (2004)

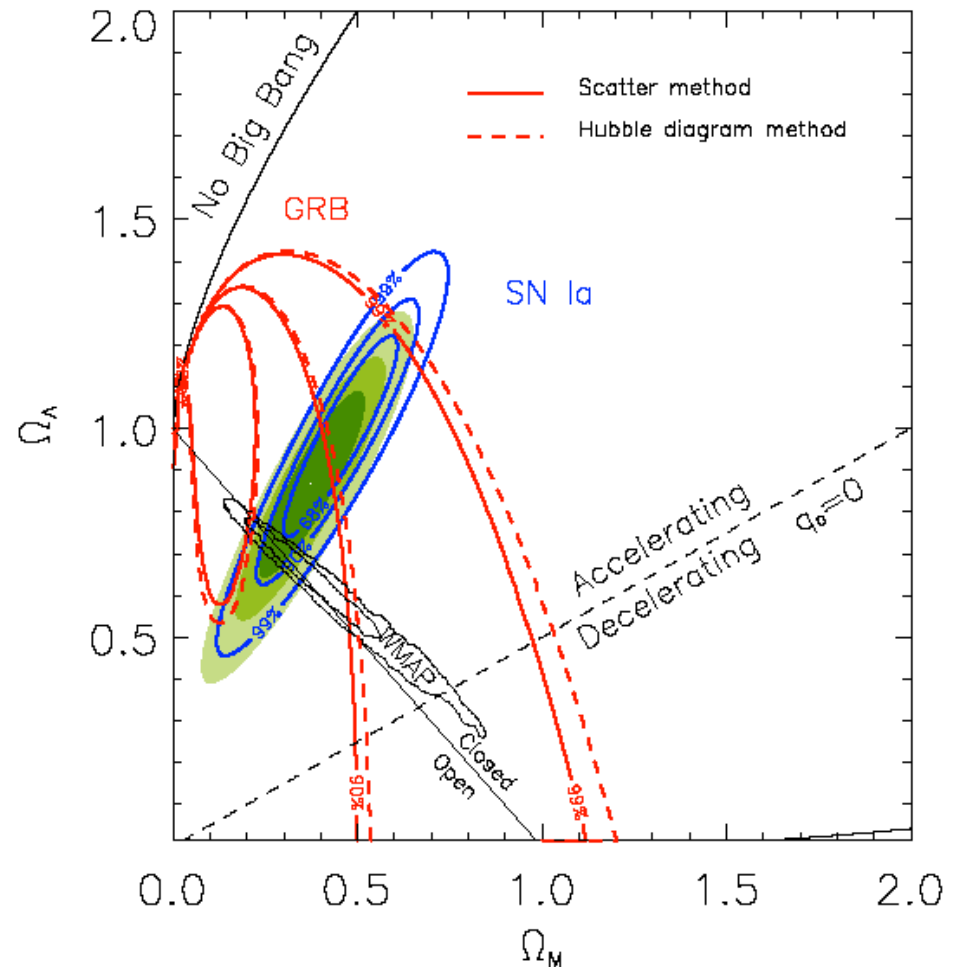

□ **Method** (e.g., Ghirlanda et al, Firmani et al., Dai et al., Zhang et al.):

$$E_{p,i} = E_{p,obs} \times (1 + z), \quad t_{b,i} = t_b / (1 + z)$$

$$E_{\gamma,iso} = \frac{4\pi D_L^2}{(1+z)} \int_{1/(1+z)}^{10^4/(1+z)} E N(E) dE \quad \text{erg} \quad \rightarrow \quad D_L = D_L(z, H_0, \Omega_M, \Omega_\Lambda, \dots)$$

➤ fit the correlation and construct an Hubble diagram for each set of cosmological parameters -> derive c.l. contours based on chi-square

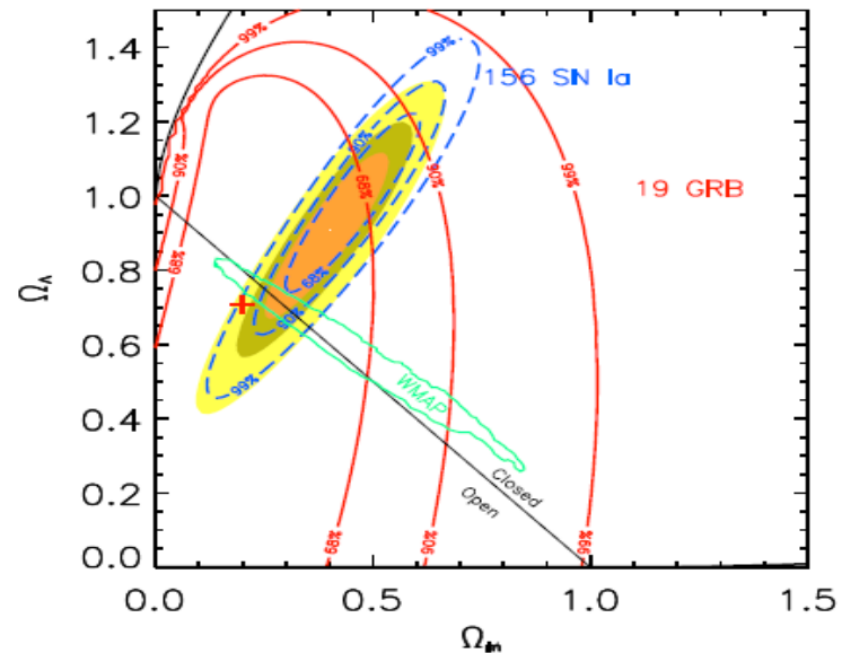
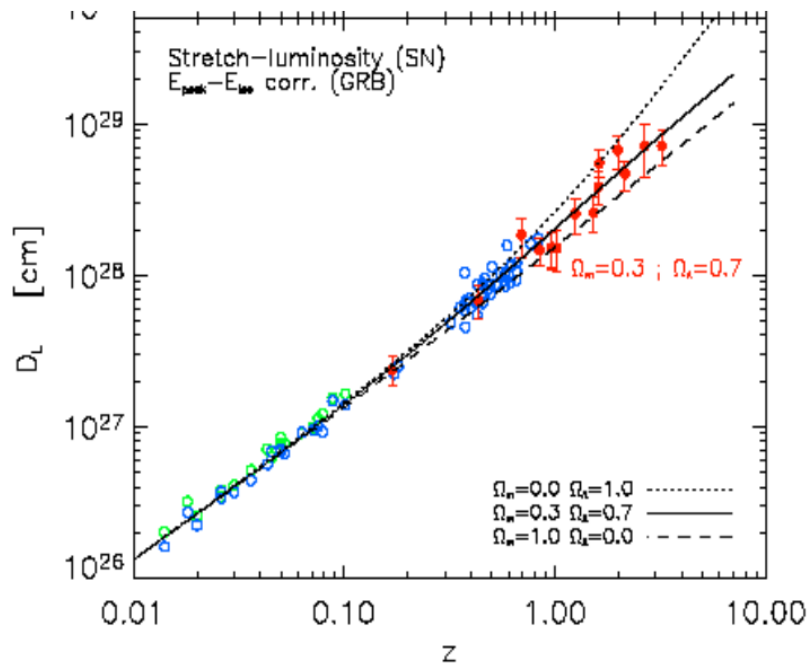

□ results obtainable with 150 GRBs with estimates of  $z$ ,  $E_{p,i}$  and  $t_b$

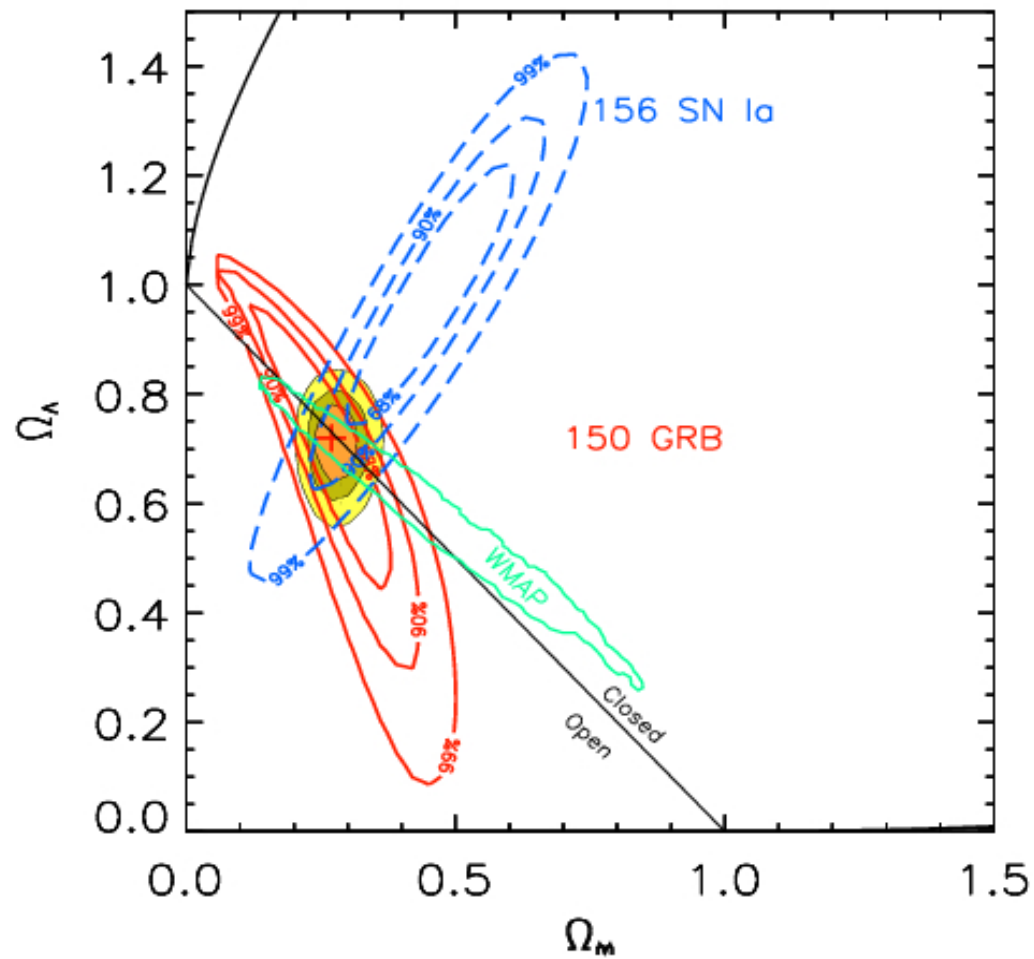

Ghirlanda et al. 2006 A&A

Ghirlanda et al. 2006 JOP Review, GRB Special Issue

# Caveats

## GRBs as a standard candle?

### Caveats:

- lack of a low-z calibration sample
- $E_{\text{peak}} \in [10 \text{ keV}, 1 \text{ MeV}]$ , not always well constrained
- $\Theta_{\text{jet}}$  is model dependent

For a homogeneous circumburst medium (Sari et al. 1999)

$$\theta_{\text{jet}} = 0.161 \left( \frac{t_{\text{jet,d}}}{1+z} \right)^{3/8} \left( \frac{n \eta_{\gamma}}{E_{\text{iso},52}} \right)^{1/8}$$

For a wind profile from massive stars (Nava et al. 2006)

$$n(r) = A/r^2$$

$$\theta_{\text{jet}} = 0.206 \left( \frac{t_{\text{jet,d}}}{1+z} \right)^{1/4} \left( \frac{A_* \eta_{\gamma}}{E_{\text{iso},52}} \right)^{1/4}$$

$$A = \dot{M}_w / (4\pi v_w) = 5 \times 10^{11} A_* \text{ g cm}^{-1}$$

- uncertain jet break time and CBM density

The Ghirlanda  $E_p - E_{\gamma}$  relation (2004)

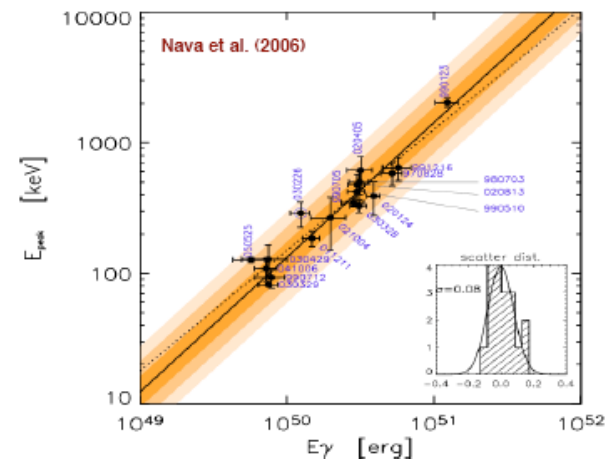
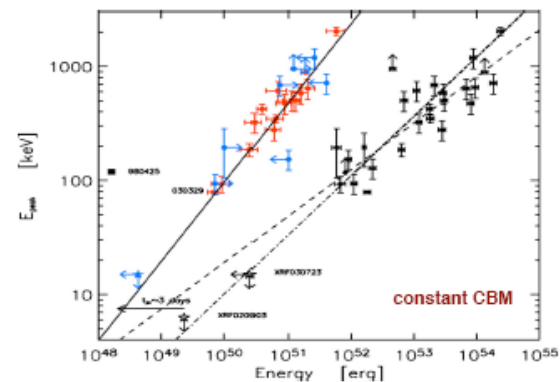

# Luminosity distance

## Distance measures in cosmology

DAVID W. HOGG

*Institute for Advanced Study, 1 Einstein Drive, Princeton NJ 08540*

`hogg@ias.edu`

2000 December

arXiv:astro-ph/9905116v4 16 Dec 2000

## 1 Introduction

In cosmology (or to be more specific, *cosmography*, the measurement of the Universe) there are many ways to specify the distance between two points, because in the expanding Universe, the distances between comoving objects are constantly changing, and Earth-bound observers look back in time as they look out in distance. The unifying aspect is that all distance measures somehow measure the separation between events on radial null trajectories, ie, trajectories of photons which terminate at the observer.

In this note, formulae for many different cosmological distance measures are provided. I treat the concept of “distance measure” very liberally, so, for instance, the lookback time and comoving volume are both considered distance measures. The bibliography of source material can be consulted for many of the derivations; this is merely a “cheat sheet.” Minimal *C* routines (KR) which compute all of these distance measures are available from the author upon request. Comments and corrections are highly appreciated, as are acknowledgments or citation in research that makes use of this summary or the associated code.

## 2 Cosmographic parameters

The *Hubble constant*  $H_0$  is the constant of proportionality between recession speed  $v$  and distance  $d$  in the expanding Universe;

$$v = H_0 d \tag{1}$$

The subscripted “0” refers to the present epoch because in general  $H$  changes with time.



# The Luminosity Distance

$$\Omega_M + \Omega_\Lambda + \Omega_k = 1 \quad z \equiv \frac{\nu_e}{\nu_o} - 1 = \frac{\lambda_o}{\lambda_e} - 1$$

$$E(z) \equiv \sqrt{\Omega_M (1+z)^3 + \Omega_k (1+z)^2 + \Omega_\Lambda}$$

$$H_0 = 100 h \text{ km s}^{-1} \text{ Mpc}^{-1} \quad D_H \equiv \frac{c}{H_0} \quad D_C = D_H \int_0^z \frac{dz'}{E(z')}$$

$$D_M = \begin{cases} D_H \frac{1}{\sqrt{\Omega_k}} \sinh \left[ \sqrt{\Omega_k} D_C / D_H \right] & \text{for } \Omega_k > 0 \\ D_C & \text{for } \Omega_k = 0 \\ D_H \frac{1}{\sqrt{|\Omega_k|}} \sin \left[ \sqrt{|\Omega_k|} D_C / D_H \right] & \text{for } \Omega_k < 0 \end{cases}$$

$$D_L = (1+z) D_M$$

# Luminosity distance and redshift

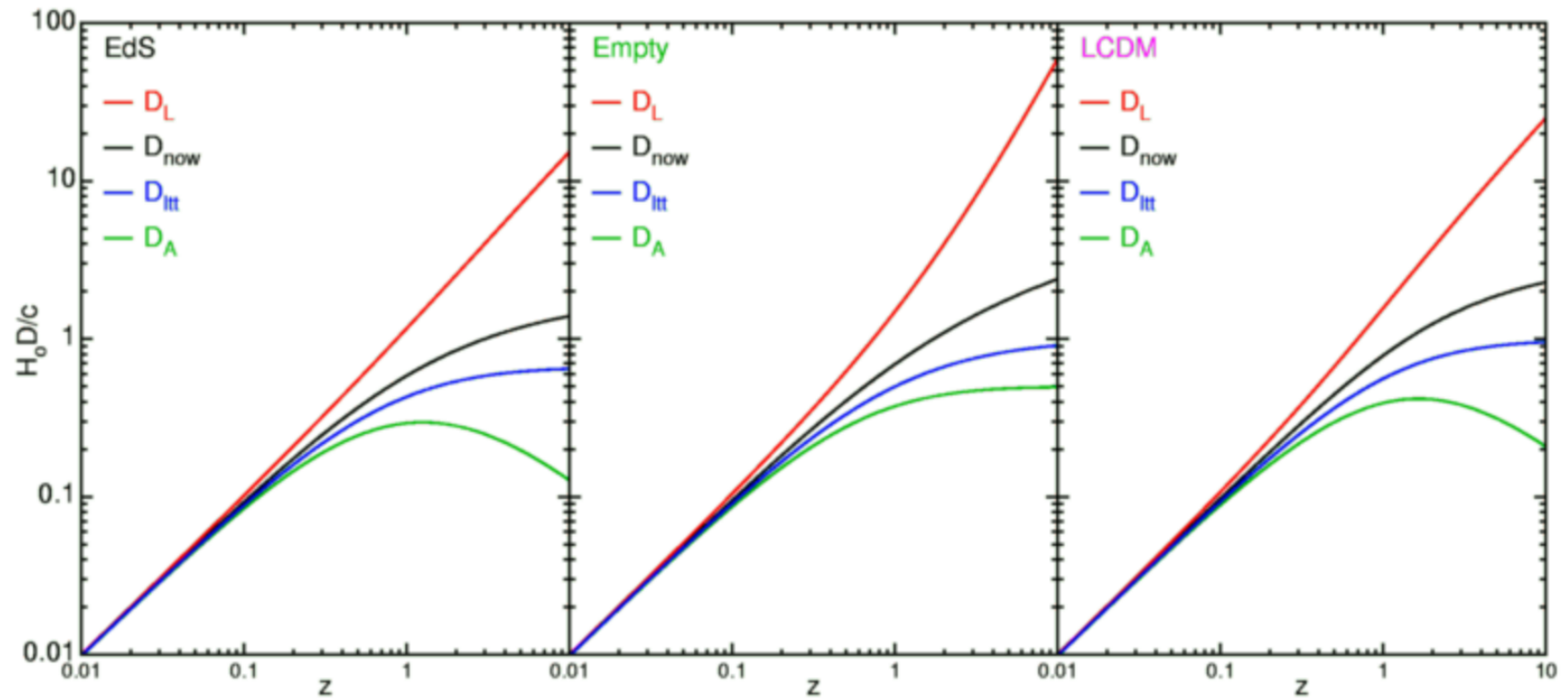

# Swift Instruments

## Instruments

- **Burst Alert Telescope (BAT)**
  - New CdZnTe detectors
  - Most sensitive gamma-ray imager ever
- **X-Ray Telescope (XRT)**
  - Arcsecond GRB positions
  - CCD spectroscopy
- **UV/Optical Telescope (UVOT)**
  - Sub-arcsec positions
  - Grism spectroscopy
  - 24<sup>th</sup> mag sensitivity (1000 sec)
  - Finding chart for other observers

## Spacecraft

- Autonomous re-pointing, 20 - 75 s
- Onboard and ground triggers

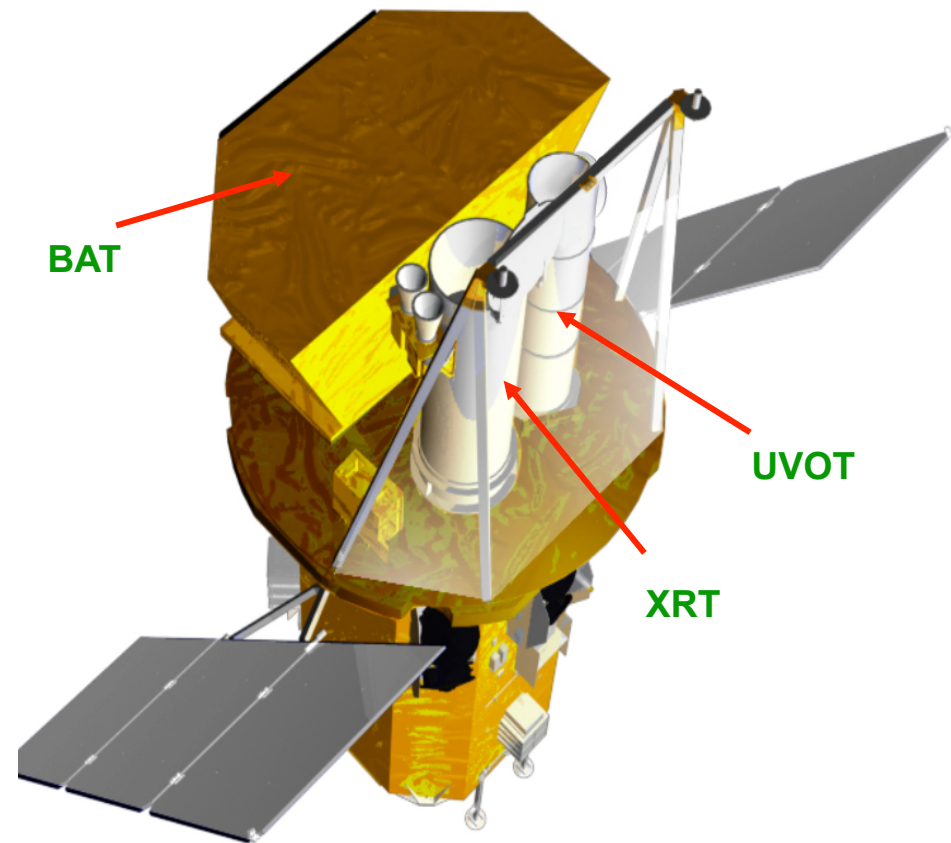

# Swift

## Details

- **BAT** (15-350 keV). Large (2 sr) field of view – detects bursts with arc min accuracy. And tells observers immediately.
- *Swift* automatically determines if it can view the GRB, and if so, slews to it.
- **XRT** (0.3-10 keV) and **UVOT** ( $\sim 1000\text{-}6000 \text{ \AA}$ ) begin observing typically within 100 s of the trigger.
- XRT can automatically detect afterglows, and downlinks limited data immediately.  $\sim 90\%$  of BAT GRBs have promptly detected XRT afterglows.

# SWIFT

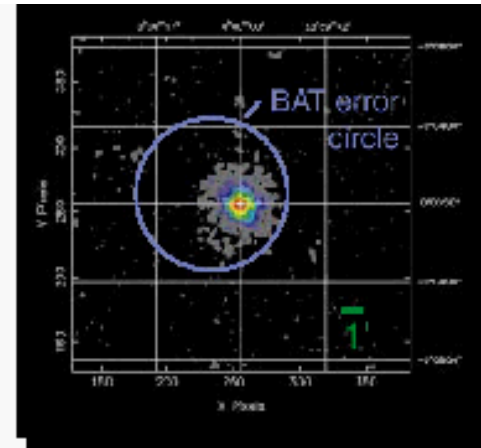
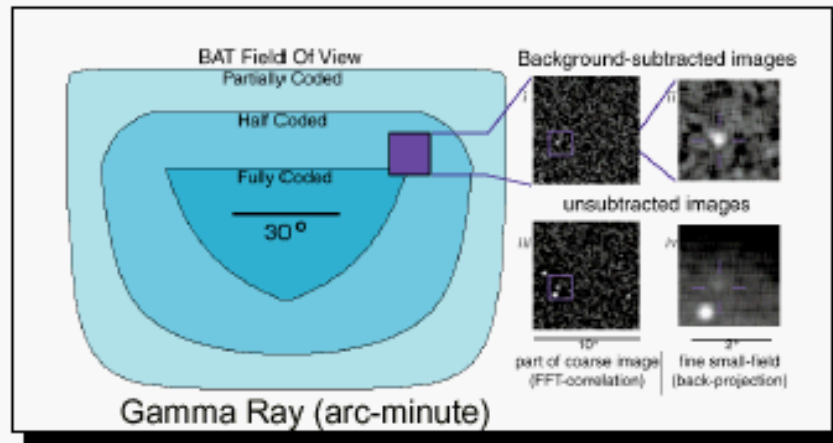

X-ray (2.5 arc-second)

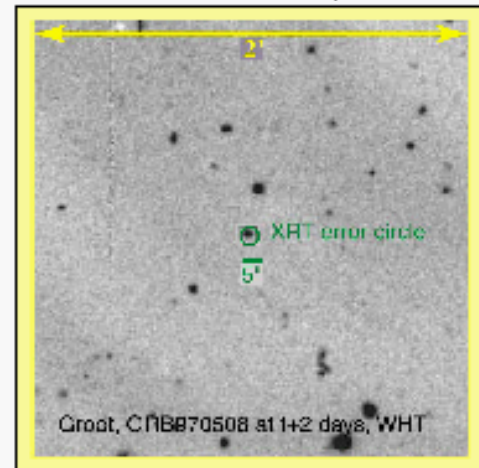

UVOT  
(0.3 arc-second)



HST, Keck,  
etc.

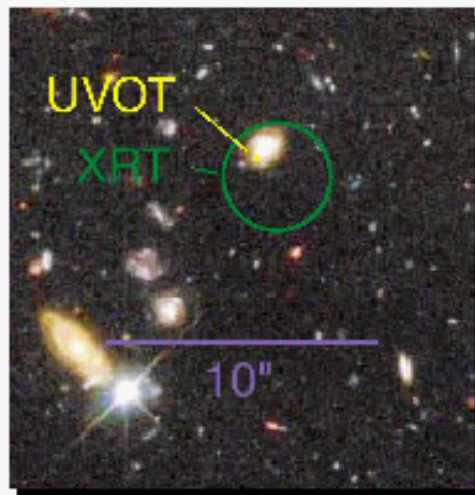

# Exercise #3

- Check and navigate into Swift web sites

# SWIFT

HEASARC   Swift Home   Archive   Data Analysis   Proposals & Tools   Education & Public Outreach

## Neil Gehrels Swift Observatory

About Swift   Quicklook Data   GCN   Results   Operations   Related Sites   Gallery

### The Neil Gehrels Swift Observatory

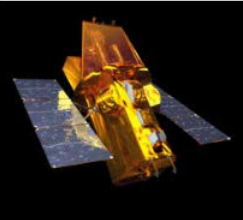

Gamma-ray bursts (GRBs) are the most powerful explosions the Universe has seen since the Big Bang. They occur approximately once per day and are brief, but intense, flashes of gamma radiation. They come from all different directions of the sky and last from a few milliseconds to a few hundred seconds. So far scientists do not know what causes them. Do they signal the birth of a black hole in a massive stellar explosion? Are they the product of the collision of two neutron stars? Or is it some other exotic phenomenon that causes these bursts?

With Swift, a NASA mission with international participation, scientists

**Swift Operations Status**  
All systems are operating normally.

#### Swift Resources

- » [GRB, BA, & TOO Contact Information](#)
- » [BAT Transient Lightcurves](#)
- » [Swift Supernovae](#)
- » [Observing Schedule](#)
- » [Journal Papers Related to Swift](#)
- » [Swift Press Release Image Archive](#)
- » [Swift User's Group \(SUG\)](#)
- » [Swift Mission Participants](#)

#### Latest Swift GRBs

- [GRB 220306B](#)



# SWIFT

<https://www.swift.ac.uk/index.php>



[Home](#) [About](#) [Support](#) [Data Access](#) [Data Analysis](#) [GRB Products](#) [Publications](#) [Links](#)

[site map](#) | Search:  ?

## The Neil Gehrels Swift Observatory

As of 3rd March, Swift has resumed normal science operations, with both ToO and GRB response re-enabled. High urgency ToOs can again be submitted. ([GCN 31668](#))

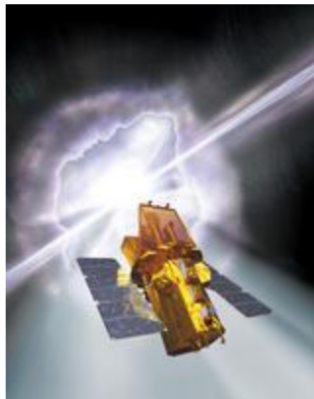

Picture courtesy of  
Spectrum Astro

Welcome to the UK Swift Science Data Centre.

The NASA-led Swift satellite discovers Gamma-Ray Bursts (GRBs) and measures their X-ray and optical afterglows to arc-second accuracy within a minute or two, continuing to make spectral observations until they fade from view days, weeks or even months later. Swift has been finding around 90 new bursts a year since launch in November 2004. It has provided the most complete study of GRBs so far, finding the most distant objects in the Universe and rapidly advancing science in this area. Swift is a rapid-response multi-wavelength facility which is ideal for observations of transient and variable sources; it has a Guest Investigator programme and a flexible Target of Opportunity programme which is well used.

On this site you can find out more about the mission and GRBs, as well as obtaining data from the on-board instruments and building X-ray products.

### Latest Swift Detected GRBs

[GRB 220310C](#)  
[GRB 220310A](#)  
[GRB 220306B](#)  
[GRB 220305A](#)  
[GRB 220302A](#)

### Quick Links

[Swift in the news](#)  
[Training Opportunities](#)  
[GRB and Swift Conferences](#)  
[Targets of Opportunity](#)  
[Guest Investigator Program](#)  
[Build XRT products](#)

### Helpdesk

Questions about Swift? Try our [guide to Swift](#) or the [guide to data processing and analysis](#). If these don't solve your problem, please feel free to [e-mail us](#) at [swifthelp@le.ac.uk](mailto:swifthelp@le.ac.uk).

[List of acronyms and abbreviations](#)

We are located in the [Department of Physics & Astronomy](#), at the [University of Leicester](#) ([directions](#)).

One of our team is tweeting about life as a Swift scientist - [follow him on Twitter!](#)



# SWIFT

<https://swift.asdc.asi.it/>



The screenshot shows the top section of the Space Science Data Center website. It features the SSDC logo on the left, the title "Space Science Data Center" in large orange letters in the center, and the ASI logo on the right. Below the title is a navigation menu with links for Home, About SSDC, News and Communication, Quick Look, Missions, Multimission Archive, Catalogs, Tools, Links, and Bibliographic services. There are also links for Helpdesk and Privacy, and social media icons for Facebook and Twitter. A banner below the menu shows a satellite and a bright light with the text "Swift: Catching Gamma-Ray Bursts on the Fly". To the right of the banner are flags and links for the U.S., Italian, and U.K. sites. Below the banner is another navigation menu with links for Swift Home, About Swift, ASI HQ Swift Home, Swift Data Archive, Swift pointings, Swift Catalogs, Swift Quicklook Data, Swift Data Analysis, Swift Helpdesk, GCN, ToO Request Form, Malindi ground station, and Gallery.

## The Swift Gamma-Ray Burst Mission

[ASI Swift Scientific Page \(Italian\)](#)

Swift is a MIDEX Gamma Ray Burst mission led by NASA with participation of Italy and the UK. The Swift data are available to the scientific community through data centers in the USA, Italy and the UK.

**Italy contributes to the mission providing:**

- The XRT X-ray mirror
- The Malindi ground station
- XRT data reduction and analysis software

**The ASI Science Data Center (ASDC) contributes to the mission providing:**

- [Swift Data Archive Mirror](#)
- [On-line XRT & UVOT data analysis](#)
- [Swift Quick Look Data \(XRT & UVOT Interactive Quick Look\)](#)
- XRT Burst Support (XBS) and Burst Advocate (BA) activity

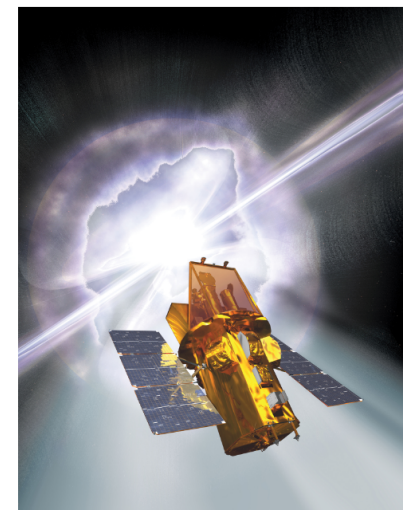

**An artist rendering of the Swift satellite catching a Gamma-ray Burst**

# Discoveries in the *Swift* era

- ① X-ray afterglow of short GRBs
- ② Prompt optical-IR emission and very early optical afterglows
- ③ X-ray flares from GRB
- ④ Early steep decay of X-ray afterglows

# Swift data

## *Swift* GRB Data

GRB 071020

### BAT lightcurve

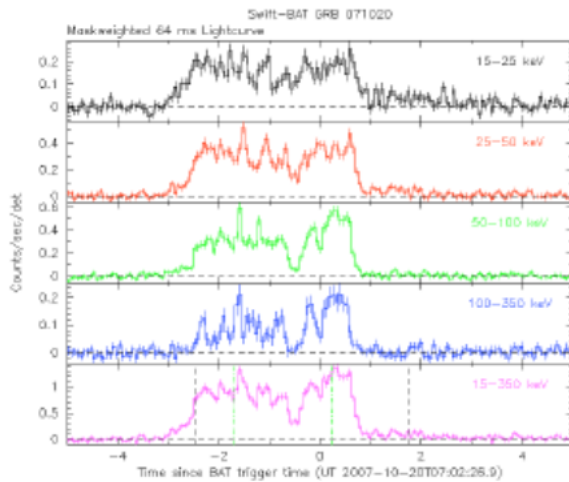

### XRT lightcurve

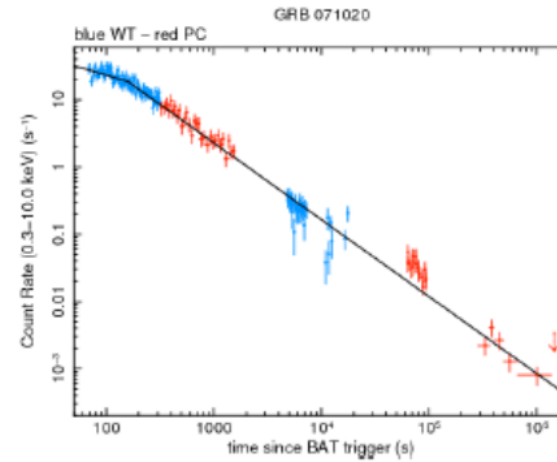

### UVOT image

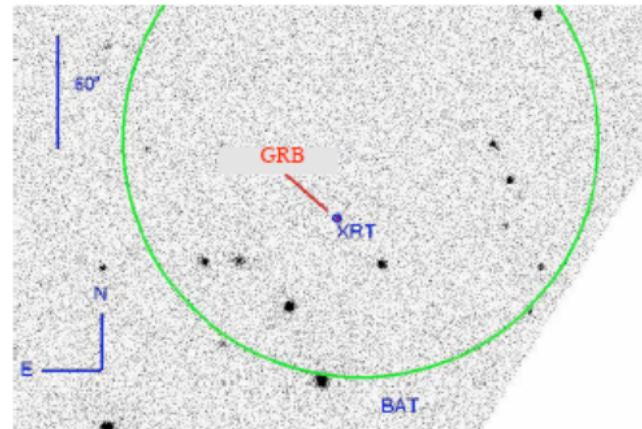

# Swift data

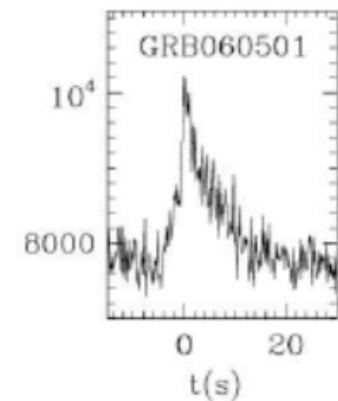
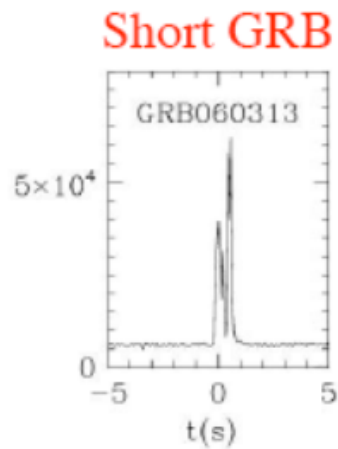
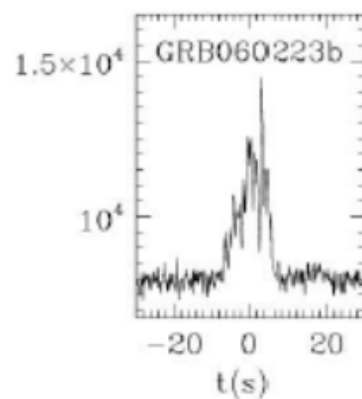
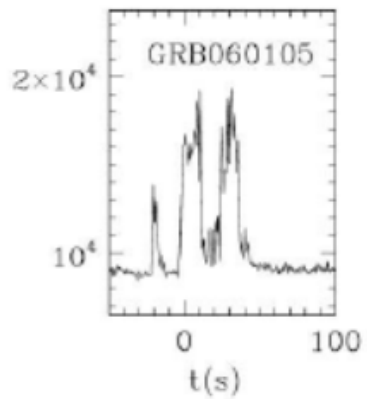
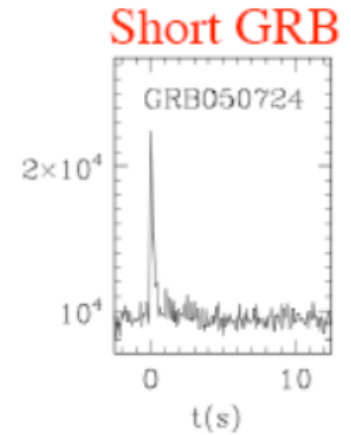
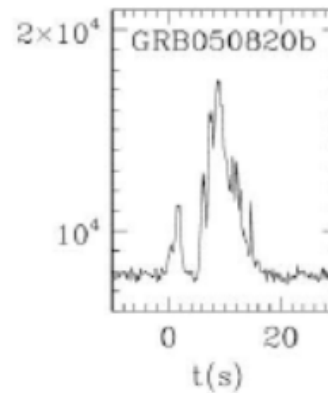
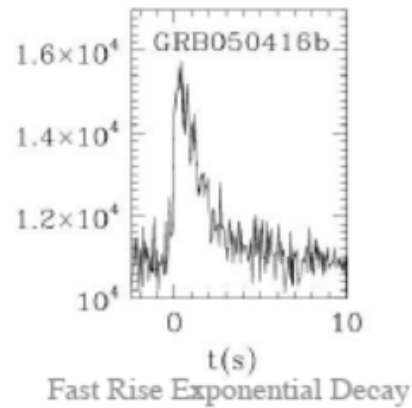
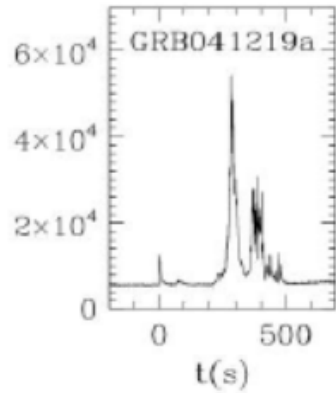

# Swift discoveries

## Summary

- GRBs with arc second positions from *Swift*
- >70% of *Swift* GRBs have redshifts
- Includes brightest GRB ever seen, and most distant one.

## Questions for *Swift*

- Do short GRBs have afterglows, and hence can we locate them more precisely?
- Can we pin down the progenitors?
- Are there new subclasses of GRBs?
- Can we find high-redshift bursts and study the early universe?

## Questions for *Swift*

- Do short GRBs have afterglows, and hence can we locate them more precisely?
- Are there new subclasses of GRBs?
- Can we pin down the progenitors?
- Can we find high-redshift bursts and study the early universe?

# Swift discoveries

## Short GRBs.

- GRB 050509B was a short GRB discovered by *Swift*, with an X-ray afterglow reported 2:29 after the trigger.
- Outskirts of an elliptical galaxy.
- Later sGRBs had optical afterglows too.
- Subsequently found in all galaxy types.

VLT image  
Hjorth et al.

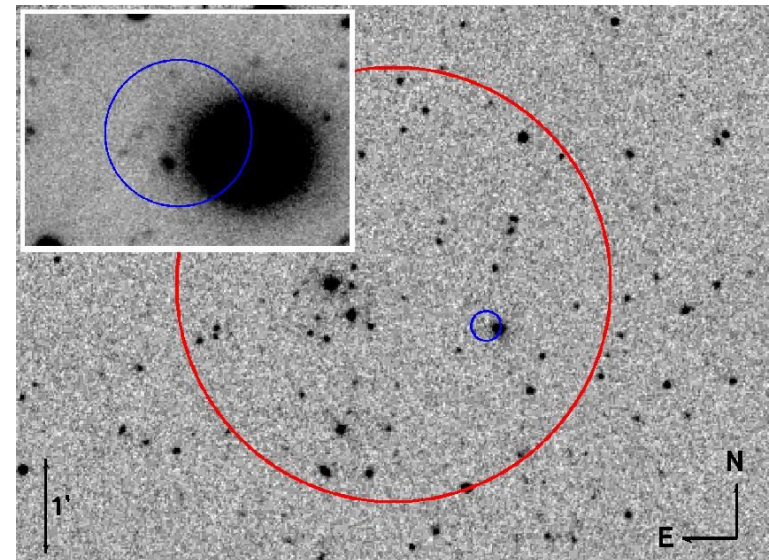



## Questions for *Swift*

- Do short GRBs have afterglows, and hence can we locate them more precisely?
- Can we pin down the progenitors?
- Are there new subclasses of GRBs?
- Can we find high-redshift bursts and study the early universe?

# Swift discoveries

## Progenitors

- Short GRBs found in all types of galaxy – old population (compact merger/magnetar)
- Long GRBs always found in star forming galaxies and regions – deaths of massive stars.

# Questions for *Swift*

- Do short GRBs have afterglows, and hence can we locate them more precisely?
- Can we pin down the progenitors?
- **Are there new subclasses of GRBs?**
- Can we find high-redshift bursts and study the early universe?

# Swift discoveries

## Short GRB with extended emission

- Blurred the distinction between “short” and “long” bursts, and made it more detector-dependent.

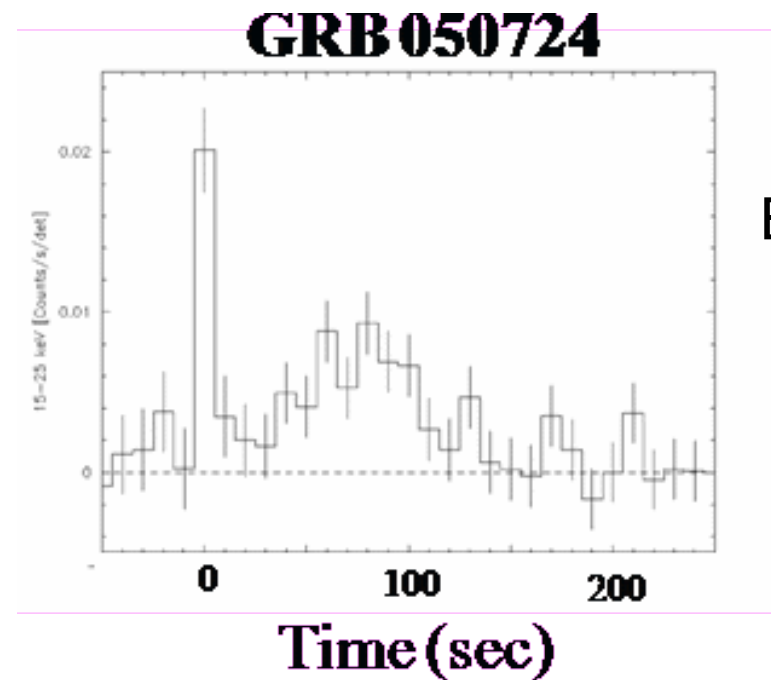

Barthelmy et al.  
2005

# Swift discoveries

## Long GRBs with no SNe

- GRB 060614 and GRB 060505 were nearby, apparently long GRBs, with no related supernova, down to deep limits.
- The GRB taxonomy is clearly more complex than previously thought.
- Maybe a new, progenitor-based classification is needed?

# Ultra Long GRBs

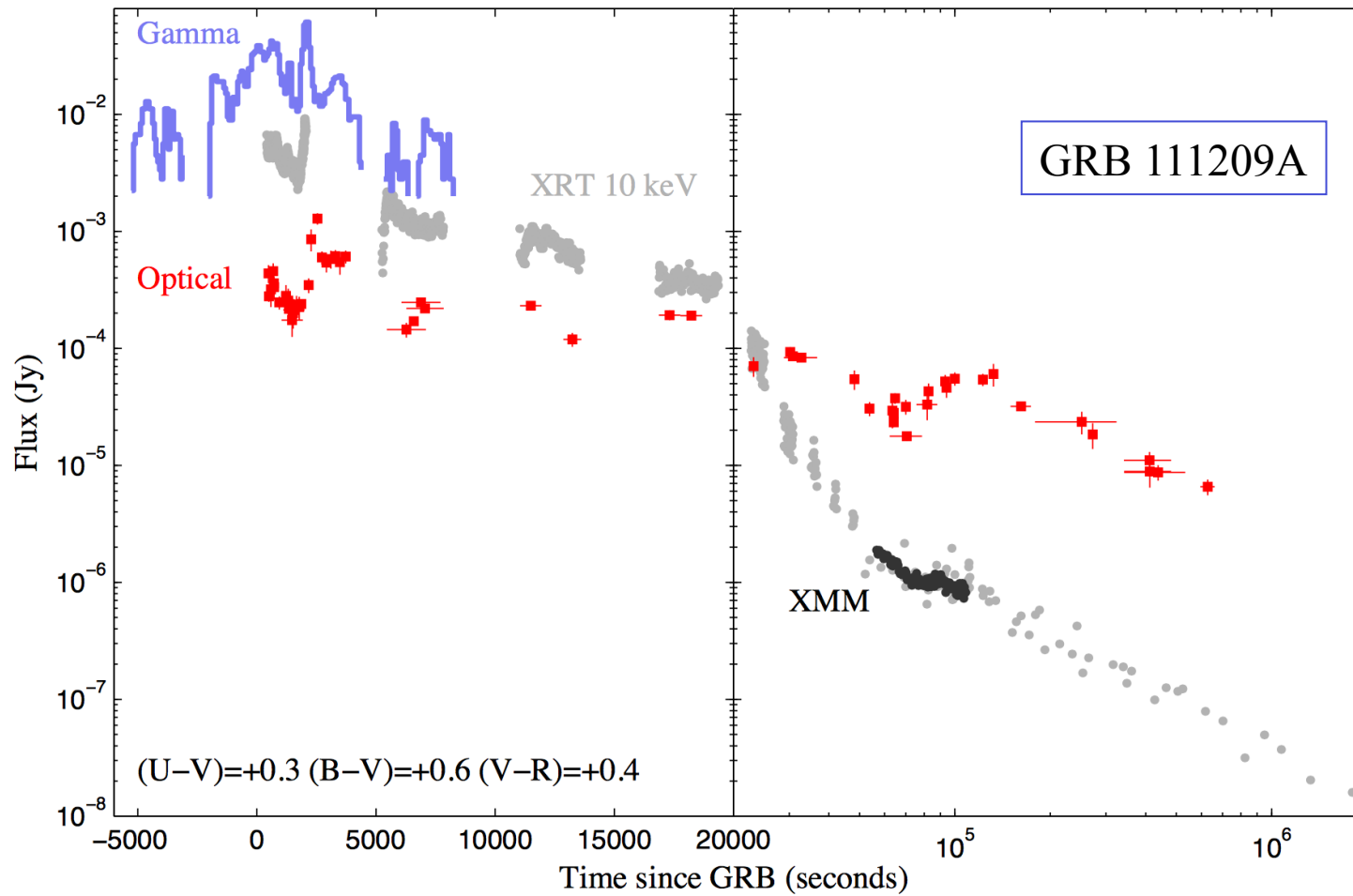

## Questions for *Swift*

- Do short GRBs have afterglows, and hence can we locate them more precisely?
- Can we pin down the progenitors?
- Are there new subclasses of GRBs?
- Can we find high-redshift bursts and study the early universe?

# Swift discoveries

## High redshift bursts

- 17 GRBs observed by *Swift* have  $z > 3.5$
- 10 have  $z > 4$ , and 5 have  $z > 5$  – a large, rapidly growing population of distant objects.
- GRB 050904 was at  $z=6.29$  (Cusumano et al. 2007)
- GRB 080913 was at  $z=6.7$ , and was a fainter-than-normal burst! (Greiner et al. 2009)
- GRB 090423 was at  $z=8.26$  !!!!
- GRB 090429B was at  $z=9.2$  !!!!!



# High redshift GRB

## High-Redshift GRBs

z	GRB	Optical Brightness
9.4	090429B	K = 19 @ 3 hrs
8.2	090423	K = 20 @ 20 min
6.7	080813	K = 19 @ 10 min
6.29	050904	J = 18 @ 3 hrs
5.6	060927	I = 16 @ 2 min
5.3	050814	K = 18 @ 23 hrs
5.11	060522	R = 21 @ 1.5 hrs

## Star Formation Rate

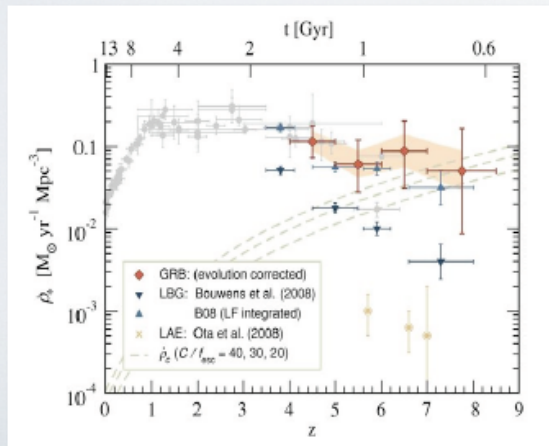

## Metallicity

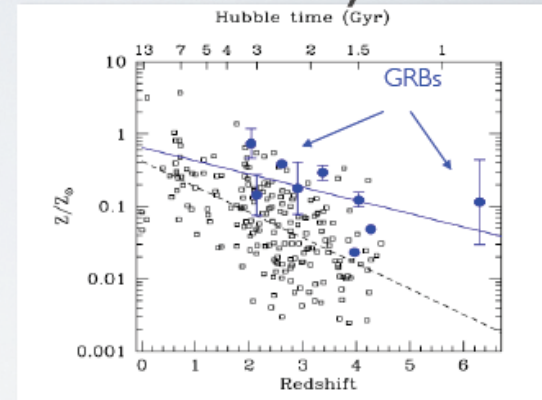

Savaglio 2006

Kistler et al. 2009;  
Robertson & Ellis 2011

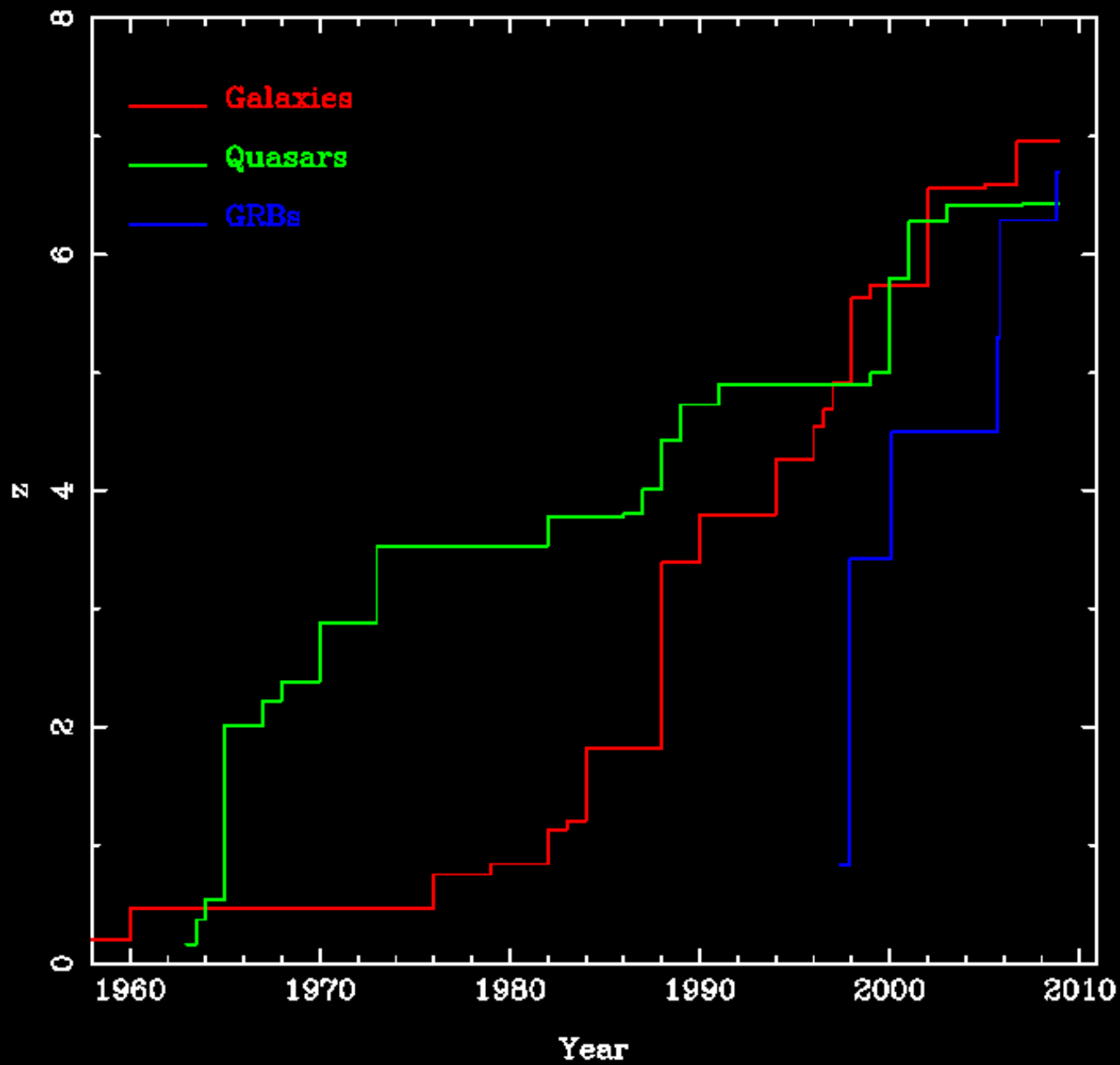

# GRB & Cosmology

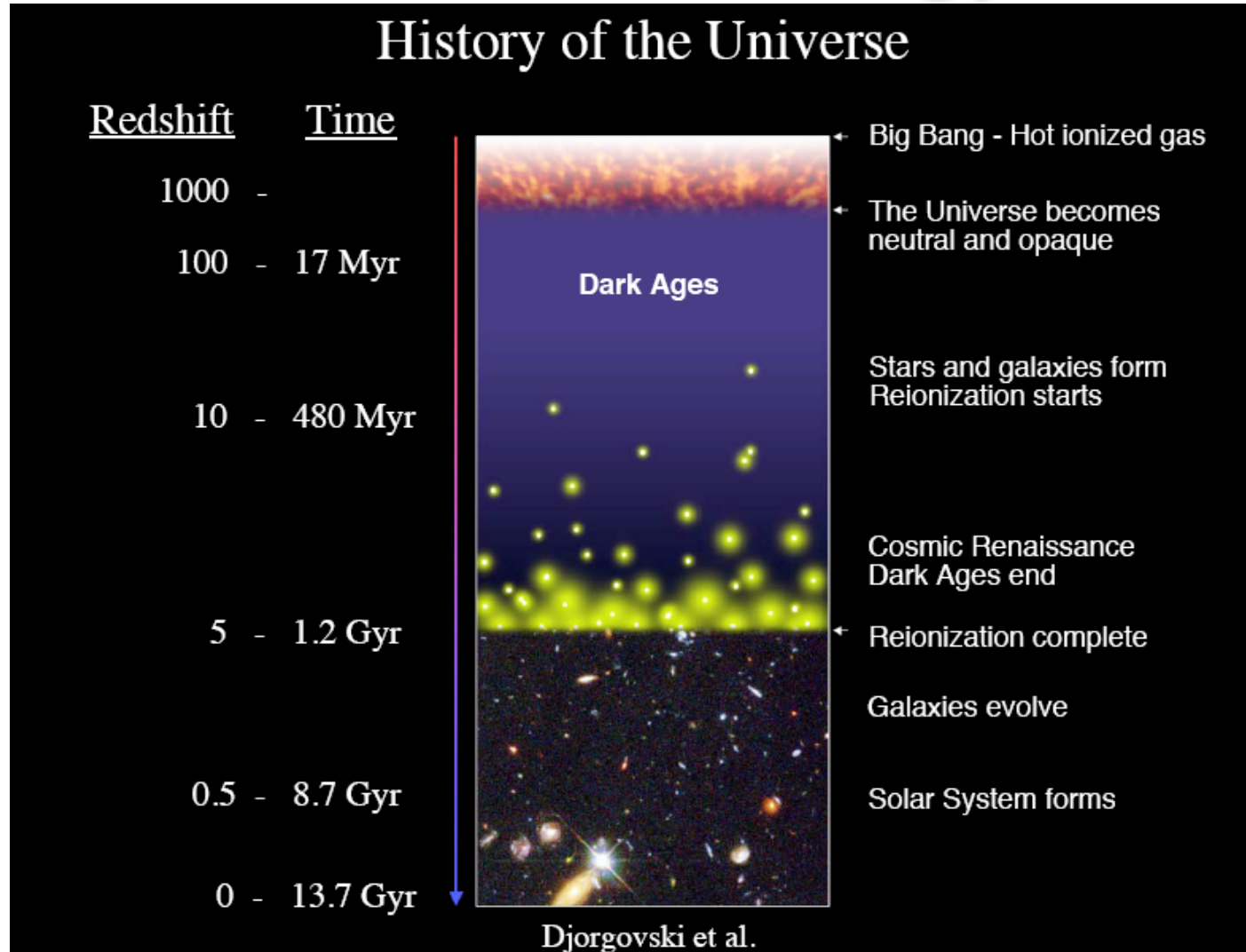

# Swift discoveries

## High redshift bursts

- 2-m class telescopes should give reliable photo-z for many  $z > 6$  bursts.
- With GROND online, X-shooter, and increasing numbers of small (ish) telescopes observing every GRB, the next high-z burst could be just round the corner....

# High z - searches

## High-z Universe: searching for the best probe

### Galaxies

#### Pros

- ★ Multiband data are available (some)
- ★ Refurbished HST
- ★ Different technique (LBG/Ly $\alpha$  emission)
- ★ Do not “disappear”

#### Cons

- ★ Small region of the sky (11 arcmin<sup>2</sup>)
- ★ Required several hours of observations
- ★ Very faint objects
- ★ Galaxy templates are complex
- ★ Difficult determination of  
Age/dust/SFR

### Gamma-ray Bursts

#### Pros

- ★ Very bright
- ★ Happens everywhere
- ★ Can be followed quickly from space and ground (now at least)
- ★ **Have a very simple spectrum**  
(synchrotron, simple power-law)
- ★ Allow better investigation of  $\tau_{HI}$

#### Cons

- ★ Rare (few “good ones”)
- ★ Fade fast,  $\sim$ minute position  
identification (space mission)
- ★ Require multiband observations

# Questions from *Swift*

## **New mysteries**

- Complex X-ray afterglows.
- X-ray flares
- Jet breaks?
- Why do the different types of GRB have such similar afterglows?
- Why is the ambient medium (apparently) constant-density, not WR-wind type environment?
- What are the microphysics parameters?

# Swift discoveries

## Complex X-ray afterglows

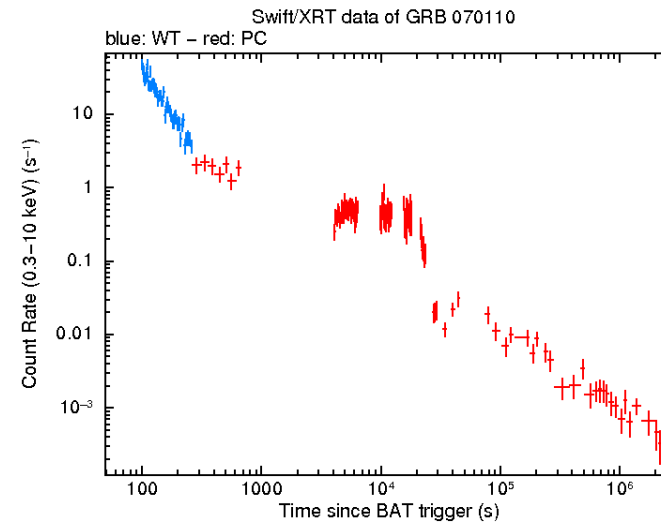
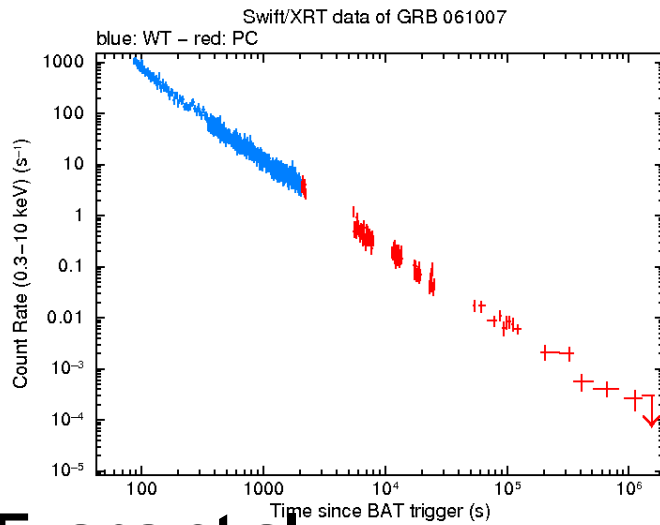
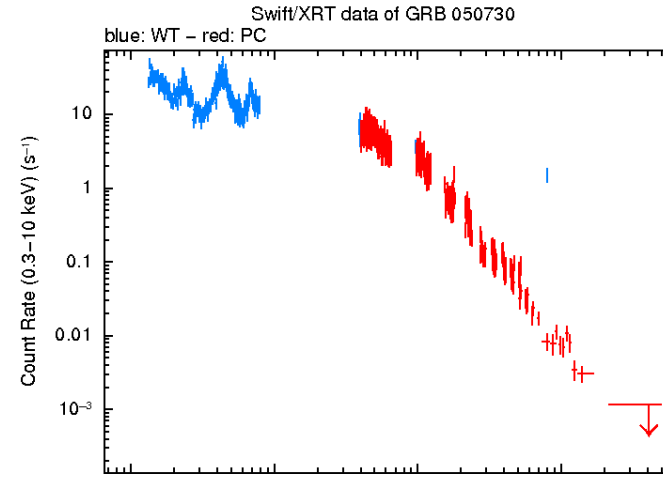
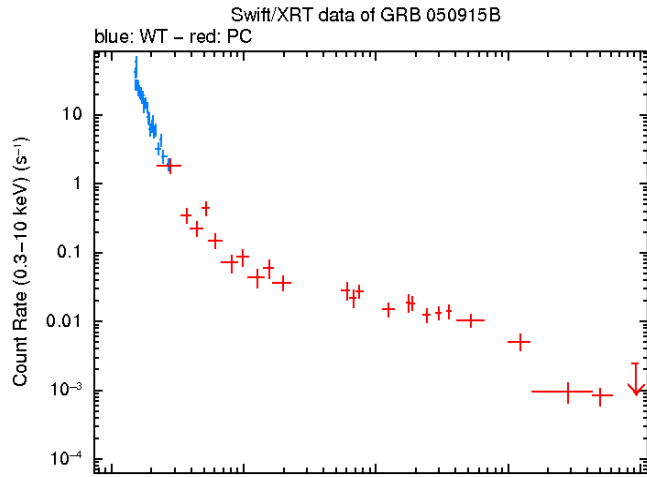

Evans et al.  
2009

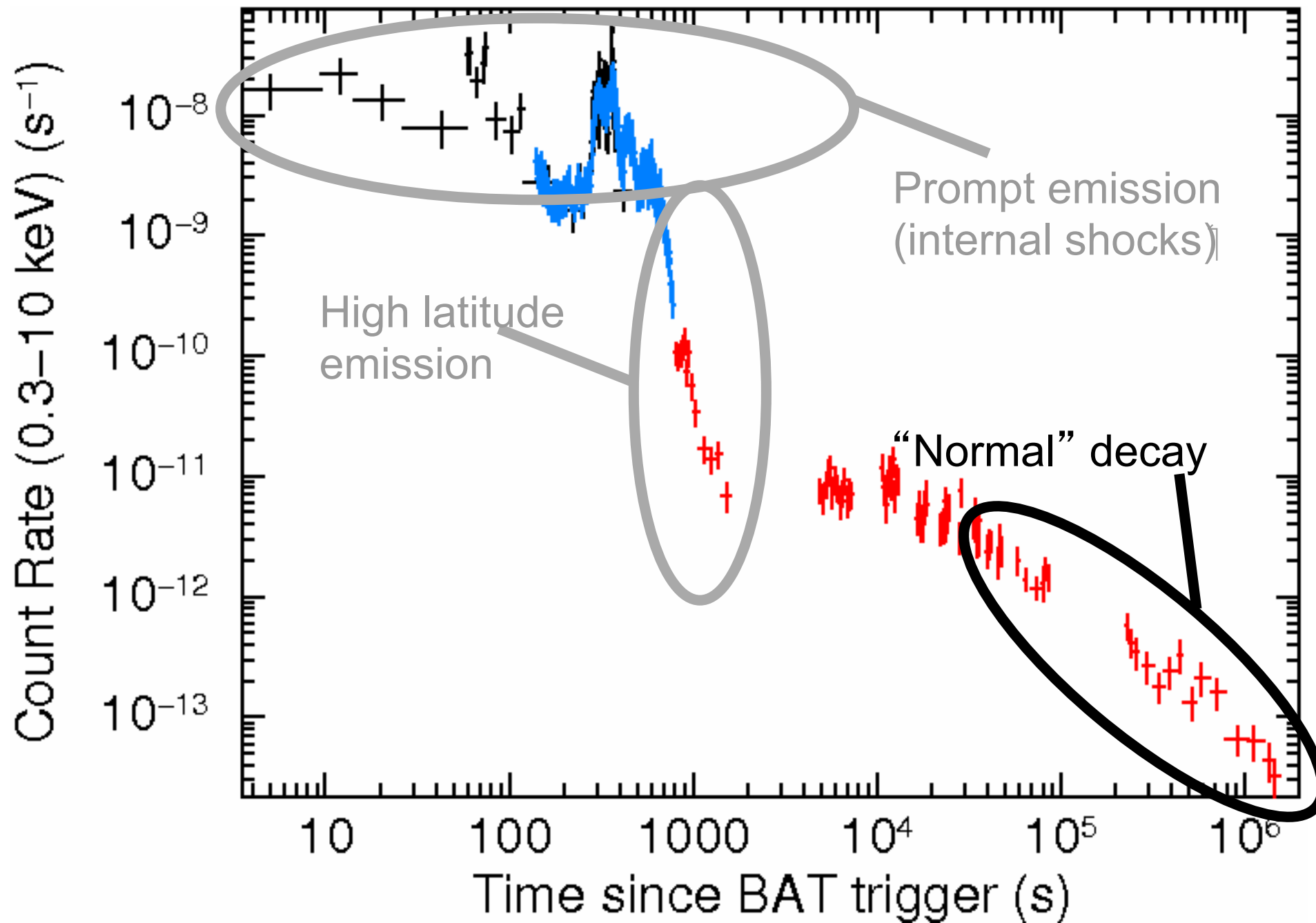



# Swift discoveries

## Shallow decay phase

- Energy injection? (Zhang et al 2006). *But it has to go on for ~1 day.*
- Dust? [models light curves really well – Shao & Dai (2007). *But not the spectra (Shen et al. 2009).*
- Upscattered forward shock emission?
- Long-lived central engine (i.e. internal shock emission).
- And more....

# Questions from *Swift*

## **New mysteries**

- Complex X-ray afterglows.
- X-ray flares
- Jet breaks?
- Why do the different GRBs have such similar afterglows?
- Why is the ambient medium (apparently) constant-density?
- What are the microphysics parameters?

# Swift discoveries

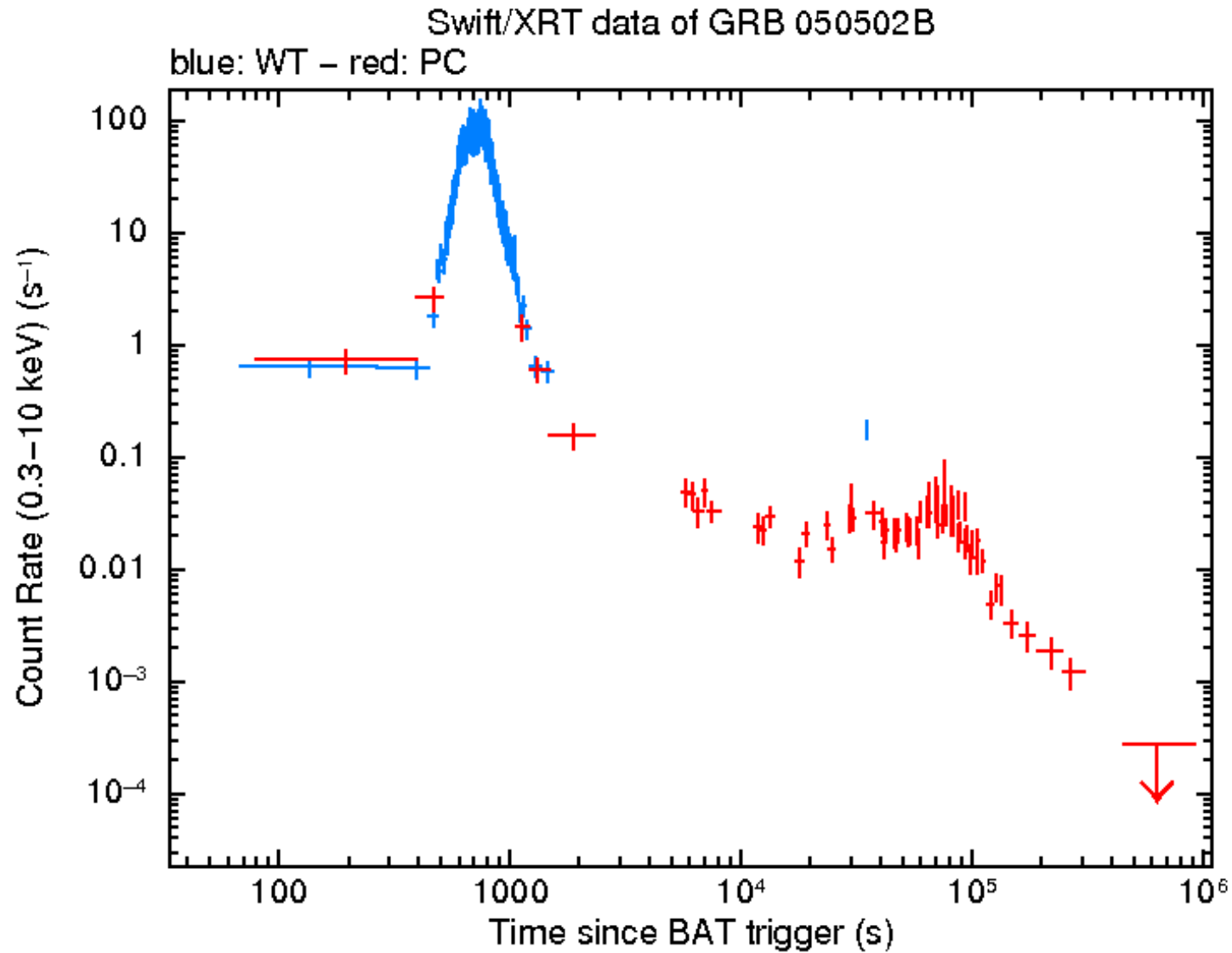

# Questions from *Swift*

## **New mysteries**

- Complex X-ray afterglows.
- X-ray flares
- **Jet breaks?**
- Why do the different GRBs have such similar afterglows?
- Why is the ambient medium (apparently) constant-density?
- What are the microphysics parameters?

# Swift discoveries

## Where are the jet breaks?

- Strong, achromatic light curve steepening was expected in most/all GRBs – it's now exciting if we think we've got one!
- They could be hidden (Curran et al. 2008), or we're not considering enough possibilities (Racusin et al. 2009)
- Perhaps the jets are structured/complex, so breaks are not achromatic? (e.g. Oates et al. 2007, de Pasquale et al. 2008).

# Afterglows in the Swift era ...

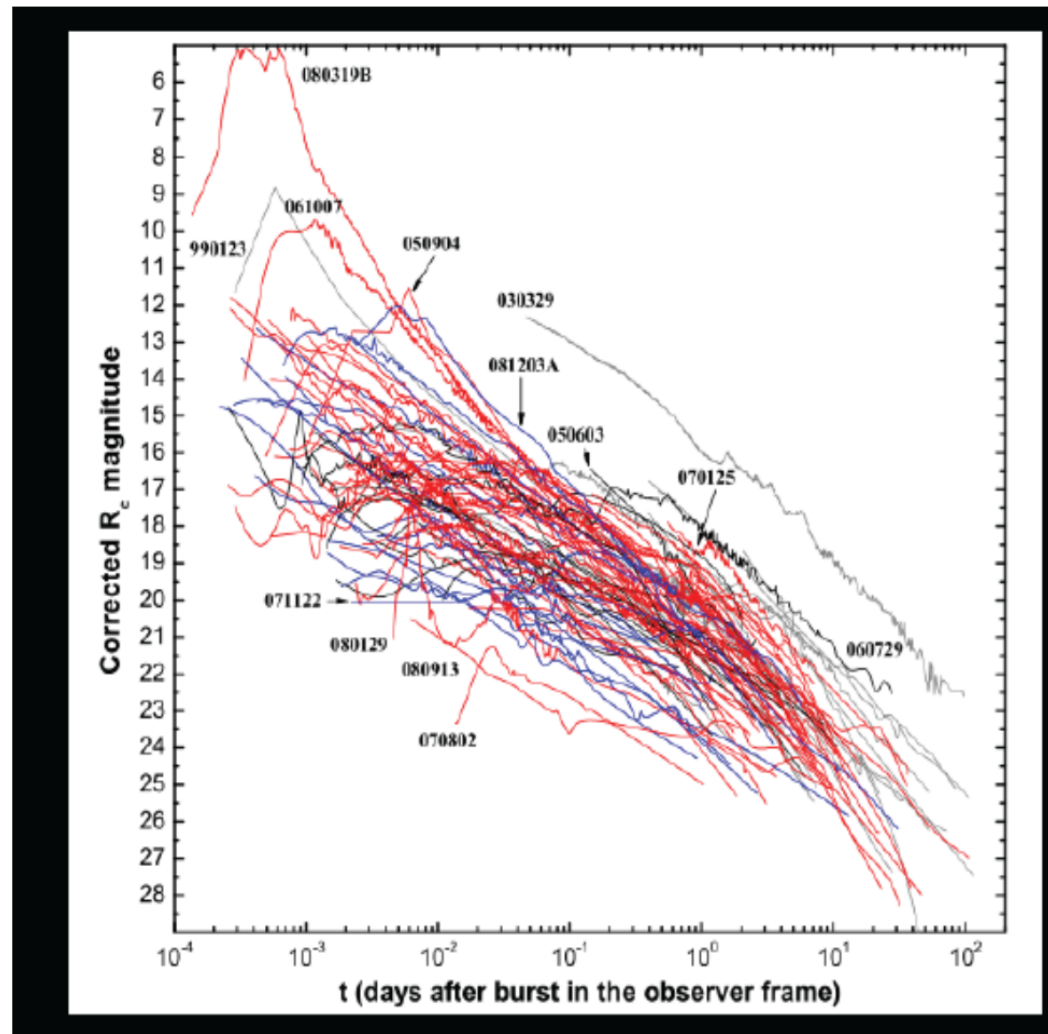

# Afterglows in the Swift era

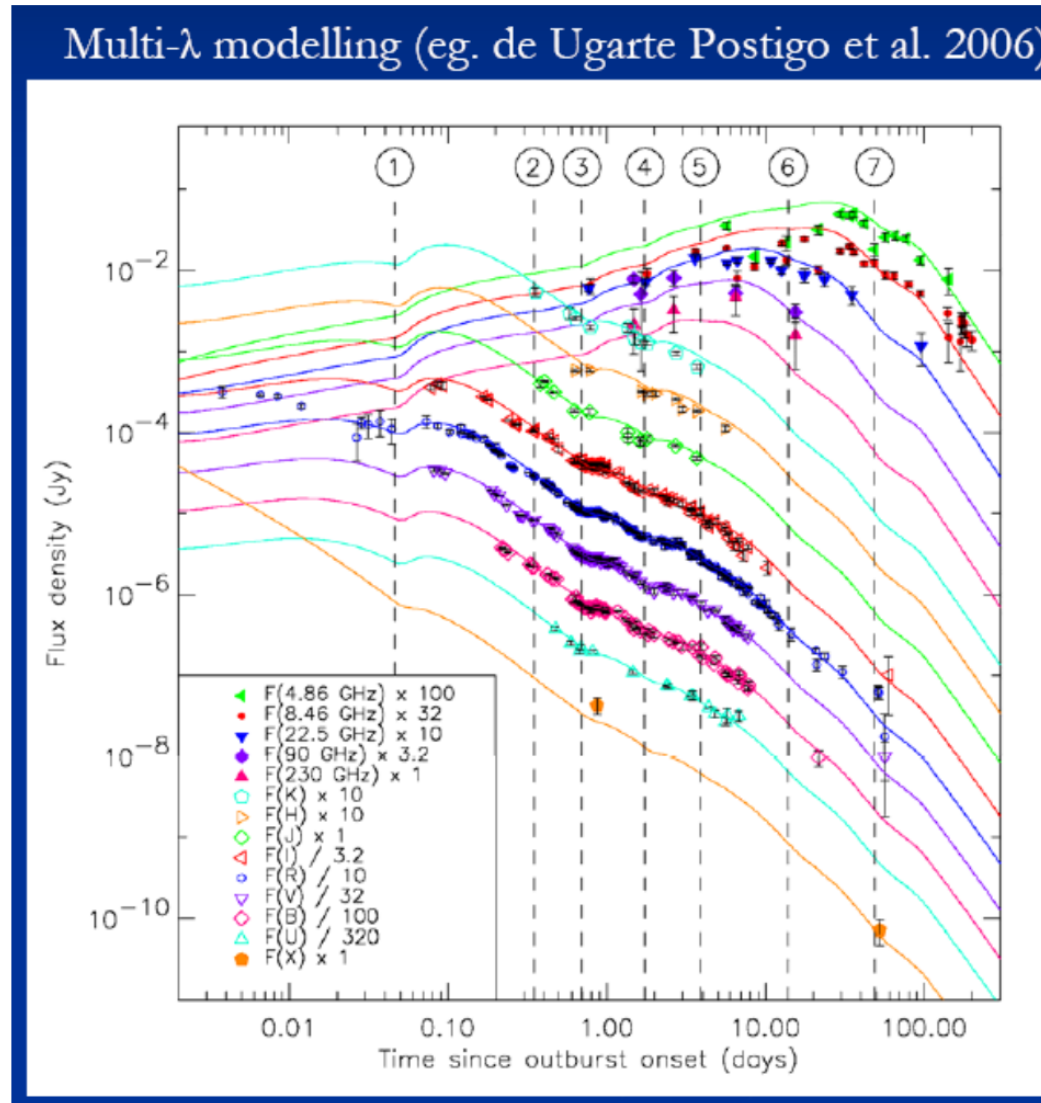

# Swift discoveries

## **GRB 080319B**

- Very bright – reached  $m_v=5.3$ .



# Swift discoveries

## GRB 080319B

- Very bright – reached  $m_v=5.3$

Movie from  
Pi of the sky.

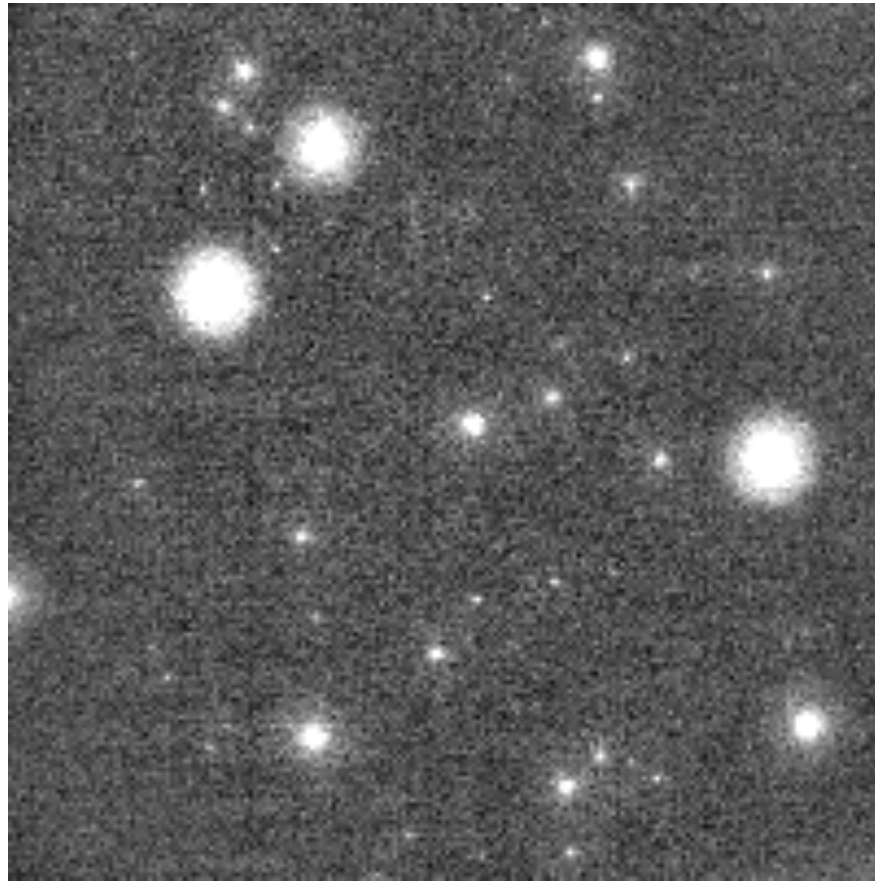

# Swift discoveries

## GRB 080319B

- Very bright – reached  $m_v=5.3$
- $z=0.9$
- If it were at the Galactic centre, it would appear as bright as the Sun!
- Bright in X-rays and Gamma-rays, but nothing like as extraordinary as in the optical.
- Implies a complex jet structure (Racusin et al. 2008, Nature).

# 080319B

## First "naked-eye" Burst GRB 080319B

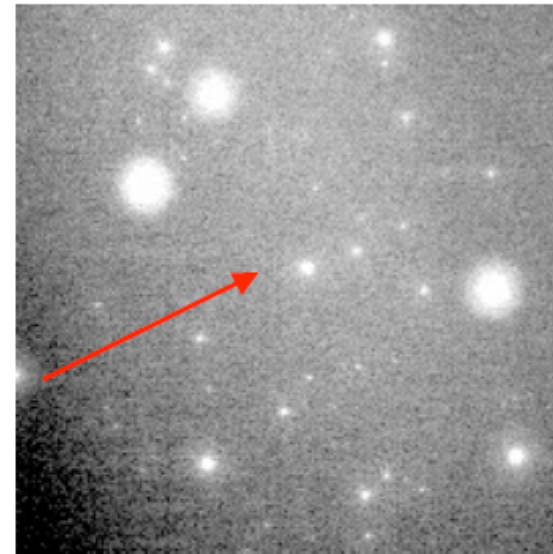
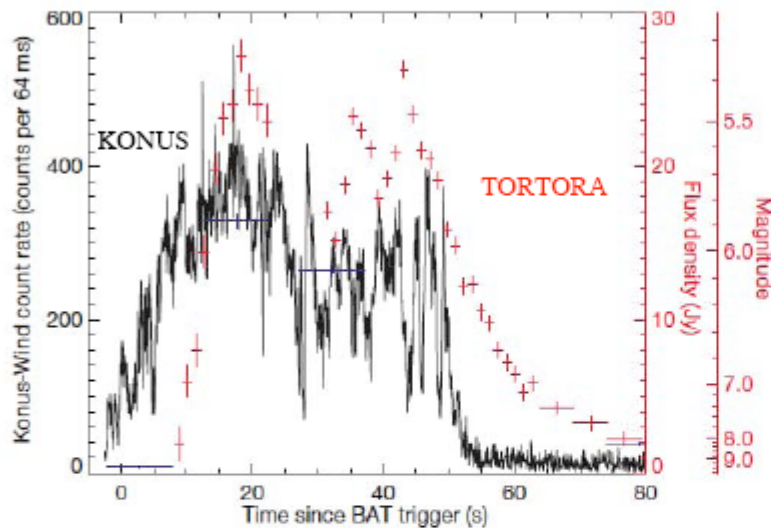

Racusin et al.  
2008

$T_{90} = 50\text{s}$     $z = 0.94$

Prompt optical observations:  
Pi-of-the-Sky (Chile) pre-burst  
RAPTOR (New Mexico)  
REM/TORTORA (Chile)

**Peak brightness of 5.6 magnitudes!!**

Pi-of-the-Sky

# 080319B

Even corrected for distance,  
brightest optical burst

In our Galaxy, such a burst  
would be brighter than the sun!

GRBs much more luminous than  
most energetic quasars & SNe

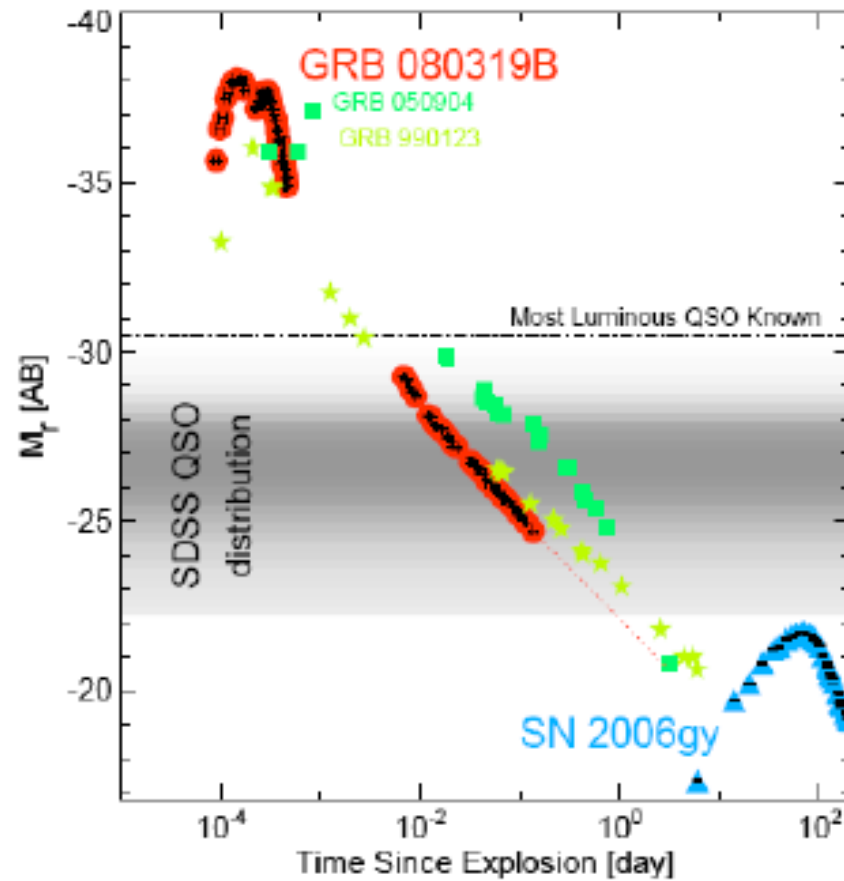

Bloom et al. 2008

# Swift discoveries

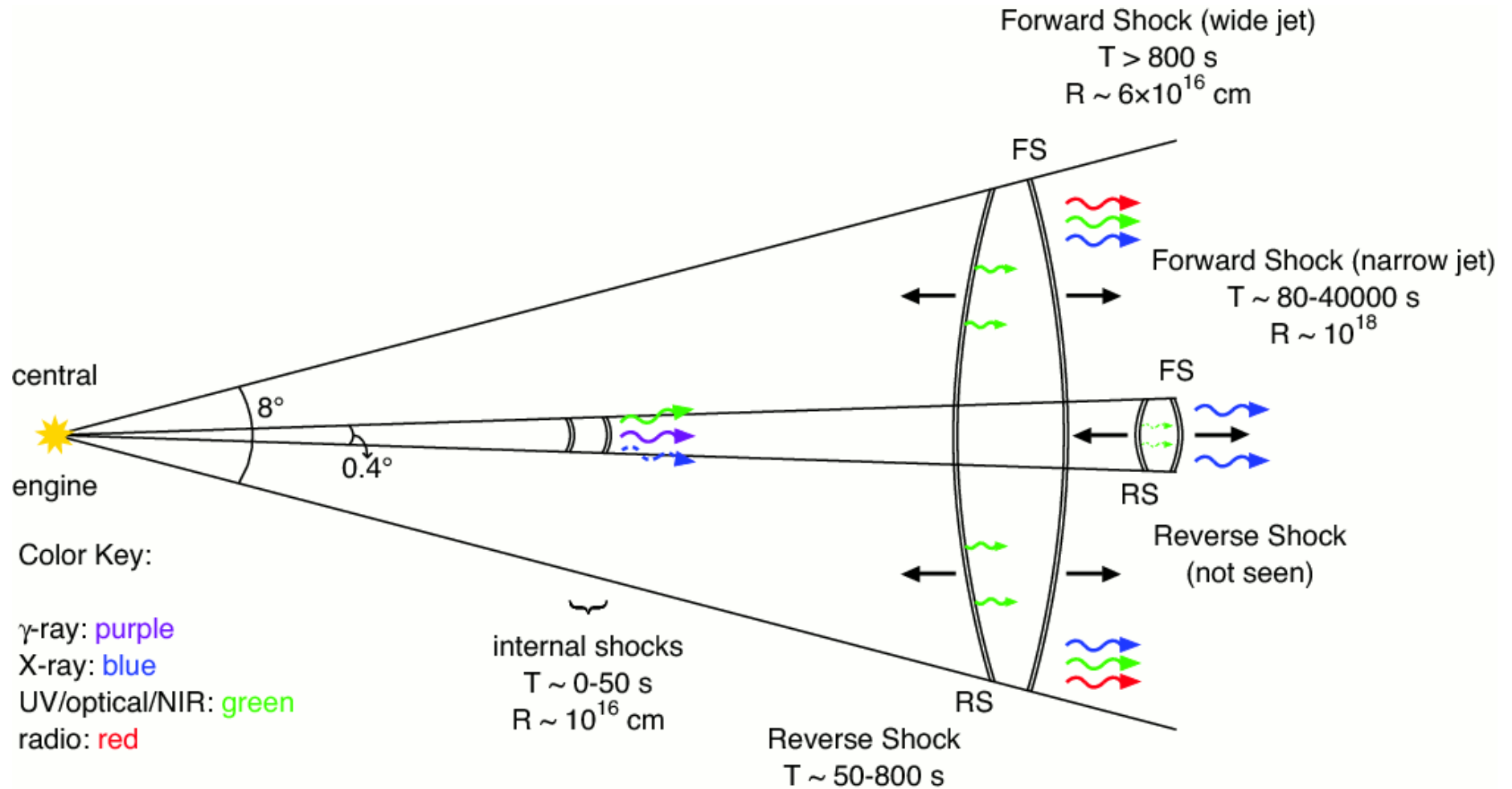

# 080319B

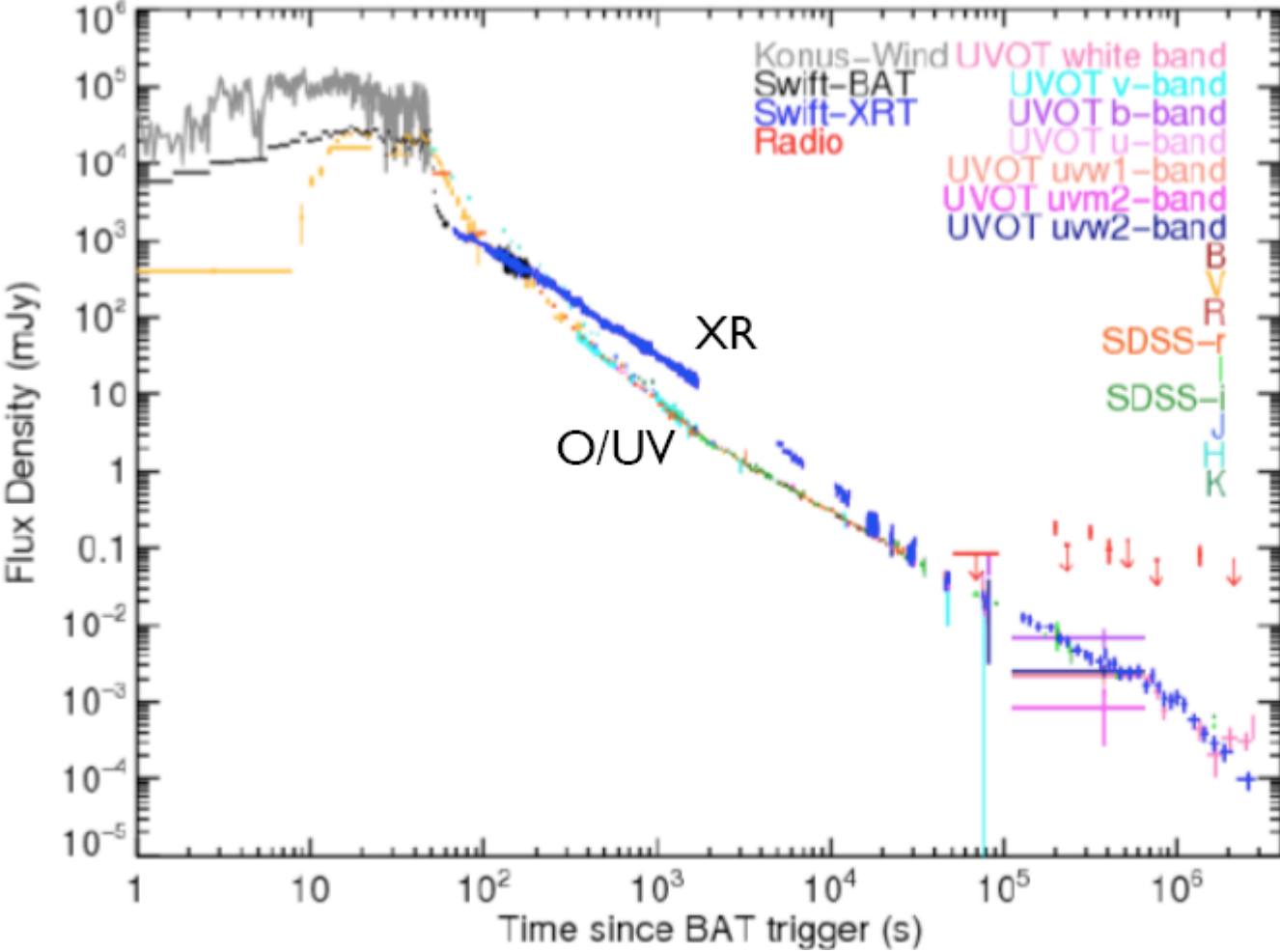

# Summary

- *Swift* has helped to answer some questions:
  - Localised short GRBs
  - Supported collapsar and compact merger progenitor models.
- Asked a load of new questions!
  - What are the subtypes?
  - How do we get X-ray afterglows? And flares?
  - What is the jet structure?

# A peculiar GRB?

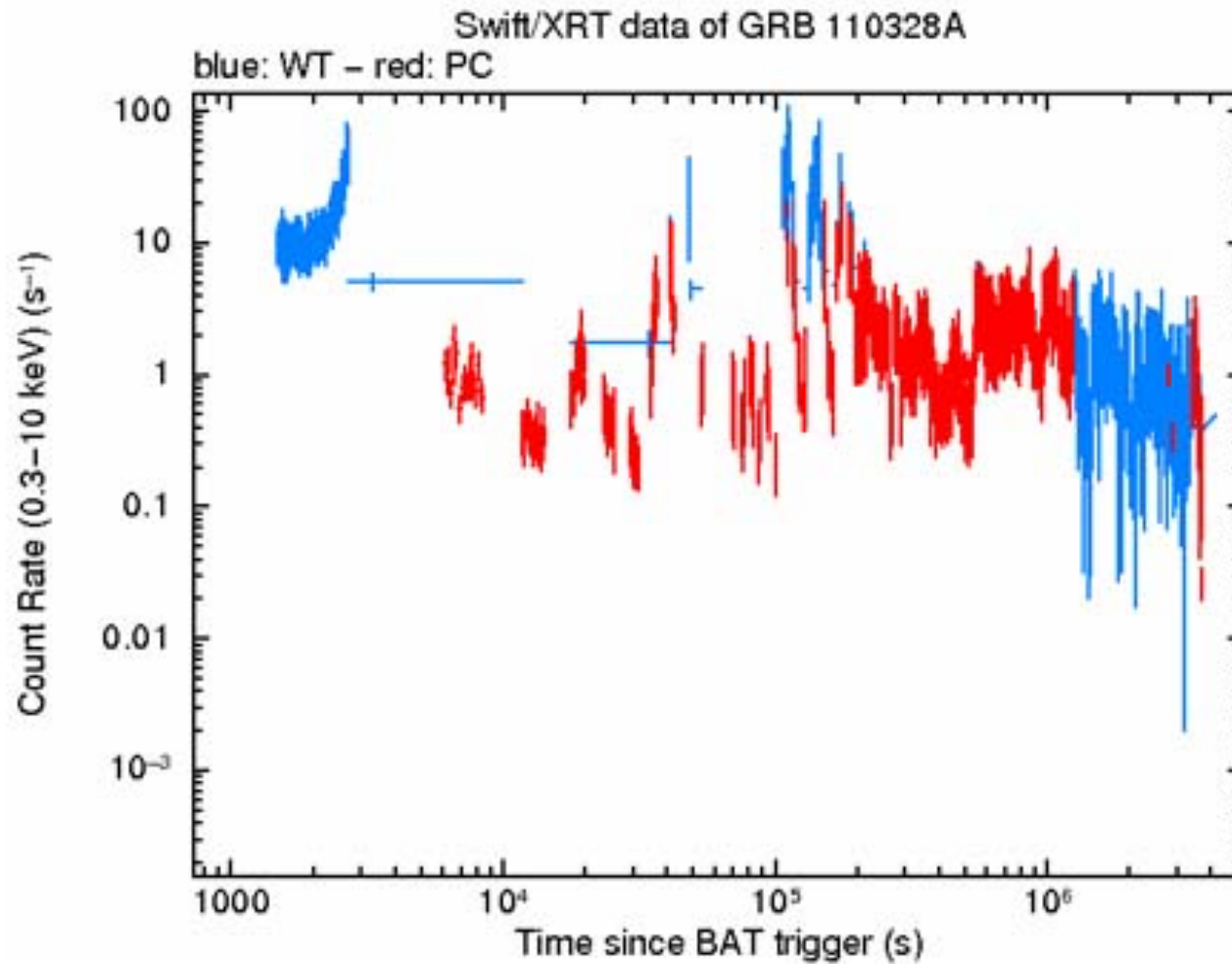



# A peculiar GRB?

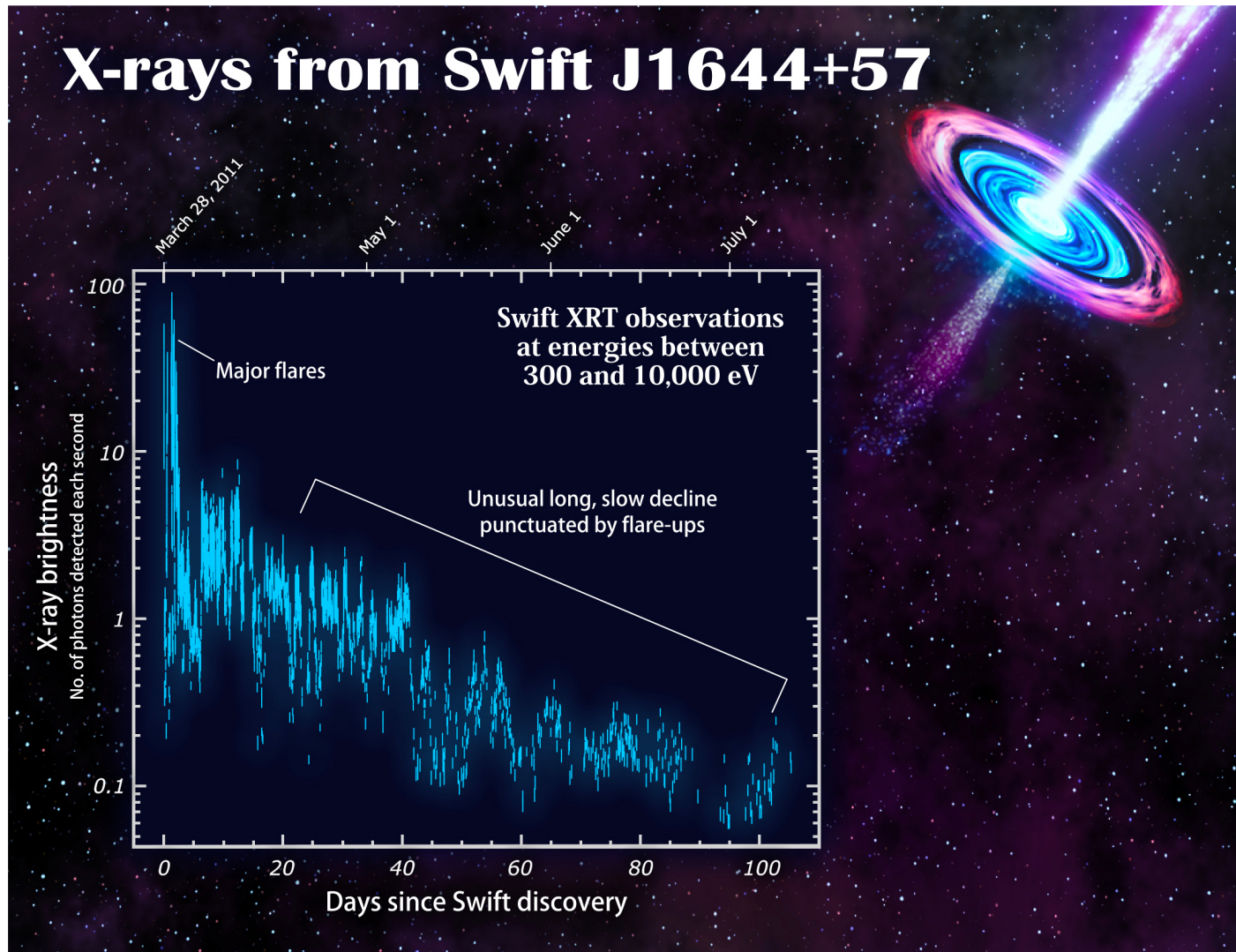

# A peculiar GRB?

## Swift J1644+57: Onset of a relativistic jet

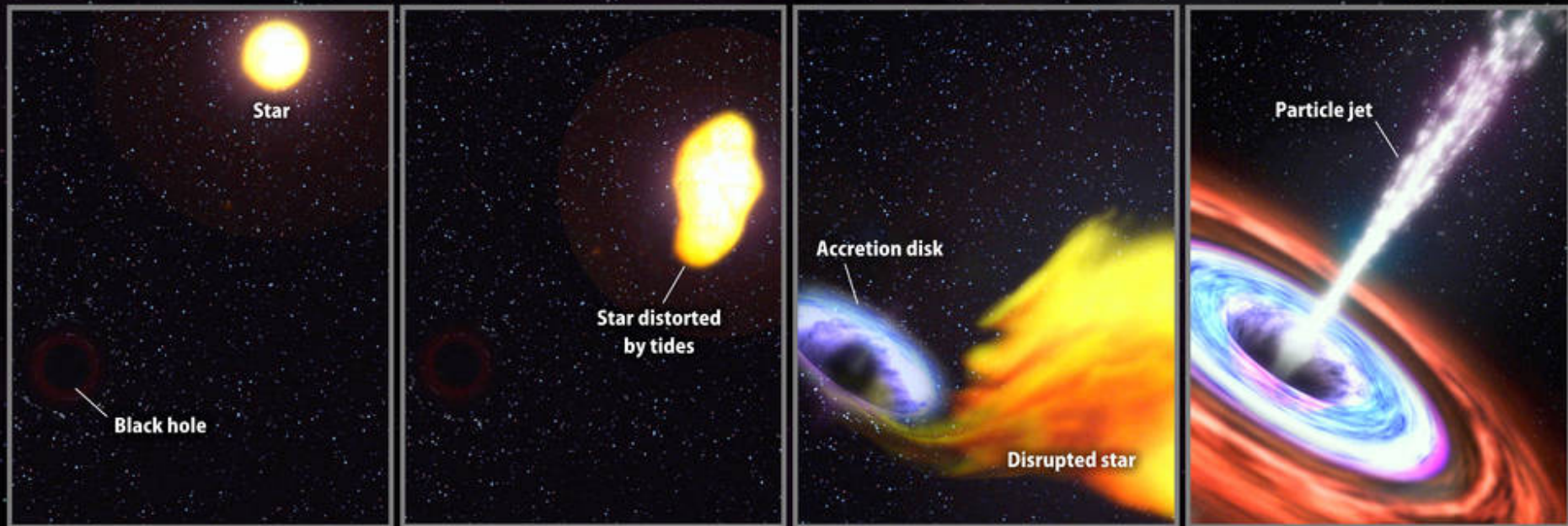

**1.** A sun-like star on an eccentric orbit plunges toward the supermassive black hole in the heart of a distant galaxy.

**2.** Strong tidal forces near the black hole increasingly distort the star. If the star passes too close, it is ripped apart.

**3.** The part of the star facing the black hole streams toward it and forms an accretion disk. The remainder of the star just expands into space.

**4.** Near the black hole, magnetic fields power a narrow jet of particles moving near the speed of light. Viewed head-on, the jet is a brilliant X-ray and radio source.



# Swift 500 GRBs

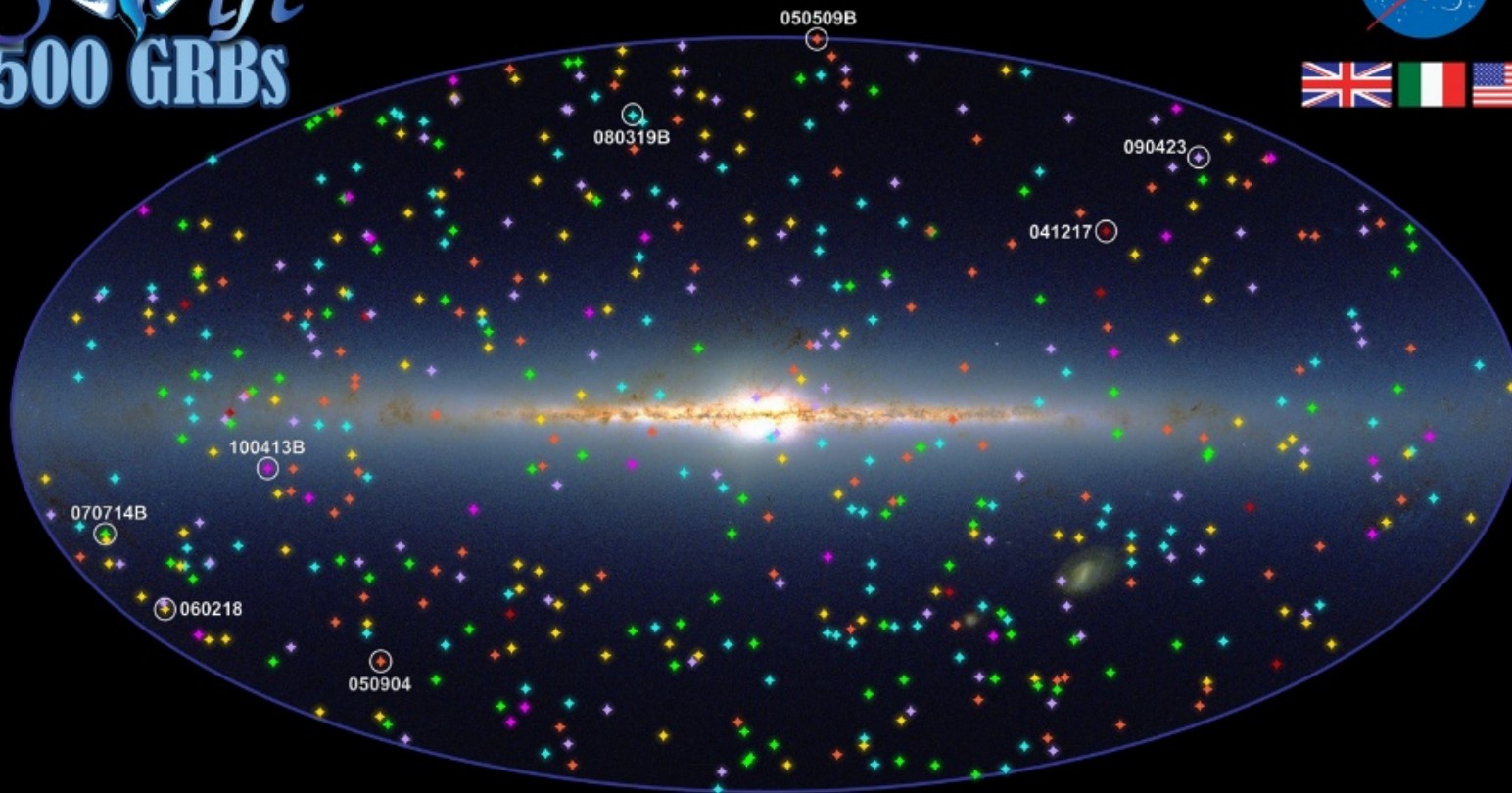

2004 2005 2006 2007 2008 2009 2010

[www.nasa.gov/swift](http://www.nasa.gov/swift)

# Swift 1000 GRBs

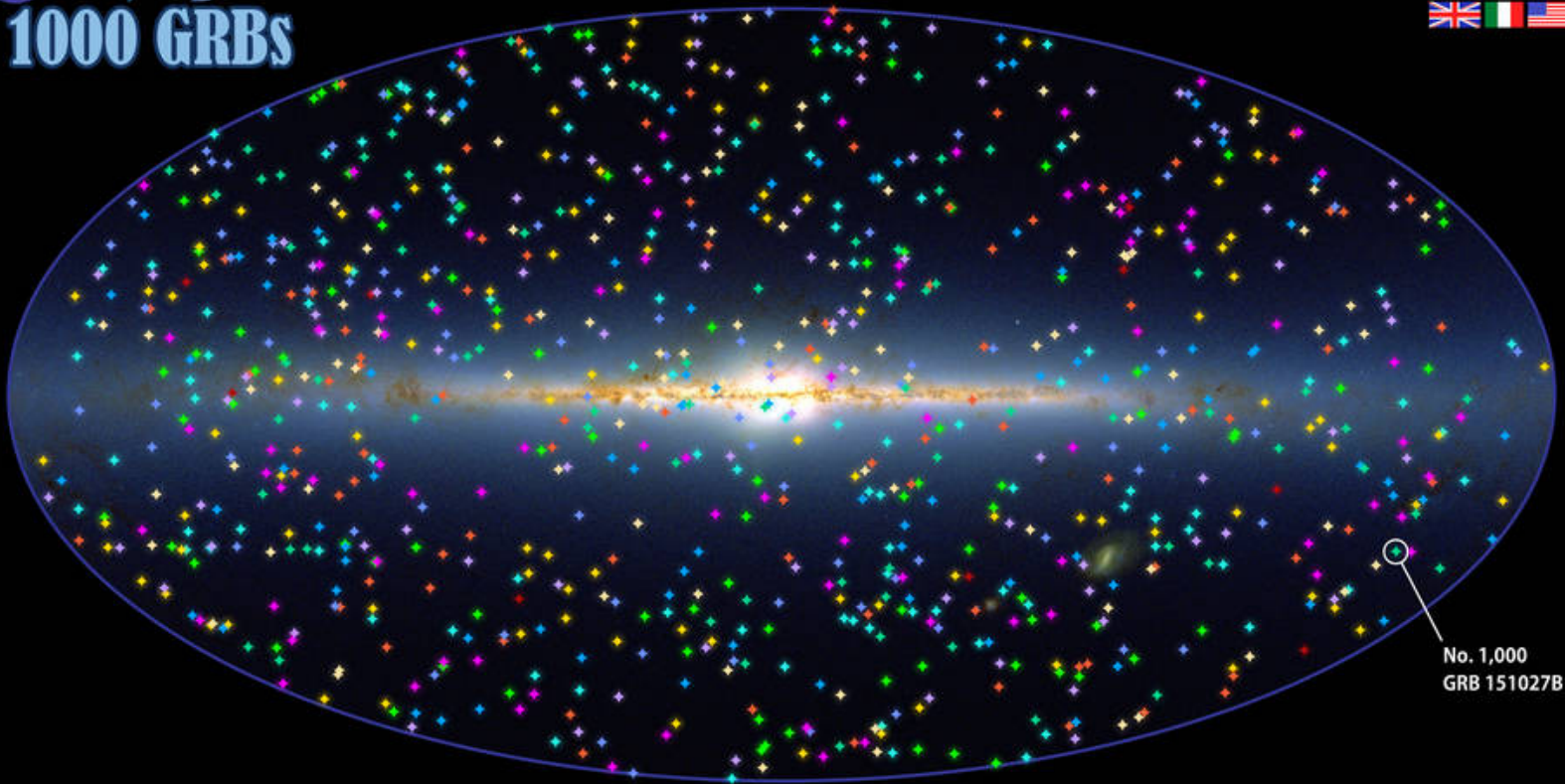

No. 1,000  
GRB 151027B

2004	2005	2006	2007	2008	2009	2010	2011	2012	2013	2014	2015
9	88	102	86	103	89	84	81	92	96	95	75 to Oct. 27

# Astrofisica Nucleare e Subnucleare

## Solid State Detectors



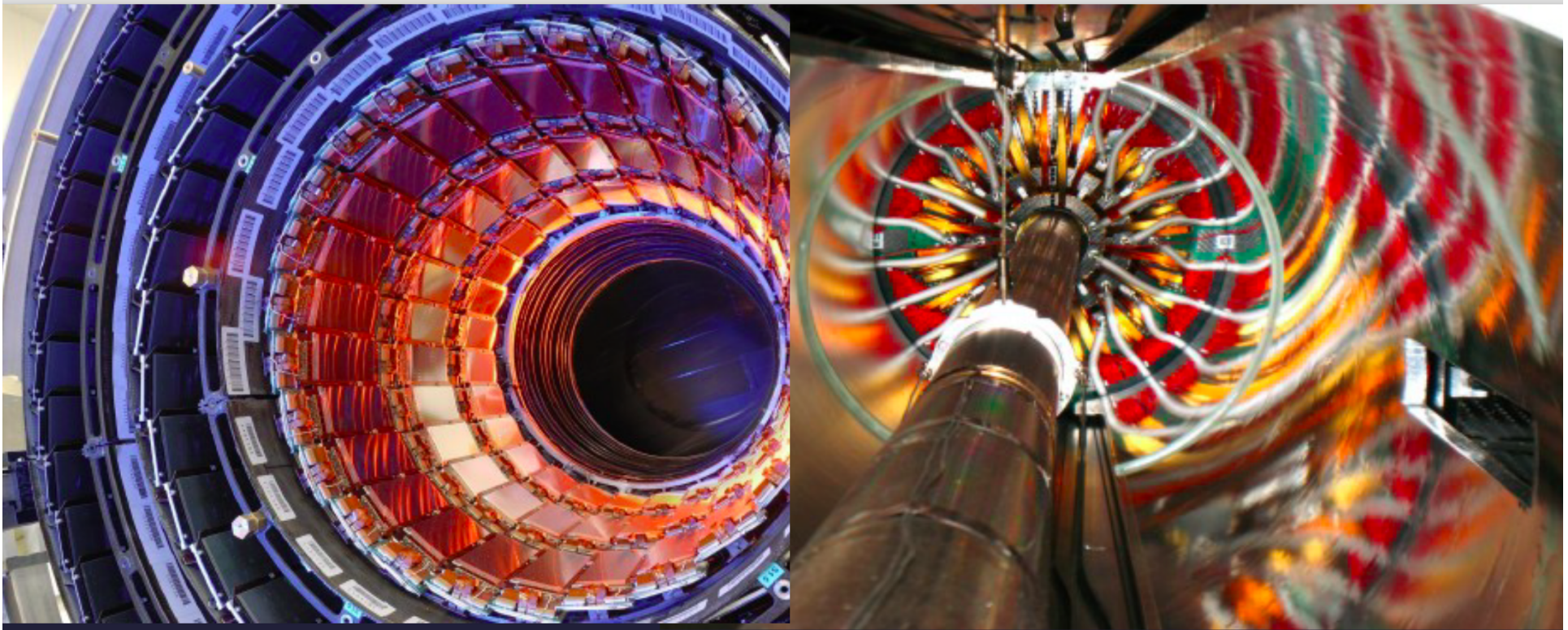

# Detectors for Particle Physics

Semiconductor Detectors

D. Bortoletto

# Solid State Detector

- A solid state detector is an ionization chamber
  - Ionizing radiation creates electron/hole pairs
  - Charge carriers move in applied E field
  - Motion induces a current in an external circuit, which can be amplified and sensed.

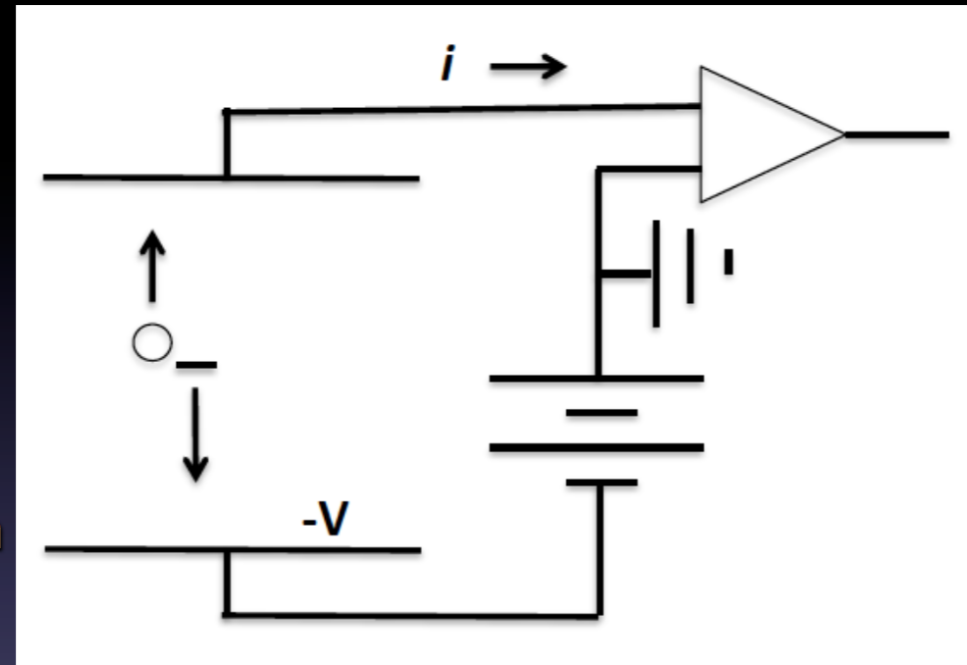

	Gas	Solid
Density	Low	High
Atomic number (Z)	Low	Moderate (Z=14)
Ionization Energy ( $\epsilon_i$ )	Moderate ( $\approx 30$ eV)	Low ( $\approx 3.6$ eV)
Signal Speed	Moderate (10ns-10 $\mu$ s)	Fast (<20 ns)

# Comparison solid state versus gas

**Ionization chamber medium could be gas, liquid, or solid**

- **Gas** ⇒ electron and ion pairs; **Semiconductor** ⇒ electron and hole pairs

	<b>Gas</b>	<b>Solid</b>
<b>Density</b>	<b>Low</b>	<b>High</b>
<b>Atomic number (Z)</b>	<b>Low</b>	<b>Moderate (Z=14)</b>
<b>Ionization Energy (<math>\epsilon_I</math>)</b>	<b>Moderate (<math>\approx 30</math> eV)</b>	<b>Low (<math>\approx 3.6</math> eV)</b>
<b>Signal Speed</b>	<b>Moderate (10ns-10<math>\mu</math>s)</b>	<b>Fast (&lt;20 ns)</b>

## Solid State Detectors

- Energy (E) to create e-h pairs 10 times smaller than gas ionization ⇒ increase charge ⇒ good E resolution

$$\frac{\Delta E}{E} \propto \frac{1}{\sqrt{N}} \propto \frac{1}{\sqrt{E / \epsilon_I}} \propto \sqrt{\epsilon_I}$$

- Greater density:
  - Reduced range of secondary electrons ⇒ excellent spatial resolution
  - Average  $E_{\text{loss}} \approx 390 \text{ eV} / \mu\text{m} \approx 108 \text{ e-h} / \mu\text{m}$  (charge collected is a function of thickness d. Up-to-now no multiplication)
- To minimize multiple scattering d is small
  - 300  $\mu\text{m} \approx 32,000$  e-h pairs ⇒ good S/N



# Solid State Detectors

## Gas Detectors

In gaseous detectors, a charged particle is liberating electrons from the atoms, which are freely bouncing between the gas atoms.

An applied electric field makes the electrons and ions move, which induces signals on the metal readout electrodes.

For individual gas atoms, the electron energy levels are discrete.

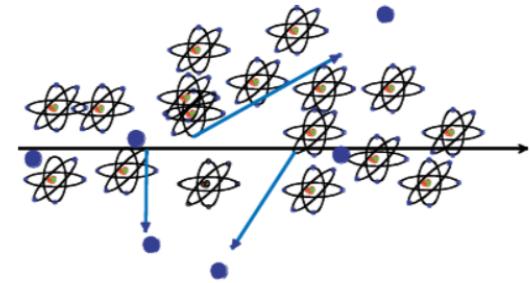

## Solid State Detectors

In solids (crystals), the electron energy levels are in 'bands'.

Inner shell electrons, in the lower energy bands, are closely bound to the individual atoms and always stay with 'their' atoms.

In a crystal there are however energy bands that are still bound states of the crystal, but they belong to the entire crystal. Electrons in these bands and the holes in the lower band can freely move around the crystal, if an electric field is applied.

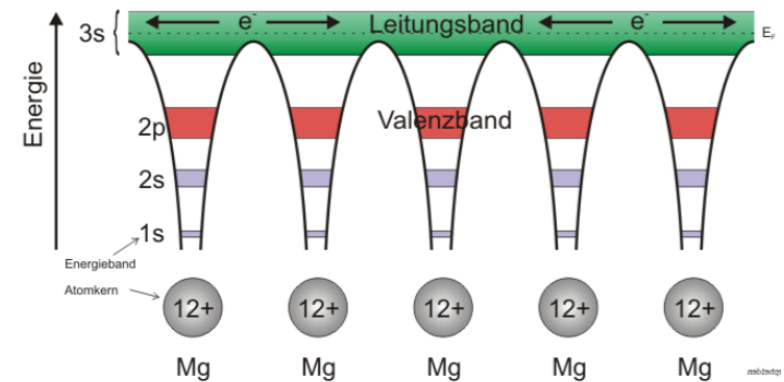

# Solid State Detectors

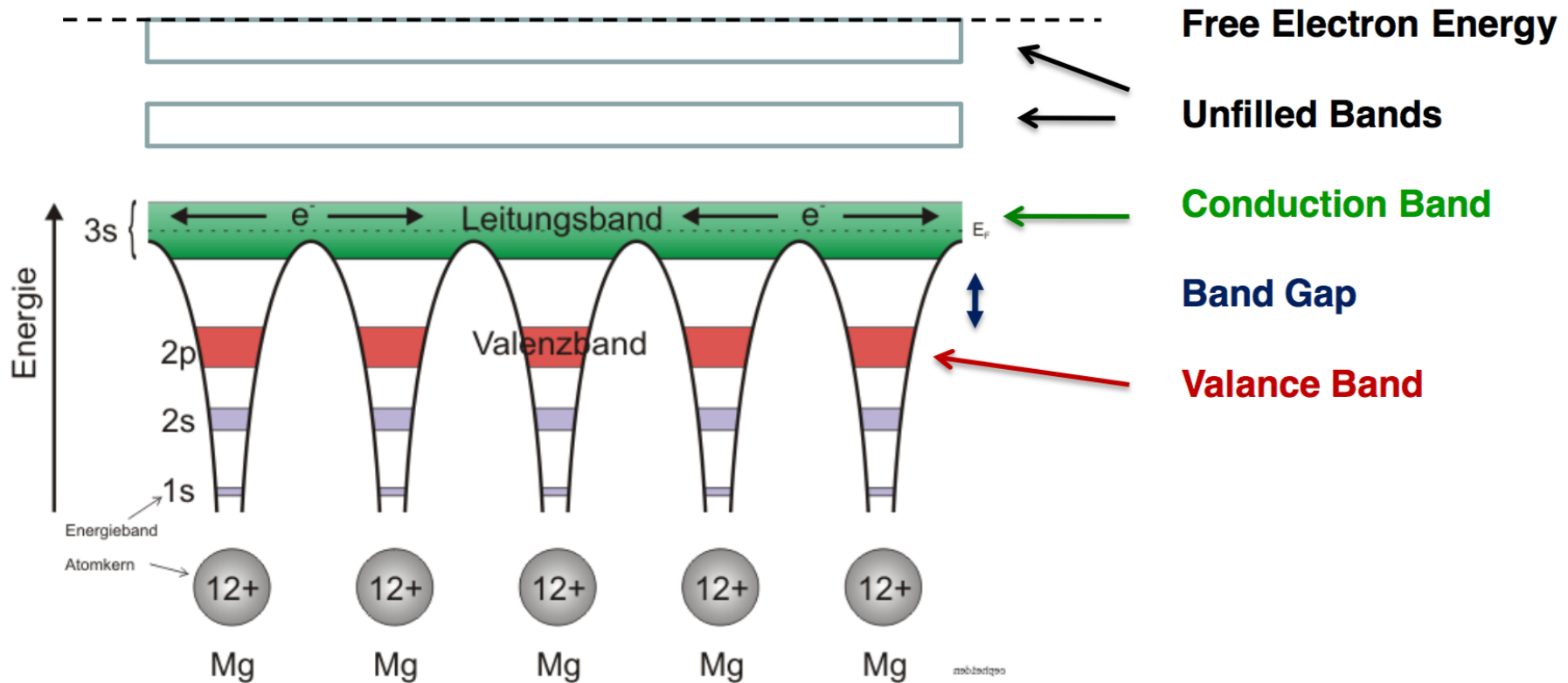

## Conductor, Insulator, Semiconductor

In case the conduction band is filled the crystal is a conductor.

In case the conduction band is empty and 'far away' from the valence band, the crystal is an insulator.

In case the conduction band is empty but the distance to the valence band is small, the crystal is a semiconductor.

# Solid State Detectors

## Band Gap, e-h pair Energy

The energy gap between the last filled band – the valence band – and the conduction band is called band gap  $E_g$ .

The band gap of Diamond/Silicon/Germanium is 5.5, 1.12, 0.66 eV.

The average energy to produce an electron/hole pair for Diamond/Silicon/Germanium is 13, 3.6, 2.9eV.

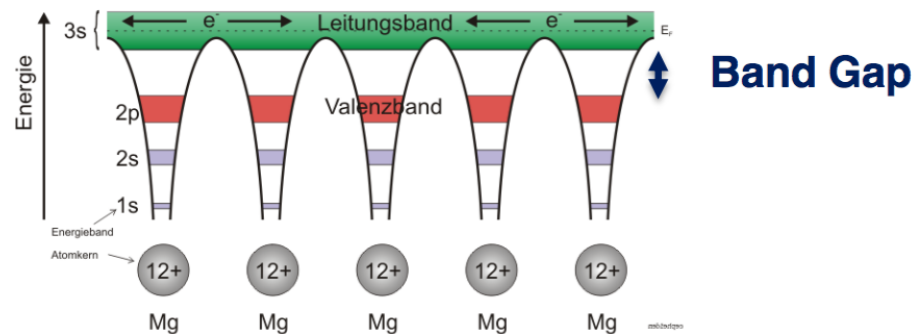

## Temperature, Charged Particle Detection

In case an electron in the valence band gains energy by some process, it can be excited into the conduction band and a hole in the valence band is left behind.

Such a process can be the passage of a charged particle, but also thermal excitation → probability is proportional  $\text{Exp}(-E_g/kT)$ .

The number of electrons in the conduction band is therefore increasing with temperature i.e. the conductivity of a semiconductor increases with temperature.

# Solid State Detectors

## Electron, Hole Movement:

It is possible to treat electrons in the conduction band and holes in the valence band similar to free particles, but with an effective mass different from elementary electrons not embedded in the lattice.

This mass is furthermore dependent on other parameters such as the direction of movement with respect to the crystal axis. All this follows from the QM treatment of the crystal (solid state physics).

## Cooling:

If we want to use a semiconductor as a detector for charged particles, the number of charge carriers in the conduction band due to thermal excitation must be smaller than the number of charge carriers in the conduction band produced by the passage of a charged particle.

Diamond ( $E_g=5.5\text{eV}$ ) can be used for particle detection at room temperature,  
Silicon ( $E_g=1.12\text{ eV}$ ) and Germanium ( $E_g=0.66\text{eV}$ ) must be cooled, or the free charge carriers must be eliminated by other tricks → doping → see later.

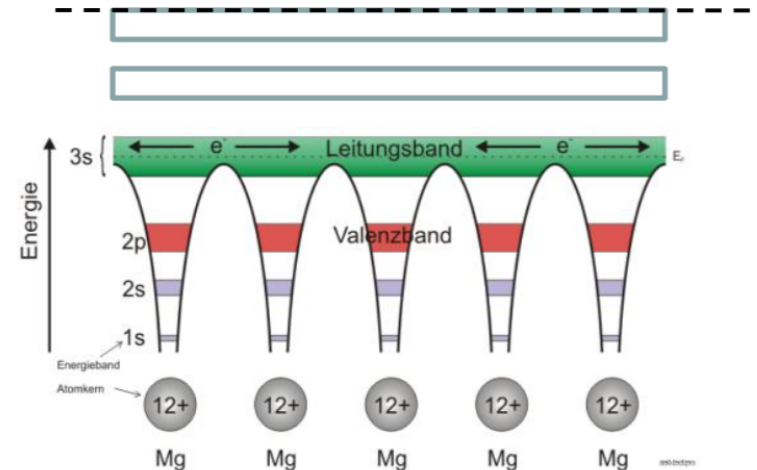

# Solid State Detectors

## Primary 'ionization':

The average energy to produce an electron/hole pair is:  
Diamond (13eV), Silicon (3.6eV), Germanium (2.9eV)

Comparing to gas detectors, the density of a solid is about a factor 1000 larger than that of a gas and the energy to produce an electron/hole pair e.g. for Si is a factor 7 smaller than the energy to produce an electron-ion pair in Argon.

## Solid State vs. Gas Detector:

The number of primary charges in a Si detector is therefore about  $10^4$  times larger than the one in gas → while gas detectors need internal charge amplification, solid state detectors don't need internal amplification.

While in gaseous detectors, the velocity of electrons and ions differs by a factor 1000, the velocity of electrons and holes in many semiconductor detectors is quite similar → very short signals.

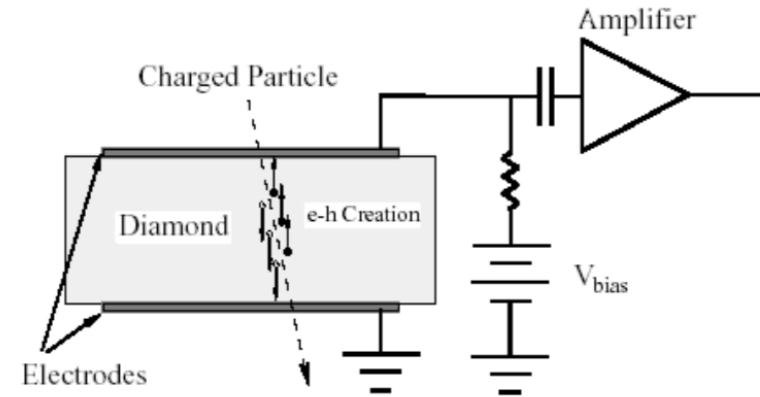

**Diamond → A solid state ionization chamber**

# Silicon Detector

## Velocity:

$\mu_e=1450 \text{ cm}^2/\text{Vs}$ ,  $\mu_h=505 \text{ cm}^2/\text{Vs}$ , 3.63eV per e-h pair.

~33000 e/h pairs in 300 $\mu\text{m}$  of silicon.

## However: Free charge carriers in Si:

T=300 K: e,h =  $1.45 \times 10^{10} / \text{cm}^3$  but only 33000 e/h pairs in 300 $\mu\text{m}$  produced by a high energy particle.

Why can we use Si as a solid state detector ???

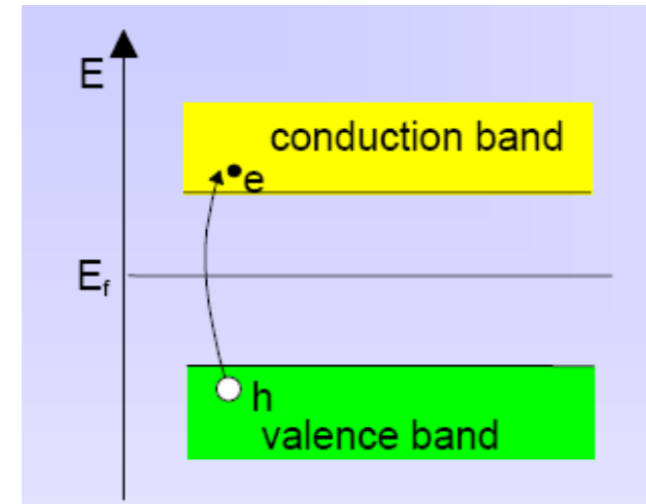



# Semiconductor

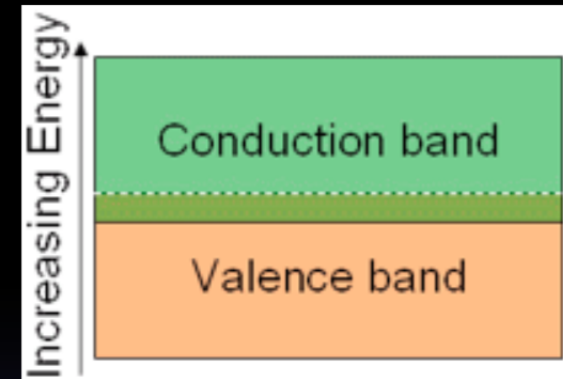
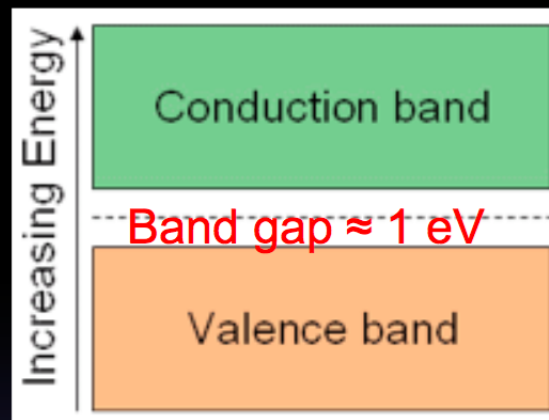
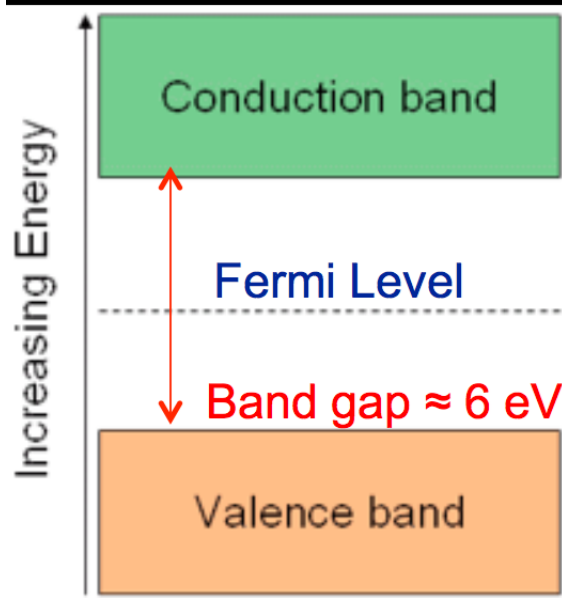

- Fermi level
  - Maximum electron energy at  $T = 0\text{ K}$

- Semiconductor: at room temperature electrons can already occupy the conduction band and may recombine with holes.
- Thermal equilibrium is reached between excitation and recombination when the charge carrier concentration  $n_e = n_h = n_i =$  intrinsic carrier concentration  $\approx 1.5 \times 10^{10}\text{ cm}^{-3}$

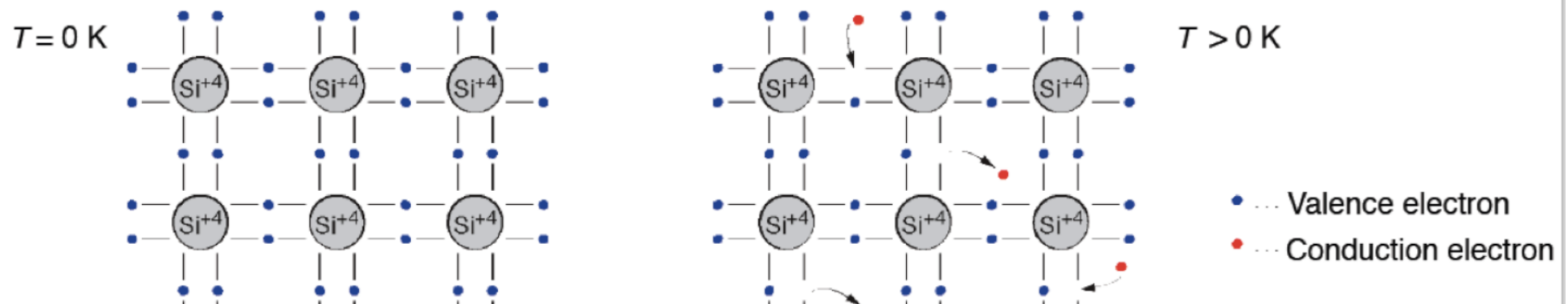

# Doped semiconductors

## DONOR (N)

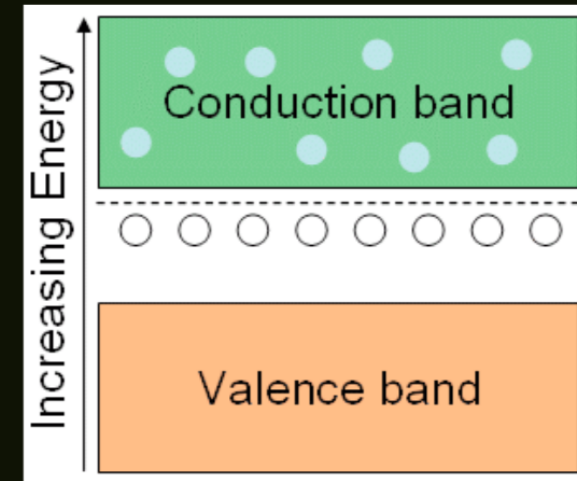
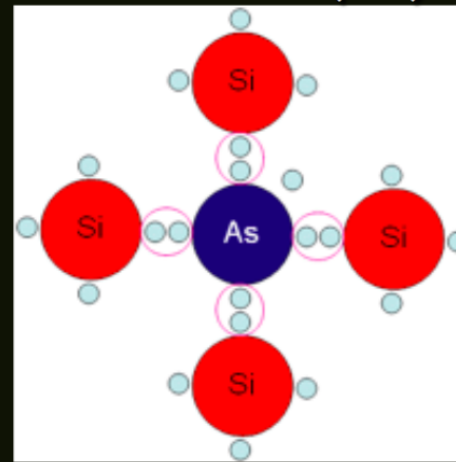
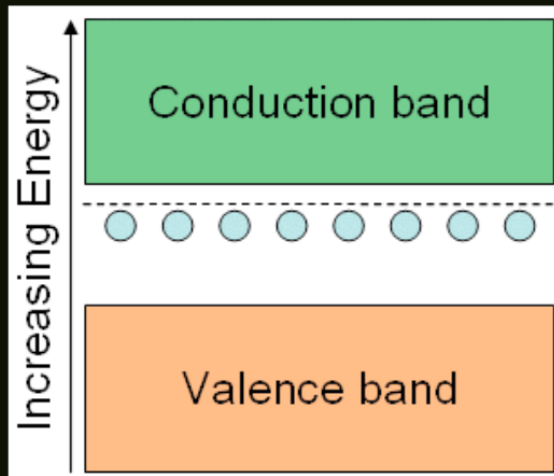

## ACCEPTOR (P)

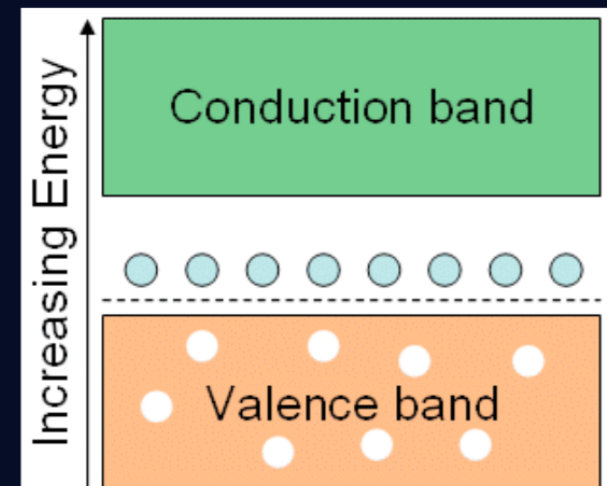
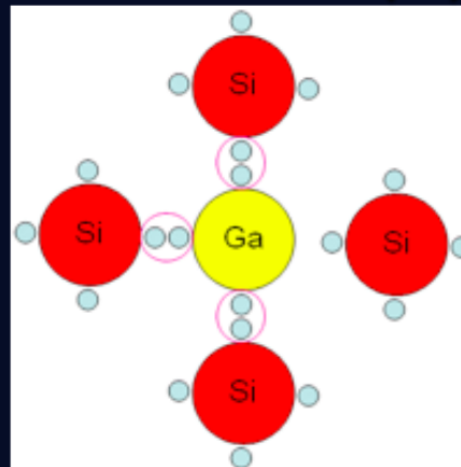
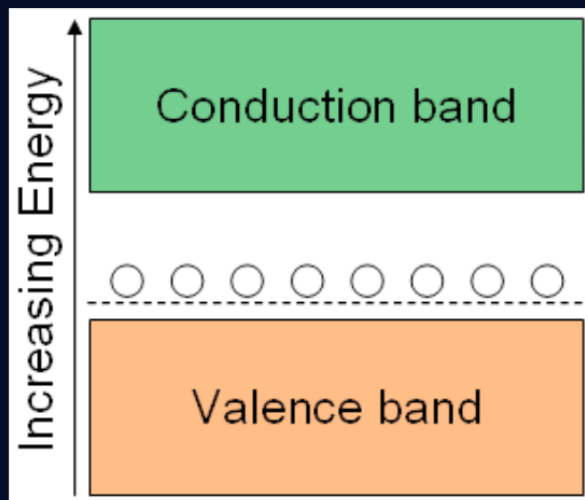



# Doping of Silicon

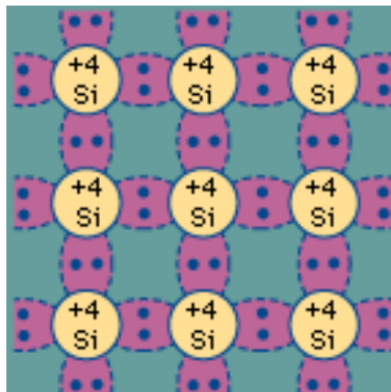

doping

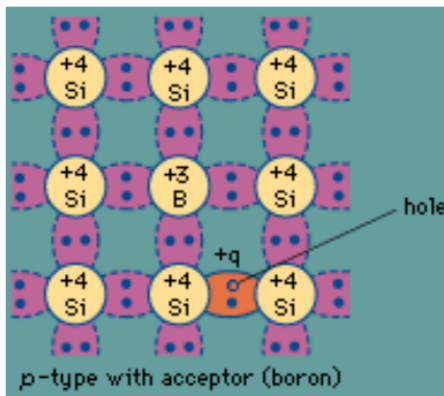
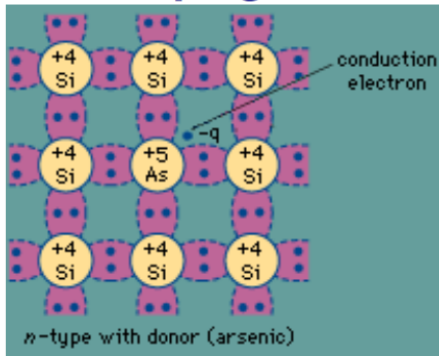

In a silicon crystal at a given temperature the number of electrons in the conduction band is equal to the number of holes in the valence band.

Doping Silicon with Arsen (+5) it becomes an n-type conductor (more electrons than holes).

Doping Silicon with Boron (+3) it becomes a p-type conductor (more holes than electrons).

Bringing p and n in contact makes a diode.

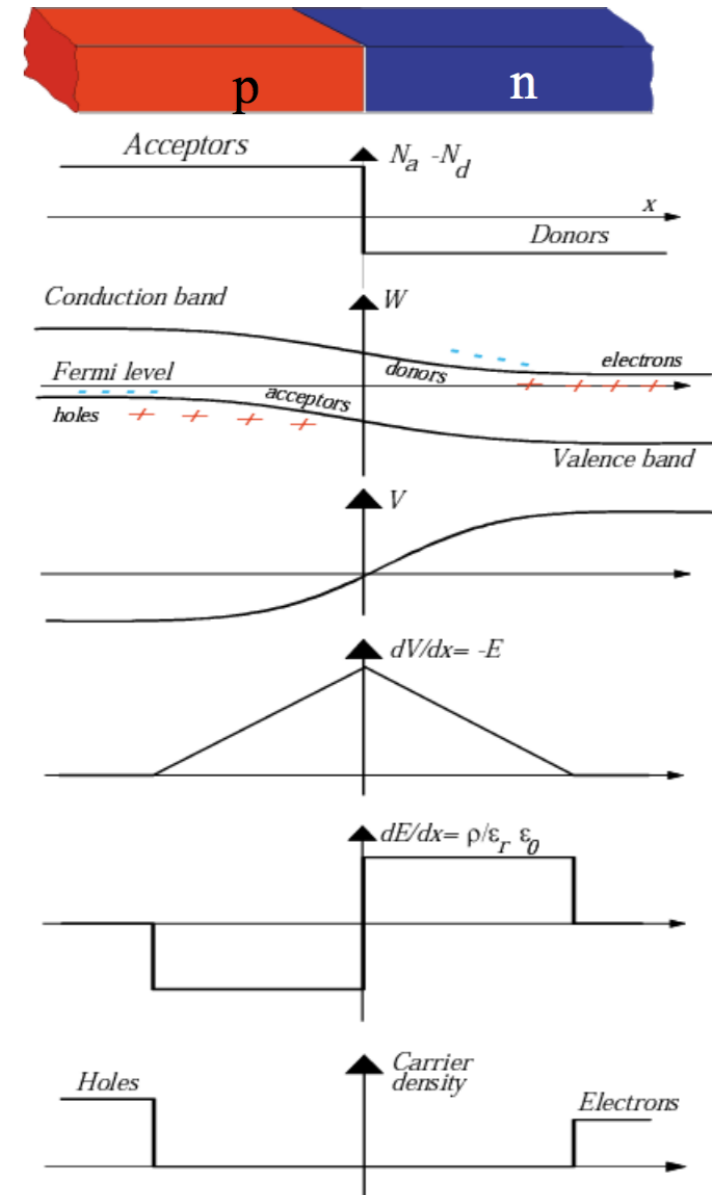

# PN Junction

- PN junction without external voltage
  - Free charges move until the chemical potential is balanced by an electrical potential called the built-in potential

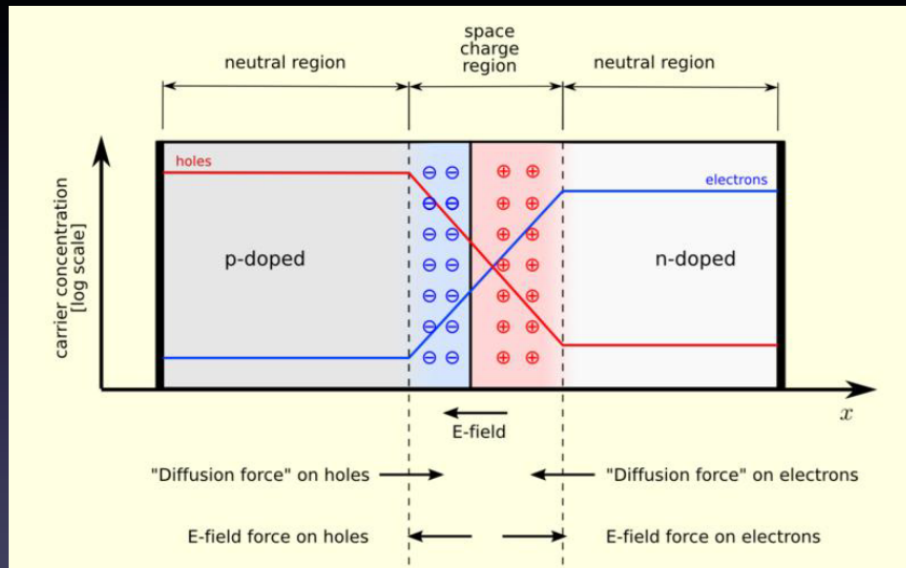

- The space charge (depletion) region can be made bigger by applying a reverse bias voltage

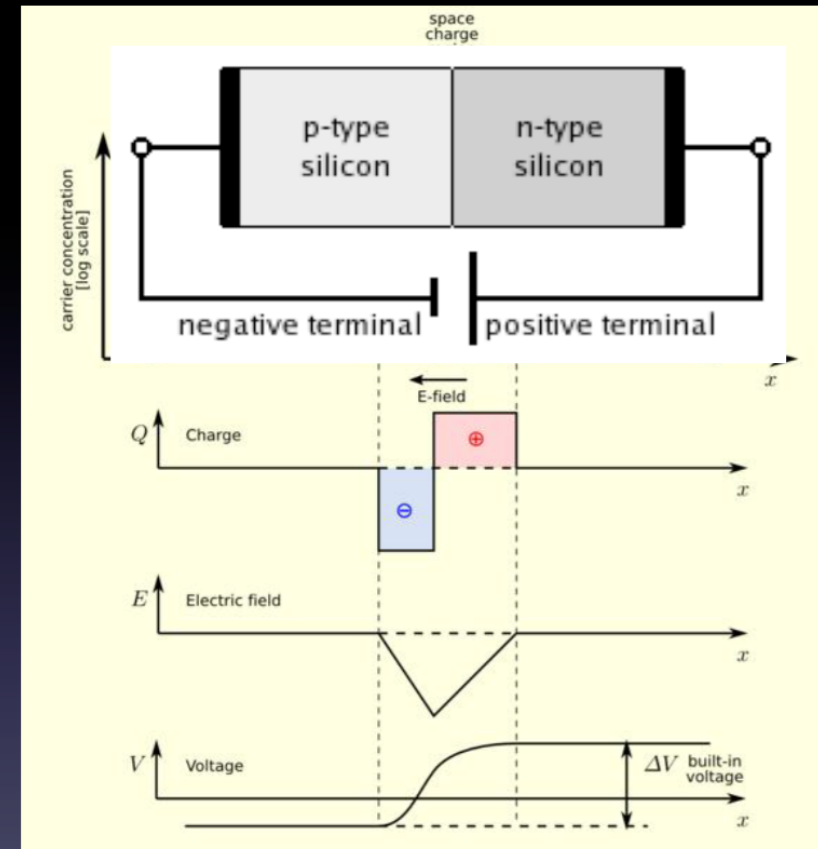

# Si-Diode used as a Particle Detector !

At the p-n junction the charges are depleted and a zone free of charge carriers is established.

By applying a voltage, the depletion zone can be extended to the entire diode → highly insulating layer.

An ionizing particle produces free charge carriers in the diode, which drift in the electric field and induce an electrical signal on the metal electrodes.

As silicon is the most commonly used material in the electronics industry, it has one big advantage with respect to other materials, namely highly developed technology.

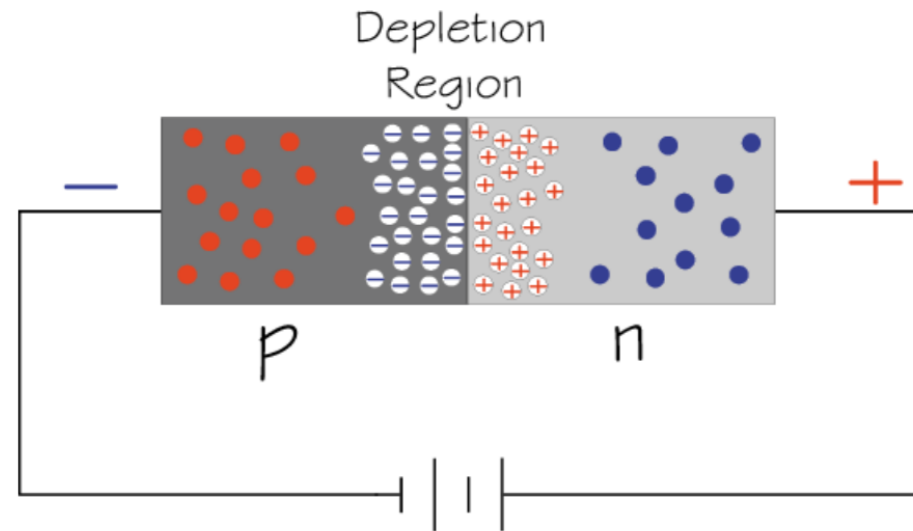

- Electron
- ⊕ Positive ion from removal of electron in n-type impurity
- ⊖ Negative ion from filling in p-type vacancy
- Hole

# Under-Depleted Silicon Detector

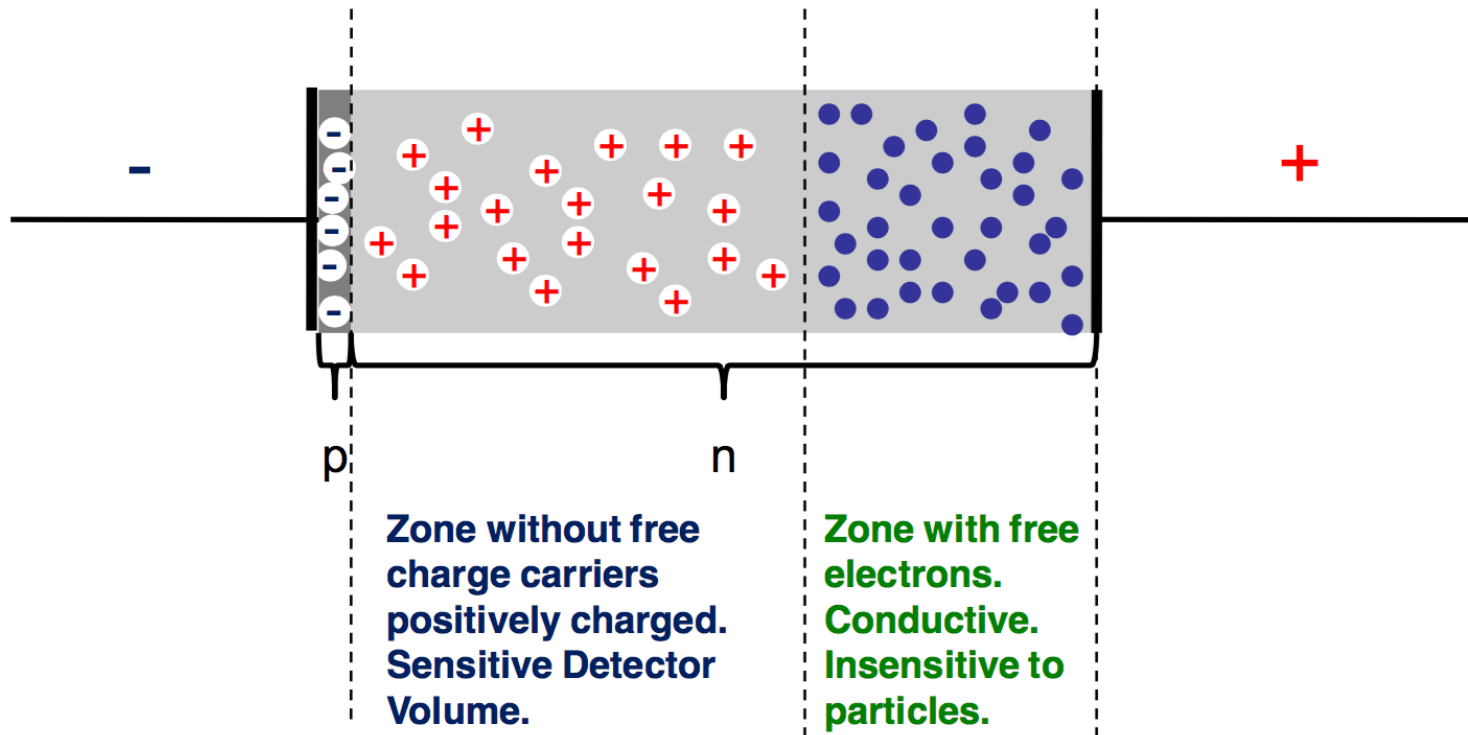

# Fully-Depleted Silicon Detector

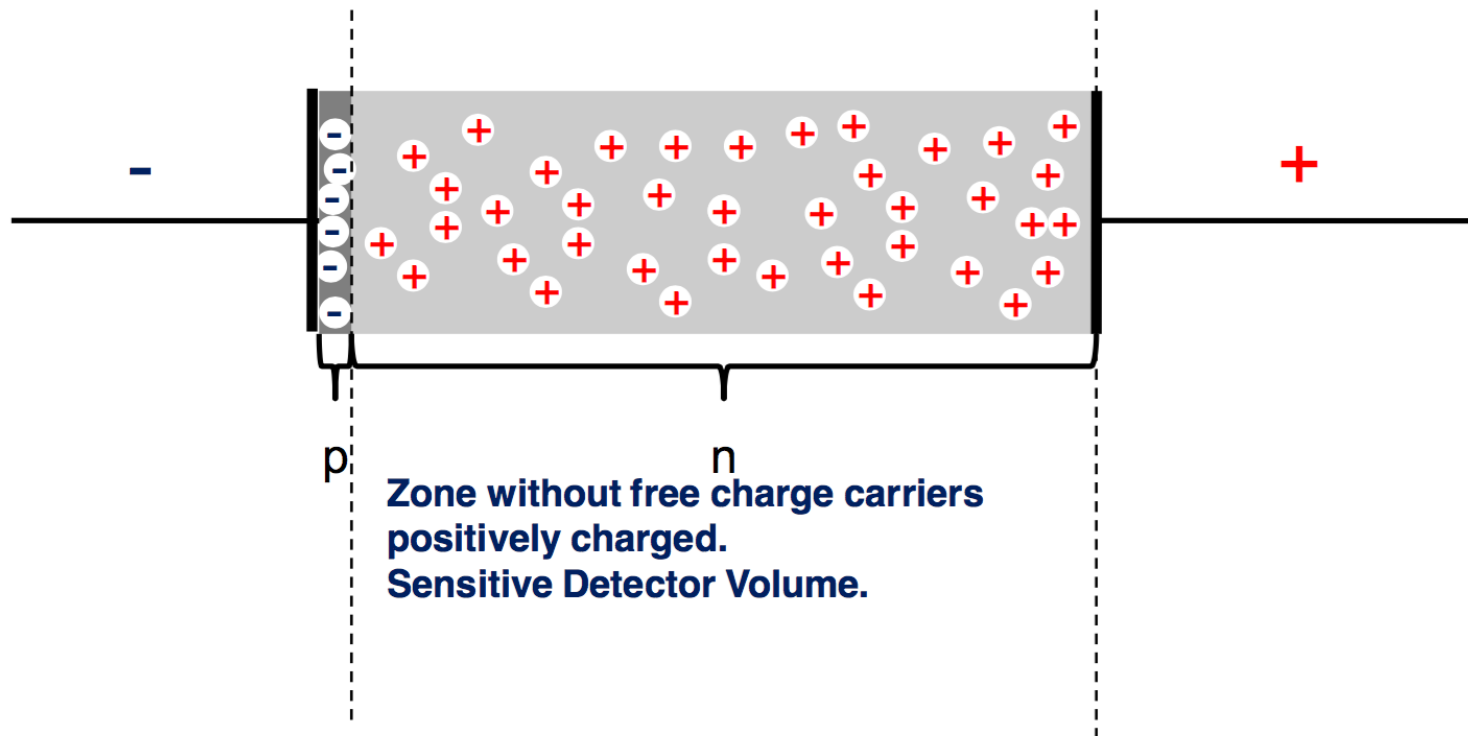

# Silicon Detector

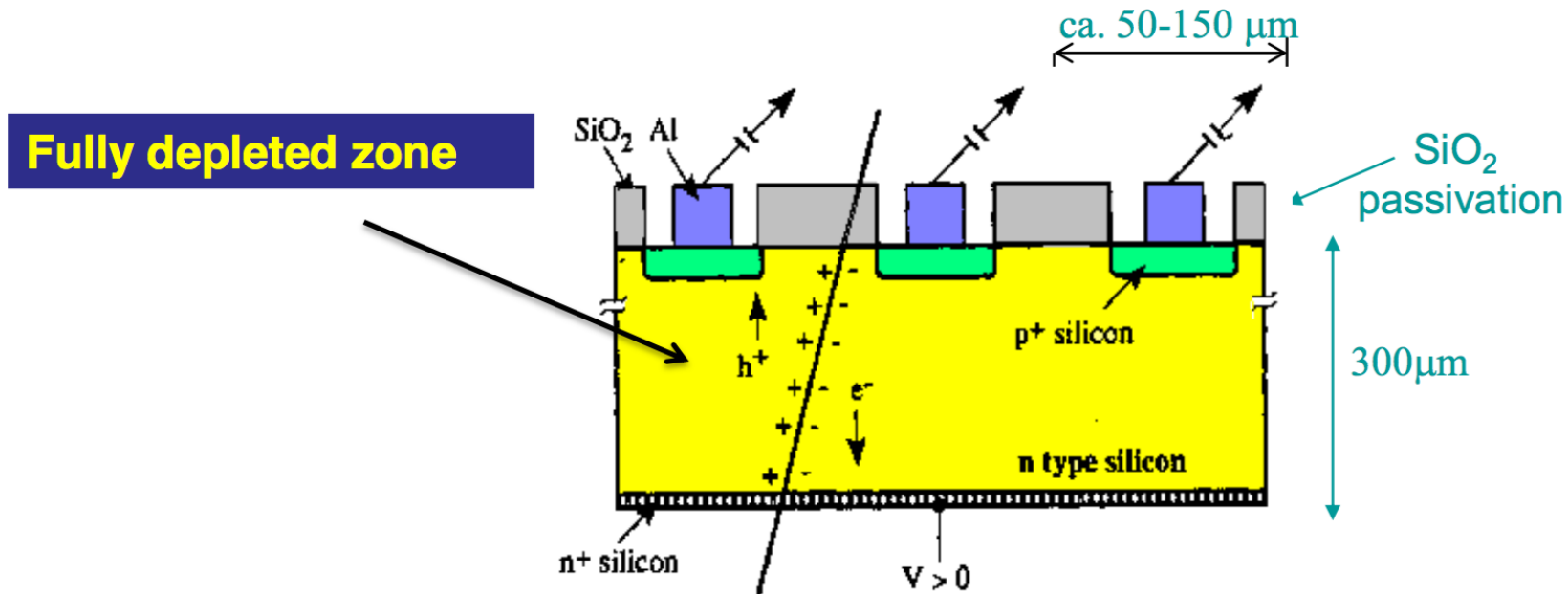

**$N(\text{e-h}) = 11\ 000/100\mu\text{m}$**

**Position Resolution down to  $\sim 5\mu\text{m}$  !**

# Silicon Strip Detectors (SSD)

- By segmenting the implant we can reconstruct the position of the traversing particle in one dimension
- DC-coupled strip detector – simplest position sensitive Silicon detector
- Standard configuration:
  - Strips p implants
  - Substrate n doped ( $\sim 2\text{-}10\text{ k}\Omega\text{cm}$ ) and  $\sim 300\mu\text{m}$  thick
  - $V_{\text{dep}} < 200\text{ V}$
  - Backside Phosphorous implant to establish ohmic contact and to prevent early breakdown
- Highest field close to the collecting electrodes (junction side) where most of the signal is induced

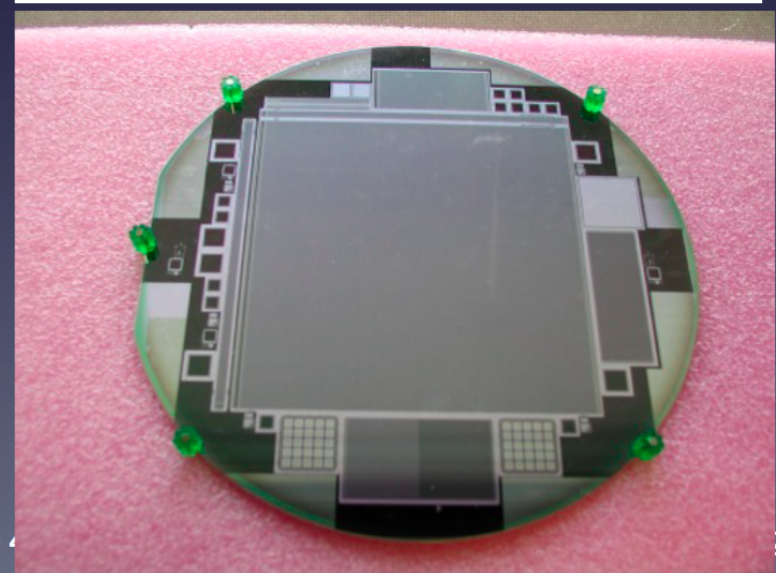
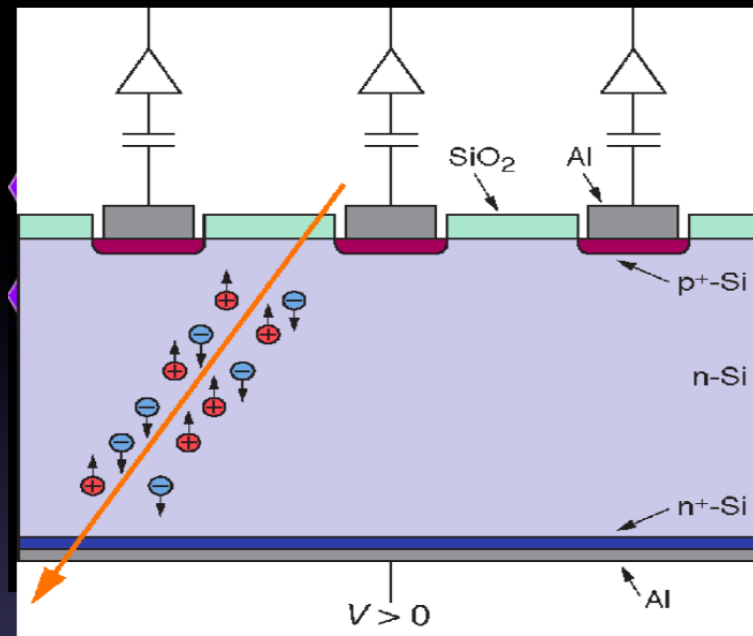



# Double Sided Silicon Detectors

- **Advantages:**
  - More elegant for measuring 2 coordinates than using stereo modules
  - Saves material
- **Disadvantages:**
  - Needs special strip insulation of n-side (p-stop, p-spray techniques)
  - Complicated manufacturing and handling procedures
- Expensive
- Ghost hits possible

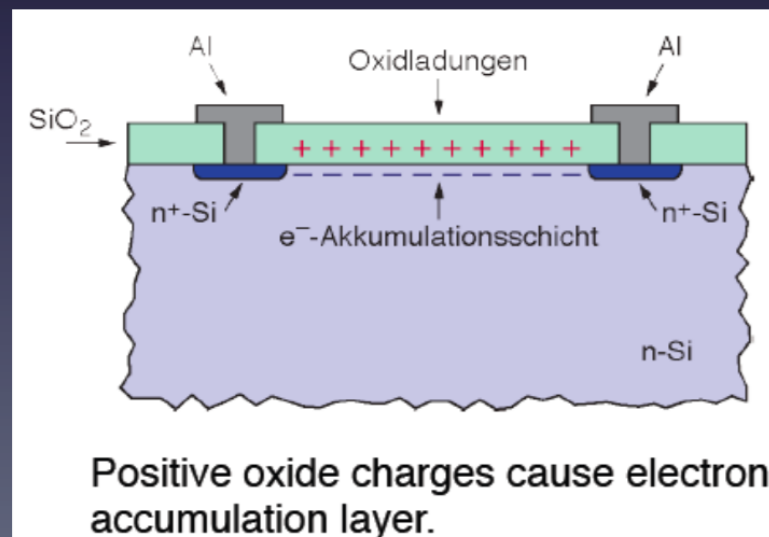
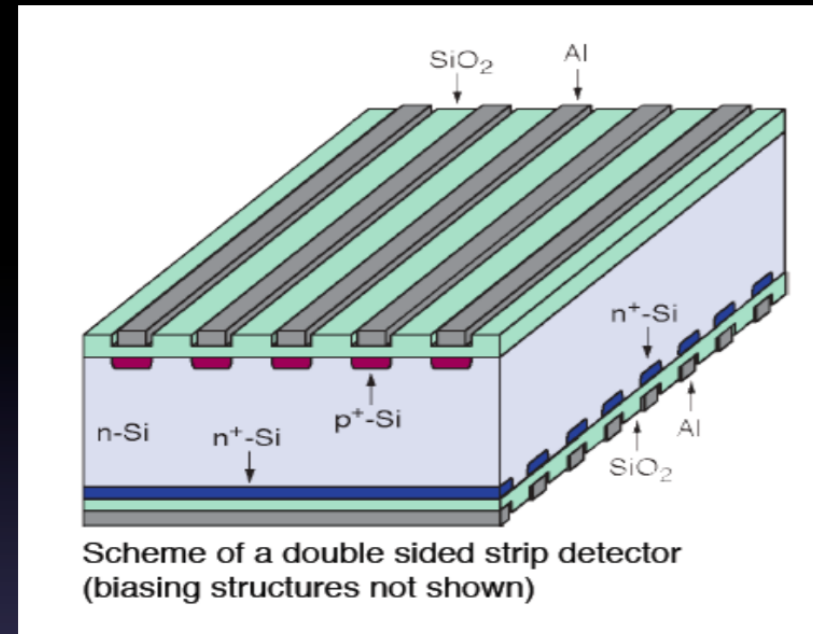
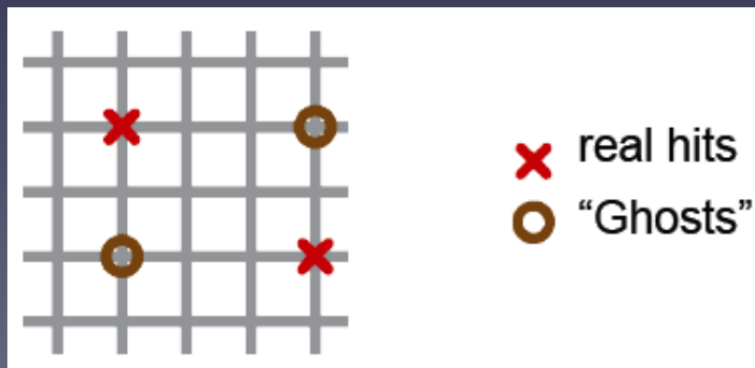



# Silicon Detector

Every electrode is connected to an amplifier →  
Highly integrated readout electronics.

Two dimensional readout is possible.

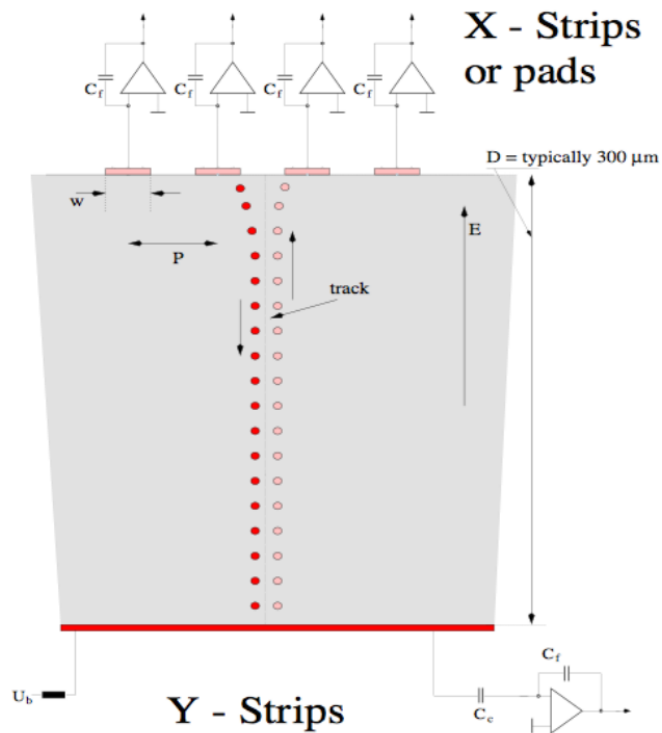

## CMS Outer Barrel Module

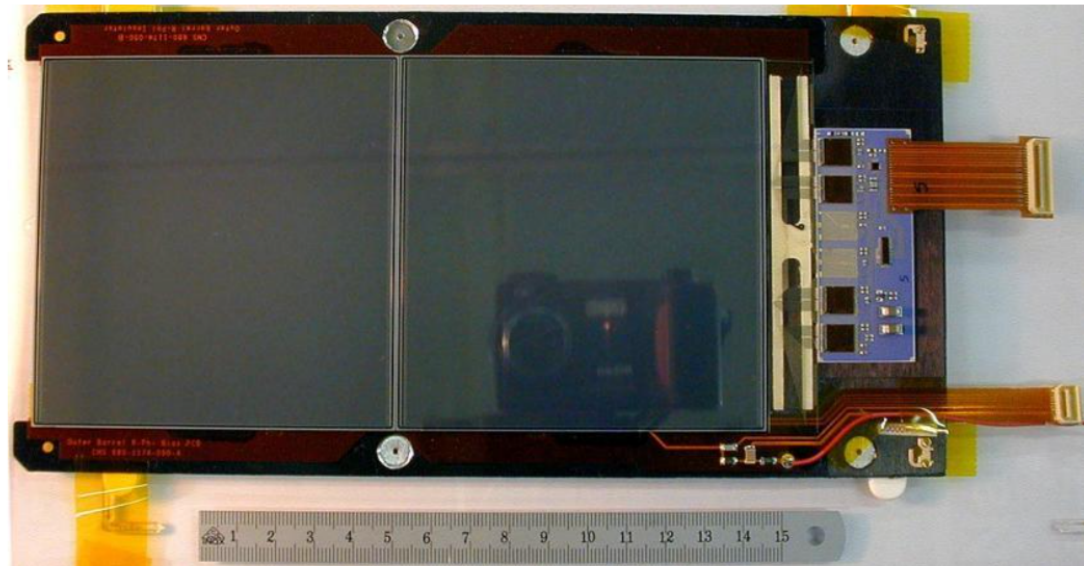

# Silicon Drift Detector (like gas TPC !)

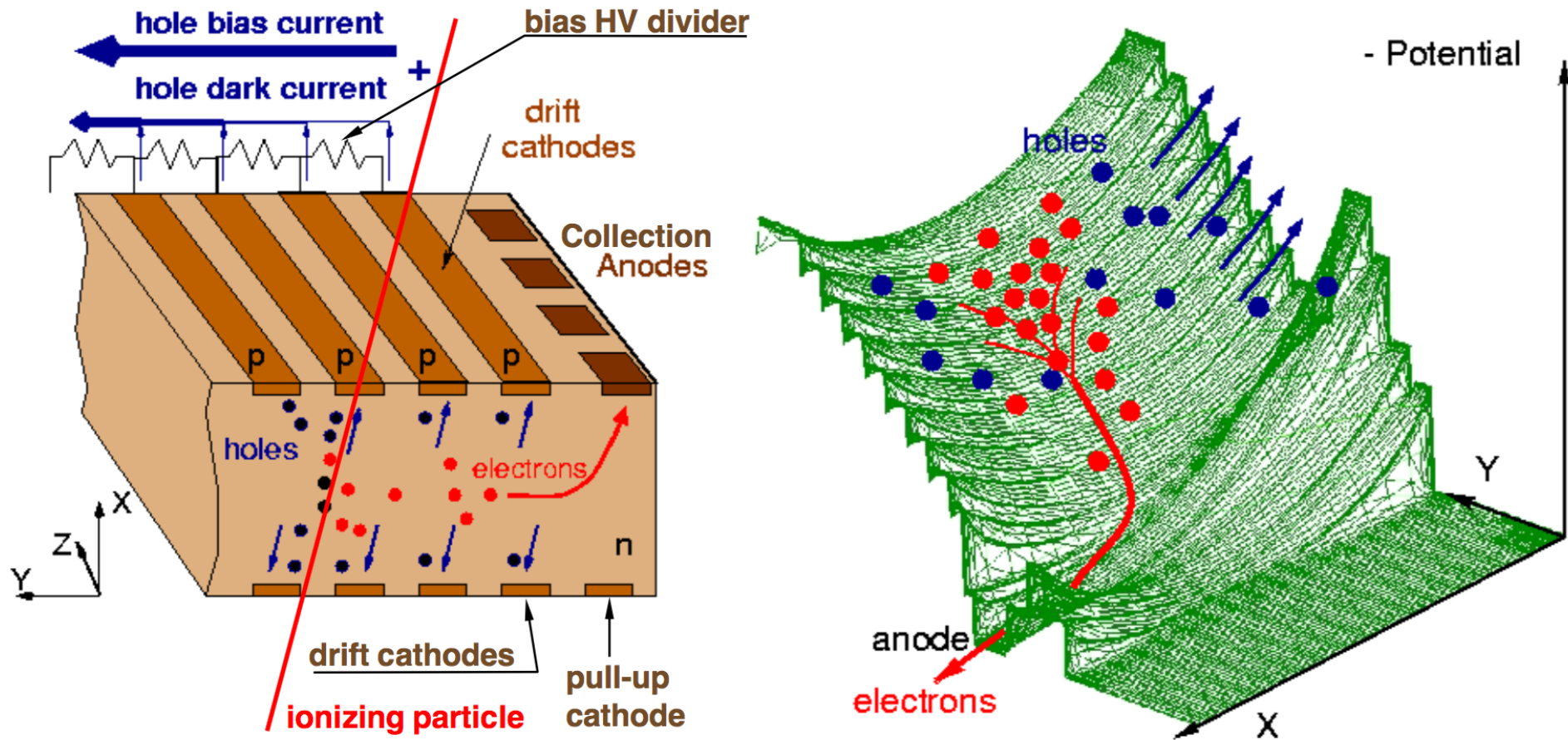

# Astrofisica Nucleare e Subnucleare

## “X-ray” Astrophysics

# Detector Project

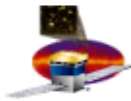

GLAST Project

For SWG discussion , Huntsville, 2002.9.13

## Definition of Terms

---

- ◆ Effective Area:

$A_{\text{eff}}$

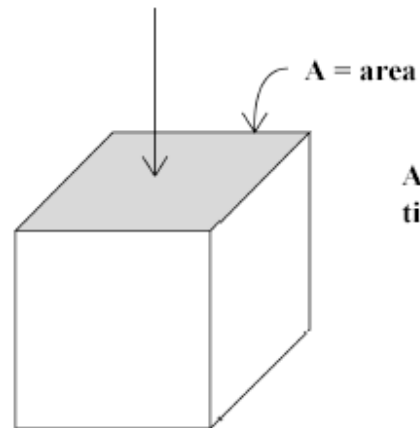

Area at normal incidence  
times detection efficiency.

- ◆ Energy Resolution:

$E_R$

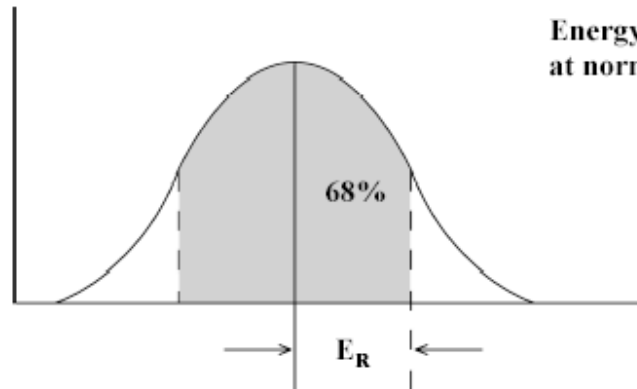

Energy 68% spread  
at normal incidence.

# Detector Project

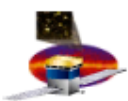

GLAST Project

For SWG discussion, Huntsville, 2002.9.13

## Definition of Terms

◆ **Angular Resolution:**

$$\Theta_R$$

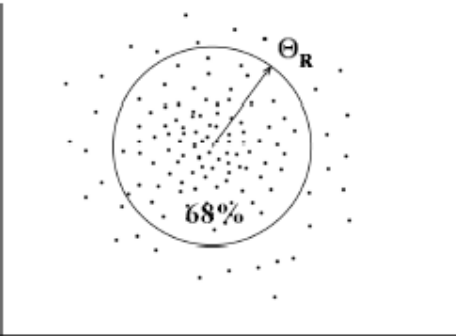

Space angle for 68% containment at normal incidence.

◆ **Field of View:**

$$FOV$$

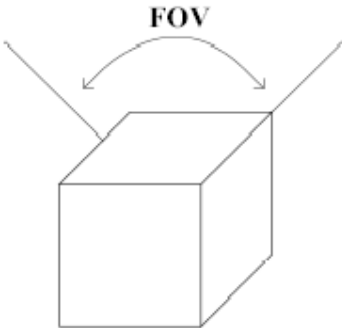

Integral effective area over solid angle divided by peak effective area.

◆ **Sensitivity:**

Flux of weakest source that can be detected at 5 sigma significance.

# Nobel prize 2002 – R.Giacconi

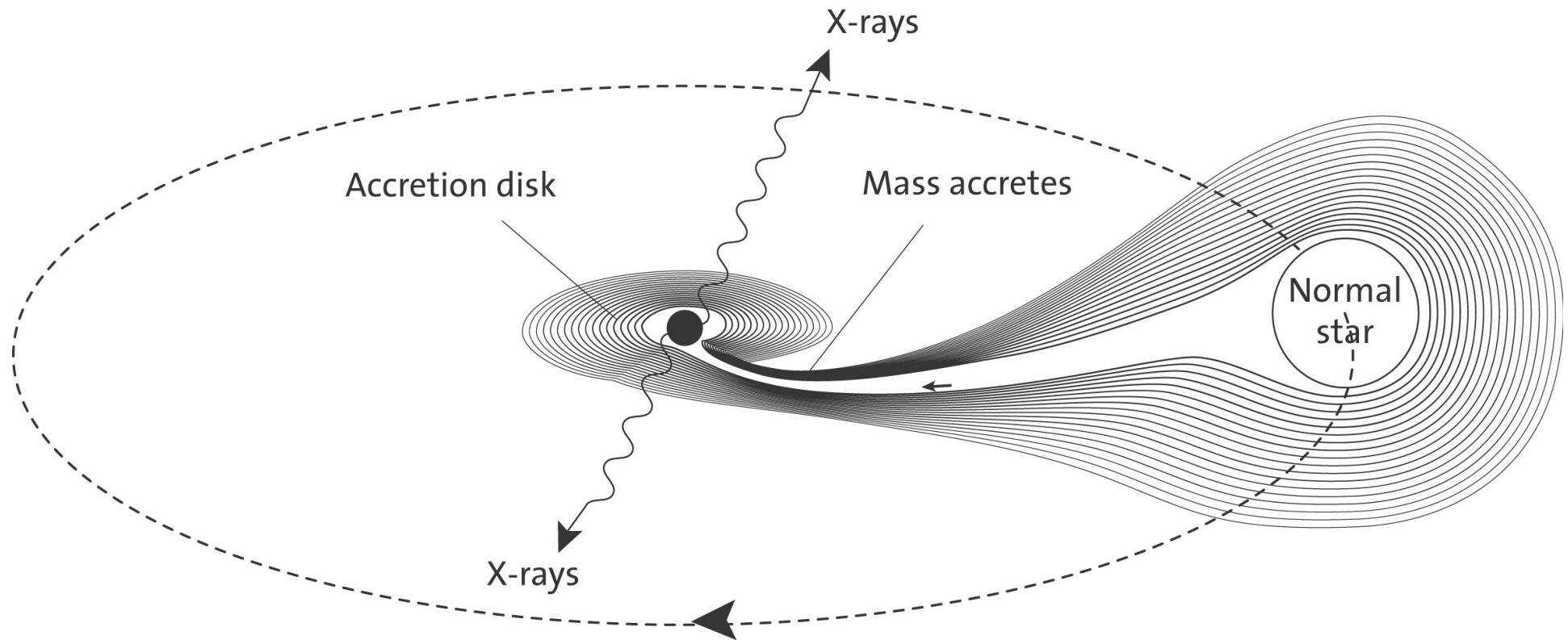

“ ... for pioneering contributions to astrophysics,  
which have led to the discovery of cosmic X-ray sources”

# **Strumentazioni per l'astrofisica**

(prima parte)

## **Rivelazione di raggi X/ $\gamma$ in condizioni astronomiche**

**partly adapted from G. Malaguti's Lessons**  
*Istituto Nazionale di Astrofisica (INAF) IASF-Bologna*



# Scanning with Slat Collimators

- **Imaging the sky with non-imaging X-ray instruments as a goal**
- **Linear scanning means position is determined in one direction**
- **At least a second scanning, preferentially in the direction perpendicular to the previous one**
- **First all-sky survey in X-rays by Uhuru (1970-72): 2 prop. counters with metal collimators ( $0.5^\circ \times 5^\circ$ ,  $5^\circ \times 5^\circ$  FWHM )**

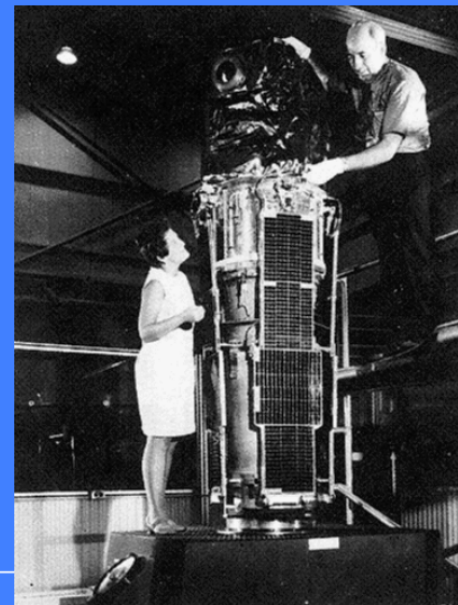
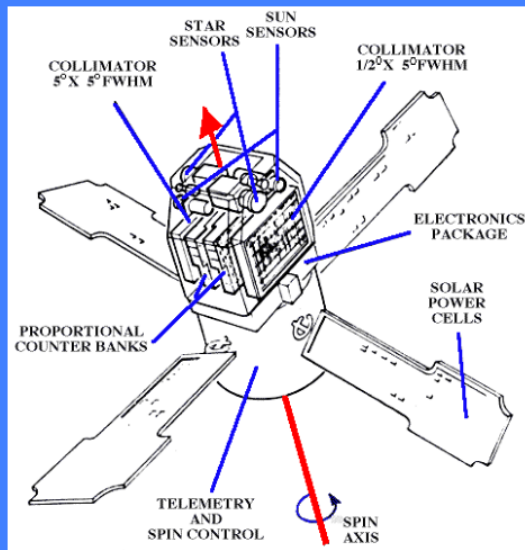



# Scanning Grid Collimators

- Two or more plane (“grid” of absorbing rods) collimators to improve angular resolution
- Higher resolution with three or more grids (e.g., 4 in HEAO-1 A-3 experiment)
- Two-dimensional measurements need scans in two or more directions

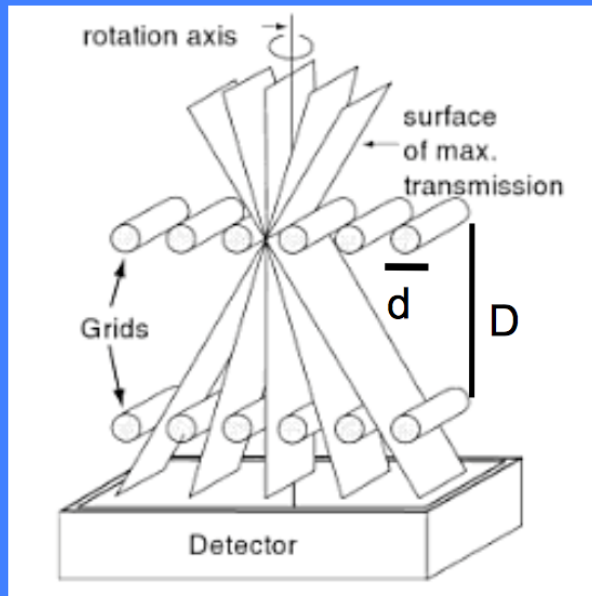

Double-grid collimator  
Transmission Function of triangular shape  
Angular resolution:  $d/D$

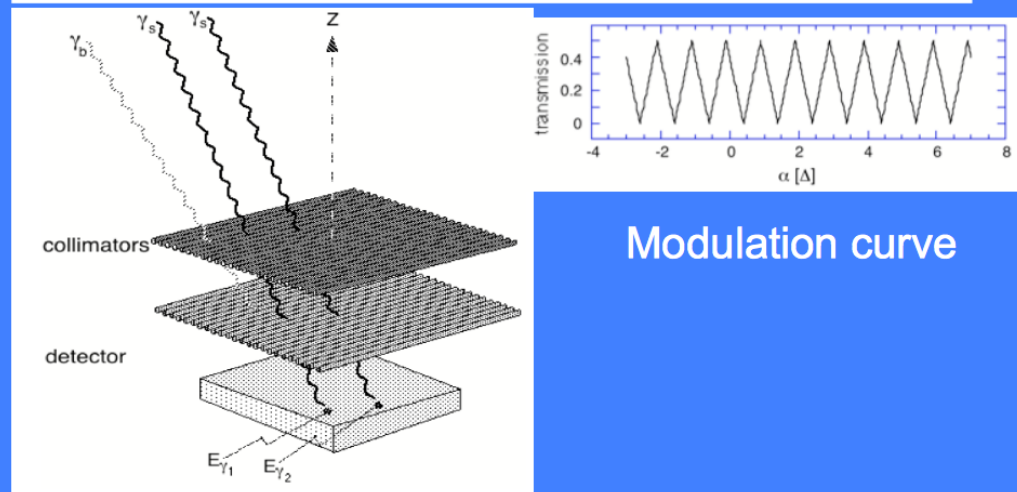

# Sensibilità - 1

- **Sensibilità = flusso minimo rivelabile**
  - **Emissione nel continuo:** fotoni  $\text{cm}^{-2} \text{s}^{-1} \text{keV}^{-1}$
  - **Emissione di righe:** fotoni  $\text{cm}^{-2} \text{s}^{-1}$
- **$C_S$  = Tasso di conteggi di sorgente**
- **$C_{Bkg}$  = Tasso di conteggi di fondo assumendo una statistica poissoniana**

$$SNR = n_\sigma = \frac{C_S}{\sqrt{C_S + C_{Bkg}}}$$

In realta' quello che si misura e'  $(S+B)-B$  in un dato intervallo di tempo

$$\begin{aligned} S &= (S + B) - B \longrightarrow \sigma_S^2 = \sigma_{S+B}^2 + \sigma_B^2 = \\ &= (\sqrt{(S + B)})^2 + (\sqrt{B})^2 = S + B + B = S + 2B \\ SNR &= S / \sigma_S = S / \sqrt{(S + 2B)} \end{aligned}$$

# Sensibilità – 2 – “basic” dependencies

$$S = \varepsilon A T \Delta E F_{src}$$

$$B = A T \Delta E F_{bkg}$$

$\varepsilon$ =efficienza di rivelazione fotoni della sorgente  
 $A$ =area efficace  
 $T$ =tempo di esposizione  
 $\Delta E$ =banda energetica  
 $F_{src}$ =flusso della sorgente  
 $F_{bkg}$ =fondo strumentale

$$B \ll \varepsilon F_{src}$$

$$SNR = \frac{S}{\sqrt{S + 2B}} \approx \sqrt{S} \propto \sqrt{F_{src} T}$$

the source dominates the signal

$$B \gg \varepsilon F_{src}$$

$$SNR = \frac{S}{\sqrt{S + 2B}} \approx S / \sqrt{2B} \propto \sqrt{T} (F_{src} / \sqrt{2F_{bkg}})$$

Backg-dominated obsn.



$$SNR = n_{\sigma} \approx \frac{\varepsilon \cdot A \cdot T \cdot \Delta E \cdot F}{\sqrt{A \cdot T \cdot \Delta E \cdot B}} \rightarrow F_{Min} = \frac{n_{\sigma}}{\varepsilon} \sqrt{\frac{B}{A \cdot T \cdot \Delta E}}$$

to give an idea of the main dependencies of the limiting flux (sensitivity)

In the “real world”, the background is not only instrumental but also cosmic

S=source flux density [counts/m<sup>2</sup> s]

A=area of the detector

Ω=solid angle subtended by the beam of the telescope on the sky

B<sub>1</sub>=instrumental (particle) background [counts/s]

B<sub>2</sub>=cosmic background (XRB) [phot/m<sup>2</sup> s ster]

T=exposure time

**SOURCE**=S×A×T (photons related to the source)

**BACKGROUND**=B<sub>1</sub>×T + B<sub>2</sub>×A×Ω×T (photons related to the backgrounds)

$$N = \sqrt{(B_1 + B_2 A \Omega) \times T}$$

$$S/N = \frac{SAT}{\sqrt{(B_1 + B_2 A \Omega) \times T}} = \frac{SA^{1/2}T^{1/2}}{\sqrt{\left(\frac{B_1}{A}\right) + \Omega B_2}}$$

$$S/N = 5 \Rightarrow S_{\min} = 5 \sqrt{\frac{B_1 / A + \Omega B_2}{AT}}$$

# Focalizzazione vs collimazione

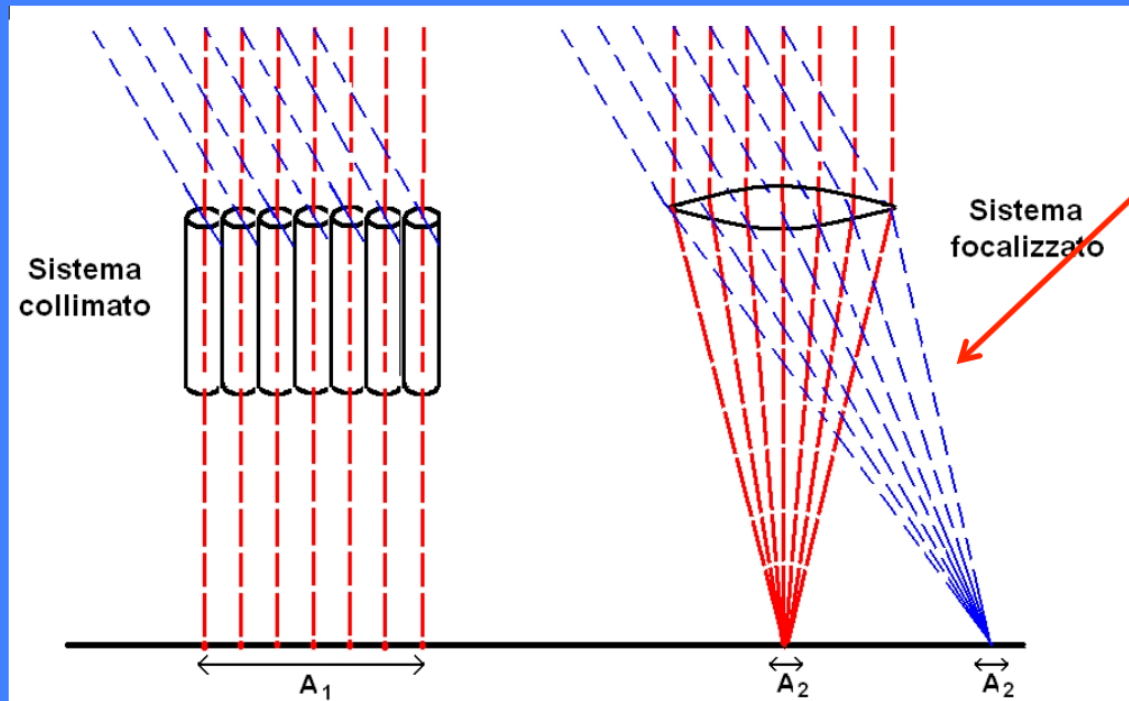

Proper  
imaging  
of X-rays  
below 20-40 keV

$A_d$  = PSF projected  
on the focal plane

$$F_{\min} \approx n_{\sigma} \frac{\sqrt{2B}}{\sqrt{A_{\text{det}} T_{\text{int}} \Delta E}}$$

$$F_{\min} \approx n_{\sigma} \frac{\sqrt{BA_d}}{A_{\text{eff}} \sqrt{T_{\text{int}} \Delta E}}$$

**Sistema collimato:** limita la regione di cielo da cui puo' provenire un segnale, (quindi limita il background), non incrementandone la "densita"

**Sistema focalizzato:** fa corrispondere ad ogni sorgente un punto nel piano focale, e "concentra" il segnale, producendo un'immagine