



UNIVERSITY SEMINARS 2014

HISTORY

1998
Foundation

2008
First Presence at
Embedded World

2013-14
In-House
Production

90

00

10

20

2004
First CPU
Module

2012
Widest ARM
Family

WHAT WE DO

DAVE deals with design, manufacturing and testing of embedded systems since 1998. Our products are used by customers in different markets such as automation, telecommunication, biomedical, computer vision, image/video processing etc.

What is an embedded system?

An embedded system is a computer system with a dedicated function within a larger mechanical or electrical system, often with real-time computing constraints. It is embedded as part of a complete device often including hardware and mechanical parts. By contrast, a general-purpose computer, such as a personal computer, is designed to be flexible and to meet a wide range of end-user needs. Embedded systems control many devices in common use today.



HEADQUARTER



Via Talponedo, 29/A
33080 Porcia (PN)
Italy



COMPANY ORGANIZATION / SUBSIDIARIES

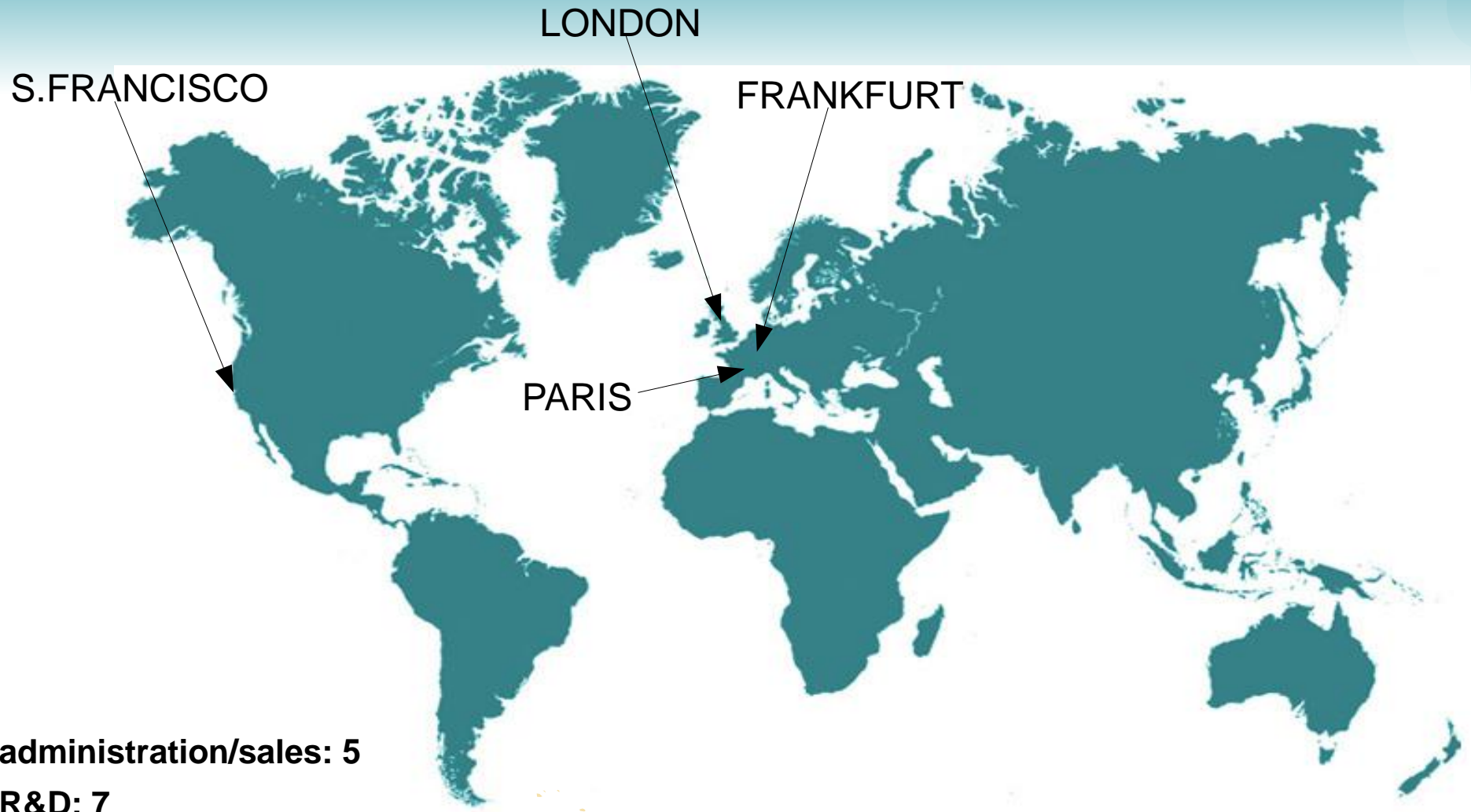

- **administration/sales: 5**
- **R&D: 7**
- **technical support: 3**
- **production: 8**

SUPPLY CHAIN AND PARTNERS

MANUFACTURERS

DISTRIBUTORS

TECHNICAL PARTNERS

**END CUSTOMERS
(B2B, B2C)**

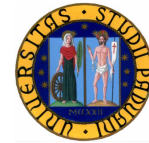

**CUSTOMERS
(B2B)**

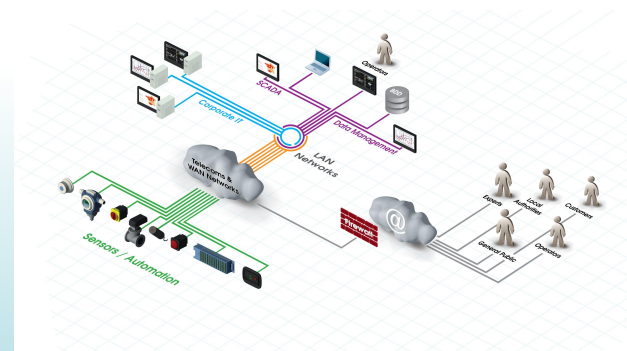
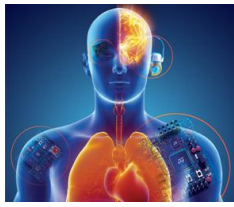

PRODUCTS / OVERVIEW

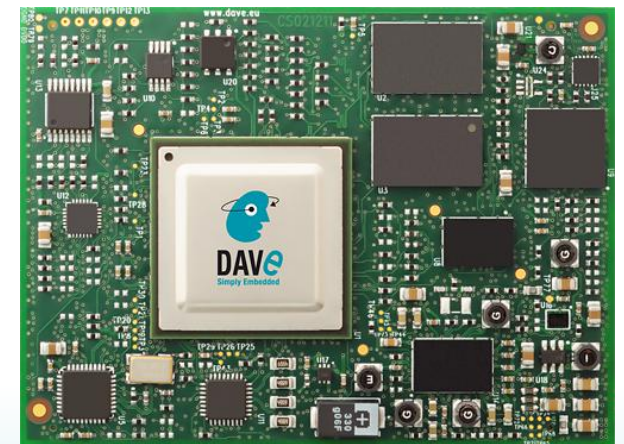
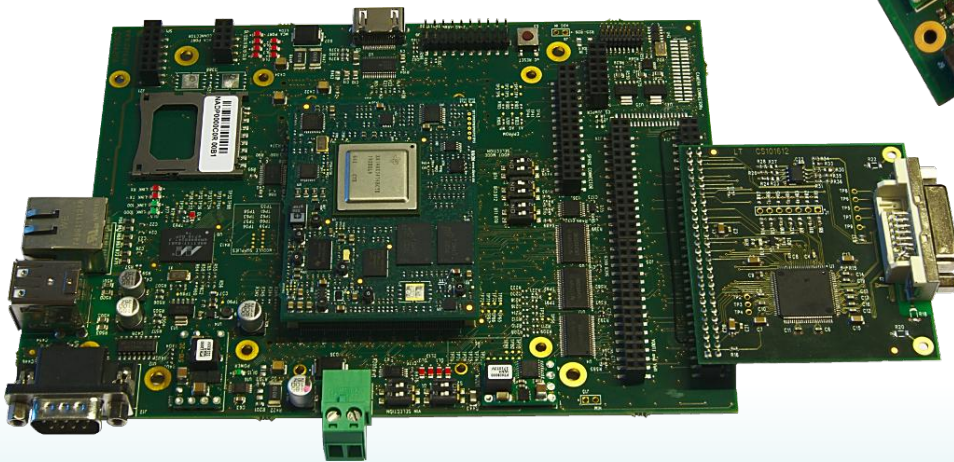
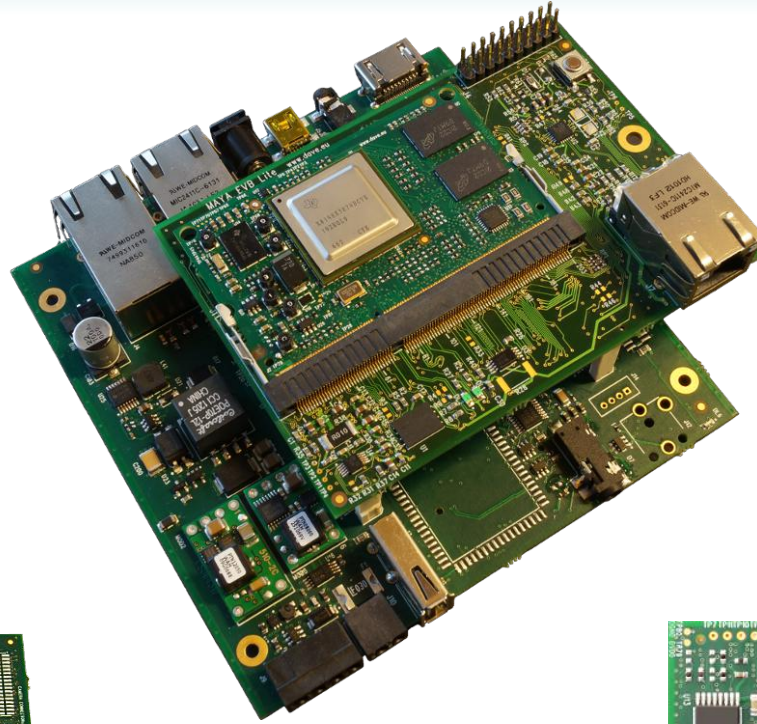
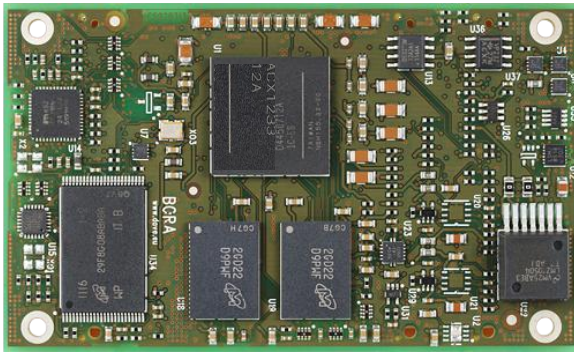

PRODUCTS / MAIN LINES

CPU Modules

Ultra

Esatta

Lite

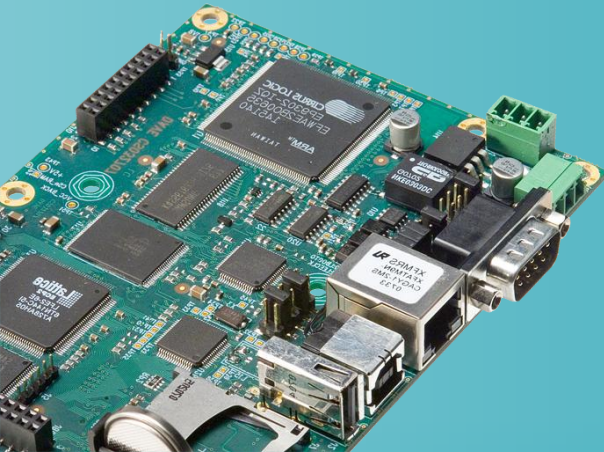
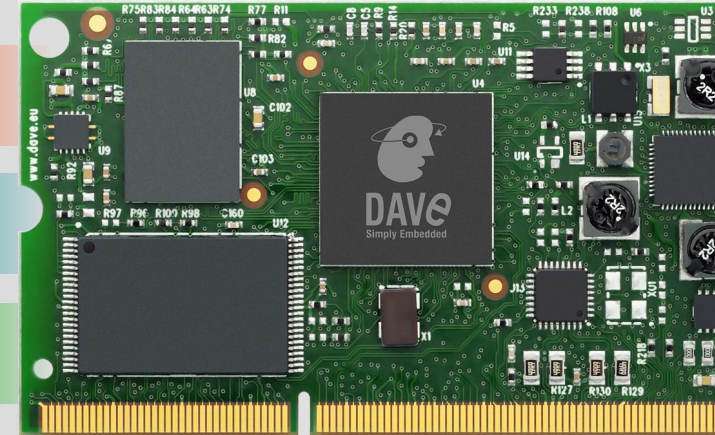

Turnkey Systems

CPU MODULES / POSITIONING

Ultra

T.o.P
PCIe
FPGA
100G Shock

Esatta

P2P Comp.
DSP
Video

50G Shock
Computation
Connections

Lite

Temperature

Reliability

Size

Quality

AXEL ULTRA

- Up to 4 Cortex-A9 cores @ 1.2GHz
- DDR3 RAM memory up to 4GB
- Wide range PSU input from 2.8V to 4.5V
- High mechanical retention up to 100G
- On-board precise 5ppm RTC
- Banks selectable power input
- PCIe and SATA

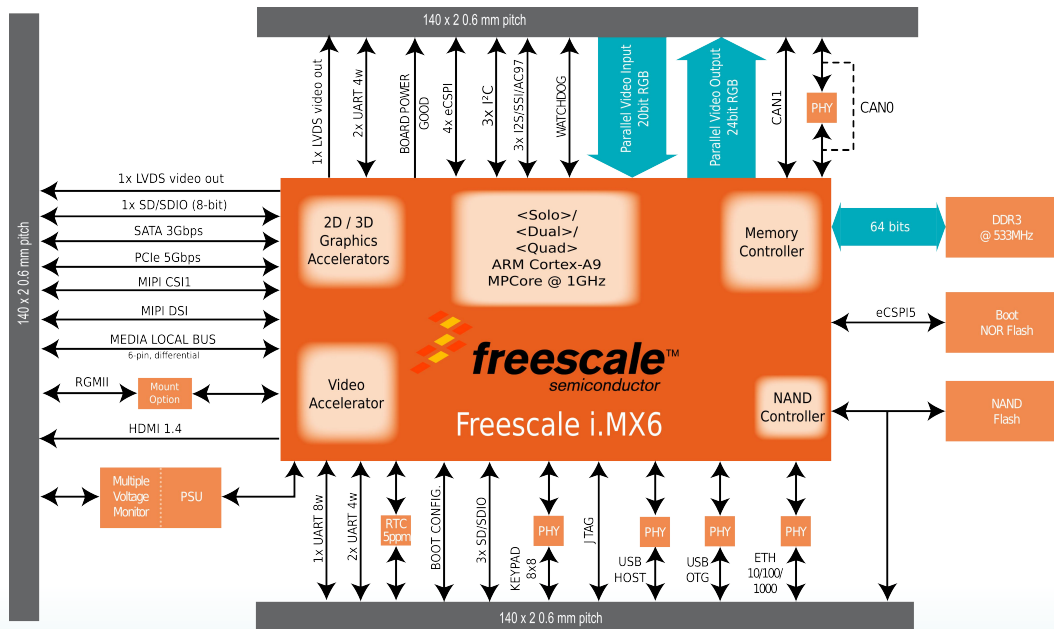

Top view

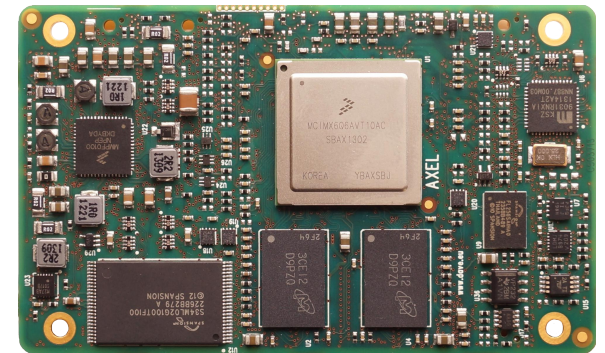

Bottom view

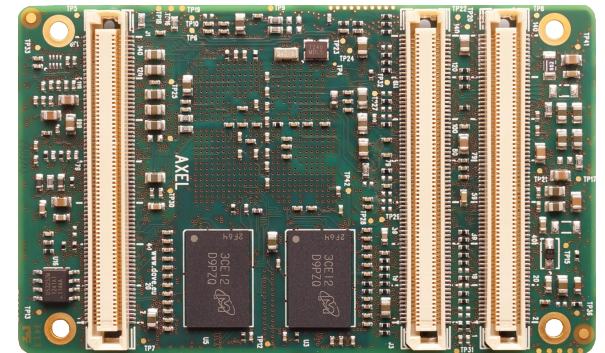

AXEL LITE - 1Q2014

- DDR3 RAM memory up to 2GB
- DDR3 SODIMM form factor 204pin
- PSU 3V3
- CSI MIPI
- CAN, USB, SDIO, I2C, SPI, Audio

Top view



Bottom view

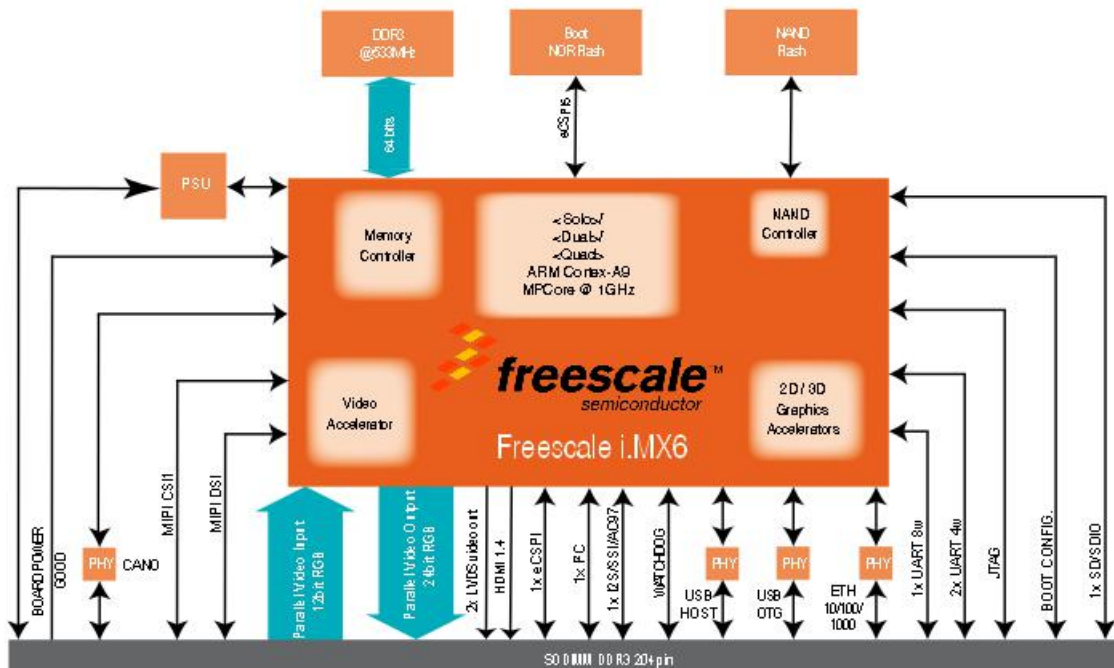
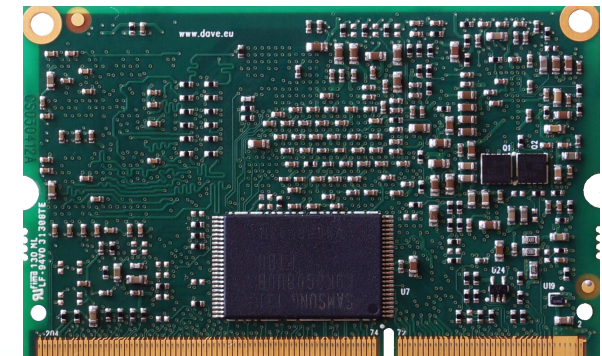

AXEL Evaluation Kit

Axel Embedded Linux Kit (XELK for short) provides:

- build the bootloader (U-Boot)
- build and run Linux operating system on Axel-based systems
- build Linux applications that will run on the target.

The main kit components are:

- hardware platform composed of
 - Axel system-on-module (SOM for short)
 - AxelEVB-Lite plugged on Dacu carrier board
 - 800x480 7" LVDS display
- Development virtual machine containing:
 - Toolchain
 - U-Boot bootloader sources
 - Linux kernel sources
 - Root file systems
- Technical documentation

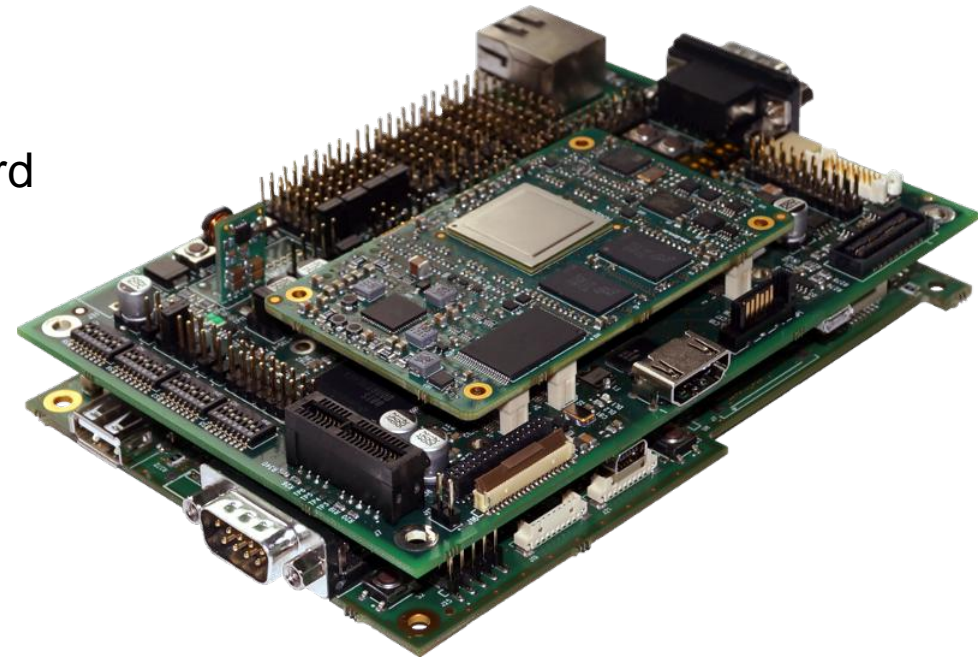

BORA – XC7Z010/XC7Z020

- Unmatched performance thanks to dual ARM Cortex-A9 @ 800MHz
- Enabling smarter system thanks to Artix-7 FPGA integrated on chip
- Highest security and reliability: voltage monitoring and power good enable
- Accurate timing application thanks to on-board 5ppm RTC

Top view



Bottom view

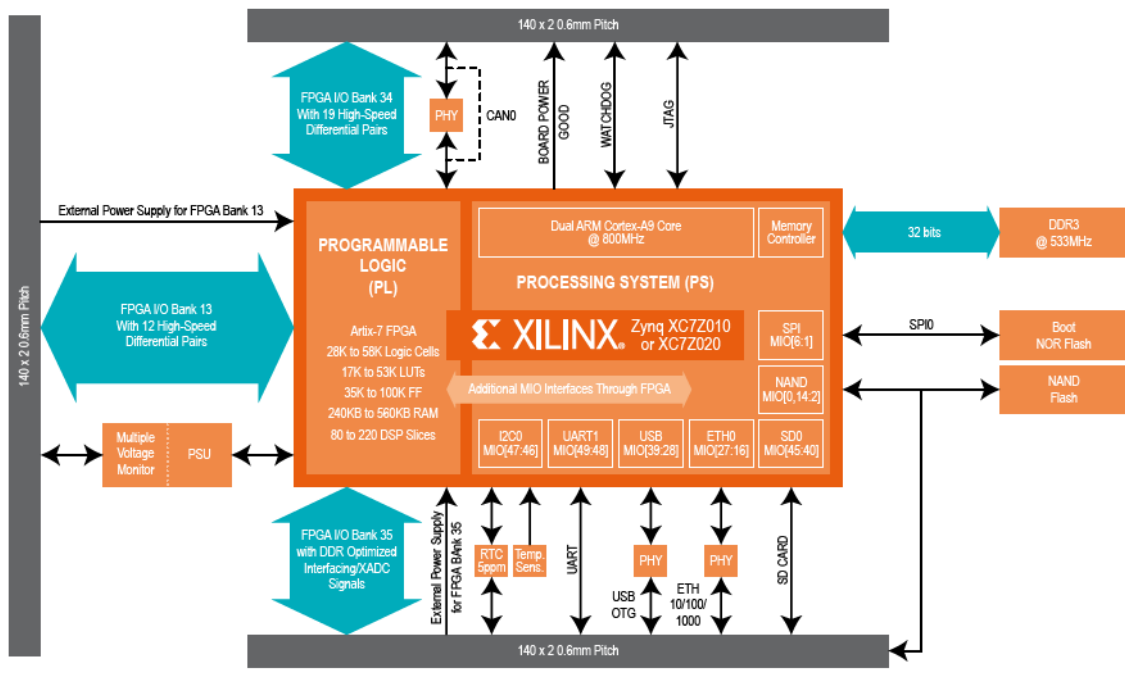
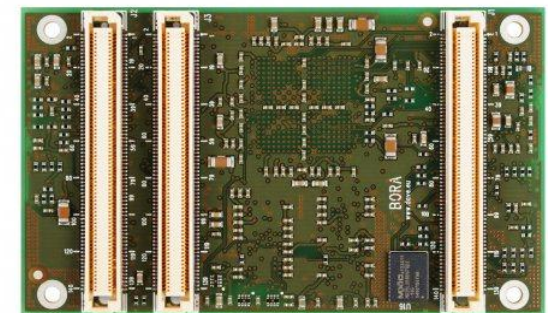

BORA – XC7Z010/XC7Z020

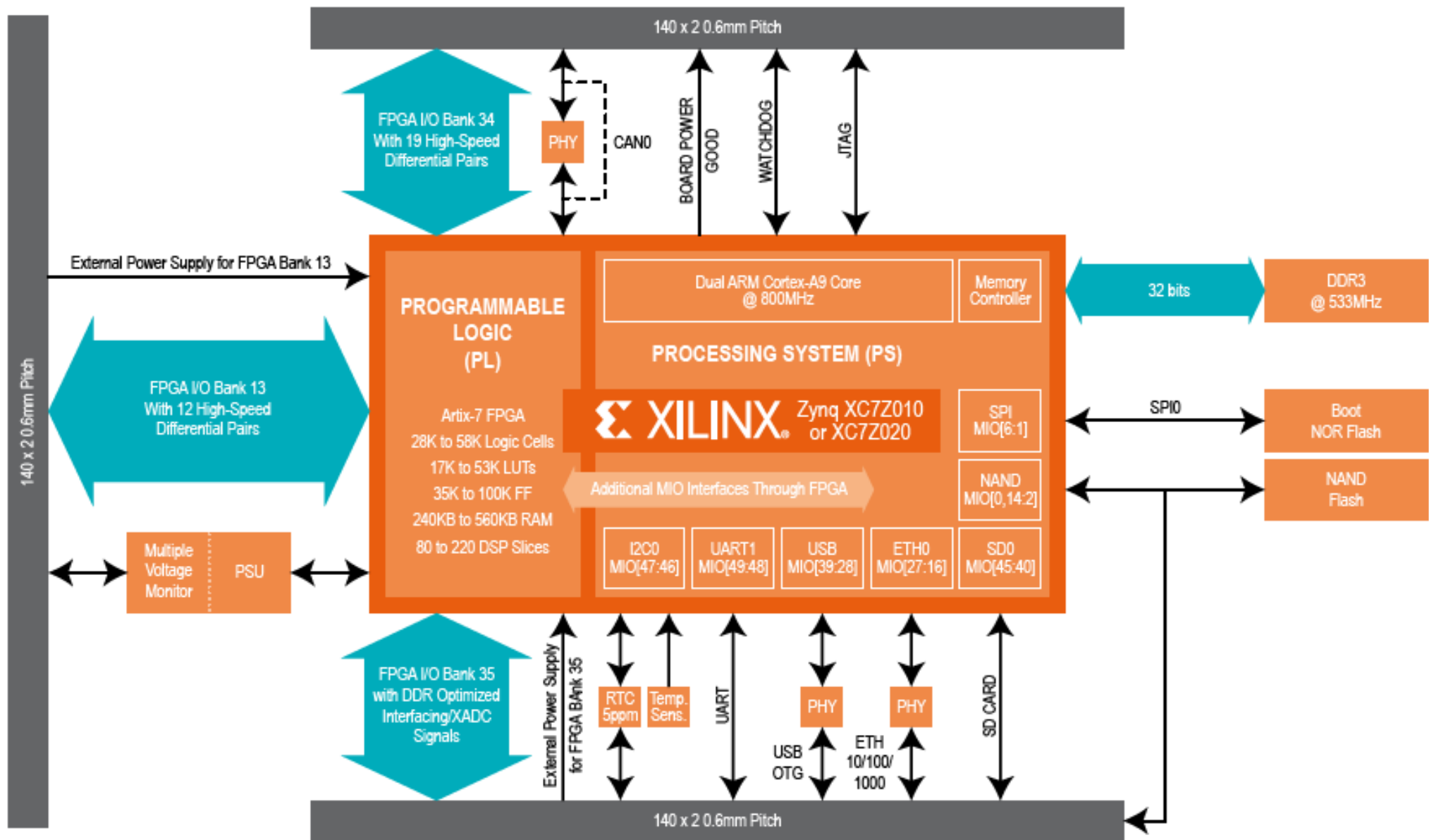

BORA – XC7Z010/XC7020

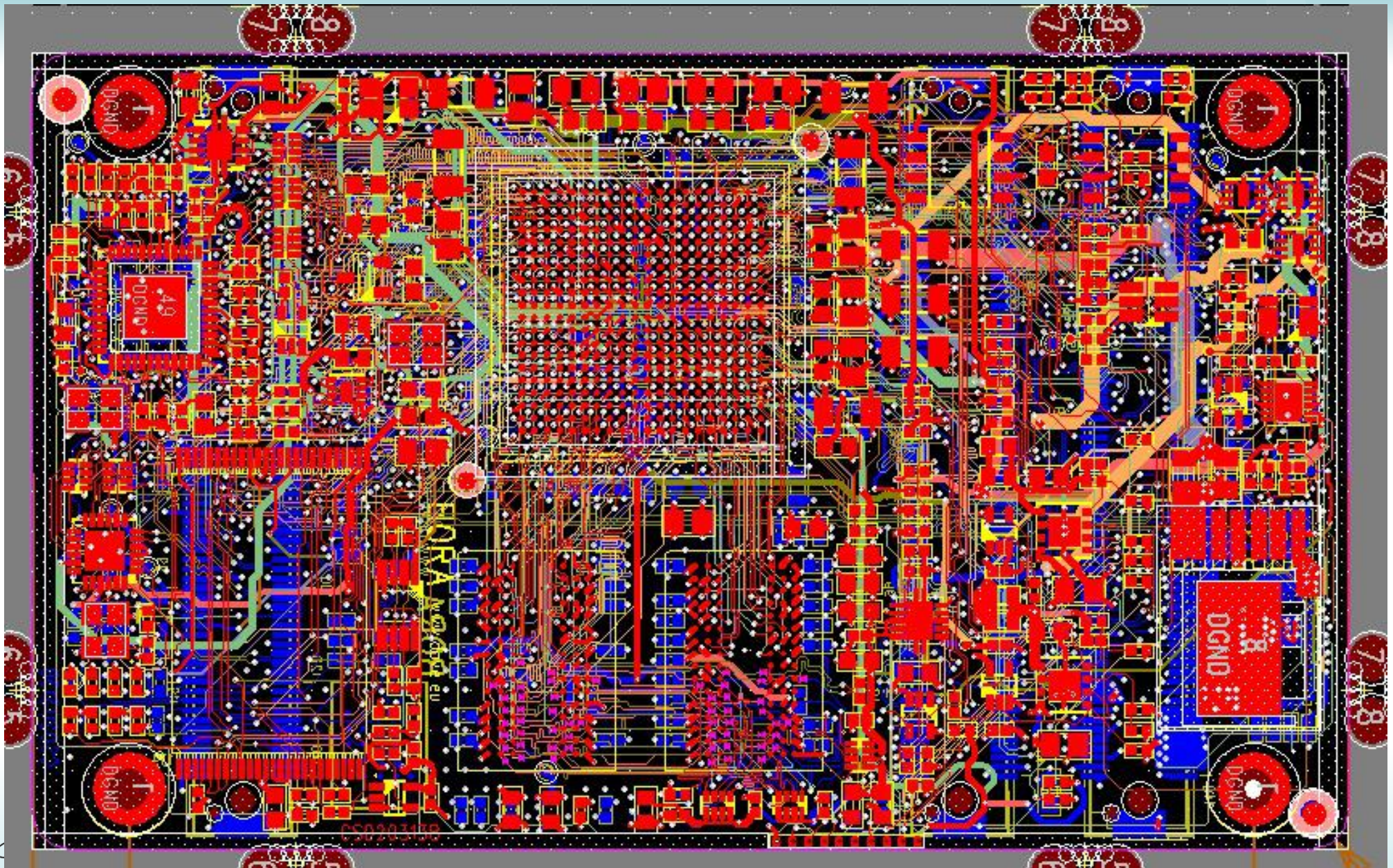

BORA Evaluation Kit

Bora Embedded Linux Kit provides all the necessary components required to set up the developing environment for:

- configuring the system (PS and PL) at hardware level
- build the first-stage bootloader (FSBL)building the second stage bootloader (U-Boot)
- building and running Linux operating system on Bora-based systems
- building Linux applications that will run on the target

The main kit components are:

- BORA SOM
- BORA-EVB-Lite Carrier board
- AC/DC Single Output Wall Mount adapter
Output: +12V -2.0 A
- MicroSDHC card with SD adapter and USB adapter

Vivado/SDK can be viewed as a collection of programs required to deal with all of the development aspects related to Xilinx components

(software running on ARM cores, FPGA fabric verification and programming, power estimation etc.). These include strictly FPGA-related tools such as Floorplanner and pure-software development tools such as SDK.

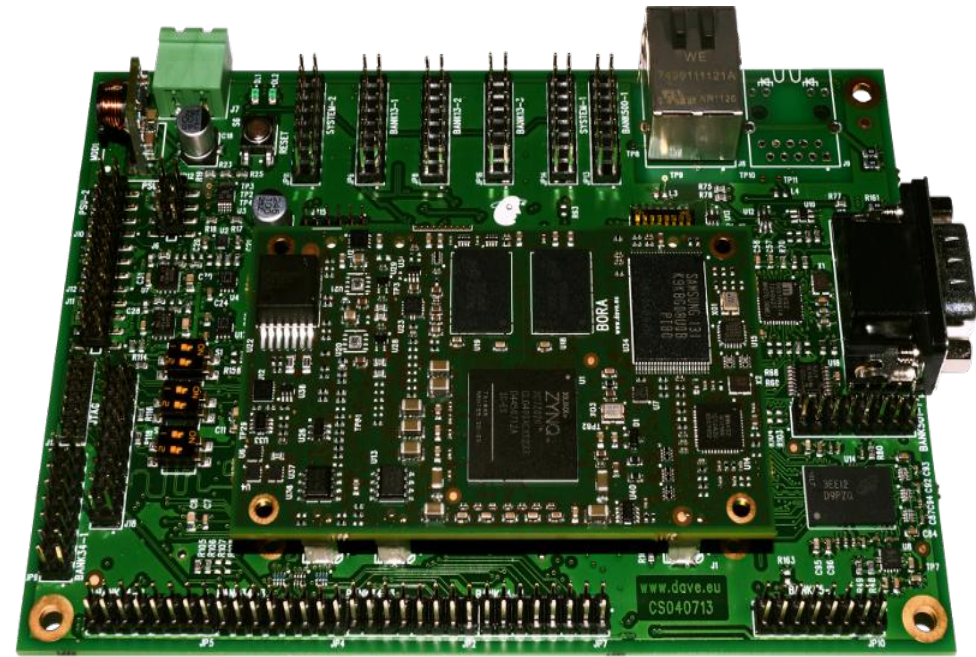

Board Support Package

BELK version			
Release number	1.0.0	1.1.0	2.0.0
Status	Released	Released	Scheduled
Release date	July 2013	November 2013	2Q2014
Release notes	Ver 1.0.0	Ver 1.1.0	-
SOM PCB version	CS020313A	CS020313A	CS020313B
Supported carrier boards			
U-Boot version	2013.04-belk-1.0.0	2013.04-belk-1.1.0	t.b.a.
Linux version	3.9.0-bora-1.0.0	3.9.0-bora-1.1.0	t.b.a.
Drivers	-	-	Gigabit Eth #0 UART NOR NAND SD/MMC USB Host/Device RTC CAN I2C

TURNKEY SYSTEMS /EXAMPLE 1

Remote Localization Unit

- Remote Vehicle and Safety Systems Localization & Monitoring Unit
- Neptune CPU Module
- Based on x86
- Carrier Board with Common Interfaces (USBs, Compact Flash, etc.)
- Two Boards for Monitoring Services (GPS, Accelerometer, Gyroscope) and Video Recording



TURNKEY SYSTEMS /EXAMPLE 2



Passenger counting system

- Low power ARM-based CPU solution
- Fanless CPU Core for 24/7 Operation
- -40 °C to +85 °C Applications
- SoC TI DM8148 1GHz
- 750 MHz floating-point integrated DSP
- Internal Solid State Disk, Up to 16GB
- real-time operation

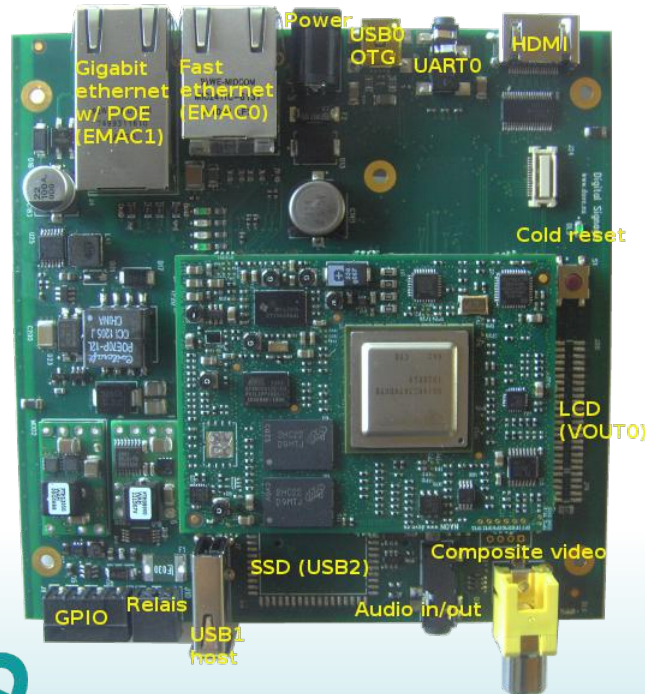

TURNKEY SYSTEMS /EXAMPLE 2



Application based on TI DaVinci
platform from DAVE

AVICS
Artificial Vision Counting System

Time	00:03
ENTRATI	USCITI
00	04

COLLABORAZIONI

Atenei ed enti di ricerca con cui collaboriamo:



- Università degli Studi di Udine
- Università degli Studi di Padova
- Università degli Studi di Trieste
- Università degli Studi di Ferrara
- Istituto IMAMOTER CNR di Ferrara
- Istituto Tecnico. S. T. "J.F. Kennedy" di Pordenone
- Associazione Cultura Informatica (AsCI) – Udine

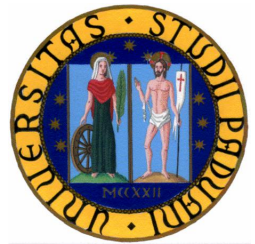

TESI DI LAUREA SPERIMENTALI (1/2)

- applicabili sia ai corsi triennali alle lauree quinquennali
- l'argomento trattato viene modulato in maniera opportuna, in accordo con lo studente, affinché il contenuto sia congruo con il percorso accademico del laureando
- possibilità da parte del laureando e del relatore di proporre delle variazioni
- previsto un periodo di presenza fisica presso i laboratori dell'azienda ma possibilità di svolgere parte del lavoro in remoto (<http://www.xilinx.com/support/university.html>)
- premio di laurea o rimborso spese per studenti non residenti nelle vicinanze della nostra sede
- efficace anche come strumento di preselezione del personale (al momento della stesura di questa presentazione – Aprile 2014 – oltre il 60% delle risorse del reparto di ricerca e sviluppo di DAVE è composto da personale che è stato inserito nell'organico immediatamente dopo aver svolto la tesi sperimentale)

TESI DI LAUREA SPERIMENTALI (2/2)

l'ingegneria dei sistemi embedded abbraccia numerose discipline
→ le tesi proposte hanno inevitabilmente un carattere fortemente interdisciplinare

- progettazione hardware (prevalentemente digitale ma anche analogica)
- signal integrity
- compatibilità elettromagnetica
- sviluppo firmware e device drivers
- sviluppo software di alto livello
- sviluppo FPGA
- sviluppo DSP
- sistemi operativi e RTOS (real-time operating system)

ESEMPIO DI TESI SVOLTA SU ARCHITETTURA ZYNQ

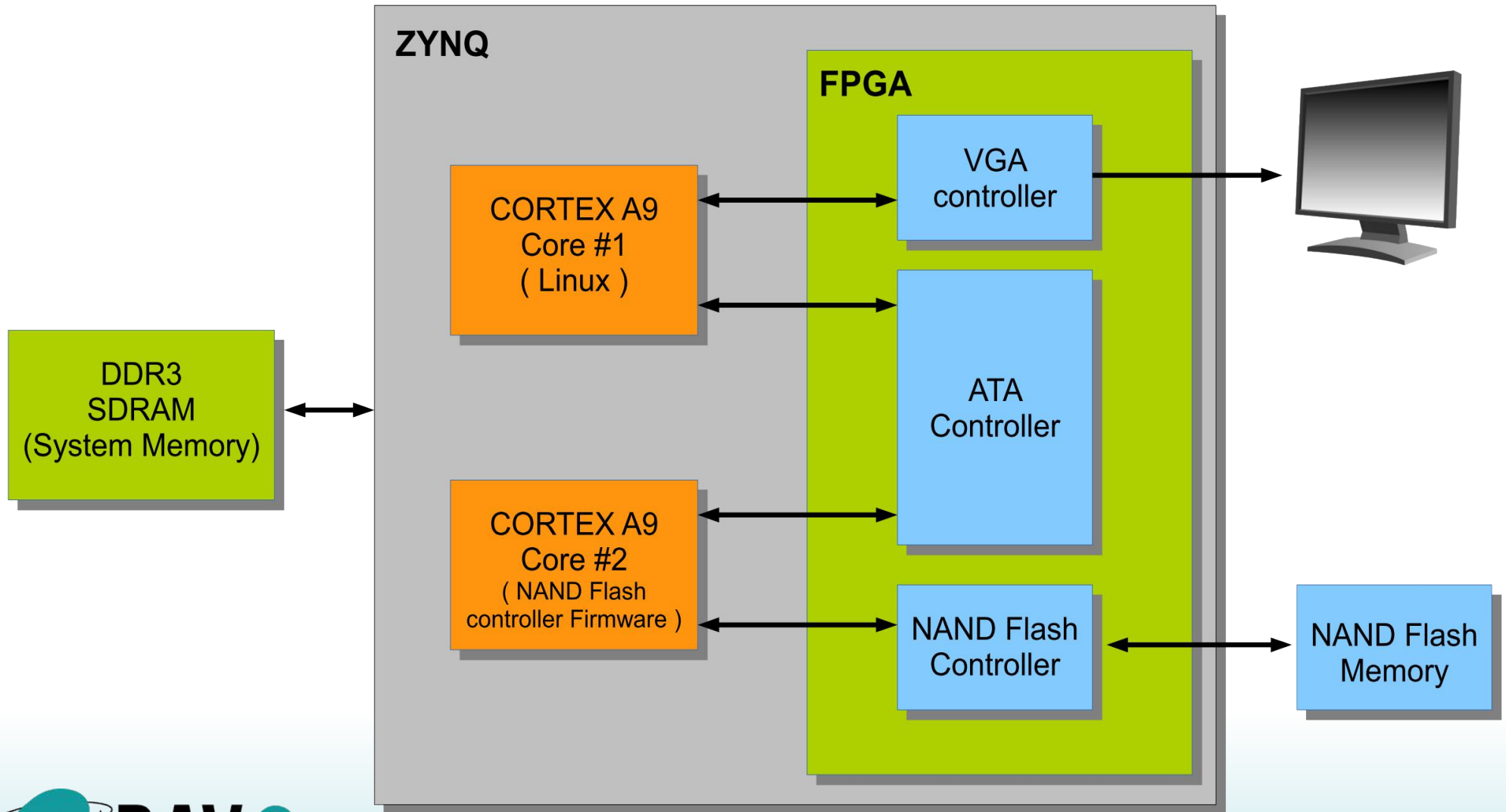

PROPOSTA INDICATIVA DI TESI #1 (LAUREA TRIENNALE)

Integrazione in Zynq di un controller grafico con accelerazione 2D

- Adattamento al bus AXI
- Adattamento a pannelli LCD con interfaccia LVDS

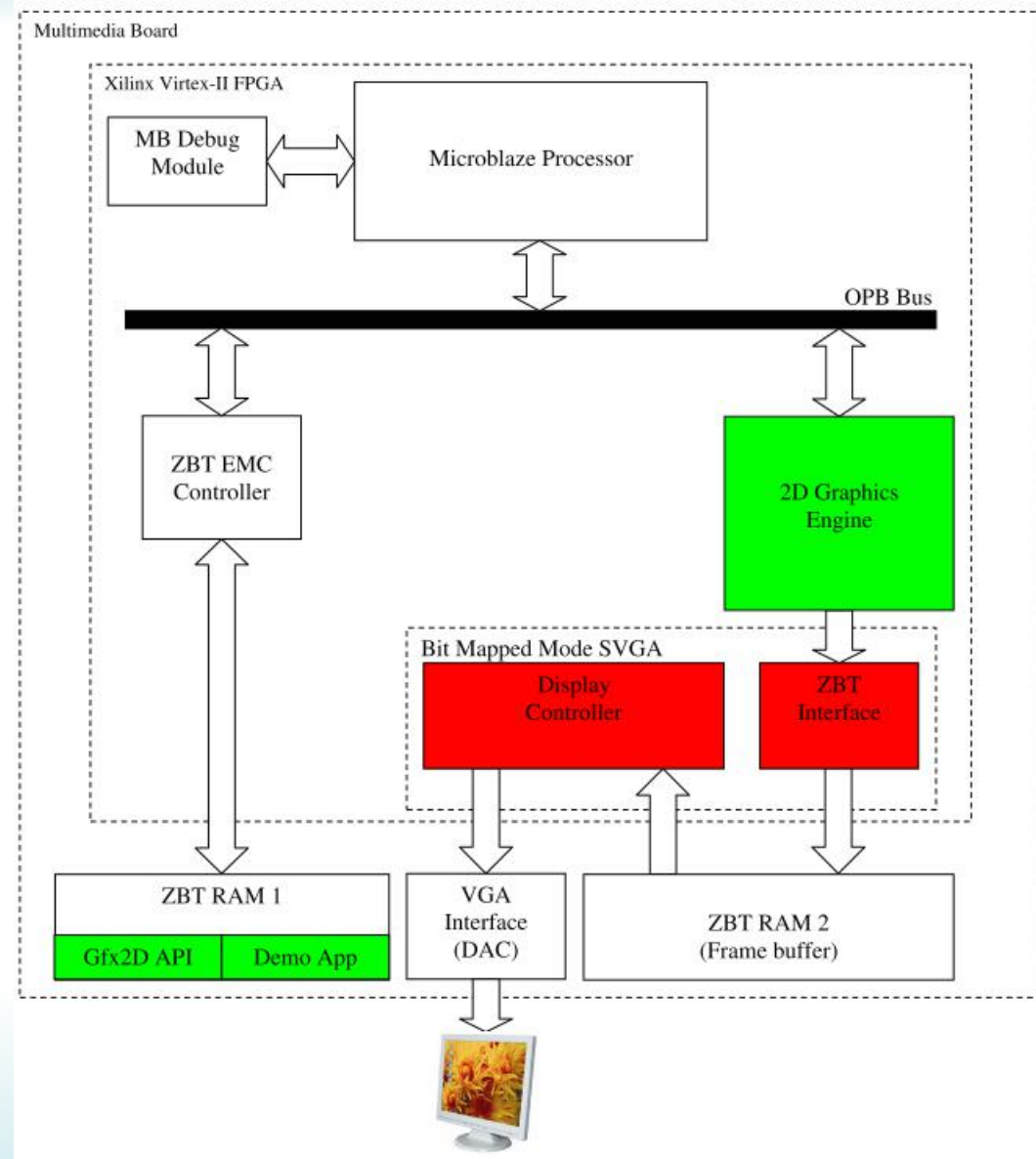

PROPOSTA INDICATIVA DI TESI #2 (LAUREA MAGISTRALE)

Caratterizzazione delle prestazioni real-time di un sistema AMP/Trustzone basato su architettura Zynq

- Porting del dual-OS monitor SafeG (www.toppers.jp/en/safeg.html)
- Asymmetric multi-processing (Linux + FreeRTOS)
- Implementazione in FPGA – potenzialmente mediante l'uso di strumenti HLS – di una periferica complessa controllata in real-time dal secondo core

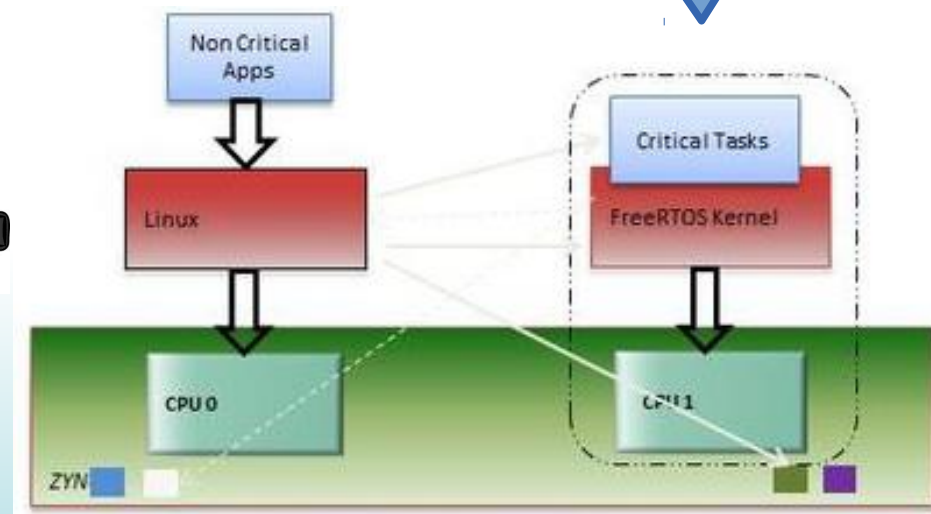
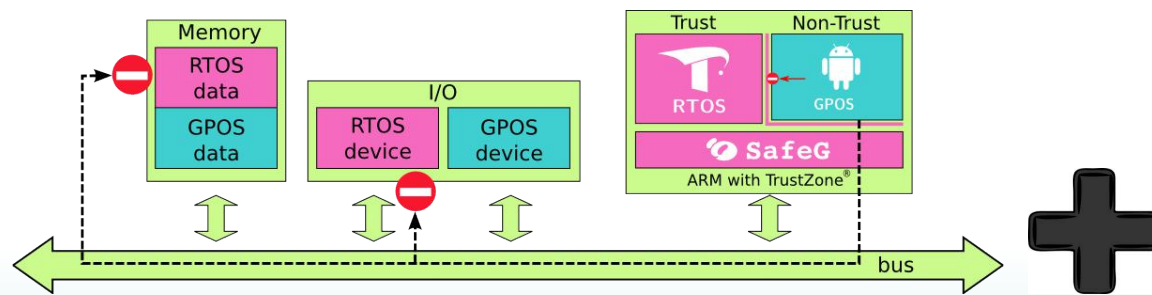
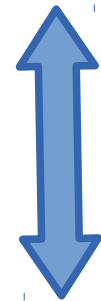

Q&A



DAVE S.r.l.

Via Talponedo, 29/A
I-33080, Porcia (PN) Italy

Tel +39 0434 921215
Fax +39 0434 1994030

www.dave.eu
info@dave.eu
wiki.dave.eu