

Corso di Laurea in Fisica - UNITS
**ISTITUZIONI DI FISICA
PER IL SISTEMA TERRA**

ELASTICITY

FABIO ROMANELLI

Department of Mathematics & Geosciences

University of Trieste

romanel@units.it

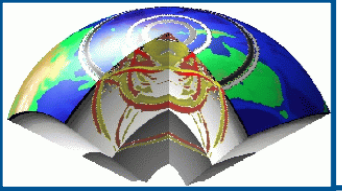

Elasticity and Seismic Waves

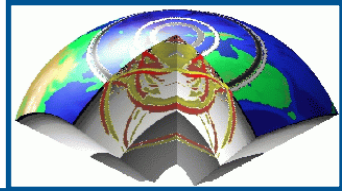

- Some mathematical basics
- Strain-displacement relation
 - Linear elasticity
 - Strain tensor – meaning of its elements
- Stress-strain relation (Hooke's Law)
 - Stress tensor
 - Symmetry
 - Elasticity tensor
 - Lame's parameters
- Equation of Motion
 - P and S waves
 - Plane wave solutions

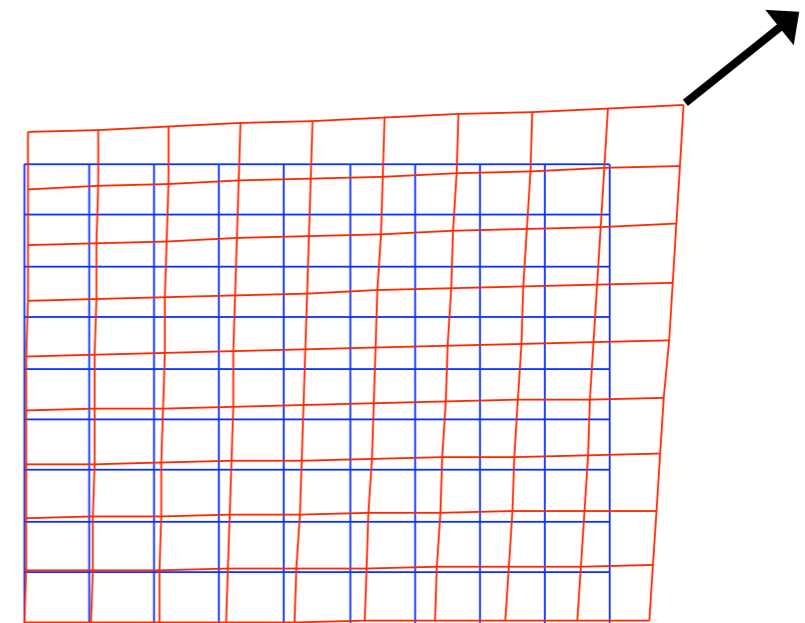



Some basic definitions - 1

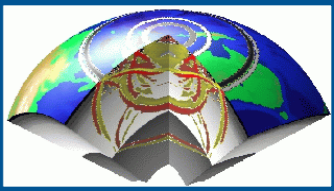

Principles of mechanics applied to bulk matter:

Mechanics of fluids Mechanics of solids

Continuum Mechanics

A material can be called **solid** (rather than -perfect- fluid) if it can support a **shearing force** over the time scale of some natural process.

Shearing forces are directed parallel, rather than perpendicular, to the material surface on which they act.

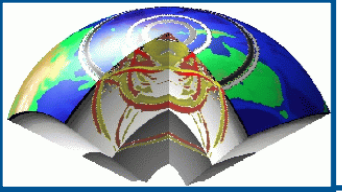

Some basic definitions - 2

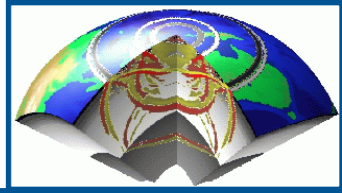

When a material is loaded at sufficiently low temperature, and/or short time scale, and with sufficiently limited stress magnitude, its deformation is fully recovered upon unloading:

the material is **elastic**

If there is a permanent (plastic) deformation due to exposition to large stresses:

the material is **elastic-plastic**

If there is a permanent deformation (viscous or creep), e.g. due to time exposure to a stress, and that increases with time:

the material is **viscoelastic** (with elastic response), or

the material is **visco-plastic** (with partial elastic response)

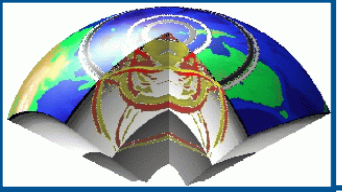

Stress-strain regimes

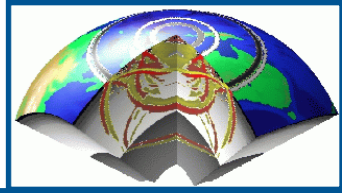

- Linear elasticity (teleseismic waves)
- rupture, breaking
- stable slip (aseismic)
- stick-slip (with sudden ruptures)

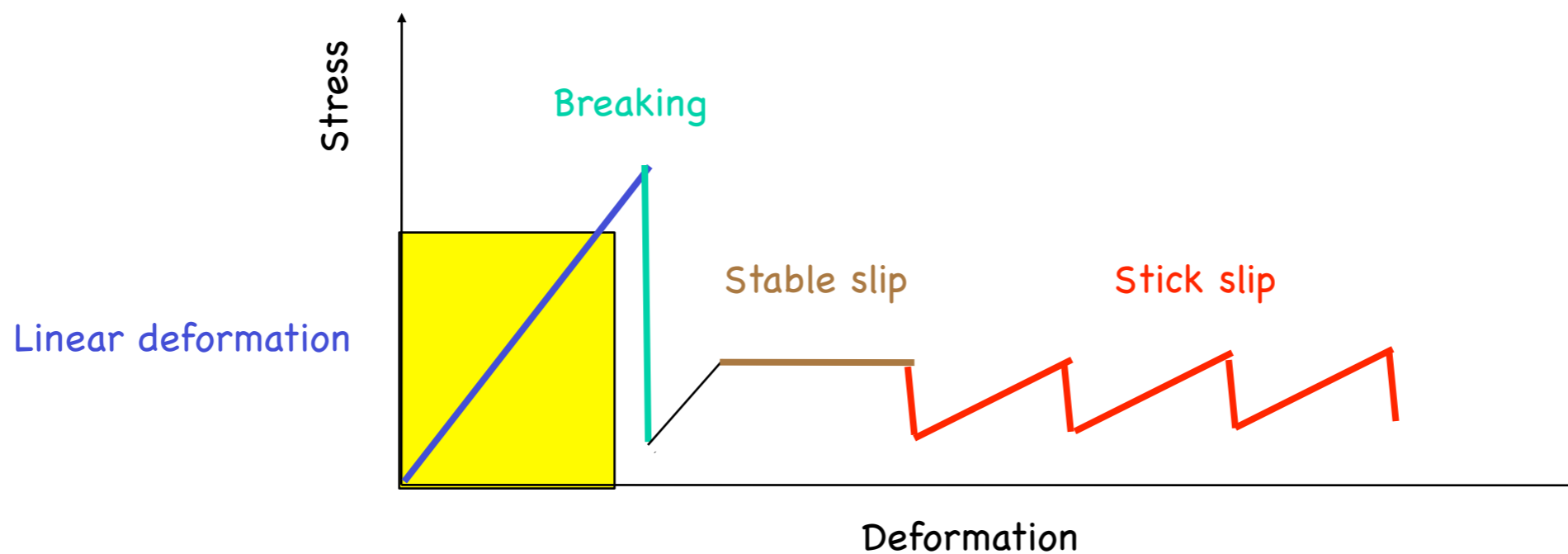

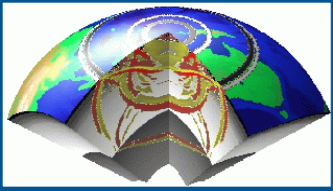

Elastic Deformation

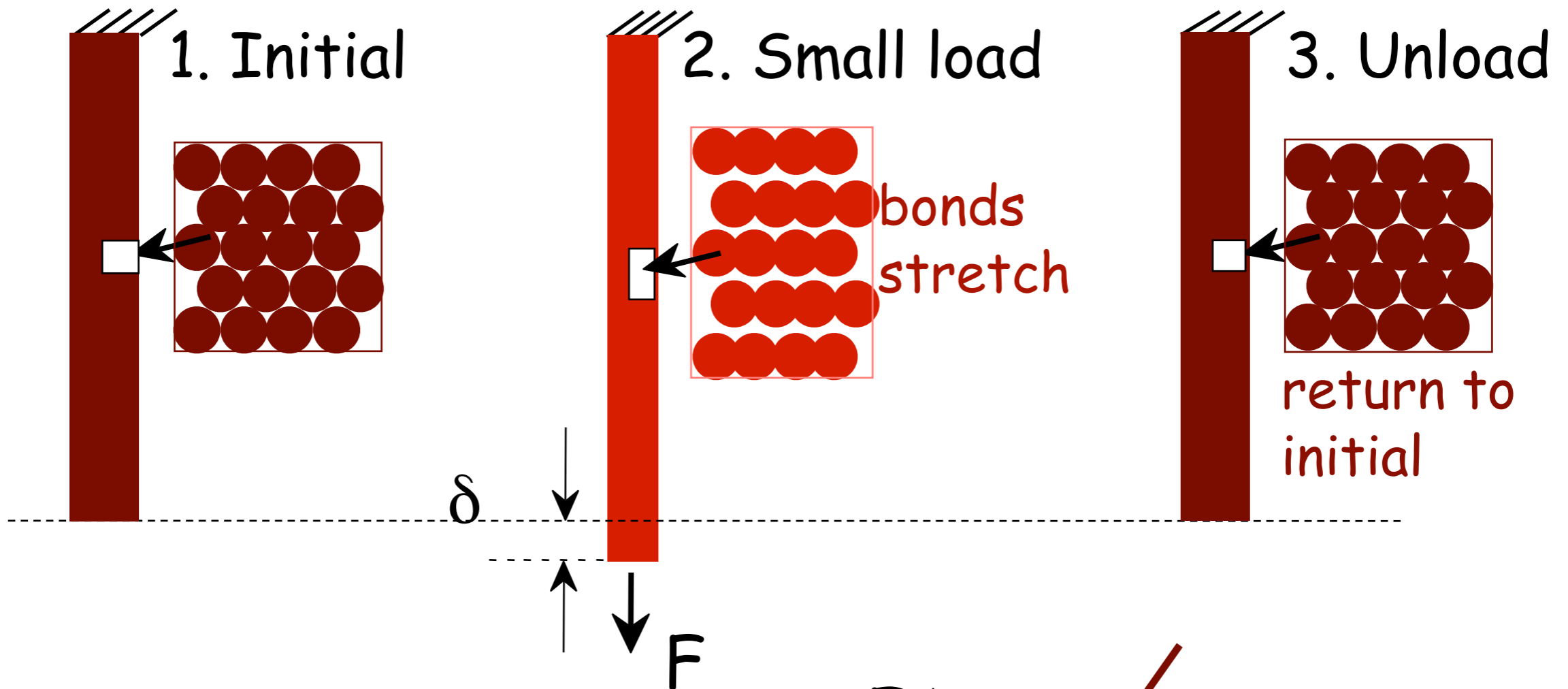
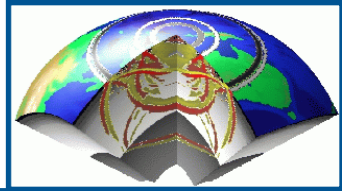

Elastic means reversible!
It goes back to its original state once the loading is removed.

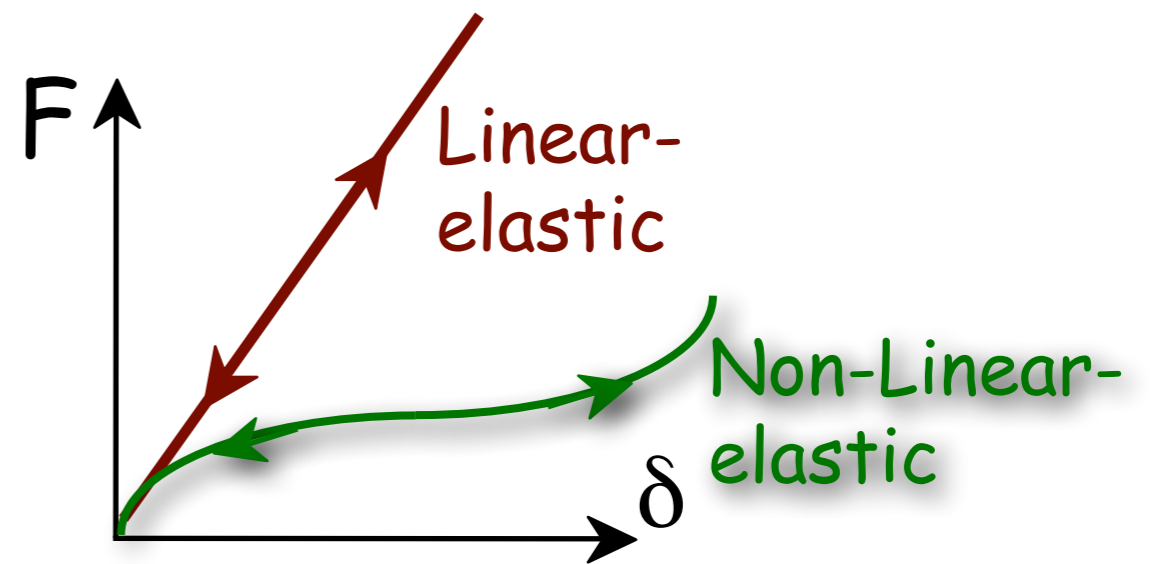

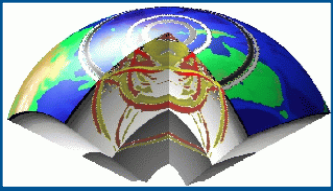

Stress as a measure of Force

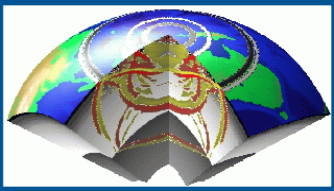

Stress is a measure of Force.

It is defined as the force per unit area ($=F/A$) (same units as pressure).

Normal stress acts perpendicular to the surface

(F =normal force)



Tensile causes elongation



Compressive causes shrinkage

$$\sigma = \frac{\text{stretching force}}{\text{cross sectional area}}$$

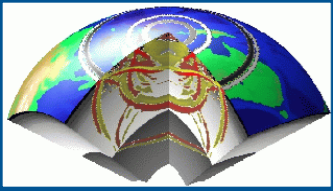

Shear Stress as a measure of Force

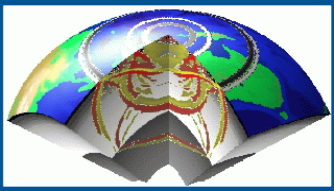

Shear stress acts tangentially to the surface (F =tangential force).

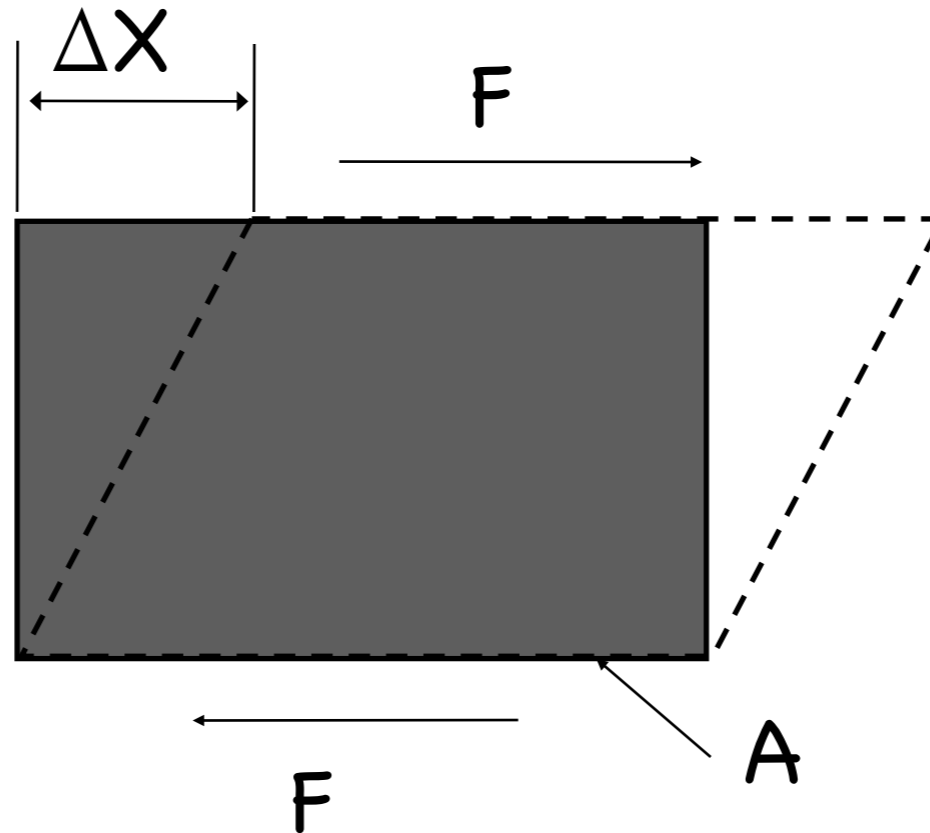

$$\tau = \frac{\text{shear force}}{\text{tangential area}}$$

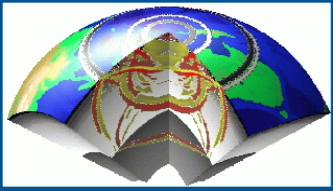

Linear Elastic Properties



Modulus of Elasticity, E :
(also known as Young's modulus)

• **Hooke's Law:**

$$\sigma = E \varepsilon$$

E : **stiffness** (material's resistance to elastic deformation)

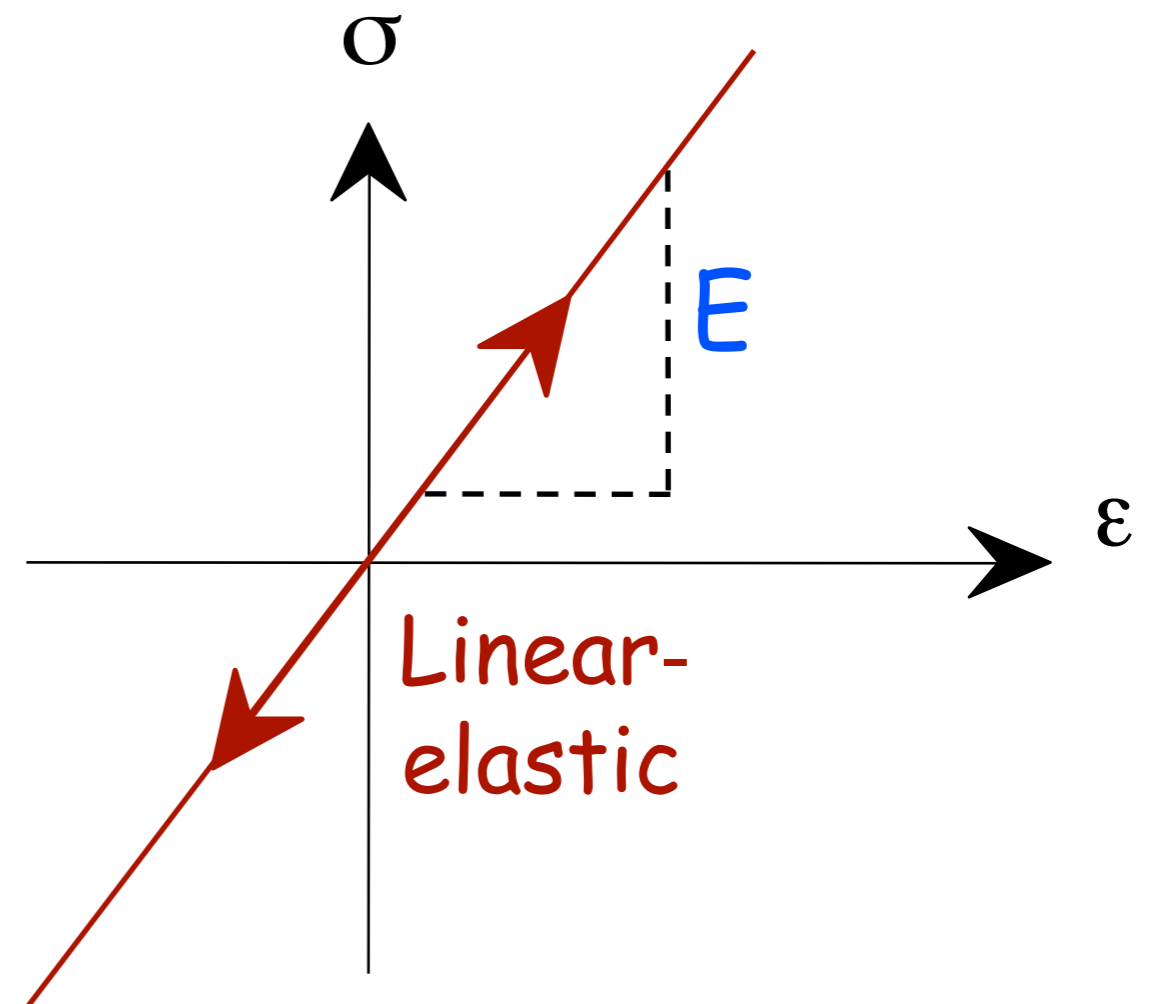
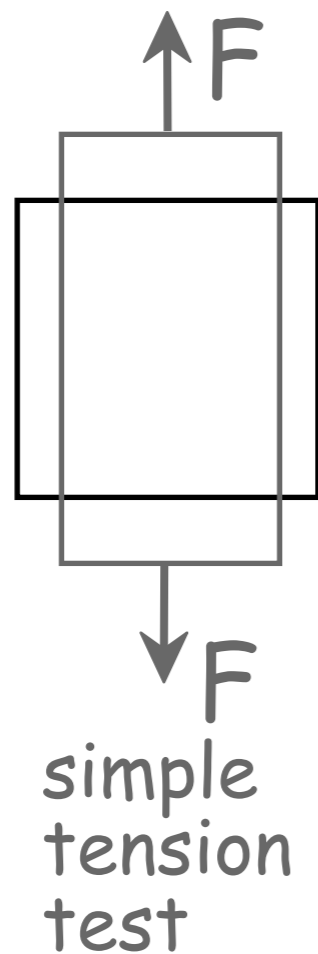

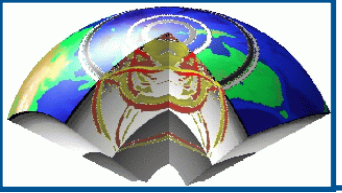

Young's modulus

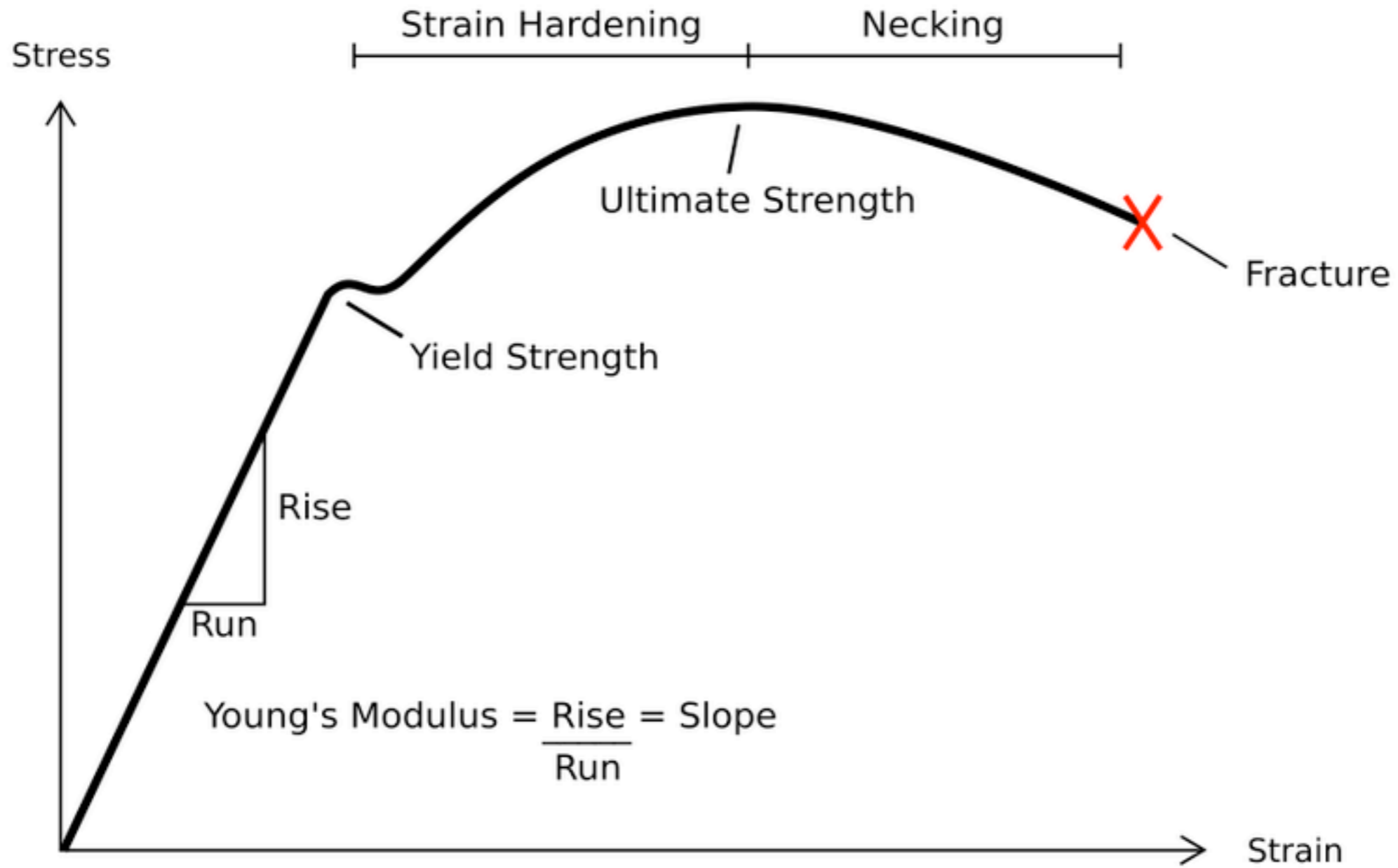
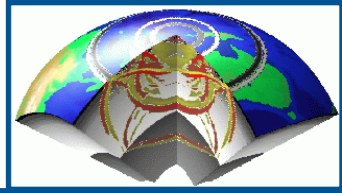

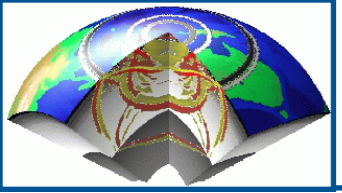

Elasticity Theory

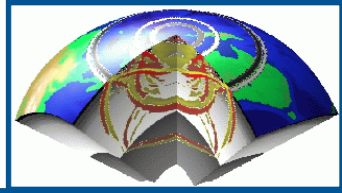

A time-dependent perturbation of an elastic medium (e.g. a rupture, an earthquake, a meteorite impact, a nuclear explosion etc.) generates elastic waves emanating from the source region. These disturbances produce local changes in **stress** and **strain**.

To understand the propagation of elastic waves we need to describe kinematically the **deformation** of our medium and the resulting forces (**stress**). The relation between **deformation** and **stress** is governed by **elastic constants**.

The time-dependence of these disturbances will lead us to the **elastic wave equation** as a consequence of conservation of energy and momentum.



Deformation

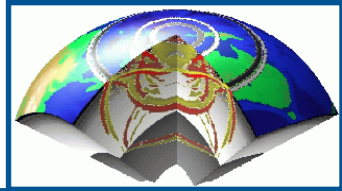

Let us consider a point P_0 at position r relative to some fixed origin and a second point Q_0 displaced from P_0 by δx

Unstrained state:

Relative position of point P_0 w.r.t. Q_0 is $\delta \mathbf{x}$.

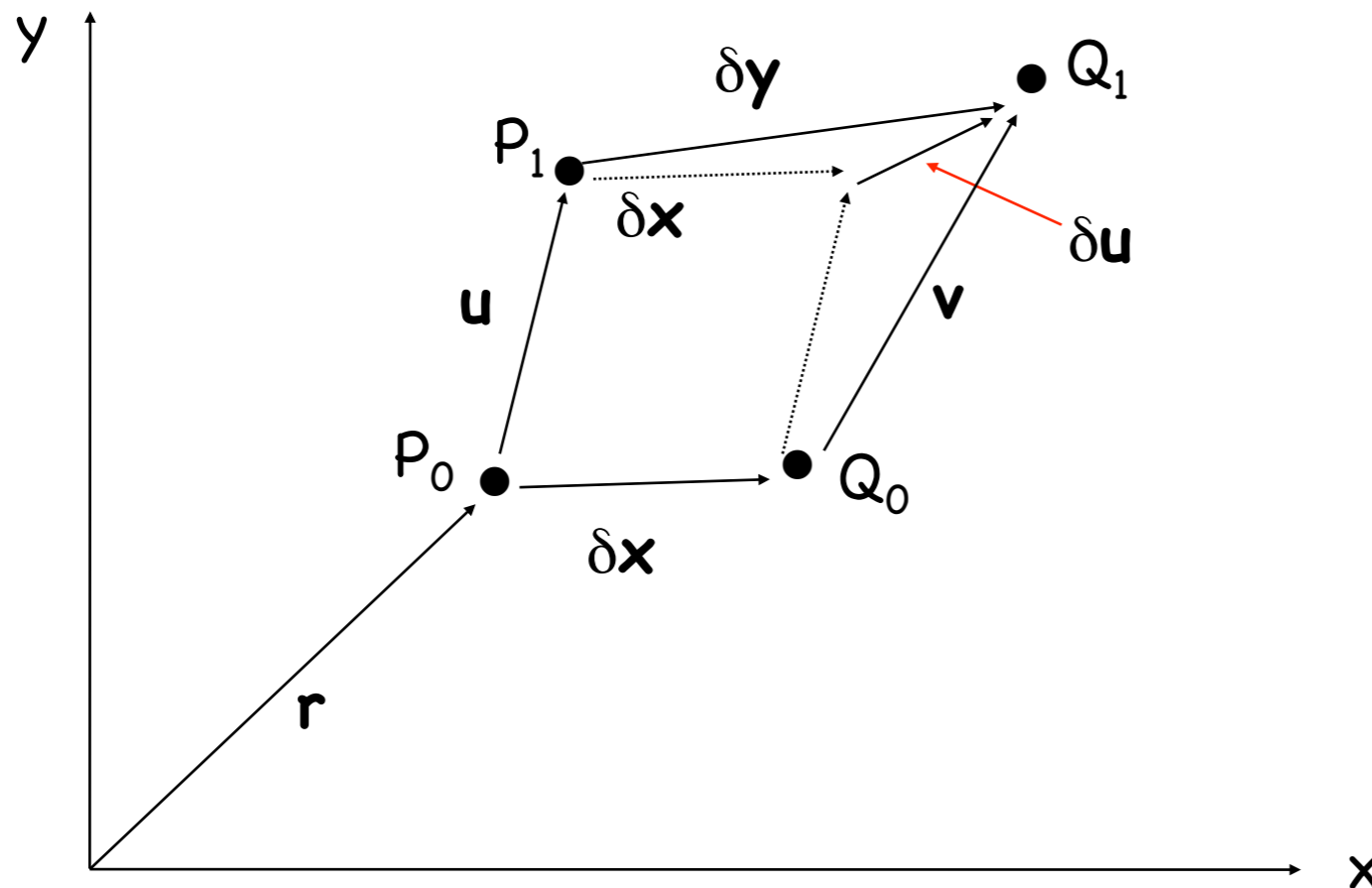

Strained state:

Relative position of point P_0 has been displaced a distance u to P_1 and point Q_0 a distance v to Q_1 .

Relative position of point P_1 w.r.t. Q_1 is $\delta \mathbf{y} = \delta \mathbf{x} + \delta \mathbf{u}$. The change in relative position between Q and P is just $\delta \mathbf{u}$.

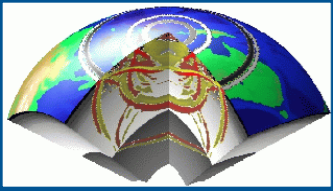

Linear Elasticity

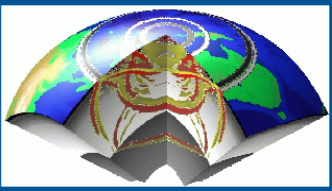

The relative displacement in the **unstrained** state is $\mathbf{u}(\mathbf{r})$. The relative displacement in the **strained** state is $\mathbf{v} = \mathbf{u}(\mathbf{r} + \delta\mathbf{x})$.

So finally we arrive at expressing the relative displacement due to strain:

$$\delta\mathbf{u} = \mathbf{u}(\mathbf{r} + \delta\mathbf{x}) - \mathbf{u}(\mathbf{r})$$

We now apply Taylor's theorem in 3-D to arrive at:

$$\delta u_i = \sum_{k=1,3} \frac{\partial u_i}{\partial x_k} \delta x_k \equiv \frac{\partial u_i}{\partial x_k} \delta x_k$$

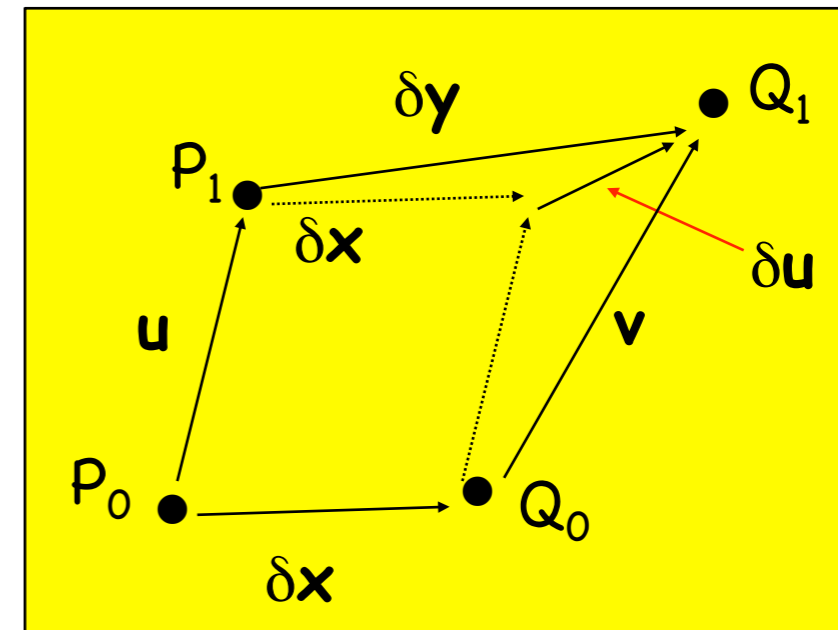

What does this equation mean?

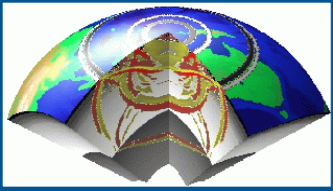

Linear Elasticity - symmetric part

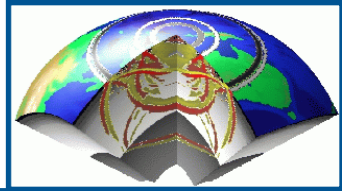

The partial derivatives of the vector components

$$\frac{\partial u_i}{\partial x_k}$$

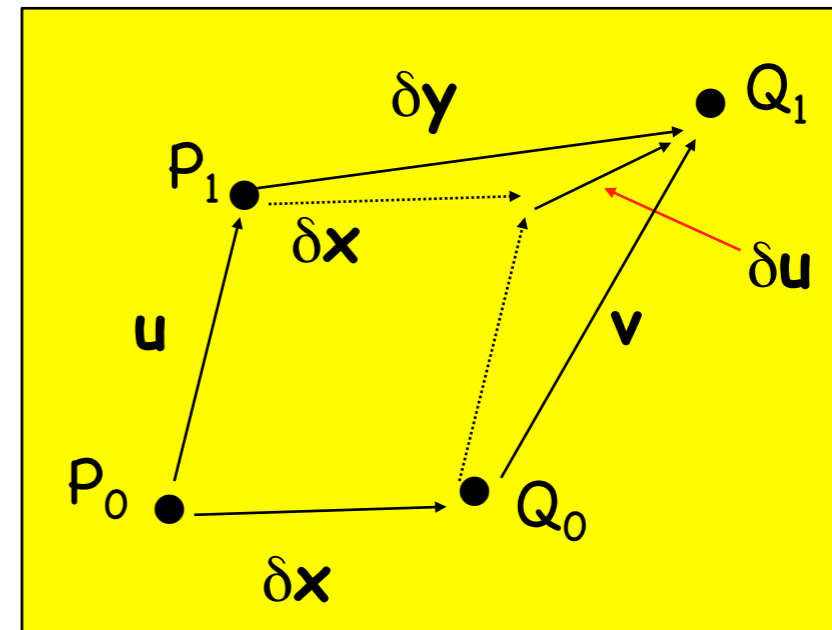

represent a **second-rank tensor** which can be resolved into a **symmetric** and anti-symmetric part:

$$\delta u_i = \frac{1}{2} \left(\frac{\partial u_i}{\partial x_k} + \frac{\partial u_k}{\partial x_i} \right) \delta x_k - \frac{1}{2} \left(\frac{\partial u_k}{\partial x_i} - \frac{\partial u_i}{\partial x_k} \right) \delta x_k$$

symmetric
strain

antisymmetric
pure rotation

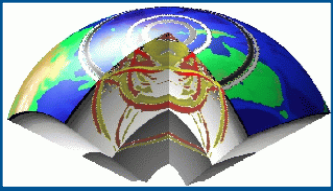

Linear Elasticity – strain tensor

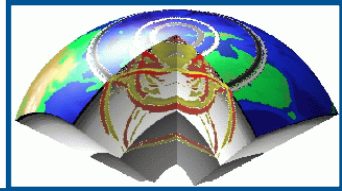

The symmetric part is called the
strain tensor

$$\varepsilon_{ij} = \frac{1}{2} \left(\frac{\partial u_i}{\partial x_j} + \frac{\partial u_j}{\partial x_i} \right)$$

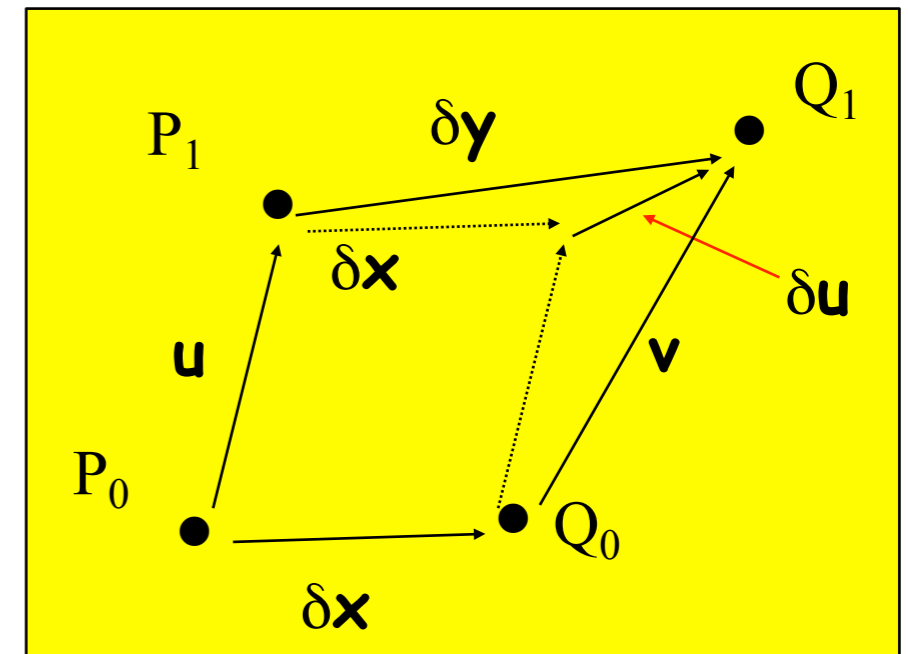

and describes the relation between strain and displacement in linear elasticity. In 2-D this tensor looks like:

$$\varepsilon_{ij} = \begin{bmatrix} \frac{\partial u_1}{\partial x} & \frac{1}{2} \left(\frac{\partial u_1}{\partial y} + \frac{\partial u_2}{\partial x} \right) \\ \frac{1}{2} \left(\frac{\partial u_1}{\partial y} + \frac{\partial u_2}{\partial x} \right) & \frac{\partial u_2}{\partial y} \end{bmatrix}$$

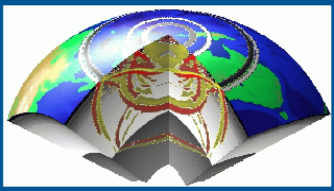
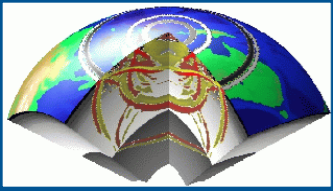
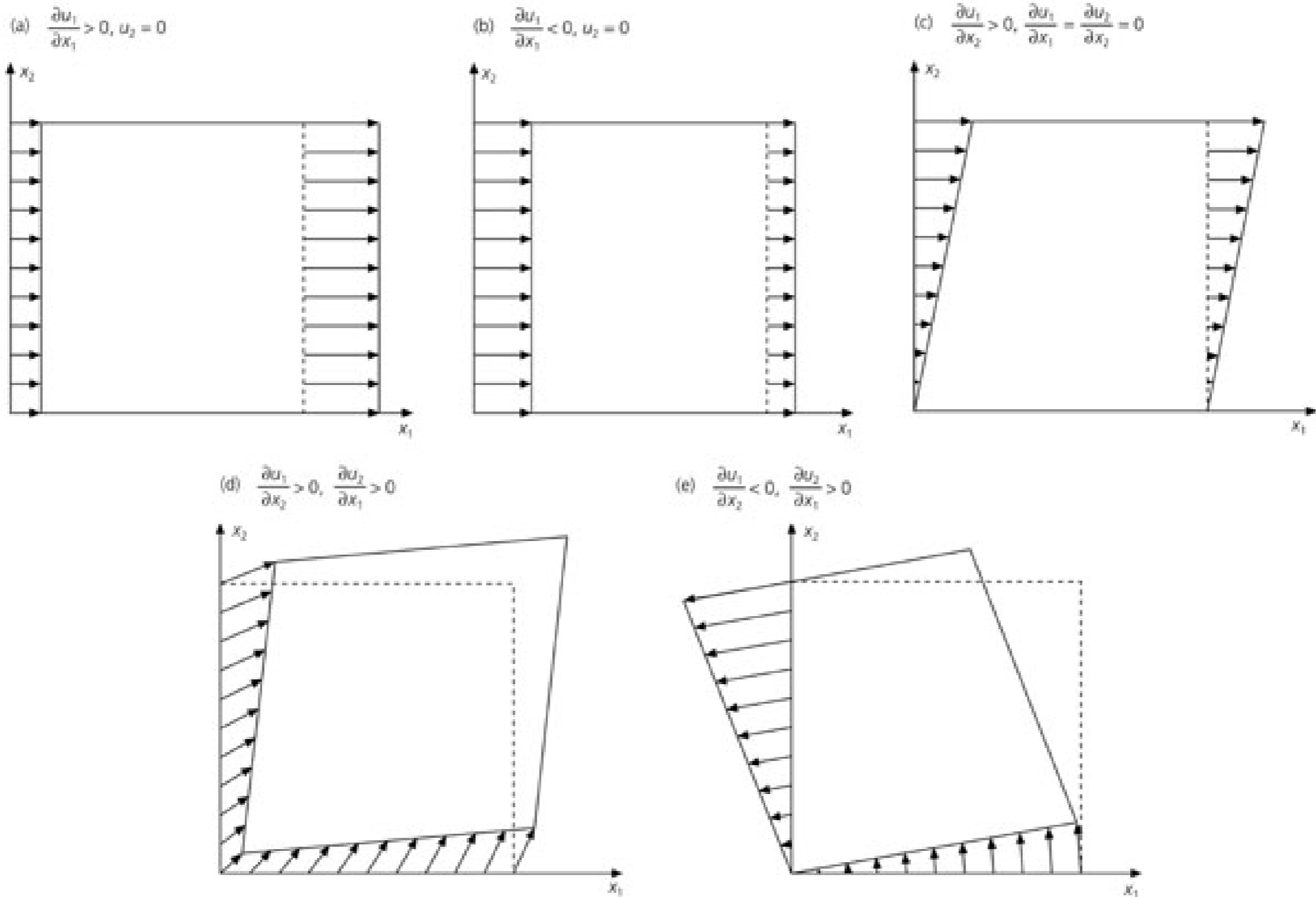
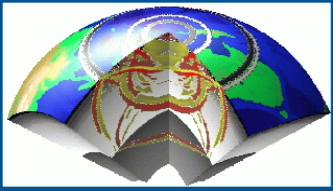

Figure 2.3-12: Some possible strains for a two-dimensional element.





Deformation tensor – its elements



Through eigenvector analysis the meaning of the elements of the deformation tensor can be clarified:

The strain tensor assigns each point – represented by its position vector \mathbf{u} – new position with vector $\mathbf{v}=\mathbf{u}+\delta\mathbf{u}$, where (summation over repeated indices applies):

$$\delta u_i = \varepsilon_{ij} \delta x_j$$

The eigenvectors of the deformation tensor are those for which the tensor is diagonal, and the eigenvalues λ :

$$\delta u_i = \lambda \delta x_i$$

and can be obtained solving the system:

$$\left| \varepsilon_{ij} - \lambda \delta_{ij} \right| = 0$$



Deformation tensor – its elements

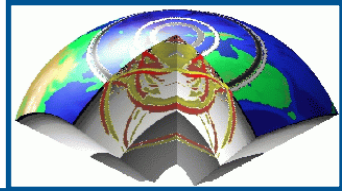

Thus

$$v_i = u_i(1 + \lambda_i)$$

... in other words ...

the eigenvalues express the relative change of length along the three coordinate axes, or the elongation respect to a unitary length

$$\lambda_i = \frac{v_i}{u_i} - 1$$

shear angle

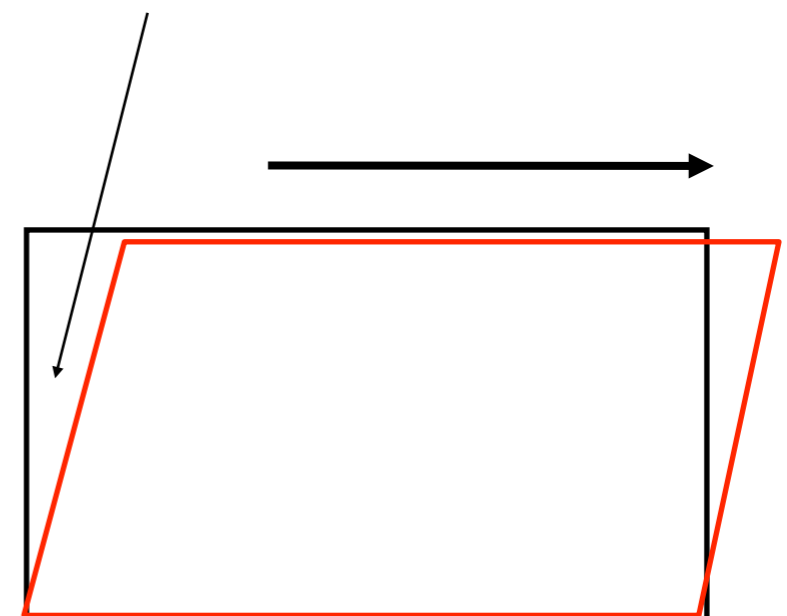

In arbitrary coordinates the **diagonal** elements are the **relative change of length along the coordinate axes** and the **off-diagonal** elements are the **infinitesimal shear angles**.



Deformation tensor – trace

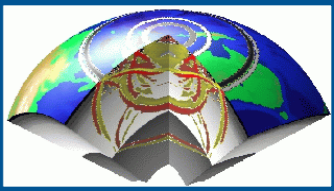

The trace of a tensor is defined as the sum over the diagonal elements.

Thus:

$$\varepsilon_{ii} = \varepsilon_{11} + \varepsilon_{22} + \varepsilon_{33}$$

This trace is linked to the volumetric change after deformation. Before deformation the volume was V_0 . Because the diagonal elements are the relative change of lengths along each direction, the new volume after deformation is

$$V = L_1(1 + \varepsilon_{11})L_2(1 + \varepsilon_{22})L_3(1 + \varepsilon_{33})$$

... and neglecting higher-order terms ...

$$V = L_1L_2L_3(1 + \varepsilon_{ii}) \text{ or } V_0(1 + \varepsilon_{ii})$$

$$\theta = \frac{\Delta V}{V_0} = \varepsilon_{ii} = \frac{\partial u_i}{\partial x_i} = \frac{\partial u_1}{\partial x_1} + \frac{\partial u_2}{\partial x_2} + \frac{\partial u_3}{\partial x_3} = \text{div} \mathbf{u} = \nabla \cdot \mathbf{u}$$



Deformation tensor – applications

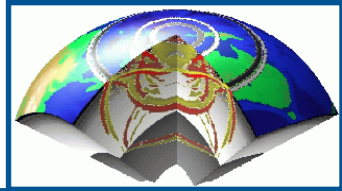

The fact that we have linearised the strain–displacement relation is quite severe. It means that the elements of the strain tensor should be $\ll 1$. Is this the case in seismology?

Let's consider an example. The 1999 Taiwan earthquake ($M=7.6$) was recorded at a teleseismic distance and the maximum ground displacement was 1.5 mm measured for surface waves of approx. 30s period. Let us assume a phase velocity of 4km/s. **How big is the strain at the Earth's surface, give an estimate !**

The answer is that ε would be on the order of $10^{-7} \ll 1$. This is typical for global seismology if we are far away from the source, so that the assumption of infinitesimal displacements is acceptable.

For displacements closer to the source this assumption is not valid. There we need a **finite strain theory**. Strong motion seismology is an own field in seismology concentrating on effects close to the seismic source.

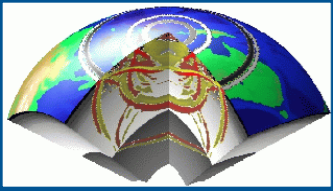

Stress - Traction (vector)

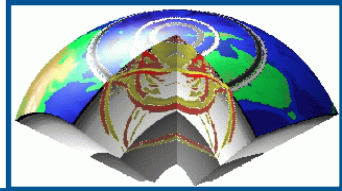

In an elastic body there are restoring forces if deformation takes place. These forces can be seen as acting on planes inside the body. **Forces divided by an areas are called stresses.**

In order for the deformed body to remain deformed these forces have to compensate each other.

Figure 2.3-1: Surface force on a volume element.

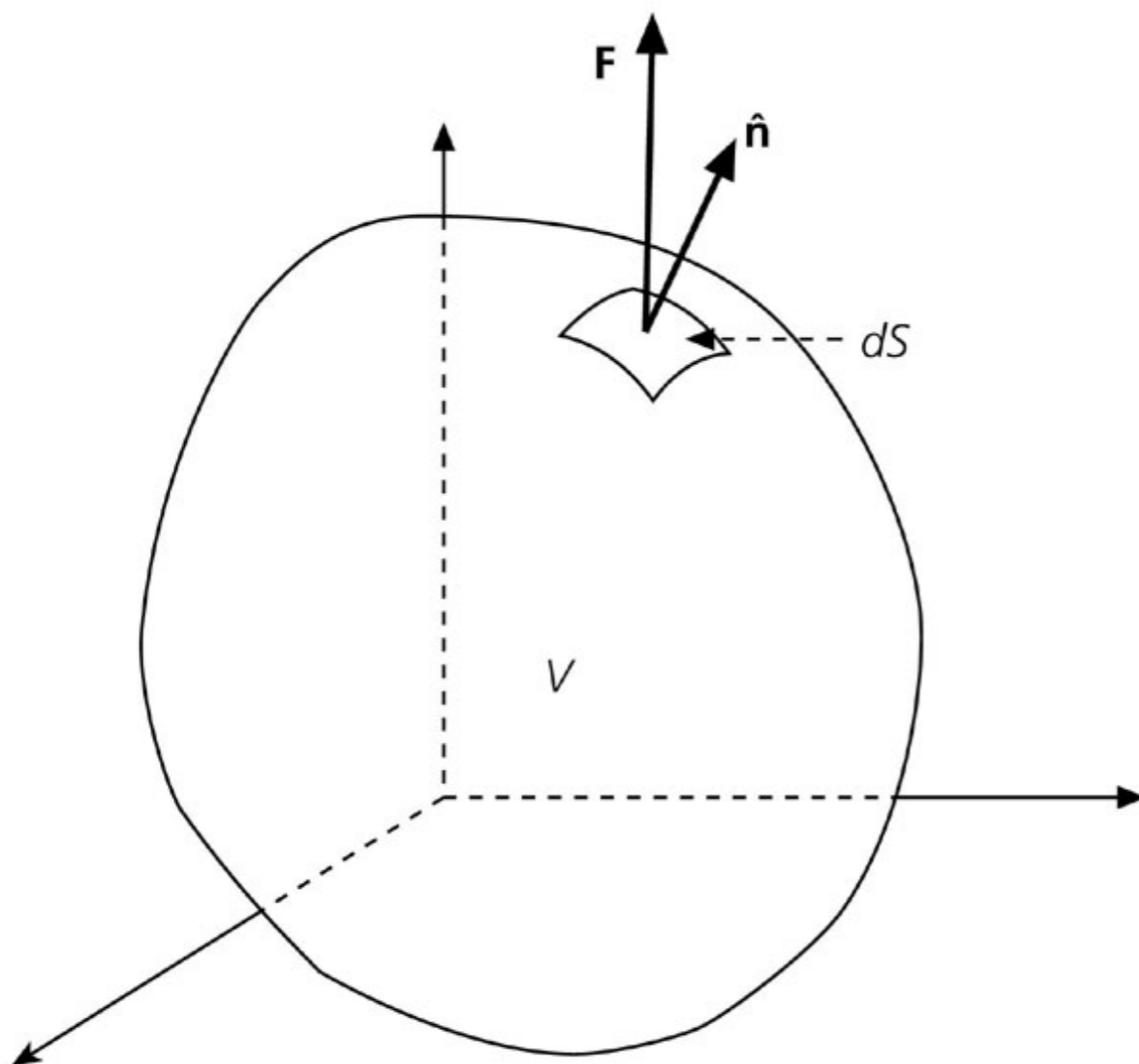

Traction vector cannot be completely described without the specification of the force ($\Delta \mathbf{F}$) and the surface ($\Delta \mathbf{S}$) on which it acts:

$$\mathbf{T}(\mathbf{n}) = \lim_{\Delta S \rightarrow 0} \frac{\Delta \mathbf{F}}{\Delta S} = \frac{d\mathbf{F}}{dS}$$

And from the linear momentum conservation, we can show that:

$$\mathbf{T}(-\mathbf{n}) = -\mathbf{T}(\mathbf{n})$$

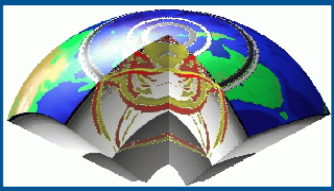
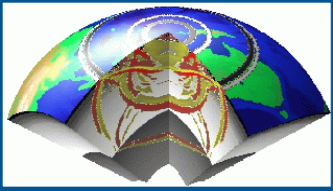

Stress acting on a given internal plane can be decomposed in 3 mutually orthogonal components: one normal (direct stress), tending to change the volume of the material, and two tangential (shear stress), tending to deform, to the surface. If we consider an infinitely small cube, aligned with a Cartesian reference system:

Figure 2.3-2: Traction vectors on the faces of a volume element.

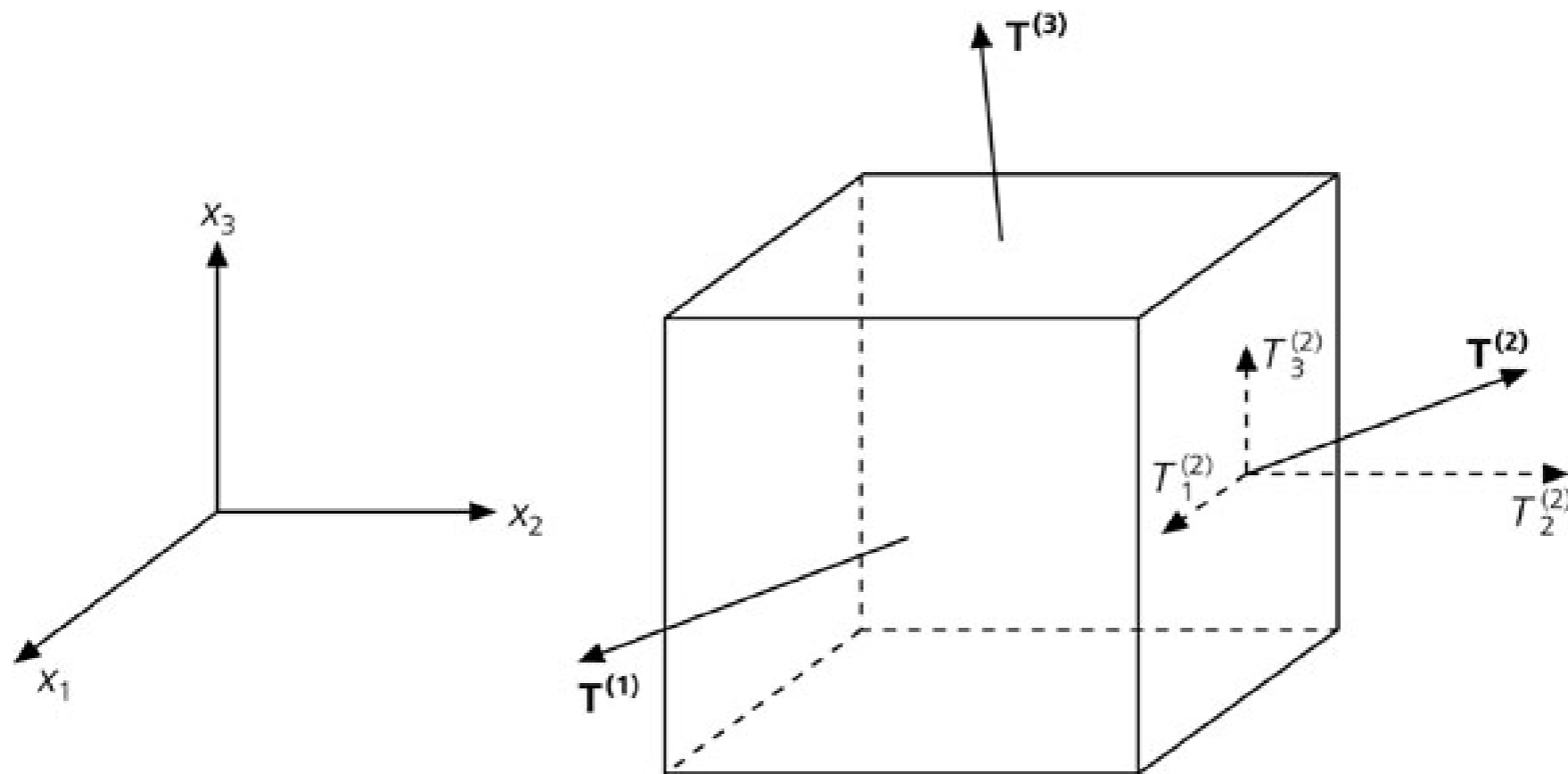

$$\mathbf{T}^{(n)} = n_i \mathbf{T}^{(i)} = n_i T_j^{(i)} \mathbf{e}_j = n_i \sigma_{ij} \mathbf{e}_j$$

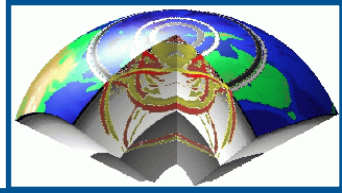
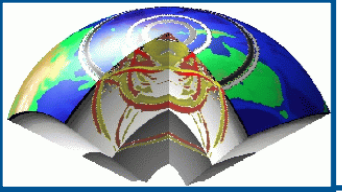

Consider an infinitively small tetrahedrum, whose 3 faces are oriented normally to the reference axes. The components of traction \mathbf{T} , acting on the face whose normal is \mathbf{n} can be written using the directional cosines referred to versor system $\hat{\mathbf{e}}$

$$\mathbf{T}^{(n)} = n_i \mathbf{T}^{(i)} = n_i T_j^{(i)} \mathbf{e}_j = n_i \sigma_{ij} \mathbf{e}_j$$

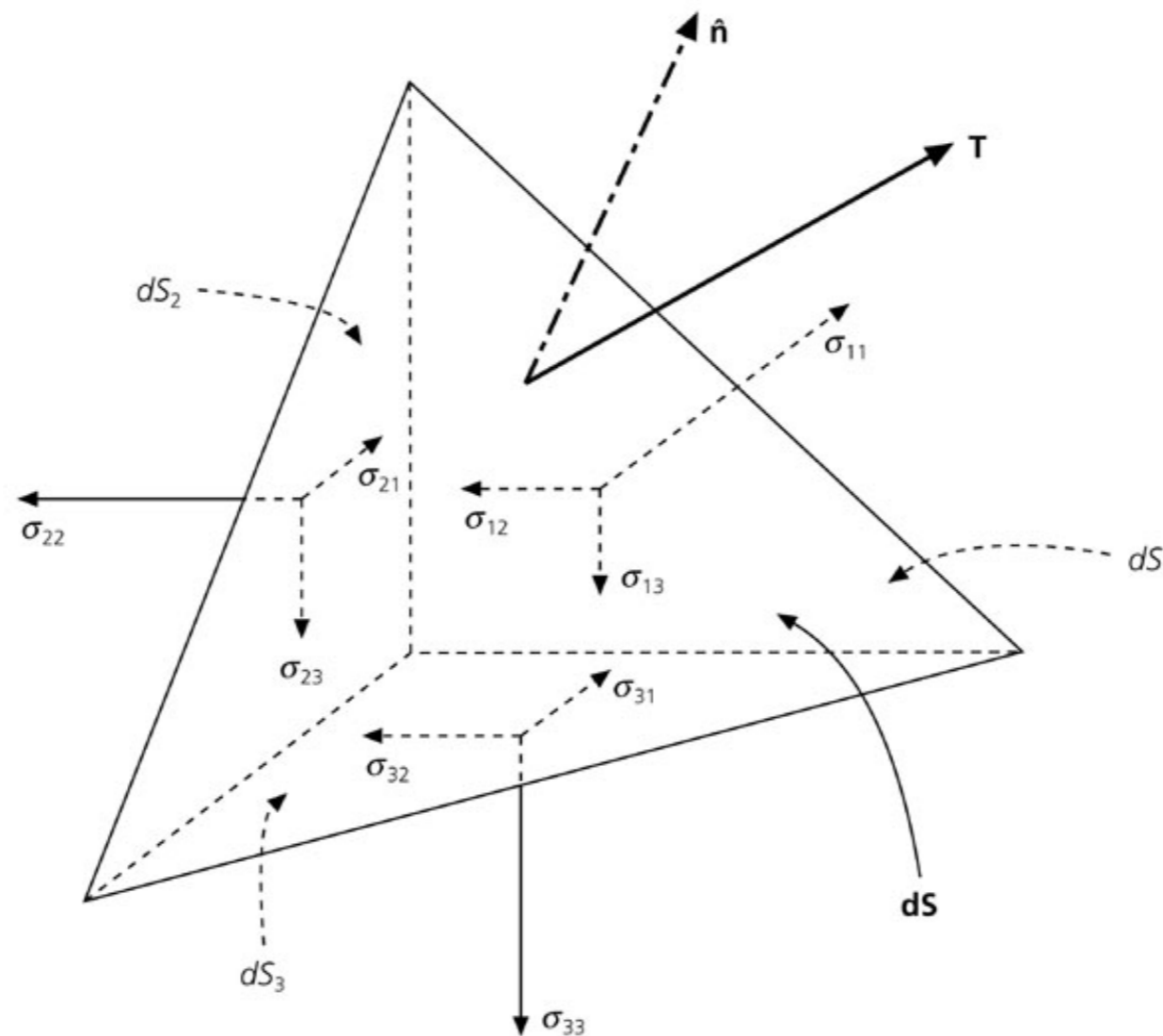

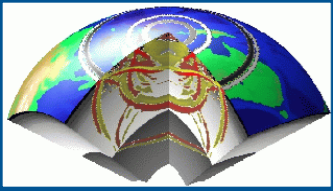

(Cauchy) Stress tensor

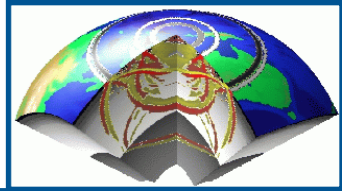

... in components we can write this as

$$T_j^{(i)} = n_i \sigma_{ij}$$

where σ_{ij} is the stress tensor and $\mathbf{n}=(n_i)$ is a surface normal.

The stress tensor describes the forces acting on planes within a body. Due to the symmetry condition

$$\sigma_{ij} = \sigma_{ji}$$

there are only six independent elements.

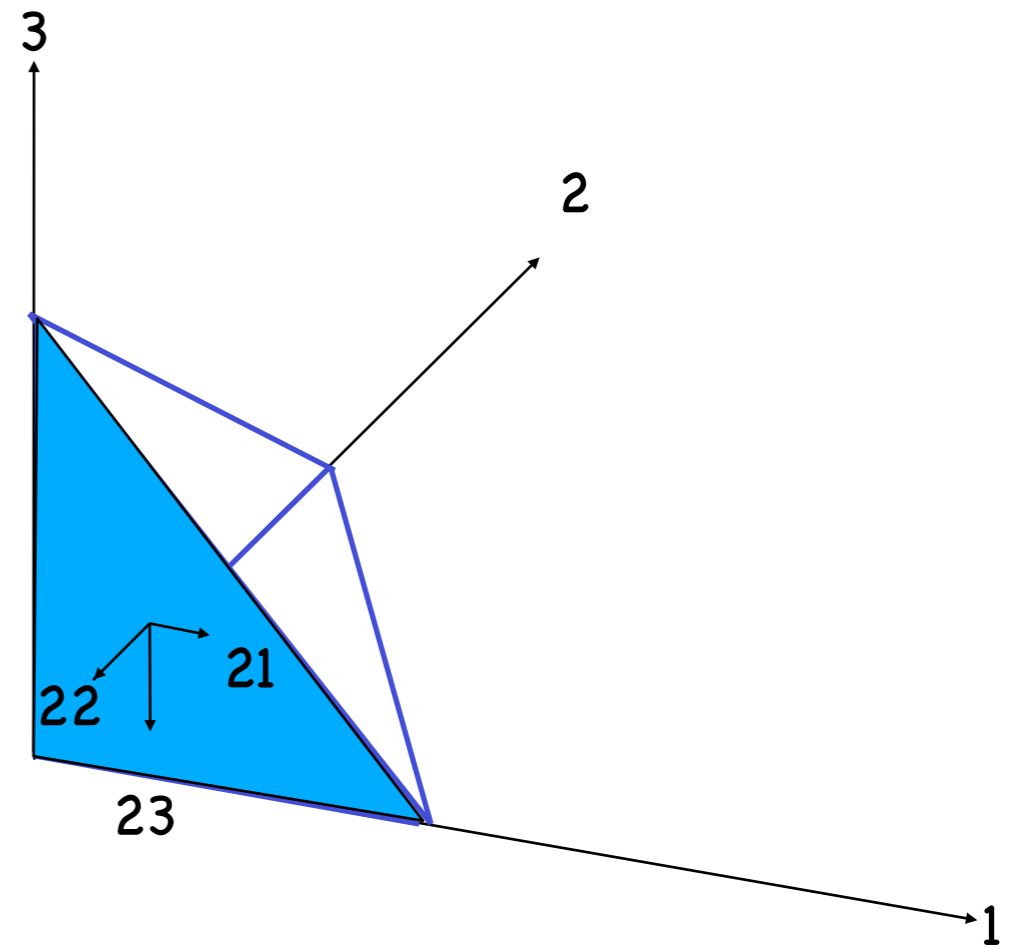

σ_{ij}

The vector normal to the corresponding surface

The direction of the force vector acting on that surface

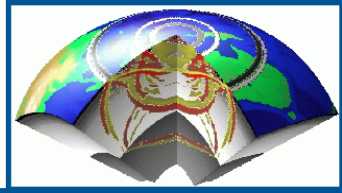
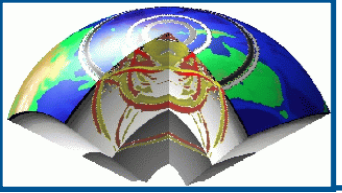

...and the stress state in a point of the material can be expressed with:

Figure 2.3-4: Stress components on the faces of a volume element.

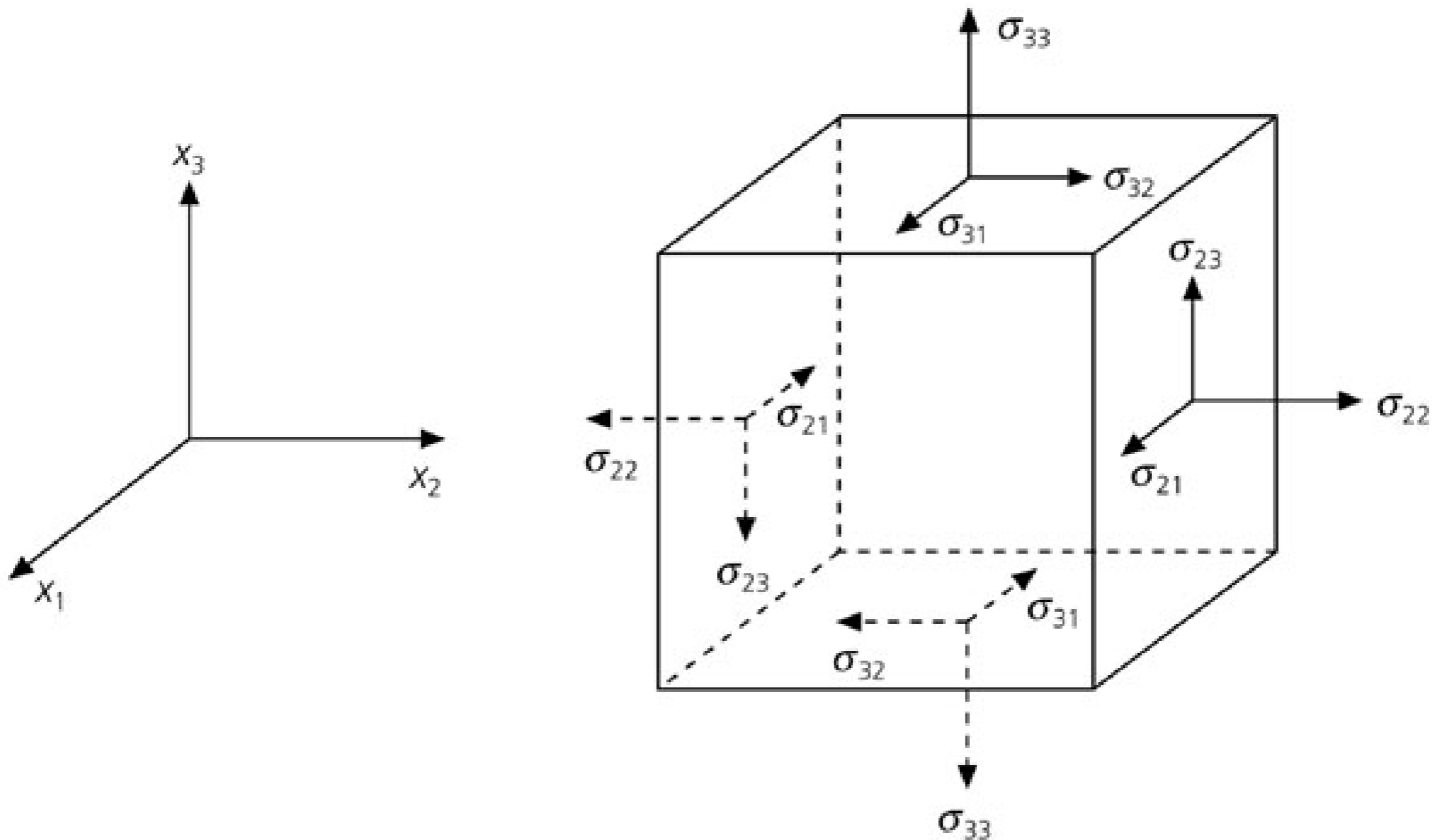

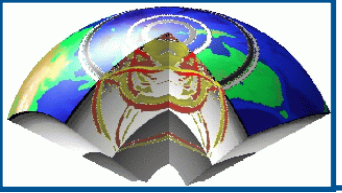

Stress tensor and principal axis

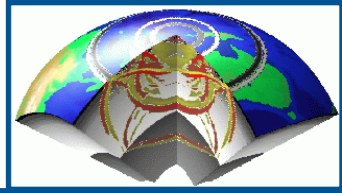

If the coordinate axes ($\hat{\mathbf{e}}_1, \hat{\mathbf{e}}_2$) are oriented in the principal stress directions, the stress tensor is diagonal,

$$\sigma_{ij} = \begin{pmatrix} \sigma_1 & 0 \\ 0 & \sigma_2 \end{pmatrix}$$

Now rotate the coordinate system by an angle θ : $A = \begin{pmatrix} \cos \theta & \sin \theta \\ -\sin \theta & \cos \theta \end{pmatrix}$

$$\sigma'_{ij} = A \sigma A^T = \begin{pmatrix} \cos \theta & \sin \theta \\ -\sin \theta & \cos \theta \end{pmatrix} \begin{pmatrix} \sigma_1 & 0 \\ 0 & \sigma_2 \end{pmatrix} \begin{pmatrix} \cos \theta & -\sin \theta \\ \sin \theta & \cos \theta \end{pmatrix} = \begin{pmatrix} \sigma_1 \cos^2 \theta + \sigma_2 \sin^2 \theta & (\sigma_2 - \sigma_1) \sin \theta \cos \theta \\ (\sigma_2 - \sigma_1) \sin \theta \cos \theta & \sigma_1 \sin^2 \theta + \sigma_2 \cos^2 \theta \end{pmatrix}$$

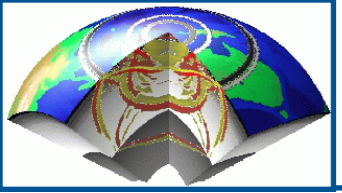

Stress - 2

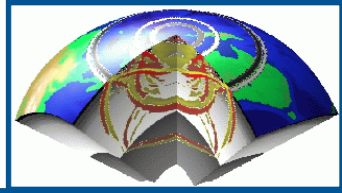
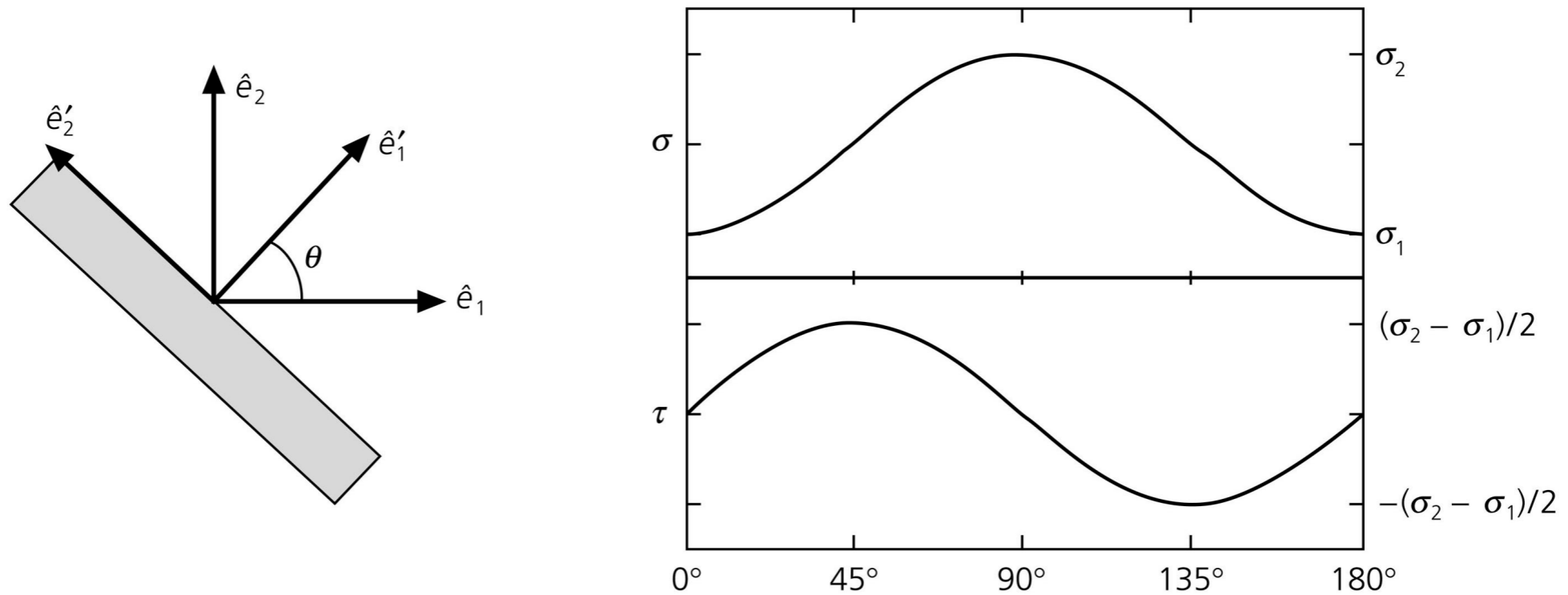

Figure 5.7-4: Normal and shear stresses as a function of geometry.



Normal stress:

$$\sigma = \sigma'_{11} = \sigma_1 \cos^2 \theta + \sigma_2 \sin^2 \theta = \frac{(\sigma_1 + \sigma_2)}{2} + \frac{(\sigma_1 - \sigma_2)}{2} \cos 2\theta$$

Shear stress:

$$\tau = \sigma'_{12} = (\sigma_2 - \sigma_1) \sin \theta \cos \theta = \frac{(\sigma_2 - \sigma_1)}{2} \sin 2\theta.$$

Mohr's circle shows the values of σ and τ as functions of θ (the angle between the normal to a plane and the principal stress direction, σ_1).



Mohr's circle

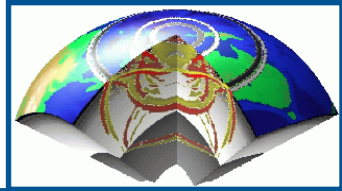
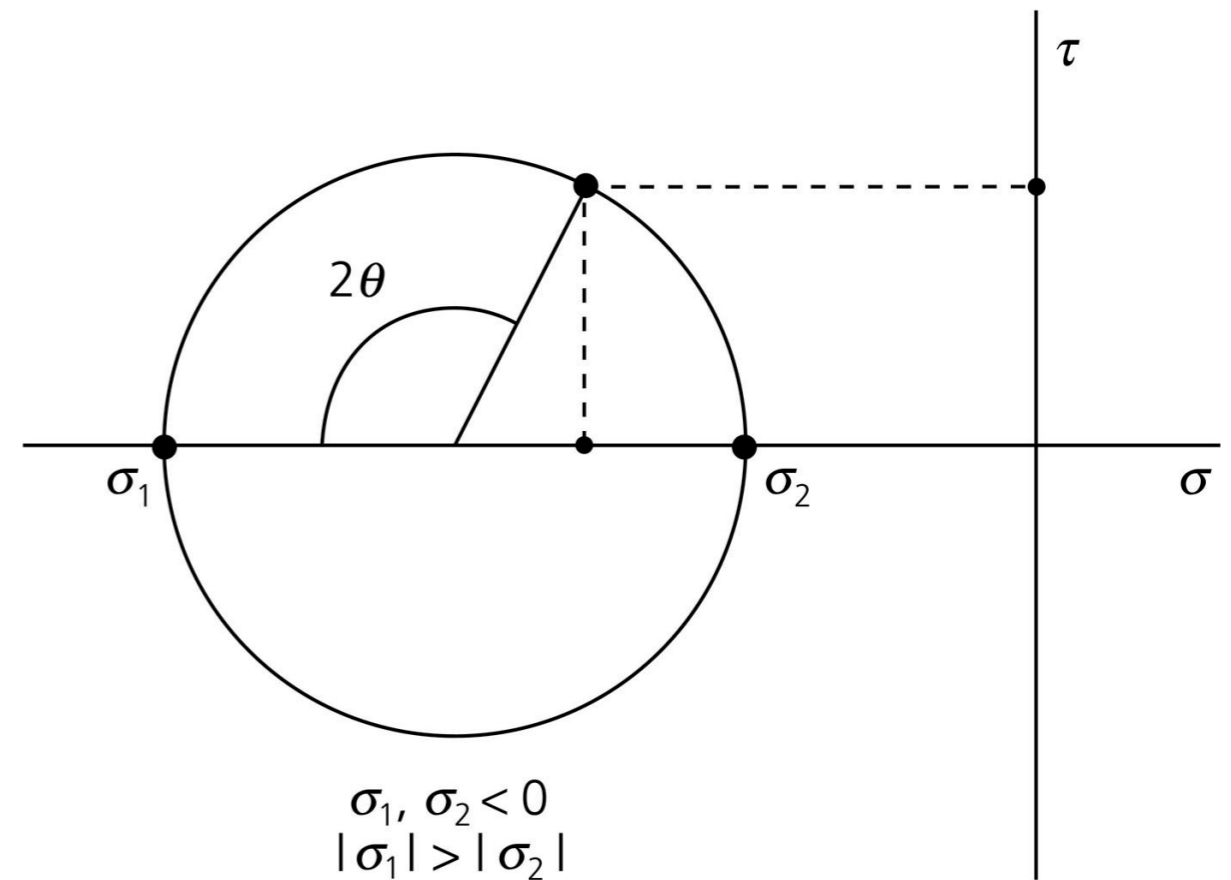

Figure 5.7-5: Definition of Mohr's circle.



Normal stress:

$$\sigma = \sigma'_{11} = \sigma_1 \cos^2 \theta + \sigma_2 \sin^2 \theta = \frac{(\sigma_1 + \sigma_2)}{2} + \frac{(\sigma_1 - \sigma_2)}{2} \cos 2\theta$$

Shear stress:

$$\tau = \sigma'_{12} = (\sigma_2 - \sigma_1) \sin \theta \cos \theta = \frac{(\sigma_2 - \sigma_1)}{2} \sin 2\theta.$$

Mohr's circle shows the values of σ and τ as functions of θ (the angle between the normal to a plane and the principal stress direction, σ_1).

<https://elearning.cpp.edu/learning-objects/mohrs-circle/>

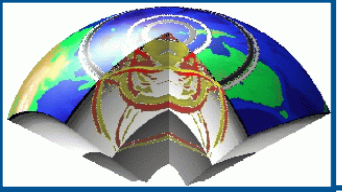

Ideal fluids

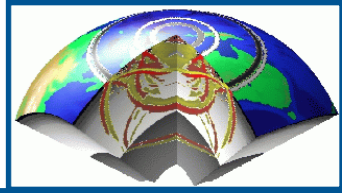

In a viscosity free liquid the stress tensor is diagonal, and defines the **PRESSURE**:

$$\sigma_{ij} = -p\delta_{ji}$$

The minus sign arises because of the outward normal convention: tractions that push inward are negative (positive stresses produce positive strains).

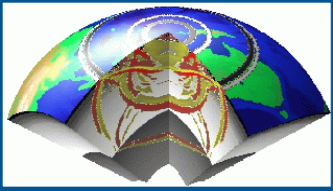

Stress equilibrium - Statics

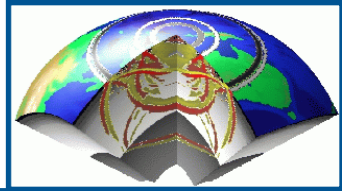

If a body is in equilibrium the internal forces and the forces acting on its surface have to vanish

$$\int_V \mathbf{f}_i dV + \oint_S \mathbf{T}_i dS = 0$$

as well as the sum over the angular momentum

$$\int_V \mathbf{x}_i \times \mathbf{f}_j dV + \oint_S \mathbf{x}_i \times \mathbf{T}_j dS = 0$$

From the second equation the symmetry of the stress tensor can be derived. Using Gauss' law the first equation yields

$$\mathbf{f}_i + \frac{\partial \sigma_{ij}}{\partial x_j} = 0$$

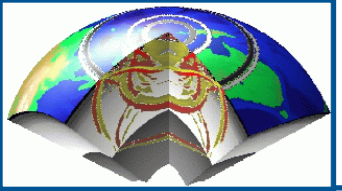

Statics - 1

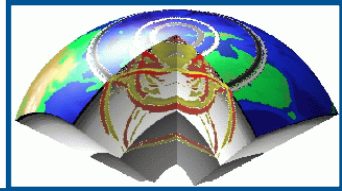
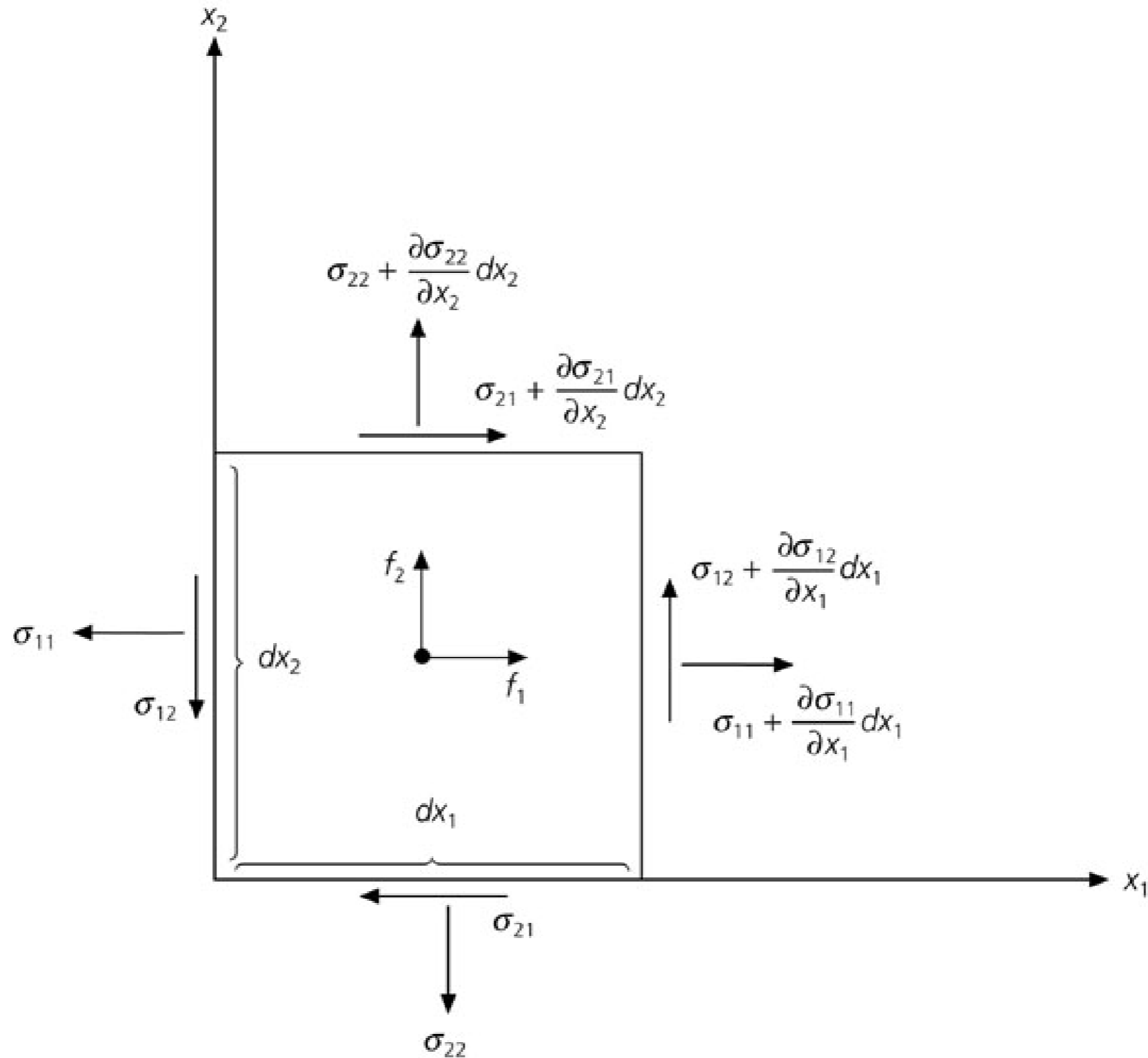
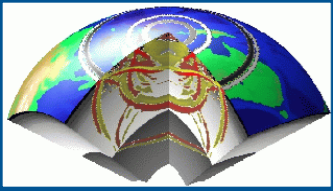

Figure 2.3-5: Torques on a rectangle.





Statics - 2

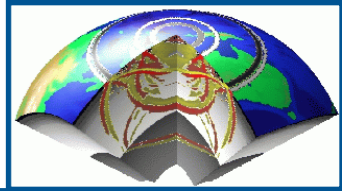
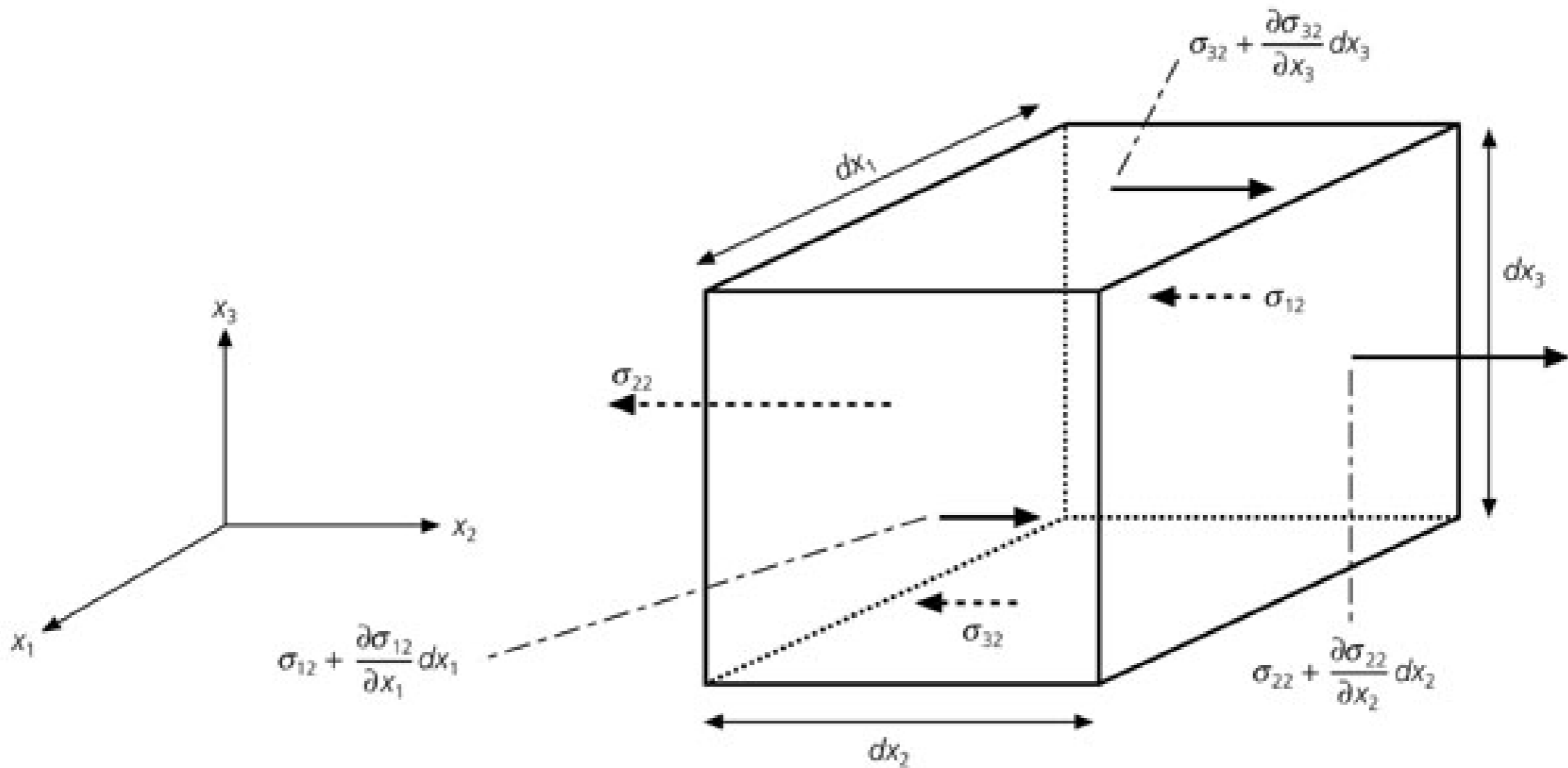
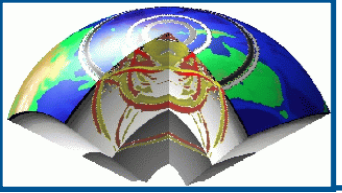
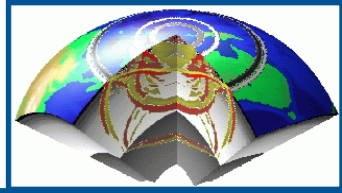

Figure 2.3-10: Stress components contributing to force in the x_2 direction.





Stress - Glossary



Stress units	$\text{bar} = 10^5 \text{N/m}^2 = 10^5 \text{Pa} = 10^6 \text{dyne/cm}^2$ $\text{mbar} = 10^2 \text{Pa} = 10^3 \text{dyne/cm}^2$ $1 \text{MPa} = 10^6 \text{Pa} = 10 \text{bar}$ At sea level $p = 1 \text{bar}$ At depth 3km $p = 1 \text{kbar}$
maximum compressive stress	the direction perpendicular to the minimum compressive stress, near the surface mostly in horizontal direction, linked to tectonic processes.
principal stress axes	the direction of the eigenvectors of the stress tensor



Stress-strain relation - 1

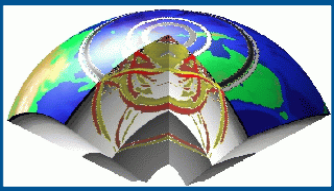

The relation between stress and strain in general is described by the tensor of elastic constants c_{ijkl}

$$\sigma_{ij} = c_{ijkl} \varepsilon_{kl}$$

Generalised Hooke's Law

From the symmetry of the stress and strain tensor and a thermodynamic condition it follows that the maximum number of independent constants of c_{ijkl} is 21. In an isotropic body, where the properties do not depend on direction, the relation reduces to

$$\sigma_{ij} = \lambda \theta \delta_{ij} + 2\mu \varepsilon_{ij}$$

Hooke's Law

where λ and μ are the Lamé parameters, θ is the dilatation and δ_{ij} is the Kronecker delta.

$$\theta \delta_{ij} = \varepsilon_{kk} \delta_{ij} = \left(\varepsilon_{11} + \varepsilon_{22} + \varepsilon_{33} \right) \delta_{ij}$$



Stress-strain relation - 2

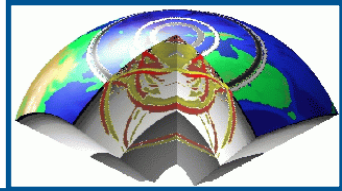

The complete stress tensor looks like

$$\sigma_{ij} = \begin{pmatrix} (\lambda + 2\mu)\varepsilon_{11} + \lambda(\varepsilon_{22} + \varepsilon_{33}) & 2\mu\varepsilon_{12} & 2\mu\varepsilon_{13} \\ 2\mu\varepsilon_{21} & (\lambda + 2\mu)\varepsilon_{22} + \lambda(\varepsilon_{11} + \varepsilon_{33}) & 2\mu\varepsilon_{23} \\ 2\mu\varepsilon_{31} & 2\mu\varepsilon_{32} & (\lambda + 2\mu)\varepsilon_{33} + \lambda(\varepsilon_{11} + \varepsilon_{22}) \end{pmatrix}$$

Mean stress (invariant respect to the coordinate system)

$$M = \frac{(\sigma_{11} + \sigma_{22} + \sigma_{33})}{3} = \frac{\sum_{n=1}^3 \lambda_n}{3}$$

Deviatoric stress:

$$D_{ij} = \sigma_{ij} - M\delta_{ij}$$

In the Earth the mean stress is essentially due to **lithostatic** load:

$$P = -\int_0^h \rho(z) dz$$



Elastic parameters

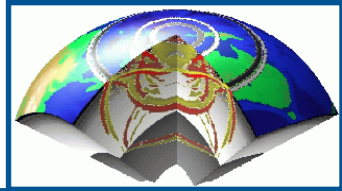

Rigidity is the ratio of pure shear strain and the applied shear stress component

$$\mu = \frac{\sigma_{ij}}{2\varepsilon_{ij}}$$

Bulk modulus of incompressibility is defined the ratio of pressure to volume change. Ideal fluid means no rigidity ($\mu = 0$), thus λ is the incompressibility of a fluid.

$$K = -\frac{P}{\theta} = \lambda + \frac{2}{3}\mu$$

Consider a stretching experiment where tension is applied to an isotropic medium along a principal axis (say x).

$$\text{Poisson's ratio} \equiv \nu = -\frac{\varepsilon_{22}}{\varepsilon_{11}} = \frac{\lambda}{2(\lambda + \mu)} \quad \text{Young's modulus} \equiv E = -\frac{\sigma_{11}}{\varepsilon_{11}} = \frac{\mu(3\lambda + 2\mu)}{\lambda + \mu}$$

$$\lambda = \frac{\nu E}{(1 + \nu)(1 - 2\nu)} \quad \mu = \frac{E}{2(1 + \nu)}$$

For Poisson's ratio we have $0 < \nu < 0.5$.

A useful approximation is $\lambda = \mu$ (Poisson's solid), then $\nu = 0.25$ and for fluids $\nu = 0.5$

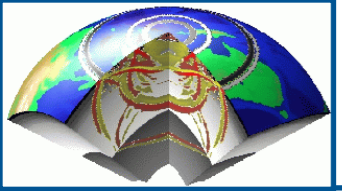

Stress-strain - significance

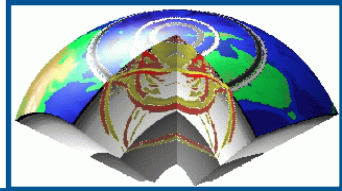

As in the case of deformation the stress-strain relation can be interpreted in simple geometric terms:

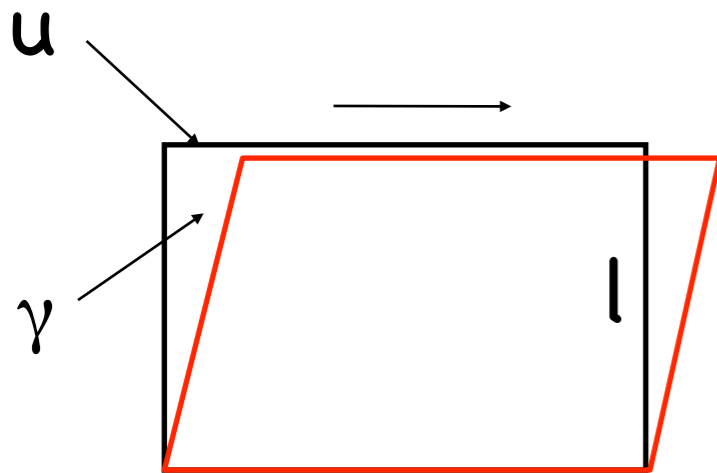

$$\sigma_{12} = \mu\gamma = \mu\epsilon_{12}$$

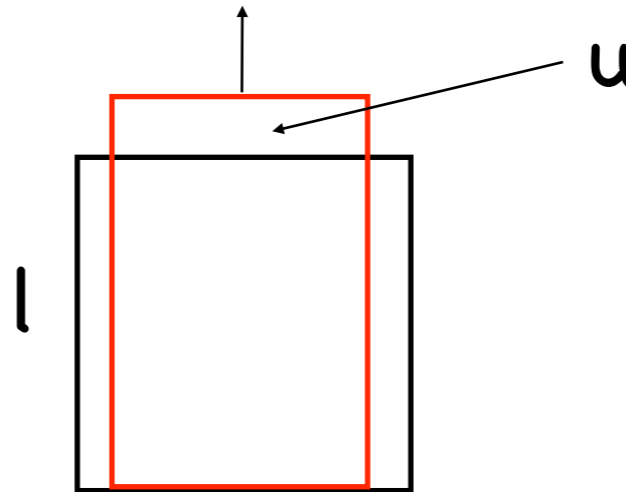

$$\sigma_{22} = E \frac{u}{l} = K\epsilon_{ii}$$

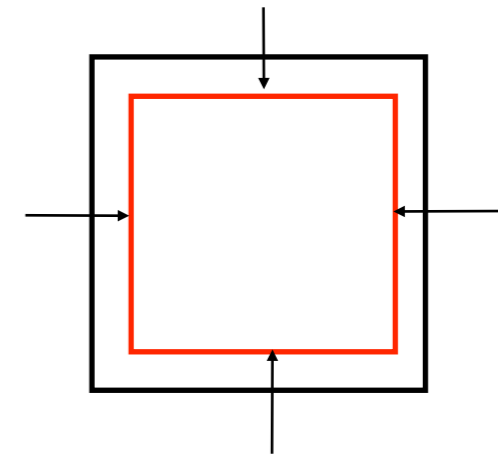

$$p = K \frac{\Delta V}{V} = K\epsilon_{ii}$$

Remember that these relations are a generalization of Hooke's Law:

$$F = Kx$$

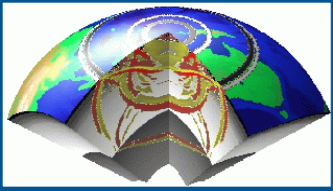

Elastic constants

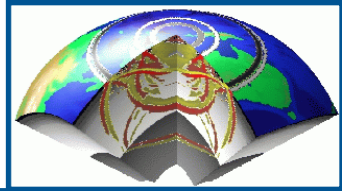

Let us look at some examples for elastic constants:

Rock	K 10^{12} dynes/cm ²	E 10^{12} dynes/cm ²	μ 10^{12} dynes/cm ²	ν
Limestone		0.621	0.248	0.251
Granite	0.132	0.416	0.197	0.055
Gabbro	0.659	1.08	0.438	0.219
Dunite		1.52	0.6	0.27

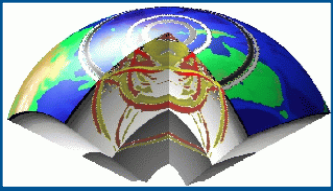

Elastic anisotropy

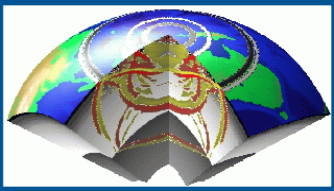

What is seismic anisotropy?

$$\sigma_{ij} = C_{ijkl} \varepsilon_{kl}$$

Seismic wave propagation in anisotropic media is quite different from isotropic media:

- There are in general 21 independent elastic constants (instead of 2 in the isotropic case)
- there is shear wave splitting (analogous to optical birefringence)
- waves travel at different speeds depending in the direction of propagation
- the polarization of compressional and shear waves may not be perpendicular or parallel to the wavefront, resp.

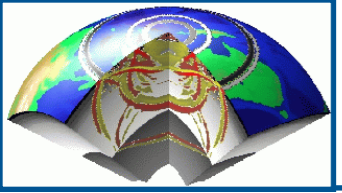

Shear wave splitting

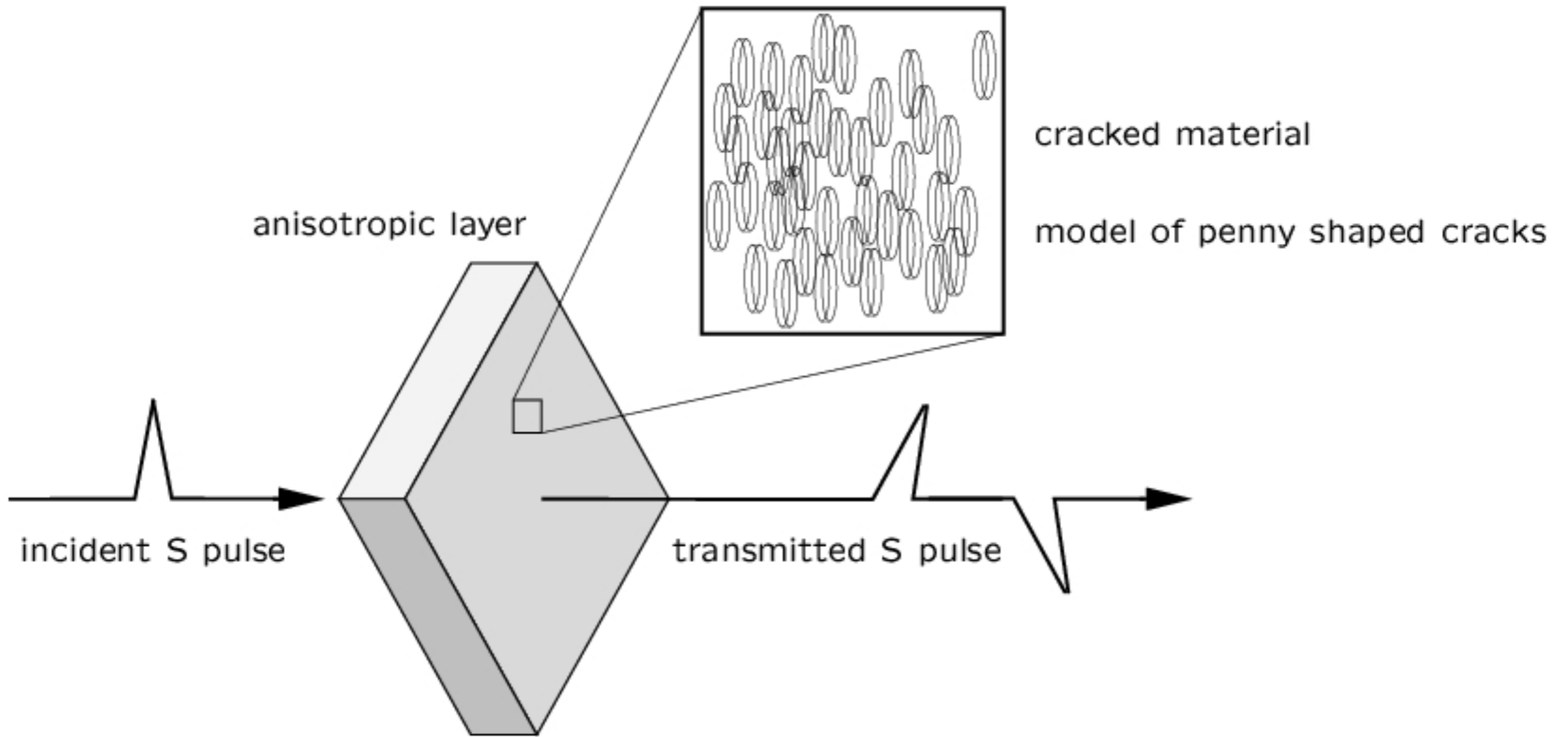
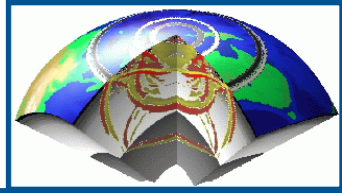

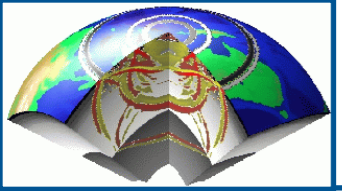

Summary: Elasticity - Stress



- Seismic wave propagation can in most cases be described by **linear elasticity**.
- The deformation of a medium is described by the symmetric **elasticity tensor**.
- The internal forces acting on virtual planes within a medium are described by the symmetric **stress tensor**.
- The stress and strain are linked by the material parameters (like spring constants) through the **generalised Hooke's Law**.
- In isotropic media there are only two elastic constants, the **Lame parameters**.
- In **anisotropic** media the wave speeds depend on direction and there are a maximum of 21 independent elastic constants.

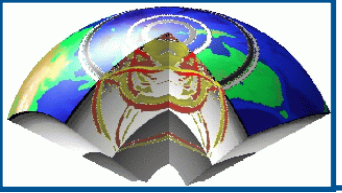

The Elastic Wave Equation

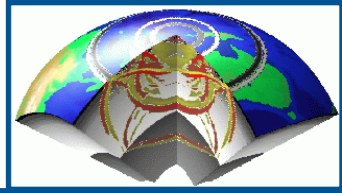

- **Elastic waves in infinite homogeneous isotropic media**
 - Helmholtz's theorem
 - P and S waves
- **Plane wave propagation in infinite media**
 - Frequency, wavenumber, wavelength
 - Geometrical spreading

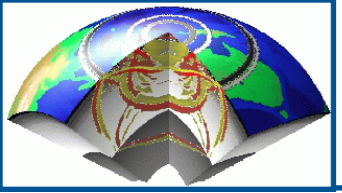

Equations of elastic motion

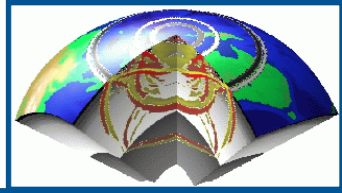

We now have a complete description of the forces acting within an elastic body. Adding the inertia forces with opposite sign leads us from

$$\mathbf{f}_i + \frac{\partial \sigma_{ij}}{\partial x_j} = 0$$

to

$$\rho \frac{\partial^2 u_i}{\partial t^2} = \mathbf{f}_i + \frac{\partial \sigma_{ij}}{\partial x_j}$$

the equations of motion for dynamic elasticity



Eq. of motion - homogeneous media

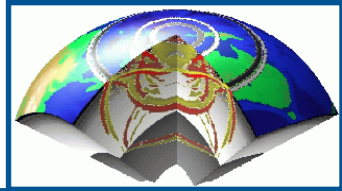

$$\rho \partial_t^2 u_i = f_i + \partial_j \sigma_{ij}$$

What are the solutions to this equation? At first we look at infinite homogeneous isotropic media, then:

$$\sigma_{ij} = \lambda \theta \delta_{ij} + 2\mu \varepsilon_{ij}$$

$$\sigma_{ij} = \lambda \partial_k u_k \delta_{ij} + \mu (\partial_i u_j + \partial_j u_i)$$

$$\rho \partial_t^2 u_i = f_i + \partial_j \left(\lambda \partial_k u_k \delta_{ij} + \mu (\partial_i u_j + \partial_j u_i) \right)$$

$$\rho \partial_t^2 u_i = f_i + \lambda \partial_i \partial_k u_k + \mu \partial_i \partial_j u_j + \mu \partial_j^2 u_i$$

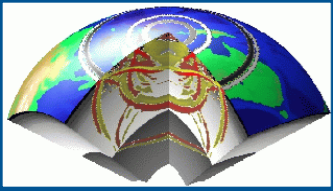

Navier equations

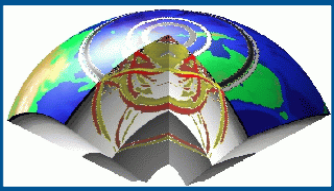

$$\rho \partial_t^2 u_i = f_i + \lambda \partial_i \partial_k u_k + \mu \partial_i \partial_j u_j + \mu \partial_{jj}^2 u_i$$

We can now simplify this equation using the curl and div operators

$$\nabla \cdot \mathbf{u} = \partial_i u_i \quad \nabla^2 = \Delta = \partial_x^2 + \partial_y^2 + \partial_z^2$$

and

$$\Delta \mathbf{u} = \nabla \nabla \cdot \mathbf{u} - \nabla \times \nabla \times \mathbf{u}$$

$$\rho \partial_t^2 \mathbf{u} = \mathbf{f} + (\lambda + 2\mu) \nabla \nabla \cdot \mathbf{u} - \mu \nabla \times \nabla \times \mathbf{u}$$

... this holds in any coordinate system ...

This equation can be further simplified,

neglecting body forces (by choosing a proper reference state) and

separating the wavefield into curl free and div free parts

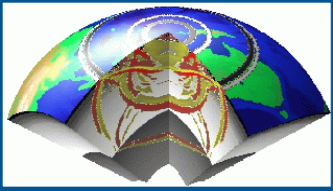

Equations of motion – P waves

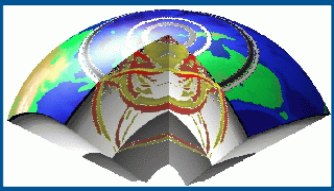

$$\rho \partial_t^2 \mathbf{u} = (\lambda + 2\mu) \nabla \nabla \cdot \mathbf{u} - \mu \nabla \times \nabla \times \mathbf{u}$$

If we apply the **div** operator to this equation, we obtain

$$\rho \partial_t^2 \theta = (\lambda + 2\mu) \Delta \theta$$

where

$$\theta = \nabla \cdot \mathbf{u}$$

“Acoustic” wave equation

with

P-wave velocity

$$\frac{1}{\alpha^2} \partial_t^2 \theta = \Delta \theta$$

$$\alpha = \sqrt{\frac{\lambda + 2\mu}{\rho}}$$

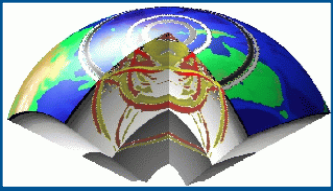

Equations of motion – S waves

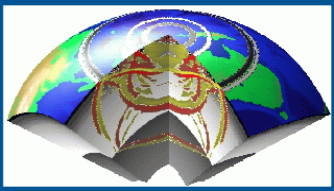

$$\rho \partial_{+}^2 \mathbf{u} = (\lambda + 2\mu) \nabla \nabla \cdot \mathbf{u} - \mu \nabla \times \nabla \times \mathbf{u}$$

If we apply the **curl** operator to this equation, we obtain

$$\rho \partial_{+}^2 \nabla \times \mathbf{u} = (\lambda + \mu) \nabla \times \nabla \theta + \mu \Delta (\nabla \times \mathbf{u})$$

we now make use of $\nabla \times \nabla \theta = 0$ and define

$$\boldsymbol{\varphi} = \nabla \times \mathbf{u}$$

to obtain

Shear wave equation

$$\frac{1}{\beta^2} \partial_{+}^2 \boldsymbol{\varphi} = \Delta \boldsymbol{\varphi}$$

S-wave velocity

$$\beta = \sqrt{\frac{\mu}{\rho}}$$

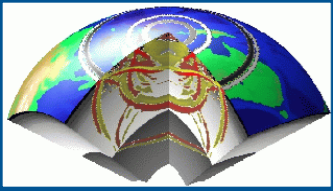

Helmholtz theorem

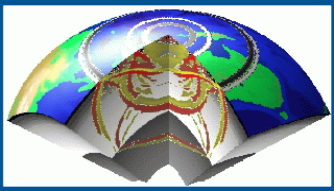

Any vector field $\mathbf{u}=\mathbf{u}(\mathbf{x})$ may be separated into scalar and vector potentials

$$\mathbf{u} = \nabla\Phi + \nabla \times \Psi$$

since it is possible to solve the Poisson equation

$$\nabla^2 \mathbf{W} = \mathbf{u}$$

$$\mathbf{W}(\mathbf{x}) = -\iiint_V \frac{\mathbf{u}(\xi)}{4\pi|\mathbf{x}-\xi|} d\xi$$

and then the identity

$$\Delta = \nabla\nabla \cdot - \nabla \times \nabla \times$$

tells us that

$$\Phi = \nabla \cdot \mathbf{W} \text{ and } \Psi = -\nabla \times \mathbf{W}$$

<http://farside.ph.utexas.edu/teaching/em/lectures/node37.html>

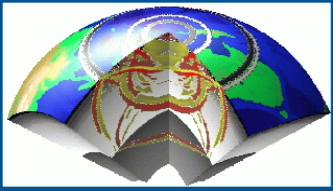

Elastodynamic Potentials

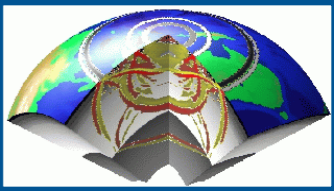

Any vector may be separated into scalar and vector potentials

$$\mathbf{u} = \nabla\Phi + \nabla \times \Psi$$

where Φ is the potential for P waves and Ψ the potential for shear waves

$$\Rightarrow \theta = \Delta\Phi$$

$$\Rightarrow \varphi = \nabla \times \mathbf{u} = \nabla \times \nabla \times \Psi = -\Delta\Psi$$

P-waves have no rotation

Shear waves have no change in volume

$$\frac{1}{\alpha^2} \partial_{\dagger}^2 \theta = \Delta\theta$$

$$\frac{1}{\beta^2} \partial_{\dagger}^2 \varphi = \Delta\varphi$$



Plane waves

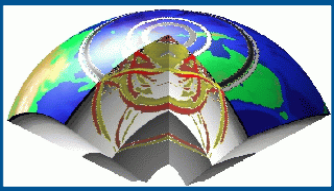

... what can we say about the direction of displacement, the **polarization** of seismic waves?

$$\mathbf{u} = \nabla\Phi + \nabla \times \Psi \quad \Rightarrow \quad \mathbf{u} = \mathbf{P} + \mathbf{S}$$

$$\mathbf{P} = \nabla\Phi \quad \mathbf{S} = \nabla \times \Psi$$

... we now assume that the potentials have the well known form of plane harmonic waves

$$\Phi = A \exp[i(\mathbf{k} \cdot \mathbf{x} - \omega t)]$$



$$\mathbf{P} = A \mathbf{k} \exp[i(\mathbf{k} \cdot \mathbf{x} - \omega t)]$$

P waves are **longitudinal** as P is parallel to k

$$\Psi = B \exp[i(\mathbf{k} \cdot \mathbf{x} - \omega t)]$$



$$\mathbf{S} = \mathbf{k} \times B \exp[i(\mathbf{k} \cdot \mathbf{x} - \omega t)]$$

S waves are **transverse** because S is normal to the wave vector k

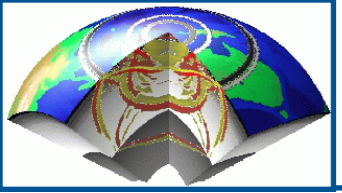

Wavefields visualization

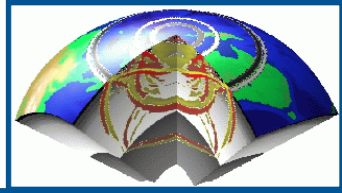

P Wave

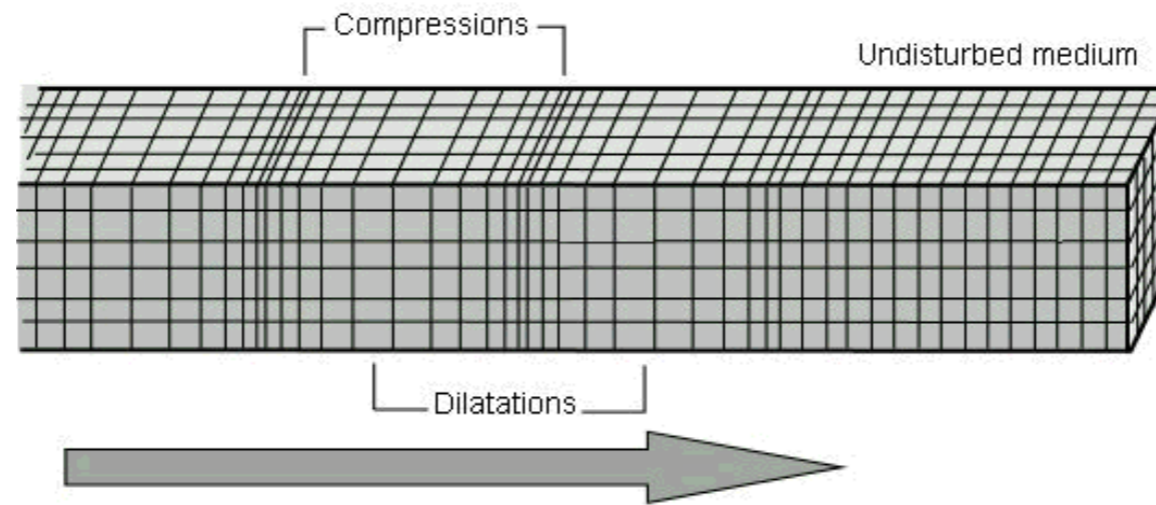

S Wave

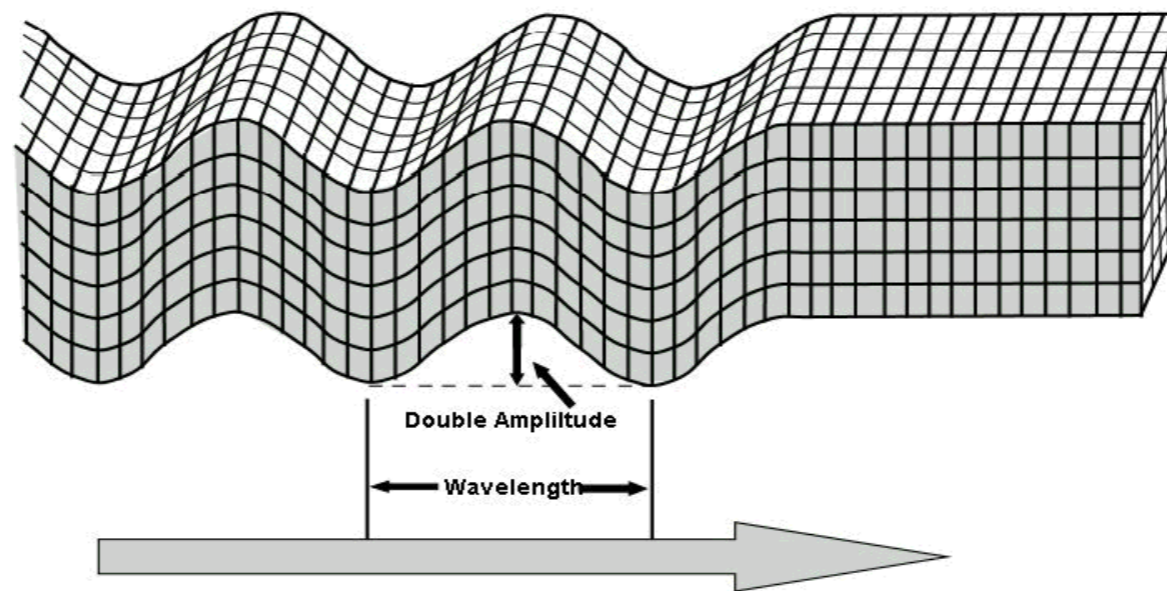



Seismic Velocities

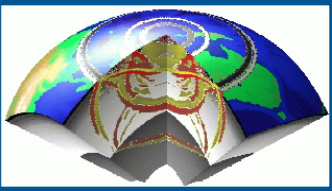

Material	P-wave velocity (m/s)	shear wave velocity (m/s)
Water	1500	0
Loose sand	1800	500
Clay	1100-2500	
Sandstone	1400-4300	
Anhydrite, Gulf Coast	4100	
Conglomerate	2400	
Limestone	6030	3030
Granite	5640	2870
Granodiorite	4780	3100
Diorite	5780	3060
Basalt	6400	3200
Dunite	8000	4370
Gabbro	6450	3420

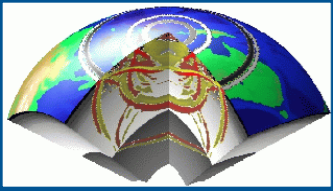

Seismic Velocities

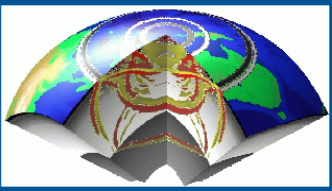

Material	V_p (km/s)
Unconsolidated material	
Sand (dry)	0.2-1.0
Sand (wet)	1.5-2.0
Sediments	
Sandstones	2.0-6.0
Limestones	2.0-6.0
Igneous rocks	
Granite	5.5-6.0
Gabbro	6.5-8.5
Pore fluids	
Air	0.3
Water	1.4-1.5
Oil	1.3-1.4
Other material	
Steel	6.1
Concrete	3.6

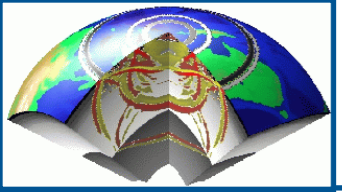

Solutions to the wave eq. - general

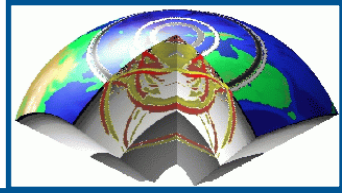

Let us consider a region without sources

$$\frac{1}{c^2} \frac{\partial^2 \eta}{\partial t^2} = \Delta \eta$$

Where η could be either dilatation or the vector potential and c is either P- or S- velocity. The general solution to this equation is:

$$\eta(x_i, t) = G(k_j x_j \pm \omega t)$$

Let us take a look at a 1-D example

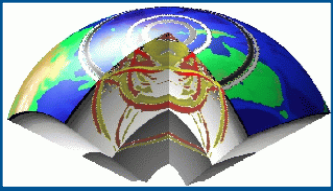

Solutions to the wave eq. - harmonic

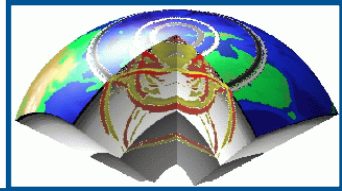

Let us consider a region without sources

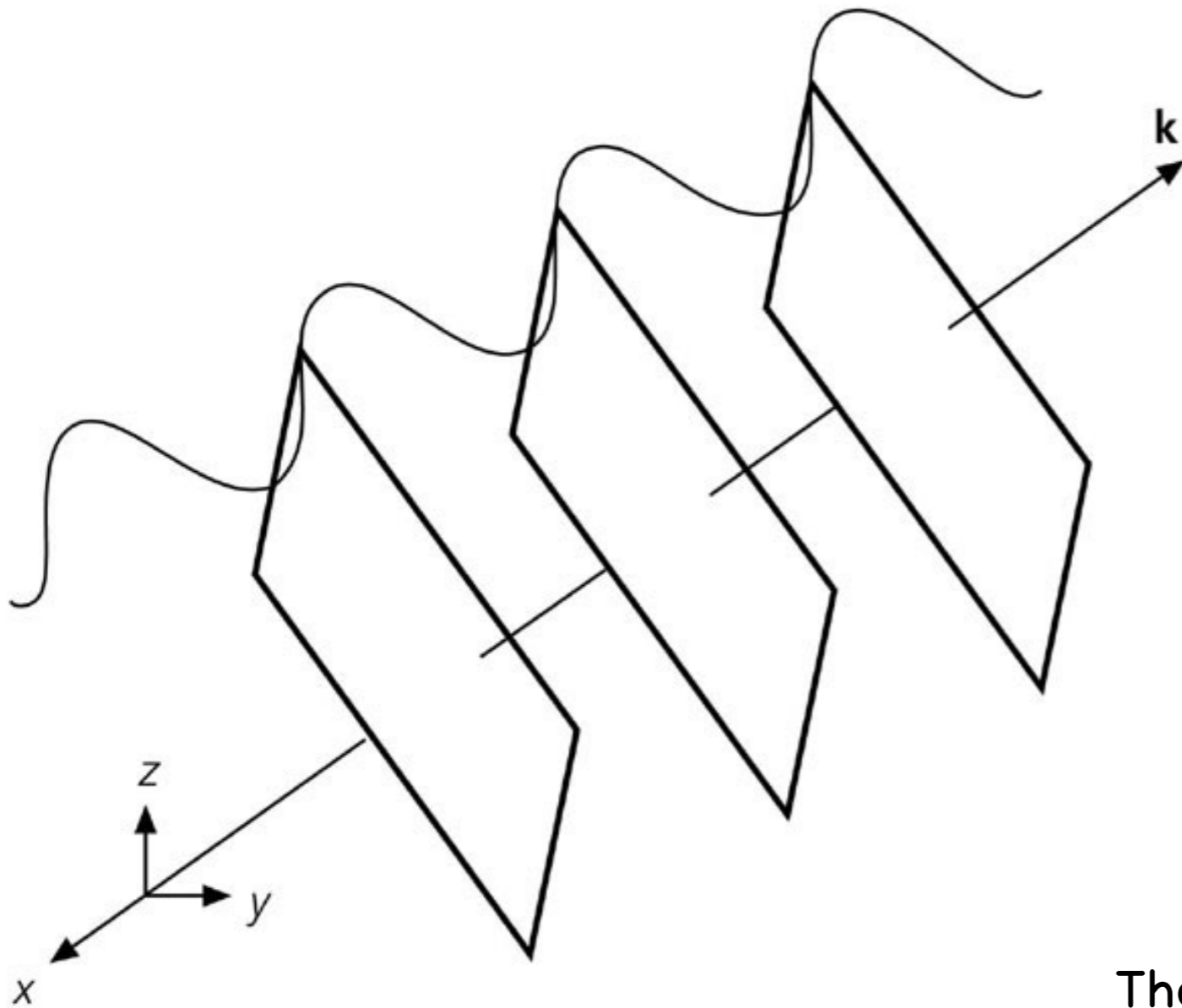

$$\frac{1}{c^2} \frac{\partial^2 \eta}{\partial t^2} = \Delta \eta$$

The most appropriate choice for G is of course the use of harmonic functions:

$$\mathbf{G}(\mathbf{x}, t) = \mathbf{A} \exp \left[i(\mathbf{k} \cdot \mathbf{x} \pm \omega t) \right] = \mathbf{A} \exp \left[i(k_j x_j \pm \omega t) \right]$$

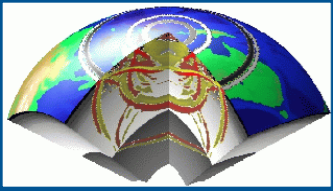

Solutions to the wave equation - harmonic

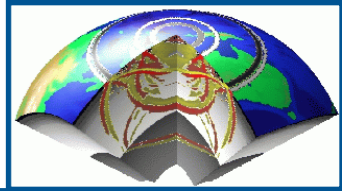

... taking only the real part and considering only 1D we obtain

$$u(x, t) = A \cos[kx - \omega t]$$

$$[kx - \omega t] = \left[\frac{2\pi}{\lambda} x - \frac{2\pi}{T} t \right] = [k(x - ct)]$$

c	wave speed
k	wavenumber
λ	wavelength
T	period
ω	frequency
A	amplitude

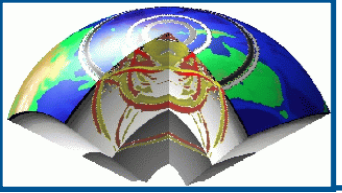

Energy of elastic waves - kinetic

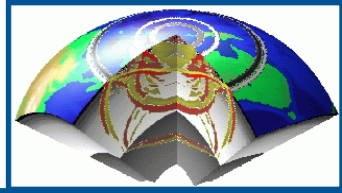

Energy in Plane Waves:

As with the 1-D string, the kinetic energy and potential energy (work, or strain energy) are equal when averaged over one wavelength.

For shear wave moving in z direction:

$$u_y(z, t) = B \cos(\omega t - kz)$$

$$KE = \frac{1}{2} \int_V \rho \left(\frac{\partial u_i}{\partial t} \right)^2 dV$$

$$KE = \frac{1}{2\lambda} \rho B^2 \omega^2 \int_0^\lambda \sin^2(\omega t - kz) dz = \frac{1}{2\lambda} \rho B^2 \omega^2 \frac{\lambda}{2} = B^2 \omega^2 \rho / 4$$

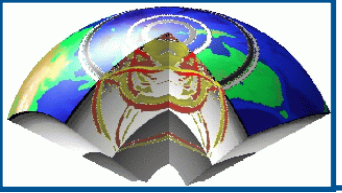

Energy of elastic waves - strain

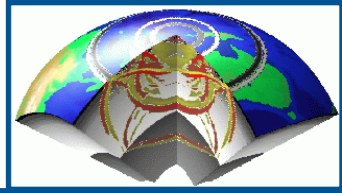

The strain energy is

$$W = \frac{1}{2} \int_V \sigma_{ij} e_{ij} dV$$

$$W = \frac{1}{2\lambda} \int_0^\lambda \mu B^2 k^2 \sin^2(\omega t - kz) dz = \mu B^2 k^2 / 4 = B^2 \omega^2 \rho / 4$$

$$E = KE + W = B^2 \omega^2 \rho / 2$$

(similar for P waves)

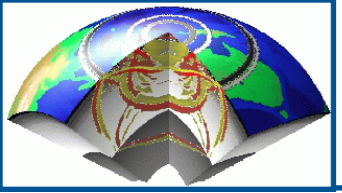

Spherical Waves

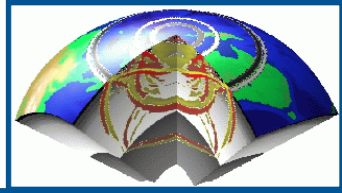
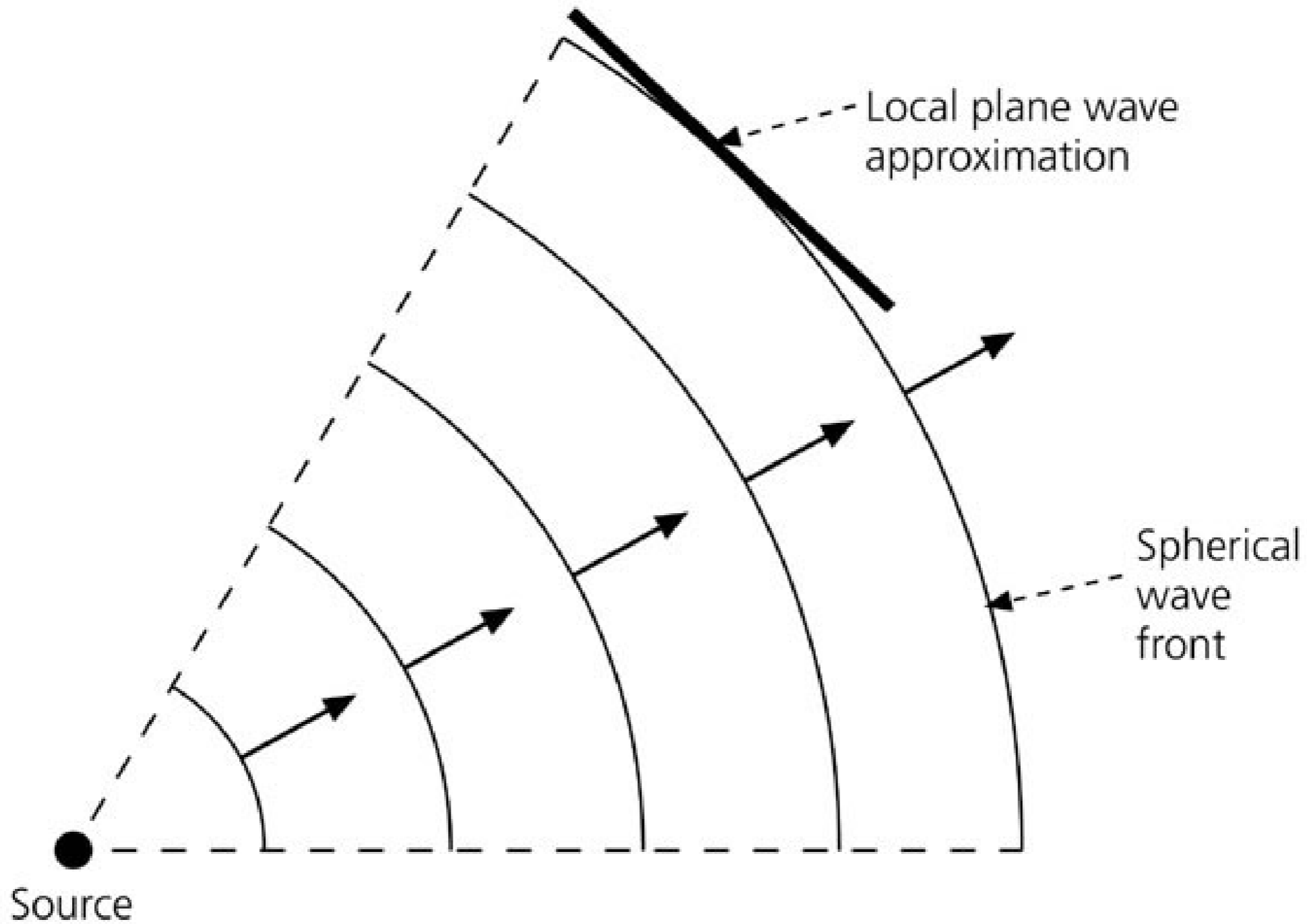
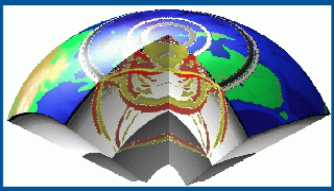

Figure 2.4-2: Approximation of a spherical wave front as plane waves.





Spherical Waves



$$\frac{1}{c^2} \frac{\partial^2 \eta}{\partial t^2} = \Delta \eta$$

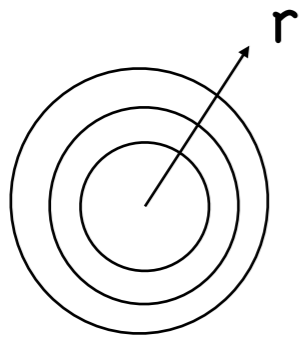

Let us assume that η is a function of the distance from the source

$$\Delta \eta = \partial_r^2 \eta + \frac{2}{r} \partial_r \eta = \frac{1}{c^2} \partial_t^2 \eta$$

where we used the definition of the Laplace operator in spherical coordinates let us define

$$\eta = \frac{\bar{\eta}}{r}$$

to obtain
$$\frac{1}{c^2} \frac{\partial^2 \bar{\eta}}{\partial t^2} = \frac{\partial^2 \bar{\eta}}{\partial r^2}$$

with the known solution
$$\bar{\eta} = f(\alpha \pm rt)$$

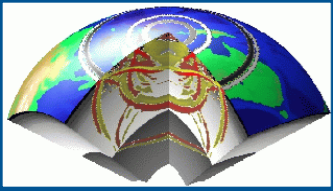

Geometrical spreading

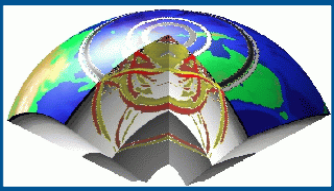

so a disturbance propagating away with **spherical** wavefronts decays like

$$\eta = \frac{f(\alpha \pm rt)}{r} \quad \eta \sim \frac{1}{r}$$

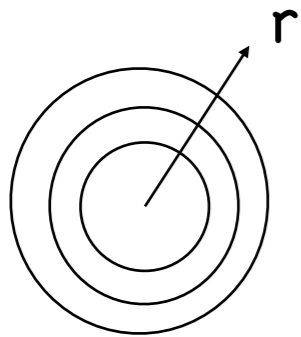

... this is the geometrical spreading for spherical waves, the amplitude decays proportional to $1/r$.

If we had looked at **cylindrical** waves the result would have been that the waves decay as (e.g. surface waves)

$$\eta \sim \frac{1}{\sqrt{r}}$$