



# **Università degli studi di Trieste**

## **LAUREA MAGISTRALE IN GEOSCIENZE**

**Classe Scienze e Tecnologie Geologiche**

### **Curriculum: Esplorazione Geologica**

**Anno accademico 2024 - 2025**

## **Analisi di Bacino e Stratigrafia Sequenziale (426SM)**

**Docente: Michele Rebesco**



# **Analisi di Bacino e Stratigrafia Sequenziale (426SM)**

## **Unit 1.3 Basin Formation Mechanisms and Structure**

**Docente: Emanuele Lodolo**

# **BASIN FORMATION MECHANISMS AND STRUCTURE**

- **Definition**
  - **Mechanisms of basin formation**
    - **Basin classification**
  - **Examples of basin geometry and structure**
- **Data + Methods in basin studies (modelling)**
  - **Summary**

## What is a basin in the geologic context?

**Repository for sediment formed by crustal subsidence relative to surrounding areas**

**Basins have many different shapes, sizes and mechanisms of formation**

**Vertical movements (subsidence, uplift) in sedimentary basins are primarily a reaction to the deformation of lithosphere (\*) and asthenosphere (\*\*)**

*\*LITHOSPHERE: is the solid, outer part of Earth, and includes the crust and the brittle upper portion of the mantle*

*\*\*ASTHENOSPHERE: is the mechanically weak and ductile region of the upper mantle (from ca. 100 to 300 km in depth)*

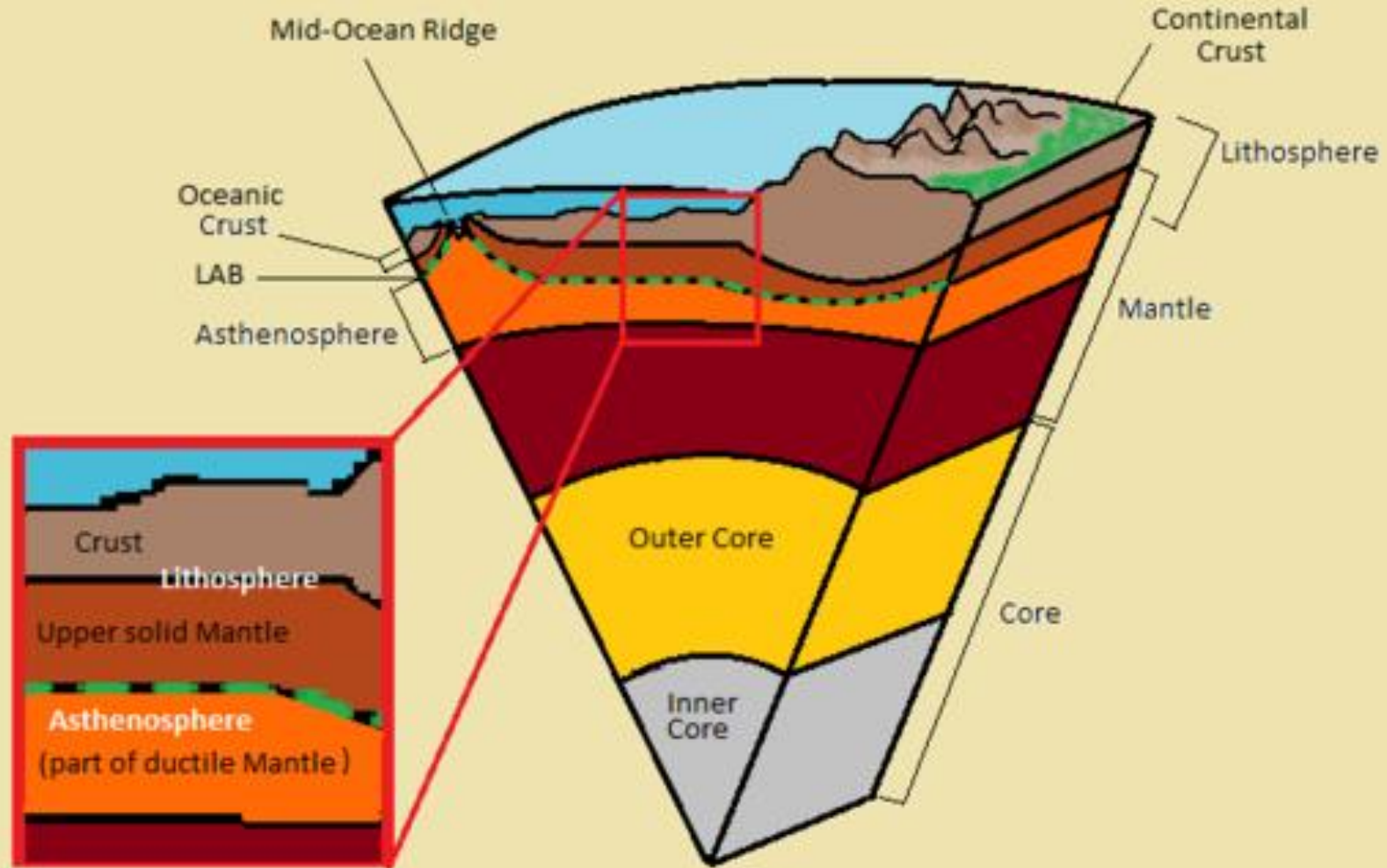

# **Plate-plate interactions can generate vertical crustal movements**

**Three types of plate boundaries exist:**

- **Divergent – plates moving apart (mid-ocean ridges, rifts)**
- **Convergent – plates moving towards each other (subduction zones)**
- **Conservative – plates move parallel to each other (strike-slip systems)**

Most (but not all) sedimentary basins occur in areas of active plate tectonics

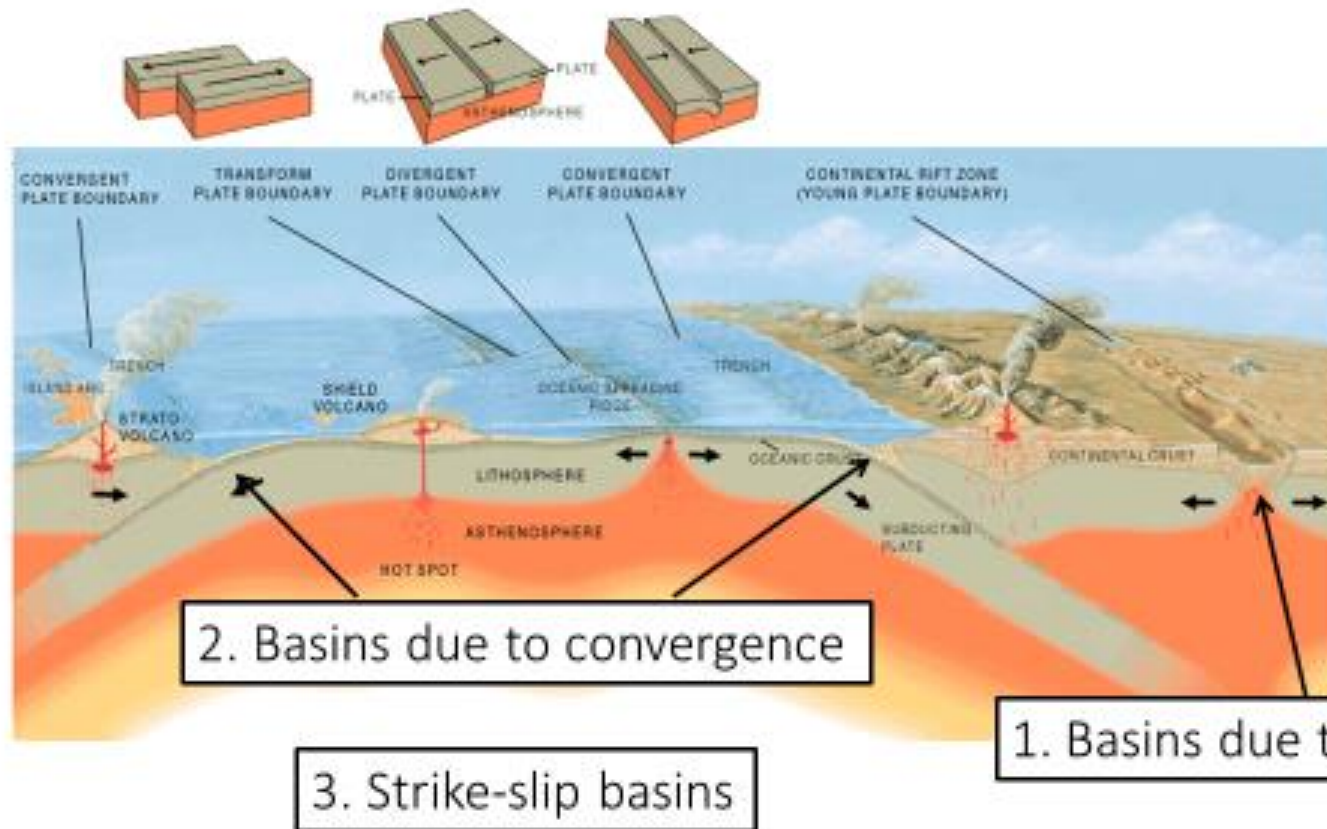

## Major physical mechanism for regional subsidence/uplift

Physical mechanisms of subsidence:

2. Flexure (also called regional isostasy)

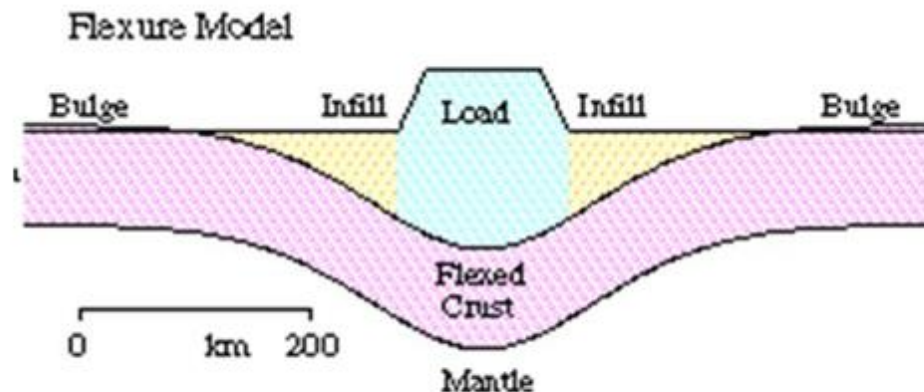

Earth's rigid lithosphere acts as an elastic plate. When loaded (by a mountain range, sediment column, other tectonic plate), it flexes.



# Basin classification

**Many different classification systems have been proposed, on the basis of:**

- **Position of the basin in relation to plate margins**
- **Crustal/lithospheric substratum**
- **Oceanic, continental crust**
- **Type of plate boundary**

**\* In this course: focus on basin-forming processes**

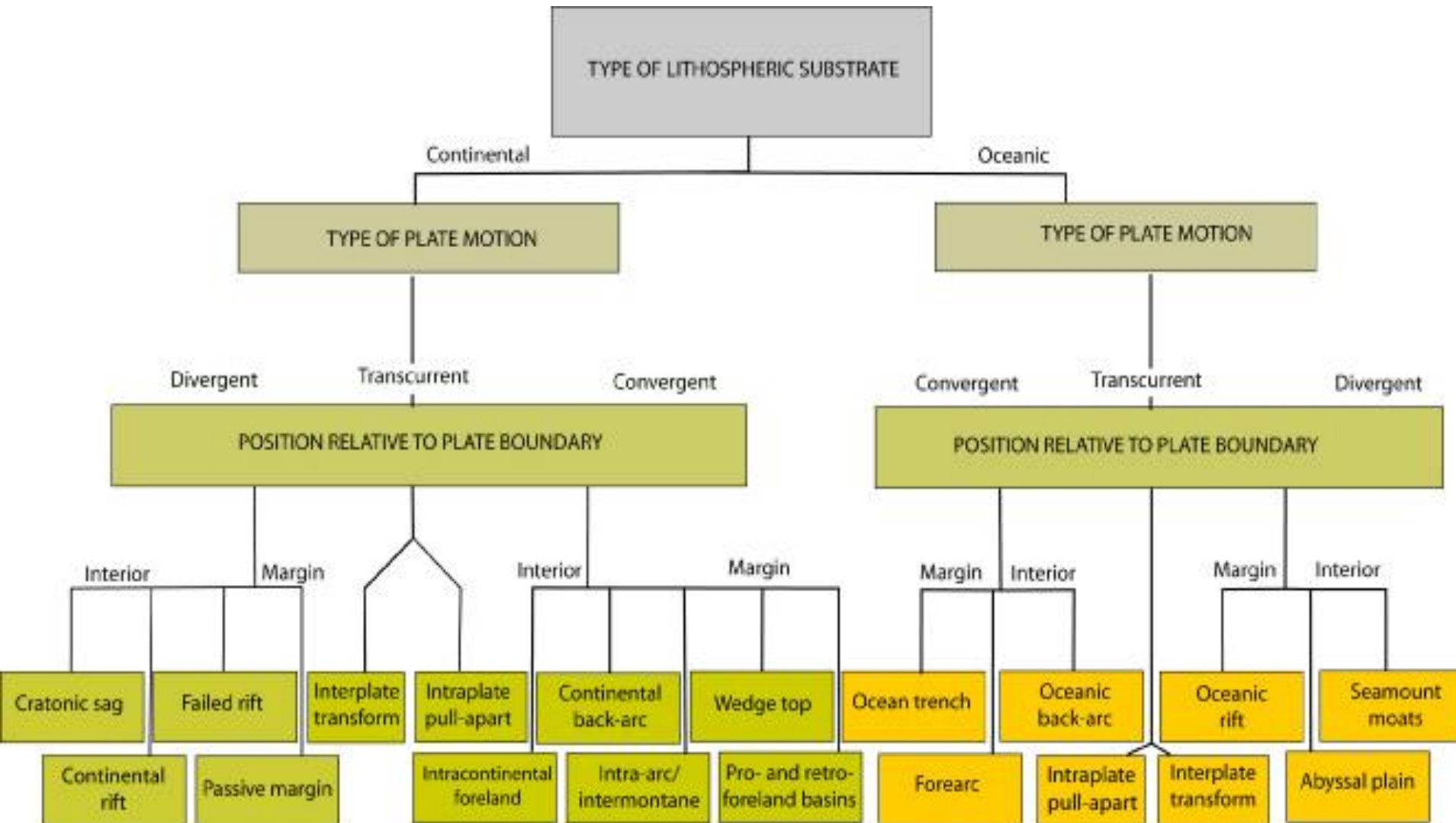

# Divergent plate boundaries

Continental rifting may lead to opening of an ocean with a mid-ocean ridge

Rift basin evolves into passive margin

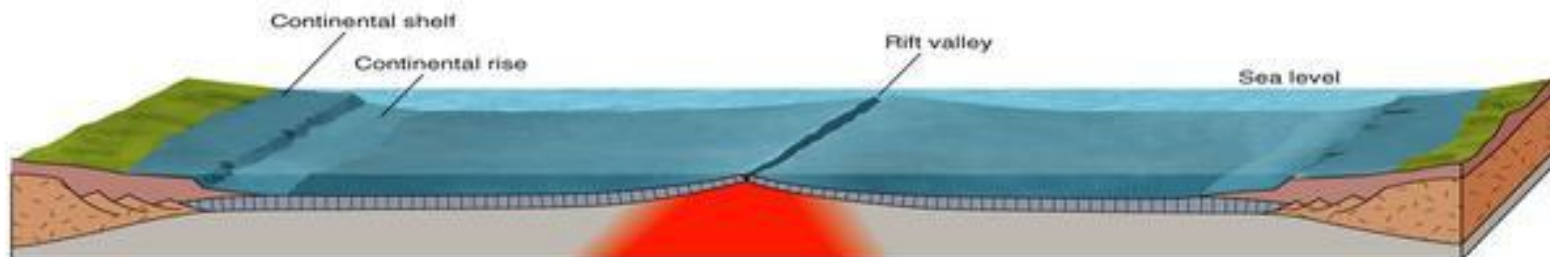
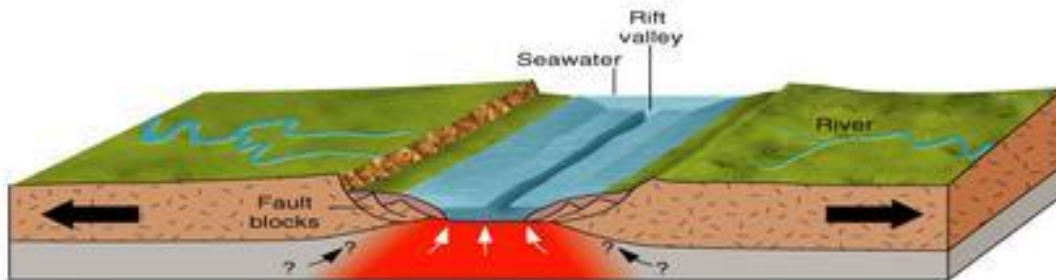
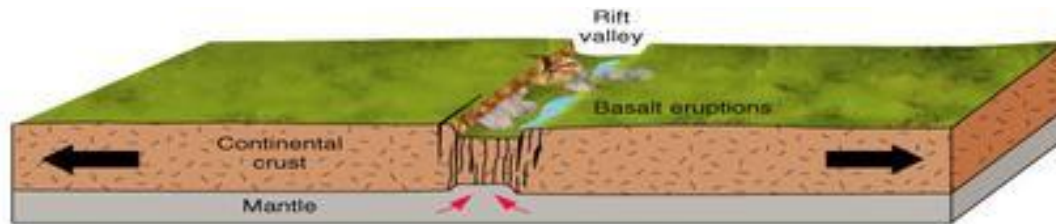

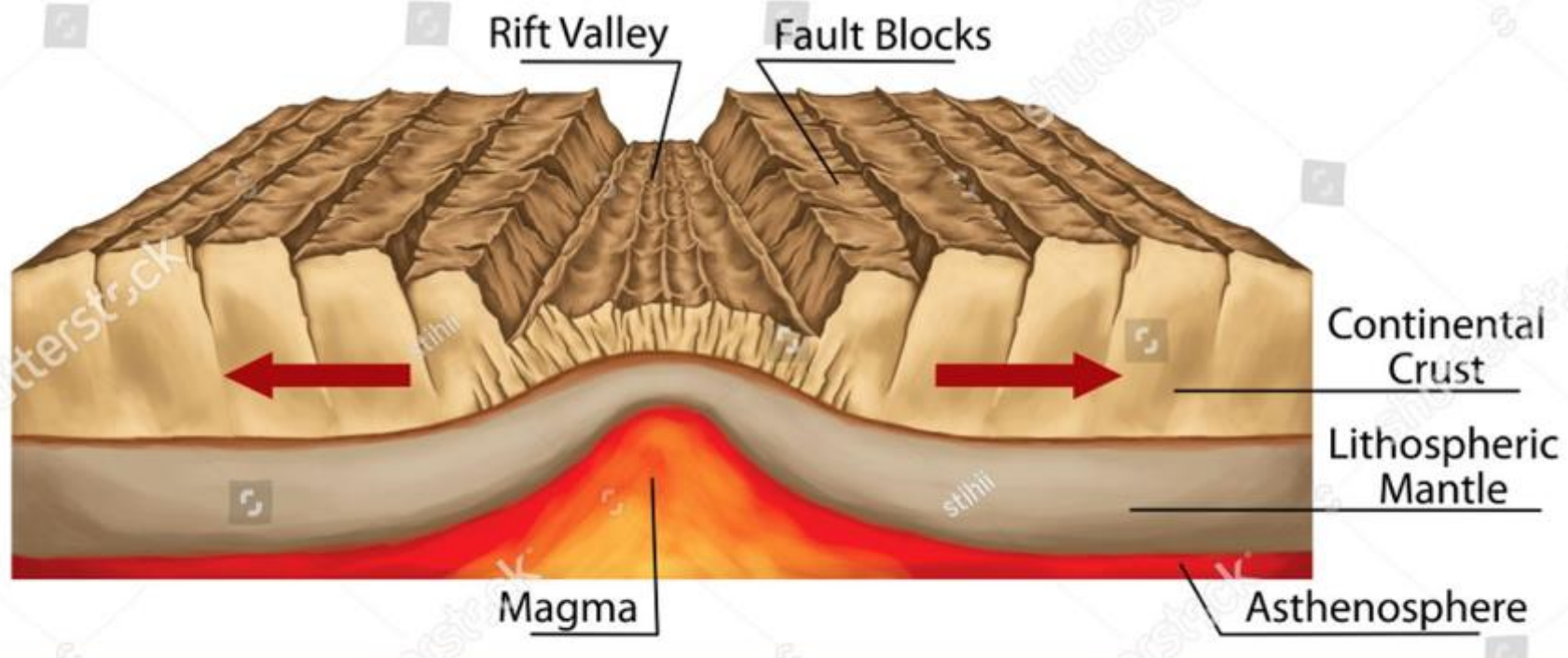

**Rift basins are characterized by elongate valleys bounded by normal faults  
(few km -> 10s of km wide)**

**(length – up to 1000s of km)**

**Occur in many plate settings, but most common in divergent settings**

**Seismic studies indicate rifts overlie thinned crust (evidence for thermal anomalies at depth - negative Bouguer gravity anomalies - high heat flow)**

### A. Active rifting

Mantle upwelling causes crustal thinning (heating) that leads to uplift  
Then, uplift leads to tension and rifting

### B. Passive rifting

Regional extension causes failure, so hot mantle rocks rise and penetrate  
lithosphere

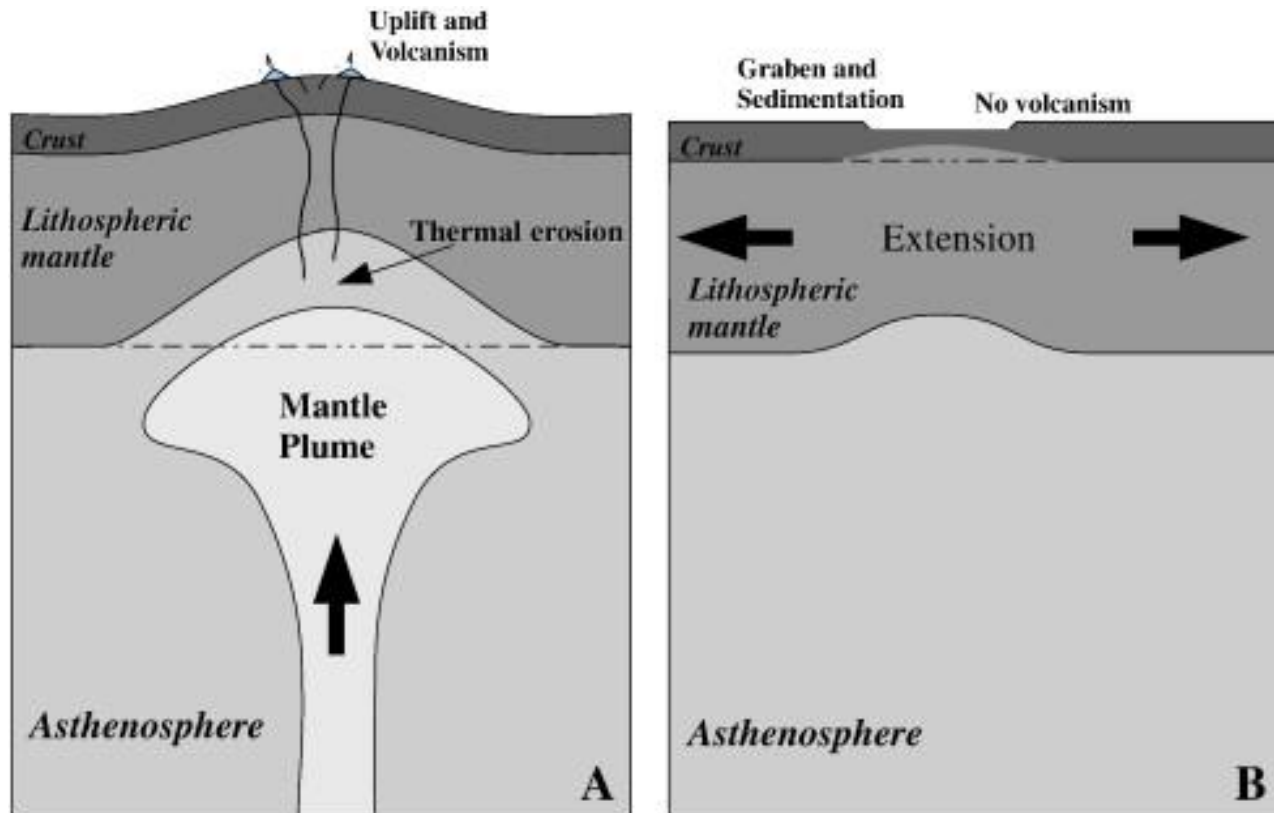

# Example of a passive rift (Rio Grande Rift)

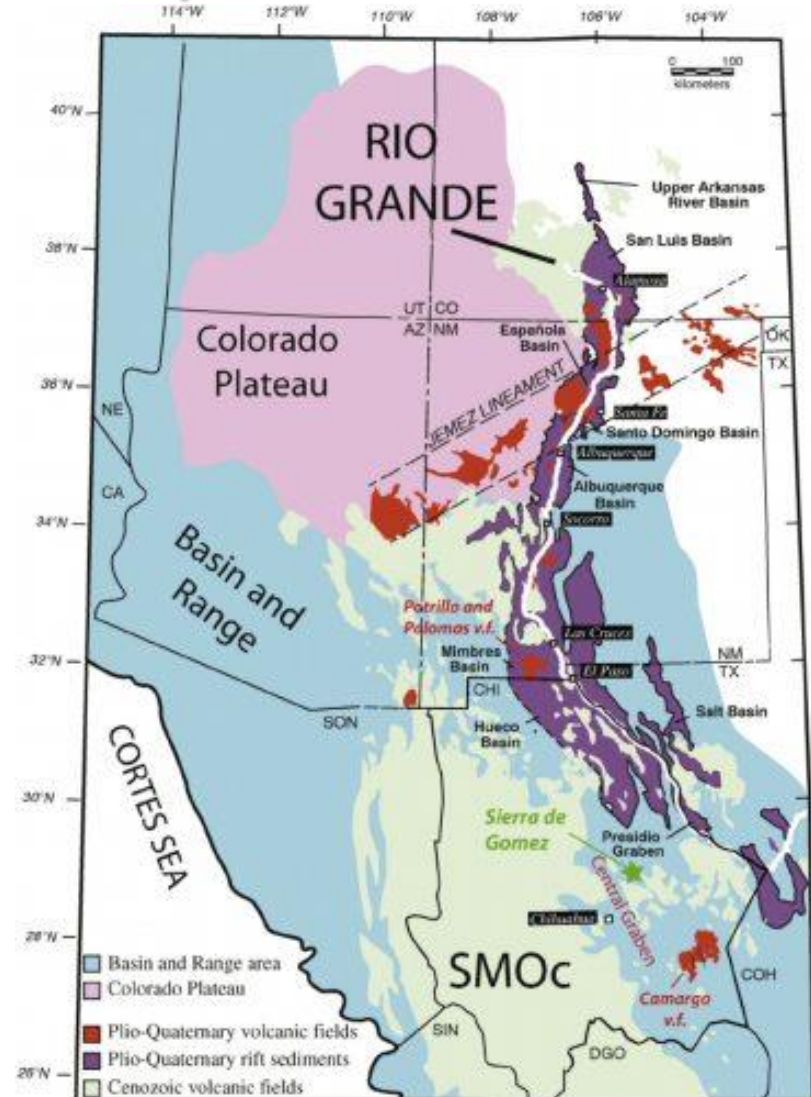
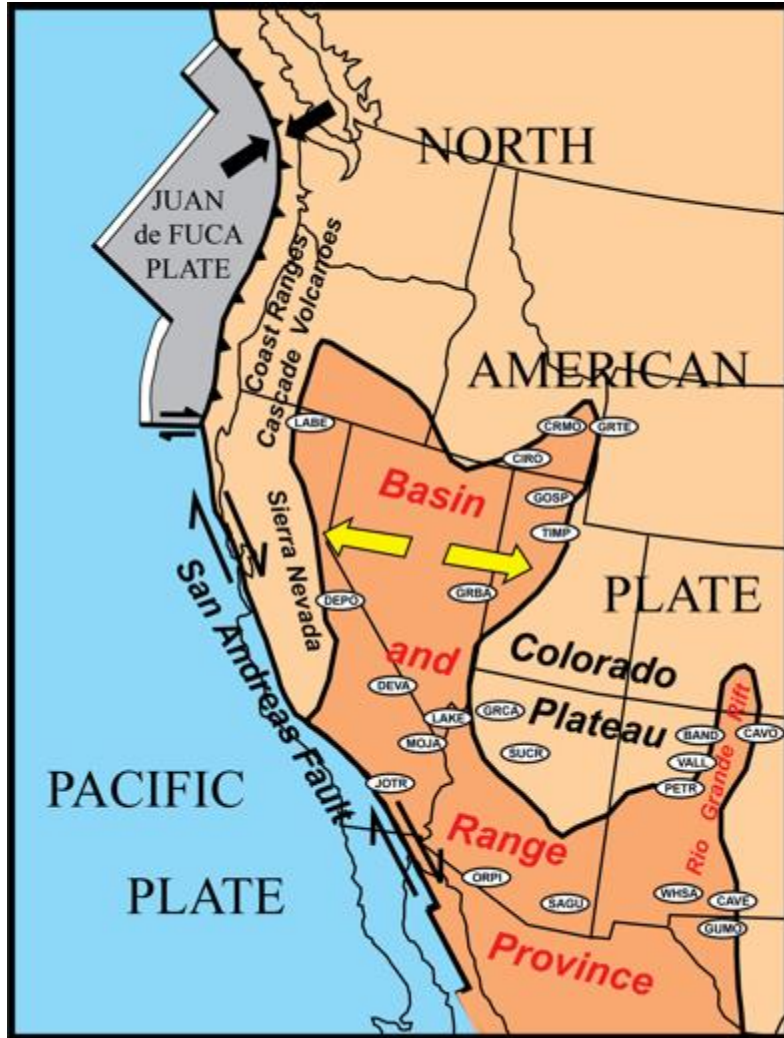

# Example of an active rift (East African Rift)

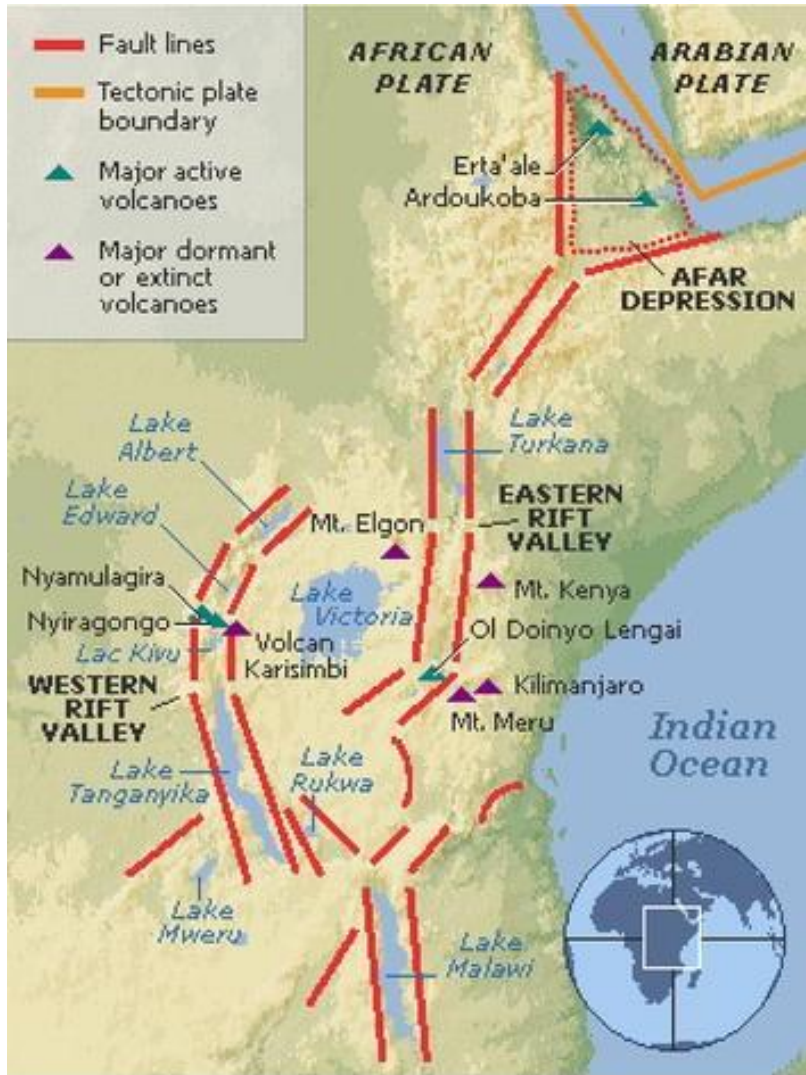

# Baikal rift

M. Graffoulière, 2004, after Soviet topographic and bathymetric maps 1/200000 (courtesy L. Touchart) and GLOBE-NGDC

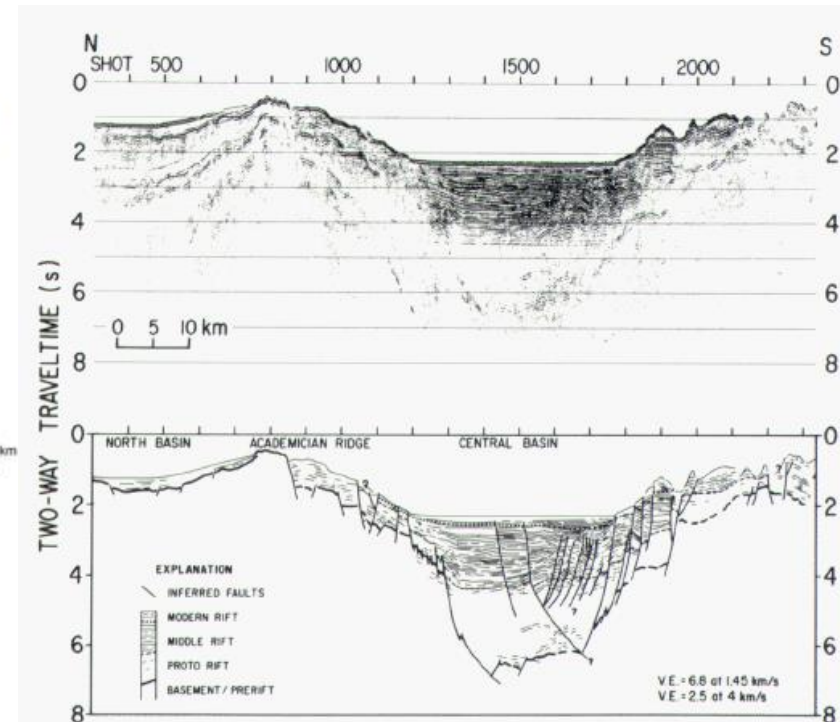
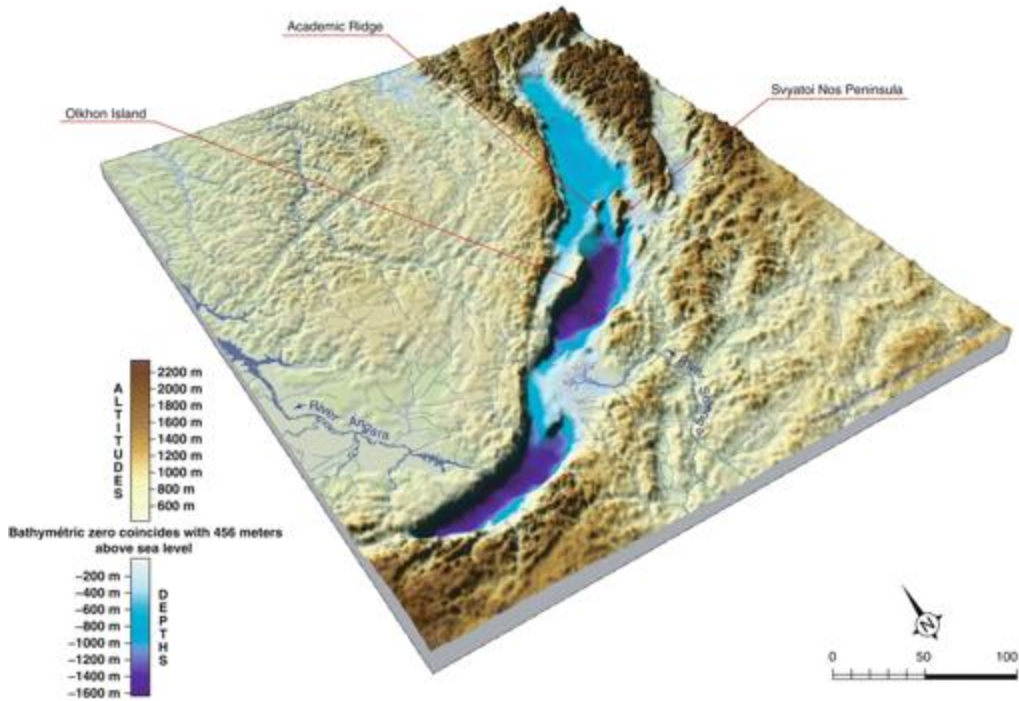

Multichannel seismic reflection line across central part of Lake Baikal showing seismic data (top) and interpretation (bottom). The thickest deposits are confined to a narrow trough that is 15 to 20 kilometers (9 to 12 miles) wide.



# Sicilian Channel Rift System

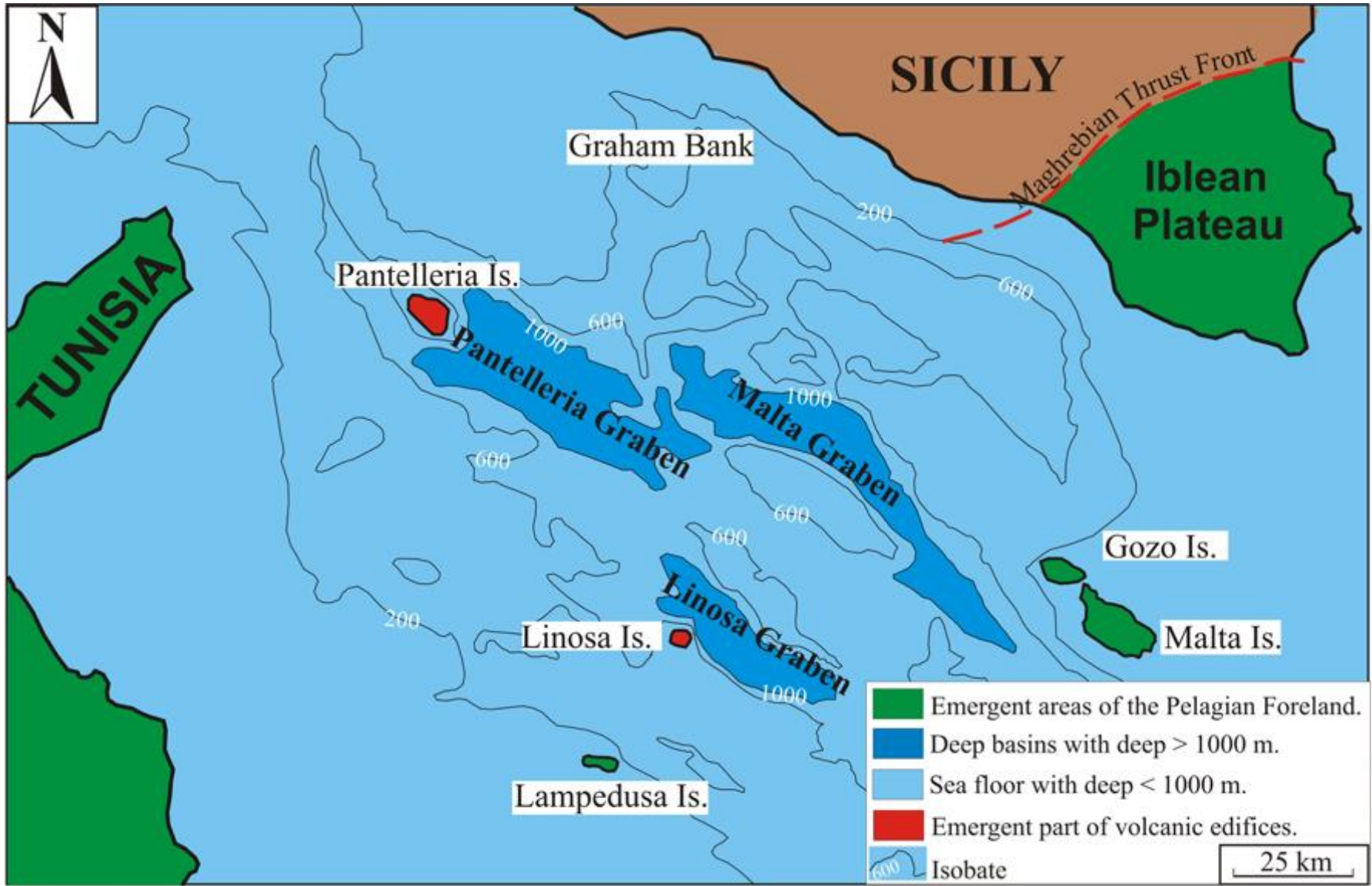

# Linosa graben

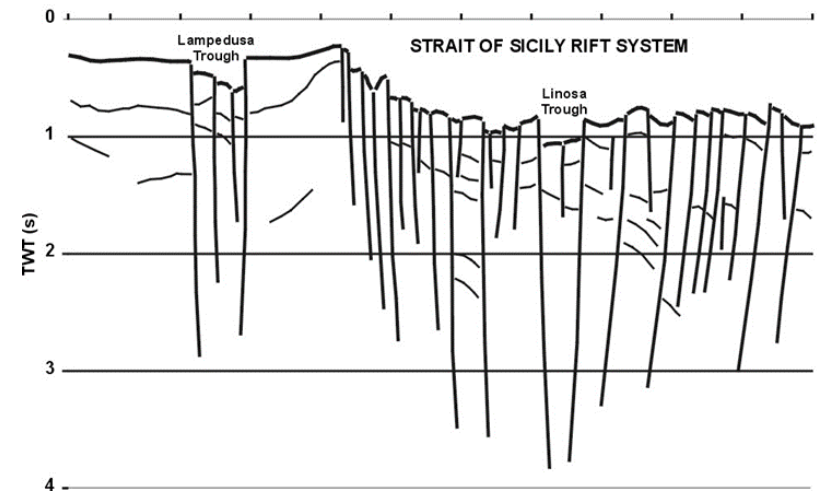
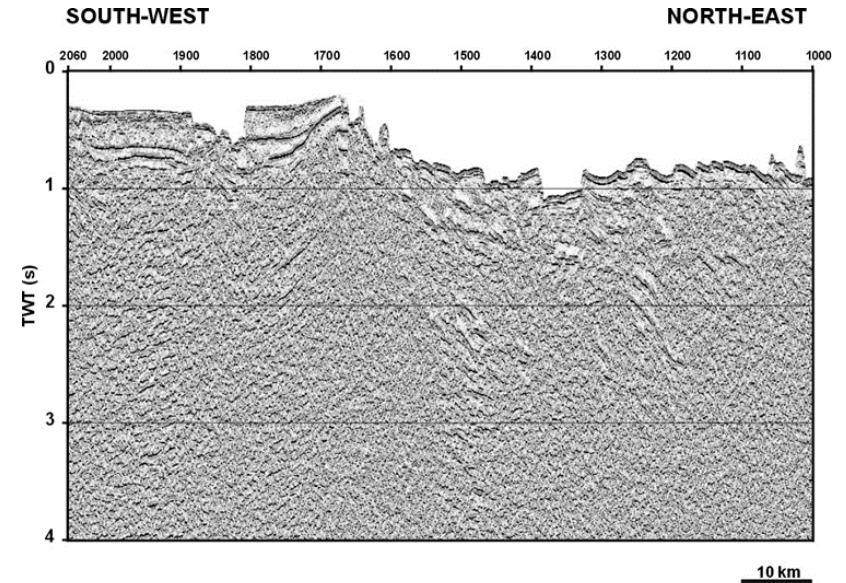
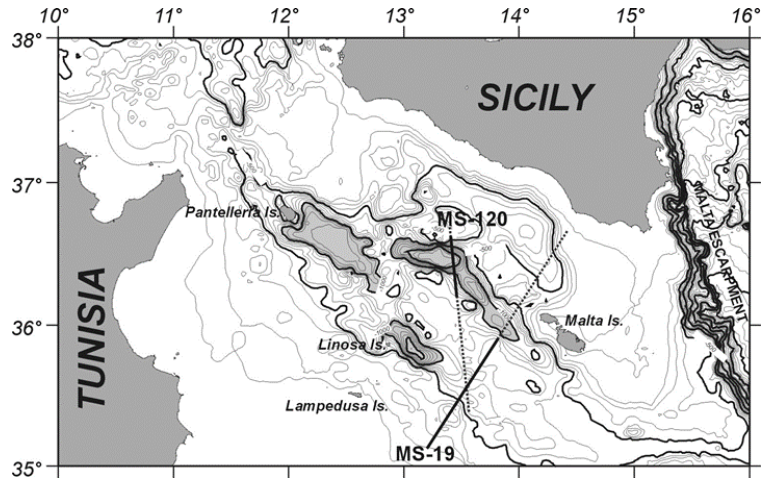

# Malta graben

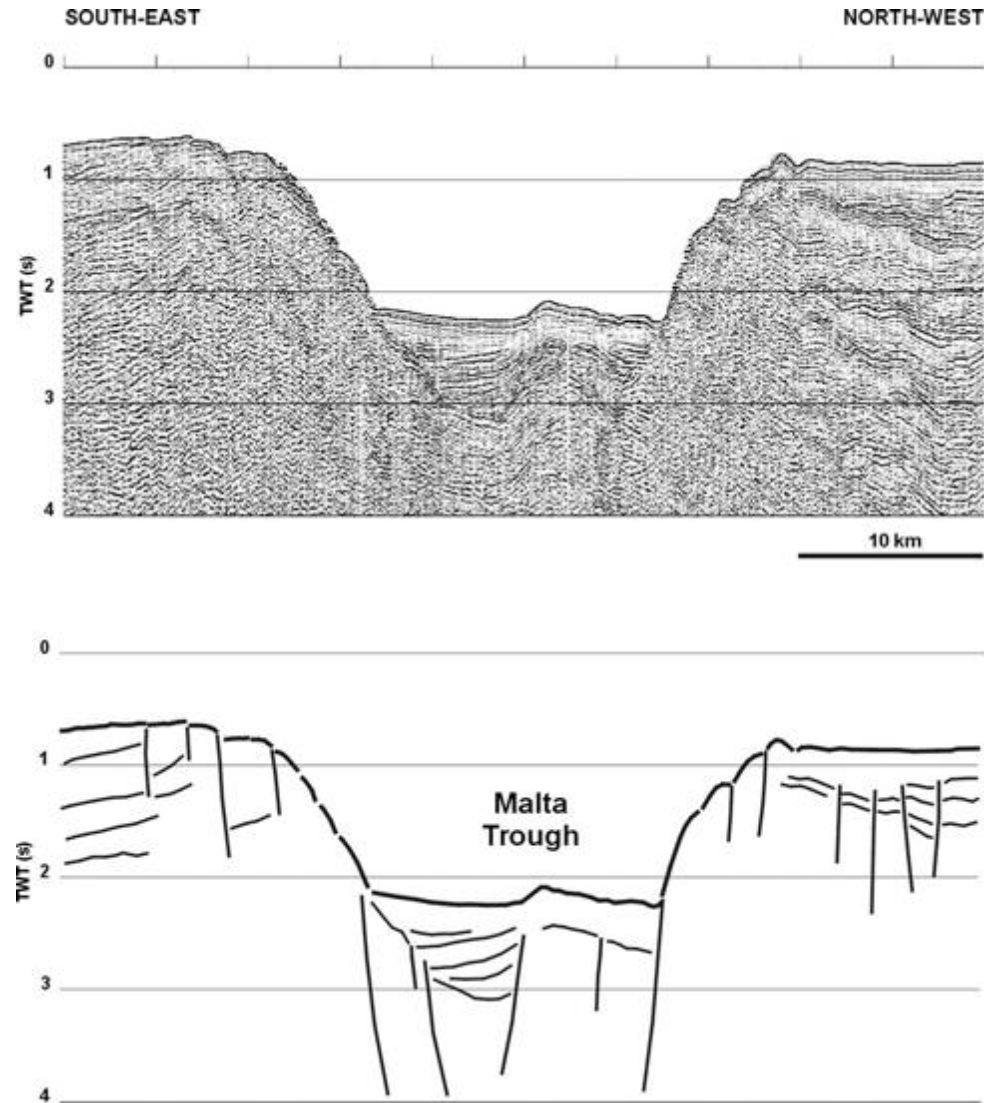
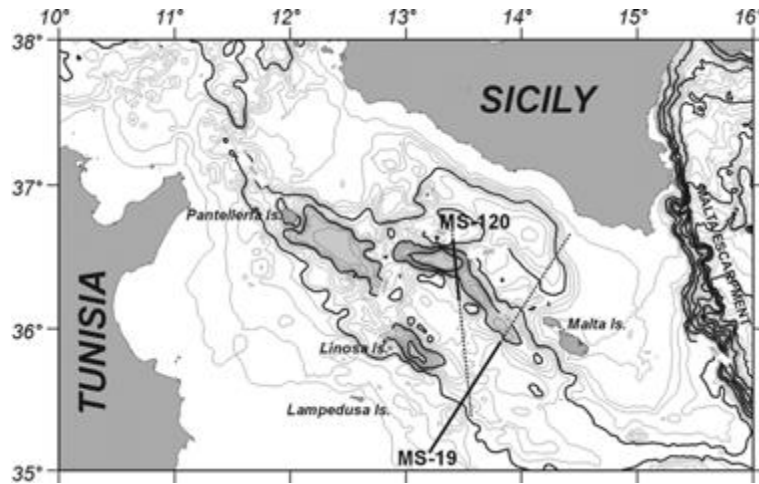

# Pantelleria graben

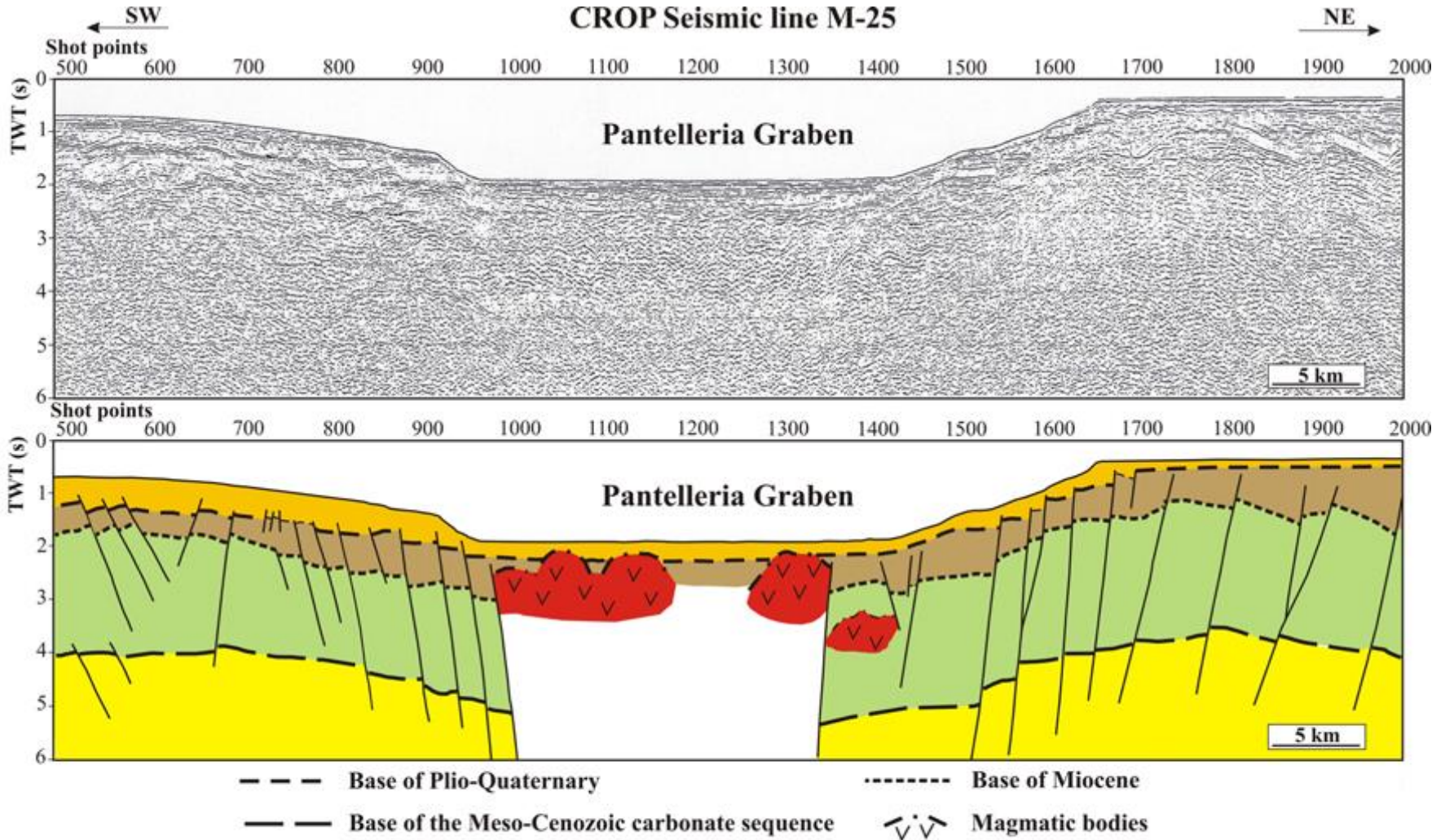

**In rift basins, fill commonly consists of “continental” deposits (fluvial, lacustrine, alluvial fans). In some cases, evaporites may form if rift valley/basin is located in a hot, dry and closed area (e.g., the Messinian Salinity Crisis occurred in the Mediterranean Basin about 5 million years ago).**

**Volcanic rocks, and associated intrusions, may also be present in rift basins**

# Messinian palaeogeography



# MIOCENE SALINITY CRISIS

## Miocene Sup. (5.9 - 5.3 Ma)

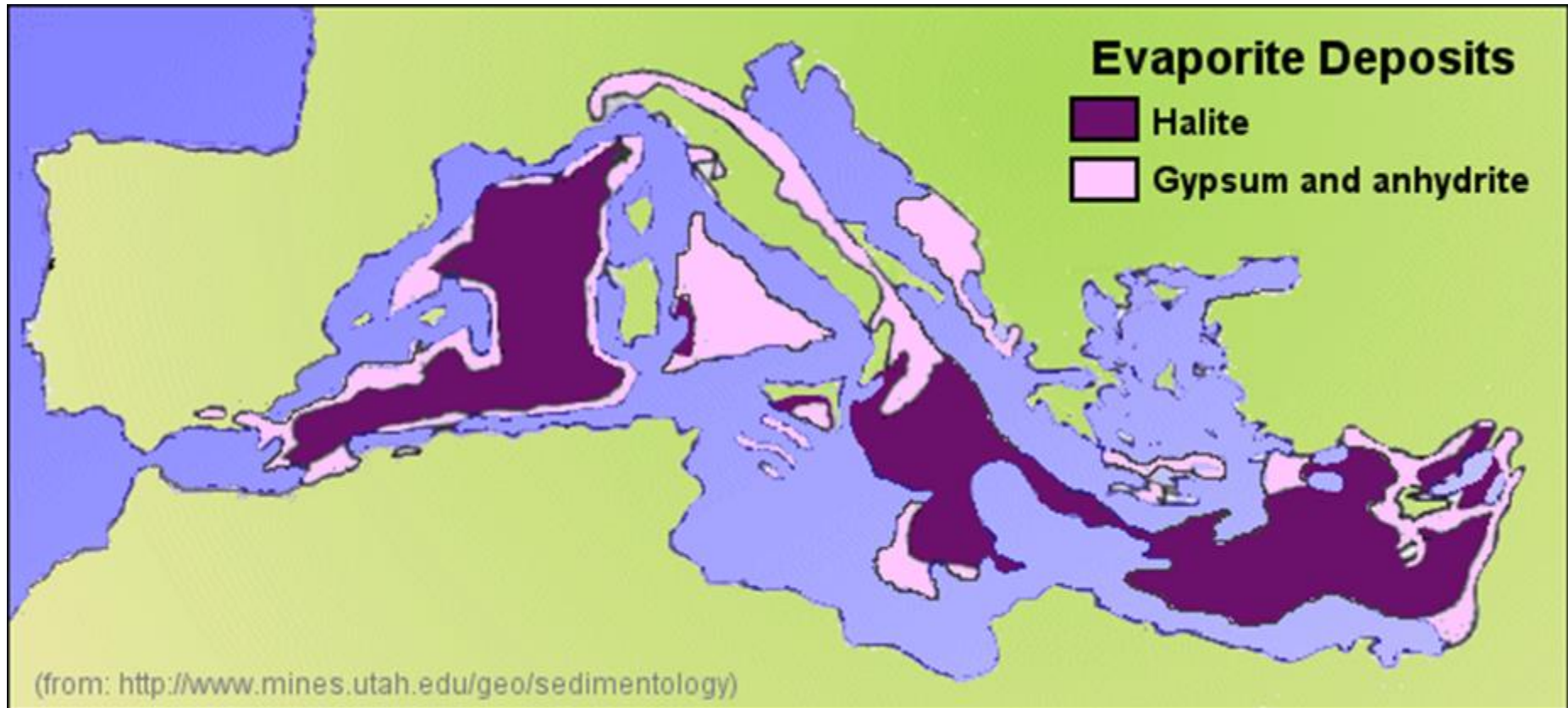

## «Oceanization» of a basin

Continued rifting can lead to formation of oceanic crust (i.e., opening of an ocean basin).

One typical example is the Red Sea

The rift-drift transition may be marked by a “breakup unconformity”, often visible on seismic profiles

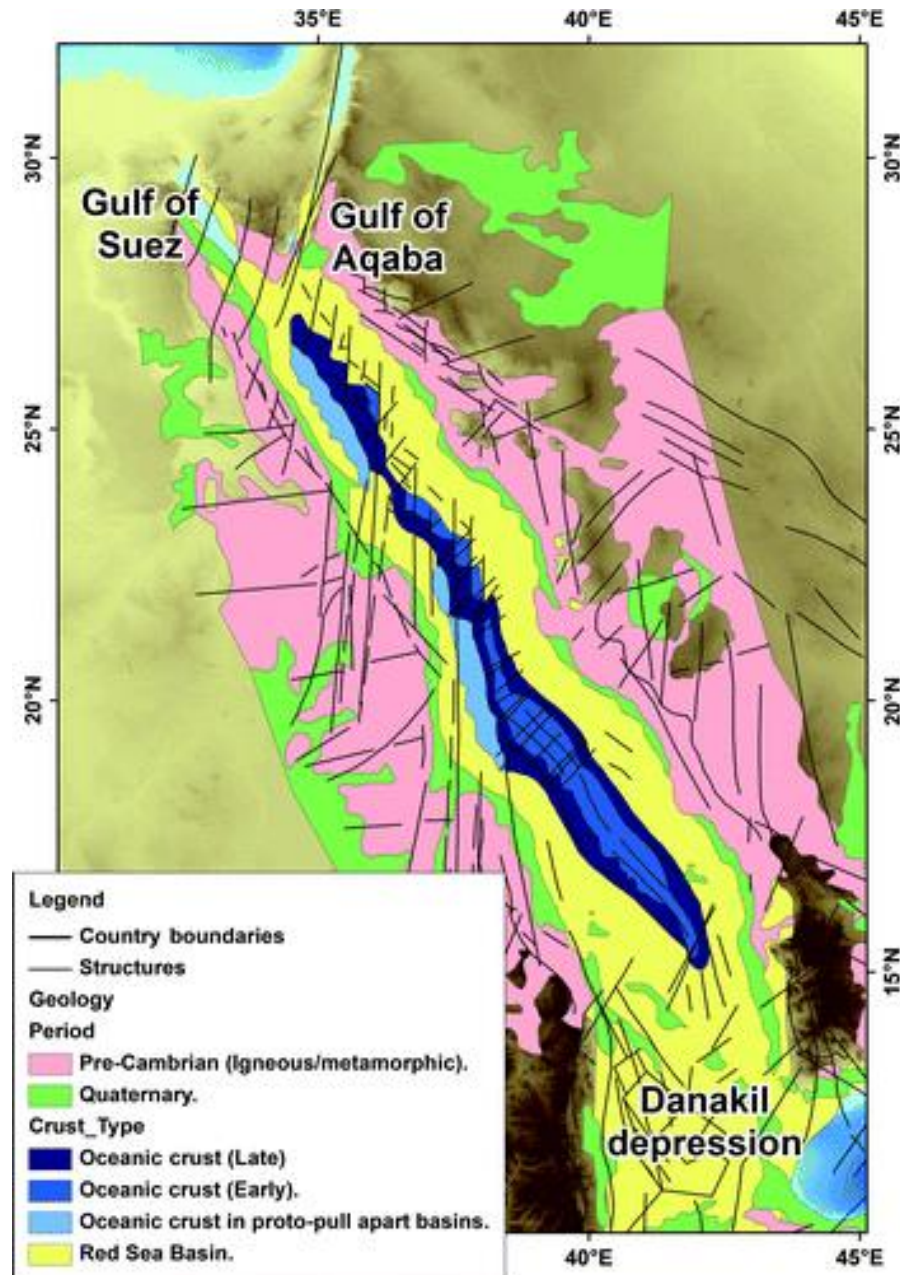



# Passive margin sedimentary basins

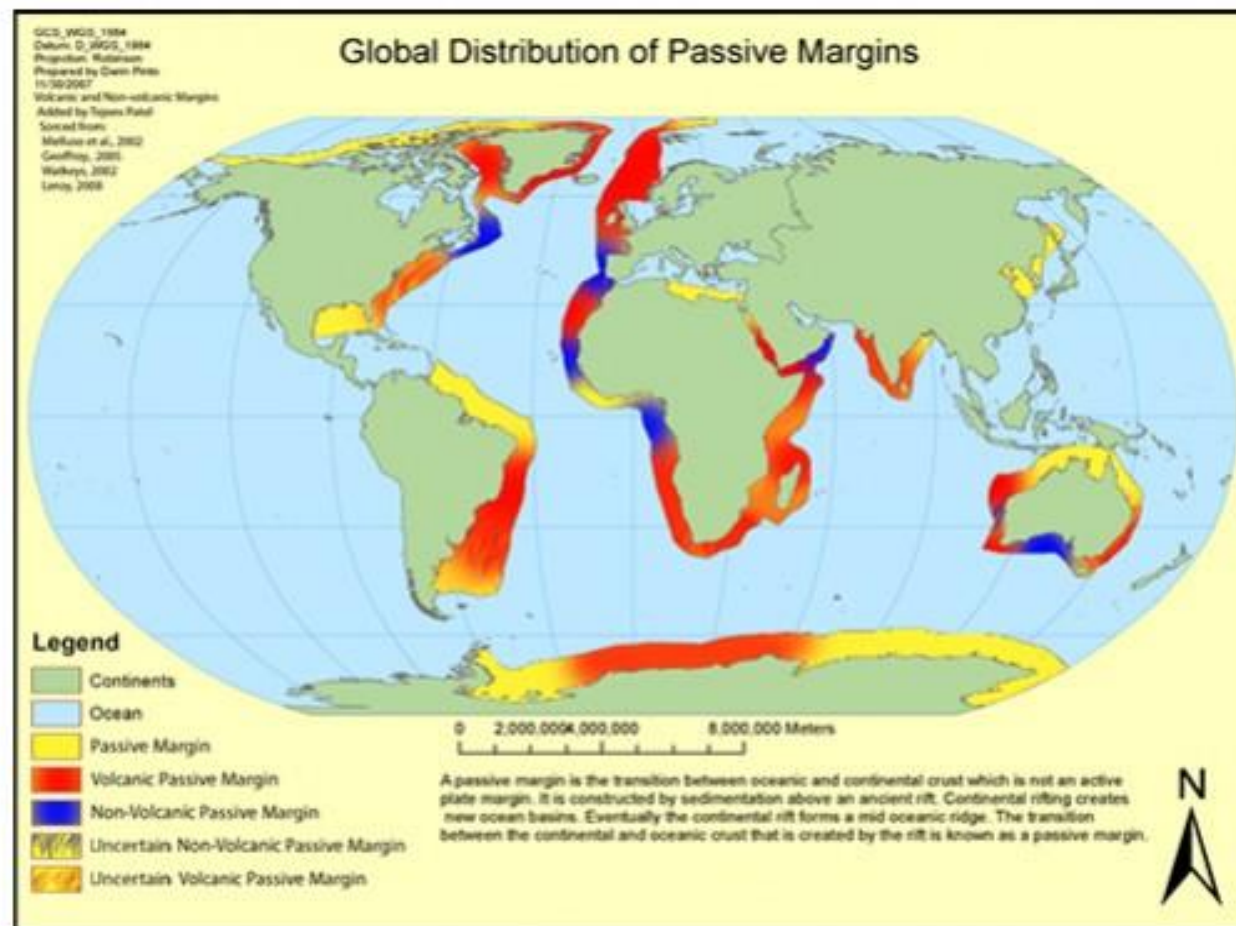

# Passive margin sedimentary basins

Morphology of margin basins is characterized by shelf, slope and continental rise.

Shelf sediments can be clastic or carbonate.

Strongly attenuated continental crust stretched over distances of 50-500 km

Overlain by seaward-thickening sediment prisms (shallow-marine deposits)

Sometimes referred to as “Atlantic-type margins”

Main mechanism for subsidence is the thermal contraction following lithospheric thinning

Subsidence rate increases in offshore direction

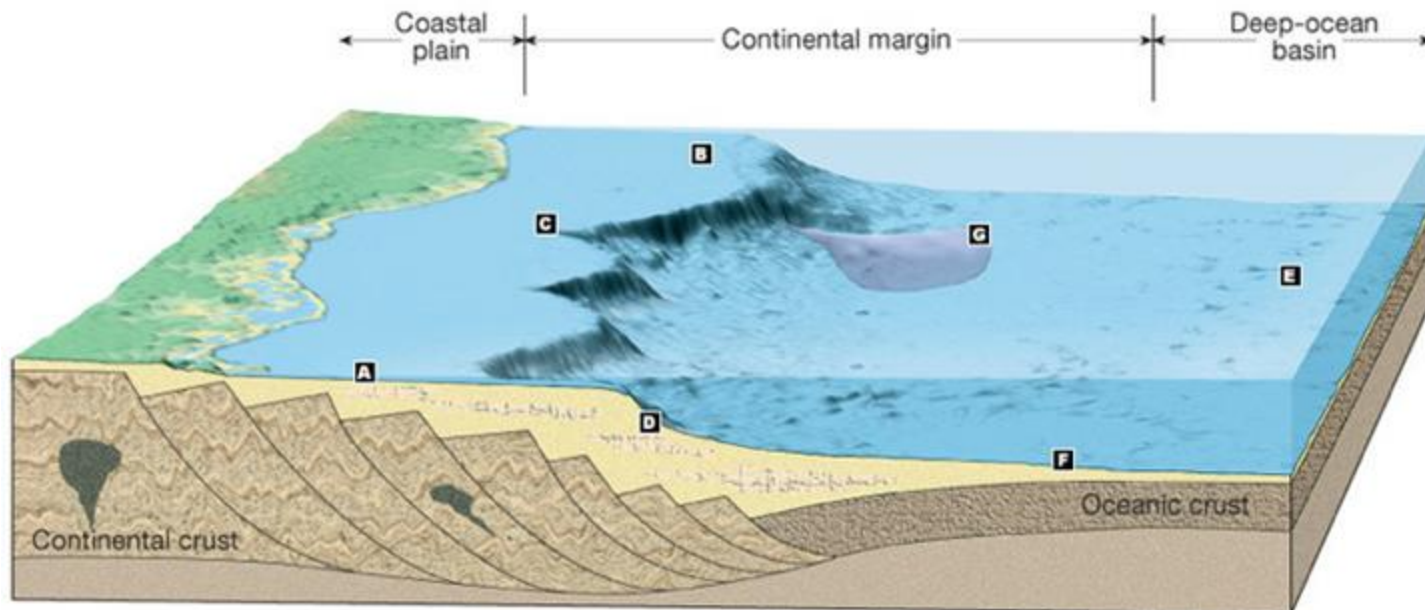

# Crustal architecture of a passive margin as seen on seismic profiles

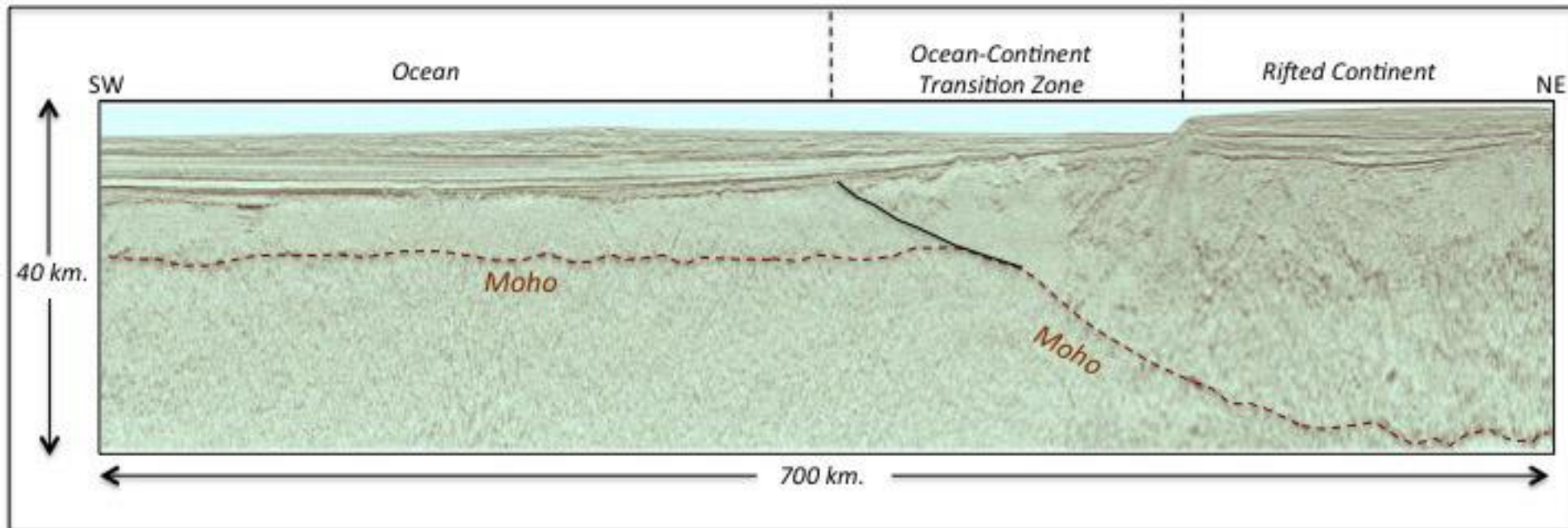

# East India Margin

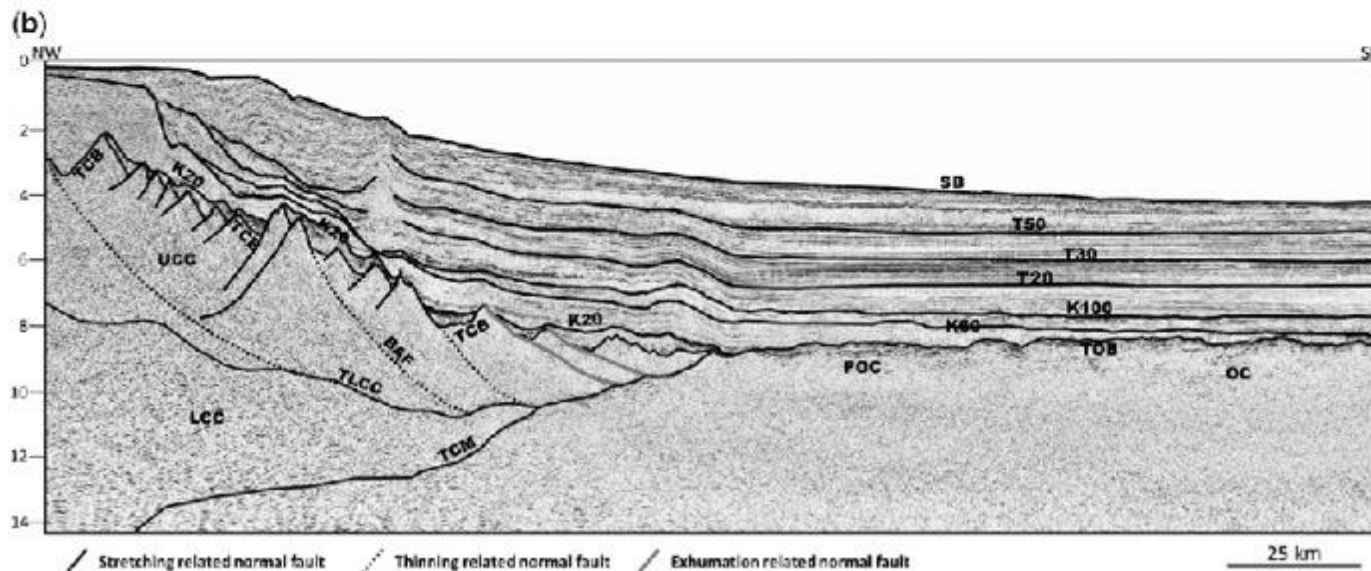
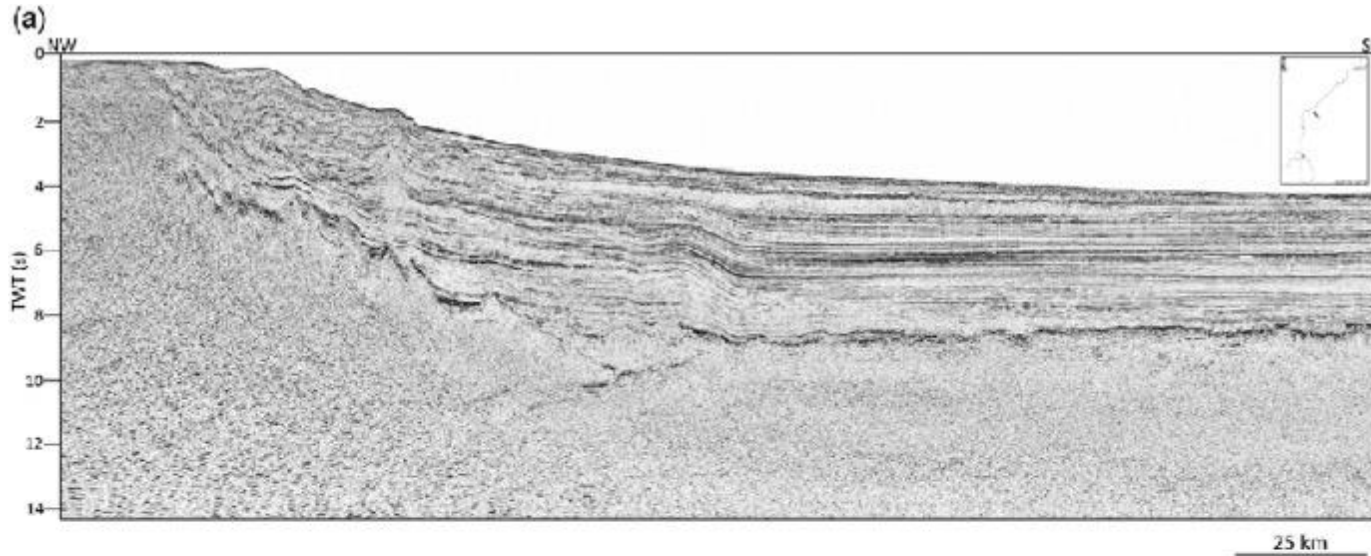

# AULACOGENS

“Failed rifts” which occur at high angle to continental margin

Fill: non-marine to deep marine

Example: Reelfoot Rift (Mississippi Valley)

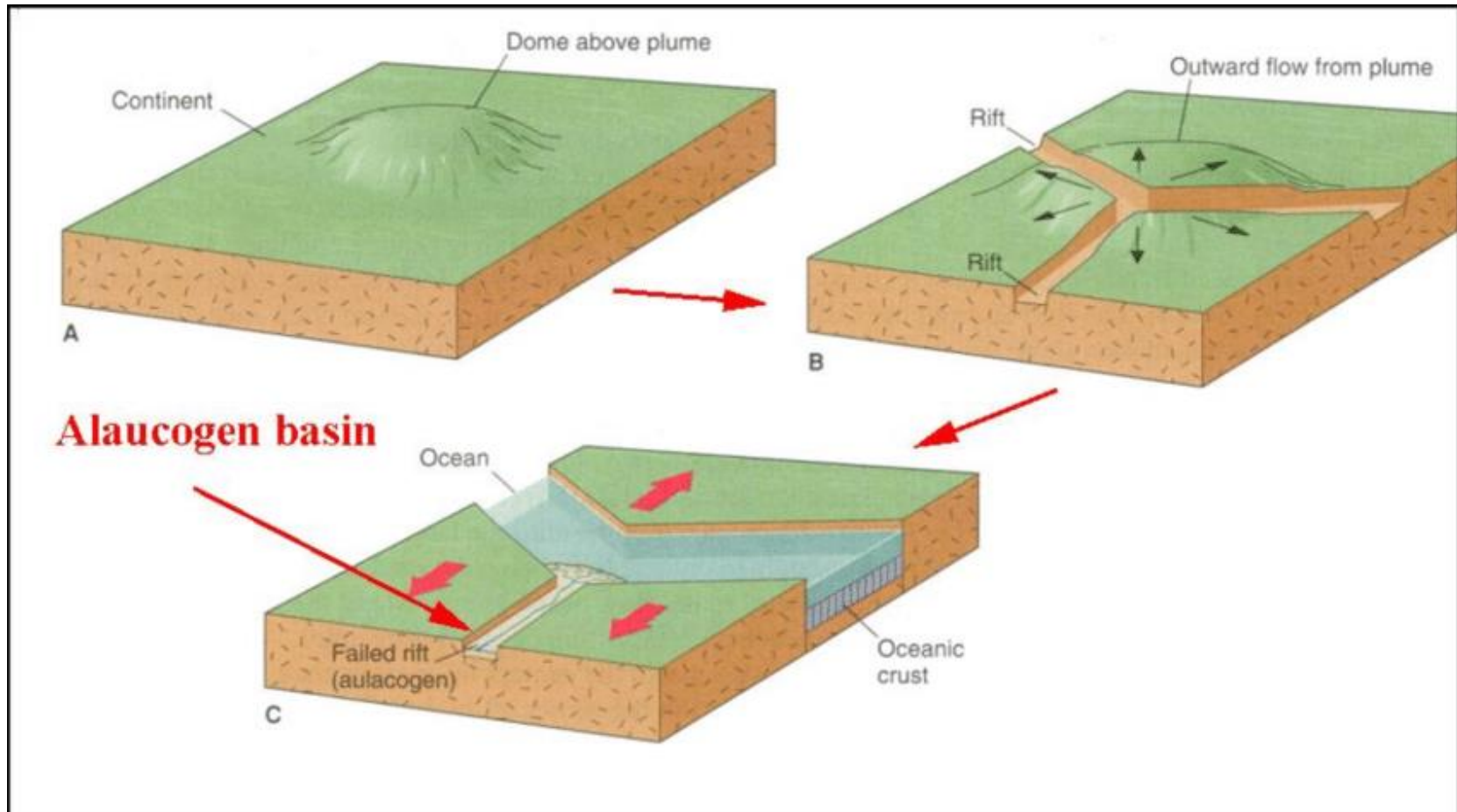

# Basins on Convergent Plate Boundaries

(Subduction of oceanic plate may lead to closing of ocean basin and ultimately to continental collision)

**Cooler oceanic plate subducts underneath island arcs (also oceanic crust), creating a deep sea trench**

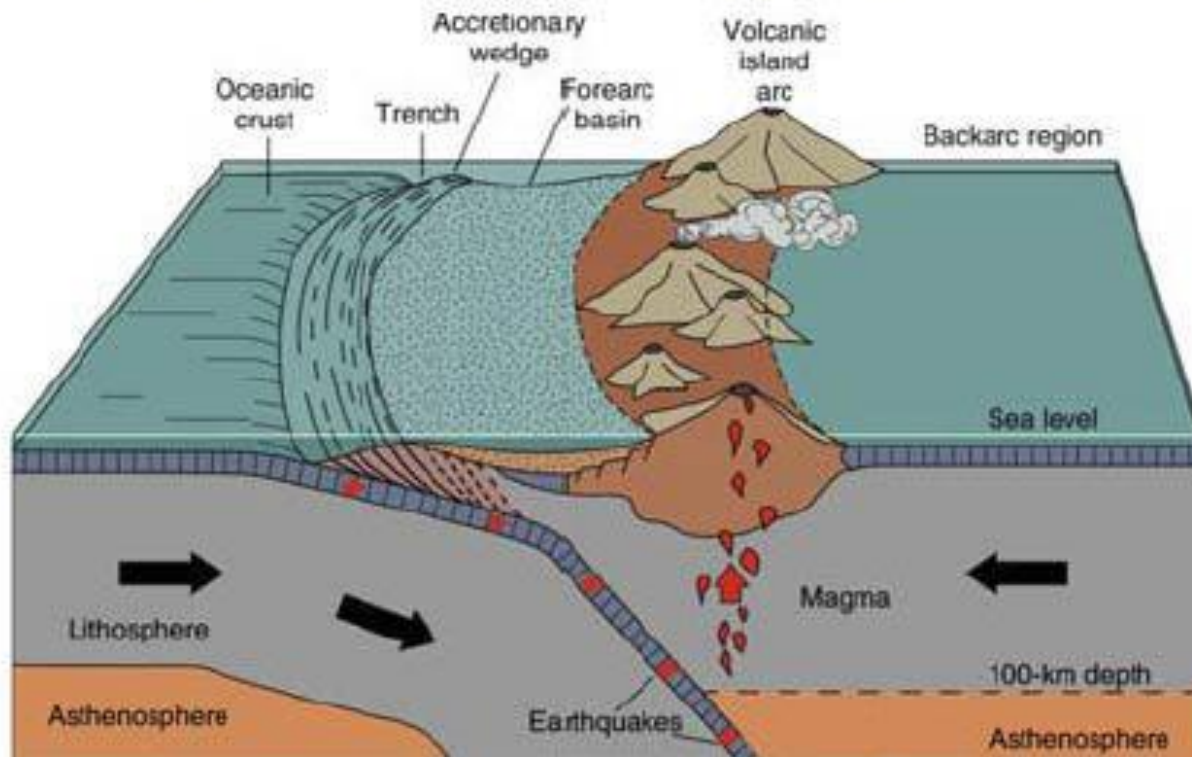

**Age of oceanic crust affects angle at which it is subducted**

**Young crust – shallow angle subduction, compression behind arc**

**Old crust – steep angle subduction, “roll-back”, extension behind arc**

Ensimatic island arc: Mariana Islands

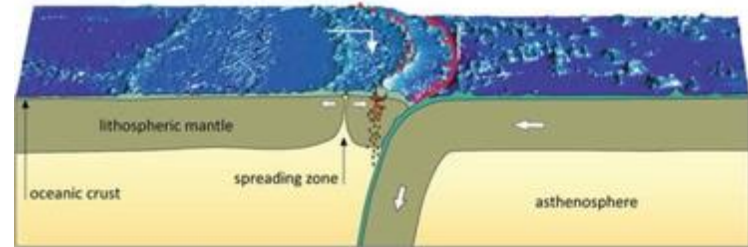

Ensilalic island arc: Japan

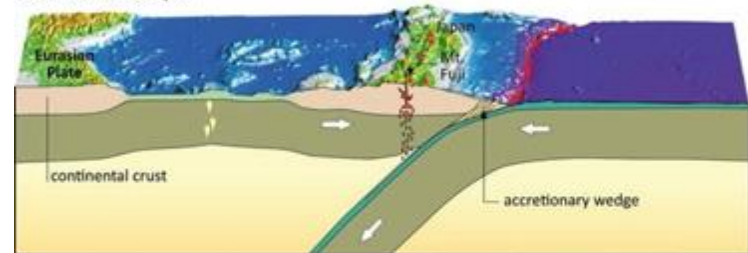

Active continental margin: Andes

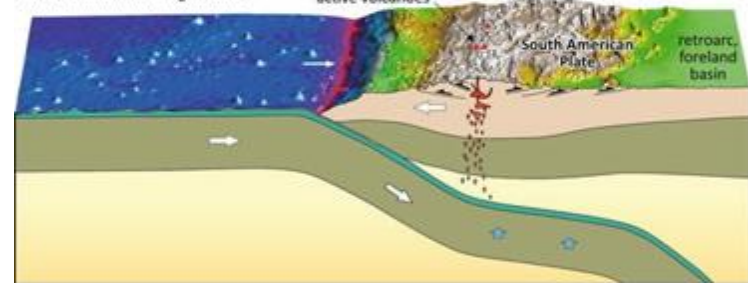

Continent-continent collision: Himalayas

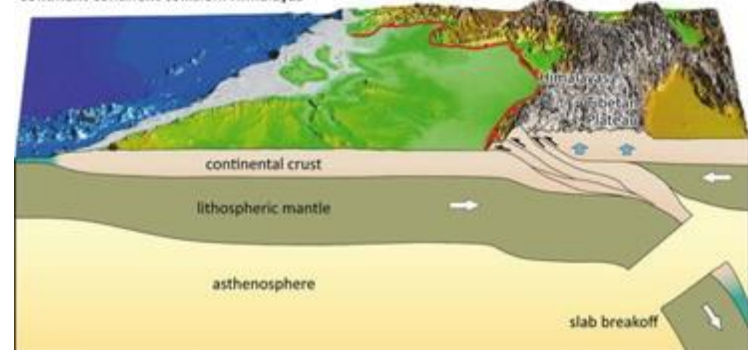

**Forearc basin is the area between the accretionary wedge and the magmatic arc**

**Forearc and back-arc basins are dominated by sediment derived from arc**

**Deep-sea trench has sediments derived from arc and sediments scraped off subducting oceanic crust (melange)**

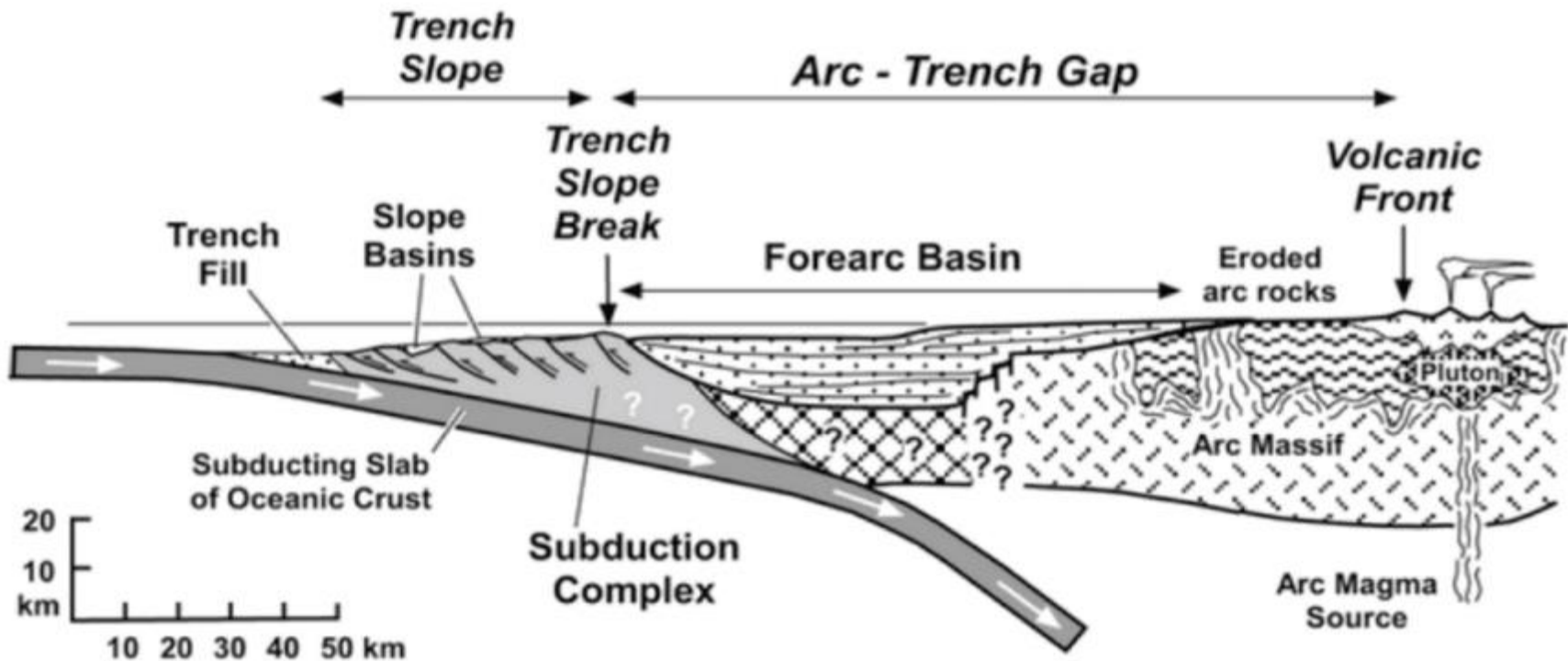



# Subduction complex off Japan

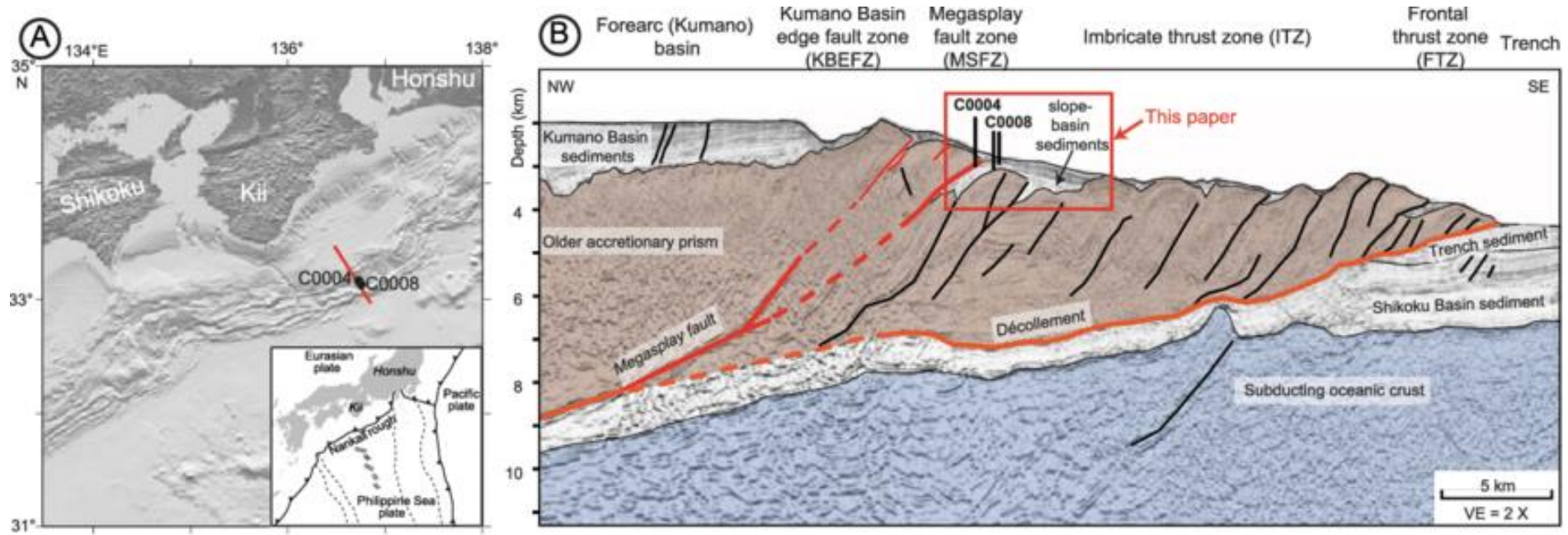

# Calabrian Arc

Deformation is related to an imbricate fan within the post-Messinian salt-bearing accretionary wedge, out-of-sequence thrust faults in the pre-Messinian wedge and normal faults in the inner plateau.

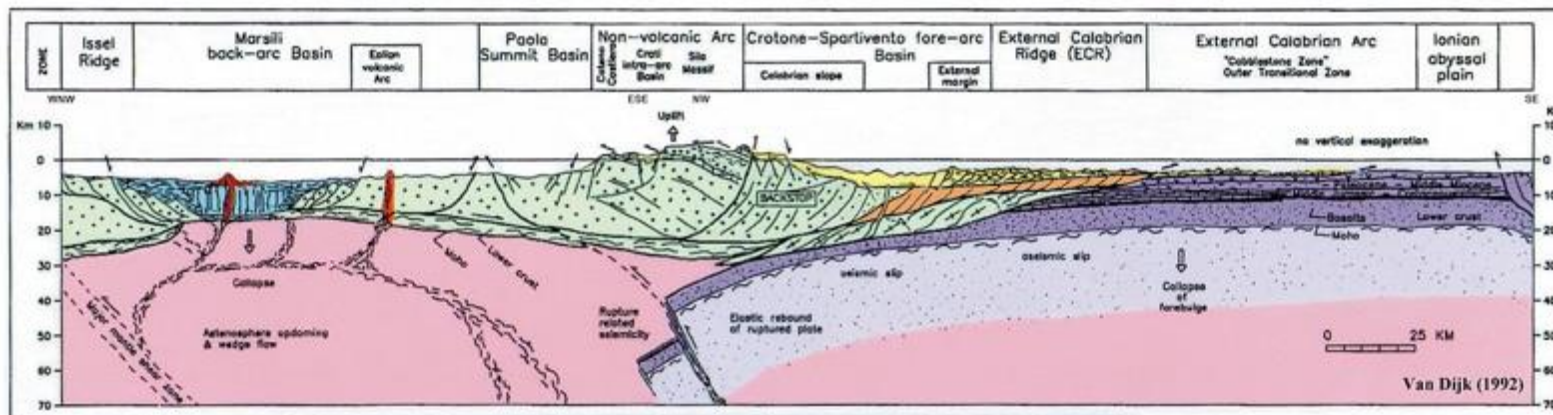
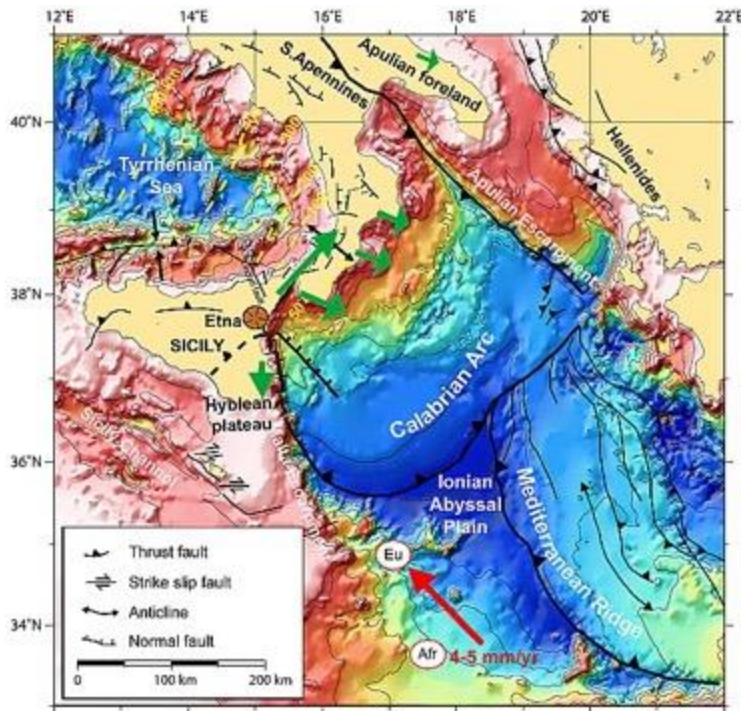

# Bransfield Strait back-arc basin

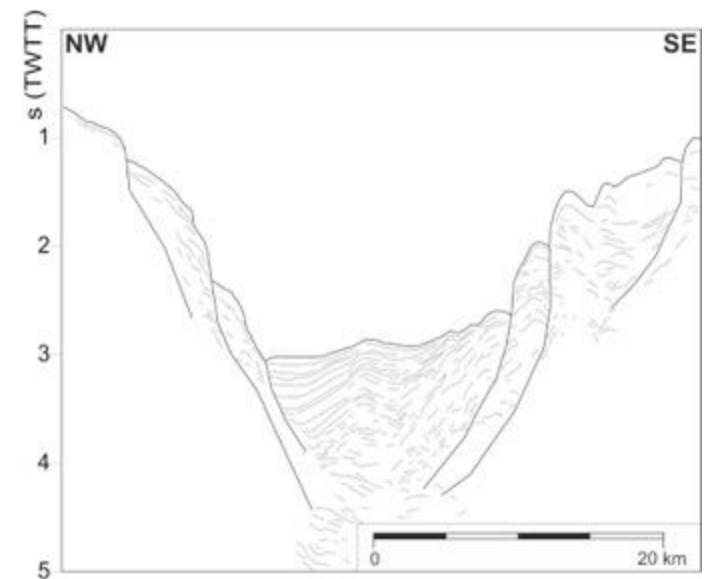
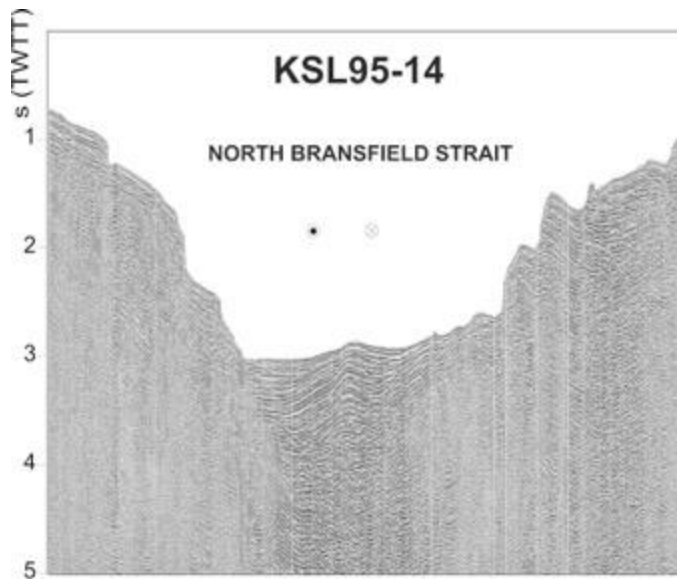
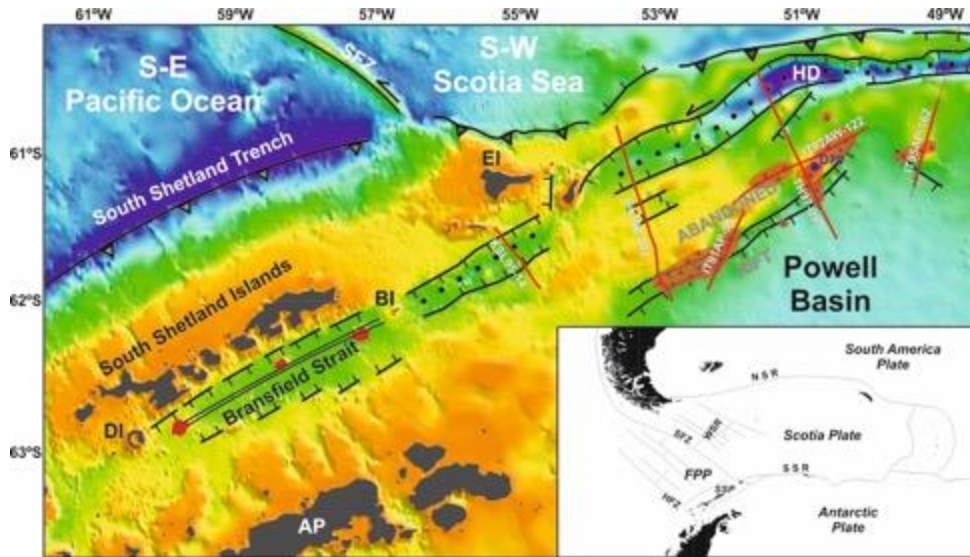

# Himalayan peripheral foreland basin



TF: Topographic Front  
MFT: Main Frontal Thrust  
MBT: main Boundary Thrust  
MCT: Main Central Thrust

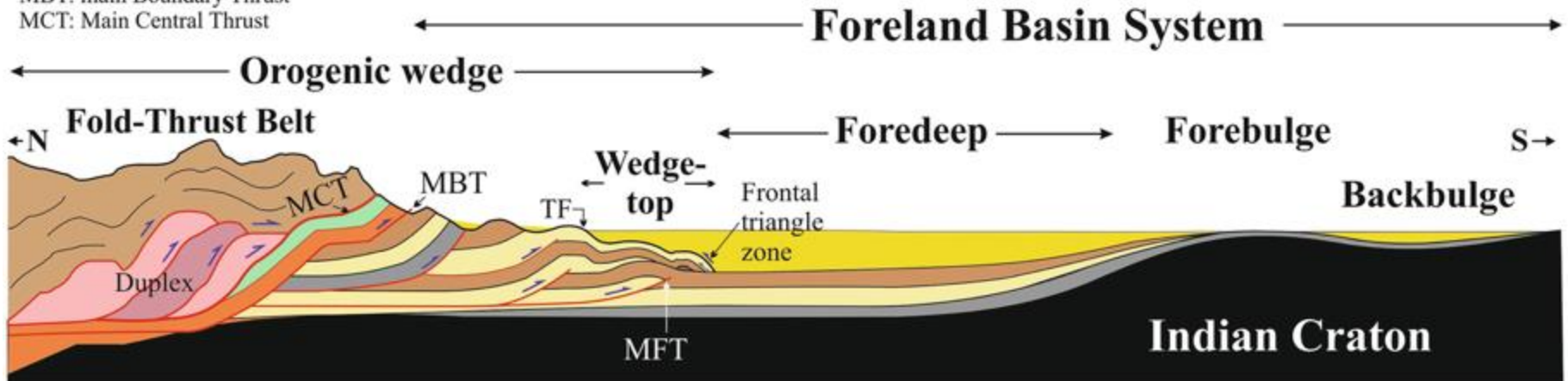



# 2° PART

# Strike-slip related basins

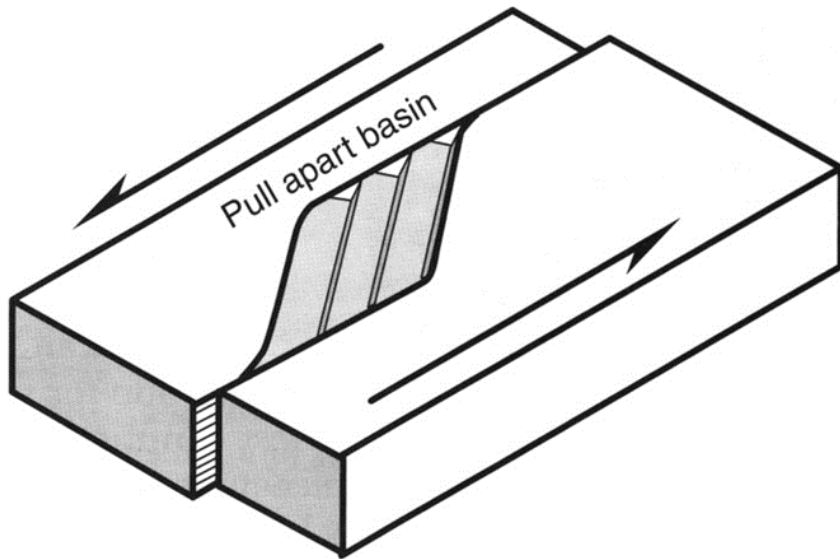

**Pull apart or fault overstep basins associated with strike-slip fault systems.**  
**Strike-slip basins often have extremely rapid lateral facies variations**

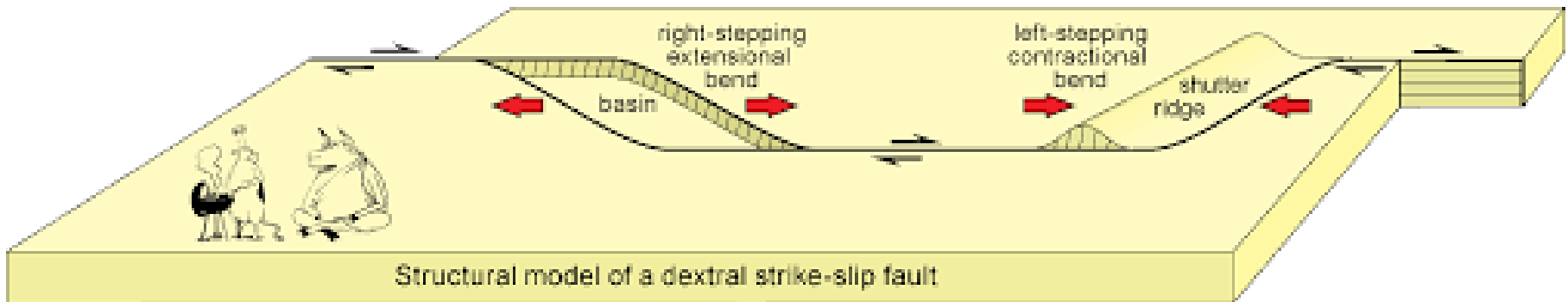

# Analogue modelling of transtensional pull-apart basins

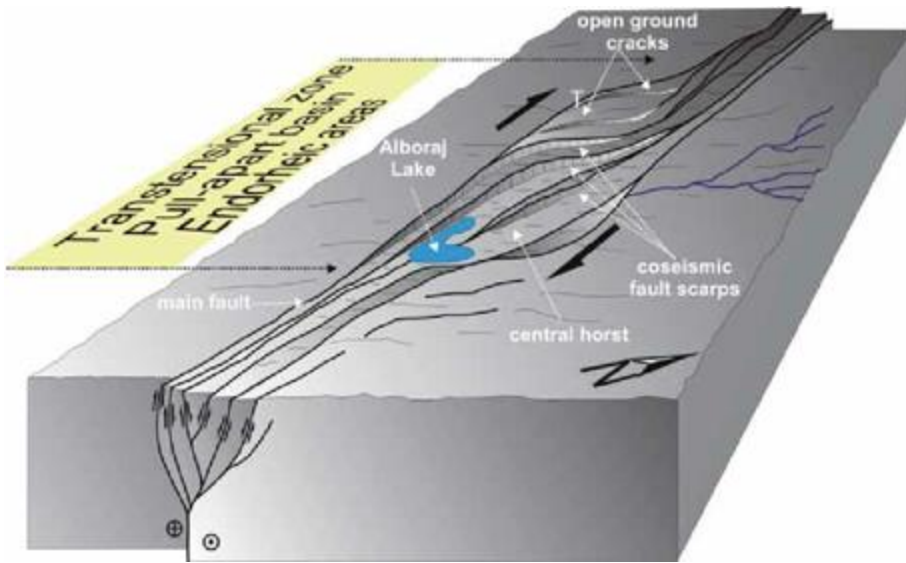

**a Pure Strike-Slip Model**

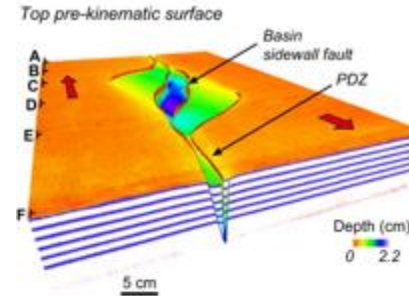

Vertical profiles

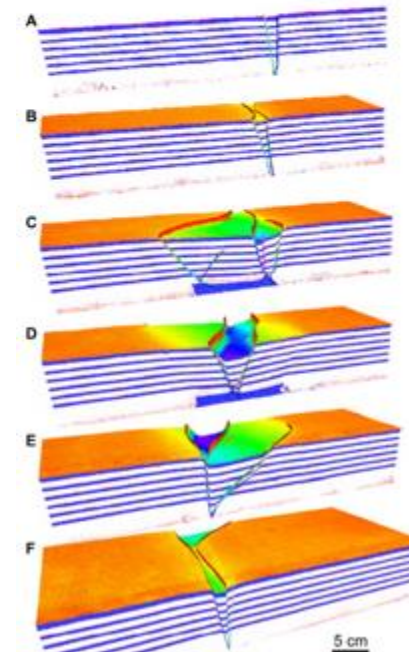

**b 5° Transtension Model**

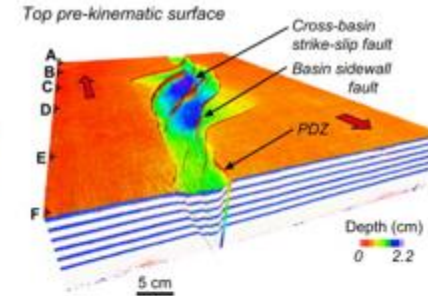

Vertical profiles

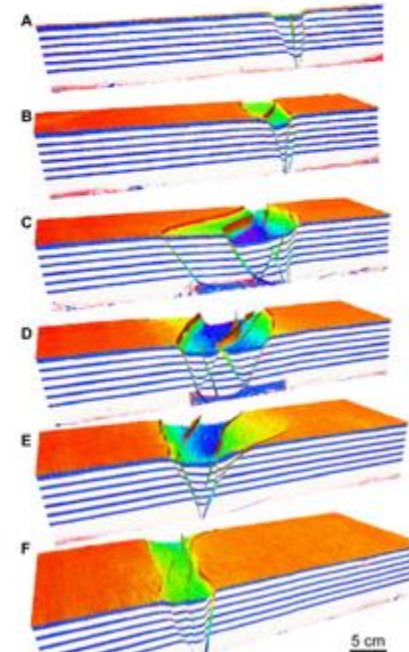

# Dead Sea Transform Fault System

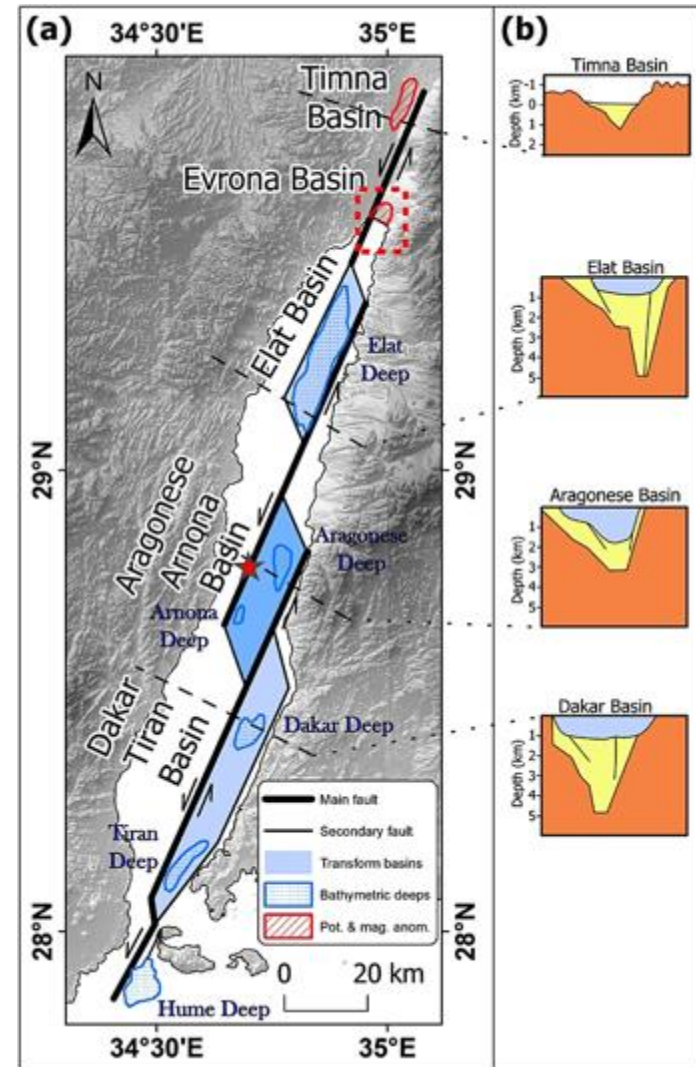



# Tierra del Fuego (South America-Scotia plate boundary)

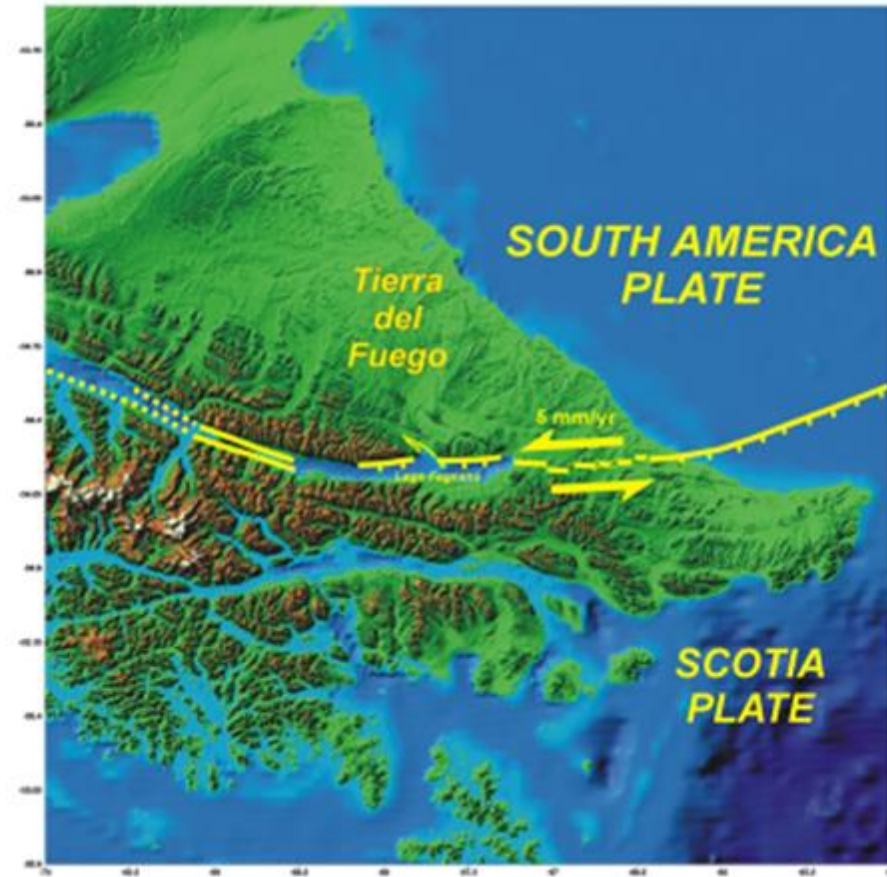
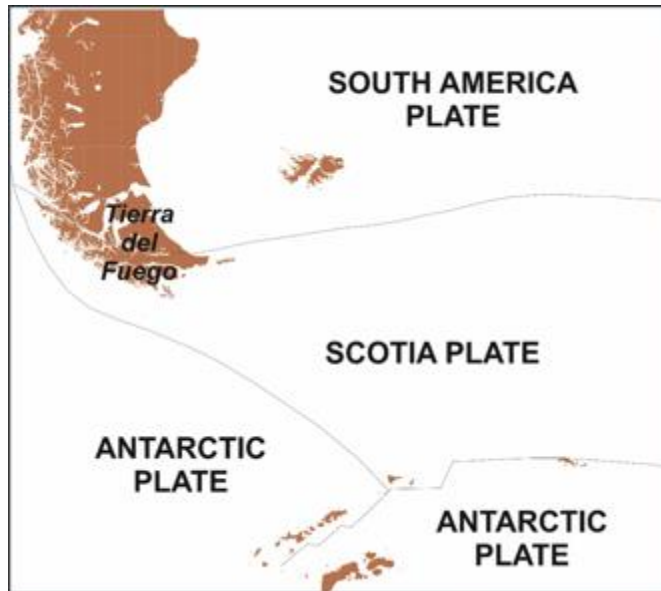

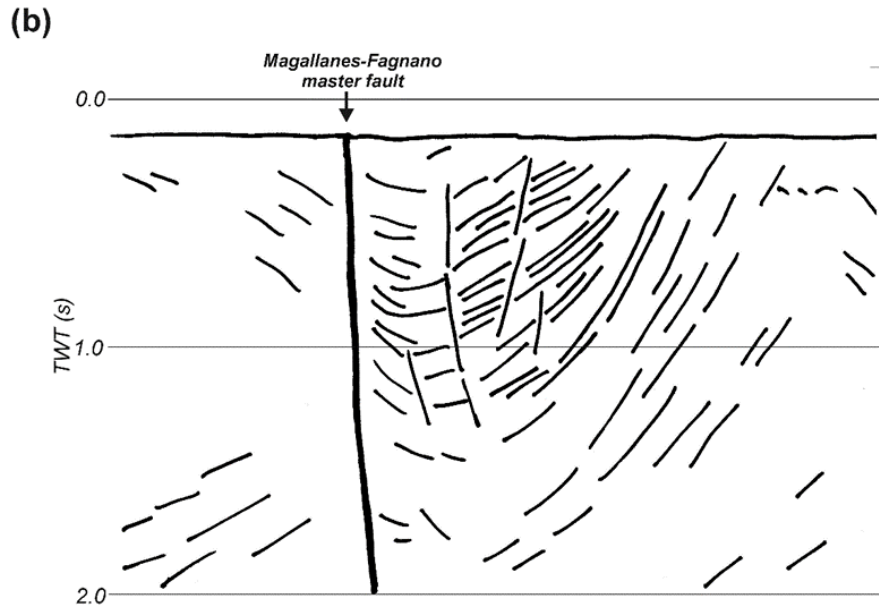
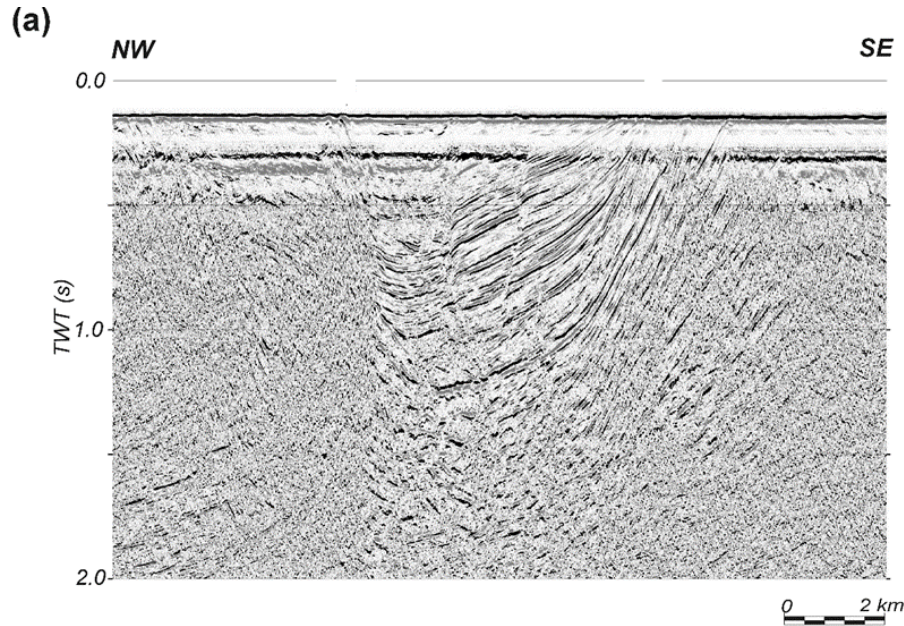

# Magallanes-Fagnano transform fault

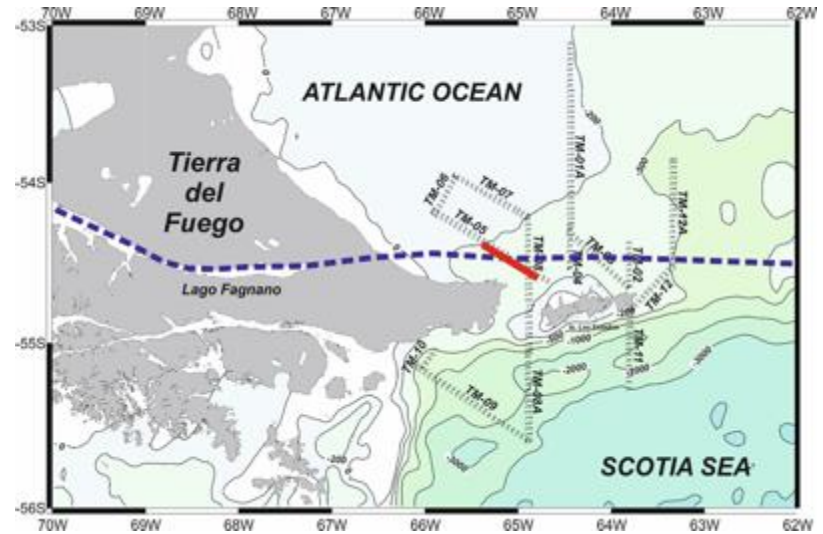

# Lago de Izabal (eastern Guatemala)

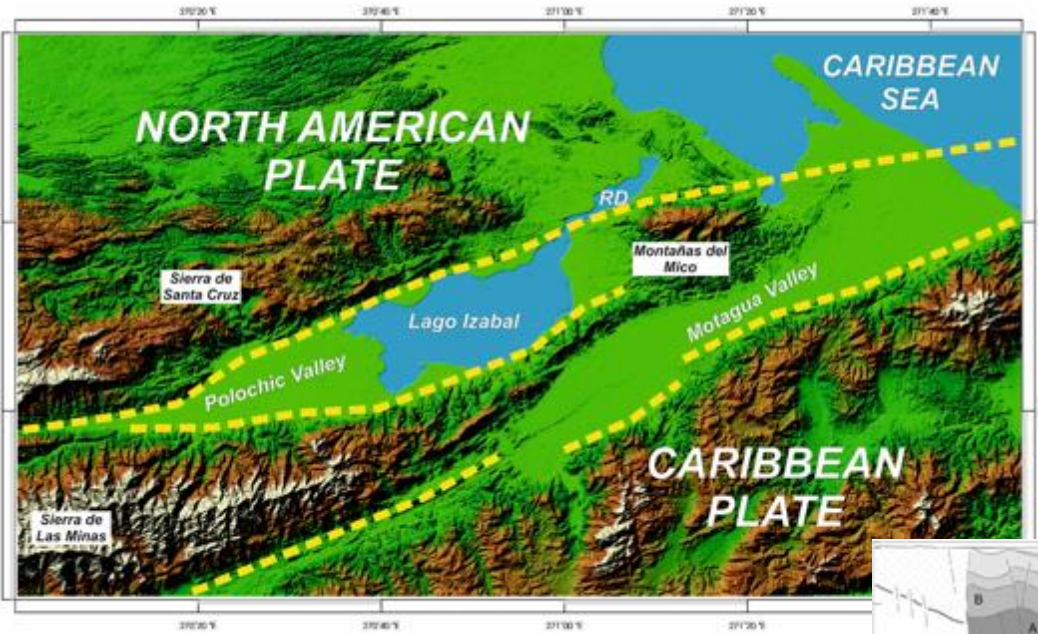

Studies show that basin asymmetry is toward the transform fault, suggesting that subsidence was mostly governed by extension in a direction normal to the strike of the transform, at the same time that strike-slip motion is taking place.

The occurrence of many asymmetric basins along transform environments testify that this specific geometry is the rule, rather than the exception.

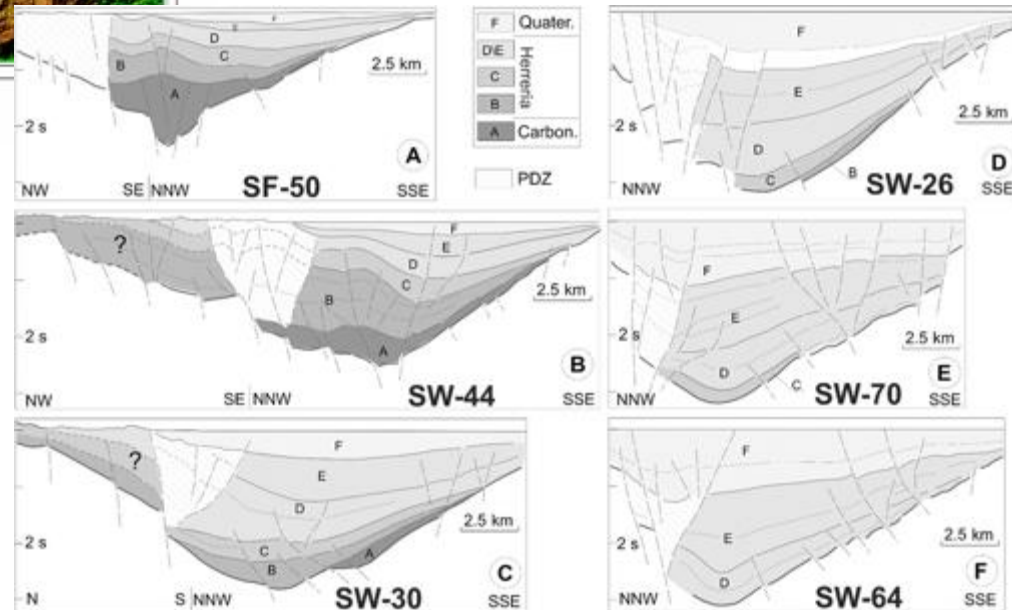

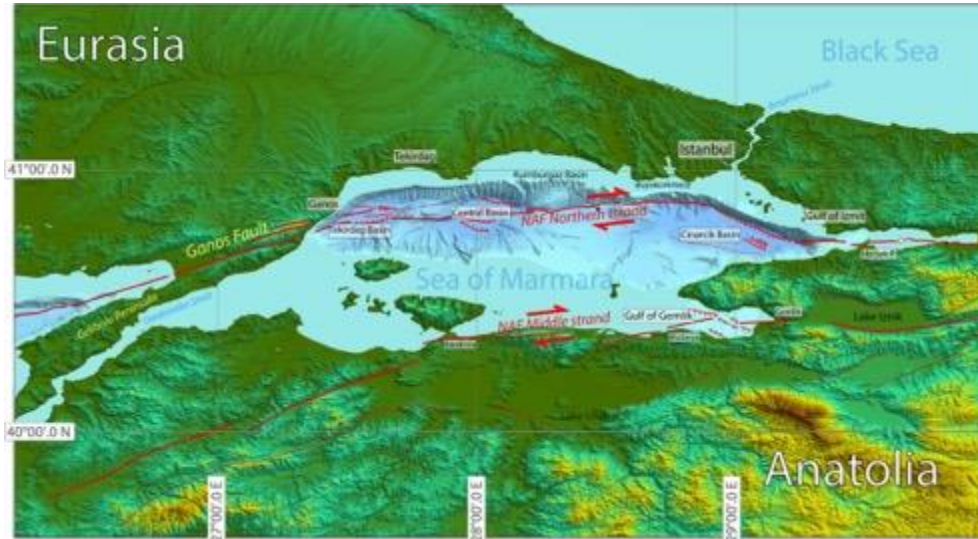

# Pull-apart basins along the North Anatolian Fault system in the Sea of Marmara

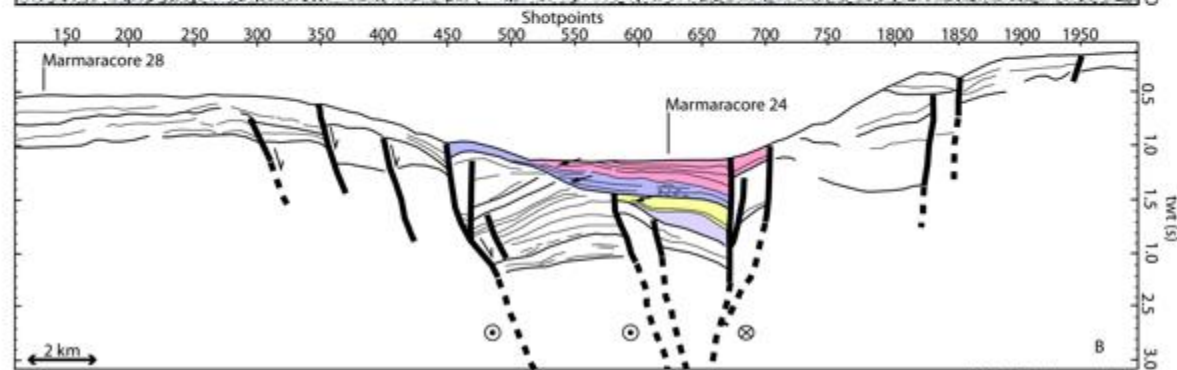
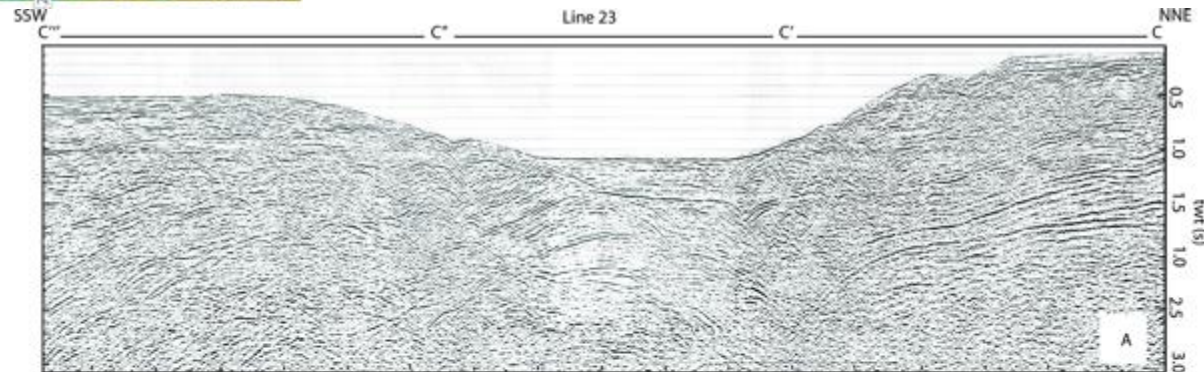

# **GEOPHYSICAL AND GEOLOGICAL METHODS FOR BASIN STUDIES**

## **Data needed for large-scale surveys:**

- **Satellite-derived images**
- **Airborne surveys (magnetic, gravity) and drones**
- **Multichannel seismic reflection surveys (both onshore and onland)**
- **Gravity surveys (both onshore and onland)**
- **Magnetic surveys (both onshore and onland)**

## **Data needed for small-scale surveys:**

- **High-resolution seismic profiles**
- **Geoelectrical soundings**
- **Georadar**
- **Sedimentary cores**

**Modeling, tomography, 3-D reconstructions, etc.**

# Bathymetry

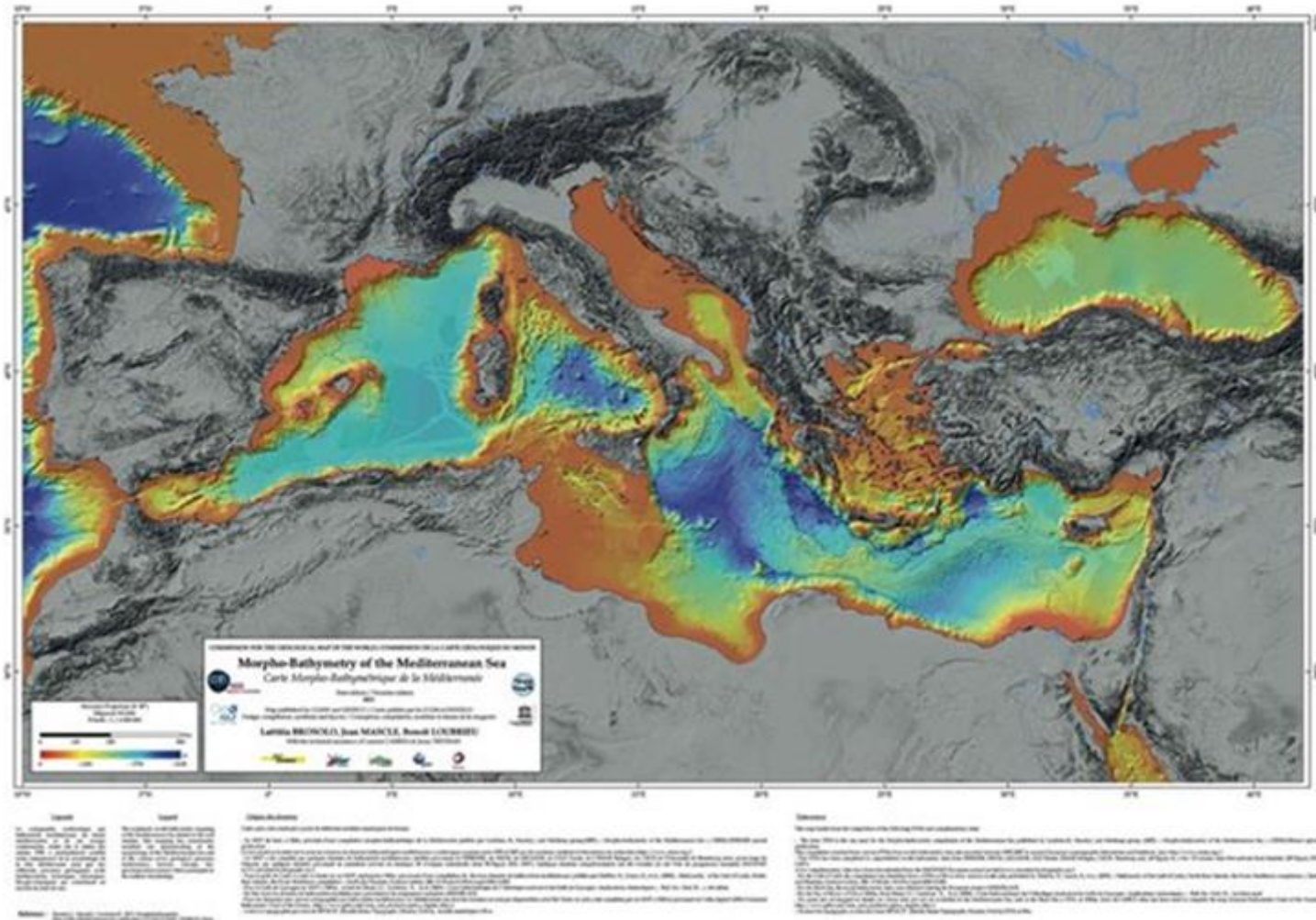

# Bouguer gravity map

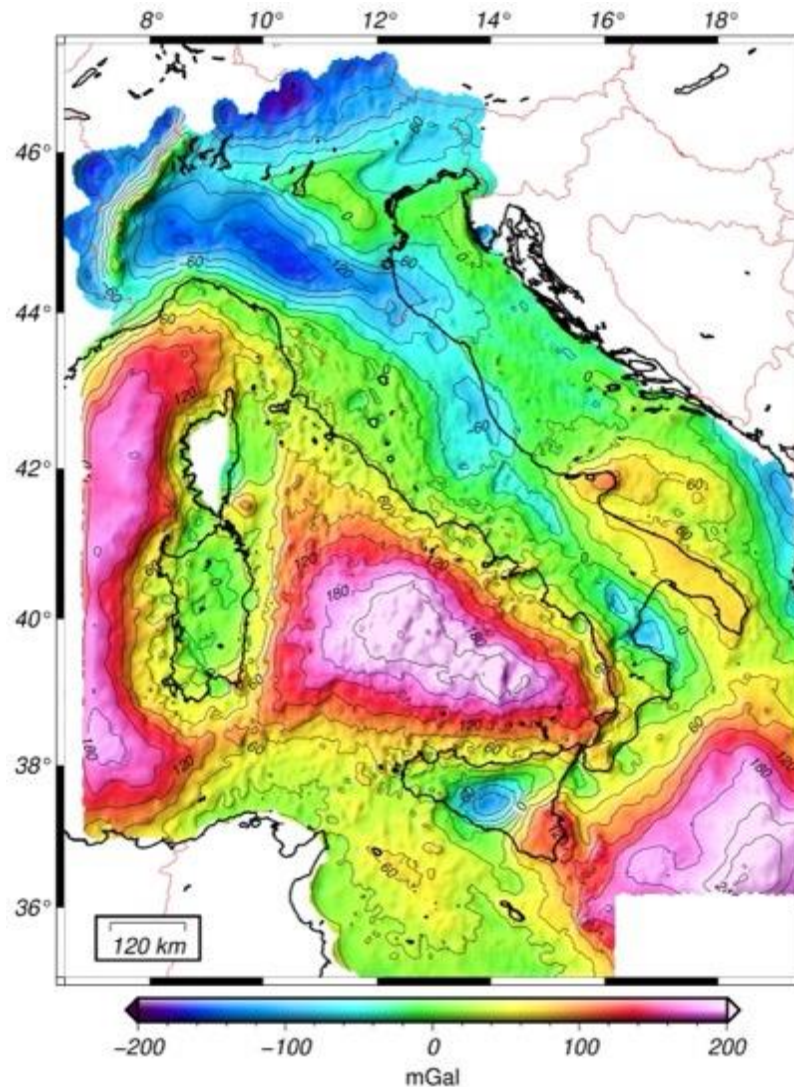

# Magnetic anomaly map

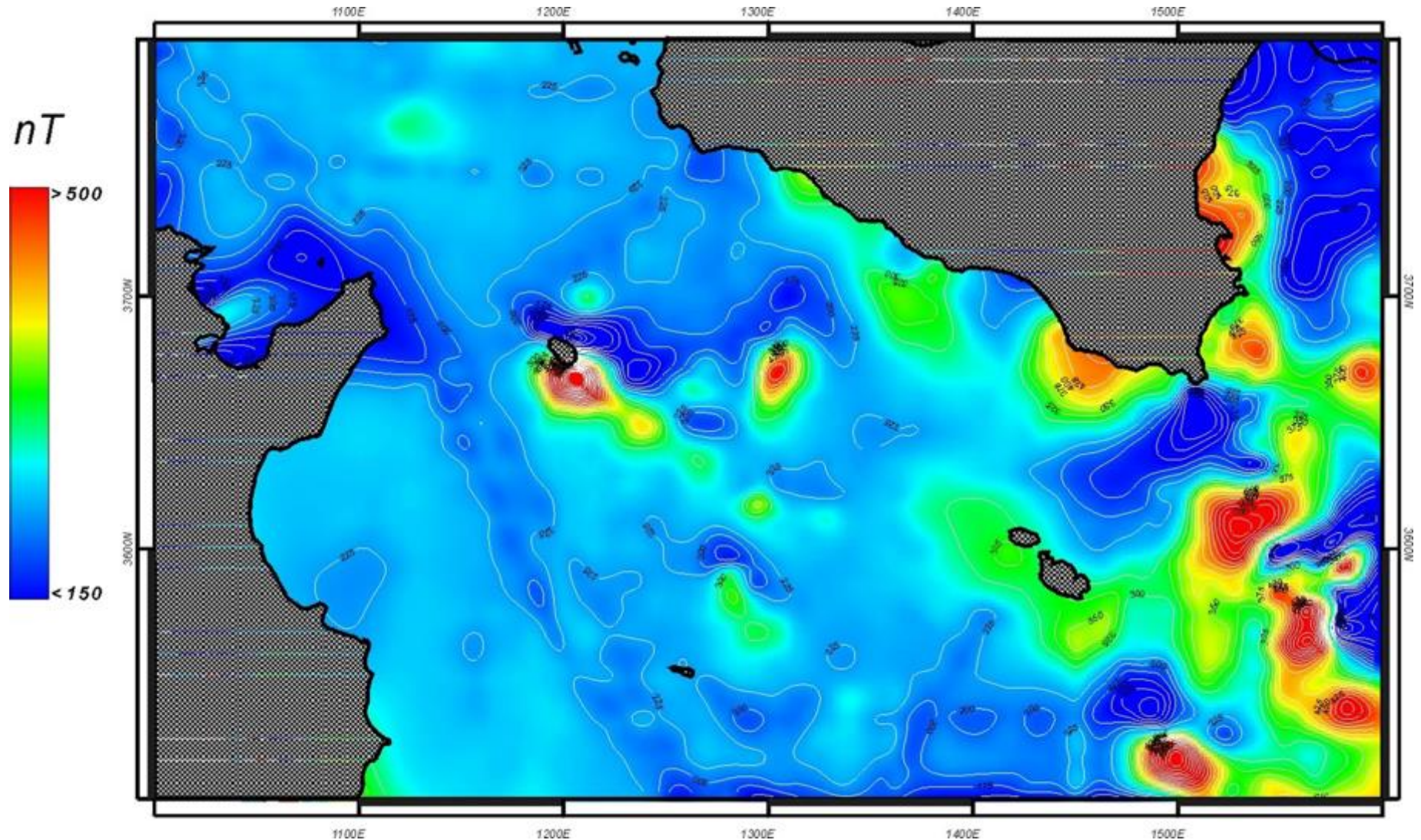



# SCIENTIFIC DRILLING

## HISTORY

**1961: Project MoHole**

**1966-1983: Deep Sea Drilling Project (DSDP)**

Drilling Vessel *Glomar Challenger*

**1983-2003: Ocean Drilling Program (ODP)**  
*JOIDES Resolution* replaced the *Glomar Challenger*

**2003-2013: Integrated Ocean Drilling Program (IODP)**

*JOIDES Resolution*, the new marine-riser equipped Japanese Vessel *Chikyu*, and specialized Mission-Specific-Platforms

**2013-Present: International Ocean Discovery Program (IODP)**

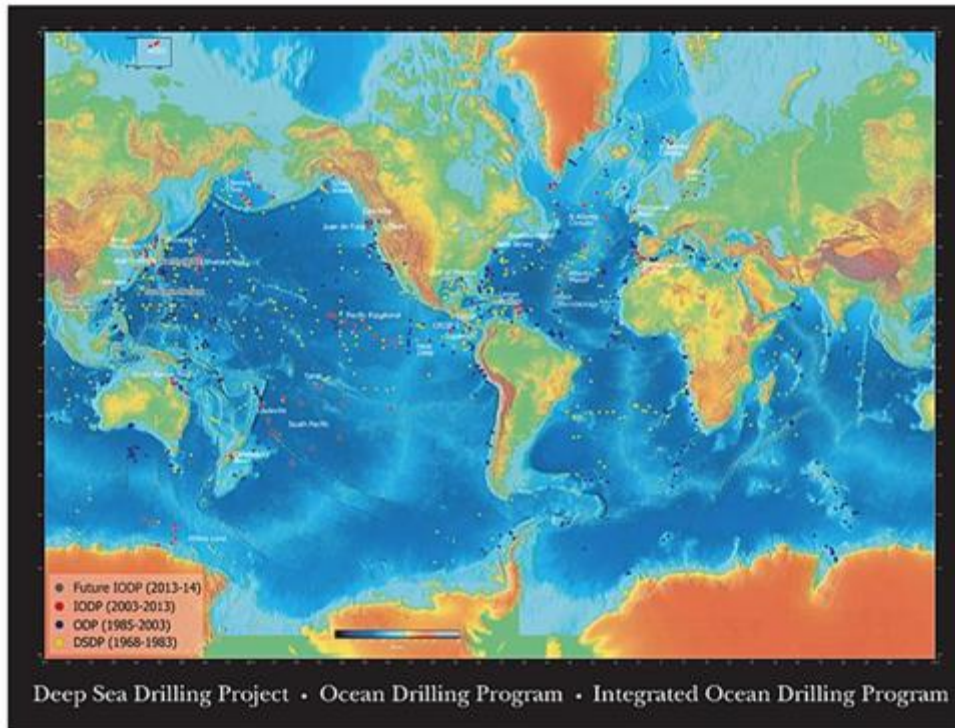

# DSDP and IODP sites in the Mediterranean Sea

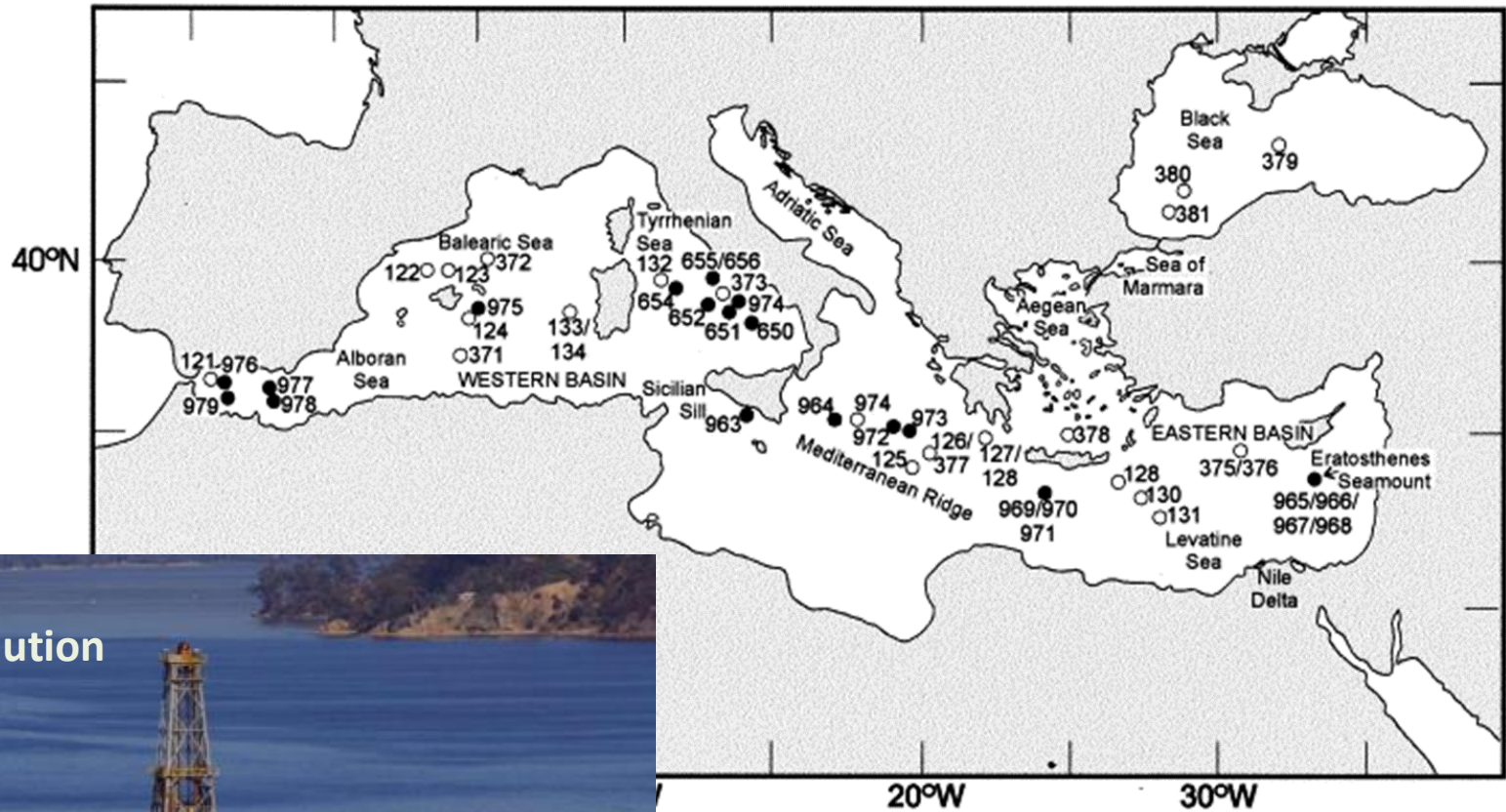

Joides Resolution



# MS seismic profiles (collected from 1968 to 1982)

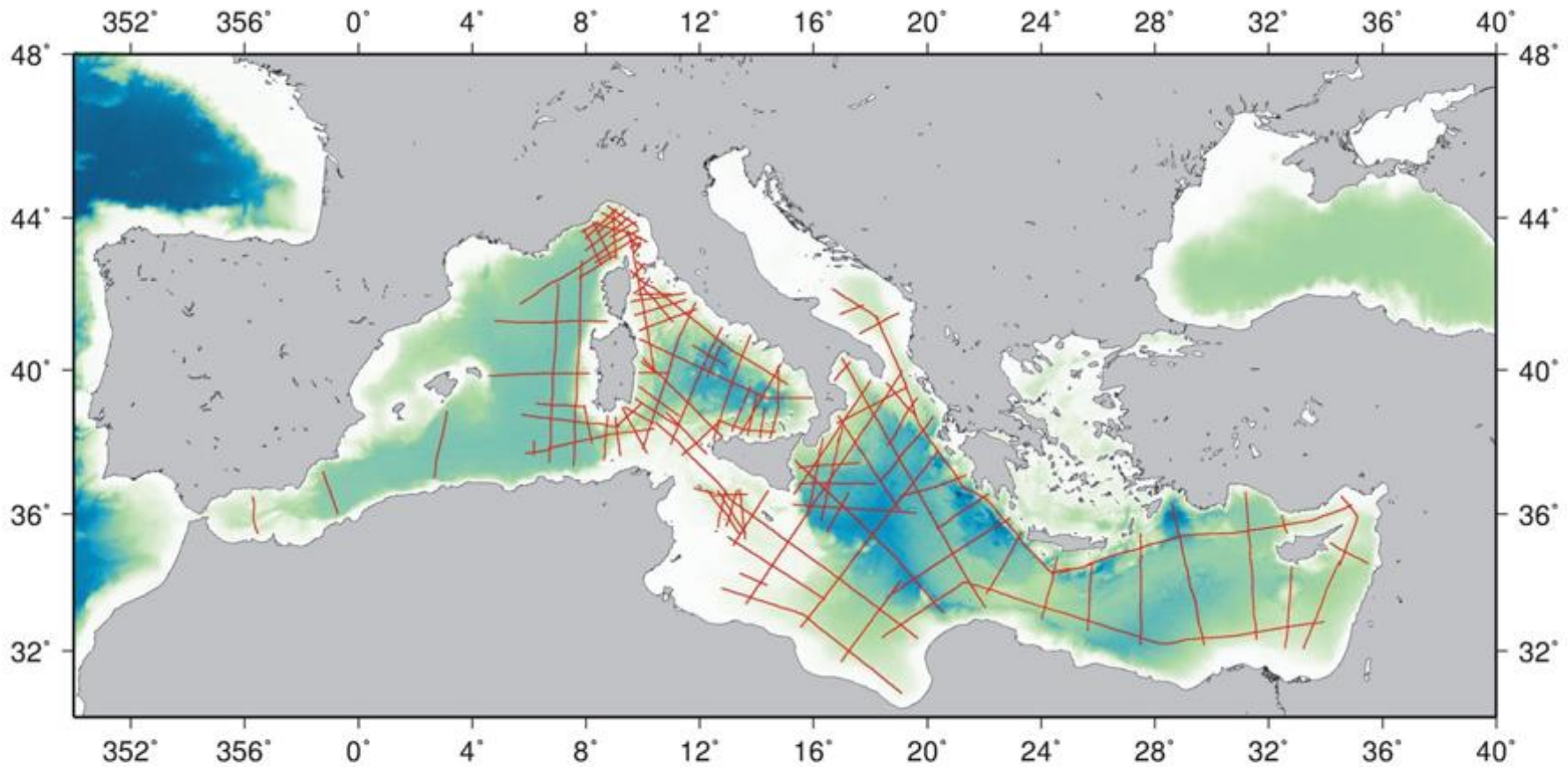

# CROP Crustal Project (Seismic profiles collected both onshore and offshore)

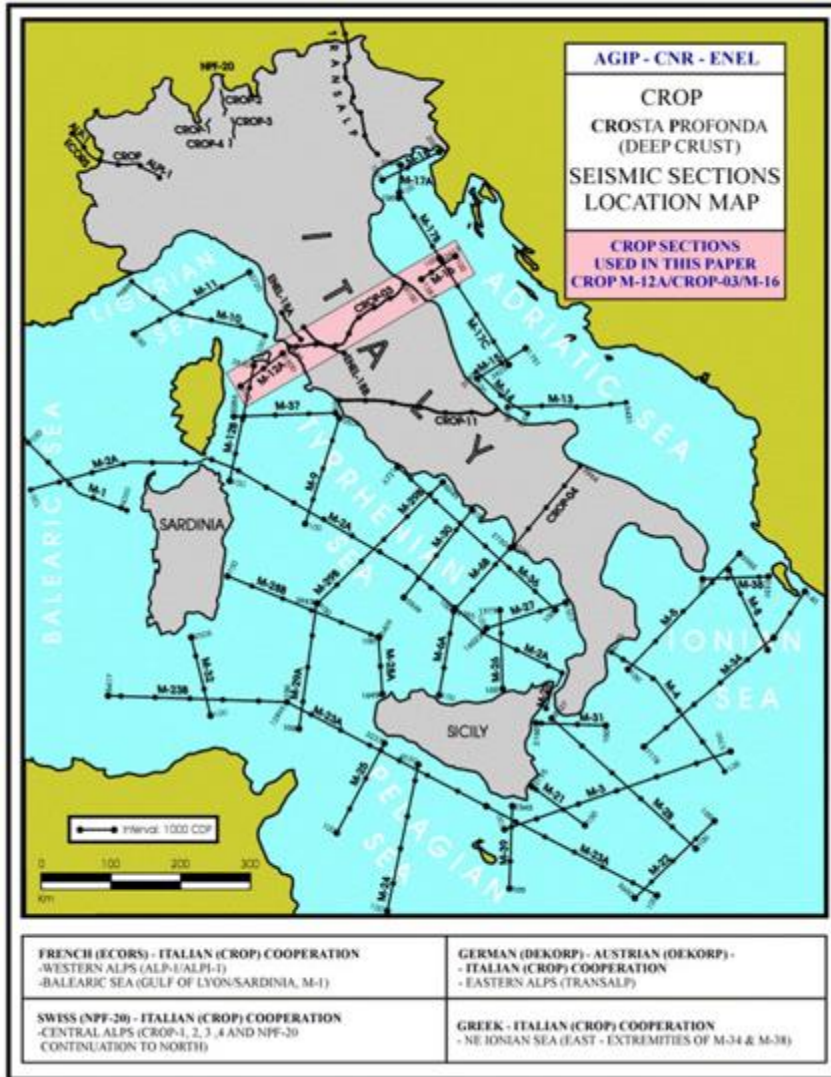

## ViDEPI

<http://unmig.sviluppoeconomico.gov.it/videpi/>

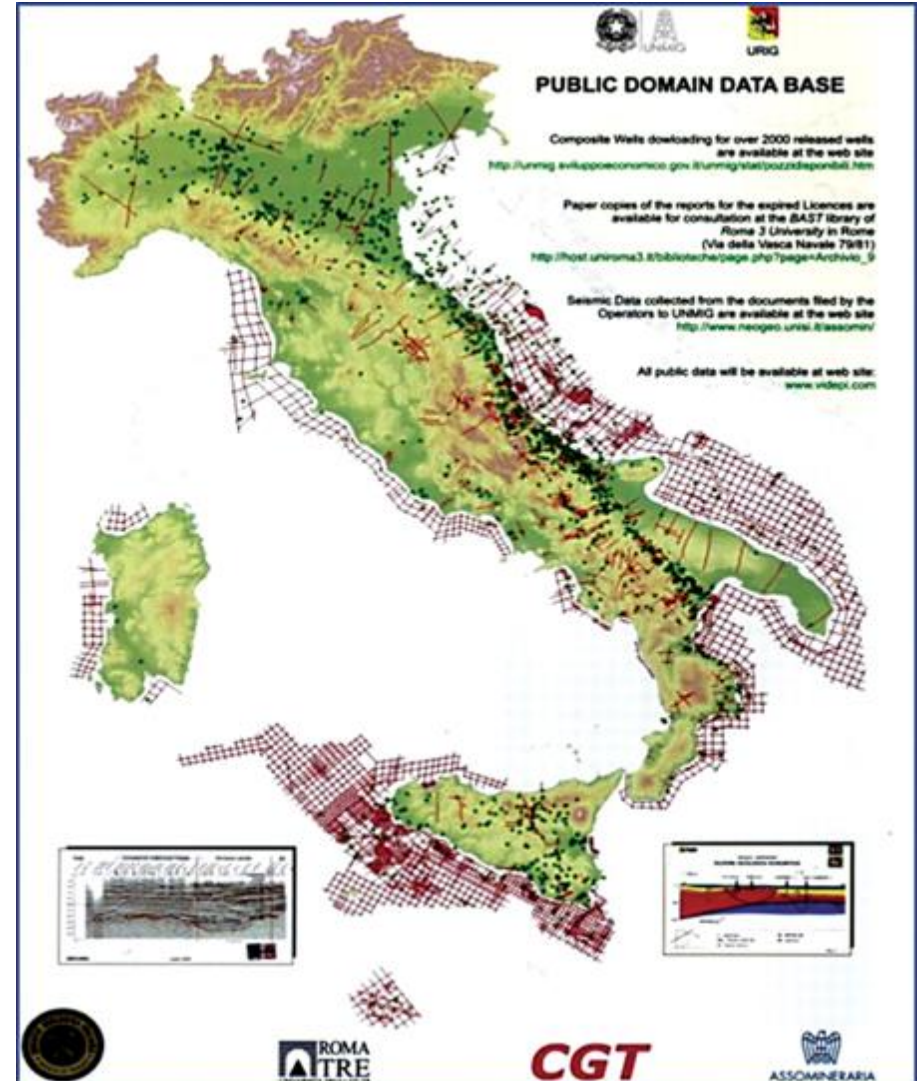

# **GEOPHYSICAL MODELLING AND INVERSION**

**(computerized representation of the Earth based on geophysical and geological observations)**

**Inversion procedure: Recording data “d” and predicting model “X”**

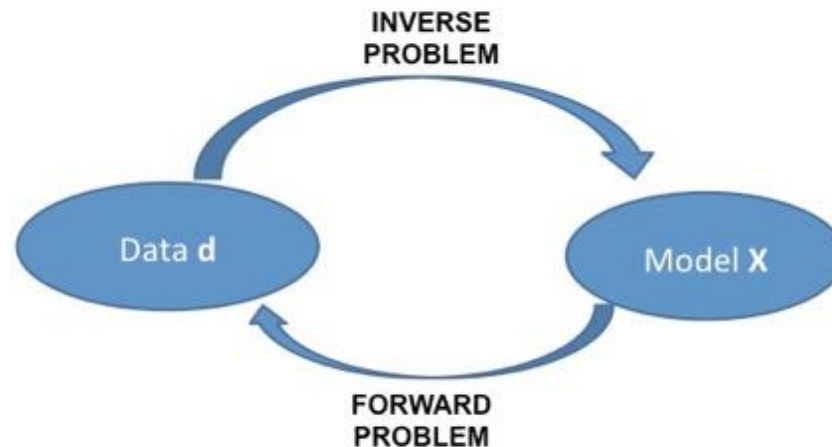

**Forward modelling: Given a model “X” and predicting data “d”**

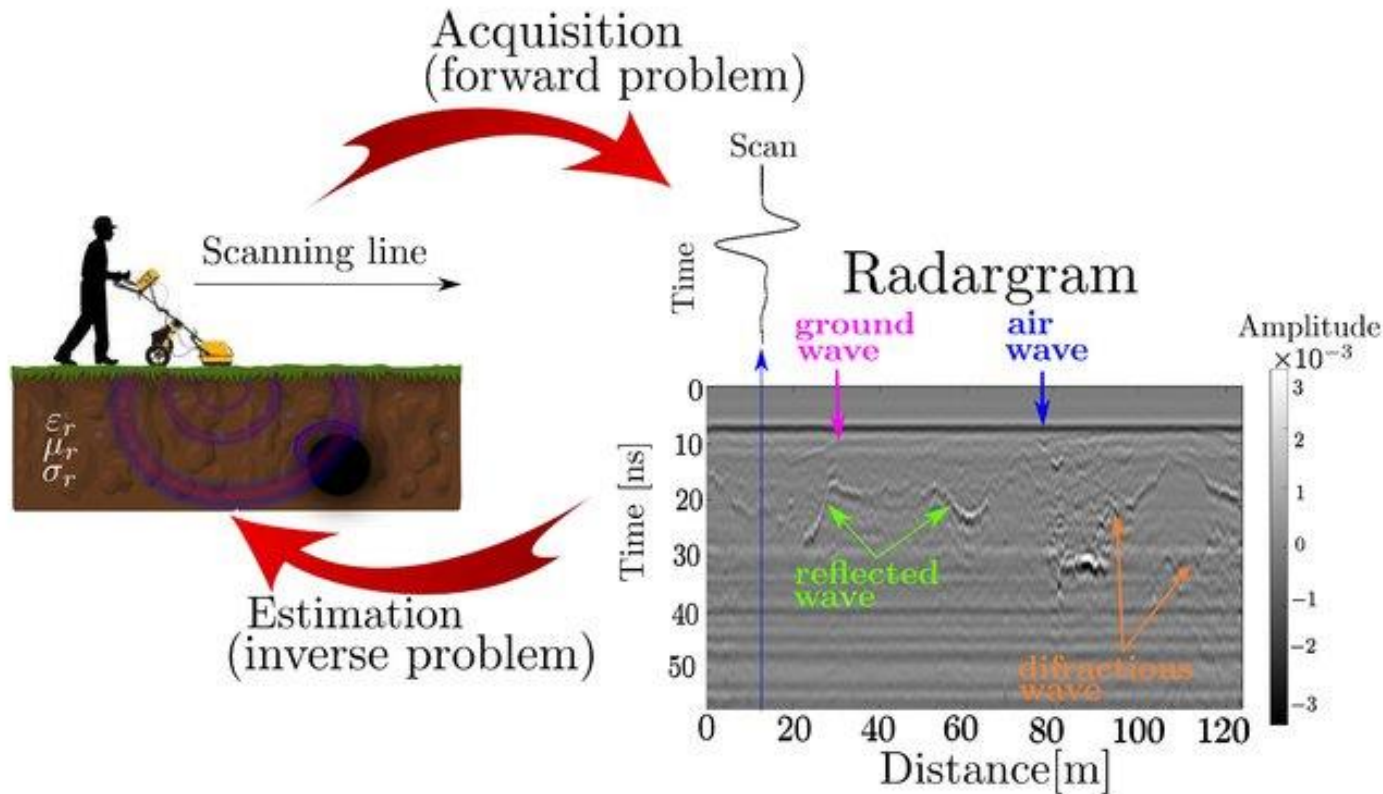

**Geophysical inversion refers to the mathematical and statistical techniques for recovering information on subsurface physical properties from observed geophysical data**

All geophysical (and geological) models are non-unique.

As an example, given only the gravity anomaly, the causative source is non-unique.

Additional information (e.g., seismostratigraphy from wells, geologic context, other geophysical data) are needed to narrow the solution space (constraints).

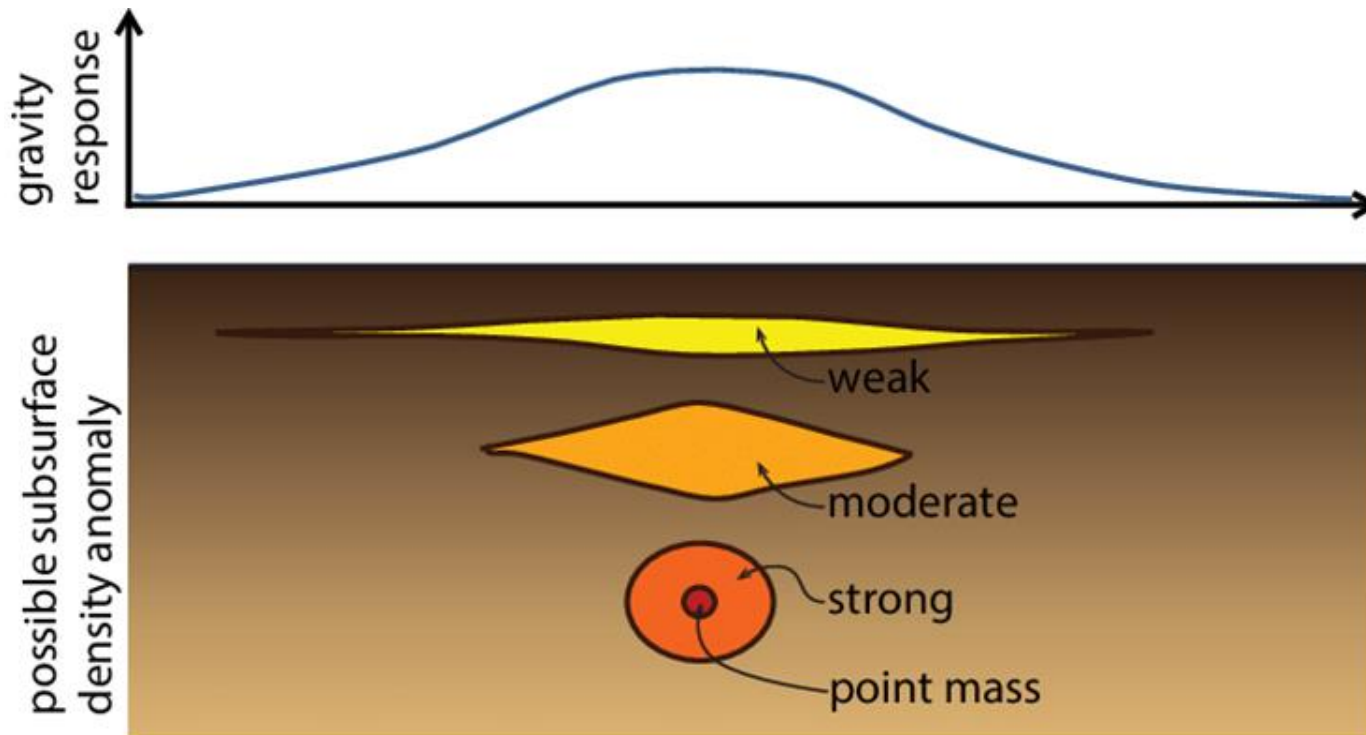

# Example of forward modelling

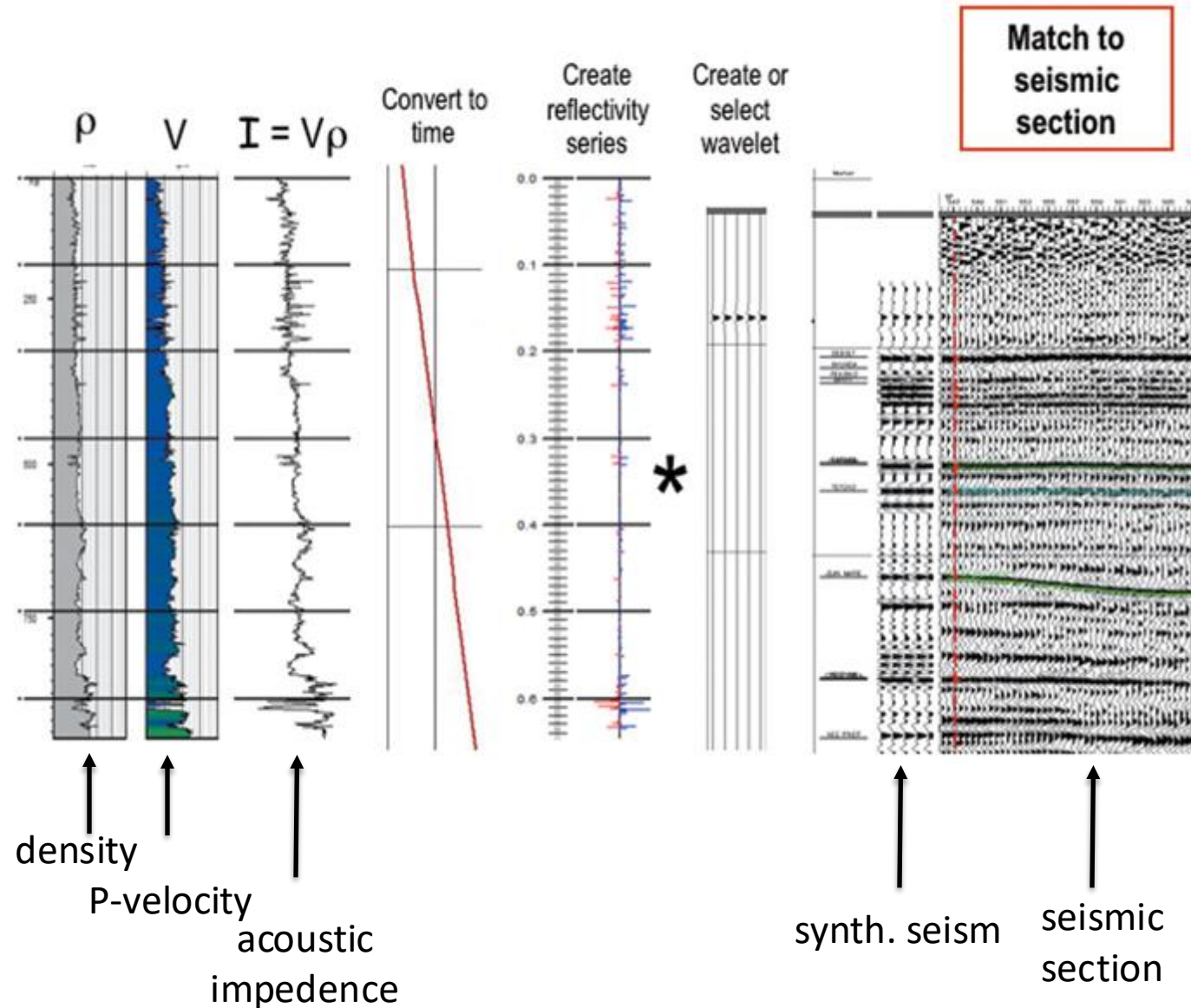

## Synthetic seismogram

Modelling the seismic response of an input earth model (variations in physical properties).

Widely used in hydrocarbon exploration to provide a 'tie' between changes in rock properties in a borehole and seismic reflection data at the same location.



# Interval acoustic velocities

Piera 1 well

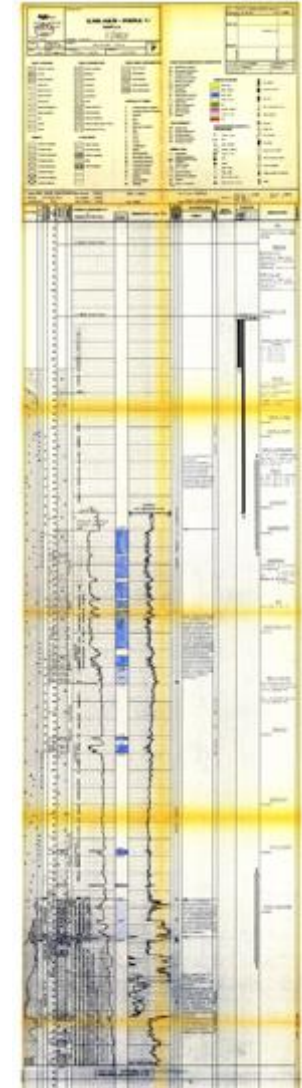
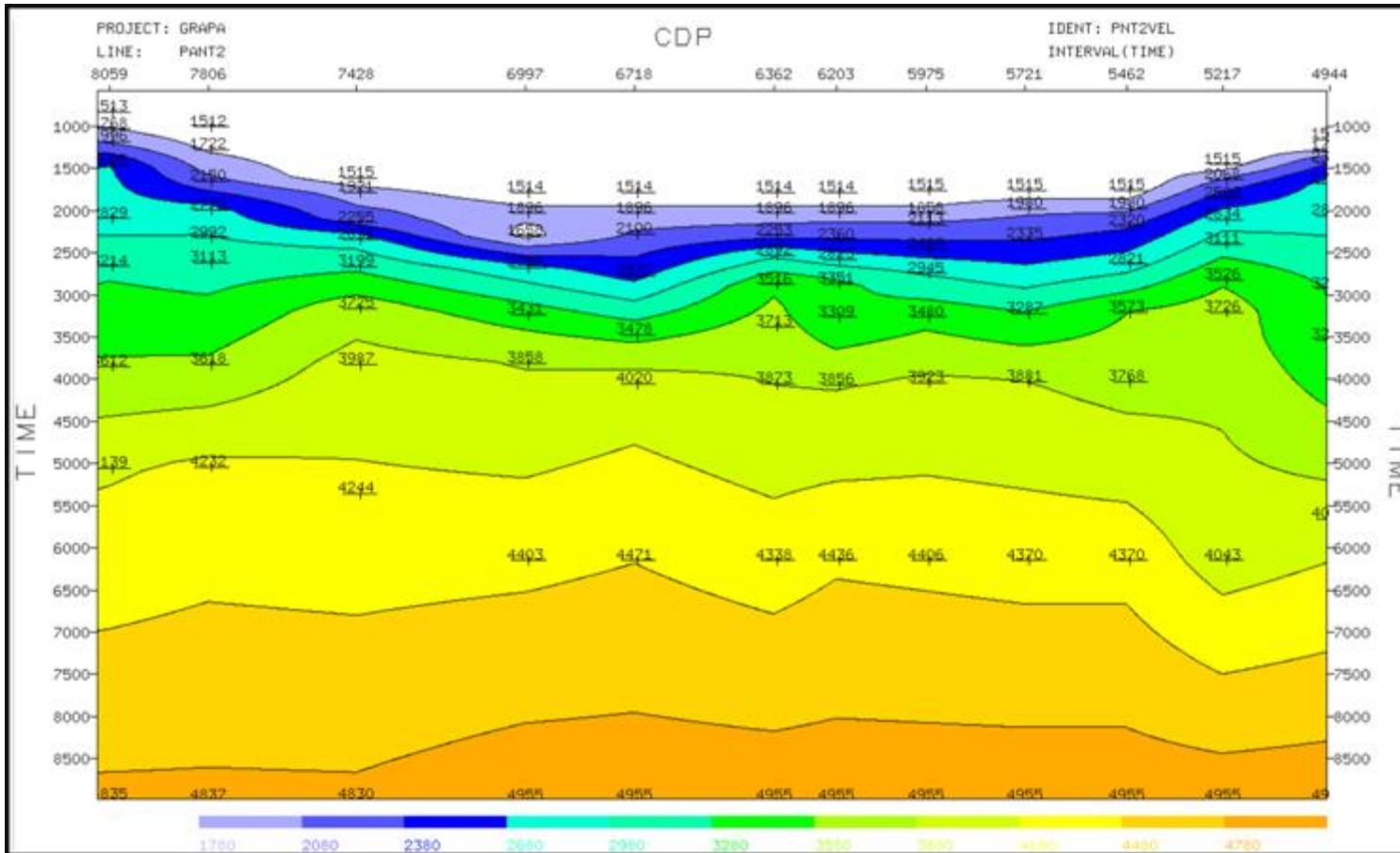

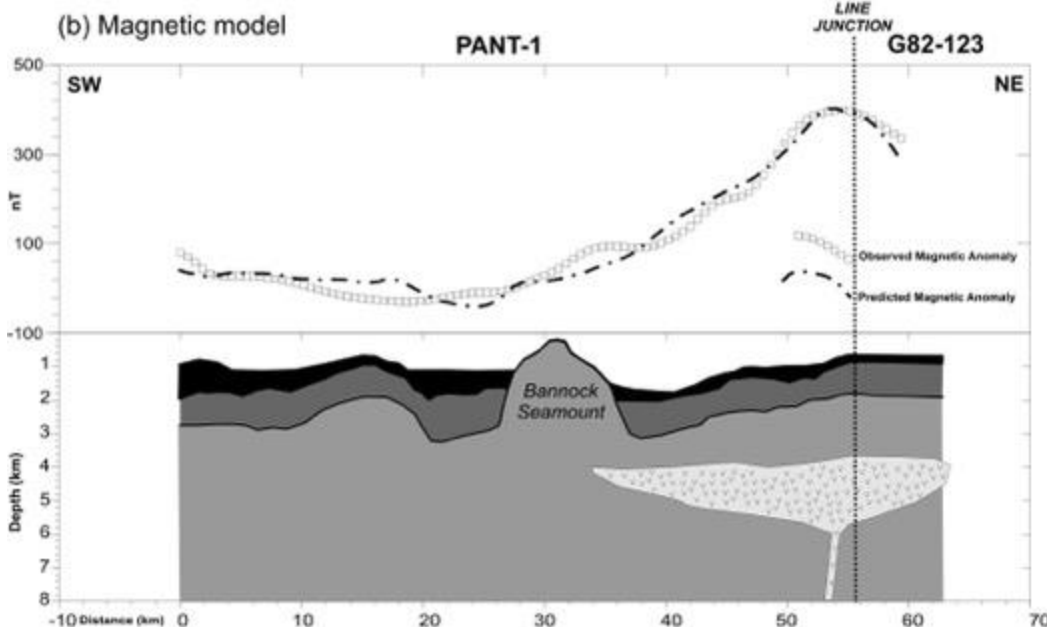
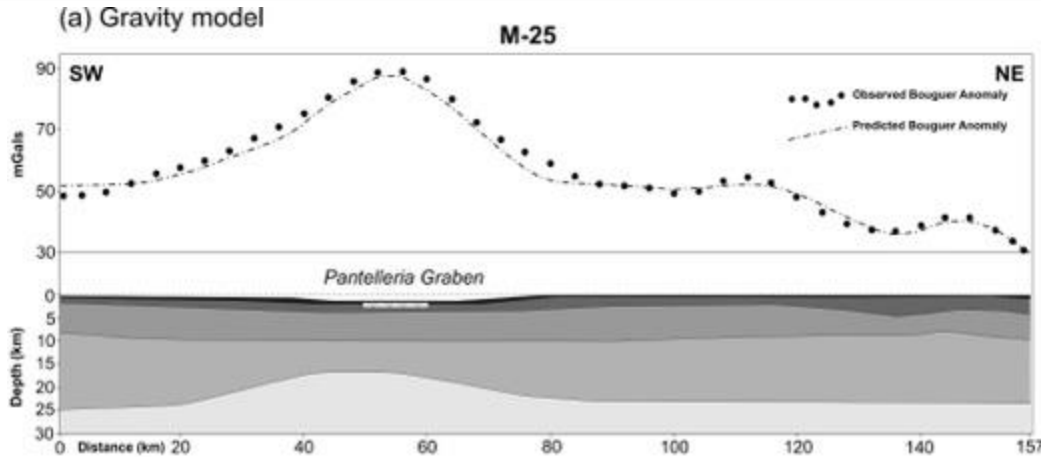

- Plio-Quaternary deposits ( $d = 2.1 \text{ g/cm}^3$ ;  $s = 0.0038$ )
  - Siliciclastic Miocene deposits ( $d = 2.37 \text{ g/cm}^3$ ;  $s = 0.004$ )
  - Carbonatic successions ( $d = 2.65 \text{ g/cm}^3$ ;  $s = 0.005$ )
  - Crystalline basement ( $d = 2.83 \text{ g/cm}^3$ )
  - Lithospheric mantle ( $d = 3.2 \text{ g/cm}^3$ )
  - Volcanic body ( $d = 2.8 \text{ g/cm}^3$ ;  $s = 0.0175$ )
- $d = \text{density}$ ;  $s = \text{susceptibility}$

# Gravity and magnetic modelling

# 3-D Moho depth geometry beneath the Pantelleria Island

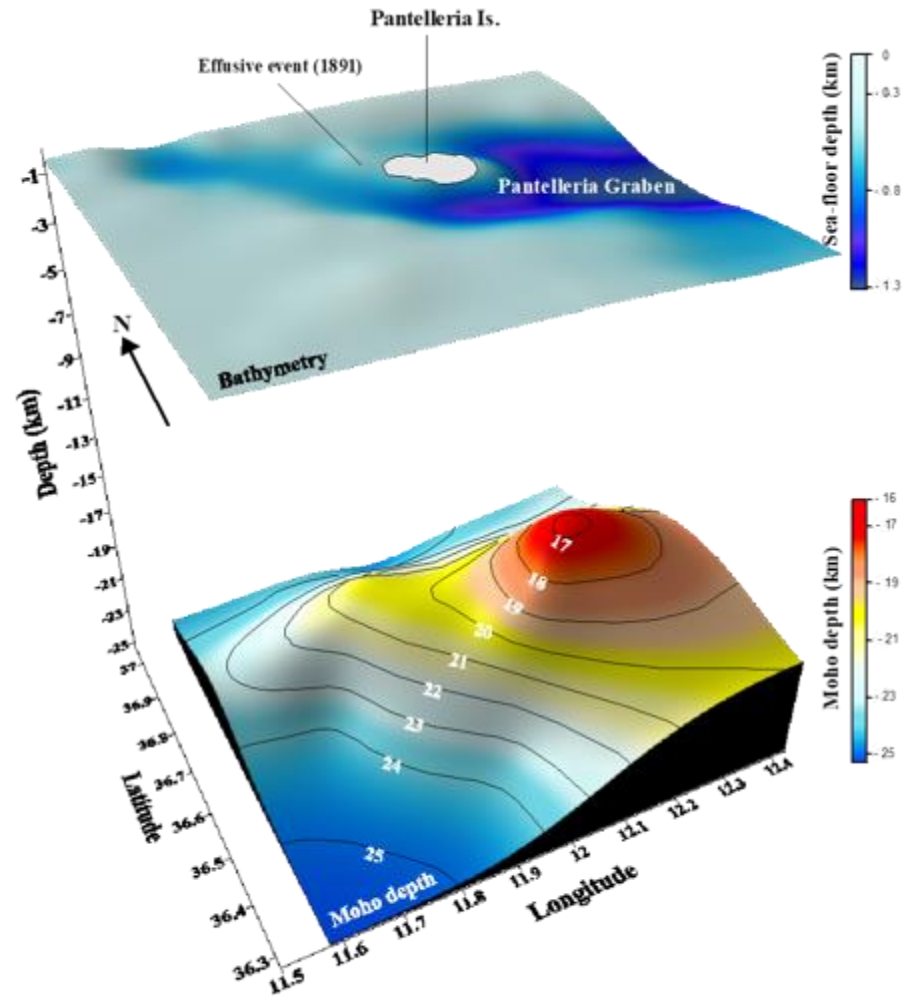

Schematic example of how to generate a crustal geological model from experimental geophysical information (seismic profile + gravimetric profile)

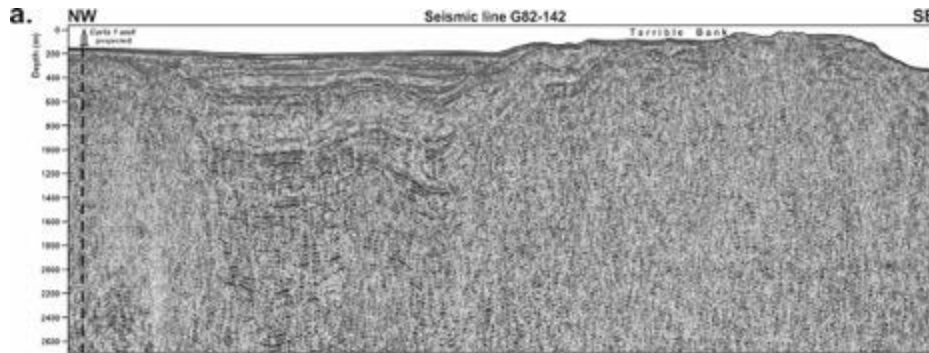

Acquired seismic data

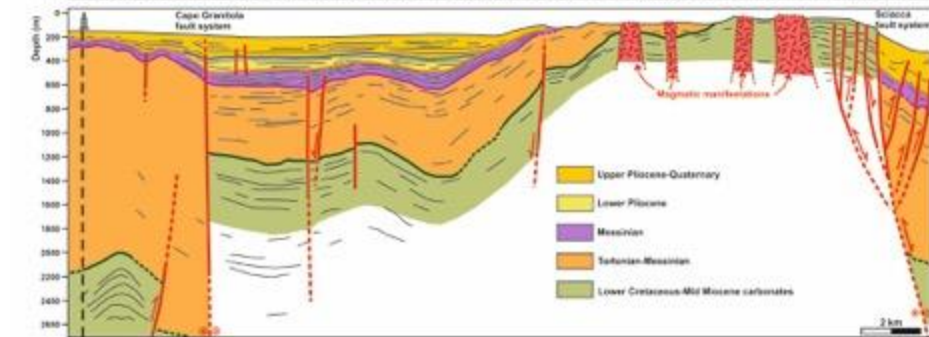

Stratigraphic interpretation from well data (after seismic data depth conversion) – shallow model

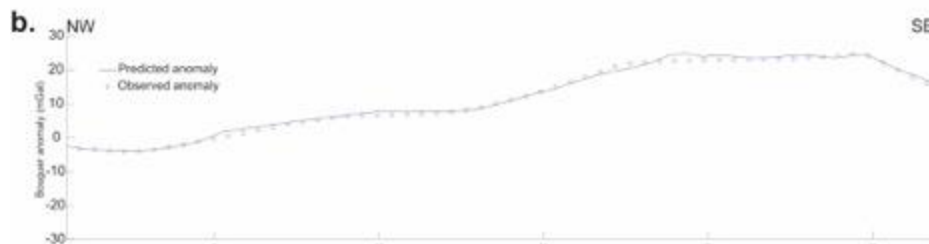

Crustal geological model from inversion of observed gravity data - deep model

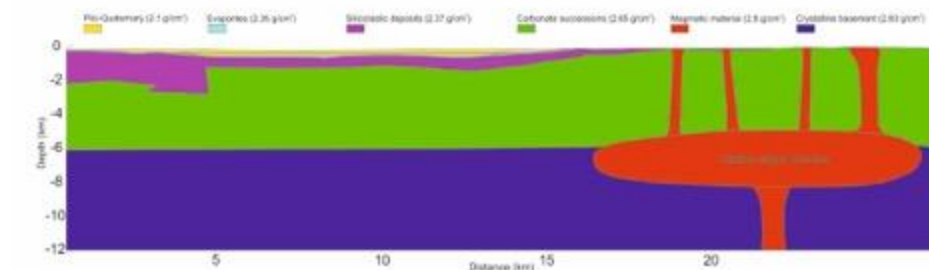

# SUMMARY

- Sedimentary basins are repositories for sediment that are formed by crustal subsidence relative to surrounding areas
- Different mechanisms can produce subsidence, related to plate interactions

## **Sedimentary basins are found in many different tectonic settings**

- Divergent plate boundaries – rift/drift transitions (not all rifts lead to the opening of ocean basins)
- Passive margins, which have highest subsidence (primarily due to cooling) that increases seawards
- Strike-slip margins along which pull-apart basins develop
- Convergent environments (i.e., subduction zones)
  
- Geophysical and geological data needed for basin studies
- Inverse and forward modelling

# SUGGESTED READINGS

