

## Wave energy utilization: A review of the technologies

António F. de O. Falcão

IDMEC, Instituto Superior Técnico, Technical University of Lisbon, 1049-001 Lisbon, Portugal

### ARTICLE INFO

#### Article history:

Received 22 October 2009

Accepted 22 October 2009

#### Keywords:

Wave energy  
Wave power  
Renewable energy  
Equipment  
Power take-off  
Review

### ABSTRACT

Sea wave energy is being increasingly regarded in many countries as a major and promising resource. The paper deals with the development of wave energy utilization since the 1970s. Several topics are addressed: the characterization of the wave energy resource; theoretical background, with especial relevance to hydrodynamics of wave energy absorption and control; how a large range of devices kept being proposed and studied, and how such devices can be organized into classes; the conception, design, model-testing, construction and deployment into real sea of prototypes; and the development of specific equipment (air and water turbines, high-pressure hydraulics, linear electrical generators) and mooring systems.

© 2009 Elsevier Ltd. All rights reserved.

### Contents

1. Introduction . . . . .	900
2. The wave energy resource . . . . .	901
3. Hydrodynamics . . . . .	901
3.1. Theoretical and numerical modelling . . . . .	901
3.2. Model testing . . . . .	903
4. Control . . . . .	903
5. The various technologies . . . . .	904
6. The oscillating water column (OWC) . . . . .	904
6.1. Fixed-structure OWC . . . . .	904
6.2. Floating-structure OWC . . . . .	905
7. Oscillating body systems . . . . .	906
7.1. Single-body heaving buoys . . . . .	906
7.2. Two-body heaving systems . . . . .	906
7.3. Fully submerged heaving systems . . . . .	907
7.4. Pitching devices . . . . .	908
7.5. Bottom-hinged systems . . . . .	910
7.6. Many-body systems . . . . .	910
8. Overtopping converters . . . . .	910
9. Power equipment . . . . .	911
9.1. Self-rectifying air turbines . . . . .	912
9.2. Hydraulic turbines . . . . .	913
9.3. High-pressure oil-hydraulics . . . . .	914
9.4. Electrical equipment . . . . .	915
10. Moorings . . . . .	915
11. Conclusion . . . . .	915
Acknowledgements . . . . .	915
References . . . . .	915

E-mail address: [antonio.falcao@ist.utl.pt](mailto:antonio.falcao@ist.utl.pt).

## 1. Introduction

The energy from ocean waves is the most conspicuous form of ocean energy, possibly because of the, often spectacular, wave destructive effects. The waves are produced by wind action and are therefore an indirect form of solar energy.

The possibility of converting wave energy into usable energy has inspired numerous inventors: more than one thousand patents had been registered by 1980 [1] and the number has increased markedly since then. The earliest such patent was filed in France in 1799 by a father and a son named Girard [2].

Several reviews on wave energy conversion have been published in book form, as conference and journal papers, and as reports. One should mention first the pioneering book by McCormick [1] published in 1981, and also the books by Shaw [3], Charlier and Justus [4] (their long chapter on wave energy was probably completed by 1986), Ross [2] (written from a non-technical point of view by a freelance journalist), Brooke [5] and Cruz [6]. A report prepared in 1999 for the UK Department of Energy [7] and the final report (2003) [8] from the European Thematic Network on Wave Energy (a project sponsored by the European Commission) provide abundant information on the state-of-the-art at the time. Shorter reviews can be found in [9–13].

Yoshio Masuda (d. 2009) (Fig. 1) may be regarded as the father of modern wave energy technology, with studies in Japan since the 1940s. He developed a navigation buoy powered by wave energy, equipped with an air turbine, which was in fact what was later named as a (floating) oscillating water column (OWC). These buoys were commercialized in Japan since 1965 (and later in USA) [14]. Later, in Japan, Masuda promoted the construction, in 1976, of a much larger device: a barge (80 m × 12 m), named Kaimei, used as a floating testing platform housing several OWCs equipped with different types of air turbines [15]. Probably because this was done at an early stage when the theoretical knowledge of wave energy absorption was in its infancy, the power output levels achieved in the Kaimei testing program were not a great success.

The oil crisis of 1973 induced a major change in the renewable energies scenario and raised the interest in large-scale energy production from the waves. A paper published in 1974 in the prestigious journal *Nature* by Stephen Salter [16], of the University of Edinburgh, became a landmark and brought wave energy to the attention of the international scientific community. The British



Fig. 1. Commander Yoshio Masuda (right) with Dr A.W. Lewis, in 2001 (courtesy of A.W. Lewis, University College Cork).

Government started in 1975 an important research and development program in wave energy [17], followed shortly afterwards by the Norwegian Government. The first conferences devoted to wave energy took place in England (Canterbury, 1976, and Heathrow, 1978). This was followed in 1979 by two more genuinely international conferences: *Power from Sea Waves* (Edinburgh, June) and the *First Symposium on Wave Energy Utilization* (Gothenburg, October–November). The *Second International Symposium on Wave Energy Utilization* (Trondheim, Norway, 1982) coincided with a marked decline in Government funding of the British wave energy program.

In Norway the activity went on to the construction, in 1985, of two full-sized (350 and 500 kW rated power) shoreline prototypes near Bergen. In the following years, until the early 1990s, the activity in Europe remained mainly at the academic level, the most visible achievement being a small (75 kW) OWC shoreline prototype deployed at the island of Islay, Scotland (commissioned in 1991) [18]. At about the same time, two OWC prototypes were constructed in Asia: a 60 kW converter integrated into a break-water at the port of Sakata, Japan [19] and a bottom-standing 125 kW plant at Trivandrum, India [20].

The wave energy absorption is a hydrodynamic process of considerable theoretical difficulty, in which relatively complex diffraction and radiation wave phenomena take place. This explains why a large part of the work on wave energy published in the second half of the 1970s was on theoretical hydrodynamics, in which several distinguished applied mathematicians took leading roles.

An additional difficulty is related to the conception of the power take-off mechanism (PTO) (air turbine, power hydraulics, electrical generator or other) which should allow the production of usable energy. The problem here lies in the variability of the energy flux absorbed from the waves, in several time-scales: wave-to-wave (a few seconds), sea states (hours or days) and seasonal variations. Naturally, the survivability in extreme conditions is another major issue.

The situation in Europe was dramatically changed by the decision made in 1991 by the European Commission of including wave energy in their R&D program on renewable energies. The first projects started in 1992. Since then, about thirty projects on wave energy were funded by the European Commission involving a large number of teams active in Europe. A few of these projects took the form of coordination activities, the most recent one (2004–2007) being the *Coordination Action in Ocean Energy*, with forty partners. Also sponsored (and in some cases partly funded) by the European Commission were a series of *European Wave Energy Conferences* (the more recent ones including also Tidal Energy): Edinburgh, UK (1993), Lisbon, Portugal (1995), Patras, Greece (1998), Aalborg, Denmark (2000), Cork, Ireland (2003), Glasgow, UK (2005), Porto, Portugal (2007), Uppsala, Sweden (2009). Sessions on ocean energy (with a major or dominant contribution of papers on wave energy) are becoming increasingly frequent in annual conferences on ocean engineering (namely the OMAE and ISOPE conferences) and on energy (the case of the World Renewable Energy Congresses).

In 2001, the International Energy Agency established an Implementing Agreement on Ocean Energy Systems (IEA-OES, presently with 17 countries as contracting parties) whose mission is to facilitate and co-ordinate ocean energy research, development and demonstration through international co-operation and information exchange. The IEA-OES 2008 Annual Report [21] contains a survey of the ongoing activities in wave energy worldwide.

In the last few years, growing interest in wave energy is taking place in northern America (USA and Canada), involving the national and regional administrations, research institutions and companies, and giving rise to frequent meetings and conferences on ocean energy [22,23].

This paper is mainly concerned with technological aspects of wave energy conversion. Issues like policies, economics and environmental impacts are left aside or only mentioned occasionally.

## 2. The wave energy resource

The main disadvantage of wave power, as with the wind from which it originates, is its (largely random) variability in several time-scales: from wave to wave, with sea state, and from month to month (although patterns of seasonal variation can be recognized).

The assessment of the wave energy resource is a basic prerequisite for the strategic planning of its utilization and for the design of wave energy devices. The characterization of the wave climate had been done before for other purposes, namely navigation, and harbour, coastal and offshore engineering (where wave energy is regarded as a nuisance), for which, however, the required information does not coincide with what is needed in wave energy utilization planning and design.

The studies aiming at the characterization of the wave energy resource, having in view its utilization, started naturally in those countries where the wave energy technology was developed first. In Europe, this was notably the case of the United Kingdom [24,25]. When the European Commission decided, in 1991, to start a series of two-year (1992–1993) *Preliminary Actions in Wave Energy R&D*, a project was included to review the background on wave theory required for the exploitation of the resource and to produce recommendations for its characterization [26]. The WERATLAS, a *European Wave Energy Atlas*, also funded by the European Commission, was the follow-up of those recommendations. It used high-quality results from numerical wind-wave modelling, validated by wave measurements where available and contains detailed wave-climate and wave-energy statistics at 85 points off the Atlantic and Mediterranean coasts of Europe [27]. The WERATLAS remains the basic tool for wave energy planning in Europe.

These data concern locations in the open sea, at distances from the coast of a few hundred km. As the waves propagate into the shore, they are modified in a complex way by bottom effects (refraction, diffraction, bottom friction and wave breaking) and by sheltering due to the presence of land (namely headlands and islands). For these reasons, the wave energy resource characterization in shallower waters (say less than 50 m water depth) has been done only for specific sites where plants are planned to be deployed. An exception is the ONDATLAS, a detailed nearshore wave-energy atlas for Portugal whose 500-km-long western coast is relatively straight, the bottom profile exhibiting little change over long coastal stretches [28].

The wave energy level is usually expressed as power per unit length (along the wave crest or along the shoreline direction); typical values for “good” offshore locations (annual average) range between 20 and 70 kW/m and occur mostly in moderate to high latitudes. Seasonal variations are in general considerably larger in the northern than in the southern hemisphere [29], which makes the southern coasts of South America, Africa and Australia particularly attractive for wave energy exploitation.

Reviews on wave energy resource characterization can be found in refs. [29,30].

## 3. Hydrodynamics

### 3.1. Theoretical and numerical modelling

The study of the hydrodynamics of floating wave energy converters could benefit from previous studies on the, largely similar, dynamics of ships in wavy seas, that took place in the decades preceding the mid-1970s. The presence of a power take-

off mechanism (PTO) and the requirement of maximizing the extracted energy introduced additional issues.

The first theoretical developments addressed the energy extraction from regular (sinusoidal) waves by a floating body oscillating in a single mode (one degree of freedom) with a linear PTO. An additional assumption of the theory was small amplitude waves and motions. This allowed the linearization of the governing equations and the use of the frequency-domain analysis. The hydrodynamic forces on the wetted surface of the body were decomposed into excitation forces (due to the incident waves), radiation forces (due to body motion) and hydrostatic forces (connected with the instantaneous position of the floating body with respect to the undisturbed free surface). Accordingly, (frequency dependent) hydrodynamic coefficients were defined, to be determined theoretically or computed with the aid of computer codes (usually based on the boundary element method). These were techniques already known from ship hydrodynamics.

This can be illustrated by the simple case of a floating body of mass  $m$  oscillating in heave (one degree of freedom). If the body position is defined by a vertical coordinate  $x$  (with  $x = 0$  in calm water), the equation of motion is

$$(m + A)\ddot{x} = f_d - B\dot{x} - \rho g S x + f_{PTO}. \quad (1)$$

Here,  $f_d(t)$  is (the vertical component of) the excitation force (acting on the assumedly fixed body;  $f_d = 0$  in calm water),  $f_{PTO}(t)$  is the vertical force due to the PTO mechanism,  $A(\omega)$  is the (hydrodynamic coefficient of) added mass (accounting for the inertia of the water surrounding the body),  $B(\omega)$  is the radiation damping coefficient (accounting for the damping on the body due to energy transfer to waves radiated away), and  $S$  is the cross-sectional area of the body by the unperturbed free surface plane ( $-\rho g S x$  is the hydrostatic restoring force). We assume the PTO force to consist of a linear damper (coefficient  $C$ ) and a linear spring (stiffness  $K$ ) and write  $f_{PTO} = -C\dot{x} - Kx$ . Then the whole system becomes fully linear. In regular waves of amplitude  $A_w$  and frequency  $\omega$ , we write  $\{x, f_d\} = \text{Re}\{\{X, F_d\}e^{i\omega t}\}$ , where  $X$  and  $F_d$  are complex amplitudes and  $\text{Re}()$  means real part of. Then, from (1), we obtain

$$X = \frac{F_d}{-\omega^2(m + A) + i\omega(B + C) + \rho g S + K}. \quad (2)$$

Since the system is linear, the excitation force is proportional to wave amplitude, i.e.  $|F_d| = \Gamma A_w$ , where  $\Gamma(\omega)$  is a hydrodynamic coefficient of diffraction force.

The time-averaged absorbed power is  $\bar{P} = \overline{f_d \dot{x}} = C\omega^2 |X|^2 / 2$ , which can be written as

$$\bar{P} = \frac{1}{8B} |F_d|^2 - \frac{B}{2} \left| U - \frac{F_d}{2B} \right|^2, \quad (3)$$

where  $U = i\omega X$  is the complex amplitude of the velocity  $\dot{x}$ .

For a given body and given incident regular wave,  $B$  and  $F_d$  are fixed. Then the absorbed power  $\bar{P}$  depends on  $X$ , i.e. on the PTO damping and spring coefficients  $C$  and  $K$ . Eq. (3) shows that its maximum value, equal to

$$\bar{P}_{\max} = \frac{1}{8B} |F_d|^2, \quad (4)$$

occurs for  $U = F_d / 2B$ , which, combined with (2), gives two optimal conditions involving real quantities

$$\omega = \left( \frac{\rho g S + K}{m + A(\omega)} \right)^{1/2}, \quad (5)$$

$$C = B(\omega). \quad (6)$$

Eq. (5) is a resonance condition: its right hand side is the frequency of free oscillations of an undamped mechanical oscillator of mass

$m + A$  acted upon by a spring of stiffness  $\rho g S + K$ . Eq. (6) shows that the optimal PTO damping should equal the radiation damping.

It is convenient to introduce the concept of capture (or absorption) width as  $L = \bar{P}/E$ , where  $E$  is the wave energy flux per unit crest length. It can be shown that

$$L_{\max} = \frac{\bar{P}_{\max}}{E} = \frac{\lambda}{2\pi} \quad (7)$$

for a body with a vertical axis of symmetry (but otherwise arbitrary geometry) oscillating in heave, and  $L_{\max} = \lambda/\pi$  if the body oscillates in sway. Here  $\lambda$  is the wavelength. Eq. (7) is an important theoretical result, obtained independently in 1975–1976 by Budal and Falnes [31] Evans [32], Newman [33] and Mei [34], on the maximum power that can be absorbed from the waves, as is the well-known Betz limit for the power coefficient of wind turbines.

Illustrative performance curves for a floater oscillating in heave, whose submerged part is hemispherical, can be easily obtained from results for the hydrodynamic coefficients derived analytically by Hulme [35] for deep water. These are shown in a dimensionless representation in Fig. 2, with the ratios  $\bar{P}/\bar{P}_{\max}$  and  $|X|/A_w$  plotted versus dimensionless wave period  $T^* = (g/a)^{1/2}T$  ( $a$  = sphere radius,  $T = 2\pi/\omega$  = wave period) for several values of the dimensionless PTO damping coefficient  $C^* = \rho a^{5/2} g^{1/2} C$ . No spring is assumed to be present, i.e.  $K = 0$ . Optimal conditions (5) and (6) are to be met for maximum power absorption: the resonance condition (5) yields  $T^* = 6.11$ , whereas the damping condition (6) gives  $C^* = 0.510$ . With  $g = 9.8 \text{ m/s}^2$ , we find the optimum radius  $a = 0.262T^2$  ( $a$  in m, wave period  $T$  in s). Taking  $T = 10 \text{ s}$  as a typical value for the northern Atlantic, we obtain  $a = 26.2 \text{ m}$  for the optimum radius of a hemispherical resonant buoy. The corresponding value for the

oscillation amplitude is  $|X|/A_w = 0.909$ . The curves of Fig. 2 show that an optimally damped buoy responds efficiently to a relatively narrow band of wave periods. Overdamping produces a less peaky response curve, which may be interesting since real waves comprehend a range of frequencies.

A radius value  $a_{\text{opt}} = 26.2 \text{ m}$  is too large to be practical and economical. Indeed, the early researchers in the mid-1970s realized that “small” buoys or “point absorbers” (say diameter up to 10–15 m) would perform very poorly in the waves typical of the wide oceans. In section 4 we will mention control strategies that were devised to improve the performance of wave energy converters, especially point absorbers.

The results briefly mentioned above for single-mode oscillators were subsequently extended to oscillating-body converters with more than one degree of freedom and to multi-body converters. David V. Evans (in England), Johannes Falnes and Kjell Budal (1933–1989) (in Norway), John Nicholas Newman and Chiang C. Mei (in USA), and others were pioneers who made fundamental contributions in the second half of the 1970s, that were subsequently reviewed by Evans [36] (see also ref. [37]).

Although oscillating water columns (OWCs) were among the first wave energy converters to be developed and reach the full-sized prototype stage, their modelling was done a few years later [38–40], since it did not benefit from existing ship-hydrodynamics theory to the same extent as oscillating body converters did.

A linear PTO (in addition to regular waves) is a basic assumption in the frequency-domain analysis underlying the early results outlined above. Since, in practice, most converters are equipped with strongly nonlinear mechanisms, a time-domain theory had to be developed. This was done in 1980 for oscillating-body converters by Jefferys [41], closely following the theory, based on Fourier transform techniques, developed for ship hydrodynamics by Cummins [42]. For the case of the floater oscillating in heave considered above, the time-domain equation of motion can be written as

$$(m + A(\infty))\ddot{x}(t) + \rho g S x(t) + \int_{-\infty}^t L(t - \tau)\dot{x}(\tau) d\tau = f_d(t) + f_{\text{PTO}}, \quad (8)$$

where

$$L(t) = \frac{2}{\pi} \int_0^{\infty} \frac{B(\omega)}{\omega} \sin \omega t d\omega.$$

In Eq. (8), the radiation force is represented by the convolution integral, which shows the dependence on the past motion of the body.

The time-domain model produces time-series and is the appropriate tool for active-control studies of converters in irregular waves (see Section 4). However it requires much more computing time as compared with the frequency-domain analysis. An alternative approach, that is computationally much less demanding (although limited to linear or nearly linear PTO), is the stochastic modelling which produces probability density distributions rather than time-series [43,44]. This was successfully used in optimisation procedures involving a very large number of simulations [45].

Large numbers of devices in arrays are required if wave energy is to provide a significant contribution to large electrical grids. The hydrodynamic interaction between devices was first studied theoretically for systems of oscillating bodies by Budal [46], Falnes and Budal [47], Evans [48], and later extended to systems of OWCs by Evans [39]. However, if the number of devices in the array is not small, the interactions become extremely complex and approximate methods have in practice to be devised, like the multiple-scattering method, the plane-wave method and the

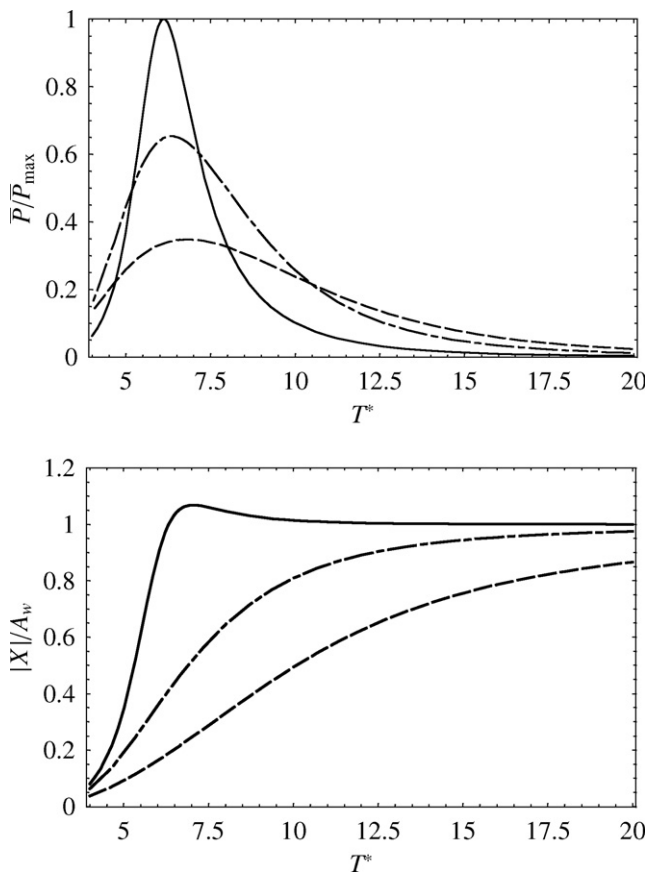

Fig. 2. Dimensionless performance curves versus wave period, of a heaving hemisphere with a simple linear-damping PTO. Solid lines: optimal damping  $C^* = 0.510$ ; chain lines:  $C^* = 2$ ; broken lines:  $C^* = 5$ .

point-absorber approximation. This was dealt with in a European Commission project in the mid-1990s (see ref. [49]).

The book by Falnes [50], himself one of the most distinguished pioneers in the theoretical hydrodynamics of wave energy absorption, is now the standard text book in these hydrodynamic studies.

### 3.2. Model testing

In the development and design of a wave energy converter, the energy absorption may be studied theoretically/numerically, or by testing a physical model in a wave basin or wave flume. The techniques to be applied are not very different from those in the hydrodynamics of ships in a wavy sea. Numerical modelling is to be applied in the first stages of the plant design. The main limitations lie in its being unable to account for losses in water due to real (viscous) fluid effects (large eddy turbulence) and not being capable to model accurately large amplitude water oscillations (nonlinear waves). Such effects are known to be important (they also occur in naval engineering and in off-shore structures, where more or less empirical corrections are currently applied). For these reasons, model tests (scales 1:80 to 1:10) are carried out in wave basin when the final geometry of the plant is already well established.

Stephen Salter is widely regarded as the pioneer in model testing of wave energy converters. In 1974 he started the experimental development of the “duck” concept in a narrow wave flume at the University of Edinburgh. Salter’s experimental facilities were greatly improved with the construction, in 1977, of the 10 m × 27.5 m × 1.2 m “wide tank” equipped with 89 independently driven paddles, that made Edinburgh the leading centre for the experimental development in wave energy conversion (for detailed information, including early photographs, see ref. [51]). Later, as the development of wave energy converter concepts progressed towards the prototype construction stage, the need of larger-scale testing required the use of very large laboratory facilities. This was the case, in Europe, of the large wave tanks in Trondheim (Norway), Wageningen (Netherlands) and Nantes (France).

## 4. Control

The utilization of wave energy involves a chain of energy conversion processes, each of which is characterized by its efficiency as well as the constraints it introduces, and has to be controlled. Particularly relevant is the hydrodynamic process of wave energy absorption, to which reference was made in the previous section.

The early theoretical studies on oscillating-body and OWC converters revealed that, if the device is to be an efficient absorber, its own frequency of oscillation should match the frequency of the incoming waves, i.e. it should operate at near-resonance conditions. The ignorance of this rule underlies many failures by inventors who regarded such systems as quasi-static (i.e. simply follow the wave surface motion) rather than dynamic. In practice, the frequency-matching meets with serious difficulties: (i) in most cases, except if the body (or the OWC) is quite large (this meaning possibly sizes substantially larger than 10 m, see Section 3 above), its own frequency of oscillation is too high as compared with typical ocean-wave frequencies; (ii) real waves are not single-frequency.

As shown in Section 3, for a single-mode oscillating body in regular waves, resonance (and maximum energy absorption) occurs when the body velocity is in phase with the excitation force (rather than with the total force on the wetted surface). Acting on the PTO to achieve such phase coincidence has been named phase-control. Several phase-control strategies have been proposed, including for devices in real irregular waves (for a review, see Falnes, [52]). We saw, in Section 3.1, that the frequency of resonance  $\omega$  of point absorbers (as given by Eq. (5) with  $K = 0$ , i.e. a

PTO consisting of pure linear damping) is in general significantly higher than typical wave frequencies in the open ocean. Obviously, the solution  $\omega$  of Eq. (5) can be lowered by allowing the spring stiffness  $K$  to take negative values. This is called reactive phase control. Fig. 3 shows the modifications to Fig. 2 if a spring of negative stiffness  $K = -\rho g S/2$  (i.e. the spring force is half the hydrostatic restoring force and of opposite sign) is introduced into the PTO. Optimal performance,  $\bar{P}/\bar{P}_{\max} = 1$ , now occurs at a larger dimensionless period  $T^* \approx 9.2$  (as compared with 6.1). Fig. 3 (as compared with Fig. 2) also shows the amplitude of body oscillations close to resonance to be substantially larger.

Apart from the impracticality of a negative mechanical spring in reactive phase control, this introduces another problem. Since the PTO force is no longer in phase with the body velocity, the energy flow direction is reversed during part of the wave cycle, with negative consequences if the reactive power peaks are not small and (friction) losses are significant in the two-way energy transfer process.

An alternative control method that avoids the energy flow reversal was proposed by Budal and Falnes [47] (see also ref. [53]) and consists in latching the device in a fixed position during certain intervals of the wave cycle so as to achieve approximate optimal phase control. Although latching should be regarded as suboptimal phase control as compared with optimal reactive phase control, it has been found that theoretically it may be almost as efficient [54] for a single-body converter. To optimally determine such latched time-intervals in real random waves turned out to be a complicated theoretical control problem, which, in addition to relatively heavy computing, requires the prediction of the incoming irregular waves some time into the future. Recently, an alternative to latching has been proposed and analysed, named unclutching, that also avoids the energy flow reversal [55]. It consists in switching on and off alternatively the wave energy

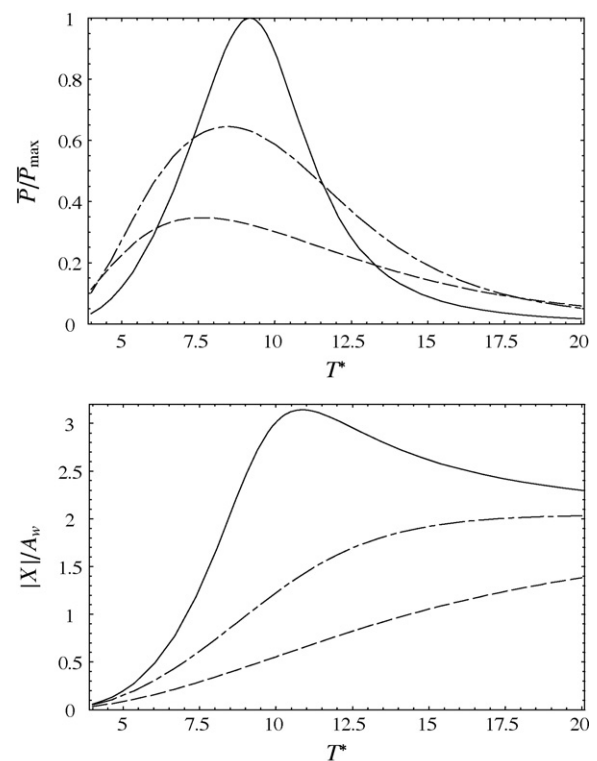

Fig. 3. Dimensionless performance curves versus wave period, of a heaving hemisphere with a reactive phase-controlled PTO consisting of a linear damper and a spring of negative stiffness  $K = -\rho g S/2$ . Solid lines: damping  $C = 0.510$ ; chain lines:  $C = 2$ ; broken lines:  $C = 5$ .

converter's PTO. Apart from the pioneers Falnes and Budal, phase control (including latching) was the object of theoretical studies from other researchers, namely Naito and Nakamura [56], who established the relation between causality and optimum control of wave energy converters, Nancy Nichols and her co-workers [57,58], who applied the maximum principle of Pontryagin to numerically solve the problem, and Korde [59] who studied the phase control of converters with several degrees of freedom. Sub-optimal phase control in real random waves and its practical implementation in wave energy converters remains an open problem.

**5. The various technologies**

Unlike large wind turbines, there is a wide variety of wave energy technologies, resulting from the different ways in which energy can be absorbed from the waves, and also depending on the water depth and on the location (shoreline, near-shore, offshore). Recent reviews identified about one hundred projects at various stages of development. The number does not seem to be decreasing: new concepts and technologies replace or outnumber those that are being abandoned.

Several methods have been proposed to classify wave energy systems, according to location, to working principle and to size ("point absorbers" versus "large" absorbers). The classification in Fig. 4 is based mostly on working principle. The examples shown are not intended to form an exhaustive list and were chosen among the projects that reached the prototype stage or at least were object of extensive development effort.

**6. The oscillating water column (OWC)**

*6.1. Fixed-structure OWC*

Based on various energy-extracting methods, a wide variety of systems has been proposed but only a few full-sized prototypes

have been built and deployed in open coastal waters. Most of these are or were located on the shoreline or near shore, and are sometimes named first generation devices. In general these devices stand on the sea bottom or are fixed to a rocky cliff. Shoreline devices have the advantage of easier installation and maintenance, and do not require deep-water moorings and long underwater electrical cables. The less energetic wave climate at the shoreline can be partly compensated by natural wave energy concentration due to refraction and/or diffraction (if the device is suitably located for that purpose). The typical first generation device is the oscillating water column. Another example is the overtopping device Tapchan (Tapered Channel Wave Power Device), a prototype of which was built on the Norwegian coast in 1985 and operated for several years (see Section 8).

The oscillating water column (OWC) device comprises a partly submerged concrete or steel structure, open below the water surface, inside which air is trapped above the water free surface (Fig. 5). The oscillating motion of the internal free surface produced by the incident waves makes the air to flow through a turbine that drives an electrical generator. The axial-flow Wells turbine, invented in the mid 1970s, has the advantage of not requiring rectifying valves. It has been used in most prototypes.

Full sized OWC prototypes were built in Norway (in Toftestallen, near Bergen, 1985, [60]), Japan (Sakata, 1990, [61]), India (Vizhinjam, near Trivandrum, Kerala state, 1990, [20]), Portugal (Pico, Azores, 1999, [62]), UK (the LIMPET plant in Islay island, Scotland, 2000, [63]). The largest of all, a nearshore bottom-standing plant (named OSPREY) was destroyed by the sea (in 1995) shortly after having been towed and sunk into place near the Scottish coast. In all these cases, the structure is fixed (bottom-standing or built on rocky sloping wall) and the main piece of equipment is the Wells air turbine driving an electrical generator. Except for the OSPREY, the structure was made of concrete. The cross-sectional area of these OWCs (at mid water-free-surface level) lies in the range 80–250 m<sup>2</sup>. Their installed power capacity is (or was) in the range 60–500 kW (2 MW for OSPREY). Smaller

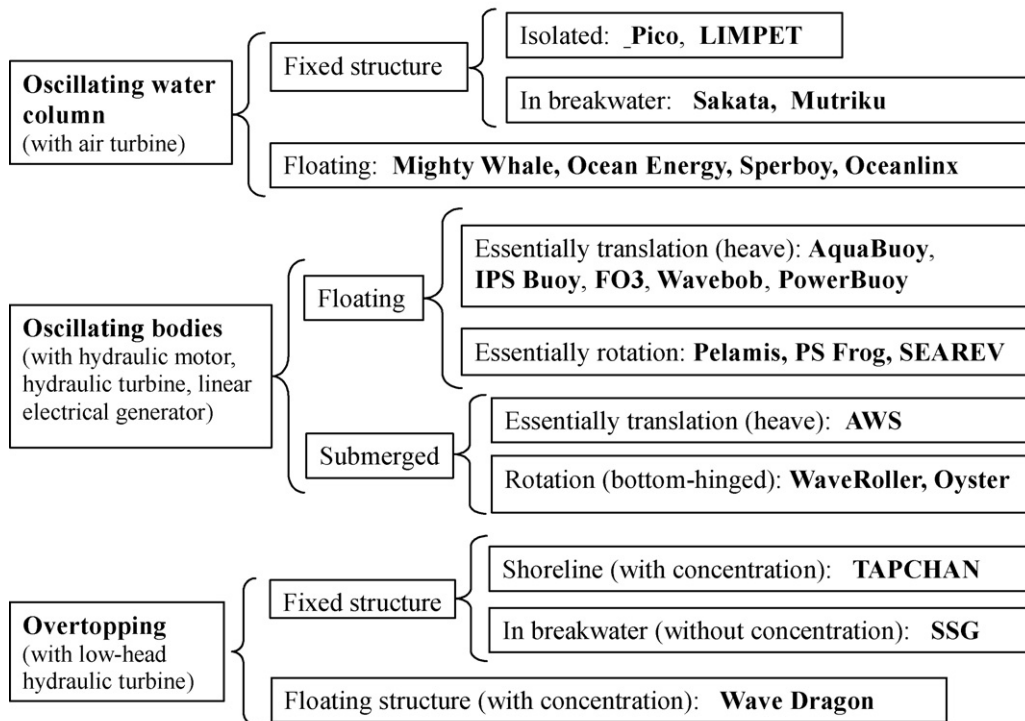

Fig. 4. The various wave energy technologies.

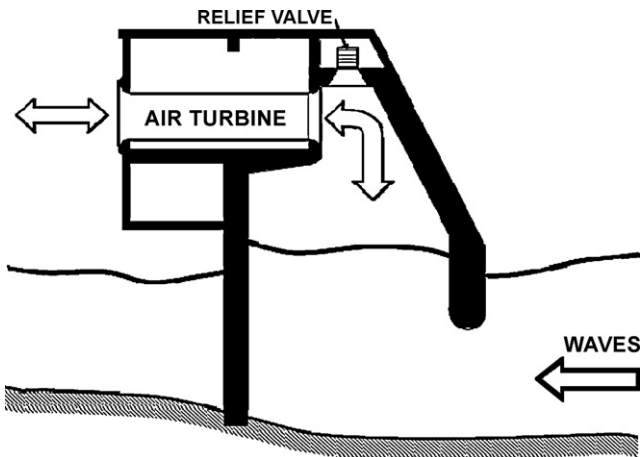

Fig. 5. Cross-sectional view of a bottom-standing OWC (Pico plant).

shoreline OWC prototypes (also equipped with Wells turbine) were built in Islay, UK (1991, [64]), and more recently in China.

It has been found theoretically [65] and experimentally since the early 1980s that the wave energy absorption process can be enhanced by extending the chamber structure by protruding (natural or man-made) walls in the direction of the waves, forming a harbour or a collector. This concept has been put into practice in most OWC prototypes. The Australian company Energetech developed a technology using a large parabolic-shaped collector (shaped like a Tapchan collector) for this purpose (a nearshore prototype was tested at Port Kembla, Australia, in 2005 [66]); the main novelty lies mostly in the large size of the converging wall compared with the dimensions of the OWC itself [67].

The design and construction of the structure (apart from the air turbine) are the most critical issues in OWC technology, and the most influential on the economics of energy produced from the waves. In the present situation, the civil construction dominates the cost of the OWC plant. The integration of the plant structure into a breakwater has several advantages: the constructional costs are shared, and the access for construction, operation and maintenance of the wave energy plant become much easier. This has been done successfully for the first time in the harbour of Sakata, Japan, in 1990 [61], where one of the caissons making up the breakwater had a special shape to accommodate the OWC and the mechanical and electrical equipment. The option of the "breakwater OWC" was adopted in the 0.75 MW twin-chamber OWC plant planned to be installed in the head of a breakwater in the mouth of the Douro river (northern Portugal) [68] and in the recently constructed breakwater at the port of Mutriku, in northern Spain, with 16 chambers and 16 Wells turbines rated 18.5 kW each [69]. A different geometry for an OWC embedded into a breakwater was proposed by Boccotti [70], approaching a quasi-two-dimensional terminator configuration, with an OWC that is long in the wave crest direction but narrow (small aperture) in the fore-aft direction. The OWC cross-section is J-shaped, with its outer opening facing upwards. A field experiment was carried out off the eastern coast of the straits of Messina, in southern Italy [71].

## 6.2. Floating-structure OWC

As mentioned above in section 1, the first OWC converters deployed in the sea were floating devices developed in Japan in the 1960s and 1970s under the leadership of Yoshio Masuda: the wave-powered navigation buoys and the large Kaimei barge. Masuda realized that the wave-to-pneumatic energy conversion of Kaimei was quite unsatisfactory and conceived a different geometry for a floating OWC: the Backward Bent Duct Buoy

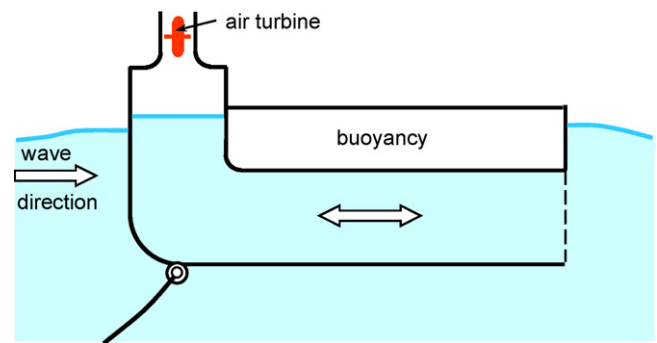

Fig. 6. Schematic representation of the Backward Bent Duct Buoy (BBDB).

(BBDB). In the BBDB, the OWC duct is bent backward from the incident wave direction (Fig. 6) (which was found to be advantageous in comparison with the frontward facing duct version) [72]. In this way, the length of the water column could be made sufficiently large for resonance to be achieved, while keeping the draught of the floating structure within acceptable limits. The BBDB converter was studied (including model testing) in several countries (Japan, China, Denmark, Korea, Ireland) and was used to power about one thousand navigation buoys in Japan and China [73,74]. In the last few years, efforts have been underway in Ireland to develop a large BBDB converter for deployment in the open ocean. A 1/4th-scale 12 m-long model equipped with a horizontal-axis Wells turbine has been tested in the sheltered sea waters of Galway Bay (western Ireland) since the end of 2006 [75].

The Mighty Whale, another floating OWC converter, was developed by the Japan Marine Science and Technology Center. After theoretical investigations and wave tank testing, a full-sized prototype was designed and constructed. The device consists of a floating structure (length 50 m, breadth 30 m, draught 12 m, displacement 4400 t) which has three air chambers located at the front, side by side, and buoyancy tanks [76]. Each air chamber is connected to a Wells air turbine that drives an electric generator. The total rated power is 110 kW. The device was deployed near the mouth of Gokasho Bay, in Mie Prefecture, Japan, in 1998 and tested for several years.

The Spar Buoy is possibly the simplest concept for a floating OWC. It is an axisymmetric device (and so insensitive to wave direction) consisting basically of a (relatively long) submerged vertical tail tube open at both ends, fixed to a floater that moves essentially in heave. The length of the tube determines the resonance frequency of the inner water column. The air flow displaced by the motion of the OWC relative to the buoy drives an air turbine. Several types of wave-powered navigation buoys have been based on this concept, which has also been considered for larger scale energy production. The Sloped Buoy has some similarities with the Spar Buoy and consists of a buoy with three sloped immersed tail tubes such that the buoy-tube set is made to oscillate at an angle intermediate between the heave and surge directions.

A report prepared for the British Department of Trade and Industry (DTI) compared three types of floating OWCs for electricity generation in an Atlantic environment: BBDB, Sloped Buoy and Spar Buoy [77].

The floating OWC devices briefly described above are slack-moored to the sea bed and so are largely free to oscillate (which may enhance the wave energy absorption if the device is properly designed for that). The Orecon, under development in UK, is a floating OWC device that is tension moored to the sea bed. It is a multi-resonance converter with several vertical OWCs of different lengths, each chamber being connected to an air turbine [78].

## 7. Oscillating body systems

Offshore devices (sometimes classified as third generation devices) are basically oscillating bodies, either floating or (more rarely) fully submerged. They exploit the more powerful wave regimes available in deep water (typically more than 40 m water depth). Offshore wave energy converters are in general more complex compared with first generation systems. This, together with additional problems associated with mooring, access for maintenance and the need of long underwater electrical cables, has hindered their development, and only recently some systems have reached, or come close to, the full-scale demonstration stage.

### 7.1. Single-body heaving buoys

The simplest oscillating-body device is the heaving buoy reacting against a fixed frame of reference (the sea bottom or a bottom-fixed structure). In most cases, such systems are conceived as point absorbers (i.e. their horizontal dimensions are much smaller than the wavelength).

An early attempt was a device named G-1T, consisting of a wedge-shaped buoy of rectangular planform (1.8 m × 1.2 m at water line level) whose vertical motion was guided by a steel structure fixed to a breakerwater. The used PTO was an early example of the hydraulic ram in a circuit including a gas accumulator. The tests, performed in Tokyo Bay in 1980, are reported in [79].

Another early example was the Norwegian buoy, consisting of a spherical floater which could perform heaving oscillations relative to a strut connected to an anchor on the sea bed through a universal joint [80]. The buoy could be phase-controlled by latching and was equipped with an air turbine. A model (buoy diameter = 1 m), in which the air turbine was simulated by an orifice, was tested (including latching control) in the Trondheim Fjord in 1983 (Fig. 7).

An alternative design is a buoy connected to a bottom-fixed structure by a cable which is kept tight by a spring or similar



Fig. 7. Norwegian heaving buoy in Trondheim Fjord, 1983 (courtesy of J. Falnes).

device. The relative motion between the wave-activated float on the sea surface and the seabed structure activates a PTO system. In the device that was tested in Denmark in the 1990s, the PTO (housed in a bottom-fixed structure) consisted in a piston pump supplying high-pressure water to a hydraulic turbine [81].

A version of the taut-moored buoy concept is being developed at Uppsala University, Sweden, and uses a linear electrical generator (rather than a piston pump) placed on the ocean floor [82]. A line from the top of the generator is connected to a buoy located at the ocean surface, acting as power takeoff. Springs attached to the translator of the generator store energy during half a wave cycle and simultaneously act as a restoring force in the wave troughs (Fig. 8). Sea tests off the western coast of Sweden of a 3 m diameter cylindrical buoy are reported in [82].

Another system with a heaving buoy driving a linear electrical generator was recently developed at Oregon State University, USA [83]. It consists of a deep-draught spar and an annular saucer-shaped buoy (Fig. 9). The spar is taut-moored to the sea bed by a cable. The buoy is free to heave relative to the spar, but is constrained in all other degrees of freedom by a linear bearing system. The forces imposed on the spar by the relative velocity of the two bodies is converted into electricity by a permanent magnet linear generator. The spar is designed to provide sufficient buoyancy to resist the generator force in the down direction. A 10 kW prototype L-10 (buoy outer radius 3.5 m, spar length 6.7 m) was deployed off Newport, Oregon, in September 2008, and tested [82].

### 7.2. Two-body heaving systems

The concept of a single floating body reacting against the sea floor may raise difficulties due to the distance between the free surface and the bottom and/or to tidal oscillations in sea level. Multi-body systems may be used instead, in which the energy is converted from the relative motion between two bodies oscillating differently. The hydrodynamics of two-body systems was theoretically analysed in detail by Falnes [84]. Multi-body wave energy converters raise special control problems [59,85,86].

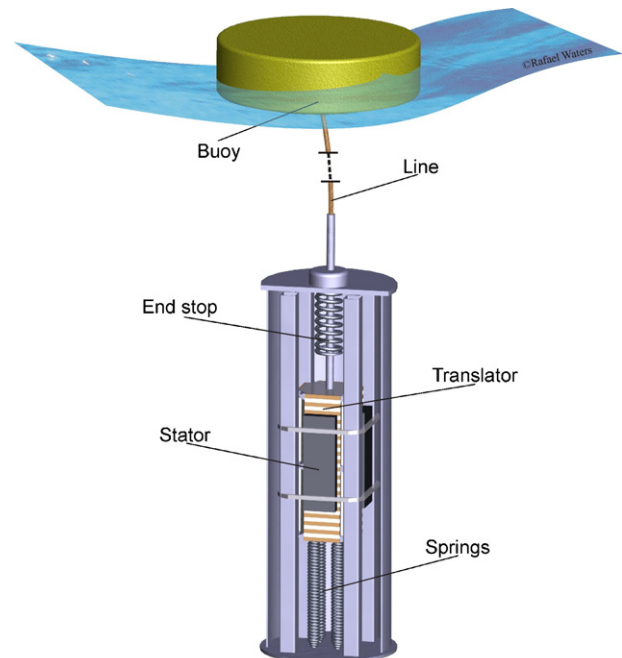

Fig. 8. Swedish heaving buoy with linear electrical generator (courtesy of Uppsala University).

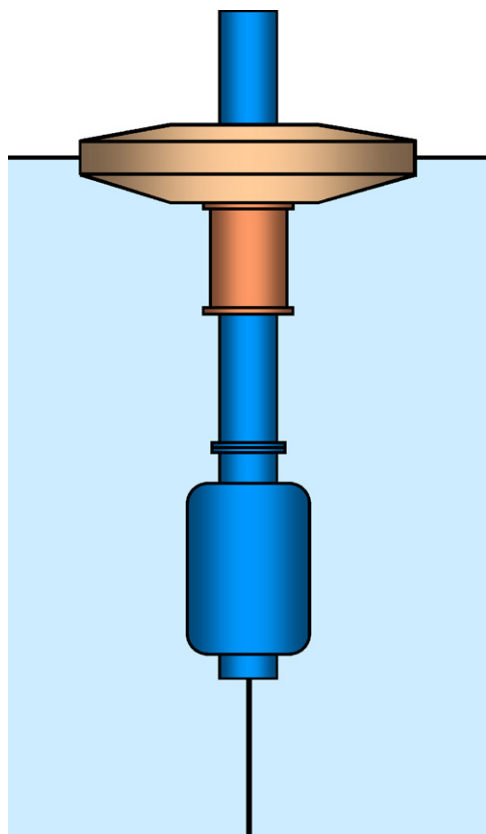

Fig. 9. L-10 wave energy converter with linear electrical generator, developed at Oregon State University.

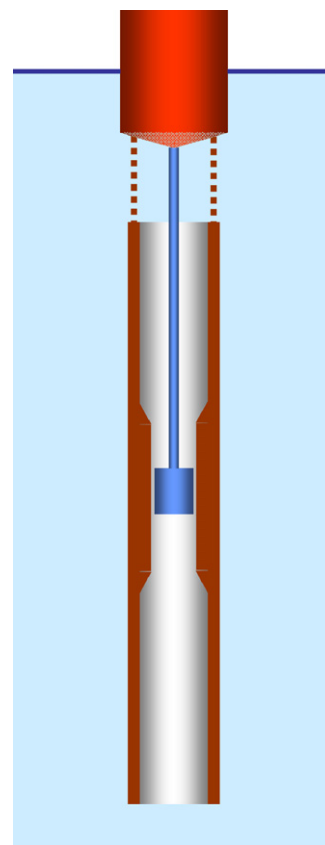

Fig. 10. Schematic representation of the IPS buoy.

The Bipartite Point Absorber concept [87] is an early example of a two-point heaving system. It consists of two floaters, the outer one (with very low resonance frequency) being a structure that acts as the reference and the inner one acting as the resonating absorber. This device incorporates a concept that was later to be adopted in the Wavebob (see below): the mass of the inner body is increased (without significantly affecting the diffraction and radiation damping forces) by rigidly connecting it to a fully submerged body located sufficiently far underneath.

One of the most interesting two-body point absorbers for wave energy conversion is the IPS buoy, invented by Sven A. Noren [88] and initially developed in Sweden by the company Interproject Service (IPS). This consists of a buoy rigidly connected to a fully submerged vertical tube (the so-called acceleration tube) open at both ends (Fig. 10). The tube contains a piston whose motion relative to the floater-tube system (motion originated by wave action on the floater and by the inertia of the water enclosed in the tube) drives a power take-off (PTO) mechanism. The same inventor later introduced an improvement that significantly contributes to solve the problem of the end-stops: the central part of the tube, along which the piston slides, bells out at either end to limit the stroke of the piston [89]. A half-scale prototype of the IPS buoy was tested in sea trials in Sweden, in the early 1980s [90]. The AquaBuOY is a wave energy converter, developed in the 2000s, that combines the IPS buoy concept with a pair of hose pumps to produce a flow of water at high pressure that drives a Pelton turbine [91]. A prototype of the AquaBuOY was deployed and tested in 2007 in the Pacific Ocean off the coast of Oregon. A variant of the initial IPS buoy concept, due to Stephen Salter, is the sloped IPS buoy: the natural frequency of the converter may be reduced, and in this way the capture width enlarged, if the buoy-tube set is made to oscillate at an angle intermediate between the heave and

the surge directions. The sloped IPS buoy has been studied since the mid-1990s at the University of Edinburgh, by model testing and numerical modelling [92–94].

The Wavebob, under development in Ireland, is another two-body heaving device [95]. It consists of two co-axial axisymmetric buoys, whose relative axial motions are converted into electric energy through a high-pressure-oil system (Fig. 11). The inner buoy (body 2 in Fig. 11) is rigidly connected to coaxial submerged body located underneath, whose function is to increase the inertia (without reduction in the excitation and radiation hydrodynamic forces) and allow the tuning to the average wave frequency. A large (1/4th scale) model has been tested in the sheltered waters of Galway Bay (Ireland).

The American company Ocean Power Technologies developed another axisymmetric two-body heaving WEC named PowerBuoy. A disc-shaped floater reacts against a submerged cylindrical body, terminated at its bottom end by a large horizontal damper plate whose function is to increase the inertia through the added mass of the surrounding water. The relative heaving motion between the two bodies is converted into electrical energy by means of a hydraulic PTO. A 40 kW prototype without grid connection was deployed off the coast of Santoña, in northern Spain, in September 2008 (Fig. 12). This is planned to be followed by a farm of 9 buoys rated at 150 kW each, the first version of which will be deployed in Scotland in 2009.

### 7.3. Fully submerged heaving systems

The Archimedes Wave Swing (AWS), a fully submerged heaving device, was basically developed in Holland, and consists of an oscillating upper part (the floater) and a bottom-fixed lower part (the basement) (Fig. 13) [96]. The floater is pushed down under a

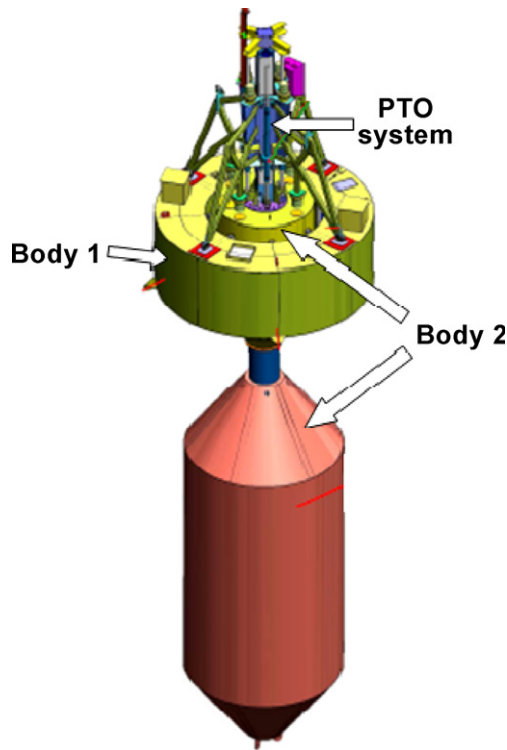

Fig. 11. Wavebob (courtesy of Wavebob Ltd).

wave crest and moves up under a wave trough. This motion is resisted by a linear electrical generator, with the interior air pressure acting as a spring. The AWS device went for several years through a programme of theoretical and physical modelling. A prototype was built, rated 2 MW (maximum instantaneous power). After unsuccessful trials in 2001 and 2002 to sink it into position off the northern coast of Portugal, it was finally deployed and tested in the second half of 2004 [97]. The AWS was the first converter using a linear electrical generator.

#### 7.4. Pitching devices

The oscillating-body wave energy converters briefly described above are nominally heaving systems, i.e. the energy conversion is associated with a relative translational motion. (It should be noted that, in some of them the mooring system allows other oscillation modes, namely surge and pitch). There are other oscillating-body systems in which the energy conversion is based on relative



Fig. 12. The PowerBuoy prototype deployed off Santoño, Spain, in 2008 (courtesy of Ocean Power Technologies).

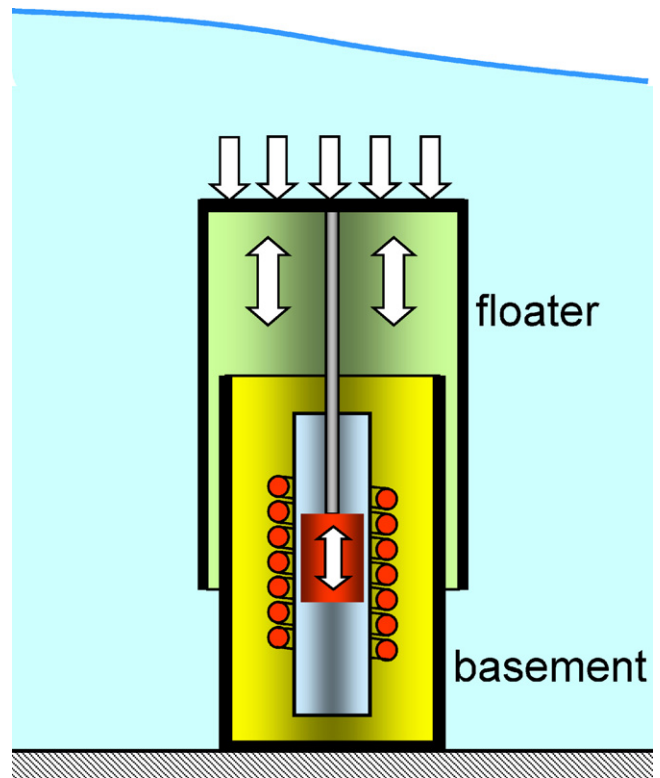

Fig. 13. Schematic representation of the Archimedes Wave Swing.

rotation (mostly pitch) rather than translation. This is remarkably the case of the nodding Duck (created by Stephen Salter, from the University of Edinburgh) probably the best known offshore device among those that appeared in the 1970s and early 1980s [16], and of which several versions were developed in the following years [98]. Basically it is a cam-like floater oscillating in pitch. The first versions consisted of a string of Ducks mounted on a long spine aligned with the wave crest direction, with a hydraulic-electric PTO system. Salter later proposed the solo duck, in which the frame of reference against which the nodding duck reacts is provided by a gyroscope (Fig. 14). Although the Duck concept was object of extensive R&D efforts for many years, including model testing at several scales [2], it never reached the stage of full-scale prototype in real seas.



Fig. 14. The Duck version of 1979 equipped with gyroscopes (courtesy of University of Edinburgh).



Fig. 15. The three-unit  $3 \times 750$  kW Pelamis wave farm in calm sea off northern Portugal, in 2008 (courtesy of R. Barros).

Among the wide variety of devices proposed in the 1970s and 1980s that did not succeed in reaching full-size testing stage (see [2]), reference should be made to the Raft invented by Sir Christopher Cockerell (who was also the inventor of the Hovercraft). This was actually a series of rafts or pontoons linked by hinges, that followed the wave contour, with a PTO system (possibly hydraulic) located at each hinge [2,17]. The Cockerell Raft may be regarded as the predecessor of a more successful device, the Pelamis, and also of the McCabe Wave Pump (see below).

The Pelamis, developed in UK, is a snake-like slack-moored articulated structure composed of four cylindrical sections linked by hinged joints, and aligned with the wave direction. The wave-induced motion of these joints is resisted by hydraulic rams, which pump high-pressure oil through hydraulic motors driving three electrical generators. Gas accumulators provide some energy storage. As other devices that reached full size, the Pelamis was the object of a detailed development program over several years, that included theoretical/numerical modelling and physical model testing at several scales [99,100]. Sea trials of a full-sized prototype (120 m long, 3.5 m diameter, 750 kW rated power) took place in 2004 in Scotland. A set of three Pelamis devices was deployed off the Portuguese northern coast in the second half of 2008 (Fig. 15), making it the first grid-connected wave farm worldwide.

The McCabe Wave Pump has conceptual similarities to the Cockerell Raft and the Pelamis: it consists of three rectangular steel pontoons hinged together, with the heaving motion of the central pontoon damped by a submerged horizontal plate [101] (Fig. 16). Two sets of hydraulic rams and a hydraulic PTO convert the relative rotational motions of the pontoons into useful energy. A 40 m long

prototype was deployed in 1996 off the coast of Kilbaha, County Clare, Ireland.

Two-body systems have been conceived in which only one body is in contact with the water: the other body is located above the water or is totally enclosed inside the wetted one (see ref. [102] for an early example). The theoretical modelling and control of such devices (especially heaving ones and including also three-body systems) has been analysed by Korde [59,103].

A typical device based on the totally enclosed hull concept is the Frog, of which several offshore point-absorber versions have been developed at Lancaster University, UK. The PS Frog Mk 5 consists of a large buoyant paddle with an integral ballasted handle hanging below it [104,105] (Fig. 17). The waves act on the blade of the paddle and the ballast beneath provides the necessary reaction. When the WEC is pitching, power is extracted by partially resisting the sliding of a power-take-off mass, which moves in guides above sea level.

The Searev wave energy converter, developed at Ecole Centrale de Nantes, France [106], is a floating device enclosing a heavy horizontal-axis wheel serving as an internal gravity reference (Fig. 18). The centre of gravity of the wheel being off-centred, this component behaves mechanically like a pendulum. The rotational motion of this pendular wheel relative to the hull activates a hydraulic PTO which, in turn, sets an electrical generator into motion. Major advantages of this arrangement are that (i) (like the Frog) all the moving parts (mechanic, hydraulic, electrical components) are sheltered from the action of the sea inside a closed hull, and (ii) the choice of a wheel working as a pendulum involve neither end-stops nor any security system limiting the stroke.

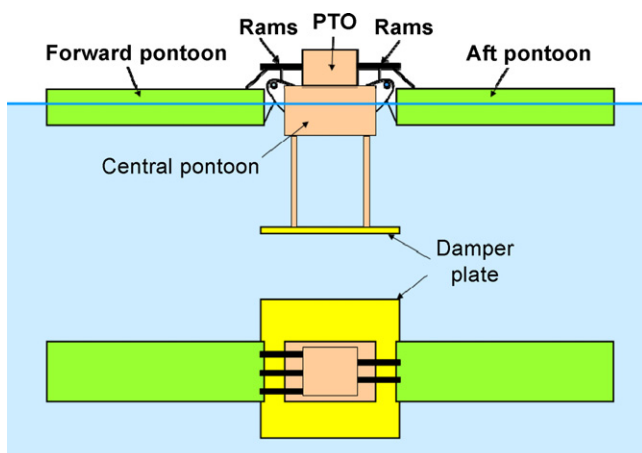

Fig. 16. Side and plan views of the McCabe Wave Pump.

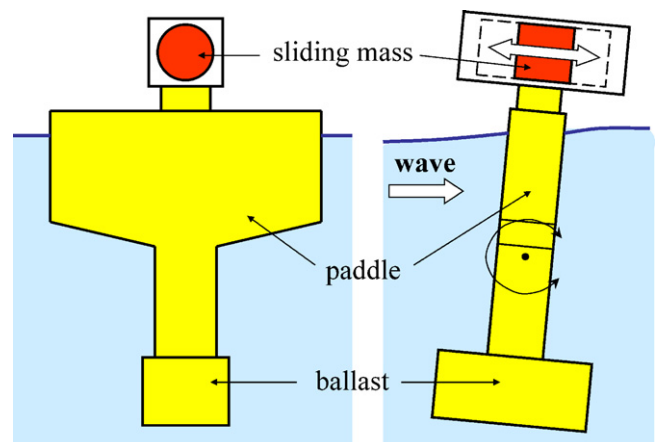

Fig. 17. Front and side views of the PS Frog Mk 5.

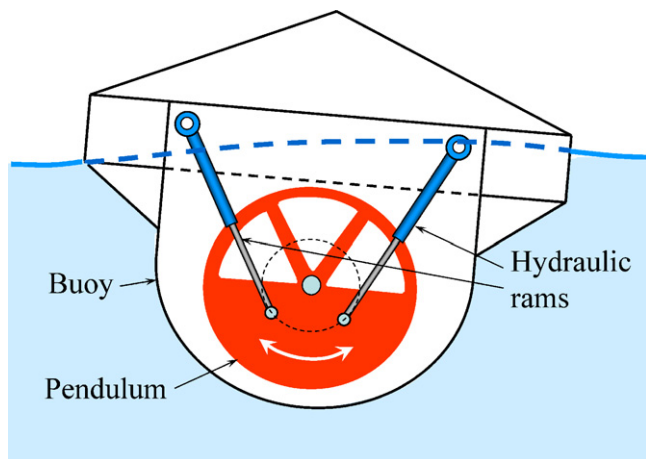

Fig. 18. Schematic representation of the Searev.

The Spanish company OceanTec is developing another offshore floating energy converter that extracts energy basically from the pitching motion. It has the shape of an elongated horizontal cylinder with ellipsoidal ends whose major axis is aligned with the incident wave direction [107]. The energy conversion process is based on the relative inertial motion that the waves cause in a gyroscopic system [108]. This motion is used to feed an electrical generator through a series of transformation stages. A 1/4th scale prototype (11.25 m long) was deployed off the coast of Guipúzcoa (northern Spain) in September 2008 and was tested for several months [107].

#### 7.5. Bottom-hinged systems

Single oscillating-body devices operating in pitching mode have been proposed, based on the inverted pendulum hinged at the sea bed concept. The mace, invented by Stephen Salter [109], consists of a buoyant spar, with symmetry about the vertical axis, that can swing about a universal joint at the sea bottom (Fig. 19). The power take-off reaction to the sea bed is via a set of cables wound several times round a winch-drum leading both fore and aft in the prevailing wave direction. The wave-activated reciprocating rotation of the drum is converted into useful energy by means of a hydraulic system.

Two devices are presently under development that share the same basic concept: a buoyant flap hinged at the sea bed, whose pitching oscillations activate a set of double-acting hydraulic rams

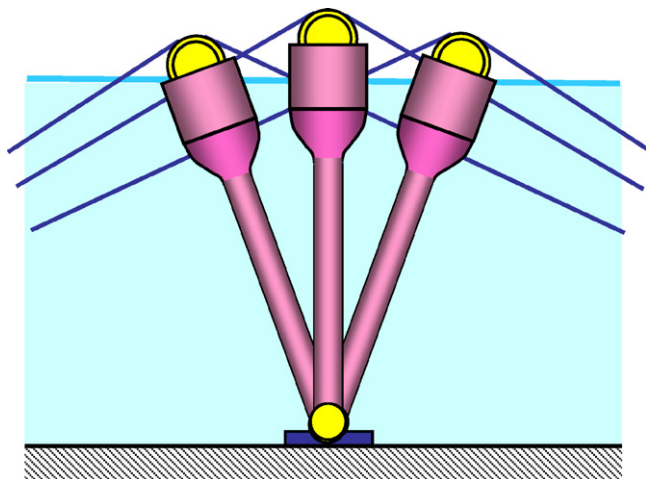

Fig. 19. The swinging mace in three angular positions.



Fig. 20. Oyster prototype (courtesy of Aquamarine Power).

located on the sea bed that pump high pressure fluid to shore via a sub-sea pipeline. The fluid flow is converted into electric energy by a conventional hydraulic circuit. These devices are intended for deployment close to shore in relatively shallow water (10–15 m). Apart from size (the Oyster is larger) and detailed design, there are some conceptual differences between them. The Oyster (under development in UK) has a surface piercing flap that spans the whole water depth and the fluid is sea water powering a Pelton turbine located onshore [110], whereas the WaveRoller (a Finish device) is totally submerged and uses oil as working fluid [111]. Several swinging flaps can feed a single onshore generator, attached to a single manifold pipeline. A 3.5 m high, 4.5 m wide prototype of the WaveRoller was deployed and tested in 2008 close to the Portuguese coast at Peniche. A large Oyster prototype was built in Scotland (Fig. 20) and is planned to be tested in the sea in 2009. A comparison of designs for small seabed-mounted bottom-hinged wave energy converters can be found in ref. [112].

#### 7.6. Many-body systems

In some cases, the device consists of a large set of floating point absorbers reacting against a common frame and sharing a common PTO. This is the case of FO3 [113] (mostly a Norwegian project), a nearshore or offshore system consisting of an array of 21 axisymmetric buoys (or “eggs”) oscillating in heave with respect to a large floating structure of square planform with very low resonance frequency and housing a hydraulic PTO. The Wave Star, developed in Denmark, consists of two rectilinear arrays of closely spaced floaters located on both sides of a long bottom-standing steel structure that is aligned with the dominant wave direction and houses a hydraulic PTO consisting of a high-pressure-oil hydraulic circuit equipped with hydraulic motors. The waves make the buoys to swing about their common reference frame and pump oil into the hydraulic circuit. A 1/10-scale 24 m long 5.5 kW model with 10 buoys on each side was deployed in 2006 in Nissum Bredning, Denmark, and tested with grid connection for a couple of years [114]. The Brazilian hyperbaric device is based on a similar concept, the main differences being that the reference frame about which the buoys are made to swing is a vertical breakwater, and water is pumped to feed a Pelton turbine. A 1/10-scale model of the hyperbaric device was tested in a large wave tank [115].

## 8. Overtopping converters

A different way of converting wave energy is to capture the water that is close to the wave crest and introduce it, by overtopping, into a reservoir where it is stored at a level higher than the

average free-surface level of the surrounding sea. The potential energy of the stored water is converted into useful energy through more or less conventional low-head hydraulic turbines. The hydrodynamics of overtopping devices is strongly non-linear, and, unlike the cases of oscillating body and OWC wave energy converters, cannot be addressed by linear water wave theory.

The Tapchan (Tapered Channel Wave Power Device), a device developed in Norway in the 1980s, was based on this principle [116]. A prototype (rated power 350 kW) was built in 1985 at Toftehallen, Norway, and operated for several years (for an aerial view see ref. [117]). The Tapchan comprises a collector, a converter, a water reservoir and a low-head water-turbine (Fig. 21). The horn-shaped collector serves the purpose of concentrating the incoming waves before they enter the converter. In the prototype built in Norway, the collector was carved into a rocky cliff and was about 60-m-wide at its entrance. The converter is a gradually narrowing channel with wall heights equal to the filling level of the reservoir (about 3 m in the Norwegian prototype). The waves enter the wide end of the channel, and, as they propagate down the narrowing channel, the wave height is amplified until the wave crests spill over the walls and fill the water reservoir. As a result, the wave energy is gradually transformed into potential energy in the reservoir. The main function of the reservoir is to provide a stable water supply to the turbine. It must be large enough to smooth out the fluctuations in the flow of water overtopping from the converter (about 8500 m<sup>2</sup> surface area in the Norwegian prototype). A conventional low-head Kaplan-type axial flow turbine is fed in this way, its main specificity being the use of corrosion-resistant material.

In other overtopping converters, the incident waves overtop a sloping wall or ramp and fill a reservoir where water is stored at a level higher than the surrounding sea. This is the case of the Wave Dragon, an offshore converter developed in Denmark, whose slack-moored floating structure consists of two wave reflectors focusing the incoming waves towards a doubly curved ramp, a reservoir and a set of low-head hydraulic turbines (Fig. 22) [118]. A 57 m-wide, 237 t (including ballast) prototype of the Wave Dragon (scale 1/4.5 of a North Sea production plant) has been deployed in Nissum Bredning, Denmark, was grid connected in May 2003 and has been tested for several years. Another run-up device based on the slopping wall concept is the Seawave Slot-Cone Generator (SSG)

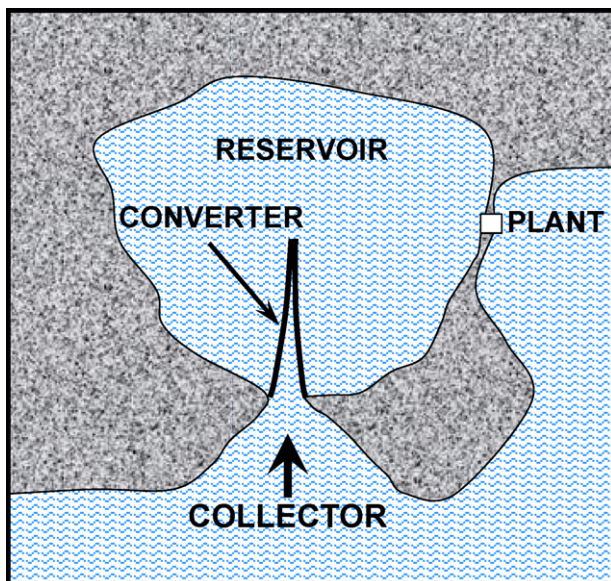

Fig. 21. Schematic plan view of the tapered channel wave power device (Tapchan).

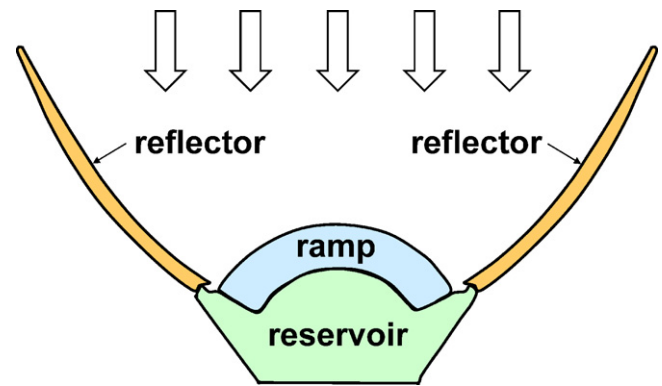

Fig. 22. Plan view of Wave Dragon.

developed (within the framework of a European project) for integration into a caisson breakwater [119,120]. The principle is based on the wave overtopping utilizing a total of three reservoirs placed on top of each other. The water enters the reservoirs through long horizontal openings on the breakwater sloping wall, at levels corresponding to the three reservoirs, and is run through a multi-stage hydraulic turbine for electricity production.

## 9. Power equipment

In all cases considered here, the final product is electrical energy to be supplied to a grid. This energy has to be generated in some kind of electrical machine, either a more or less conventional rotating generator (as in small hydro and wind applications) or a direct-drive linear generator. In the former case, there has to be a mechanical interface that converts the alternative motion (of the oscillating body or body-pair or of the OWC) into a continuous one-directional motion. The most frequently used or proposed mechanical interfaces are air turbines, (low- and high-head) water turbines and (high-pressure oil driven) hydraulic motors. The power equipment is possibly the single most important element in wave energy technology, and underlies many (possibly most) of the failures to date.

Air turbines equipped most of the early (small and large) wave energy converters and are still the favoured PTO for many development teams. Conventional turbines are not appropriate for reciprocating flows, and so new types of turbines had to be devised and developed. Self-rectifying air turbines were probably the object of more published papers than any other piece of equipment for wave energy converters.

More or less conventional low-head hydraulic turbines are used in overtopping devices, whereas high-head (in general Pelton) turbines are an alternative to hydraulic motors in oscillating-body devices.

High-pressure-oil circuits, with rams, gas accumulators and hydraulic motors, have been used in several oscillating-body wave energy converter prototypes, including the Pelamis. This may be regarded as an unconventional use of conventional equipment.

Although linear electrical generators have been proposed since the late 1970s for wave energy devices with translational motion, and have indeed equipped several devices tested in the sea (namely the AWS), they are still at the prototype development stage.

Energy storage capacity is a highly desirable feature in a wave energy converter, and can be provided in a variety of manners, as is the case of the flywheel effect in air turbines, water reservoirs in run-up devices, and gas accumulators in high-pressure hydraulic (water and oil) circuits. The use of large electrical capacitors in connection with linear-generator technology is being envisaged.

It is to be noted that, in his pioneering book on ocean wave energy conversion published in 1981 [1], McCormick dealt in considerable detail with air and water turbines and linear electrical generators, but did not consider oil-hydraulics.

A review of mechanical power-take-off equipment for wave energy converters can be found in [121].

### 9.1. Self-rectifying air turbines

The air turbine of an OWC is subject to much more demanding conditions than the turbines in any other application, including wind turbines. Indeed the flow through the turbine is reciprocating (except if a rectifying system is provided, which so far has been found unpractical), and is random and highly variable over several time scales, ranging from a few seconds to seasonal variations. It is not surprising that the time-averaged efficiency of an air turbine in an OWC is substantially lower than that of a (water, steam, gas, wind) turbine working in nearly steady conditions. Several types of air turbines have been proposed, and in some cases used, in wave energy conversion.

The Wells turbine was invented in the mid-1970s by Dr. Allan Wells (1924–2005) (at that time Professor at Queen's University of Belfast) [122,123]. It is an axial-flow turbine that is self-rectifying, i.e. its torque is not sensitive to the direction of the air flow. Several versions have been studied since then: a single rotor without (the initial version) or with guide vanes (used in Pico, Fig. 23); twin rotors in series (bi-plane, used in Islay I); two counter-rotating rotors (used in OSPREY and in LIMPET-Islay II). All these versions have been object of considerable theoretical and/or experimental R&D, especially in Europe (UK, Portugal, Ireland), Japan, India and China. This gave rise to a substantial number of published papers.

The Wells turbine is clearly the most frequently proposed and/or used air turbine to equip OWC plants. Its favourable features are: (i) high blade to air-flow velocity ratio, which means that a relatively high rotational speed may be attained for a low velocity of air flowing through the turbine (this allows a cheaper generator to be used and also enhances the possibility of storing energy by flywheel effect); (ii) a fairly good peak efficiency (0.7–0.8 for a full-sized turbine); (iii) relatively cheap to construct. The weak points of the Wells turbine are: (i) low or even negative torque at

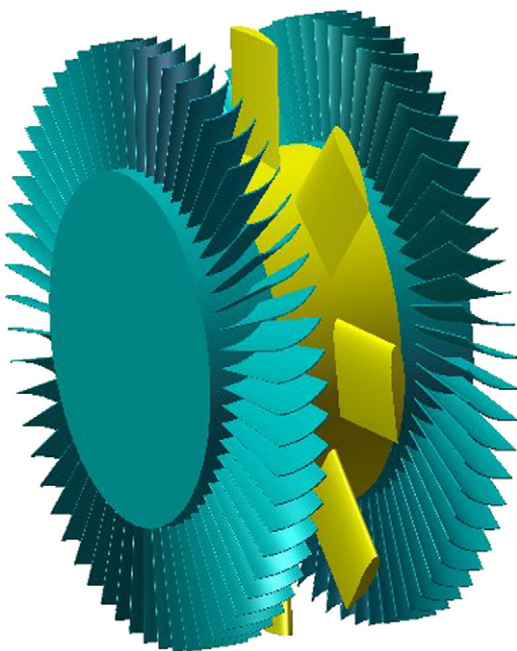

Fig. 23. Wells turbine, version with guide vanes.

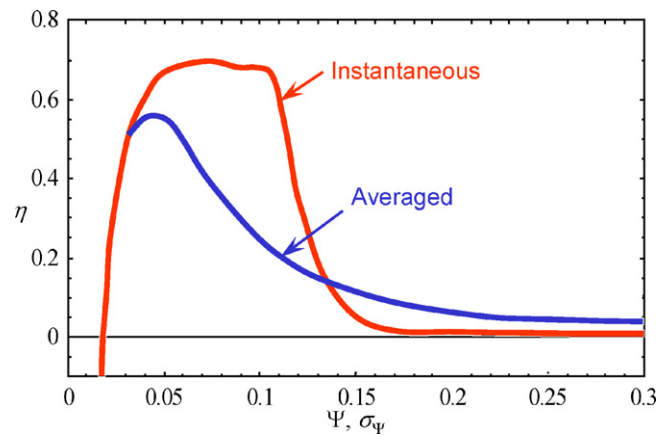

Fig. 24. Aerodynamic efficiency curves of a Wells turbine.

(relatively) small flow rates; (ii) drop (possibly sharp drop) in power output due to aerodynamic losses at flow rates exceeding the stall-free critical value; (iii) aerodynamic noise; (iv) relatively large diameter for its power (2.3 m for the single-rotor 400 kW turbine of the Pico OWC plant, 2.6 m for the counter-rotating 500 kW turbine of the LIMPET Islay II plant, 3.5 m for the Osprey plant). For a review of the Wells turbine see [124]. An experimental investigation comparing the several versions of the Wells turbine is reported in [125].

Fig. 24 represents (in dimensionless form, and from model testing results) the instantaneous efficiency  $\eta$  of a typical Wells turbine (single rotor and guide vanes) versus the available pressure head  $\Psi$  [43]

$$\Psi = \frac{\Delta p}{\rho_a N^2 D^2}. \quad (9)$$

Here  $\Delta p$  is the pressure difference available to the turbine (coinciding approximately with the pressure difference between the plant's air chamber and the atmosphere),  $\rho_a$  the air density,  $N$  the rotational speed (radians per unit time) and  $D$  the turbine rotor outer diameter. Fig. 24 shows that the efficiency remains at about 0.7 for instantaneous pressures within the range 0.05–0.11, but drops sharply on both sides of this interval. Of course, in reciprocating air-flow produced by real irregular waves, the pressure randomly oscillates, passing through zero from positive to negative values and vice-versa. In this case it is more useful to characterize the efficiency by its time-averaged value  $\bar{\eta}$  and the pressure by its rms value (or variance)  $\sigma_\Psi$  [43]. This is shown by another line in Fig. 24, which should be taken as representative of the turbine (average) performance in real random waves. We see that the average efficiency reaches a maximum of about 0.58 for  $\sigma_\Psi \cong 0.05$ . Obviously it would be desirable to keep  $\sigma_\Psi$  close to 0.05. We recall that  $\Psi$ , and hence  $\sigma_\Psi$ , are dimensionless values ((Eq. (9)); it follows that in rougher seas (higher waves and larger amplitudes of pressure oscillation) the turbine should be controlled to rotate faster. An optimal control law is  $L_e = \text{constan } t \times N^\alpha$ , where  $L_e$  is the instantaneous electromagnetic torque to be applied on the generator rotor and  $\alpha$  is an exponent whose value is close to 2 and depends weakly on the OWC hydrodynamic coefficients [126] (this also applies to the impulse turbine, see below).

If the setting angle of the rotor blades of a Wells turbine can be controlled during normal operation, then the efficiency curve becomes substantially wider. This idea was put into practice a long time ago in the well-known Kaplan water-turbines, and also aircraft and ship variable-pitch screw-propellers. The concept of the variable-pitch Wells turbine was proposed in the 1980s and

was object of theoretical and experimental studies [127,128]. A full-sized 400 kW prototype was designed and constructed to be installed in the Azores OWC [129]. If the rotor blade pitch angle is adequately controlled, a substantial improvement in time-averaged turbine efficiency can be achieved. Of course, the negative side is a more complex and more expensive machine as compared with the mechanically simple and robust conventional Wells turbine.

The most popular alternative to the Wells turbine seems to be the self-rectifying impulse turbine, patented by I.A. Babinsten in 1975 [130]. Its rotor is basically identical to the rotor of a conventional single-stage steam turbine of axial-flow impulse type (the classical de Laval steam turbine patented in 1889). Since the turbine is required to be self-rectifying, instead of a single row of guide vanes (as in the conventional de Laval turbine) there are two rows, placed symmetrically on both sides of the rotor (Fig. 25). These two rows of guide vanes are like the mirror image of each other with respect to a plane through the rotor disc. A severe limitation in the turbine efficiency results from aerodynamic stalling at the downstream row of guide vanes. Most of the R&D on this type of turbine has been done in Japan (and to a less extent in India, China, UK and Ireland) in the last twenty years or so (for a review, see ref. [131]).

The advantages and disadvantages of the self-rectifying impulse turbine as compared with the Wells turbine are not clear, and of course depend on which versions of each are being compared. It should be pointed out that the **efficiency of the Wells turbine is quite sensitive to Reynolds number** (more so than more conventional turbine types like the impulse turbine): tests done on small Wells turbine models should not be taken as representative of what can be achieved at full size. For this reason, comparisons between the Wells turbine and the impulse turbine, based on tests on small models, should be considered with some reserve. In general, one can say that the Wells turbine is characterized by a considerably higher rotational speed than the impulse turbine, which enhances the storage of energy by flywheel effect (with the resulting smoothing effect upon power delivered to the grid) and is expected to allow a cheaper electrical generator to be used (smaller number of poles). The impulse turbine, due to its smaller blade speed, is less constrained by Mach number effects and centrifugal

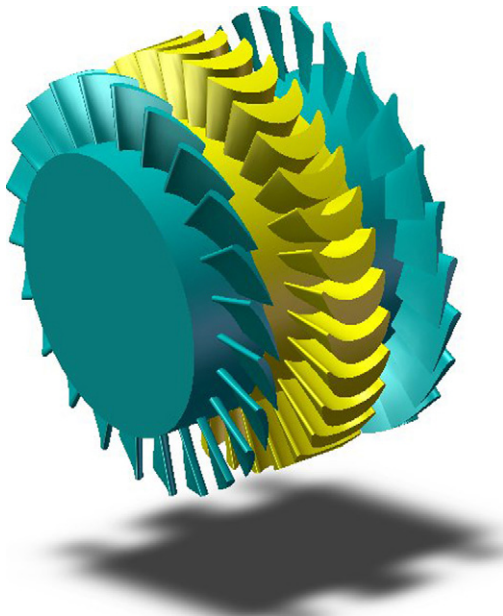

Fig. 25. Impulse turbine.

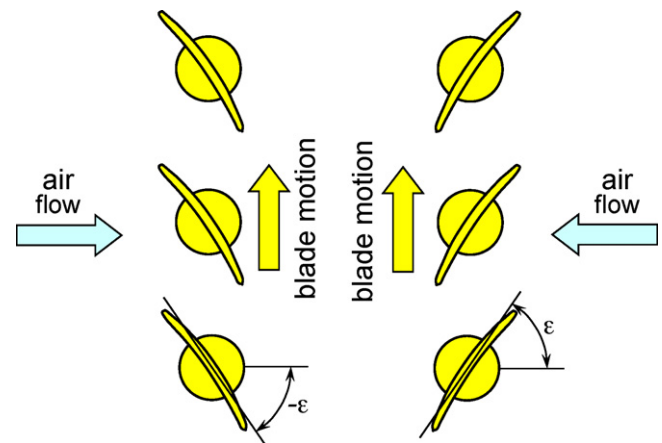

Fig. 26. Denniss-Auld air turbine. The rotor blades pivot rapidly between extreme positions when the air flow is reversed.

stresses which may be an important advantage in very energetic wave climates [132].

The so-called Denniss-Auld turbine, developed in Australia to equip OWC plants [133], is also a self-rectifying turbine, that shares some characteristics with the variable-pitch Wells turbine, the main difference being that the angle of stagger  $\varepsilon$  ( $\varepsilon = 0$  means blade along a longitudinal plane,  $\varepsilon = \pi/2$  on a cross-sectional plane) of the Denniss-Auld rotor blades may be controlled to vary within a range  $-\alpha < \varepsilon < \alpha$  (where  $\alpha \cong 55^\circ$ ) (Fig. 26), whereas in the variable-pitch Wells turbine it is  $\pi/2 - \beta < \varepsilon < \pi/2 + \beta$  (with  $\beta \cong 25^\circ$ ). While in the Wells turbine the rotor blade rounded leading edge faces the incoming flow all the time, in the Denniss-Auld turbine both edges of a blade must be identical since each edge behaves alternately as a leading edge or as a trailing edge depending on the direction of the reciprocating flow through the turbine. It is to be noted that whenever the flow changes direction (exhaust to inlet or vice-versa) the blades of the Denniss-Auld turbine are required to pivot almost instantaneously between their extreme positions, whereas in the Wells turbine the blades are required to pivot smoothly within a relatively small angular range.

These self-rectifying air turbines, especially the fixed-geometry ones, are mechanically simple and reliable machines. Based on available information, their time-averaged efficiency is relatively modest (compared with more conventional turbines operating in near steady state conditions), hardly exceeding 0.5–0.6, even if their rotational speed is controlled to match the current sea state (especially the significant wave height).

## 9.2. Hydraulic turbines

As in conventional mini-hydroelectric low-head plants [134,135], axial-flow reaction turbines are used to convert the head (typically 3–4 m at full size) created between the reservoir of an overtopping device and the mean sea level. The flow may be controlled by adjustable inlet guide vanes. In some cases the blades of the runner can also be adjusted (Kaplan turbines) which greatly improves efficiency over a wide range of flows; however this can be costly and is not normally employed in the small turbines typical of wave energy applications.

High-head (typically tens to hundreds of metres) impulse turbines (mostly of Pelton type) are adopted in some oscillating-body converters, as alternatives to hydraulic motors, with the advantage of using non-pollutant water (rather than oil) [91,110,115]. The flow may be controlled by a needle whose axial position within the nozzle is controlled by a servomechanism. The hydraulic circuit includes a ram (or set of rams) (a pair of hose

pumps in Aquabuoy) and may include also a gas accumulator system.

These (low- and high-head) hydraulic turbines may reach peak efficiencies about 0.9. Their efficiency is in general quite sensitive to the head-to-rotational-speed ratio, which makes the use of variable-speed electrical generators highly advantageous, especially in the case of Pelton turbines equipping oscillating-body converters.

### 9.3. High-pressure oil-hydraulics

High-pressure oil systems are particularly suitable to convert energy from the very large forces or moments applied by the waves on slowly oscillating bodies (in translation or rotation) (Fig. 27). The hydraulic circuit usually includes a gas accumulator system capable of storing energy over a few wave periods, which can smooth out the very irregular power absorbed from the waves. The body motion is converted into hydraulic energy by a hydraulic cylinder or ram (or a set of them). A fast hydraulic motor drives a conventional electrical generator. The engineering problems raised in this kind of PTO for wave energy applications are analysed in refs. [121,136].

The oil-hydraulic PTO was used to equip the heaving buoy tested in Tokyo Bay in 1980 (see Section 7.1), and, more recently, the Wavebob, PowerBuoy and Pelamis devices (Section 7.2), and the WaveRoller (Section 7.5).

The most frequently used type of fast hydraulic motor in wave energy applications is the axial-piston bent-axis variable-displacement machine (Fig. 28), available from a few manufacturers in the rated power range between a few kW and about 1 MW, with operating oil-pressures up to about 350 bar. Even large (1-MW) machines can drive an electrical generator at speeds exceeding 1500 rpm. The motor consists of a drive shaft with a flange, which is constrained to rotate together with a cylinder block inside which there is a set (usually odd number) of cylinders arranged axially parallel to each other around the circumferential periphery of the block. The two axes of rotation make a non-zero angle  $\beta$ . The piston displacement depends on the angle  $\beta$  between the drive shaft axis

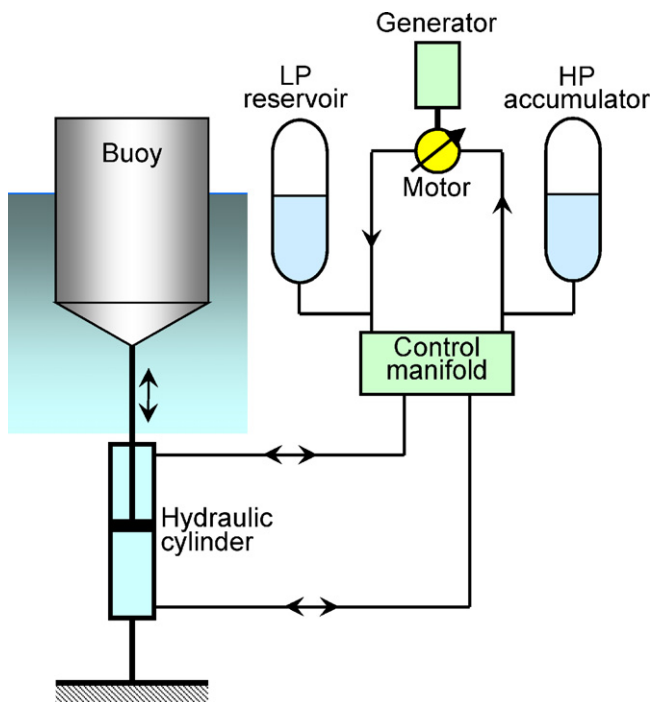

Fig. 27. Schematic representation of the hydraulic PTO of a heaving wave energy converter.

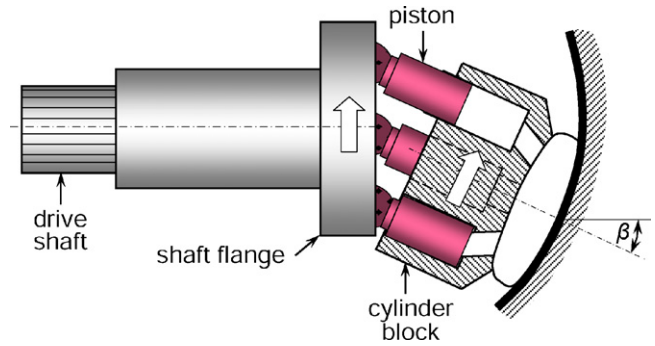

Fig. 28. Schematic representation of a variable-displacement hydraulic motor of axial-piston bent-axis type, showing the cylinder block with pistons and the drive shaft flange. The piston displacement can be varied by changing the setting angle  $\beta$  between the shaft axis and the cylinder block axis.

and the cylinder block axis (Fig. 28). The flow rate is proportional to  $N \tan \beta$ , where  $N$  is the rotational speed [137]. This allows the instantaneous flow rate to be controlled by changing the rotational speed  $N$  of the motor-generator set and/or by adjusting the setting-angle  $\beta$ .

Energy can be stored in, and released from, a gas accumulator system, consisting of a high-pressure accumulator and a low-pressure reservoir (Fig. 27). The gas, usually nitrogen, is separated from the oil by a bladder or by a free piston. In order to avoid cavitation in the circuit, the pressure in the reservoir is kept above a few bar. High-pressure gas accumulators are designed to withstand pressures up to about 500–600 bar. The amount of energy stored per unit mass of gas is  $\Delta E = c_v \Delta T$ , where  $c_v$  is the specific heat at constant volume and  $T$  is absolute temperature. Over small time intervals (not exceeding, say, a few minutes) the compression/decompression process may be regarded as approximately isentropic. Assuming the gas to behave as a perfect gas, we may write

$$\Delta T = T \left\{ \left( \frac{p + \Delta p}{p} \right)^{(\gamma-1)/\gamma} - 1 \right\}. \quad (9)$$

Here,  $p$  is pressure,  $\Delta p$  is increase in pressure and  $\gamma = c_p/c_v$  is the specific pressure ratio. For nitrogen it is  $\gamma \cong 1.4$  and  $c_v \cong 0.74 \text{ kJ}/(\text{kg K})$ . Usually a set of high-pressure gas accumulators interconnected in parallel is required to provide a suitable smoothing effect to a full-sized wave energy converter, and may represent a significant part of the PTO capital cost. Criteria for the specification/design of gas accumulator systems for wave energy applications can be found in [138].

The damping provided by a hydraulic PTO is highly non-linear and (except if reactive phase control is envisaged) it may be regarded as Coulomb damping: the piston in the hydraulic cylinder remains stationary for as long as the force applied on its shaft is less than  $S(p_H - p_L)$ , where  $S$  is piston area and  $p_H - p_L$  is pressure difference between the high-pressure and low-pressure accumulators. The oil flow rate admitted to the hydraulic motor should increase with the absorbed wave-power level. It may be shown that its instantaneous value should be controlled (by adjusting the rotational speed and/or the motor geometry) to remain proportional to the pressure difference  $p_H - p_L$  [138]. This kind of PTO is highly suitable for phase control by latching: to do that, the control manifold in the hydraulic circuit remains locked for as long as the control algorithm specifies the piston to remain fixed. A simple latching control algorithm was proposed in ref. [139].

Although little has been disclosed on the performance of recent sea-tested prototypes equipped with hydraulic PTO, it appears that some concerns are related to lower-than-expected energy conversion efficiency and the limited estimated life-span of hydraulic ram seals. New designs of hydraulic equipment, specifically for

wave energy applications, may be the way to proceed, as advocated by Salter and his co-workers [98,121].

#### 9.4. Electrical equipment

In most wave energy converters, a rotating electrical generator is driven by a mechanical machine: air or hydraulic turbine, hydraulic motor. The electrical equipment, including variable rotational speed and power electronics, is mostly conventional and largely similar to wind energy conversion. If the driving machine is a variable displacement hydraulic motor, it is possible to keep the rotational speed fixed while controlling the flow rate and power by adjusting the motor geometry (see Section 9.3).

This is not the case of direct drive conversion, without mechanical interface, by a linear electrical generator, already considered in McCormick's book [1]. The first prototype equipped with a linear electrical generator (rated 2 MW) was the bottom-standing Archimedes Wave Swing (AWS) (Fig. 13), tested in the sea in 2004 [97]. More recently, heaving buoys equipped with linear generators were sea-tested off Sweden (Fig. 8) [82] and Oregon, USA (Fig. 9) [83]. In these buoys, the force that drives the generator is provided by a taught mooring line.

Direct drive has the advantage of not requiring a mechanical interface and avoiding the non-negligible losses that take place in the mechanical machines (turbines and hydraulic motors) in more conventional PTO systems. On the other hand, linear electrical generators for wave energy applications are subject to much more demanding conditions than high-speed rotary ones, and are to a large extent still at the development stage in several countries: Holland [140], UK [141], Sweden [142], USA [143]. The generator consists of a stator and a translator (rather than a rotor). In wave energy applications, the generator reciprocating motion matches the motion of the actual device, at speeds two orders of magnitude lower than the velocities typical of high-speed rotary generators. At such low speeds, the forces are very large, which requires a physically large machine. For an overview of direct drive technology in wave energy converters, see [143–145]. The phase-control of a wave energy converter (like the AWS) equipped with a linear generator raises special problems [146].

#### 10. Moorings

Free floating bodies, like oil and gas platforms, are subject to drift forces due to waves, currents and wind, and so they have to be kept on station by moorings [147]. This is also the case of a large class of floating wave-energy converters for deployment offshore, typically in water depths between 40 and 100 m. (Early contributions to the mooring design of such wave energy converters can be found in refs. [1,148]). Although similarities can be found between those applications, the mooring design requirements will have some important differences, one of them associated to the fact that, in the case of a wave energy converter, the mooring connections may significantly modify its energy absorption properties by interacting with its oscillations [149].

The mooring, especially the slack-mooring, of floating wave energy converters has been addressed in the last few years by several authors [149–154]. Due to the catenary effect, the inertia of the mooring lines and hydrodynamic drag forces, the three-dimensional dynamics of the mooring system and its interaction with the oscillating moored floater is non-linear and quite complex (there are several commercial codes available for mooring analysis). Fitzgerald and Bergdahl [152] studied in detail the effect of the mooring connections upon the performance of a wave energy converter, by linearizing the mooring forces about the static condition, which conveniently allows a frequency-domain analysis to be applied.

Little attention seems to have been devoted in the published literature to the mooring design of free-floating point absorbers in dense arrays. This may be explained by the present stage of development of the technology (focusing on single prototypes) and/or by the restricted availability of such information. In such cases, it may be more convenient that the array is spread-moored to the sea bottom by slack mooring lines through only some of its elements, located in the periphery, while the other array elements are prevented from drifting and colliding with each other by connections to adjacent elements. This has been analysed in ref. [155], where the hydrodynamics of the mooring of an array of identical floating point absorbers located at the grid points of an equilateral triangular grid is considered.

#### 11. Conclusion

Unlike in the case of wind energy, the present situation shows a wide variety of wave energy systems, at several stages of development, competing against each other, without it being clear which types will be the final winners.

In the last fifteen years or so, most of the R&D activity in wave energy has been taking place in Europe, largely due to the financial support and coordination provided by the European Commission, and to the positive attitude adopted by some European national governments (especially in the last few years). However, in the last few years, interest in wave energy utilization has been growing rapidly also in other parts of the world.

In general, the development, from concept to commercial stage, has been found to be a difficult, slow and expensive process. Although substantial progress has been achieved in the theoretical and numerical modelling of wave energy converters and of their energy conversion chain, model testing in wave basin – a time-consuming and considerably expensive task – is still essential. The final stage is testing under real sea conditions. In almost every system, optimal wave energy absorption involves some kind of resonance, which implies that the geometry and size of the structure are linked to wavelength. For these reasons, if pilot plants are to be tested in the open ocean, they must be large structures. For the same reasons, it is difficult, in the wave energy technology, to follow what was done in the wind turbine industry (namely in Denmark): relatively small machines where developed first, and were subsequently scaled up to larger sizes and powers as the market developed. The high costs of constructing, deploying, maintaining and testing large prototypes under sometimes very harsh environmental conditions, has hindered the development of wave energy systems; in most cases such operations were possible only with substantial financial support from governments (or, in the European case, from the European Commission).

#### Acknowledgements

The work reported here was partly supported by the Portuguese Foundation for Science and Technology under contracts Nos. POCSFA-46 and PTDC/EME-MFE/66999/2006. The author thanks Rui Gomes for doing some of the drawings.

#### References

- [1] McCormick ME. Ocean wave energy conversion. New York: Wiley; 1981.
- [2] Ross D. Power from sea waves. Oxford: Oxford University Press; 1995.
- [3] Shaw R. Wave energy: a design challenge. Chichester: Ellis Horwood; 1982.
- [4] Charlier RH, Justus JR. Ocean energies. Amsterdam: Elsevier; 1993.
- [5] Brooke J. Wave energy conversion. Amsterdam: Elsevier; 2003.
- [6] Cruz J, editor. Ocean wave energy. Berlin: Springer; 2008.
- [7] Thorpe TW. A brief review of wave energy. A report produced for the UK Department of Energy. Report No ETSU-120; 1999. Available online at: <http://www.mech.ed.ac.uk/research/wavepower/Tom%20Thorpe/Tom%20Thorpe%20report.pdf>.

- [8] WaveNet. Results from the Work of the European Thematic Network on Wave Energy; 2003. Available online at: <http://www.wave-energy.net/Main.htm>.
- [9] Salter SH. World progress in wave energy. *Int J Ambient Energy* 1989;10:3–24.
- [10] Thorpe T. An overview of wave energy technologies—status, performance and costs. In: *Wave power: moving towards commercial viability*. London: Professional Engineering Publishing; 2000. p. 13–30.
- [11] Clément A, McCullen P, Falcão A, Fiorentino A, Gardner F, Hammarlund K, et al. Wave energy in Europe: current status and perspectives. *Renew Sustain Energy Rev* 2002;6:405–31.
- [12] Falcão AF de O. First-generation wave power plants: current status and R&D requirements. *Trans ASME J Offshore Mech Arct Eng* 2004;126:384–8.
- [13] Falnes J. A review of wave-energy extraction. *Mar Struct* 2007;20:185–201.
- [14] Masuda Y. Wave-activated generator. *Int. Colloq Exposition Oceans*. France: Bordeaux; 1971.
- [15] Masuda Y. Experimental full-scale results of wave power machine Kaimei in 1978. In: *Proc First Symp Wave Energy Utilization*, Gothenburg, Sweden; 1979, p. 349–63.
- [16] Salter SH. Wave power. *Nature* 1974;249:720–4.
- [17] Grove-Palmer COJ. Wave energy in the United Kingdom: a review of the programme June 1975 to March 1982. In: *Proceedings of 2nd International Symposium on Wave Energy Utilization*; 1982. p. 23–54.
- [18] Whittaker TJT, McLwaine SJ, Raghunathan S. A review of the Islay shoreline wave power station. In: *Proceedings of First European Wave Energy Symposium*; 1993. p. 283–6.
- [19] Ohneda H, Igarashi S, Shinbo O, Sekihara S, Suzuki K, Kubota H, et al. Construction procedure of a wave power extracting caisson breakwater. In: *Proceedings of 3rd Symposium on Ocean Energy Utilization*; 1991. p. 171–9.
- [20] Ravindran M, Koola PM. Energy from sea waves—the Indian wave energy program. *Current Sci* 1991;60:676–80.
- [21] Annual Report 2008. International Energy Agency Implementing Agreement on Ocean Energy Systems; 2009. Available online at: [http://www.iea-oceans.org/\\_fich/6/Annual\\_Report\\_2008\\_\(1\).pdf](http://www.iea-oceans.org/_fich/6/Annual_Report_2008_(1).pdf).
- [22] Bedard R, Previsic M, Hagerman G, Polagye B, Musial W, Klure J, et al. North American ocean energy status—March 2007. In: *Proceedings of 7th European Wave Tidal Energy Conference*; 2007.
- [23] Previsic M, Moreno A, Bedard R, Polagye B, Collar C, Lockard D, et al. Hydrokinetic energy in the United States—resources, challenges and opportunities. In: *Proceedings of 8th European Wave Tidal Energy Conference*; 2009. p. 76–84.
- [24] Mollison D. The prediction of device performance. In: Count B, editor. *Power from sea waves*. London: Academic Press; 1980. p. 135–72.
- [25] Mollison D. Wave climate and the wave power resource. In: Evans DV, Falcão A.F. de O, editors. *Hydrodynamics of ocean wave energy utilization*. Berlin: Springer; 1986. p. 133–67.
- [26] Pontes T, Mollison D, Borge JC, Cavaleri L, Athanassoulis GA. Evaluation of the wave energy resource. In: *Proc Workshop Wave Energy R&D*, Cork, Ireland, European Commission Report No. EUR 15079 EN; 1993. p. 1–8.
- [27] Pontes MT. Assessing the European wave energy resource. *Trans ASME J Offshore Mech Arct Eng* 1998;120:226–31.
- [28] Pontes MT, Aguiar R, Pires HO. A nearshore wave energy atlas for Portugal. *Trans ASME J Offshore Mech Arct Eng* 2005;127:249–55.
- [29] Barstow S, Gunnar M, Mollison D, Cruz J. The wave energy resource. In: Cruz J, editor. *Ocean wave energy*. Berlin: Springer; 2008. p. 93–132.
- [30] Pontes MT, Cavaleri L, Mollison D. Ocean waves: energy resource assessment. *Marine Technol Soc J* 2002;36:42–51.
- [31] Budal K, Falnes J. A resonant point absorber of ocean-wave power. *Nature* 1975;257:478–9.
- [32] Evans DV. A theory for wave-power absorption by oscillating bodies. *J Fluid Mech* 1976;77:1–25.
- [33] Newman JN. The interaction of stationary vessels with regular waves. In: *Proceedings of 11th Symposium on Naval Hydrodynamics*; 1976. p. 491–501.
- [34] Mei CC. Power extraction from water waves. *J Ship Res* 1976;20:63–6.
- [35] Hulme H. The wave forces acting on a floating hemisphere undergoing forced periodic oscillations. *J Fluid Mech* 1982;121:443–63.
- [36] Evans DV. Power from water waves. *Ann Rev Fluid Mech* 1981;13:157–87.
- [37] Mei CC. *The applied dynamics of ocean surface waves*. New York: Wiley; 1983.
- [38] Falcão AF de O, Sarmento AJNA. Wave generation by a periodic surface pressure and its application in wave-energy extraction. In: *15th International Congress of Theoretical and Applied Mechanics*; 1980.
- [39] Evans DV. Wave power absorption by systems of oscillating surface-pressure distributions. *J Fluid Mech* 1982;114:481–99.
- [40] Sarmento AJNA, Falcão AF de O. Wave generation by an oscillating surface-pressure and its application in wave-energy extraction. *J Fluid Mech* 1985;150:467–85.
- [41] Jefferys ER. Device characterisation. In: Count B, editor. *Power from sea waves*. London: Academic Press; 1980. p. 413–38.
- [42] Cummins WE. The impulse response function and ship motions. *Schiffstechnik* 1962;9:101–9.
- [43] Falcão AF de O, Rodrigues RJA. Stochastic modelling of OWC wave power plant performance. *Appl Ocean Res* 2002;24:59–71.
- [44] Falcão AF de O. Stochastic modelling in wave power-equipment optimization: maximum energy production versus maximum profit. *Ocean Eng* 2004;31:1407–21.
- [45] Gato LMC, Justino PAP, Falcão AF de O. Optimization of power take-off equipment for an oscillating-water column wave energy plant. In: *Proceedings of 6th European Wave Tidal Energy Conference*; 2005. p. 155–61.
- [46] Budal K. Theory for absorption of wave power by a system of interacting bodies. *J Ship Res* 1977;21:248–53.
- [47] Falnes J, Budal K. Wave-power conversion by power absorbers. *Norweg Mar Res* 1978;6:2–11.
- [48] Evans DV. Some theoretical aspects of three-dimensional wave energy absorbers. In: *Proceedings of 1st Symposium on Ocean Wave Energy Utilization*; 1979. p. 77–113.
- [49] Mavrakos SA, McIver P. Comparison of methods for computing hydrodynamic characteristics of arrays of wave power devices. *Appl Ocean Res* 1997;19:283–91.
- [50] Falnes J. *Ocean waves and oscillating systems*. Cambridge: Cambridge University Press; 2002.
- [51] Taylor J. The [University of Edinburgh] wave power group. Available online at: <http://www.mech.ed.ac.uk/research/wavepower/> [accessed 20.10.2009].
- [52] Falnes J. Optimum control of oscillation of wave-energy converters. *Int J Offshore Polar Eng* 2002;12:147–55.
- [53] Budal K, Falnes J. Interacting point absorbers with controlled motion. In: Count B, editor. *Power from sea waves*. London: Academic Press; 1980. p. 381–99.
- [54] Hals J, Bjarte-Larsson T, Falnes J. Optimum reactive control and control by latching of a wave-absorbing semisubmerged heaving sphere. In: *Proceedings of 21st International Conference on Offshore Mechanics and Arctic Engineering*; 2002.
- [55] Babarit A, Guglielmi M, Clément AH. Declutching control of a wave energy converter. *Ocean Eng* 2009;36:1015–24.
- [56] Naiko S, Nakamura S. Wave energy absorption in irregular waves by feedforward control system. In: Evans DV, Falcão A.F. de O, editors. *Hydrodynamics of ocean wave energy utilization*. Berlin: Springer; 1986. p. 269–80.
- [57] Hoskin RE, Count BM, Nichols NK, Nicol DAC. Phase control for the oscillating water column. In: Evans DV, Falcão A.F. de O, editors. *Hydrodynamics of ocean wave energy utilization*. Berlin: Springer; 1986. p. 257–68.
- [58] Hoskin RE, Nichols RK. Optimal strategies for phase control of wave energy devices. In: McCormick ME, Kim YC, editors. *Proceedings of International Symposium on Utilization of Ocean Waves—Wave to Energy Conversion*. La Jolla, CA, ASCE; 1986. p. 184–99.
- [59] Korde UA. Phase control of floating bodies from an on-board reference. *Appl Ocean Res* 2001;23:251–62.
- [60] Benke K, Ambli N. Prototype wave power stations in Norway. In: McCormick ME, Kim YC, editors. *Proceedings of International Symposium on Utilization of Ocean Waves—Wave to Energy Conversion*. La Jolla, CA, ASCE; 1986. p. 34–45.
- [61] Ohneda H, Igarashi S, Shinbo O, Sekihara S, Suzuki K, Kubota H, et al. Construction procedure of a wave power extracting caisson breakwater. Tokyo: *Proceedings of 3rd Symposium on Ocean Energy Utilization*; 1991. pp. 171–9.
- [62] Falcão AF de O. The shoreline OWC wave power plant at the Azores. In: *Proceedings of 4th European Wave Energy Conference*; 2000. p. 42–7.
- [63] Heath T, Whittaker TJT, Boake CB. The design, construction and operation of the LIMPET wave energy converter (Islay, Scotland). In: *Proceedings of 4th European Wave Energy Conference*; 2000. p. 49–55.
- [64] Whittaker TJT, McLwaine SJ, Raghunathan S. A review of the Islay shoreline wave power station. In: *Proceedings of (First) European Wave Energy Symposium*; 1993. p. 283–6.
- [65] Count BM, Evans DV. The influence of projecting sidewalls on the hydrodynamic performance of wave energy devices. *J Fluid Mech* 1984;145:361–76.
- [66] Alcorn R, Hunter S, Signorelli C, Obeyesekera R, Finnigan T, Dennis T. Results of the testing of the Energetech wave energy plant at Port Kembla. Energetech Report; 2005. Available online at: [http://energetech.com.au:8080/attachments/Results\\_PK\\_Wave\\_Energy\\_Trial.pdf](http://energetech.com.au:8080/attachments/Results_PK_Wave_Energy_Trial.pdf).
- [67] Basmat A, Dennis T, Finnigan T. Diffraction of linear water waves on a parabolic wall: small parameter approach. In: *Proceedings of 13th International Offshore Polar Engineering Conference*, Honolulu, Hawaii; 2003, vol. 1, p. 327–32.
- [68] Martins E, Ramos FS, Carrilho L, Justino P, Gato L, Trigo L, Neumann F. CeoDouro project: overall design of an OWC in the new Oporto breakwater. In: *Proceedings of 6th European Wave Tidal Energy Conference*; 2005. p. 273–80.
- [69] Torre-Enciso Y, Ortuibia I, López de Aguilera LI, Marqués J. Mutriku wave power plant: from the thinking out to the reality. In: *Proceedings 8th European Wave Tidal Energy Conference*; 2009, p. 319–29.
- [70] Boccotti P. Caisson breakwaters embodying an OWC with a small opening. Part I: Theory. *Ocean Eng* 2007;34:806–19.
- [71] Boccotti P, Filianoti P, Fiamma V, Arena F. Caisson breakwaters embodying an OWC with a small opening. Part II: A small-scale field experiment. *Ocean Eng* 2007;34:820–41.
- [72] Masuda Y, McCormick ME. Experiences in pneumatic wave energy conversion in Japan. In: McCormick ME, Kim YC, editors. *Utilization of ocean waves—wave to energy conversion*. New York: ASCE; 1987. p. 1–33.
- [73] Masuda Y, Xiangfang L, Xiangfan G. High performance of cylinder float backward bent duct buoy (BBDB) and its use in European seas. In: *Proceedings of (First) European Wave Energy Symposium*; 1993. p. 323–37.

- [74] Masuda Y, Kimura H, Liang X, Gao X, Mogensen RM, Andersen T. Regarding BBDB wave power generation plant. In: Proceedings of 2nd European Wave Power Conference; 1995. p. 69–76.
- [75] Ocean Energy. Available online at: <http://www.oceanenergy.ie/> [accessed 20.10.2009].
- [76] Washio Y, Osawa H, Nagata Y, Fujii F, Furuyama H, Fujita T. The offshore floating type wave power device "Mighty Whale": open sea tests. In: Proceedings of 10th International Offshore Polar Engineering Conference, Seattle; 2000, vol.1, p. 373–80.
- [77] DTI. Nearshore floating oscillating water column: prototype development and evaluation. Rep URN 05/581; 2005. Available online at: <http://www.berr.gov.uk/files/file17347.pdf>.
- [78] Lye JL, Brown DT, Johnson F. An investigation into the non-linear effects resulting from air cushions in the Orecon oscillating water column (OWC) device. In: Proceedings of 28th International Conference on Ocean Offshore Arctic Engineering, Honolulu, Hawaii; 2009 [paper no. OMAE2009-79115].
- [79] Hirohisa T. Sea trial of a heaving buoy wave power absorber. In: Berge H, editor. Proceedings of 2nd International Symposium on Wave Energy Utilization, Trondheim, Norway; 1982, p. 403–17.
- [80] Budal K, Falnes J, Iversen LC, Lillebekken PM, Oltedal G, Hals, et al. The Norwegian wave-power buoy project. In: Berge H, editor. Proceedings of 2nd International Symposium on Wave Energy Utilization, Trondheim, Norway; 1982, p. 323–44.
- [81] Nielsen K, Smed PF. Point absorber—optimization and survival testing. In: Proceedings of 3rd European Wave Energy Conference; 1998, p. 207–14.
- [82] Waters R, Stalberg M, Danielsson O, Svensson O, Gustafsson S, Stromstedt E, et al. Experimental results from sea trials of an offshore wave energy system. *Appl Phys Lett* 2007;90(3) [Art No. 034105].
- [83] Elwood D, Schacher A, Rhinefrank K, Prudell J, Yim S, Amon E, et al. Numerical modelling and ocean testing of a direct-drive wave energy device utilizing a permanent magnet linear generator for power take-off. In: Proceedings of 28th International Conference on Ocean Offshore Arctic Engineering, ASME, Honolulu, Hawaii; 2009 [Paper No. OMAE2009-79146].
- [84] Falnes J. Wave-energy conversion through relative motion between two single-mode oscillating bodies. *J Offshore Mech Arctic Eng* 1999;121: 32–8.
- [85] Korde UA. Systems of reactively loaded coupled oscillating bodies in wave energy conversion. *Appl Ocean Res* 2003;25:79–91.
- [86] Beatty SJ, Buckham BJ, Wild P. Frequency response tuning for a two-body heaving wave energy converter. In: Proceedings of 18th International Offshore Polar Engineering Conference; 2008, p. 342–8.
- [87] Ferdinande V, Vantorre M. The concept of a bipartite point absorber. In: Evans DV, Falcão A.F. de O, editors. Hydrodynamics of ocean wave energy utilization. Berlin: Springer; 1986, p. 217–26.
- [88] Noren SA. Plant for utilizing kinetic energy. US Patent No. 4277690; 1981 [Original Swedish patent No. 7808679; 1978].
- [89] Noren SA. Apparatus for recovering the kinetic energy of sea waves. US Patent No. 4773221; 1988 [Original Swedish patent No. 8104407; 1981].
- [90] Cleason L, Forsberg J, Rylander A, Sjöström BO. Contribution to the theory and experience of energy production and transmission from the buoy-concept. In: Proceedings of 2nd International Symposium on Wave Energy Utilization; 1982, p. 345–70.
- [91] Weinstein A, Fredrikson G, Parks MJ, Nielsen K. AquaBuOY, the offshore wave energy converter numerical modelling and optimization. In: Proceedings of MTT/IEEE Techno-Ocean'04 Conference, Kobe, Japan; 2004, vol. 4, p. 1854–59.
- [92] Salter SH, Lin CP. Wide tank efficiency measurements on a model of the sloped IPS buoy. In: Proceedings of 3rd European Wave Energy Conference; 1998, p. 200–6.
- [93] Payne GS, Taylor JRM, Bruce T, Parkin P. Assessment of boundary-element method for modelling a free-floating sloped wave energy device. Part 1: Numerical modelling. *Ocean Eng* 2008;35:333–41.
- [94] Payne GS, Taylor JRM, Bruce T, Parkin P. Assessment of boundary-element method for modelling a free-floating sloped wave energy device. Part 2: Experimental validation. *Ocean Eng* 2008;35:342–57.
- [95] Weber J, Mouwen F, Parrish A, Robertson D. Wavebob—research & development network and tools in the context of systems engineering. In: Proceedings of 8th European Wave Tidal Energy Conference; 2009, p. 416–20.
- [96] Prado M. Archimedes wave swing (AWS). In: Cruz J, editor. Ocean wave energy. Berlin: Springer; 2008, p. 297–304.
- [97] Gardner FE. Learning experience of AWS pilot plant test offshore Portugal. In: Proceedings of 6th European Wave Energy Conference; 2005, p. 149–54.
- [98] Salter S. Looking back. In: Cruz J, editor. Ocean wave energy. Berlin: Springer; 2008, p. 7–39.
- [99] Pizer DJ, Retzler C, Henderson RM, Cowieson FL, Shaw MG, Dickens B, Hart R. Pelamis WEC—recent advances in the numerical and experimental modelling programme. In: Proceedings of 6th European Wave Tidal Energy Conference; 2005, p. 373–8.
- [100] Yemm R. Pelamis. In: Cruz J, editor. Ocean wave energy. Berlin: Springer; 2008, p. 304–21.
- [101] McCormick ME, Murthagh J, McCabe P. Large-scale experimental study of a hinged-barge wave energy conversion system. In: 3rd European Wave Energy Conference; 1998, p. 215–22.
- [102] French MJ, Bracewell R. Heaving point absorbers reacting against an internal mass. In: Evans DV, Falcão A.F. de O, editors. Hydrodynamics of ocean wave energy utilization. Berlin: Springer; 1986, p. 247–55.
- [103] Korde UA. On providing a reaction for efficient wave energy absorption by floating devices. *Appl Ocean Res* 1999;21:235–48.
- [104] McCabe AP, Bradshaw A, Widden MB, Chaplin RV, French MJ, Meadowcroft JAC. PS Frog Mk5: an offshore point-absorber wave energy converter. In: Proceedings of 5th European Wave Energy Conference; 2003, p. 31–7.
- [105] McCabe AP, Bradshaw A, Meadowcroft JAC, Aggidis G. Developments in the design of the PS Frog Mk 5 wave energy converter. *Renewable Energy* 2006;31:141–51.
- [106] Babarit A, Clement AH, Gilotteaux JC. Optimization and time-domain simulation of the SEAREV wave energy converter. In: Proceedings of 24th International Conference Offshore Mechanics Arctic Engineering, Halkidiki, Greece; 2005, vol. 2, p. 703–12.
- [107] Salcedo F, Ruiz-Minguela P, Rodriguez R, Ricci P, Santos M. Oceanec: sea trials of a quarter scale prototype. In: Proceedings of 8th European Wave Tidal Energy Conference; 2009, p. 460–5.
- [108] Perez T, Santos-Mujica M, Ruiz-Minguela JP. Performance analysis and control design of a gyro-based wave energy converter. In: Proceedings of European Control Conference 2009; 2009, p. 3743–8.
- [109] Salter SH. The swinging mace. In: Proceedings of Workshop Wave Energy R&D, Cork, Ireland; 1992, European Commission Rep EUR 15079EN, p. 197–206.
- [110] Whittaker T, Collier D, Folley M, Osterried M, Henry A, Crowley M. The development of Oyster—a shallow water surging wave energy converter. Proceedings of 7th European Wave Tidal Energy Conference, Porto, Portugal, 2007.
- [111] WaveRoller. Available online at: <http://www.aw-energy.com/index.php/waveroller.html> [accessed 20.10.2009].
- [112] Folley M, Whittaker T, van't Hoff J. The design of small seabed-mounted bottom-hinged wave energy converters. In: Proceedings of 7th European Wave Tidal Energy Conference; 2007.
- [113] Lendenmann H, Strømsem K-C, Dai Pre M, Arshad W, Leirbukt A, Tjensvoll G, Gulli T. Direct generation wave energy converters for optimized electrical power production. In: Proceedings of 7th European Wave Tidal Energy Conference; 2007.
- [114] Wave Star Energy. Available online at: <http://www.wavestarenergy.com/> [accessed 20.10.2009].
- [115] Estefen SF, Esperança PTT, Ricarte E, Costa PR, Pinheiro MM, Clemente CH, et al. Experimental and numerical studies of the wave energy hyperbaric device for electricity production. In: Proceedings of 27th International Conference Offshore Mechanics Arctic Engineering, Estoril, Portugal; 2008 [paper no. OMAE2008-57891].
- [116] Mehlum E Tapchan. In: Evans DV, Falcão A.F. de O, editors. Hydrodynamics of ocean wave energy utilization. Berlin: Springer; 1986, p. 51–5.
- [117] Graw KU. Eine Einführung in die Nutzung der Wellenenergie, Universität Leipzig; 2004. Available online at: [http://www.uni-leipzig.de/~grw/welle/wenergie\\_3\\_80.html#zwei](http://www.uni-leipzig.de/~grw/welle/wenergie_3_80.html#zwei).
- [118] Kofoed JP, Frigaard P, Friis-Madsen E, Sørensen HC. Prototype testing of the wave energy converter Wave Dragon. *Renewable Energy* 2006;31:181–9.
- [119] Margheritini L, Vicinanza D, Frigaard P. Hydraulic characteristics of seawave slot-cone generator pilot plant at Kvitsoy (Norway). In: Proceedings of 7th European Wave Tidal Energy Conference; 2007.
- [120] Vicinanza D, Frigaard P. Wave pressure acting on a seawave slot-cone generator. *Coastal Eng* 2008;55:553–68.
- [121] Salter SH, Taylor JRM, Caldwell NJ. Power conversion mechanisms for wave energy. *Proc Inst Mech Eng Part M J Eng Maritime Environ* 2002;216:1–27.
- [122] Wells AA. Fluid driven rotary transducer. British Patent Spec No. 1595700; 1976.
- [123] Whittaker T, Wells AA. Experiences with hydropneumatic wave power device. In: Proceedings of Wave and Tidal Symposium, Canterbury, UK; 1978 [paper B4].
- [124] Raghunathan S. The Wells air turbine for wave energy conversion. *Prog Aerospace Sci* 1995;31:335–86.
- [125] Curran R, Gato LMC. The energy conversion performance of several types of Wells turbine designs. *Proc Inst Mech Eng Part A J Power Energy* 1997;211:133–45.
- [126] Falcão AF de O. Control of an oscillating-water-column wave power plant for maximum energy production. *Appl Ocean Res* 2002;24:73–82.
- [127] Gato LMC, Falcão AF de O. Aerodynamics of the Wells turbine: control by swinging rotor blades. *Int J Mech Sci* 1989;31:425–34.
- [128] Gato LMC, Eça LRC, Falcão AF de O. Performance of the Wells turbine with variable pitch rotor blades. *Trans ASME J Energy Resour Techn* 1991; 113:141–6.
- [129] Taylor JMR, Caldwell NJ. Design and construction of the variable-pitch air turbine for the Azores wave power plant. In: Proceedings of 3rd European Wave Energy Conference; 1998, p. 328–37.
- [130] Babinsten IA. Apparatus for converting sea wave energy into electrical energy. U.S. patent No. 3922739; 1975.
- [131] Setoguchi T, Santhakumar S, Maeda H, Takao M, Kaneko K. A review of impulse turbines for wave energy conversion. *Renewable Energy* 2001; 23:261–92.
- [132] Scuto M, Falcão AF de O. Wells and impulse turbines in an OWC wave power plant: a comparison. In: Proceedings of 6th European Wave Tidal Energy Conference; 2005, p. 463–9.
- [133] Curran R, Dennis T, Boake S. Multidisciplinary design for performance: ocean wave energy conversion. In: Proceedings of 10th International Offshore Polar Engineering Conference, Seattle; 2000, vol. 1, pp. 434–41.

- [134] Paish O. Small hydro power: technology and current status. *Renewable Sustain Energy Rev* 2002;6:537–56.
- [135] Raabe J. *Hydropower*. Düsseldorf: VDI Verlag; 1985.
- [136] Taylor J. Power take-off systems: hydraulics. In: Cruz J, editor. *Ocean wave energy*. Berlin: Springer; 2008. p. 241–60.
- [137] Majumdar SR. *Oil hydraulic systems. Principles and maintenance*. New York: McGraw Hill; 2001.
- [138] Falcão AF de O. Modelling and control of oscillating-body wave energy converters with hydraulic power take-off and gas accumulator. *Ocean Eng* 2007;34:2021–32.
- [139] Falcão AF de O. Phase control through load control of oscillating-body wave energy converters with hydraulic PTO system. *Ocean Eng* 2008;35:358–66.
- [140] Polinder H, Damen MEC, Gardner F. Design, modelling and test results of the AWS PM linear generator. *Eur Trans Electrical Power* 2005;15:245–56.
- [141] Caraher SL, Chick JP, Mueller MA. Investigation of fluid film bearings for use in direct drive linear generators in submerged wave energy converters. In: *Proceedings of 18th International Offshore Polar Engineering Conference*; 2008. p. 409–16.
- [142] Stalberg M, Waters R, Danielsson O, Leijon M. Influence of generator damping on peak power and variance of power for a direct drive wave energy converter. *Trans ASME J Offshore Mech Arct Eng* 2008; 130 [Art No. 031003].
- [143] Rhinefrank K, Agamloh EB, von Jouanne A, Wallace AK, Prudell J, Kimble K, et al. Novel ocean energy permanent magnet linear generator buoy. *Renewable Energy* 2006;31:1279–98.
- [144] Mueller MA. Electrical generators for direct drive wave energy converters. *IEE Proc Generation Trans Distrib* 2002;149:446–56.
- [145] Danielsson O, Thorburn K, Leijon M. Direct drive—linear generators. In: Cruz J, editor. *Ocean wave energy*. Berlin: Springer; 2008. p. 220–41.
- [146] Valério D, Beirão P, da Costa J. Identification and control of the AWS using neural network models. *Appl Ocean Res* 2008;30:178–88.
- [147] Brown DT. Mooring systems. In: Chakrabarti S, editor. *Handbook of offshore engineering*. Amsterdam: Elsevier; 2005, vol. 2, p. 663–708.
- [148] Fylling IJ. Anchoring systems for wave energy converters. In: Berge H, editor. *Proceedings of 2nd International Symposium on Wave Energy Utilization*. Norway: Trondheim; 1982. p. 229–51.
- [149] Johanning I, Smith GH, Wolfram J. Mooring design approach for wave energy converters. *Proc Inst Mech Eng Part M J Eng Marit Environ* 2006;220:159–74.
- [150] Johanning L, Smith GH, Wolfram J. Towards design standards for WEC moorings. In: *Proceedings of 6th European Wave Tidal Energy Conference*; 2005.
- [151] Johanning L, Smith GH, Wolfram J. Interaction between mooring line damping and response frequency as a result of stiffness alterations in surge. In: *Proceedings of 25th International Conference Offshore Mechanics Arctic Engineering*, Hamburg; 2006 [Paper no. 2006-92373].
- [152] Fitzgerald J, Bergdahl L. Considering mooring cables for offshore wave energy converters. In: *Proceedings of 7th European Wave Tidal Energy Conference*; 2007.
- [153] Fitzgerald J, Bergdahl L. Including moorings in the assessment of a generic offshore energy converter: a frequency domain approach. *Mar Struct* 2008; 21:23–46.
- [154] Fonseca N, Pascoal R, Morais T, Dias R. Design of a mooring system with synthetic ropes for the FLOW wave energy converter. In: *Proceedings of 28th International Conference Ocean Offshore Arctic Engineering*, Honolulu, Hawaii; 2009 [Paper No. OMAE2009-80223].
- [155] Vicente PC, Falcão AF de O, Gato LMC, Justino PAP. Dynamics of arrays of floating point-absorber wave energy converters with inter-body and bottom slack-mooring connections. *Appl Ocean Res*, in press.